

FCC Test Report

Report No.: RF150730C47-4

FCC ID: NM82PQ9100

Test Model: 2PQ9100

Received Date: Jul. 30, 2015

Test Date: Aug. 06, 2015 ~ Aug. 30, 2015

Issued Date: Sep. 17, 2015

Applicant: HTC Corporation

Address: 1F, 6-3 Baoqiang Road, Xindian City, Taipei County 231, Taiwan

Issued By: Bureau Veritas Consumer Products Services (H.K.) Ltd., Taoyuan Branch

Lab Address: No. 47-2, 14th Ling, Chia Pau Vil., Lin Kou Dist., New Taipei City, Taiwan (R.O.C)

Test Location (1): No. 19, Hwa Ya 2nd Rd, Wen Hwa Tsuen, Kwei Shan Hsiang, Taoyuan Hsien 333, Taiwan, R.O.C.

Test Location (2): No.215, Sec. 3, Beixin Rd., Xindian Dist., New Taipei City 231, Taiwan, R.O.C



This report is for your exclusive use. Any copying or replication of this report to or for any other person or entity, or use of our name or trademark, is permitted only with our prior written permission. This report sets forth our findings solely with respect to the test samples identified herein. The results set forth in this report are not indicative or representative of the quality or characteristics of the lot from which a test sample was taken or any similar or identical product unless specifically and expressly noted. Our report includes all of the tests requested by you and the results thereof based upon the information that you provided to us. You have 60 days from date of issuance of this report to notify us of any material error or omission caused by our negligence, provided, however, that such notice shall be in writing and shall specifically address the issue you wish to raise. A failure to raise such issue within the prescribed time shall constitute your unqualified acceptance of the completeness of this report, the tests conducted and the correctness of the report contents. Unless specific mention, the uncertainty of measurement has been explicitly taken into account to declare the compliance or non-compliance to the specification. The report must not be used by the client to claim product certification, approval, or endorsement by TAF or any government agencies.

Table of Contents

Release Control Record	4
1 Certificate of Conformity	5
2 Summary of Test Results.....	6
2.1 Measurement Uncertainty.....	6
2.2 Modification Record	6
3 General Information	7
3.1 General Description of EUT	7
3.2 Description of Test Modes.....	8
3.2.1 Test Mode Applicability and Tested Channel Detail.....	10
3.3 Duty Cycle of Test Signal	12
3.4 Description of Support Units	16
3.4.1 Configuration of System under Test	16
3.5 General Description of Applied Standards.....	16
4 Test Types and Results	17
4.1 Radiated Emission and Bandedge Measurement	17
4.1.1 Limits of Radiated Emission and Bandedge Measurement	17
4.1.2 Limits of Unwanted Emission Out of The Restricted Bands.....	17
4.1.3 Test Instruments	18
4.1.4 Test Procedures.....	19
4.1.5 Deviation from Test Standard	19
4.1.6 Test Set Up	20
4.1.7 EUT Operating Conditions.....	20
4.1.8 Test Results	21
4.2 Conducted Emission Measurement.....	63
4.2.1 Limits of Conducted Emission Measurement	63
4.2.2 Test Instruments	63
4.2.3 Test Procedures.....	64
4.2.4 Deviation from Test Standard	64
4.2.5 Test Setup.....	64
4.2.6 EUT Operating Conditions.....	64
4.2.7 Test Results	65
4.3 Transmit Power Measurement.....	67
4.3.1 Limits of Transmit Power Measurement	67
4.3.2 Test Setup.....	67
4.3.3 Test Instruments	68
4.3.4 Test Procedure	68
4.3.5 Deviation from Test Standard	68
4.3.6 EUT Operating Conditions.....	68
4.3.7 Test Result	69
4.4 Peak Power Spectral Density Measurement	74
4.4.1 Limits of Peak Power Spectral Density Measurement	74
4.4.2 Test Setup.....	74
4.4.3 Test Instruments	74
4.4.4 Test Procedures.....	75
4.4.5 Deviation from Test Standard	75
4.4.6 EUT Operating Conditions.....	75
4.4.7 Test Results	76
4.5 Frequency Stability	81
4.5.1 Limit of Frequency Stability Measurement	81
4.5.2 Test Setup.....	81
4.5.3 Test Instruments	81
4.5.4 Test Procedure	81
4.5.5 Deviation from Test Standard	81



4.5.6 EUT Operating Condition	81
4.5.7 Test Results	82
4.6 6dB Bandwidth Measurement.....	83
4.6.1 Limits of 6dB Bandwidth Measurement.....	83
4.6.2 Test Setup.....	83
4.6.3 Test Instruments	83
4.6.4 Test Procedure	83
4.6.5 Deviation from Test Standard	83
4.6.6 EUT Operating Condition	83
4.6.7 Test Results	84
5 Pictures of Test Arrangements.....	86
Appendix – Information on the Testing Laboratories	87



A D T

Release Control Record

Issue No.	Description	Date Issued
RF150730C47-4	Original Release	Sep. 17, 2015



1 Certificate of Conformity

Product: Smartphone
Brand: HTC
Test Model: 2PQ9100
Sample Status: Identical Prototype
Applicant: HTC Corporation
Test Date: Aug. 06, 2015 ~ Aug. 30, 2015
Standards: 47 CFR FCC Part 15, Subpart E (Section 15.407)
ANSI C63.10:2013

The above equipment has been tested by **Bureau Veritas Consumer Products Services (H.K.) Ltd., Taoyuan Branch**, and found compliance with the requirement of the above standards. The test record, data evaluation & Equipment Under Test (EUT) configurations represented herein are true and accurate accounts of the measurements of the sample's EMC characteristics under the conditions specified in this report.

Prepared by : Ivonne Wu , **Date:** Sep. 17, 2015
Ivonne Wu / Supervisor

Approved by : Kay Wu , **Date:** Sep. 17, 2015
Kay Wu / Supervisor

2 Summary of Test Results

47 CFR FCC Part 15, Subpart E (SECTION 15.407)			
FCC Clause	Test Item	Result	Remarks
15.407(b)(6)	AC Power Conducted Emissions	PASS	Meet the requirement of limit. Minimum passing margin is -13.07dB at 0.55241MHz.
15.407(b)(1/2/3/4/6)	Radiated Emissions & Band Edge Measurement	PASS	Meet the requirement of limit. Minimum passing margin is -5.54dB at 5470MHz.
15.407(a)(1/2/3)	Max Average Transmit Power	PASS	Meet the requirement of limit.
15.407(a)(1/2/3)	Peak Power Spectral Density	PASS	Meet the requirement of limit.
15.407(e)	6dB bandwidth	PASS	Meet the requirement of limit. (U-NII-3 Band only)
15.407(g)	Frequency Stability	PASS	Meet the requirement of limit.
15.203	Antenna Requirement	PASS	No antenna connector is used.

2.1 Measurement Uncertainty

Where relevant, the following measurement uncertainty levels have been estimated for tests performed on the EUT as specified in CISPR 16-4-2:

Measurement	Frequency	Expanded Uncertainty (k=2) (\pm)
Conducted Emissions at mains ports	150kHz ~ 30MHz	2.44 dB
Radiated Emissions up to 1 GHz	30MHz ~ 200MHz	2.0153 dB
	200MHz ~ 1000MHz	2.0224 dB
Radiated Emissions above 1 GHz	1GHz ~ 18GHz	1.0121 dB
	18GHz ~ 40GHz	1.1508 dB

2.2 Modification Record

There were no modifications required for compliance.

3 General Information

3.1 General Description of EUT

Product	Smartphone
Brand	HTC
Test Model	2PQ9100
Status of EUT	Identical Prototype
Power Supply Rating	5.0Vdc (adapter or host equipment) 3.85Vdc (Li-ion battery)
Modulation Type	256QAM, 64QAM, 16QAM, QPSK, BPSK
Modulation Technology	OFDM
Transfer Rate	802.11a: 54.0/ 48.0/ 36.0/ 24.0/ 18.0/ 12.0/ 9.0/ 6.0Mbps 802.11n: up to MCS7 802.11ac: up to V9
Operating Frequency	5180 ~ 5240MHz, 5260 ~ 5320MHz, 5500 ~ 5700MHz, 5745 ~ 5825MHz
Number of Channel	5180 ~ 5240MHz: 4 for 802.11a, 802.11n (20MHz) 2 for 802.11n (40MHz) 1 for 802.11ac (80MHz) 5260 ~ 5320MHz: 4 for 802.11a, 802.11n (20MHz) 2 for 802.11n (40MHz) 1 for 802.11ac (80MHz) 5500 ~ 5700MHz: 8 for 802.11a, 802.11n (20MHz) 3 for 802.11n (40MHz) 2 for 802.11ac (80MHz) 5745 ~ 5825MHz: 5 for 802.11a, 802.11n (20MHz) 2 for 802.11n (40MHz) 1 for 802.11ac (80MHz)
Output Power	19.63mW for 5180 ~ 5240MHz 19.68mW for 5260 ~ 5320MHz 19.91mW for 5500 ~ 5700MHz 20.23mW for 5745 ~ 5825MHz
Antenna Type	PIFA antenna with -3dBi gain (5180 ~ 5240MHz) PIFA antenna with -2.42dBi gain (5260 ~ 5320MHz) PIFA antenna with -2dBi gain (5500 ~ 5700MHz) PIFA antenna with -3.2dBi gain (5745 ~ 5825MHz)
Antenna Connector	{ antenna connector }
Accessory Device	Refer to Note as below
Data Cable Supplied	Refer to Note as below

Note:

1. The EUT's accessories list refers to Ext. Pho.
2. The above EUT information is declared by manufacturer and for more detailed features description, please refer to the manufacturer's specifications or user's manual.

3.2 Description of Test Modes

FOR 5180 ~ 5240MHz

4 channels are provided for 802.11a, 802.11n (20MHz):

Channel	Frequency	Channel	Frequency
36	5180 MHz	44	5220 MHz
40	5200 MHz	48	5240 MHz

2 channels are provided for 802.11n (40MHz):

Channel	Frequency	Channel	Frequency
38	5190 MHz	46	5230 MHz

1 channel is provided for 802.11ac (80MHz):

Channel	Frequency
42	5210MHz

FOR 5260 ~ 5320MHz

4 channels are provided for 802.11a, 802.11n (20MHz):

Channel	Frequency	Channel	Frequency
52	5260 MHz	60	5300 MHz
56	5280 MHz	64	5320 MHz

2 channels are provided for 802.11n (40MHz):

Channel	Frequency	Channel	Frequency
54	5270 MHz	62	5310 MHz

1 channel is provided for 802.11ac (80MHz):

Channel	Frequency
58	5290MHz

FOR 5500 ~ 5700MHz

11 channels are provided for 802.11a, 802.11n (20MHz):

Channel	Frequency	Channel	Frequency
100	5500 MHz	124	5620 MHz
104	5520 MHz	128	5640 MHz
108	5540 MHz	132	5660 MHz
112	5560 MHz	136	5680 MHz
116	5580 MHz	140	5700 MHz
120	5600 MHz		

5 channels are provided for 802.11n (40MHz):

Channel	Frequency	Channel	Frequency
102	5510 MHz	126	5630 MHz
110	5550 MHz	134	5670 MHz
118	5590 MHz		

2 channels are provided for 802.11ac (80MHz):

Channel	Frequency	Channel	Frequency
106	5530MHz	122	5610 MHz

FOR 5745 ~ 5825MHz:

5 channels are provided for 802.11a, 802.11n (20MHz):

Channel	Frequency	Channel	Frequency
149	5745MHz	161	5805MHz
153	5765MHz	165	5825MHz
157	5785MHz		

2 channels are provided for 802.11n (40MHz):

Channel	Frequency	Channel	Frequency
151	5755MHz	159	5795MHz

1 channel is provided for 802.11ac (80MHz):

Channel	Frequency
155	5775MHz

3.2.1 Test Mode Applicability and Tested Channel Detail

EUT Configure Mode	Applicable To				Description
	RE \geq 1G	RE $<$ 1G	PLC	APCM	
-	√	√	√	√	-

Where **RE \geq 1G**: Radiated Emission above 1GHz **RE $<$ 1G**: Radiated Emission below 1GHz
PLC: Power Line Conducted Emission **APCM**: Antenna Port Conducted Measurement

NOTE:

1. The EUT had been pre-tested on the positioned of each 3 axis. The worst case was found when positioned on **X-plane**.
2. "-" means no effect.

Radiated Emission Test (Above 1GHz):

- Pre-Scan has been conducted to determine the worst-case mode from all possible combinations between available modulations, data rates and antenna ports (if EUT with antenna diversity architecture).
- Following channel(s) was (were) selected for the final test as listed below.

EUT Configure Mode	Mode	Frequency Band (MHz)	Available Channel	Tested Channel	Modulation Technology	Modulation Type	Data Rate (Mbps)
-	802.11a	5180-5240	36 to 48	36, 40, 48	OFDM	BPSK	6.0
-	802.11n (20MHz)		36 to 48	36, 40, 48	OFDM	BPSK	MCS0
-	802.11n (40MHz)		38 to 46	38, 46	OFDM	BPSK	MCS0
-	802.11ac (80MHz)		42	42	OFDM	BPSK	V0
-	802.11a	5260-5320	52 to 64	52, 60, 64	OFDM	BPSK	6.0
-	802.11n (20MHz)		52 to 64	52, 60, 64	OFDM	BPSK	MCS0
-	802.11n (40MHz)		54 to 62	54, 62	OFDM	BPSK	MCS0
-	802.11ac (80MHz)		58	58	OFDM	BPSK	V0
-	802.11a	5500-5700	100 to 140	100, 116, 140	OFDM	BPSK	6.0
-	802.11n (20MHz)		100 to 140	100, 116, 140	OFDM	BPSK	MCS0
-	802.11n (40MHz)		102 to 134	102, 110, 134	OFDM	BPSK	MCS0
-	802.11ac (80MHz)		106 to 122	106, 122	OFDM	BPSK	V0
-	802.11a	5745-5825	149 to 165	149, 157, 165	OFDM	BPSK	6.0
-	802.11n (20MHz)		149 to 165	149, 157, 165	OFDM	BPSK	MCS0
-	802.11n (40MHz)		151 to 159	151, 159	OFDM	BPSK	MCS0
-	802.11ac (80MHz)		155	155	OFDM	BPSK	V0

Radiated Emission Test (Below 1GHz):

- Pre-Scan has been conducted to determine the worst-case mode from all possible combinations between available modulations, data rates and antenna ports (if EUT with antenna diversity architecture).
- Following channel(s) was (were) selected for the final test as listed below.

EUT Configure Mode	Mode	Frequency Band (MHz)	Available Channel	Tested Channel	Modulation Technology	Modulation Type	Data Rate (Mbps)
-	802.11ac (80MHz)	5180-5240	42	42	OFDM	BPSK	V0
-	802.11a	5260-5320	52 to 64	60	OFDM	BPSK	6.0
-	802.11n (40MHz)	5500-5700	102 to 134	102	OFDM	BPSK	MCS0
-	802.11n (40MHz)	5745-5825	151 to 159	151	OFDM	BPSK	MCS0

Power Line Conducted Emission Test:

- Pre-Scan has been conducted to determine the worst-case mode from all possible combinations between available modulations, data rates and antenna ports (if EUT with antenna diversity architecture).
- Following channel(s) was (were) selected for the final test as listed below.

EUT Configure Mode	Mode	Frequency Band (MHz)	Available Channel	Tested Channel	Modulation Technology	Modulation Type	Data Rate (Mbps)
-	802.11n (40MHz)	5500-5700	102 to 134	102	OFDM	BPSK	MCS0

Antenna Port Conducted Measurement:

- This item includes all test value of each mode, but only includes spectrum plot of worst value of each mode.
- Pre-Scan has been conducted to determine the worst-case mode from all possible combinations between available modulations, data rates and antenna ports (if EUT with antenna diversity architecture).
- Following channel(s) was (were) selected for the final test as listed below.

EUT Configure Mode	Mode	Frequency Band (MHz)	Available Channel	Tested Channel	Modulation Technology	Modulation Type	Data Rate (Mbps)
-	802.11a	5180-5240	36 to 48	36, 40, 48	OFDM	BPSK	6.0
-	802.11n (20MHz)		36 to 48	36, 40, 48	OFDM	BPSK	MCS0
-	802.11n (40MHz)		38 to 46	38, 46	OFDM	BPSK	MCS0
-	802.11ac (80MHz)		42	42	OFDM	BPSK	V0
-	802.11a	5260-5320	52 to 64	52, 60, 64	OFDM	BPSK	6.0
-	802.11n (20MHz)		52 to 64	52, 60, 64	OFDM	BPSK	MCS0
-	802.11n (40MHz)		54 to 62	54, 62	OFDM	BPSK	MCS0
-	802.11ac (80MHz)		58	58	OFDM	BPSK	V0
-	802.11a	5500-5700	100 to 140	100, 116, 140	OFDM	BPSK	6.0
-	802.11n (20MHz)		100 to 140	100, 116, 140	OFDM	BPSK	MCS0
-	802.11n (40MHz)		102 to 134	102, 110, 134	OFDM	BPSK	MCS0
-	802.11ac (80MHz)		106 to 122	106, 122	OFDM	BPSK	V0
-	802.11a	5745-5825	149 to 165	149, 157, 165	OFDM	BPSK	6.0
-	802.11n (20MHz)		149 to 165	149, 157, 165	OFDM	BPSK	MCS0
-	802.11n (40MHz)		151 to 159	151, 159	OFDM	BPSK	MCS0
-	802.11ac (80MHz)		155	155	OFDM	BPSK	V0

Test Condition:

Applicable To	Environmental Conditions	Input Power	Tested by
RE \geq 1G	25deg. C, 65%RH	120Vac, 60Hz	Charles Hsiao
RE<1G	25deg. C, 65%RH	120Vac, 60Hz	Charles Hsiao
PLC	25deg. C, 65%RH	120Vac, 60Hz	Toby Tian
APCM	25deg. C, 65%RH	3.85Vdc	Howard Kao

3.3 Duty Cycle of Test Signal

MODULATION TYPE: BPSK

Duty cycle of test signal is < 98%, duty factor is required.

802.11a: Duty cycle = $1.034/1.242 = 0.832$, Duty factor = $10 * \log(1/0.832) = 0.80$

802.11n (20MHz): Duty cycle = $969.55/1177.89 = 0.823$, Duty factor = $10 * \log(1/0.823) = 0.85$

802.11n (40MHz): Duty cycle = $472.76/689.10 = 0.686$, Duty factor = $10 * \log(1/0.686) = 1.64$

802.11ac (80MHz): Duty cycle = $248.40/451.92 = 0.550$, Duty factor = $10 * \log(1/0.550) = 2.60$

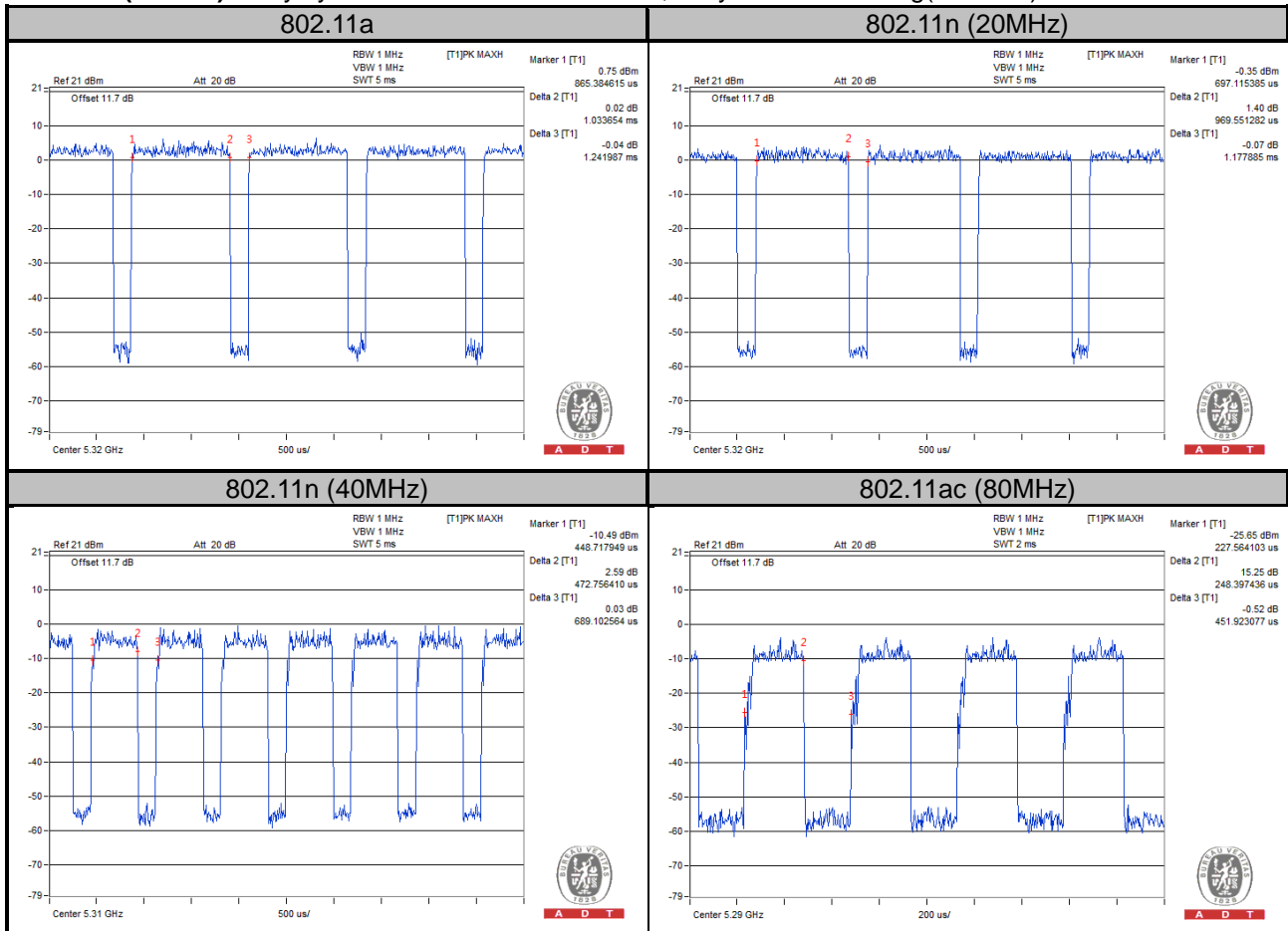

MODULATION TYPE: QPSK

Duty cycle of test signal is < 98%, duty factor is required.

802.11a: Duty cycle = 528.85/737.18 = 0.717, Duty factor = $10 * \log(1/0.717) = 1.44$

802.11n (20MHz): Duty cycle = 496.79/705.13 = 0.705, Duty factor = $10 * \log(1/0.705) = 1.52$

802.11n (40MHz): Duty cycle = 248.40/464.74 = 0.534, Duty factor = $10 * \log(1/0.534) = 2.72$

802.11ac (80MHz): Duty cycle = 142.63/346.15 = 0.412, Duty factor = $10 * \log(1/0.412) = 3.85$

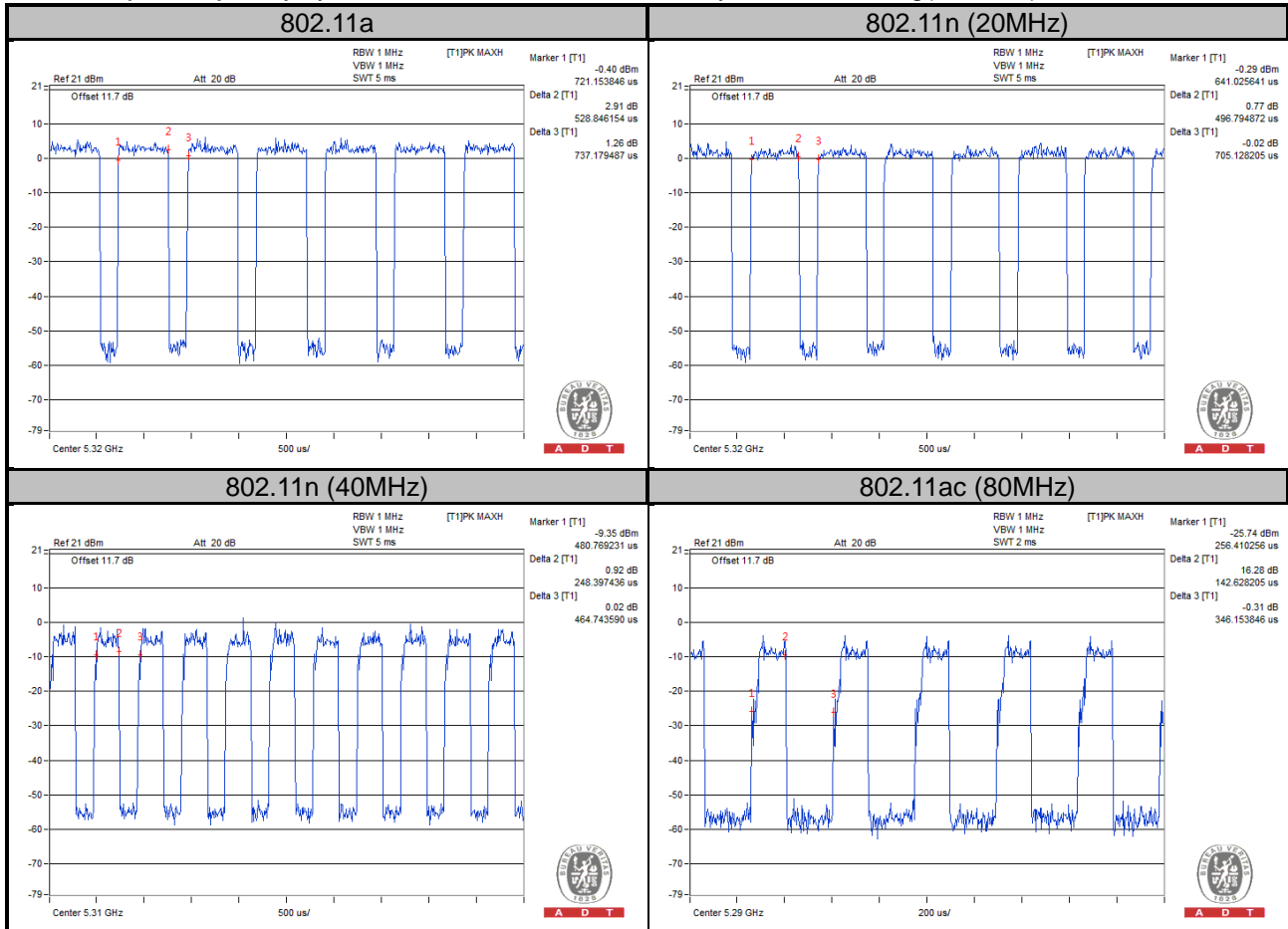

MODULATION TYPE: 16QAM

Duty cycle of test signal is < 98%, duty factor is required.

802.11a: Duty cycle = $264.42/472.76 = 0.559$, Duty factor = $10 * \log(1/0.559) = 2.52$

802.11n (20MHz): Duty cycle = $264.42/472.76 = 0.559$, Duty factor = $10 * \log(1/0.559) = 2.52$

802.11n (40MHz): Duty cycle = $152.24/352.56 = 0.432$, Duty factor = $10 * \log(1/0.432) = 3.65$

802.11ac (80MHz): Duty cycle = $88.14/291.67 = 0.302$, Duty factor = $10 * \log(1/0.302) = 5.20$

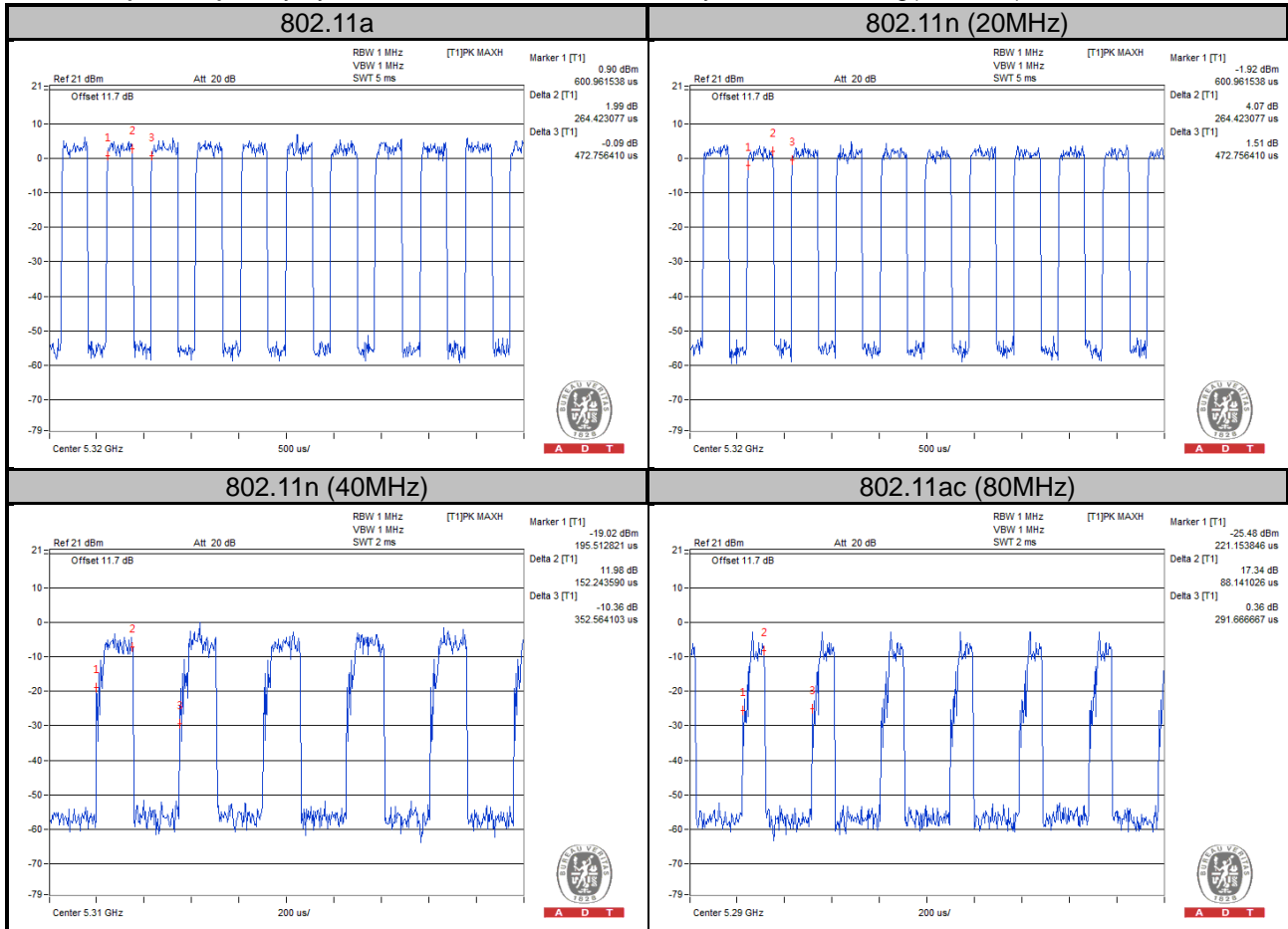

MODULATION TYPE: 64QAM

Duty cycle of test signal is < 98%, duty factor is required.

802.11a: Duty cycle = $144.23/352.56 = 0.409$, Duty factor = $10 * \log(1/0.409) = 3.88$

802.11n (20MHz): Duty cycle = $144.23/352.56 = 0.409$, Duty factor = $10 * \log(1/0.409) = 3.88$

802.11n (40MHz): Duty cycle = $94.55/298.08 = 0.317$, Duty factor = $10 * \log(1/0.317) = 4.99$

802.11ac (80MHz): Duty cycle = $65.71/266.03 = 0.247$, Duty factor = $10 * \log(1/0.247) = 6.07$

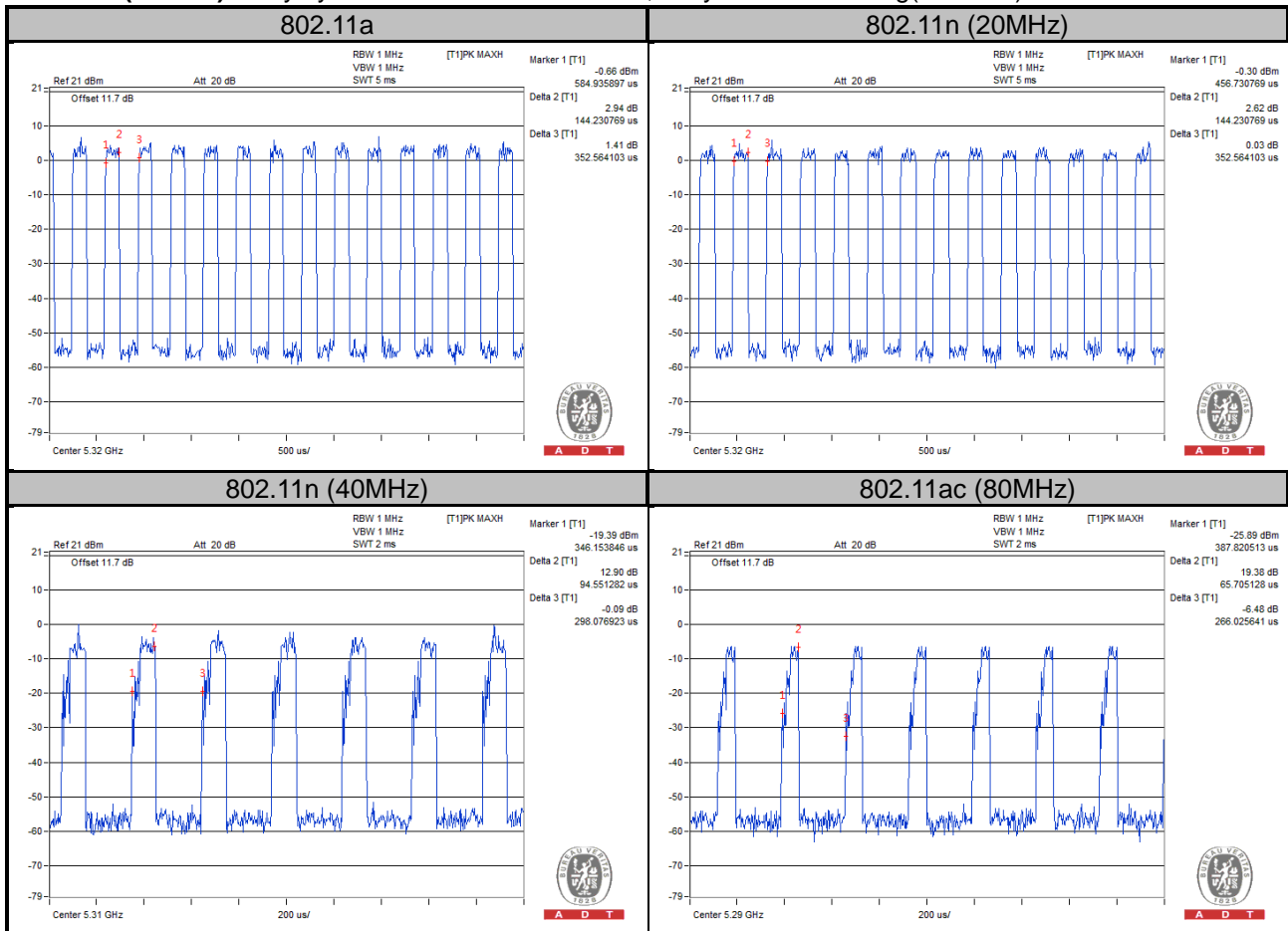

MODULATION TYPE: 256QAM

Duty cycle of test signal is < 98%, duty factor is required.

802.11ac (80MHz): Duty cycle = $59.29/262.82 = 0.226$, Duty factor = $10 * \log(1/0.226) = 6.47$

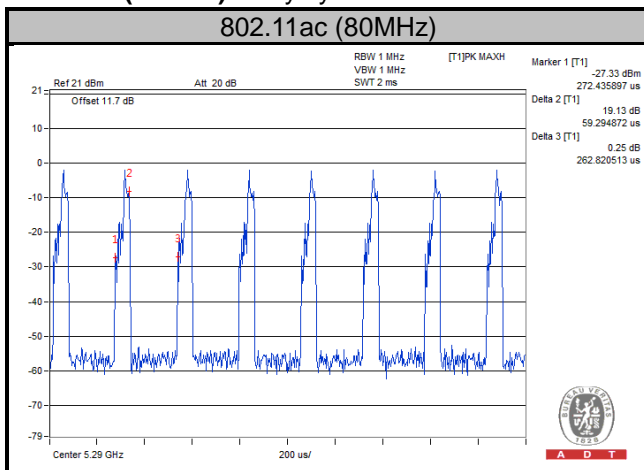

3.4 Description of Support Units

The EUT has been tested as an independent unit together with other necessary accessories or support units.

3.4.1 Configuration of System under Test

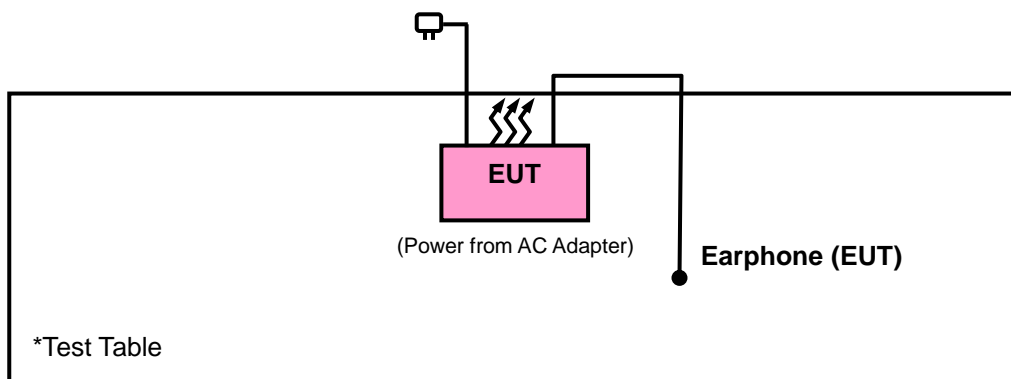

3.5 General Description of Applied Standards

The EUT is a RF Product. According to the specifications of the manufacturer, it must comply with the requirements of the following standards:

FCC Part 15, Subpart E (15.407)

789033 D02 General UNII Test Procedures New Rules v01

644545 D01 Guidance for IEEE 802 11ac v01r02

ANSI C63.10-2013

All test items have been performed and recorded as per the above standards.

NOTE: The EUT has been verified to comply with the requirements of FCC Part 15, Subpart B, Class B (DoC).
The test report has been issued separately.

4 Test Types and Results

4.1 Radiated Emission and Bandedge Measurement

4.1.1 Limits of Radiated Emission and Bandedge Measurement

Radiated emissions which fall in the restricted bands must comply with the radiated emission limits specified as below table. Other emissions shall be at least 20dB below the highest level of the desired power:

Frequencies (MHz)	Field Strength (microvolts/meter)	Measurement Distance (meters)
0.009 ~ 0.490	2400/F(kHz)	300
0.490 ~ 1.705	24000/F(kHz)	30
1.705 ~ 30.0	30	30
30 ~ 88	100	3
88 ~ 216	150	3
216 ~ 960	200	3
Above 960	500	3

NOTE:

1. The lower limit shall apply at the transition frequencies.
2. Emission level (dBuV/m) = 20 log Emission level (uV/m).
3. For frequencies above 1000MHz, the field strength limits are based on average detector, however, the peak field strength of any emission shall not exceed the maximum permitted average limits, specified above by more than 20dB under any condition of modulation.

4.1.2 Limits of Unwanted Emission Out of The Restricted Bands

Applicable To	Limit	
789033 D02 General UNII Test Procedures New Rules v01	Field Strength AT 3m	
	PK:74 (dBµV/m)	AV:54 (dBµV/m)
Applicable To	EIRP Limit	Equivalent Field Strength At 3m
15.407(b)(1)	PK:-27 (dBm/MHz)	PK:68.2(dBµV/m)
15.407(b)(2)		
15.407(b)(3)		
15.407(b)(4)	PK:-27 (dBm/MHz) ^{*1} PK:-17 (dBm/MHz) ^{*2}	PK: 68.2(dBµV/m) ^{*1} PK:78.2 (dBµV/m) ^{*2}

NOTE: ^{*1} beyond 10MHz of the band edge ^{*2} within 10 MHz of band edge

The following formula is used to convert the equipment isotropic radiated power (eirp) to field strength:

$$E = \frac{1000000\sqrt{30P}}{3} \mu\text{V/m, where P is the eirp (Watts).}$$

4.1.3 Test Instruments

Description & Manufacturer	Model No.	Serial No.	Date of Calibration	Due Date of Calibration
Spectrum Analyzer Agilent Technologies	N9038A	MY52260177	May 19, 2015	May 18, 2016
Spectrum Analyzer ROHDE & SCHWARZ	FSU43	101261	Dec. 10, 2014	Dec. 09, 2015
BILOG Antenna SCHWARZBECK	VULB9168	9168-472	Feb. 04, 2015	Feb. 04, 2016
HORN Antenna ETS-Lindgren	3117	00143293	Jan. 05, 2015	Jan. 04, 2016
HORN Antenna SCHWARZBECK	BBHA 9170	9170-480	Feb. 04, 2015	Feb. 04, 2016
Bluetooth Tester	CBT	100980	Apr. 27, 2015	Apr. 26, 2017
Agilent Communications Tester-Wireless	8960 Series 10	MY53201073	Jul. 03, 2015	Jul. 02, 2017
Preamplifier Agilent	310N	187226	Jun. 29, 2015	Jun. 28, 2016
Preamplifier Agilent	83017A	MY39501357	Jun. 29, 2015	Jun. 28, 2016
Power Meter Anritsu	ML2495A	1232002	Sep. 17, 2014	Sep. 16, 2015
Power Sensor Anritsu	MA2411B	1207325	Sep. 17, 2014	Sep. 16, 2015
RF signal cable ETS-LINDGREN	5D-FB	Cable-CH1-01(R FC-SMS-100-SM S-120+RFC-SMS -100-SMS-400)	Jun. 27, 2015	Jun. 26, 2016
RF signal cable ETS-LINDGREN	8D-FB	Cable-CH1-02(R FC-SMS-100-SM S-24)	Jun. 27, 2015	Jun. 26, 2016
Software BV ADT	E3 8.130425b	NA	NA	NA
Antenna Tower MF	NA	NA	NA	NA
Turn Table MF	NA	NA	NA	NA
Antenna Tower & Turn Table Controller MF	MF-7802	NA	NA	NA

- Note: 1. The calibration interval of the above test instruments is 12 months and the calibrations are traceable to NML/ROC and NIST/USA.
2. The test was performed in HsinTien Chamber 1.
3. The horn antenna and HP preamplifier (model: 8449B) are used only for the measurement of emission frequency above 1GHz if tested.
4. The FCC Site Registration No. is 149147.
5. The IC Site Registration No. is IC7450I-1.

4.1.4 Test Procedures

- a. The EUT was placed on the top of a rotating table 0.8 meters (for below 1GHz) / 1.5 meters (for above 1GHz) above the ground at 3 meter chamber room for test. The table was rotated 360 degrees to determine the position of the highest radiation.
- b. The EUT was set 3 meters away from the interference-receiving antenna, which was mounted on the top of a variable-height antenna tower.
- c. The height of antenna is varied from one meter to four meters above the ground to determine the maximum value of the field strength. Both horizontal and vertical polarizations of the antenna are set to make the measurement.
- d. For each suspected emission, the EUT was arranged to its worst case and then the antenna was tuned to heights from 1 meter to 4 meters and the rotatable table was turned from 0 degrees to 360 degrees to find the maximum reading.
- e. The test-receiver system was set to quasi-peak detect function and specified bandwidth with maximum hold mode when the test frequency is below 1 GHz.
- f. The test-receiver system was set to peak and average detect function and specified bandwidth with maximum hold mode when the test frequency is above 1 GHz. If the peak reading value also meets average limit, measurement with the average detector is unnecessary.

Note:

1. The resolution bandwidth and video bandwidth of test receiver/spectrum analyzer is 120kHz for Quasi-peak detection (QP) at frequency below 1GHz.
2. The resolution bandwidth of test receiver/spectrum analyzer is 1 MHz and the video bandwidth is 3 MHz for Peak detection (PK) at frequency above 1GHz.
3. The resolution bandwidth of test receiver/spectrum analyzer is 1MHz and the video bandwidth is 3MHz for RMS Average (Duty cycle < 98%) for Average detection (AV) at frequency above 1GHz, then the measurement results was added to a correction factor ($10 \log(1/\text{duty cycle})$).
4. The resolution bandwidth of test receiver/spectrum analyzer is 1MHz and the video bandwidth is 10Hz (Duty cycle $\geq 98\%$) for Average detection (AV) at frequency above 1GHz.
5. All modes of operation were investigated and the worst-case emissions are reported.

4.1.5 Deviation from Test Standard

No deviation.

4.1.6 Test Set Up

<Frequency Range below 1GHz>

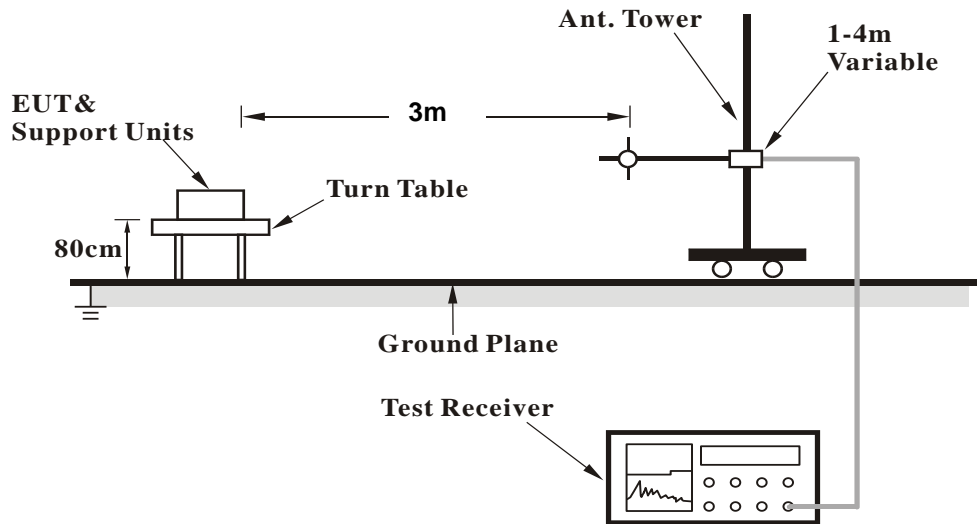

<Frequency Range above 1GHz>

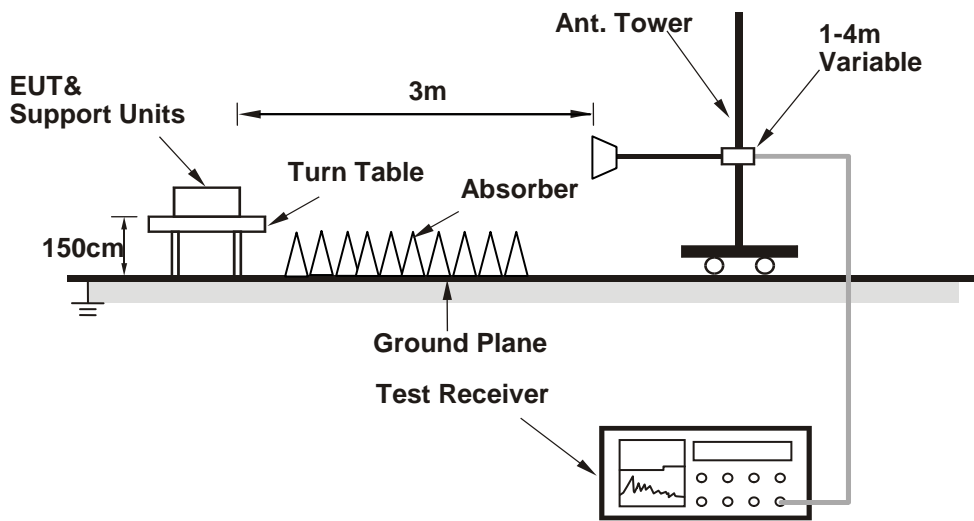

For the actual test configuration, please refer to the attached file (Test Setup Photo).

4.1.7 EUT Operating Conditions

- a. Placed the EUT on a testing table.
- b. Use the software to control the EUT under transmission condition continuously at specific channel frequency.

4.1.8 Test Results
ABOVE 1GHz DATA :
802.11a

EUT TEST CONDITION		MEASUREMENT DETAIL	
CHANNEL	Channel 36	FREQUENCY RANGE	1GHz ~ 40GHz
INPUT POWER	120Vac, 60 Hz	DETECTOR FUNCTION	Peak (PK) Average (AV)
ENVIRONMENTAL CONDITIONS	25deg. C, 65%RH	TESTED BY	Charles Hsiao

ANTENNA POLARITY & TEST DISTANCE: HORIZONTAL AT 3 M										
FREQ. (MHz)	EMISSION LEVEL (dBuV/m)	READ LEVEL (dBuV)	LIMIT (dBuV/m)	MARGIN (dB)	ANTENNA FACTOR (dB/m)	CABLE LOSS (dB)	PREAMP FACTOR (dB)	ANTENNA HEIGHT (cm)	TABLE ANGLE (Degree)	REMARK
5104	43.92	35.76	54	-10.08	34.08	8.07	33.99	181	340	Average
5104	57.58	49.42	74	-16.42	34.08	8.07	33.99	181	340	Peak
5180	96.22	87.91			34.15	8.16	34	181	340	Average
5180	103.78	95.47			34.15	8.16	34	181	340	Peak
5458	42.85	34.03	54	-11.15	34.36	8.51	34.05	181	340	Average
5458	57.4	48.58	74	-16.6	34.36	8.51	34.05	181	340	Peak
ANTENNA POLARITY & TEST DISTANCE: VERTICAL AT 3 M										
FREQ. (MHz)	EMISSION LEVEL (dBuV/m)	READ LEVEL (dBuV)	LIMIT (dBuV/m)	MARGIN (dB)	ANTENNA FACTOR (dB/m)	CABLE LOSS (dB)	PREAMP FACTOR (dB)	ANTENNA HEIGHT (cm)	TABLE ANGLE (Degree)	REMARK
5018	44.49	36.48	54	-9.51	34.01	7.97	33.97	199	26	Average
5018	57.18	49.17	74	-16.82	34.01	7.97	33.97	199	26	Peak
5180	96.76	88.45			34.15	8.16	34	199	26	Average
5180	105.14	96.83			34.15	8.16	34	199	26	Peak
5424	42.76	33.99	54	-11.24	34.33	8.48	34.04	199	26	Average
5424	57.57	48.8	74	-16.43	34.33	8.48	34.04	199	26	Peak

REMARKS:

- Emission Level = Read Level + Antenna Factor + Cable Loss - Preamp Factor
Margin value = Emission level – Limit value
- 5180MHz: Fundamental frequency.

EUT TEST CONDITION		MEASUREMENT DETAIL	
CHANNEL	Channel 44	FREQUENCY RANGE	1GHz ~ 40GHz
INPUT POWER	120Vac, 60 Hz	DETECTOR FUNCTION	Peak (PK) Average (AV)
ENVIRONMENTAL CONDITIONS	25deg. C, 65%RH	TESTED BY	Charles Hsiao

ANTENNA POLARITY & TEST DISTANCE: HORIZONTAL AT 3 M										
FREQ. (MHz)	EMISSION LEVEL (dBuV/m)	READ LEVEL (dBuV)	LIMIT (dBuV/m)	MARGIN (dB)	ANTENNA FACTOR (dB/m)	CABLE LOSS (dB)	PREAMP FACTOR (dB)	ANTENNA HEIGHT (cm)	TABLE ANGLE (Degree)	REMARK
5126	42.54	34.32	54	-11.46	34.11	8.1	33.99	204	339	Average
5126	56.78	48.56	74	-17.22	34.11	8.1	33.99	204	339	Peak
5220	95.4	87.01			34.17	8.22	34	204	339	Average
5220	103.58	95.19			34.17	8.22	34	204	339	Peak
5404	42.61	33.89	54	-11.39	34.32	8.44	34.04	204	339	Average
5404	57.15	48.43	74	-16.85	34.32	8.44	34.04	204	339	Peak
ANTENNA POLARITY & TEST DISTANCE: VERTICAL AT 3 M										
FREQ. (MHz)	EMISSION LEVEL (dBuV/m)	READ LEVEL (dBuV)	LIMIT (dBuV/m)	MARGIN (dB)	ANTENNA FACTOR (dB/m)	CABLE LOSS (dB)	PREAMP FACTOR (dB)	ANTENNA HEIGHT (cm)	TABLE ANGLE (Degree)	REMARK
5134	42.55	34.3	54	-11.45	34.11	8.13	33.99	214	26	Average
5134	56.88	48.63	74	-17.12	34.11	8.13	33.99	214	26	Peak
5220	97.3	88.91			34.17	8.22	34	214	26	Average
5220	105.47	97.08			34.17	8.22	34	214	26	Peak
5360	42.46	33.83	54	-11.54	34.28	8.38	34.03	214	26	Average
5360	57.05	48.42	74	-16.95	34.28	8.38	34.03	214	26	Peak

REMARKS:

- Emission Level = Read Level + Antenna Factor + Cable Loss - Preamp Factor
Margin value = Emission level – Limit value
- 5220MHz: Fundamental frequency.



A D T

EUT TEST CONDITION		MEASUREMENT DETAIL	
CHANNEL	Channel 48	FREQUENCY RANGE	1GHz ~ 40GHz
INPUT POWER	120Vac, 60 Hz	DETECTOR FUNCTION	Peak (PK) Average (AV)
ENVIRONMENTAL CONDITIONS	25deg. C, 65%RH	TESTED BY	Charles Hsiao

ANTENNA POLARITY & TEST DISTANCE: HORIZONTAL AT 3 M										
FREQ. (MHz)	EMISSION LEVEL (dBuV/m)	READ LEVEL (dBuV)	LIMIT (dBuV/m)	MARGIN (dB)	ANTENNA FACTOR (dB/m)	CABLE LOSS (dB)	PREAMP FACTOR (dB)	ANTENNA HEIGHT (cm)	TABLE ANGLE (Degree)	REMARK
5094	42.48	34.32	54	-11.52	34.08	8.07	33.99	204	339	Average
5094	56.47	48.31	74	-17.53	34.08	8.07	33.99	204	339	Peak
5240	95.15	86.71			34.19	8.26	34.01	204	339	Average
5240	103.4	94.96			34.19	8.26	34.01	204	339	Peak
5434	42.72	33.93	54	-11.28	34.35	8.48	34.04	204	339	Average
5434	56.93	48.14	74	-17.07	34.35	8.48	34.04	204	339	Peak

ANTENNA POLARITY & TEST DISTANCE: VERTICAL AT 3 M										
FREQ. (MHz)	EMISSION LEVEL (dBuV/m)	READ LEVEL (dBuV)	LIMIT (dBuV/m)	MARGIN (dB)	ANTENNA FACTOR (dB/m)	CABLE LOSS (dB)	PREAMP FACTOR (dB)	ANTENNA HEIGHT (cm)	TABLE ANGLE (Degree)	REMARK
5146	42.65	34.4	54	-11.35	34.12	8.13	34	204	26	Average
5146	57.45	49.2	74	-16.55	34.12	8.13	34	204	26	Peak
5240	98.04	89.6			34.19	8.26	34.01	204	26	Average
5240	105.57	97.13			34.19	8.26	34.01	204	26	Peak
5430	42.83	34.04	54	-11.17	34.35	8.48	34.04	204	26	Average
5430	57.42	48.63	74	-16.58	34.35	8.48	34.04	204	26	Peak

REMARKS:

- Emission Level = Read Level + Antenna Factor + Cable Loss - Preamp Factor
Margin value = Emission level – Limit value
- 5240MHz: Fundamental frequency.



A D T

EUT TEST CONDITION		MEASUREMENT DETAIL	
CHANNEL	Channel 52	FREQUENCY RANGE	1GHz ~ 40GHz
INPUT POWER	120Vac, 60 Hz	DETECTOR FUNCTION	Peak (PK) Average (AV)
ENVIRONMENTAL CONDITIONS	25deg. C, 65%RH	TESTED BY	Charles Hsiao

ANTENNA POLARITY & TEST DISTANCE: HORIZONTAL AT 3 M										
FREQ. (MHz)	EMISSION LEVEL (dBuV/m)	READ LEVEL (dBuV)	LIMIT (dBuV/m)	MARGIN (dB)	ANTENNA FACTOR (dB/m)	CABLE LOSS (dB)	PREAMP FACTOR (dB)	ANTENNA HEIGHT (cm)	TABLE ANGLE (Degree)	REMARK
5072	42.38	34.26	54	-11.62	34.07	8.03	33.98	208	336	Average
5072	57.16	49.04	74	-16.84	34.07	8.03	33.98	208	336	Peak
5260	95.57	87.11			34.21	8.26	34.01	208	336	Average
5260	103.71	95.25			34.21	8.26	34.01	208	336	Peak
5436	42.67	33.88	54	-11.33	34.35	8.48	34.04	208	336	Average
5436	57.51	48.72	74	-16.49	34.35	8.48	34.04	208	336	Peak

ANTENNA POLARITY & TEST DISTANCE: VERTICAL AT 3 M										
FREQ. (MHz)	EMISSION LEVEL (dBuV/m)	READ LEVEL (dBuV)	LIMIT (dBuV/m)	MARGIN (dB)	ANTENNA FACTOR (dB/m)	CABLE LOSS (dB)	PREAMP FACTOR (dB)	ANTENNA HEIGHT (cm)	TABLE ANGLE (Degree)	REMARK
5150	42.52	34.27	54	-11.48	34.12	8.13	34	204	32	Average
5150	56.78	48.53	74	-17.22	34.12	8.13	34	204	32	Peak
5260	96.77	88.31			34.21	8.26	34.01	204	32	Average
5260	105.03	96.57			34.21	8.26	34.01	204	32	Peak
5350	42.56	33.93	54	-11.44	34.28	8.38	34.03	204	32	Average
5350	57.64	49.01	74	-16.36	34.28	8.38	34.03	204	32	Peak

REMARKS:

1. Emission Level = Read Level + Antenna Factor + Cable Loss - Preamp Factor
Margin value = Emission level – Limit value
2. 5260MHz: Fundamental frequency.



EUT TEST CONDITION		MEASUREMENT DETAIL	
CHANNEL	Channel 60	FREQUENCY RANGE	1GHz ~ 40GHz
INPUT POWER	120Vac, 60 Hz	DETECTOR FUNCTION	Peak (PK) Average (AV)
ENVIRONMENTAL CONDITIONS	25deg. C, 65%RH	TESTED BY	Charles Hsiao

ANTENNA POLARITY & TEST DISTANCE: HORIZONTAL AT 3 M										
FREQ. (MHz)	EMISSION LEVEL (dBuV/m)	READ LEVEL (dBuV)	LIMIT (dBuV/m)	MARGIN (dB)	ANTENNA FACTOR (dB/m)	CABLE LOSS (dB)	PREAMP FACTOR (dB)	ANTENNA HEIGHT (cm)	TABLE ANGLE (Degree)	REMARK
5058	42.39	34.29	54	-11.61	34.05	8.03	33.98	208	336	Average
5058	57.32	49.22	74	-16.68	34.05	8.03	33.98	208	336	Peak
5300	95.22	86.68			34.24	8.32	34.02	208	336	Average
5300	103.4	94.86			34.24	8.32	34.02	208	336	Peak
5432	44.82	36.03	54	-9.18	34.35	8.48	34.04	208	336	Average
5432	58.02	49.23	74	-15.98	34.35	8.48	34.04	208	336	Peak
ANTENNA POLARITY & TEST DISTANCE: VERTICAL AT 3 M										
FREQ. (MHz)	EMISSION LEVEL (dBuV/m)	READ LEVEL (dBuV)	LIMIT (dBuV/m)	MARGIN (dB)	ANTENNA FACTOR (dB/m)	CABLE LOSS (dB)	PREAMP FACTOR (dB)	ANTENNA HEIGHT (cm)	TABLE ANGLE (Degree)	REMARK
5058	42.34	34.24	54	-11.66	34.05	8.03	33.98	194	32	Average
5058	56.64	48.54	74	-17.36	34.05	8.03	33.98	194	32	Peak
5300	97.26	88.72			34.24	8.32	34.02	194	32	Average
5300	105.3	96.76			34.24	8.32	34.02	194	32	Peak
5402	45.14	36.42	54	-8.86	34.32	8.44	34.04	194	32	Average
5402	57.35	48.63	74	-16.65	34.32	8.44	34.04	194	32	Peak

REMARKS:

- Emission Level = Read Level + Antenna Factor + Cable Loss - Preamp Factor
Margin value = Emission level – Limit value
- 5300MHz: Fundamental frequency.



EUT TEST CONDITION		MEASUREMENT DETAIL	
CHANNEL	Channel 64	FREQUENCY RANGE	1GHz ~ 40GHz
INPUT POWER	120Vac, 60 Hz	DETECTOR FUNCTION	Peak (PK) Average (AV)
ENVIRONMENTAL CONDITIONS	25deg. C, 65%RH	TESTED BY	Charles Hsiao

ANTENNA POLARITY & TEST DISTANCE: HORIZONTAL AT 3 M										
FREQ. (MHz)	EMISSION LEVEL (dBuV/m)	READ LEVEL (dBuV)	LIMIT (dBuV/m)	MARGIN (dB)	ANTENNA FACTOR (dB/m)	CABLE LOSS (dB)	PREAMP FACTOR (dB)	ANTENNA HEIGHT (cm)	TABLE ANGLE (Degree)	REMARK
5042	42.21	34.15	54	-11.79	34.04	8	33.98	208	336	Average
5042	56.7	48.64	74	-17.3	34.04	8	33.98	208	336	Peak
5320	95.2	86.62			34.25	8.35	34.02	208	336	Average
5320	103.24	94.66			34.25	8.35	34.02	208	336	Peak
5430	45.04	36.25	54	-8.96	34.35	8.48	34.04	208	336	Average
5430	56.44	47.65	74	-17.56	34.35	8.48	34.04	208	336	Peak
ANTENNA POLARITY & TEST DISTANCE: VERTICAL AT 3 M										
FREQ. (MHz)	EMISSION LEVEL (dBuV/m)	READ LEVEL (dBuV)	LIMIT (dBuV/m)	MARGIN (dB)	ANTENNA FACTOR (dB/m)	CABLE LOSS (dB)	PREAMP FACTOR (dB)	ANTENNA HEIGHT (cm)	TABLE ANGLE (Degree)	REMARK
5082	42.38	34.22	54	-11.62	34.07	8.07	33.98	209	32	Average
5082	56.81	48.65	74	-17.19	34.07	8.07	33.98	209	32	Peak
5320	97.1	88.52			34.25	8.35	34.02	209	32	Average
5320	105.5	96.92			34.25	8.35	34.02	209	32	Peak
5432	44.72	35.93	54	-9.28	34.35	8.48	34.04	209	32	Average
5432	57.97	49.18	74	-16.03	34.35	8.48	34.04	209	32	Peak

REMARKS:

- Emission Level = Read Level + Antenna Factor + Cable Loss - Preamp Factor
Margin value = Emission level – Limit value
- 5320MHz: Fundamental frequency.



A D T

EUT TEST CONDITION		MEASUREMENT DETAIL	
CHANNEL	Channel 100	FREQUENCY RANGE	1GHz ~ 40GHz
INPUT POWER	120Vac, 60 Hz	DETECTOR FUNCTION	Peak (PK) Average (AV)
ENVIRONMENTAL CONDITIONS	25deg. C, 65%RH	TESTED BY	Charles Hsiao

ANTENNA POLARITY & TEST DISTANCE: HORIZONTAL AT 3 M										
FREQ. (MHz)	EMISSION LEVEL (dBuV/m)	READ LEVEL (dBuV)	LIMIT (dBuV/m)	MARGIN (dB)	ANTENNA FACTOR (dB/m)	CABLE LOSS (dB)	PREAMP FACTOR (dB)	ANTENNA HEIGHT (cm)	TABLE ANGLE (Degree)	REMARK
5350	45.06	36.43	54	-8.94	34.28	8.38	34.03	198	339	Average
5350	57.52	48.89	74	-16.48	34.28	8.38	34.03	198	339	Peak
5470	55.87	47.04	68.2	-12.33	34.37	8.51	34.05	198	339	Peak
5500	96.03	87.11			34.4	8.57	34.05	198	339	Average
5500	104.06	95.14			34.4	8.57	34.05	198	339	Peak
5725	56.16	47	68.2	-12.04	34.62	8.65	34.11	198	339	Peak
ANTENNA POLARITY & TEST DISTANCE: VERTICAL AT 3 M										
FREQ. (MHz)	EMISSION LEVEL (dBuV/m)	READ LEVEL (dBuV)	LIMIT (dBuV/m)	MARGIN (dB)	ANTENNA FACTOR (dB/m)	CABLE LOSS (dB)	PREAMP FACTOR (dB)	ANTENNA HEIGHT (cm)	TABLE ANGLE (Degree)	REMARK
5446	45.17	36.34	54	-8.83	34.36	8.51	34.04	219	30	Average
5446	58.32	49.49	74	-15.68	34.36	8.51	34.04	219	30	Peak
5470	56.42	47.59	68.2	-11.78	34.37	8.51	34.05	219	30	Peak
5500	98.11	89.19			34.4	8.57	34.05	219	30	Average
5500	106.36	97.44			34.4	8.57	34.05	219	30	Peak
5725	56.41	47.25	68.2	-11.79	34.62	8.65	34.11	219	30	Peak

REMARKS:

- Emission Level = Read Level + Antenna Factor + Cable Loss - Preamp Factor
Margin value = Emission level – Limit value
- 5500MHz: Fundamental frequency.
- 5470MHz & 5725MHz: Out of restricted band

EUT TEST CONDITION		MEASUREMENT DETAIL	
CHANNEL	Channel 116	FREQUENCY RANGE	1GHz ~ 40GHz
INPUT POWER	120Vac, 60 Hz	DETECTOR FUNCTION	Peak (PK) Average (AV)
ENVIRONMENTAL CONDITIONS	25deg. C, 65%RH	TESTED BY	Charles Hsiao

ANTENNA POLARITY & TEST DISTANCE: HORIZONTAL AT 3 M										
FREQ. (MHz)	EMISSION LEVEL (dBuV/m)	READ LEVEL (dBuV)	LIMIT (dBuV/m)	MARGIN (dB)	ANTENNA FACTOR (dB/m)	CABLE LOSS (dB)	PREAMP FACTOR (dB)	ANTENNA HEIGHT (cm)	TABLE ANGLE (Degree)	REMARK
5410	42.66	33.94	54	-11.34	34.32	8.44	34.04	170	339	Average
5410	56.54	47.82	74	-17.46	34.32	8.44	34.04	170	339	Peak
5470	55.43	46.6	68.2	-12.77	34.37	8.51	34.05	170	339	Peak
5580	96.07	87.08			34.47	8.6	34.08	170	339	Average
5580	104.16	95.17			34.47	8.6	34.08	170	339	Peak
5725	57.54	48.38	68.2	-10.66	34.62	8.65	34.11	170	339	Peak
ANTENNA POLARITY & TEST DISTANCE: VERTICAL AT 3 M										
FREQ. (MHz)	EMISSION LEVEL (dBuV/m)	READ LEVEL (dBuV)	LIMIT (dBuV/m)	MARGIN (dB)	ANTENNA FACTOR (dB/m)	CABLE LOSS (dB)	PREAMP FACTOR (dB)	ANTENNA HEIGHT (cm)	TABLE ANGLE (Degree)	REMARK
5438	42.72	33.93	54	-11.28	34.35	8.48	34.04	223	30	Average
5438	56.84	48.05	74	-17.16	34.35	8.48	34.04	223	30	Peak
5470	55.63	46.8	68.2	-12.57	34.37	8.51	34.05	223	30	Peak
5580	99.37	90.38			34.47	8.6	34.08	223	30	Average
5580	106.9	97.91			34.47	8.6	34.08	223	30	Peak
5725	55.59	46.43	68.2	-12.61	34.62	8.65	34.11	223	30	Peak

REMARKS:

- Emission Level = Read Level + Antenna Factor + Cable Loss - Preamp Factor
Margin value = Emission level – Limit value
- 5580MHz: Fundamental frequency.
- 5470MHz & 5725MHz: Out of restricted band



EUT TEST CONDITION		MEASUREMENT DETAIL	
CHANNEL	Channel 140	FREQUENCY RANGE	1GHz ~ 40GHz
INPUT POWER	120Vac, 60 Hz	DETECTOR FUNCTION	Peak (PK) Average (AV)
ENVIRONMENTAL CONDITIONS	25deg. C, 65%RH	TESTED BY	Charles Hsiao

ANTENNA POLARITY & TEST DISTANCE: HORIZONTAL AT 3 M										
FREQ. (MHz)	EMISSION LEVEL (dBuV/m)	READ LEVEL (dBuV)	LIMIT (dBuV/m)	MARGIN (dB)	ANTENNA FACTOR (dB/m)	CABLE LOSS (dB)	PREAMP FACTOR (dB)	ANTENNA HEIGHT (cm)	TABLE ANGLE (Degree)	REMARK
5406	42.62	33.9	54	-11.38	34.32	8.44	34.04	147	339	Average
5406	57.32	48.6	74	-16.68	34.32	8.44	34.04	147	339	Peak
5470	55.75	46.92	68.2	-12.45	34.37	8.51	34.05	147	339	Peak
5700	96.73	87.6			34.59	8.64	34.1	147	339	Average
5700	104.55	95.42			34.59	8.64	34.1	147	339	Peak
5725	58.9	49.74	68.2	-9.3	34.62	8.65	34.11	147	339	Peak
ANTENNA POLARITY & TEST DISTANCE: VERTICAL AT 3 M										
FREQ. (MHz)	EMISSION LEVEL (dBuV/m)	READ LEVEL (dBuV)	LIMIT (dBuV/m)	MARGIN (dB)	ANTENNA FACTOR (dB/m)	CABLE LOSS (dB)	PREAMP FACTOR (dB)	ANTENNA HEIGHT (cm)	TABLE ANGLE (Degree)	REMARK
5378	42.57	33.89	54	-11.43	34.31	8.41	34.04	209	30	Average
5378	56.83	48.15	74	-17.17	34.31	8.41	34.04	209	30	Peak
5470	55.6	46.77	68.2	-12.6	34.37	8.51	34.05	209	30	Peak
5700	98.83	89.7			34.59	8.64	34.1	209	30	Average
5700	106.74	97.61			34.59	8.64	34.1	209	30	Peak
5725	55.92	46.76	68.2	-12.28	34.62	8.65	34.11	209	30	Peak

REMARKS:

- Emission Level = Read Level + Antenna Factor + Cable Loss - Preamp Factor
Margin value = Emission level – Limit value
- 5700MHz: Fundamental frequency.
- 5470MHz & 5725MHz: Out of restricted band

EUT TEST CONDITION		MEASUREMENT DETAIL	
CHANNEL	Channel 149	FREQUENCY RANGE	1GHz ~ 40GHz
INPUT POWER	120Vac, 60 Hz	DETECTOR FUNCTION	Peak (PK) Average (AV)
ENVIRONMENTAL CONDITIONS	25deg. C, 65%RH	TESTED BY	Charles Hsiao

ANTENNA POLARITY & TEST DISTANCE: HORIZONTAL AT 3 M										
FREQ. (MHz)	EMISSION LEVEL (dBuV/m)	READ LEVEL (dBuV)	LIMIT (dBuV/m)	MARGIN (dB)	ANTENNA FACTOR (dB/m)	CABLE LOSS (dB)	PREAMP FACTOR (dB)	ANTENNA HEIGHT (cm)	TABLE ANGLE (Degree)	REMARK
*5714	56.47	47.32	68.2	-11.73	34.61	8.65	34.11	202	339	Peak
*5724	66.8	57.64	78.2	-11.4	34.62	8.65	34.11	202	339	Peak
5745	95.1	85.91			34.64	8.66	34.11	202	339	Average
5745	103.12	93.93			34.64	8.66	34.11	202	339	Peak
*5858	56.09	46.77	78.2	-22.11	34.76	8.7	34.14	202	339	Peak
*5862	56.4	47.07	68.2	-11.8	34.76	8.71	34.14	202	339	Peak
ANTENNA POLARITY & TEST DISTANCE: VERTICAL AT 3 M										
FREQ. (MHz)	EMISSION LEVEL (dBuV/m)	READ LEVEL (dBuV)	LIMIT (dBuV/m)	MARGIN (dB)	ANTENNA FACTOR (dB/m)	CABLE LOSS (dB)	PREAMP FACTOR (dB)	ANTENNA HEIGHT (cm)	TABLE ANGLE (Degree)	REMARK
*5708	56.82	47.67	68.2	-11.38	34.61	8.65	34.11	199	26	Peak
*5724	67.54	58.38	78.2	-10.66	34.62	8.65	34.11	199	26	Peak
5745	98	88.81			34.64	8.66	34.11	199	26	Average
5745	105.63	96.44			34.64	8.66	34.11	199	26	Peak
*5852	56.42	47.12	78.2	-21.78	34.74	8.7	34.14	199	26	Peak
*5862	56.52	47.19	68.2	-11.68	34.76	8.71	34.14	199	26	Peak

REMARKS:

- Emission Level = Read Level + Antenna Factor + Cable Loss - Preamp Factor
Margin value = Emission level – Limit value
- 5745MHz: Fundamental frequency.
- *: Out of restricted band



EUT TEST CONDITION		MEASUREMENT DETAIL	
CHANNEL	Channel 157	FREQUENCY RANGE	1GHz ~ 40GHz
INPUT POWER	120Vac, 60 Hz	DETECTOR FUNCTION	Peak (PK) Average (AV)
ENVIRONMENTAL CONDITIONS	25deg. C, 65%RH	TESTED BY	Charles Hsiao

ANTENNA POLARITY & TEST DISTANCE: HORIZONTAL AT 3 M										
FREQ. (MHz)	EMISSION LEVEL (dBuV/m)	READ LEVEL (dBuV)	LIMIT (dBuV/m)	MARGIN (dB)	ANTENNA FACTOR (dB/m)	CABLE LOSS (dB)	PREAMP FACTOR (dB)	ANTENNA HEIGHT (cm)	TABLE ANGLE (Degree)	REMARK
*5706	57.3	48.15	68.2	-10.9	34.61	8.65	34.11	203	339	Peak
*5718	56.8	47.64	78.2	-21.4	34.62	8.65	34.11	203	339	Peak
5785	95.36	86.13			34.68	8.68	34.13	203	339	Average
5785	103.18	93.95			34.68	8.68	34.13	203	339	Peak
*5858	57.22	47.9	78.2	-20.98	34.76	8.7	34.14	203	339	Peak
*5866	56.76	47.43	68.2	-11.44	34.76	8.71	34.14	203	339	Peak
ANTENNA POLARITY & TEST DISTANCE: VERTICAL AT 3 M										
FREQ. (MHz)	EMISSION LEVEL (dBuV/m)	READ LEVEL (dBuV)	LIMIT (dBuV/m)	MARGIN (dB)	ANTENNA FACTOR (dB/m)	CABLE LOSS (dB)	PREAMP FACTOR (dB)	ANTENNA HEIGHT (cm)	TABLE ANGLE (Degree)	REMARK
*5708	56.33	47.18	68.2	-11.87	34.61	8.65	34.11	199	26	Peak
*5720	56.05	46.89	78.2	-22.15	34.62	8.65	34.11	199	26	Peak
5785	97.8	88.57			34.68	8.68	34.13	199	26	Average
5785	105.6	96.37			34.68	8.68	34.13	199	26	Peak
*5858	56.4	47.08	78.2	-21.8	34.76	8.7	34.14	199	26	Peak
*5864	56.77	47.44	68.2	-11.43	34.76	8.71	34.14	199	26	Peak

REMARKS:

- Emission Level = Read Level + Antenna Factor + Cable Loss - Preamp Factor
Margin value = Emission level – Limit value
- 5785MHz: Fundamental frequency.
- *: Out of restricted band

EUT TEST CONDITION		MEASUREMENT DETAIL	
CHANNEL	Channel 165	FREQUENCY RANGE	1GHz ~ 40GHz
INPUT POWER	120Vac, 60 Hz	DETECTOR FUNCTION	Peak (PK) Average (AV)
ENVIRONMENTAL CONDITIONS	25deg. C, 65%RH	TESTED BY	Charles Hsiao

ANTENNA POLARITY & TEST DISTANCE: HORIZONTAL AT 3 M										
FREQ. (MHz)	EMISSION LEVEL (dBuV/m)	READ LEVEL (dBuV)	LIMIT (dBuV/m)	MARGIN (dB)	ANTENNA FACTOR (dB/m)	CABLE LOSS (dB)	PREAMP FACTOR (dB)	ANTENNA HEIGHT (cm)	TABLE ANGLE (Degree)	REMARK
*5712	56.97	47.82	68.2	-11.23	34.61	8.65	34.11	179	339	Peak
*5716	57.63	48.48	78.2	-20.57	34.61	8.65	34.11	179	339	Peak
5825	95.81	86.52			34.73	8.69	34.13	179	339	Average
5825	103.51	94.22			34.73	8.69	34.13	179	339	Peak
*5856	57.25	47.93	78.2	-20.95	34.76	8.7	34.14	179	339	Peak
*5866	57.63	48.3	68.2	-10.57	34.76	8.71	34.14	179	339	Peak
ANTENNA POLARITY & TEST DISTANCE: VERTICAL AT 3 M										
FREQ. (MHz)	EMISSION LEVEL (dBuV/m)	READ LEVEL (dBuV)	LIMIT (dBuV/m)	MARGIN (dB)	ANTENNA FACTOR (dB/m)	CABLE LOSS (dB)	PREAMP FACTOR (dB)	ANTENNA HEIGHT (cm)	TABLE ANGLE (Degree)	REMARK
*5708	56.73	47.58	68.2	-11.47	34.61	8.65	34.11	195	26	Peak
*5724	56.8	47.64	78.2	-21.4	34.62	8.65	34.11	195	26	Peak
5825	97.78	88.49			34.73	8.69	34.13	195	26	Average
5825	105.64	96.35			34.73	8.69	34.13	195	26	Peak
*5854	57.64	48.32	78.2	-20.56	34.76	8.7	34.14	195	26	Peak
*5868	57.74	48.41	68.2	-10.46	34.76	8.71	34.14	195	26	Peak

REMARKS:

- Emission Level = Read Level + Antenna Factor + Cable Loss - Preamp Factor
Margin value = Emission level – Limit value
- 5825MHz: Fundamental frequency.
- *: Out of restricted band

802.11n (20MHz)

EUT TEST CONDITION		MEASUREMENT DETAIL	
CHANNEL	Channel 36	FREQUENCY RANGE	1GHz ~ 40GHz
INPUT POWER	120Vac, 60 Hz	DETECTOR FUNCTION	Peak (PK) Average (AV)
ENVIRONMENTAL CONDITIONS	25deg. C, 65%RH	TESTED BY	Charles Hsiao

ANTENNA POLARITY & TEST DISTANCE: HORIZONTAL AT 3 M

FREQ. (MHz)	EMISSION LEVEL (dBuV/m)	READ LEVEL (dBuV)	LIMIT (dBuV/m)	MARGIN (dB)	ANTENNA FACTOR (dB/m)	CABLE LOSS (dB)	PREAMP FACTOR (dB)	ANTENNA HEIGHT (cm)	TABLE ANGLE (Degree)	REMARK
5132	44.2	35.98	54	-9.8	34.11	8.1	33.99	203	339	Average
5132	56.48	48.26	74	-17.52	34.11	8.1	33.99	203	339	Peak
5180	94.11	85.8			34.15	8.16	34	203	339	Average
5180	102.04	93.73			34.15	8.16	34	203	339	Peak
5358	42.97	34.34	54	-11.03	34.28	8.38	34.03	203	339	Average
5358	56.32	47.69	74	-17.68	34.28	8.38	34.03	203	339	Peak

ANTENNA POLARITY & TEST DISTANCE: VERTICAL AT 3 M

FREQ. (MHz)	EMISSION LEVEL (dBuV/m)	READ LEVEL (dBuV)	LIMIT (dBuV/m)	MARGIN (dB)	ANTENNA FACTOR (dB/m)	CABLE LOSS (dB)	PREAMP FACTOR (dB)	ANTENNA HEIGHT (cm)	TABLE ANGLE (Degree)	REMARK
5106	44.16	35.99	54	-9.84	34.09	8.07	33.99	217	26	Average
5106	56.88	48.71	74	-17.12	34.09	8.07	33.99	217	26	Peak
5180	96.01	87.7			34.15	8.16	34	217	26	Average
5180	104.11	95.8			34.15	8.16	34	217	26	Peak
5454	42.77	33.95	54	-11.23	34.36	8.51	34.05	217	26	Average
5454	58.04	49.22	74	-15.96	34.36	8.51	34.05	217	26	Peak

REMARKS:

- Emission Level = Read Level + Antenna Factor + Cable Loss - Preamp Factor
Margin value = Emission level – Limit value
- 5180MHz: Fundamental frequency.



A D T

EUT TEST CONDITION		MEASUREMENT DETAIL	
CHANNEL	Channel 44	FREQUENCY RANGE	1GHz ~ 40GHz
INPUT POWER	120Vac, 60 Hz	DETECTOR FUNCTION	Peak (PK) Average (AV)
ENVIRONMENTAL CONDITIONS	25deg. C, 65%RH	TESTED BY	Charles Hsiao

ANTENNA POLARITY & TEST DISTANCE: HORIZONTAL AT 3 M										
FREQ. (MHz)	EMISSION LEVEL (dBuV/m)	READ LEVEL (dBuV)	LIMIT (dBuV/m)	MARGIN (dB)	ANTENNA FACTOR (dB/m)	CABLE LOSS (dB)	PREAMP FACTOR (dB)	ANTENNA HEIGHT (cm)	TABLE ANGLE (Degree)	REMARK
5134	42.74	34.49	54	-11.26	34.11	8.13	33.99	203	339	Average
5134	56.57	48.32	74	-17.43	34.11	8.13	33.99	203	339	Peak
5220	95	86.61			34.17	8.22	34	203	339	Average
5220	102.56	94.17			34.17	8.22	34	203	339	Peak
5456	42.77	33.95	54	-11.23	34.36	8.51	34.05	203	339	Average
5456	57.73	48.91	74	-16.27	34.36	8.51	34.05	203	339	Peak
ANTENNA POLARITY & TEST DISTANCE: VERTICAL AT 3 M										
FREQ. (MHz)	EMISSION LEVEL (dBuV/m)	READ LEVEL (dBuV)	LIMIT (dBuV/m)	MARGIN (dB)	ANTENNA FACTOR (dB/m)	CABLE LOSS (dB)	PREAMP FACTOR (dB)	ANTENNA HEIGHT (cm)	TABLE ANGLE (Degree)	REMARK
5134	42.57	34.32	54	-11.43	34.11	8.13	33.99	214	26	Average
5134	56.75	48.5	74	-17.25	34.11	8.13	33.99	214	26	Peak
5220	96	87.61			34.17	8.22	34	214	26	Average
5220	104.31	95.92			34.17	8.22	34	214	26	Peak
5446	42.73	33.9	54	-11.27	34.36	8.51	34.04	214	26	Average
5446	56.78	47.95	74	-17.22	34.36	8.51	34.04	214	26	Peak

REMARKS:

- Emission Level = Read Level + Antenna Factor + Cable Loss - Preamp Factor
Margin value = Emission level – Limit value
- 5220MHz: Fundamental frequency.



EUT TEST CONDITION		MEASUREMENT DETAIL	
CHANNEL	Channel 48	FREQUENCY RANGE	1GHz ~ 40GHz
INPUT POWER	120Vac, 60 Hz	DETECTOR FUNCTION	Peak (PK) Average (AV)
ENVIRONMENTAL CONDITIONS	25deg. C, 65%RH	TESTED BY	Charles Hsiao

ANTENNA POLARITY & TEST DISTANCE: HORIZONTAL AT 3 M										
FREQ. (MHz)	EMISSION LEVEL (dBuV/m)	READ LEVEL (dBuV)	LIMIT (dBuV/m)	MARGIN (dB)	ANTENNA FACTOR (dB/m)	CABLE LOSS (dB)	PREAMP FACTOR (dB)	ANTENNA HEIGHT (cm)	TABLE ANGLE (Degree)	REMARK
5144	42.55	34.3	54	-11.45	34.12	8.13	34	203	339	Average
5144	56.49	48.24	74	-17.51	34.12	8.13	34	203	339	Peak
5240	94.54	86.1			34.19	8.26	34.01	203	339	Average
5240	102.61	94.17			34.19	8.26	34.01	203	339	Peak
5440	42.82	34.03	54	-11.18	34.35	8.48	34.04	203	339	Average
5440	57.39	48.6	74	-16.61	34.35	8.48	34.04	203	339	Peak
ANTENNA POLARITY & TEST DISTANCE: VERTICAL AT 3 M										
FREQ. (MHz)	EMISSION LEVEL (dBuV/m)	READ LEVEL (dBuV)	LIMIT (dBuV/m)	MARGIN (dB)	ANTENNA FACTOR (dB/m)	CABLE LOSS (dB)	PREAMP FACTOR (dB)	ANTENNA HEIGHT (cm)	TABLE ANGLE (Degree)	REMARK
5064	42.44	34.34	54	-11.56	34.05	8.03	33.98	214	26	Average
5064	57.12	49.02	74	-16.88	34.05	8.03	33.98	214	26	Peak
5240	96.02	87.58			34.19	8.26	34.01	214	26	Average
5240	104.01	95.57			34.19	8.26	34.01	214	26	Peak
5400	42.86	34.14	54	-11.14	34.32	8.44	34.04	214	26	Average
5400	56.98	48.26	74	-17.02	34.32	8.44	34.04	214	26	Peak

REMARKS:

- Emission Level = Read Level + Antenna Factor + Cable Loss - Preamp Factor
Margin value = Emission level – Limit value
- 5240MHz: Fundamental frequency.



A D T

EUT TEST CONDITION		MEASUREMENT DETAIL	
CHANNEL	Channel 52	FREQUENCY RANGE	1GHz ~ 40GHz
INPUT POWER	120Vac, 60 Hz	DETECTOR FUNCTION	Peak (PK) Average (AV)
ENVIRONMENTAL CONDITIONS	25deg. C, 65%RH	TESTED BY	Charles Hsiao

ANTENNA POLARITY & TEST DISTANCE: HORIZONTAL AT 3 M										
FREQ. (MHz)	EMISSION LEVEL (dBuV/m)	READ LEVEL (dBuV)	LIMIT (dBuV/m)	MARGIN (dB)	ANTENNA FACTOR (dB/m)	CABLE LOSS (dB)	PREAMP FACTOR (dB)	ANTENNA HEIGHT (cm)	TABLE ANGLE (Degree)	REMARK
5124	42.47	34.25	54	-11.53	34.11	8.1	33.99	208	336	Average
5124	56.67	48.45	74	-17.33	34.11	8.1	33.99	208	336	Peak
5260	94.07	85.61			34.21	8.26	34.01	208	336	Average
5260	102.41	93.95			34.21	8.26	34.01	208	336	Peak
5454	42.76	33.94	54	-11.24	34.36	8.51	34.05	208	336	Average
5454	56.97	48.15	74	-17.03	34.36	8.51	34.05	208	336	Peak

ANTENNA POLARITY & TEST DISTANCE: VERTICAL AT 3 M										
FREQ. (MHz)	EMISSION LEVEL (dBuV/m)	READ LEVEL (dBuV)	LIMIT (dBuV/m)	MARGIN (dB)	ANTENNA FACTOR (dB/m)	CABLE LOSS (dB)	PREAMP FACTOR (dB)	ANTENNA HEIGHT (cm)	TABLE ANGLE (Degree)	REMARK
5100	42.42	34.26	54	-11.58	34.08	8.07	33.99	204	32	Average
5100	56.35	48.19	74	-17.65	34.08	8.07	33.99	204	32	Peak
5260	96.47	88.01			34.21	8.26	34.01	204	32	Average
5260	104.13	95.67			34.21	8.26	34.01	204	32	Peak
5440	42.64	33.85	54	-11.36	34.35	8.48	34.04	204	32	Average
5440	57.32	48.53	74	-16.68	34.35	8.48	34.04	204	32	Peak

REMARKS:

1. Emission Level = Read Level + Antenna Factor + Cable Loss - Preamp Factor
Margin value = Emission level – Limit value
2. 5260MHz: Fundamental frequency.



EUT TEST CONDITION		MEASUREMENT DETAIL	
CHANNEL	Channel 60	FREQUENCY RANGE	1GHz ~ 40GHz
INPUT POWER	120Vac, 60 Hz	DETECTOR FUNCTION	Peak (PK) Average (AV)
ENVIRONMENTAL CONDITIONS	25deg. C, 65%RH	TESTED BY	Charles Hsiao

ANTENNA POLARITY & TEST DISTANCE: HORIZONTAL AT 3 M										
FREQ. (MHz)	EMISSION LEVEL (dBuV/m)	READ LEVEL (dBuV)	LIMIT (dBuV/m)	MARGIN (dB)	ANTENNA FACTOR (dB/m)	CABLE LOSS (dB)	PREAMP FACTOR (dB)	ANTENNA HEIGHT (cm)	TABLE ANGLE (Degree)	REMARK
5138	42.57	34.32	54	-11.43	34.11	8.13	33.99	208	336	Average
5138	55.81	47.56	74	-18.19	34.11	8.13	33.99	208	336	Peak
5300	93.86	85.32			34.24	8.32	34.02	208	336	Average
5300	102.26	93.72			34.24	8.32	34.02	208	336	Peak
5454	44.92	36.1	54	-9.08	34.36	8.51	34.05	208	336	Average
5454	56.72	47.9	74	-17.28	34.36	8.51	34.05	208	336	Peak
ANTENNA POLARITY & TEST DISTANCE: VERTICAL AT 3 M										
FREQ. (MHz)	EMISSION LEVEL (dBuV/m)	READ LEVEL (dBuV)	LIMIT (dBuV/m)	MARGIN (dB)	ANTENNA FACTOR (dB/m)	CABLE LOSS (dB)	PREAMP FACTOR (dB)	ANTENNA HEIGHT (cm)	TABLE ANGLE (Degree)	REMARK
5140	42.49	34.23	54	-11.51	34.12	8.13	33.99	194	32	Average
5140	56.72	48.46	74	-17.28	34.12	8.13	33.99	194	32	Peak
5300	97.06	88.52			34.24	8.32	34.02	194	32	Average
5300	104.79	96.25			34.24	8.32	34.02	194	32	Peak
5430	44.97	36.18	54	-9.03	34.35	8.48	34.04	194	32	Average
5430	57.59	48.8	74	-16.41	34.35	8.48	34.04	194	32	Peak

REMARKS:

- Emission Level = Read Level + Antenna Factor + Cable Loss - Preamp Factor
Margin value = Emission level – Limit value
- 5300MHz: Fundamental frequency.

EUT TEST CONDITION		MEASUREMENT DETAIL	
CHANNEL	Channel 64	FREQUENCY RANGE	1GHz ~ 40GHz
INPUT POWER	120Vac, 60 Hz	DETECTOR FUNCTION	Peak (PK) Average (AV)
ENVIRONMENTAL CONDITIONS	25deg. C, 65%RH	TESTED BY	Charles Hsiao

ANTENNA POLARITY & TEST DISTANCE: HORIZONTAL AT 3 M										
FREQ. (MHz)	EMISSION LEVEL (dBuV/m)	READ LEVEL (dBuV)	LIMIT (dBuV/m)	MARGIN (dB)	ANTENNA FACTOR (dB/m)	CABLE LOSS (dB)	PREAMP FACTOR (dB)	ANTENNA HEIGHT (cm)	TABLE ANGLE (Degree)	REMARK
5114	42.5	34.3	54	-11.5	34.09	8.1	33.99	208	336	Average
5114	56.28	48.08	74	-17.72	34.09	8.1	33.99	208	336	Peak
5320	94	85.42			34.25	8.35	34.02	208	336	Average
5320	102.17	93.59			34.25	8.35	34.02	208	336	Peak
5456	44.57	35.75	54	-9.43	34.36	8.51	34.05	208	336	Average
5456	58.11	49.29	74	-15.89	34.36	8.51	34.05	208	336	Peak
ANTENNA POLARITY & TEST DISTANCE: VERTICAL AT 3 M										
FREQ. (MHz)	EMISSION LEVEL (dBuV/m)	READ LEVEL (dBuV)	LIMIT (dBuV/m)	MARGIN (dB)	ANTENNA FACTOR (dB/m)	CABLE LOSS (dB)	PREAMP FACTOR (dB)	ANTENNA HEIGHT (cm)	TABLE ANGLE (Degree)	REMARK
5144	42.61	34.36	54	-11.39	34.12	8.13	34	209	32	Average
5144	56.98	48.73	74	-17.02	34.12	8.13	34	209	32	Peak
5320	96.6	88.02			34.25	8.35	34.02	209	32	Average
5320	104.23	95.65			34.25	8.35	34.02	209	32	Peak
5418	44.48	35.75	54	-9.52	34.33	8.44	34.04	209	32	Average
5418	56.76	48.03	74	-17.24	34.33	8.44	34.04	209	32	Peak

REMARKS:

- Emission Level = Read Level + Antenna Factor + Cable Loss - Preamp Factor
Margin value = Emission level – Limit value
- 5320MHz: Fundamental frequency.

EUT TEST CONDITION		MEASUREMENT DETAIL	
CHANNEL	Channel 100	FREQUENCY RANGE	1GHz ~ 40GHz
INPUT POWER	120Vac, 60 Hz	DETECTOR FUNCTION	Peak (PK) Average (AV)
ENVIRONMENTAL CONDITIONS	25deg. C, 65%RH	TESTED BY	Charles Hsiao

ANTENNA POLARITY & TEST DISTANCE: HORIZONTAL AT 3 M										
FREQ. (MHz)	EMISSION LEVEL (dBuV/m)	READ LEVEL (dBuV)	LIMIT (dBuV/m)	MARGIN (dB)	ANTENNA FACTOR (dB/m)	CABLE LOSS (dB)	PREAMP FACTOR (dB)	ANTENNA HEIGHT (cm)	TABLE ANGLE (Degree)	REMARK
5448	44.97	36.14	54	-9.03	34.36	8.51	34.04	198	339	Average
5448	56.84	48.01	74	-17.16	34.36	8.51	34.04	198	339	Peak
5470	55.52	46.69	68.2	-12.68	34.37	8.51	34.05	198	339	Peak
5500	95.27	86.35			34.4	8.57	34.05	198	339	Average
5500	103.46	94.54			34.4	8.57	34.05	198	339	Peak
5725	54.83	45.67	68.2	-13.37	34.62	8.65	34.11	198	339	Peak
ANTENNA POLARITY & TEST DISTANCE: VERTICAL AT 3 M										
FREQ. (MHz)	EMISSION LEVEL (dBuV/m)	READ LEVEL (dBuV)	LIMIT (dBuV/m)	MARGIN (dB)	ANTENNA FACTOR (dB/m)	CABLE LOSS (dB)	PREAMP FACTOR (dB)	ANTENNA HEIGHT (cm)	TABLE ANGLE (Degree)	REMARK
5350	44.66	36.03	54	-9.34	34.28	8.38	34.03	219	30	Average
5350	57.33	48.7	74	-16.67	34.28	8.38	34.03	219	30	Peak
5470	55.56	46.73	68.2	-12.64	34.37	8.51	34.05	219	30	Peak
5500	97.18	88.26			34.4	8.57	34.05	219	30	Average
5500	105.48	96.56			34.4	8.57	34.05	219	30	Peak
5725	55.02	45.86	68.2	-13.18	34.62	8.65	34.11	219	30	Peak

REMARKS:

- Emission Level = Read Level + Antenna Factor + Cable Loss - Preamp Factor
Margin value = Emission level – Limit value
- 5500MHz: Fundamental frequency.
- 5470MHz & 5725MHz: Out of restricted band

EUT TEST CONDITION		MEASUREMENT DETAIL	
CHANNEL	Channel 116	FREQUENCY RANGE	1GHz ~ 40GHz
INPUT POWER	120Vac, 60 Hz	DETECTOR FUNCTION	Peak (PK) Average (AV)
ENVIRONMENTAL CONDITIONS	25deg. C, 65%RH	TESTED BY	Charles Hsiao

ANTENNA POLARITY & TEST DISTANCE: HORIZONTAL AT 3 M										
FREQ. (MHz)	EMISSION LEVEL (dBuV/m)	READ LEVEL (dBuV)	LIMIT (dBuV/m)	MARGIN (dB)	ANTENNA FACTOR (dB/m)	CABLE LOSS (dB)	PREAMP FACTOR (dB)	ANTENNA HEIGHT (cm)	TABLE ANGLE (Degree)	REMARK
5412	42.58	33.85	54	-11.42	34.33	8.44	34.04	170	339	Average
5412	57.27	48.54	74	-16.73	34.33	8.44	34.04	170	339	Peak
5470	56.52	47.69	68.2	-11.68	34.37	8.51	34.05	170	339	Peak
5580	95.67	86.68			34.47	8.6	34.08	170	339	Average
5580	103.3	94.31			34.47	8.6	34.08	170	339	Peak
5725	55.44	46.28	68.2	-12.76	34.62	8.65	34.11	170	339	Peak
ANTENNA POLARITY & TEST DISTANCE: VERTICAL AT 3 M										
FREQ. (MHz)	EMISSION LEVEL (dBuV/m)	READ LEVEL (dBuV)	LIMIT (dBuV/m)	MARGIN (dB)	ANTENNA FACTOR (dB/m)	CABLE LOSS (dB)	PREAMP FACTOR (dB)	ANTENNA HEIGHT (cm)	TABLE ANGLE (Degree)	REMARK
5424	42.61	33.84	54	-11.39	34.33	8.48	34.04	223	30	Average
5424	56.57	47.8	74	-17.43	34.33	8.48	34.04	223	30	Peak
5470	56.55	47.72	68.2	-11.65	34.37	8.51	34.05	223	30	Peak
5580	96.87	87.88			34.47	8.6	34.08	223	30	Average
5580	105.11	96.12			34.47	8.6	34.08	223	30	Peak
5725	53.55	44.39	68.2	-14.65	34.62	8.65	34.11	223	30	Peak

REMARKS:

- Emission Level = Read Level + Antenna Factor + Cable Loss - Preamp Factor
Margin value = Emission level – Limit value
- 5580MHz: Fundamental frequency.
- 5470MHz & 5725MHz: Out of restricted band



A D T

EUT TEST CONDITION		MEASUREMENT DETAIL	
CHANNEL	Channel 140	FREQUENCY RANGE	1GHz ~ 40GHz
INPUT POWER	120Vac, 60 Hz	DETECTOR FUNCTION	Peak (PK) Average (AV)
ENVIRONMENTAL CONDITIONS	25deg. C, 65%RH	TESTED BY	Charles Hsiao

ANTENNA POLARITY & TEST DISTANCE: HORIZONTAL AT 3 M										
FREQ. (MHz)	EMISSION LEVEL (dBuV/m)	READ LEVEL (dBuV)	LIMIT (dBuV/m)	MARGIN (dB)	ANTENNA FACTOR (dB/m)	CABLE LOSS (dB)	PREAMP FACTOR (dB)	ANTENNA HEIGHT (cm)	TABLE ANGLE (Degree)	REMARK
5452	42.68	33.86	54	-11.32	34.36	8.51	34.05	147	339	Average
5452	57.6	48.78	74	-16.4	34.36	8.51	34.05	147	339	Peak
5470	57.59	48.76	68.2	-10.61	34.37	8.51	34.05	147	339	Peak
5700	94.53	85.4			34.59	8.64	34.1	147	339	Average
5700	103	93.87			34.59	8.64	34.1	147	339	Peak
5725	56.15	46.99	68.2	-12.05	34.62	8.65	34.11	147	339	Peak
ANTENNA POLARITY & TEST DISTANCE: VERTICAL AT 3 M										
FREQ. (MHz)	EMISSION LEVEL (dBuV/m)	READ LEVEL (dBuV)	LIMIT (dBuV/m)	MARGIN (dB)	ANTENNA FACTOR (dB/m)	CABLE LOSS (dB)	PREAMP FACTOR (dB)	ANTENNA HEIGHT (cm)	TABLE ANGLE (Degree)	REMARK
5354	42.55	33.92	54	-11.45	34.28	8.38	34.03	209	30	Average
5354	57.35	48.72	74	-16.65	34.28	8.38	34.03	209	30	Peak
5470	54.57	45.74	68.2	-13.63	34.37	8.51	34.05	209	30	Peak
5700	97.23	88.1			34.59	8.64	34.1	209	30	Average
5700	105.67	96.54			34.59	8.64	34.1	209	30	Peak
5725	55.44	46.28	68.2	-12.76	34.62	8.65	34.11	209	30	Peak

REMARKS:

- Emission Level = Read Level + Antenna Factor + Cable Loss - Preamp Factor
Margin value = Emission level – Limit value
- 5700MHz: Fundamental frequency.
- 5470MHz & 5725MHz: Out of restricted band



EUT TEST CONDITION		MEASUREMENT DETAIL	
CHANNEL	Channel 149	FREQUENCY RANGE	1GHz ~ 40GHz
INPUT POWER	120Vac, 60 Hz	DETECTOR FUNCTION	Peak (PK) Average (AV)
ENVIRONMENTAL CONDITIONS	25deg. C, 65%RH	TESTED BY	Charles Hsiao

ANTENNA POLARITY & TEST DISTANCE: HORIZONTAL AT 3 M										
FREQ. (MHz)	EMISSION LEVEL (dBuV/m)	READ LEVEL (dBuV)	LIMIT (dBuV/m)	MARGIN (dB)	ANTENNA FACTOR (dB/m)	CABLE LOSS (dB)	PREAMP FACTOR (dB)	ANTENNA HEIGHT (cm)	TABLE ANGLE (Degree)	REMARK
*5712	57.56	48.41	68.2	-10.64	34.61	8.65	34.11	202	342	Peak
*5722	62.26	53.1	78.2	-15.94	34.62	8.65	34.11	202	342	Peak
5745	94.53	85.34			34.64	8.66	34.11	202	342	Average
5745	102.06	92.87			34.64	8.66	34.11	202	342	Peak
*5860	58.71	49.39	78.2	-19.49	34.76	8.7	34.14	202	342	Peak
*5864	58.42	49.09	68.2	-9.78	34.76	8.71	34.14	202	342	Peak
ANTENNA POLARITY & TEST DISTANCE: VERTICAL AT 3 M										
FREQ. (MHz)	EMISSION LEVEL (dBuV/m)	READ LEVEL (dBuV)	LIMIT (dBuV/m)	MARGIN (dB)	ANTENNA FACTOR (dB/m)	CABLE LOSS (dB)	PREAMP FACTOR (dB)	ANTENNA HEIGHT (cm)	TABLE ANGLE (Degree)	REMARK
*5706	57.4	48.25	68.2	-10.8	34.61	8.65	34.11	208	25	Peak
*5724	64.61	55.45	78.2	-13.59	34.62	8.65	34.11	208	25	Peak
5745	97.06	87.87			34.64	8.66	34.11	208	25	Average
5745	104.59	95.4			34.64	8.66	34.11	208	25	Peak
*5854	58.4	49.08	78.2	-19.8	34.76	8.7	34.14	208	25	Peak
*5864	58.08	48.75	68.2	-10.12	34.76	8.71	34.14	208	25	Peak

REMARKS:

- Emission Level = Read Level + Antenna Factor + Cable Loss - Preamp Factor
Margin value = Emission level – Limit value
- 5745MHz: Fundamental frequency.
- *: Out of restricted band



EUT TEST CONDITION		MEASUREMENT DETAIL	
CHANNEL	Channel 157	FREQUENCY RANGE	1GHz ~ 40GHz
INPUT POWER	120Vac, 60 Hz	DETECTOR FUNCTION	Peak (PK) Average (AV)
ENVIRONMENTAL CONDITIONS	25deg. C, 65%RH	TESTED BY	Charles Hsiao

ANTENNA POLARITY & TEST DISTANCE: HORIZONTAL AT 3 M										
FREQ. (MHz)	EMISSION LEVEL (dBuV/m)	READ LEVEL (dBuV)	LIMIT (dBuV/m)	MARGIN (dB)	ANTENNA FACTOR (dB/m)	CABLE LOSS (dB)	PREAMP FACTOR (dB)	ANTENNA HEIGHT (cm)	TABLE ANGLE (Degree)	REMARK
*5708	57.72	48.57	68.2	-10.48	34.61	8.65	34.11	188	339	Peak
*5718	58.05	48.89	78.2	-20.15	34.62	8.65	34.11	188	339	Peak
5785	95.05	85.82			34.68	8.68	34.13	188	339	Average
5785	102.89	93.66			34.68	8.68	34.13	188	339	Peak
*5852	57.75	48.45	78.2	-20.45	34.74	8.7	34.14	188	339	Peak
*5866	58.43	49.1	68.2	-9.77	34.76	8.71	34.14	188	339	Peak
ANTENNA POLARITY & TEST DISTANCE: VERTICAL AT 3 M										
FREQ. (MHz)	EMISSION LEVEL (dBuV/m)	READ LEVEL (dBuV)	LIMIT (dBuV/m)	MARGIN (dB)	ANTENNA FACTOR (dB/m)	CABLE LOSS (dB)	PREAMP FACTOR (dB)	ANTENNA HEIGHT (cm)	TABLE ANGLE (Degree)	REMARK
*5712	56.63	47.48	68.2	-11.57	34.61	8.65	34.11	198	26	Peak
*5718	57.07	47.91	78.2	-21.13	34.62	8.65	34.11	198	26	Peak
5785	96.58	87.35			34.68	8.68	34.13	198	26	Average
5785	104.76	95.53			34.68	8.68	34.13	198	26	Peak
*5854	57.36	48.04	78.2	-20.84	34.76	8.7	34.14	198	26	Peak
*5868	57.62	48.29	68.2	-10.58	34.76	8.71	34.14	198	26	Peak

REMARKS:

- Emission Level = Read Level + Antenna Factor + Cable Loss - Preamp Factor
Margin value = Emission level – Limit value
- 5785MHz: Fundamental frequency.
- *: Out of restricted band

EUT TEST CONDITION		MEASUREMENT DETAIL	
CHANNEL	Channel 165	FREQUENCY RANGE	1GHz ~ 40GHz
INPUT POWER	120Vac, 60 Hz	DETECTOR FUNCTION	Peak (PK) Average (AV)
ENVIRONMENTAL CONDITIONS	25deg. C, 65%RH	TESTED BY	Charles Hsiao

ANTENNA POLARITY & TEST DISTANCE: HORIZONTAL AT 3 M										
FREQ. (MHz)	EMISSION LEVEL (dBuV/m)	READ LEVEL (dBuV)	LIMIT (dBuV/m)	MARGIN (dB)	ANTENNA FACTOR (dB/m)	CABLE LOSS (dB)	PREAMP FACTOR (dB)	ANTENNA HEIGHT (cm)	TABLE ANGLE (Degree)	REMARK
*5708	57.39	48.24	68.2	-10.81	34.61	8.65	34.11	179	339	Peak
*5722	57.58	48.42	78.2	-20.62	34.62	8.65	34.11	179	339	Peak
5825	94.44	85.15			34.73	8.69	34.13	179	339	Average
5825	102.21	92.92			34.73	8.69	34.13	179	339	Peak
*5858	56.76	47.44	78.2	-21.44	34.76	8.7	34.14	179	339	Peak
*5868	58.02	48.69	68.2	-10.18	34.76	8.71	34.14	179	339	Peak
ANTENNA POLARITY & TEST DISTANCE: VERTICAL AT 3 M										
FREQ. (MHz)	EMISSION LEVEL (dBuV/m)	READ LEVEL (dBuV)	LIMIT (dBuV/m)	MARGIN (dB)	ANTENNA FACTOR (dB/m)	CABLE LOSS (dB)	PREAMP FACTOR (dB)	ANTENNA HEIGHT (cm)	TABLE ANGLE (Degree)	REMARK
*5714	58.01	48.86	68.2	-10.19	34.61	8.65	34.11	195	26	Peak
*5724	57.52	48.36	78.2	-20.68	34.62	8.65	34.11	195	26	Peak
5825	97.33	88.04			34.73	8.69	34.13	195	26	Average
5825	104.85	95.56			34.73	8.69	34.13	195	26	Peak
*5858	58.09	48.77	78.2	-20.11	34.76	8.7	34.14	195	26	Peak
*5868	58	48.67	68.2	-10.2	34.76	8.71	34.14	195	26	Peak

REMARKS:

- Emission Level = Read Level + Antenna Factor + Cable Loss - Preamp Factor
Margin value = Emission level – Limit value
- 5825MHz: Fundamental frequency.
- *: Out of restricted band



802.11n (40MHz)

EUT TEST CONDITION		MEASUREMENT DETAIL	
CHANNEL	Channel 38	FREQUENCY RANGE	1GHz ~ 40GHz
INPUT POWER	120Vac, 60 Hz	DETECTOR FUNCTION	Peak (PK) Average (AV)
ENVIRONMENTAL CONDITIONS	25deg. C, 65%RH	TESTED BY	Charles Hsiao

ANTENNA POLARITY & TEST DISTANCE: HORIZONTAL AT 3 M

FREQ. (MHz)	EMISSION LEVEL (dBuV/m)	READ LEVEL (dBuV)	LIMIT (dBuV/m)	MARGIN (dB)	ANTENNA FACTOR (dB/m)	CABLE LOSS (dB)	PREAMP FACTOR (dB)	ANTENNA HEIGHT (cm)	TABLE ANGLE (Degree)	REMARK
5150	43.45	35.2	54	-10.55	34.12	8.13	34	203	339	Average
5150	56.96	48.71	74	-17.04	34.12	8.13	34	203	339	Peak
5190	94.02	85.68			34.15	8.19	34	203	339	Average
5190	102.12	93.78			34.15	8.19	34	203	339	Peak
5428	43.01	34.24	54	-10.99	34.33	8.48	34.04	203	339	Average
5428	57.44	48.67	74	-16.56	34.33	8.48	34.04	203	339	Peak

ANTENNA POLARITY & TEST DISTANCE: VERTICAL AT 3 M

FREQ. (MHz)	EMISSION LEVEL (dBuV/m)	READ LEVEL (dBuV)	LIMIT (dBuV/m)	MARGIN (dB)	ANTENNA FACTOR (dB/m)	CABLE LOSS (dB)	PREAMP FACTOR (dB)	ANTENNA HEIGHT (cm)	TABLE ANGLE (Degree)	REMARK
5104	43.55	35.39	54	-10.45	34.08	8.07	33.99	206	26	Average
5104	58	49.84	74	-16	34.08	8.07	33.99	206	26	Peak
5190	96.14	87.8			34.15	8.19	34	206	26	Average
5190	104	95.66			34.15	8.19	34	206	26	Peak
5434	43.04	34.25	54	-10.96	34.35	8.48	34.04	206	26	Average
5434	57.22	48.43	74	-16.78	34.35	8.48	34.04	206	26	Peak

REMARKS:

- Emission Level = Read Level + Antenna Factor + Cable Loss - Preamp Factor
Margin value = Emission level – Limit value
- 5190MHz: Fundamental frequency.



EUT TEST CONDITION		MEASUREMENT DETAIL	
CHANNEL	Channel 46	FREQUENCY RANGE	1GHz ~ 40GHz
INPUT POWER	120Vac, 60 Hz	DETECTOR FUNCTION	Peak (PK) Average (AV)
ENVIRONMENTAL CONDITIONS	25deg. C, 65%RH	TESTED BY	Charles Hsiao

ANTENNA POLARITY & TEST DISTANCE: HORIZONTAL AT 3 M										
FREQ. (MHz)	EMISSION LEVEL (dBuV/m)	READ LEVEL (dBuV)	LIMIT (dBuV/m)	MARGIN (dB)	ANTENNA FACTOR (dB/m)	CABLE LOSS (dB)	PREAMP FACTOR (dB)	ANTENNA HEIGHT (cm)	TABLE ANGLE (Degree)	REMARK
5108	42.79	34.59	54	-11.21	34.09	8.1	33.99	203	339	Average
5108	56.84	48.64	74	-17.16	34.09	8.1	33.99	203	339	Peak
5230	94.11	85.71			34.19	8.22	34.01	203	339	Average
5230	102.23	93.83			34.19	8.22	34.01	203	339	Peak
5460	43.11	34.29	54	-10.89	34.36	8.51	34.05	203	339	Average
5460	56.75	47.93	74	-17.25	34.36	8.51	34.05	203	339	Peak

ANTENNA POLARITY & TEST DISTANCE: VERTICAL AT 3 M										
FREQ. (MHz)	EMISSION LEVEL (dBuV/m)	READ LEVEL (dBuV)	LIMIT (dBuV/m)	MARGIN (dB)	ANTENNA FACTOR (dB/m)	CABLE LOSS (dB)	PREAMP FACTOR (dB)	ANTENNA HEIGHT (cm)	TABLE ANGLE (Degree)	REMARK
5056	42.74	34.64	54	-11.26	34.05	8.03	33.98	214	26	Average
5056	56.43	48.33	74	-17.57	34.05	8.03	33.98	214	26	Peak
5230	96.11	87.71			34.19	8.22	34.01	214	26	Average
5230	104.58	96.18			34.19	8.22	34.01	214	26	Peak
5420	43.06	34.29	54	-10.94	34.33	8.48	34.04	214	26	Average
5420	56.61	47.84	74	-17.39	34.33	8.48	34.04	214	26	Peak

REMARKS:

- Emission Level = Read Level + Antenna Factor + Cable Loss - Preamp Factor
Margin value = Emission level – Limit value
- 5230MHz: Fundamental frequency.



EUT TEST CONDITION		MEASUREMENT DETAIL	
CHANNEL	Channel 54	FREQUENCY RANGE	1GHz ~ 40GHz
INPUT POWER	120Vac, 60 Hz	DETECTOR FUNCTION	Peak (PK) Average (AV)
ENVIRONMENTAL CONDITIONS	25deg. C, 65%RH	TESTED BY	Charles Hsiao

ANTENNA POLARITY & TEST DISTANCE: HORIZONTAL AT 3 M										
FREQ. (MHz)	EMISSION LEVEL (dBuV/m)	READ LEVEL (dBuV)	LIMIT (dBuV/m)	MARGIN (dB)	ANTENNA FACTOR (dB/m)	CABLE LOSS (dB)	PREAMP FACTOR (dB)	ANTENNA HEIGHT (cm)	TABLE ANGLE (Degree)	REMARK
5052	42.8	34.74	54	-11.2	34.04	8	33.98	208	336	Average
5052	56.17	48.11	74	-17.83	34.04	8	33.98	208	336	Peak
5270	94.7	86.21			34.21	8.29	34.01	208	336	Average
5270	102.47	93.98			34.21	8.29	34.01	208	336	Peak
5422	43.39	34.62	54	-10.61	34.33	8.48	34.04	208	336	Average
5422	56.62	47.85	74	-17.38	34.33	8.48	34.04	208	336	Peak
ANTENNA POLARITY & TEST DISTANCE: VERTICAL AT 3 M										
FREQ. (MHz)	EMISSION LEVEL (dBuV/m)	READ LEVEL (dBuV)	LIMIT (dBuV/m)	MARGIN (dB)	ANTENNA FACTOR (dB/m)	CABLE LOSS (dB)	PREAMP FACTOR (dB)	ANTENNA HEIGHT (cm)	TABLE ANGLE (Degree)	REMARK
5042	42.79	34.73	54	-11.21	34.04	8	33.98	204	32	Average
5042	57.09	49.03	74	-16.91	34.04	8	33.98	204	32	Peak
5270	96.6	88.11			34.21	8.29	34.01	204	32	Average
5270	104.71	96.22			34.21	8.29	34.01	204	32	Peak
5390	43.33	34.65	54	-10.67	34.31	8.41	34.04	204	32	Average
5390	57.55	48.87	74	-16.45	34.31	8.41	34.04	204	32	Peak

REMARKS:

- Emission Level = Read Level + Antenna Factor + Cable Loss - Preamp Factor
Margin value = Emission level – Limit value
- 5270MHz: Fundamental frequency.



EUT TEST CONDITION		MEASUREMENT DETAIL	
CHANNEL	Channel 62	FREQUENCY RANGE	1GHz ~ 40GHz
INPUT POWER	120Vac, 60 Hz	DETECTOR FUNCTION	Peak (PK) Average (AV)
ENVIRONMENTAL CONDITIONS	25deg. C, 65%RH	TESTED BY	Charles Hsiao

ANTENNA POLARITY & TEST DISTANCE: HORIZONTAL AT 3 M										
FREQ. (MHz)	EMISSION LEVEL (dBuV/m)	READ LEVEL (dBuV)	LIMIT (dBuV/m)	MARGIN (dB)	ANTENNA FACTOR (dB/m)	CABLE LOSS (dB)	PREAMP FACTOR (dB)	ANTENNA HEIGHT (cm)	TABLE ANGLE (Degree)	REMARK
5042	42.59	34.53	54	-11.41	34.04	8	33.98	208	336	Average
5042	57.01	48.95	74	-16.99	34.04	8	33.98	208	336	Peak
5310	94.07	85.52			34.25	8.32	34.02	208	336	Average
5310	102.3	93.75			34.25	8.32	34.02	208	336	Peak
5432	44.32	35.53	54	-9.68	34.35	8.48	34.04	208	336	Average
5432	56.98	48.19	74	-17.02	34.35	8.48	34.04	208	336	Peak
ANTENNA POLARITY & TEST DISTANCE: VERTICAL AT 3 M										
FREQ. (MHz)	EMISSION LEVEL (dBuV/m)	READ LEVEL (dBuV)	LIMIT (dBuV/m)	MARGIN (dB)	ANTENNA FACTOR (dB/m)	CABLE LOSS (dB)	PREAMP FACTOR (dB)	ANTENNA HEIGHT (cm)	TABLE ANGLE (Degree)	REMARK
5030	42.7	34.64	54	-11.3	34.03	8	33.97	194	32	Average
5030	57.25	49.19	74	-16.75	34.03	8	33.97	194	32	Peak
5310	96.57	88.02			34.25	8.32	34.02	194	32	Average
5310	104.66	96.11			34.25	8.32	34.02	194	32	Peak
5350	43.66	35.03	54	-10.34	34.28	8.38	34.03	194	32	Average
5350	56.94	48.31	74	-17.06	34.28	8.38	34.03	194	32	Peak

REMARKS:

- Emission Level = Read Level + Antenna Factor + Cable Loss - Preamp Factor
Margin value = Emission level – Limit value
- 5310MHz: Fundamental frequency.



EUT TEST CONDITION		MEASUREMENT DETAIL	
CHANNEL	Channel 102	FREQUENCY RANGE	1GHz ~ 40GHz
INPUT POWER	120Vac, 60 Hz	DETECTOR FUNCTION	Peak (PK) Average (AV)
ENVIRONMENTAL CONDITIONS	25deg. C, 65%RH	TESTED BY	Charles Hsiao

ANTENNA POLARITY & TEST DISTANCE: HORIZONTAL AT 3 M										
FREQ. (MHz)	EMISSION LEVEL (dBuV/m)	READ LEVEL (dBuV)	LIMIT (dBuV/m)	MARGIN (dB)	ANTENNA FACTOR (dB/m)	CABLE LOSS (dB)	PREAMP FACTOR (dB)	ANTENNA HEIGHT (cm)	TABLE ANGLE (Degree)	REMARK
5434	43.42	34.63	54	-10.58	34.35	8.48	34.04	198	339	Average
5434	57.78	48.99	74	-16.22	34.35	8.48	34.04	198	339	Peak
5470	62.66	53.83	68.2	-5.54	34.37	8.51	34.05	198	339	Peak
5510	95.87	86.96			34.4	8.57	34.06	198	339	Average
5510	103.84	94.93			34.4	8.57	34.06	198	339	Peak
5725	54.3	45.14	68.2	-13.9	34.62	8.65	34.11	198	339	Peak
ANTENNA POLARITY & TEST DISTANCE: VERTICAL AT 3 M										
FREQ. (MHz)	EMISSION LEVEL (dBuV/m)	READ LEVEL (dBuV)	LIMIT (dBuV/m)	MARGIN (dB)	ANTENNA FACTOR (dB/m)	CABLE LOSS (dB)	PREAMP FACTOR (dB)	ANTENNA HEIGHT (cm)	TABLE ANGLE (Degree)	REMARK
5424	43.41	34.64	54	-10.59	34.33	8.48	34.04	219	30	Average
5424	57.1	48.33	74	-16.9	34.33	8.48	34.04	219	30	Peak
5470	61.69	52.86	68.2	-6.51	34.37	8.51	34.05	219	30	Peak
5510	97.27	88.36			34.4	8.57	34.06	219	30	Average
5510	105.42	96.51			34.4	8.57	34.06	219	30	Peak
5725	54.66	45.5	68.2	-13.54	34.62	8.65	34.11	219	30	Peak

REMARKS:

- Emission Level = Read Level + Antenna Factor + Cable Loss - Preamp Factor
Margin value = Emission level – Limit value
- 5510MHz: Fundamental frequency.
- 5470MHz & 5725MHz: Out of restricted band



A D T

EUT TEST CONDITION		MEASUREMENT DETAIL	
CHANNEL	Channel 110	FREQUENCY RANGE	1GHz ~ 40GHz
INPUT POWER	120Vac, 60 Hz	DETECTOR FUNCTION	Peak (PK) Average (AV)
ENVIRONMENTAL CONDITIONS	25deg. C, 65%RH	TESTED BY	Charles Hsiao

ANTENNA POLARITY & TEST DISTANCE: HORIZONTAL AT 3 M										
FREQ. (MHz)	EMISSION LEVEL (dBuV/m)	READ LEVEL (dBuV)	LIMIT (dBuV/m)	MARGIN (dB)	ANTENNA FACTOR (dB/m)	CABLE LOSS (dB)	PREAMP FACTOR (dB)	ANTENNA HEIGHT (cm)	TABLE ANGLE (Degree)	REMARK
5372	43.11	34.44	54	-10.89	34.29	8.41	34.03	170	339	Average
5372	56.62	47.95	74	-17.38	34.29	8.41	34.03	170	339	Peak
5470	55.04	46.21	68.2	-13.16	34.37	8.51	34.05	170	339	Peak
5550	95.54	86.57			34.45	8.59	34.07	170	339	Average
5550	103.48	94.51			34.45	8.59	34.07	170	339	Peak
5725	55.59	46.43	68.2	-12.61	34.62	8.65	34.11	170	339	Peak

ANTENNA POLARITY & TEST DISTANCE: VERTICAL AT 3 M										
FREQ. (MHz)	EMISSION LEVEL (dBuV/m)	READ LEVEL (dBuV)	LIMIT (dBuV/m)	MARGIN (dB)	ANTENNA FACTOR (dB/m)	CABLE LOSS (dB)	PREAMP FACTOR (dB)	ANTENNA HEIGHT (cm)	TABLE ANGLE (Degree)	REMARK
5382	43.52	34.84	54	-10.48	34.31	8.41	34.04	223	30	Average
5382	57.31	48.63	74	-16.69	34.31	8.41	34.04	223	30	Peak
5470	56.68	47.85	68.2	-11.52	34.37	8.51	34.05	223	30	Peak
5550	97.04	88.07			34.45	8.59	34.07	223	30	Average
5550	105.26	96.29			34.45	8.59	34.07	223	30	Peak
5725	57.73	48.57	68.2	-10.47	34.62	8.65	34.11	223	30	Peak

REMARKS:

1. Emission Level = Read Level + Antenna Factor + Cable Loss - Preamp Factor
Margin value = Emission level – Limit value
2. 5550MHz: Fundamental frequency.
3. 5470MHz & 5725MHz: Out of restricted band



A D T

EUT TEST CONDITION		MEASUREMENT DETAIL	
CHANNEL	Channel 134	FREQUENCY RANGE	1GHz ~ 40GHz
INPUT POWER	120Vac, 60 Hz	DETECTOR FUNCTION	Peak (PK) Average (AV)
ENVIRONMENTAL CONDITIONS	25deg. C, 65%RH	TESTED BY	Charles Hsiao

ANTENNA POLARITY & TEST DISTANCE: HORIZONTAL AT 3 M										
FREQ. (MHz)	EMISSION LEVEL (dBuV/m)	READ LEVEL (dBuV)	LIMIT (dBuV/m)	MARGIN (dB)	ANTENNA FACTOR (dB/m)	CABLE LOSS (dB)	PREAMP FACTOR (dB)	ANTENNA HEIGHT (cm)	TABLE ANGLE (Degree)	REMARK
5448	43.27	34.44	54	-10.73	34.36	8.51	34.04	147	339	Average
5448	57.26	48.43	74	-16.74	34.36	8.51	34.04	147	339	Peak
5470	57.22	48.39	68.2	-10.98	34.37	8.51	34.05	147	339	Peak
5670	95.01	85.91			34.57	8.63	34.1	147	339	Average
5670	103.17	94.07			34.57	8.63	34.1	147	339	Peak
5725	56.13	46.97	68.2	-12.07	34.62	8.65	34.11	147	339	Peak
ANTENNA POLARITY & TEST DISTANCE: VERTICAL AT 3 M										
FREQ. (MHz)	EMISSION LEVEL (dBuV/m)	READ LEVEL (dBuV)	LIMIT (dBuV/m)	MARGIN (dB)	ANTENNA FACTOR (dB/m)	CABLE LOSS (dB)	PREAMP FACTOR (dB)	ANTENNA HEIGHT (cm)	TABLE ANGLE (Degree)	REMARK
5378	42.9	34.22	54	-11.1	34.31	8.41	34.04	209	30	Average
5378	58.29	49.61	74	-15.71	34.31	8.41	34.04	209	30	Peak
5470	54.81	45.98	68.2	-13.39	34.37	8.51	34.05	209	30	Peak
5670	97.9	88.8			34.57	8.63	34.1	209	30	Average
5670	105.69	96.59			34.57	8.63	34.1	209	30	Peak
5725	55.54	46.38	68.2	-12.66	34.62	8.65	34.11	209	30	Peak

REMARKS:

- Emission Level = Read Level + Antenna Factor + Cable Loss - Preamp Factor
Margin value = Emission level – Limit value
- 5670MHz: Fundamental frequency.
- 5470MHz & 5725MHz: Out of restricted band



EUT TEST CONDITION		MEASUREMENT DETAIL	
CHANNEL	Channel 151	FREQUENCY RANGE	1GHz ~ 40GHz
INPUT POWER	120Vac, 60 Hz	DETECTOR FUNCTION	Peak (PK) Average (AV)
ENVIRONMENTAL CONDITIONS	25deg. C, 65%RH	TESTED BY	Charles Hsiao

ANTENNA POLARITY & TEST DISTANCE: HORIZONTAL AT 3 M										
FREQ. (MHz)	EMISSION LEVEL (dBuV/m)	READ LEVEL (dBuV)	LIMIT (dBuV/m)	MARGIN (dB)	ANTENNA FACTOR (dB/m)	CABLE LOSS (dB)	PREAMP FACTOR (dB)	ANTENNA HEIGHT (cm)	TABLE ANGLE (Degree)	REMARK
*5714	59.43	50.28	68.2	-8.77	34.61	8.65	34.11	166	339	Peak
*5722	60.3	51.14	78.2	-17.9	34.62	8.65	34.11	166	339	Peak
5755	91.9	82.69			34.66	8.66	34.11	166	339	Average
5755	100.1	90.89			34.66	8.66	34.11	166	339	Peak
*5854	58.69	49.37	78.2	-19.51	34.76	8.7	34.14	166	339	Peak
*5862	58.06	48.73	68.2	-10.14	34.76	8.71	34.14	166	339	Peak
ANTENNA POLARITY & TEST DISTANCE: VERTICAL AT 3 M										
FREQ. (MHz)	EMISSION LEVEL (dBuV/m)	READ LEVEL (dBuV)	LIMIT (dBuV/m)	MARGIN (dB)	ANTENNA FACTOR (dB/m)	CABLE LOSS (dB)	PREAMP FACTOR (dB)	ANTENNA HEIGHT (cm)	TABLE ANGLE (Degree)	REMARK
*5714	59.89	50.74	68.2	-8.31	34.61	8.65	34.11	208	25	Peak
*5724	64.45	55.29	78.2	-13.75	34.62	8.65	34.11	208	25	Peak
5755	94.46	85.25			34.66	8.66	34.11	208	25	Average
5755	102.31	93.1			34.66	8.66	34.11	208	25	Peak
*5852	58.33	49.03	78.2	-19.87	34.74	8.7	34.14	208	25	Peak
*5868	58.58	49.25	68.2	-9.62	34.76	8.71	34.14	208	25	Peak

REMARKS:

- Emission Level = Read Level + Antenna Factor + Cable Loss - Preamp Factor
Margin value = Emission level – Limit value
- 5755MHz: Fundamental frequency.
- *: Out of restricted band

EUT TEST CONDITION		MEASUREMENT DETAIL	
CHANNEL	Channel 159	FREQUENCY RANGE	1GHz ~ 40GHz
INPUT POWER	120Vac, 60 Hz	DETECTOR FUNCTION	Peak (PK) Average (AV)
ENVIRONMENTAL CONDITIONS	25deg. C, 65%RH	TESTED BY	Charles Hsiao

ANTENNA POLARITY & TEST DISTANCE: HORIZONTAL AT 3 M										
FREQ. (MHz)	EMISSION LEVEL (dBuV/m)	READ LEVEL (dBuV)	LIMIT (dBuV/m)	MARGIN (dB)	ANTENNA FACTOR (dB/m)	CABLE LOSS (dB)	PREAMP FACTOR (dB)	ANTENNA HEIGHT (cm)	TABLE ANGLE (Degree)	REMARK
*5710	58.17	49.02	68.2	-10.03	34.61	8.65	34.11	179	339	Peak
*5718	57.57	48.41	78.2	-20.63	34.62	8.65	34.11	179	339	Peak
5795	93.18	83.94			34.69	8.68	34.13	179	339	Average
5795	100.88	91.64			34.69	8.68	34.13	179	339	Peak
*5856	58.76	49.44	78.2	-19.44	34.76	8.7	34.14	179	339	Peak
*5864	58.33	49	68.2	-9.87	34.76	8.71	34.14	179	339	Peak
ANTENNA POLARITY & TEST DISTANCE: VERTICAL AT 3 M										
FREQ. (MHz)	EMISSION LEVEL (dBuV/m)	READ LEVEL (dBuV)	LIMIT (dBuV/m)	MARGIN (dB)	ANTENNA FACTOR (dB/m)	CABLE LOSS (dB)	PREAMP FACTOR (dB)	ANTENNA HEIGHT (cm)	TABLE ANGLE (Degree)	REMARK
*5712	56.78	47.63	68.2	-11.42	34.61	8.65	34.11	195	26	Peak
*5716	57.55	48.4	78.2	-20.65	34.61	8.65	34.11	195	26	Peak
5795	95.15	85.91			34.69	8.68	34.13	195	26	Average
5795	102.97	93.73			34.69	8.68	34.13	195	26	Peak
*5860	57.93	48.61	78.2	-20.27	34.76	8.7	34.14	195	26	Peak
*5870	57.78	48.45	68.2	-10.42	34.76	8.71	34.14	195	26	Peak

REMARKS:

- Emission Level = Read Level + Antenna Factor + Cable Loss - Preamp Factor
Margin value = Emission level – Limit value
- 5795MHz: Fundamental frequency.
- *: Out of restricted band

802.11ac (80MHz)

EUT TEST CONDITION		MEASUREMENT DETAIL	
CHANNEL	Channel 42	FREQUENCY RANGE	1GHz ~ 40GHz
INPUT POWER	120Vac, 60 Hz	DETECTOR FUNCTION	Peak (PK) Average (AV)
ENVIRONMENTAL CONDITIONS	25deg. C, 65%RH	TESTED BY	Charles Hsiao

ANTENNA POLARITY & TEST DISTANCE: HORIZONTAL AT 3 M

FREQ. (MHz)	EMISSION LEVEL (dBuV/m)	READ LEVEL (dBuV)	LIMIT (dBuV/m)	MARGIN (dB)	ANTENNA FACTOR (dB/m)	CABLE LOSS (dB)	PREAMP FACTOR (dB)	ANTENNA HEIGHT (cm)	TABLE ANGLE (Degree)	REMARK
5070	44.43	36.33	54	-9.57	34.05	8.03	33.98	194	339	Average
5070	56.91	48.81	74	-17.09	34.05	8.03	33.98	194	339	Peak
5210	91.77	83.41			34.17	8.19	34	194	339	Average
5210	99.34	90.98			34.17	8.19	34	194	339	Peak
5398	43.87	35.15	54	-10.13	34.32	8.44	34.04	194	339	Average
5398	57.69	48.97	74	-16.31	34.32	8.44	34.04	194	339	Peak

ANTENNA POLARITY & TEST DISTANCE: VERTICAL AT 3 M

FREQ. (MHz)	EMISSION LEVEL (dBuV/m)	READ LEVEL (dBuV)	LIMIT (dBuV/m)	MARGIN (dB)	ANTENNA FACTOR (dB/m)	CABLE LOSS (dB)	PREAMP FACTOR (dB)	ANTENNA HEIGHT (cm)	TABLE ANGLE (Degree)	REMARK
5134	44.86	36.61	54	-9.14	34.11	8.13	33.99	216	27	Average
5134	58	49.75	74	-16	34.11	8.13	33.99	216	27	Peak
5210	93.2	84.84			34.17	8.19	34	216	27	Average
5210	101.26	92.9			34.17	8.19	34	216	27	Peak
5396	43.87	35.15	54	-10.13	34.32	8.44	34.04	216	27	Average
5396	57.89	49.17	74	-16.11	34.32	8.44	34.04	216	27	Peak

REMARKS:

- Emission Level = Read Level + Antenna Factor + Cable Loss - Preamp Factor
Margin value = Emission level – Limit value
- 5210MHz: Fundamental frequency.



EUT TEST CONDITION		MEASUREMENT DETAIL	
CHANNEL	Channel 58	FREQUENCY RANGE	1GHz ~ 40GHz
INPUT POWER	120Vac, 60 Hz	DETECTOR FUNCTION	Peak (PK) Average (AV)
ENVIRONMENTAL CONDITIONS	25deg. C, 65%RH	TESTED BY	Charles Hsiao

ANTENNA POLARITY & TEST DISTANCE: HORIZONTAL AT 3 M										
FREQ. (MHz)	EMISSION LEVEL (dBuV/m)	READ LEVEL (dBuV)	LIMIT (dBuV/m)	MARGIN (dB)	ANTENNA FACTOR (dB/m)	CABLE LOSS (dB)	PREAMP FACTOR (dB)	ANTENNA HEIGHT (cm)	TABLE ANGLE (Degree)	REMARK
5098	44.1	35.94	54	-9.9	34.08	8.07	33.99	208	336	Average
5098	58.56	50.4	74	-15.44	34.08	8.07	33.99	208	336	Peak
5290	92.14	83.61			34.23	8.32	34.02	208	336	Average
5290	100.15	91.62			34.23	8.32	34.02	208	336	Peak
5430	44.72	35.93	54	-9.28	34.35	8.48	34.04	208	336	Average
5430	58.22	49.43	74	-15.78	34.35	8.48	34.04	208	336	Peak
ANTENNA POLARITY & TEST DISTANCE: VERTICAL AT 3 M										
FREQ. (MHz)	EMISSION LEVEL (dBuV/m)	READ LEVEL (dBuV)	LIMIT (dBuV/m)	MARGIN (dB)	ANTENNA FACTOR (dB/m)	CABLE LOSS (dB)	PREAMP FACTOR (dB)	ANTENNA HEIGHT (cm)	TABLE ANGLE (Degree)	REMARK
5070	44.41	36.31	54	-9.59	34.05	8.03	33.98	252	20	Average
5070	57.32	49.22	74	-16.68	34.05	8.03	33.98	252	20	Peak
5290	94.21	85.68			34.23	8.32	34.02	252	20	Average
5290	102.02	93.49			34.23	8.32	34.02	252	20	Peak
5378	44.25	35.57	54	-9.75	34.31	8.41	34.04	252	20	Average
5378	58	49.32	74	-16	34.31	8.41	34.04	252	20	Peak

REMARKS:

- Emission Level = Read Level + Antenna Factor + Cable Loss - Preamp Factor
Margin value = Emission level – Limit value
- 5290MHz: Fundamental frequency.



A D T

EUT TEST CONDITION		MEASUREMENT DETAIL	
CHANNEL	Channel 106	FREQUENCY RANGE	1GHz ~ 40GHz
INPUT POWER	120Vac, 60 Hz	DETECTOR FUNCTION	Peak (PK) Average (AV)
ENVIRONMENTAL CONDITIONS	25deg. C, 65%RH	TESTED BY	Charles Hsiao

ANTENNA POLARITY & TEST DISTANCE: HORIZONTAL AT 3 M										
FREQ. (MHz)	EMISSION LEVEL (dBuV/m)	READ LEVEL (dBuV)	LIMIT (dBuV/m)	MARGIN (dB)	ANTENNA FACTOR (dB/m)	CABLE LOSS (dB)	PREAMP FACTOR (dB)	ANTENNA HEIGHT (cm)	TABLE ANGLE (Degree)	REMARK
5424	45.01	36.24	54	-8.99	34.33	8.48	34.04	198	339	Average
5424	57.81	49.04	74	-16.19	34.33	8.48	34.04	198	339	Peak
5470	56.92	48.09	68.2	-11.28	34.37	8.51	34.05	198	339	Peak
5530	93.82	84.89			34.42	8.58	34.07	198	339	Average
5530	101.49	92.56			34.42	8.58	34.07	198	339	Peak
5725	56.51	47.35	68.2	-11.69	34.62	8.65	34.11	198	339	Peak
ANTENNA POLARITY & TEST DISTANCE: VERTICAL AT 3 M										
FREQ. (MHz)	EMISSION LEVEL (dBuV/m)	READ LEVEL (dBuV)	LIMIT (dBuV/m)	MARGIN (dB)	ANTENNA FACTOR (dB/m)	CABLE LOSS (dB)	PREAMP FACTOR (dB)	ANTENNA HEIGHT (cm)	TABLE ANGLE (Degree)	REMARK
5446	44.22	35.39	54	-9.78	34.36	8.51	34.04	218	22	Average
5446	58.71	49.88	74	-15.29	34.36	8.51	34.04	218	22	Peak
5470	56.99	48.16	68.2	-11.21	34.37	8.51	34.05	218	22	Peak
5530	95.24	86.31			34.42	8.58	34.07	218	22	Average
5530	103.46	94.53			34.42	8.58	34.07	218	22	Peak
5725	56.92	47.76	68.2	-11.28	34.62	8.65	34.11	218	22	Peak

REMARKS:

- Emission Level = Read Level + Antenna Factor + Cable Loss - Preamp Factor
Margin value = Emission level – Limit value
- 5530MHz: Fundamental frequency.
- 5470MHz & 5725MHz: Out of restricted band

EUT TEST CONDITION		MEASUREMENT DETAIL	
CHANNEL	Channel 122	FREQUENCY RANGE	1GHz ~ 40GHz
INPUT POWER	120Vac, 60 Hz	DETECTOR FUNCTION	Peak (PK) Average (AV)
ENVIRONMENTAL CONDITIONS	25deg. C, 65%RH	TESTED BY	Charles Hsiao

ANTENNA POLARITY & TEST DISTANCE: HORIZONTAL AT 3 M										
FREQ. (MHz)	EMISSION LEVEL (dBuV/m)	READ LEVEL (dBuV)	LIMIT (dBuV/m)	MARGIN (dB)	ANTENNA FACTOR (dB/m)	CABLE LOSS (dB)	PREAMP FACTOR (dB)	ANTENNA HEIGHT (cm)	TABLE ANGLE (Degree)	REMARK
5430	44.38	35.59	54	-9.62	34.35	8.48	34.04	170	339	Average
5430	57.29	48.5	74	-16.71	34.35	8.48	34.04	170	339	Peak
5470	55.55	46.72	68.2	-12.65	34.37	8.51	34.05	170	339	Peak
5610	93.65	84.62			34.5	8.61	34.08	170	339	Average
5610	101.73	92.7			34.5	8.61	34.08	170	339	Peak
5725	56.58	47.42	68.2	-11.62	34.62	8.65	34.11	170	339	Peak
ANTENNA POLARITY & TEST DISTANCE: VERTICAL AT 3 M										
FREQ. (MHz)	EMISSION LEVEL (dBuV/m)	READ LEVEL (dBuV)	LIMIT (dBuV/m)	MARGIN (dB)	ANTENNA FACTOR (dB/m)	CABLE LOSS (dB)	PREAMP FACTOR (dB)	ANTENNA HEIGHT (cm)	TABLE ANGLE (Degree)	REMARK
5358	44.19	35.56	54	-9.81	34.28	8.38	34.03	223	30	Average
5358	58.15	49.52	74	-15.85	34.28	8.38	34.03	223	30	Peak
5470	56.99	48.16	68.2	-11.21	34.37	8.51	34.05	223	30	Peak
5610	94.65	85.62			34.5	8.61	34.08	223	30	Average
5610	103.1	94.07			34.5	8.61	34.08	223	30	Peak
5725	58.23	49.07	68.2	-9.97	34.62	8.65	34.11	223	30	Peak

REMARKS:

- Emission Level = Read Level + Antenna Factor + Cable Loss - Preamp Factor
Margin value = Emission level – Limit value
- 5610MHz: Fundamental frequency.
- 5470MHz & 5725MHz: Out of restricted band



A D T

EUT TEST CONDITION		MEASUREMENT DETAIL	
CHANNEL	Channel 155	FREQUENCY RANGE	1GHz ~ 40GHz
INPUT POWER	120Vac, 60 Hz	DETECTOR FUNCTION	Peak (PK) Average (AV)
ENVIRONMENTAL CONDITIONS	25deg. C, 65%RH	TESTED BY	Charles Hsiao

ANTENNA POLARITY & TEST DISTANCE: HORIZONTAL AT 3 M										
FREQ. (MHz)	EMISSION LEVEL (dBuV/m)	READ LEVEL (dBuV)	LIMIT (dBuV/m)	MARGIN (dB)	ANTENNA FACTOR (dB/m)	CABLE LOSS (dB)	PREAMP FACTOR (dB)	ANTENNA HEIGHT (cm)	TABLE ANGLE (Degree)	REMARK
5430	44.38	35.59	54	-9.62	34.35	8.48	34.04	170	339	Average
5430	57.29	48.5	74	-16.71	34.35	8.48	34.04	170	339	Peak
5470	55.55	46.72	68.2	-12.65	34.37	8.51	34.05	170	339	Peak
5610	93.65	84.62			34.5	8.61	34.08	170	339	Average
5610	101.73	92.7			34.5	8.61	34.08	170	339	Peak
5725	56.58	47.42	68.2	-11.62	34.62	8.65	34.11	170	339	Peak

ANTENNA POLARITY & TEST DISTANCE: VERTICAL AT 3 M										
FREQ. (MHz)	EMISSION LEVEL (dBuV/m)	READ LEVEL (dBuV)	LIMIT (dBuV/m)	MARGIN (dB)	ANTENNA FACTOR (dB/m)	CABLE LOSS (dB)	PREAMP FACTOR (dB)	ANTENNA HEIGHT (cm)	TABLE ANGLE (Degree)	REMARK
5358	44.19	35.56	54	-9.81	34.28	8.38	34.03	223	30	Average
5358	58.15	49.52	74	-15.85	34.28	8.38	34.03	223	30	Peak
5470	56.99	48.16	68.2	-11.21	34.37	8.51	34.05	223	30	Peak
5610	94.65	85.62			34.5	8.61	34.08	223	30	Average
5610	103.1	94.07			34.5	8.61	34.08	223	30	Peak
5725	58.23	49.07	68.2	-9.97	34.62	8.65	34.11	223	30	Peak

REMARKS:

1. Emission Level = Read Level + Antenna Factor + Cable Loss - Preamp Factor
Margin value = Emission level – Limit value
2. 5775MHz: Fundamental frequency.
3. *: Out of restricted band

BELOW 1GHz WORST-CASE DATA:
802.11ac (80MHz)

EUT TEST CONDITION		MEASUREMENT DETAIL	
CHANNEL	Channel 42	FREQUENCY RANGE	30MHz ~ 1GHz
INPUT POWER	120Vac, 60 Hz	DETECTOR FUNCTION	Peak (PK) Quasi-peak (QP)
ENVIRONMENTAL CONDITIONS	25deg. C, 65%RH	TESTED BY	Charles Hsiao

ANTENNA POLARITY & TEST DISTANCE: HORIZONTAL AT 3 M										
FREQ. (MHz)	EMISSION LEVEL (dBuV/m)	READ LEVEL (dBuV)	LIMIT (dBuV/m)	MARGIN (dB)	ANTENNA FACTOR (dB/m)	CABLE LOSS (dB)	PREAMP FACTOR (dB)	ANTENNA HEIGHT (cm)	TABLE ANGLE (Degree)	REMARK
100.47	26.81	48.09	43.5	-16.69	9.7	1.28	32.26	139	231	Peak
187.95	29.63	49.87	43.5	-13.87	10.4	1.61	32.25	114	128	Peak
256.8	17.64	34.59	46	-28.36	13.21	1.94	32.1	108	213	Peak
529.6	20.68	29.53	46	-25.32	20.61	2.7	32.16	175	121	Peak
806.8	25.68	30	46	-20.32	24.38	3.32	32.02	138	237	Peak
924.4	27.78	29.35	46	-18.22	26.2	3.53	31.3	108	213	Peak
ANTENNA POLARITY & TEST DISTANCE: VERTICAL AT 3 M										
FREQ. (MHz)	EMISSION LEVEL (dBuV/m)	READ LEVEL (dBuV)	LIMIT (dBuV/m)	MARGIN (dB)	ANTENNA FACTOR (dB/m)	CABLE LOSS (dB)	PREAMP FACTOR (dB)	ANTENNA HEIGHT (cm)	TABLE ANGLE (Degree)	REMARK
48.09	30.17	53.09	40	-9.83	8.4	0.9	32.22	124	121	Peak
152.04	21.3	41.77	43.5	-22.2	10.28	1.52	32.27	200	127	Peak
196.86	24.04	43.98	43.5	-19.46	10.73	1.61	32.28	128	320	Peak
449.1	18.63	30.29	46	-27.37	18	2.49	32.15	108	306	Peak
680.1	23.77	29.52	46	-22.23	23.31	3.05	32.11	120	132	Peak
927.2	27.87	29.33	46	-18.13	26.2	3.62	31.28	108	314	Peak

REMARKS: Emission Level = Read Level + Antenna Factor + Cable Loss - Preamp Factor
Margin value = Emission level – Limit value



A D T

802.11a

EUT TEST CONDITION		MEASUREMENT DETAIL	
CHANNEL	Channel 60	FREQUENCY RANGE	30MHz ~ 1GHz
INPUT POWER	120Vac, 60 Hz	DETECTOR FUNCTION	Peak (PK) Quasi-peak (QP)
ENVIRONMENTAL CONDITIONS	25deg. C, 65%RH	TESTED BY	Charles Hsiao

ANTENNA POLARITY & TEST DISTANCE: HORIZONTAL AT 3 M

FREQ. (MHz)	EMISSION LEVEL (dBuV/m)	READ LEVEL (dBuV)	LIMIT (dBuV/m)	MARGIN (dB)	ANTENNA FACTOR (dB/m)	CABLE LOSS (dB)	PREAMP FACTOR (dB)	ANTENNA HEIGHT (cm)	TABLE ANGLE (Degree)	REMARK
99.39	26.87	48.23	43.5	-16.63	9.62	1.28	32.26	139	301	Peak
191.46	30.63	50.82	43.5	-12.87	10.46	1.61	32.26	175	128	Peak
256.26	17.46	34.46	46	-28.54	13.16	1.94	32.1	142	281	Peak
449.1	19.13	30.79	46	-26.87	18	2.49	32.15	108	127	Peak
716.5	24.66	30.39	46	-21.34	23.27	3.11	32.11	139	232	Peak
917.4	28	29.86	46	-18	25.96	3.53	31.35	107	127	Peak

ANTENNA POLARITY & TEST DISTANCE: VERTICAL AT 3 M

FREQ. (MHz)	EMISSION LEVEL (dBuV/m)	READ LEVEL (dBuV)	LIMIT (dBuV/m)	MARGIN (dB)	ANTENNA FACTOR (dB/m)	CABLE LOSS (dB)	PREAMP FACTOR (dB)	ANTENNA HEIGHT (cm)	TABLE ANGLE (Degree)	REMARK
47.55	30.33	53.08	40	-9.67	8.57	0.9	32.22	135	237	Peak
101.01	21.38	42.68	43.5	-22.12	9.68	1.28	32.26	184	128	Peak
197.94	23.68	43.57	43.5	-19.82	10.79	1.61	32.29	108	328	Peak
476.4	20.93	31.59	46	-25.07	18.9	2.56	32.12	130	120	Peak
798.4	27.39	31.71	46	-18.61	24.42	3.32	32.06	128	314	Peak
910.4	27.26	29.65	46	-18.74	25.48	3.53	31.4	139	128	Peak

REMARKS: Emission Level = Read Level + Antenna Factor + Cable Loss - Preamp Factor

Margin value = Emission level – Limit value



A D T

802.11n (40MHz)

EUT TEST CONDITION		MEASUREMENT DETAIL	
CHANNEL	Channel 102	FREQUENCY RANGE	30MHz ~ 1GHz
INPUT POWER	120Vac, 60 Hz	DETECTOR FUNCTION	Peak (PK) Quasi-peak (QP)
ENVIRONMENTAL CONDITIONS	25deg. C, 65%RH	TESTED BY	Charles Hsiao

ANTENNA POLARITY & TEST DISTANCE: HORIZONTAL AT 3 M

FREQ. (MHz)	EMISSION LEVEL (dBuV/m)	READ LEVEL (dBuV)	LIMIT (dBuV/m)	MARGIN (dB)	ANTENNA FACTOR (dB/m)	CABLE LOSS (dB)	PREAMP FACTOR (dB)	ANTENNA HEIGHT (cm)	TABLE ANGLE (Degree)	REMARK
100.47	26.54	47.82	43.5	-16.96	9.7	1.28	32.26	175	120	Peak
194.97	30.68	50.73	43.5	-12.82	10.62	1.61	32.28	139	238	Peak
262.47	18.37	35.17	46	-27.63	13.37	1.94	32.11	108	320	Peak
463.1	18.57	29.69	46	-27.43	18.45	2.56	32.13	139	208	Peak
731.9	25.59	31.19	46	-20.41	23.37	3.16	32.13	107	219	Peak
869.1	26.36	29.99	46	-19.64	24.6	3.44	31.67	195	212	Peak

ANTENNA POLARITY & TEST DISTANCE: VERTICAL AT 3 M

FREQ. (MHz)	EMISSION LEVEL (dBuV/m)	READ LEVEL (dBuV)	LIMIT (dBuV/m)	MARGIN (dB)	ANTENNA FACTOR (dB/m)	CABLE LOSS (dB)	PREAMP FACTOR (dB)	ANTENNA HEIGHT (cm)	TABLE ANGLE (Degree)	REMARK
48.36	30.26	53.27	40	-9.74	8.31	0.9	32.22	178	128	Peak
100.74	21.05	42.35	43.5	-22.45	9.68	1.28	32.26	145	127	Peak
159.6	19.79	39.8	43.5	-23.71	10.74	1.52	32.27	109	238	Peak
449.1	19.7	31.36	46	-26.3	18	2.49	32.15	164	237	Peak
673.1	24.35	30.02	46	-21.65	23.4	3.05	32.12	121	108	Peak
925.1	28.09	29.65	46	-17.91	26.2	3.53	31.29	186	132	Peak

REMARKS: Emission Level = Read Level + Antenna Factor + Cable Loss - Preamp Factor

Margin value = Emission level – Limit value

9kHz ~ 30MHz DATA:

The amplitude of spurious emissions attenuated more than 20dB below the permissible value is not required to be report.

30MHz ~ 1GHz WORST-CASE DATA:
802.11n (40MHz)

EUT TEST CONDITION		MEASUREMENT DETAIL	
CHANNEL	Channel 151	FREQUENCY RANGE	30MHz ~ 1GHz
INPUT POWER	120Vac, 60 Hz	DETECTOR FUNCTION	Peak (PK) Quasi-peak (QP)
ENVIRONMENTAL CONDITIONS	25deg. C, 65%RH	TESTED BY	Charles Hsiao

ANTENNA POLARITY & TEST DISTANCE: HORIZONTAL AT 3 M

FREQ. (MHz)	EMISSION LEVEL (dBuV/m)	READ LEVEL (dBuV)	LIMIT (dBuV/m)	MARGIN (dB)	ANTENNA FACTOR (dB/m)	CABLE LOSS (dB)	PREAMP FACTOR (dB)	ANTENNA HEIGHT (cm)	TABLE ANGLE (Degree)	REMARK
99.66	26.42	47.74	43.5	-17.08	9.66	1.28	32.26	114	128	Peak
190.92	30.04	50.29	43.5	-13.46	10.4	1.61	32.26	139	238	Peak
262.2	18.57	35.37	46	-27.43	13.37	1.94	32.11	175	281	Peak
461.7	18.67	29.79	46	-27.33	18.45	2.56	32.13	100	128	Peak
689.2	24.28	30.1	46	-21.72	23.23	3.05	32.1	176	218	Peak
875.4	26.47	29.81	46	-19.53	24.8	3.49	31.63	125	128	Peak

ANTENNA POLARITY & TEST DISTANCE: VERTICAL AT 3 M

FREQ. (MHz)	EMISSION LEVEL (dBuV/m)	READ LEVEL (dBuV)	LIMIT (dBuV/m)	MARGIN (dB)	ANTENNA FACTOR (dB/m)	CABLE LOSS (dB)	PREAMP FACTOR (dB)	ANTENNA HEIGHT (cm)	TABLE ANGLE (Degree)	REMARK
47.01	30.27	52.85	40	-9.73	8.74	0.9	32.22	145	125	Peak
125.58	13.91	35.8	43.5	-29.59	8.97	1.38	32.24	128	230	Peak
238.71	19.76	37.57	46	-26.24	12.48	1.85	32.14	108	345	Peak
472.9	20.17	30.92	46	-25.83	18.81	2.56	32.12	139	345	Peak
656.3	23.07	29.9	46	-22.93	22.32	2.99	32.14	175	247	Peak
910.4	27.28	29.67	46	-18.72	25.48	3.53	31.4	145	179	Peak

REMARKS: Emission Level = Read Level + Antenna Factor + Cable Loss - Preamp Factor

Margin value = Emission level – Limit value

4.2 Conducted Emission Measurement

4.2.1 Limits of Conducted Emission Measurement

Frequency (MHz)	Conducted Limit (dBuV)	
	Quasi-peak	Average
0.15 - 0.5	66 - 56	56 - 46
0.50 - 5.0	56	46
5.0 - 30.0	60	50

Note: 1. The lower limit shall apply at the transition frequencies.

2. The limit decreases in line with the logarithm of the frequency in the range of 0.15 to 0.50MHz.

4.2.2 Test Instruments

Description & Manufacturer	Model No.	Serial No.	Date Of Calibration	Due Date Of Calibration
Test Receiver ROHDE & SCHWARZ	ESCI	100613	Nov. 11, 2014	Nov. 10, 2015
RF signal cable (with 10dB PAD) Woken	5D-FB	Cable-cond1-01	Dec. 26, 2014	Dec. 25, 2015
LISN ROHDE & SCHWARZ (EUT)	ESH3-Z5	835239/001	Feb. 26, 2015	Feb. 25, 2016
LISN ROHDE & SCHWARZ (Peripheral)	ESH3-Z5	100311	Jul. 24, 2015	Jul. 23, 2016
Software ADT	BV ADT_Cond_ V7.3.7.3	NA	NA	NA

- Note:**
1. The calibration interval of the above test instruments is 12 months and the calibrations are traceable to NML/ROC and NIST/USA.
 2. The test was performed in HwaYa Shielded Room 1.
 3. The VCCI Site Registration No. is C-2040.

4.2.3 Test Procedures

- a. The EUT was placed 0.4 meters from the conducting wall of the shielded room with EUT being connected to the power mains through a line impedance stabilization network (LISN). Other support units were connected to the power mains through another LISN. The two LISNs provide 50 ohm/ 50uH of coupling impedance for the measuring instrument.
- b. Both lines of the power mains connected to the EUT were checked for maximum conducted interference.
- c. The frequency range from 150kHz to 30MHz was searched. Emission levels under (Limit - 20dB) was not recorded.

NOTE: All modes of operation were investigated and the worst-case emissions are reported.

4.2.4 Deviation from Test Standard

No deviation.

4.2.5 Test Setup

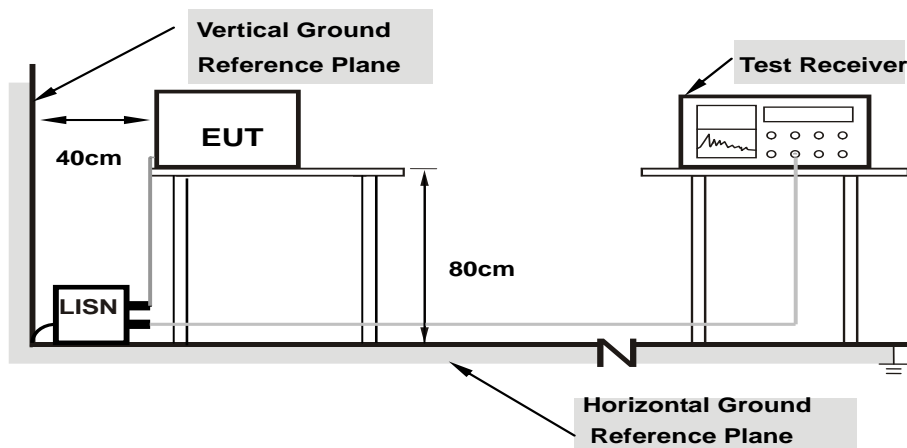

- Note:**
1. Support units were connected to second LISN.
 2. Both of LISNs (AMN) are 80 cm from EUT and at least 80 from other units and other metal planes

For the actual test configuration, please refer to the attached file (Test Setup Photo).

4.2.6 EUT Operating Conditions

Same as 4.1.6.

4.2.7 Test Results

Frequency Range	150kHz ~ 30MHz	Detector Function & Resolution Bandwidth	Quasi-Peak (QP) / Average (AV)
Input Power	120Vac, 60Hz	Environmental Conditions	25°C, 65%RH
Tested by	Toby Tian	Test Date	2015/8/25

Phase Of Power : Line (L)										
No	Frequency (MHz)	Correction Factor (dB)	Reading Value (dBuV)		Emission Level (dBuV)		Limit (dBuV)		Margin (dB)	
			Q.P.	AV.	Q.P.	AV.	Q.P.	AV.	Q.P.	AV.
1	0.15000	0.05	39.76	30.54	39.81	30.59	66.00	56.00	-26.19	-25.41
2	0.34159	0.06	37.68	26.56	37.74	26.62	59.16	49.16	-21.42	-22.54
3	0.55241	0.07	42.86	30.73	42.93	30.80	56.00	46.00	-13.07	-15.20
4	0.91245	0.08	40.80	29.59	40.88	29.67	56.00	46.00	-15.12	-16.33
5	2.55074	0.14	39.09	30.12	39.23	30.26	56.00	46.00	-16.77	-15.74
6	3.49696	0.17	39.89	30.77	40.06	30.94	56.00	46.00	-15.94	-15.06

Remarks:

1. Q.P. and AV. are abbreviations of quasi-peak and average individually.
2. The emission levels of other frequencies were very low against the limit.
3. Margin value = Emission level – Limit value
4. Correction factor = Insertion loss + Cable loss
5. Emission Level = Correction Factor + Reading Value

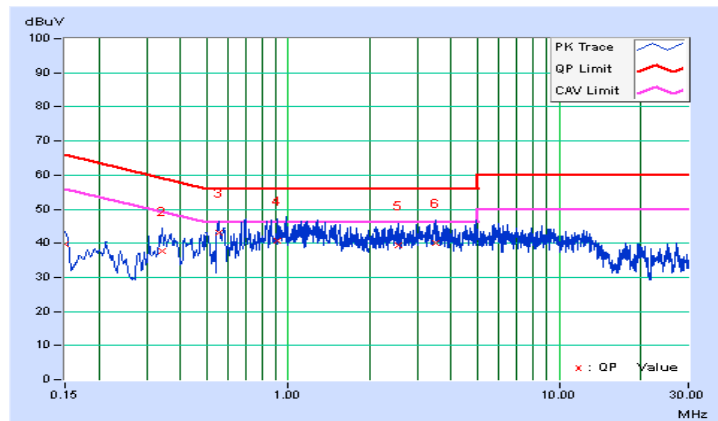

Frequency Range	150kHz ~ 30MHz	Detector Function & Resolution Bandwidth	Quasi-Peak (QP) / Average (AV)
Input Power	120Vac, 60Hz	Environmental Conditions	25°C, 65%RH
Tested by	Toby Tian	Test Date	2015/8/25

Phase Of Power : Neutral (N)										
No	Frequency (MHz)	Correction Factor (dB)	Reading Value (dBuV)		Emission Level (dBuV)		Limit (dBuV)		Margin (dB)	
			Q.P.	AV.	Q.P.	AV.	Q.P.	AV.	Q.P.	AV.
1	0.15760	0.05	35.20	23.84	35.25	23.89	65.59	55.59	-30.34	-31.70
2	0.45498	0.06	37.87	26.20	37.93	26.26	56.78	46.78	-18.85	-20.52
3	0.54882	0.06	37.21	24.59	37.27	24.65	56.00	46.00	-18.73	-21.35
4	0.93200	0.08	37.92	29.26	38.00	29.34	56.00	46.00	-18.00	-16.66
5	1.56542	0.10	36.24	27.51	36.34	27.61	56.00	46.00	-19.66	-18.39
6	3.05513	0.15	33.50	25.84	33.65	25.99	56.00	46.00	-22.35	-20.01

Remarks:

1. Q.P. and AV. are abbreviations of quasi-peak and average individually.
2. The emission levels of other frequencies were very low against the limit.
3. Margin value = Emission level – Limit value
4. Correction factor = Insertion loss + Cable loss
5. Emission Level = Correction Factor + Reading Value

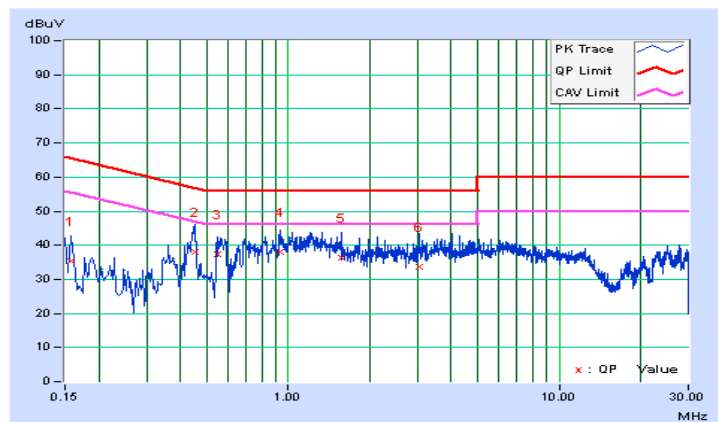

4.3 Transmit Power Measurement

4.3.1 Limits of Transmit Power Measurement

Operation Band	EUT Category		LIMIT
U-NII-1		Outdoor Access Point	1 Watt (30 dBm) (Max. e.i.r.p \leq 125mW(21 dBm) at any elevation angle above 30 degrees as measured from the horizon)
		Fixed point-to-point Access Point	1 Watt (30 dBm)
		Indoor Access Point	1 Watt (30 dBm)
	√	Mobile and Portable client device	250mW (24 dBm)
U-NII-2A		√	250mW (24 dBm) or 11 dBm+10 log B*
U-NII-2C		√	250mW (24 dBm) or 11 dBm+10 log B*
U-NII-3		√	1 Watt (30 dBm)

*B is the 26 dB emission bandwidth in megahertz

Per KDB 662911 Method of conducted output power measurement on IEEE 802.11 devices,

Array Gain = 0 dB (i.e., no array gain) for $N_{ANT} \leq 4$;

Array Gain = 0 dB (i.e., no array gain) for channel widths ≥ 40 MHz for any N_{ANT} ;

Array Gain = $5 \log(N_{ANT}/N_{SS})$ dB or 3 dB, whichever is less for 20-MHz channel widths with $N_{ANT} \geq 5$.

For power measurements on all other devices: Array Gain = $10 \log(N_{ANT}/N_{SS})$ dB.

4.3.2 Test Setup

FOR POWER OUTPUT MEASUREMENT

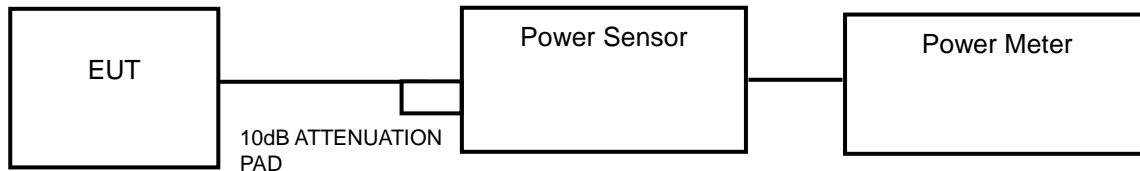

or

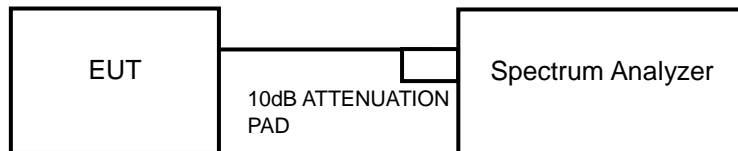

FOR 26dB BANDWIDTH

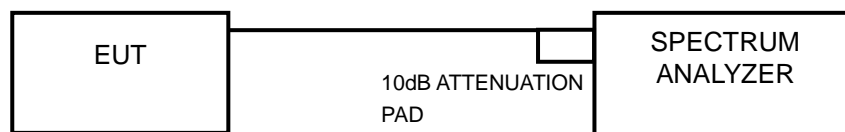

4.3.3 Test Instruments

Refer to section 4.1.2 to get information of above instrument.

4.3.4 Test Procedure

FOR AVERAGE POWER MEASUREMENT

<802.11a, 802.11n (20MHz), 802.11n (40MHz)>

Method PM is used to perform output power measurement, trigger and gating function of wide band power meter is enabled to measure max output power of TX on burst. Duty factor is not added to measured value.

<802.11ac (80MHz)>

Method SA-1 is used to perform output power measurement, trigger and gating function of spectrum analyzer is enabled to measure max output power of TX on burst. Duty factor is not added to measured value.

FOR 26dB BANDWIDTH

- 1) Set RBW = approximately 1% of the emission bandwidth.
- 2) Set the VBW > RBW.
- 3) Detector = Peak.
- 4) Trace mode = max hold.
- 5) Measure the maximum width of the emission that is 26 dB down from the peak of the emission. Compare this with the RBW setting of the analyzer. Readjust RBW and repeat measurement as needed until the RBW/EBW ratio is approximately 1%.

4.3.5 Deviation from Test Standard

No deviation.

4.3.6 EUT Operating Conditions

The software provided by client to enable the EUT under transmission condition continuously at lowest, middle and highest channel frequencies individually.

4.3.7 Test Result

POWER OUTPUT:

802.11a

Channel	Frequency (MHz)	Maximum Conducted Power (mW)	Maximum Conducted Power (dBm)	Power Limit (dBm)	Pass / Fail
36	5180	19.41	12.88	24	Pass
44	5220	19.63	12.93	24	Pass
48	5240	19.50	12.90	24	Pass
52	5260	19.68	12.94	24	Pass
60	5300	19.14	12.82	24	Pass
64	5320	19.23	12.84	24	Pass
100	5500	19.63	12.93	24	Pass
116	5580	18.97	12.78	24	Pass
140	5700	19.91	12.99	24	Pass
149	5745	19.50	12.9	30	Pass
157	5785	20.23	13.06	30	Pass
165	5825	19.59	12.92	30	Pass

NOTE:

For U-NII-2A, U-NII-2C Band:

1. $11\text{dBm} + 10\log(22.79) = 24.58\text{ dBm} > 24\text{dBm}$.
2. $11\text{dBm} + 10\log(22.23) = 24.47\text{ dBm} > 24\text{dBm}$.
3. $11\text{dBm} + 10\log(22.73) = 24.57\text{ dBm} > 24\text{dBm}$.
4. $11\text{dBm} + 10\log(22.67) = 24.55\text{ dBm} > 24\text{dBm}$.
5. $11\text{dBm} + 10\log(22.34) = 24.49\text{ dBm} > 24\text{dBm}$.
6. $11\text{dBm} + 10\log(22.89) = 24.60\text{ dBm} > 24\text{dBm}$.

802.11n (20MHz)

Channel	Frequency (MHz)	Maximum Conducted Power (mW)	Maximum Conducted Power (dBm)	Power Limit (dBm)	Pass / Fail
36	5180	15.17	11.81	24	Pass
44	5220	15.67	11.95	24	Pass
48	5240	15.52	11.91	24	Pass
52	5260	15.74	11.97	24	Pass
60	5300	15.81	11.99	24	Pass
64	5320	15.45	11.89	24	Pass
100	5500	15.70	11.96	24	Pass
116	5580	15.78	11.98	24	Pass
140	5700	15.24	11.83	24	Pass
149	5745	16.03	12.05	30	Pass
157	5785	16.18	12.09	30	Pass
165	5825	15.78	11.98	30	Pass

NOTE:
For U-NII-2A, U-NII-2C Band:

1. $11\text{dBm} + 10\log(22.82) = 24.58\text{ dBm} > 24\text{dBm}$.
2. $11\text{dBm} + 10\log(23.06) = 24.63\text{ dBm} > 24\text{dBm}$.
3. $11\text{dBm} + 10\log(22.87) = 24.59\text{ dBm} > 24\text{dBm}$.
4. $11\text{dBm} + 10\log(22.52) = 24.53\text{ dBm} > 24\text{dBm}$.
5. $11\text{dBm} + 10\log(22.82) = 24.58\text{ dBm} > 24\text{dBm}$.
6. $11\text{dBm} + 10\log(22.66) = 24.55\text{ dBm} > 24\text{dBm}$.

802.11n (40MHz)

Channel	Frequency (MHz)	Maximum Conducted Power (mW)	Maximum Conducted Power (dBm)	Power Limit (dBm)	Pass / Fail
38	5190	15.14	11.80	24	Pass
46	5230	15.24	11.83	24	Pass
54	5270	15.03	11.77	24	Pass
62	5310	15.10	11.79	24	Pass
102	5510	15.35	11.86	24	Pass
110	5550	15.00	11.76	24	Pass
134	5670	15.96	12.03	24	Pass
151	5755	15.38	11.87	30	Pass
159	5795	15.67	11.95	30	Pass

NOTE:
For U-NII-2A, U-NII-2C Band:

1. $11\text{dBm} + 10\log(45.51) = 27.58\text{ dBm} > 24\text{dBm}$.
2. $11\text{dBm} + 10\log(46.70) = 27.69\text{ dBm} > 24\text{dBm}$.
3. $11\text{dBm} + 10\log(45.73) = 27.60\text{ dBm} > 24\text{dBm}$.
4. $11\text{dBm} + 10\log(45.95) = 27.62\text{ dBm} > 24\text{dBm}$.
5. $11\text{dBm} + 10\log(45.16) = 27.55\text{ dBm} > 24\text{dBm}$.

802.11ac (80MHz)

Channel	Frequency (MHz)	Maximum Conducted Power (mW)	Maximum Conducted Power (dBm)	Power Limit (dBm)	Pass / Fail
42	5210	9.46	9.76	24	Pass
58	5290	9.71	9.87	24	Pass
106	5530	9.98	9.99	24	Pass
122	5610	9.64	9.84	24	Pass
155	5775	10.14	10.06	30	Pass

NOTE:
For U-NII-2A, U-NII-2C Band:

1. $11\text{dBm} + 10\log(85.57) = 30.32\text{ dBm} > 24\text{dBm}$.
2. $11\text{dBm} + 10\log(84.98) = 30.29\text{ dBm} > 24\text{dBm}$.
3. $11\text{dBm} + 10\log(85.30) = 30.31\text{ dBm} > 24\text{dBm}$.

26dB BANDWIDTH:
802.11a

Channel	Frequency (MHz)	26dBc Bandwidth (MHz)	Pass / Fail
36	5180	22.46	Pass
44	5220	22.87	Pass
48	5240	22.74	Pass
52	5260	22.79	Pass
60	5300	22.23	Pass
64	5320	22.73	Pass
100	5500	22.67	Pass
116	5580	22.34	Pass
140	5700	22.89	Pass

802.11n (20MHz)

Channel	Frequency (MHz)	26dBc Bandwidth (MHz)	Pass / Fail
36	5180	22.90	Pass
44	5220	23.14	Pass
48	5240	22.94	Pass
52	5260	22.82	Pass
60	5300	23.06	Pass
64	5320	22.87	Pass
100	5500	22.52	Pass
116	5580	22.82	Pass
140	5700	22.66	Pass

802.11n (40MHz)

Channel	Frequency (MHz)	26dBc Bandwidth (MHz)	Pass / Fail
38	5190	46.11	Pass
46	5230	45.64	Pass
54	5270	45.51	Pass
62	5310	46.70	Pass
102	5510	45.73	Pass
110	5550	45.95	Pass
134	5670	45.16	Pass

802.11ac (80MHz)

Channel	Frequency (MHz)	26dBc Bandwidth (MHz)	Pass / Fail
42	5210	85.71	Pass
58	5290	85.57	Pass
106	5530	84.98	Pass
122	5610	85.30	Pass

Spectrum Plot of Worst Value

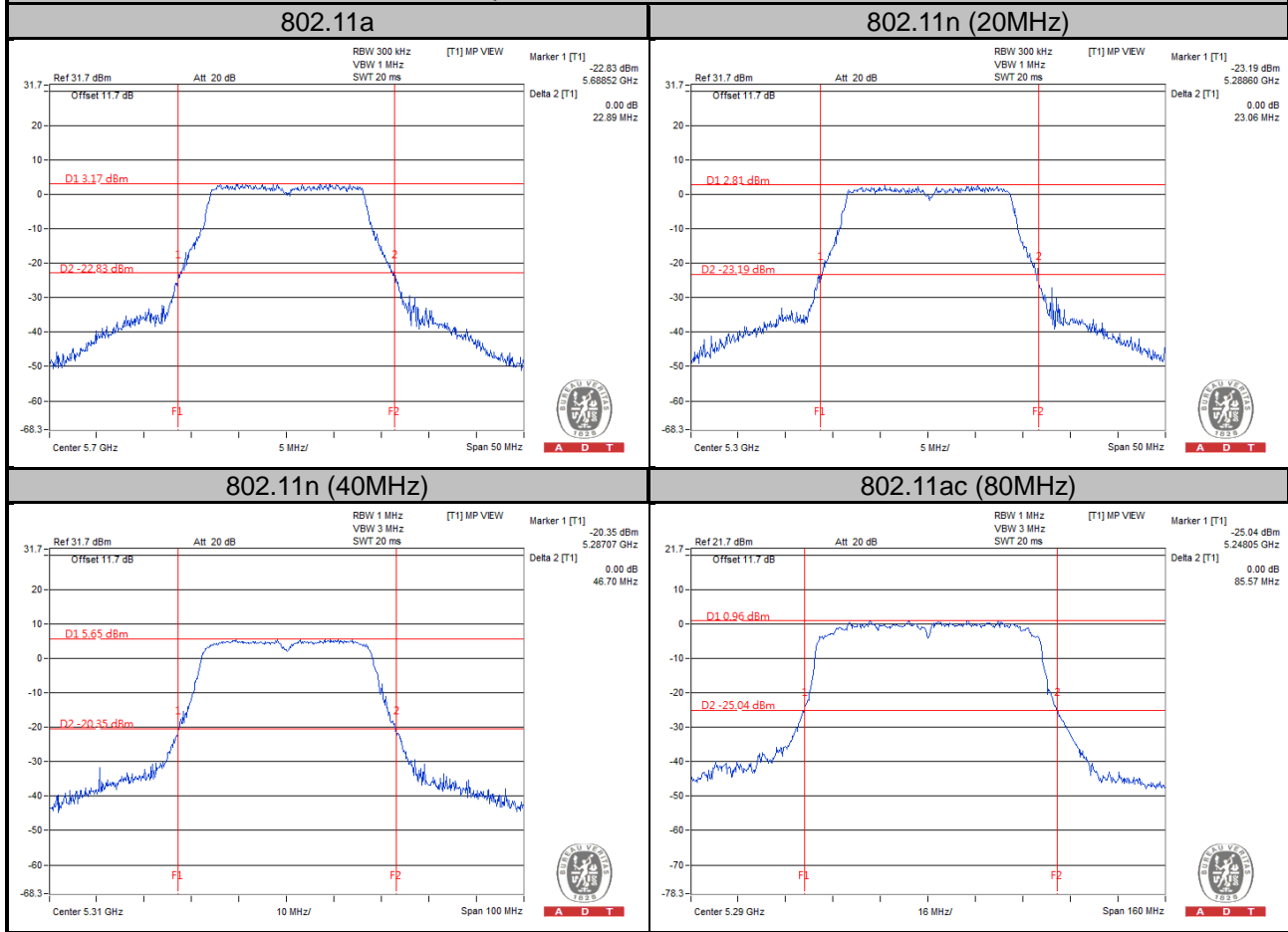

4.4 Peak Power Spectral Density Measurement

4.4.1 Limits of Peak Power Spectral Density Measurement

Operation Band	EUT Category		Limit
U-NII-1		Outdoor Access Point	17dBm/ MHz
		Fixed point-to-point Access Point	
		Indoor Access Point	
	√	Mobile and Portable client device	11dBm/ MHz
U-NII-2A	√		11dBm/ MHz
U-NII-2C	√		11dBm/ MHz
U-NII-3	√		30dBm/ 500MHz

4.4.2 Test Setup

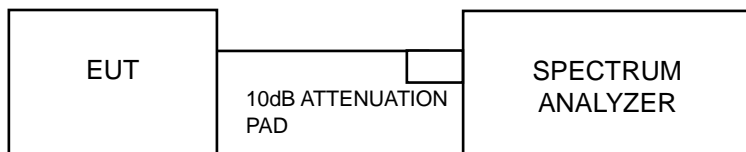

4.4.3 Test Instruments

Refer to section 4.1.3 to get information of above instrument.

4.4.4 Test Procedures

For U-NII-1, U-NII-2A, U-NII-2C band:

Using method SA-2

1. Set span to encompass the entire emission bandwidth (EBW) of the signal.
2. Set RBW = 1 MHz, Set VBW \geq 3 MHz, Detector = RMS
3. Sweep time = auto, trigger set to "free run".
4. Trace average at least 100 traces in power averaging mode.
5. Record the max value and add 10 log (1/duty cycle)

※For U-NII-3:

1. Set span to encompass the entire emission bandwidth (EBW) of the signal.
2. Set RBW = 300 kHz, Set VBW \geq 1 MHz, Detector = RMS
3. Use the peak marker function to determine the maximum power level in any 300 kHz band segment within the fundamental EBW.
4. Scale the observed power level to an equivalent value in 500 kHz by adjusting (reducing) the measured power by a bandwidth correction factor (BWCF) where $BWCF = 10\log(500\text{ kHz}/300\text{ kHz})$
5. Sweep time = auto, trigger set to "free run".
6. Trace average at least 100 traces in power averaging mode.
7. Record the max value and add 10 log (1/duty cycle)

4.4.5 Deviation from Test Standard

No deviation.

4.4.6 EUT Operating Conditions

Same as Item 4.3.6.

4.4.7 Test Results

802.11a

Channel	Frequency (MHz)	PSD w/o Duty Factor (dBm)	Duty Factor	PSD with Duty Factor (dBm)	Maximum Limit (dBm)	Pass / Fail
36	5180	-0.94	0.80	-0.14	11	Pass
44	5220	-0.81	0.80	-0.01	11	Pass
48	5240	-0.56	0.80	0.24	11	Pass
52	5260	-0.25	0.80	0.55	11	Pass
60	5300	-0.22	0.80	0.58	11	Pass
64	5320	0.40	0.80	1.20	11	Pass
100	5500	0.67	0.80	1.47	11	Pass
116	5580	0.14	0.80	0.94	11	Pass
140	5700	-0.31	0.80	0.49	11	Pass

NOTE: Refer to section 3.3 for duty cycle spectrum plot.

802.11n (20MHz)

Channel	Frequency (MHz)	PSD w/o Duty Factor (dBm)	Duty Factor	PSD with Duty Factor (dBm)	Maximum Limit (dBm)	Pass / Fail
36	5180	-2.19	0.85	-1.34	11	Pass
44	5220	-1.91	0.85	-1.06	11	Pass
48	5240	-1.82	0.85	-0.97	11	Pass
52	5260	-1.57	0.85	-0.72	11	Pass
60	5300	-1.43	0.85	-0.58	11	Pass
64	5320	-1.20	0.85	-0.35	11	Pass
100	5500	-0.77	0.85	0.08	11	Pass
116	5580	-1.19	0.85	-0.34	11	Pass
140	5700	-1.93	0.85	-1.08	11	Pass

NOTE: Refer to section 3.3 for duty cycle spectrum plot.

802.11n (40MHz)

Channel	Frequency (MHz)	PSD w/o Duty Factor (dBm)	Duty Factor	PSD with Duty Factor (dBm)	Maximum Limit (dBm)	Pass / Fail
38	5190	-5.79	1.64	-4.15	11	Pass
46	5230	-5.64	1.64	-4.00	11	Pass
54	5270	-5.23	1.64	-3.59	11	Pass
62	5310	-5.50	1.64	-3.86	11	Pass
102	5510	-4.40	1.64	-2.76	11	Pass
110	5550	-4.60	1.64	-2.96	11	Pass
134	5670	-5.04	1.64	-3.40	11	Pass

NOTE: Refer to section 3.3 for duty cycle spectrum plot.

802.11ac (80MHz)

Channel	Frequency (MHz)	PSD w/o Duty Factor (dBm)	Duty Factor	PSD with Duty Factor (dBm)	Maximum Limit (dBm)	Pass / Fail
42	5210	-13.29	2.60	-10.69	11	Pass
58	5290	-13.13	2.60	-10.53	11	Pass
106	5530	-12.80	2.60	-10.20	11	Pass
122	5610	-12.69	2.60	-10.09	11	Pass

NOTE: Refer to section 3.3 for duty cycle spectrum plot.

Spectrum Plot of Worst Value

802.11a

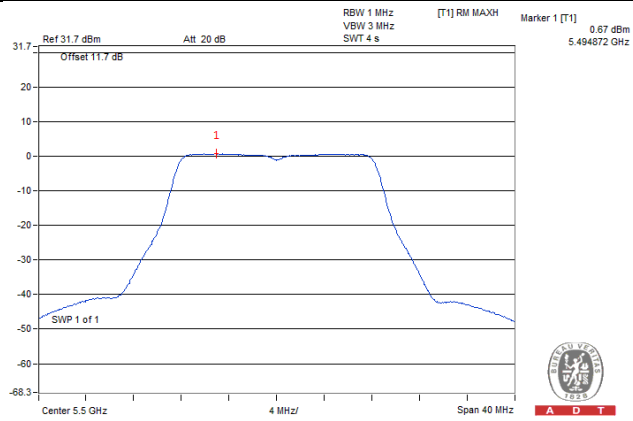

802.11n (20MHz)

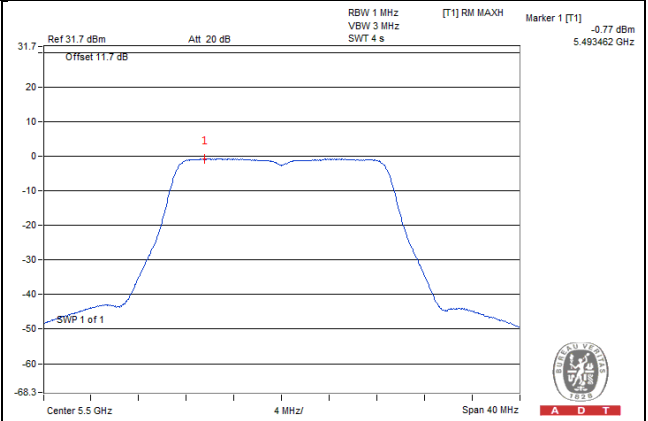

802.11n (40MHz)

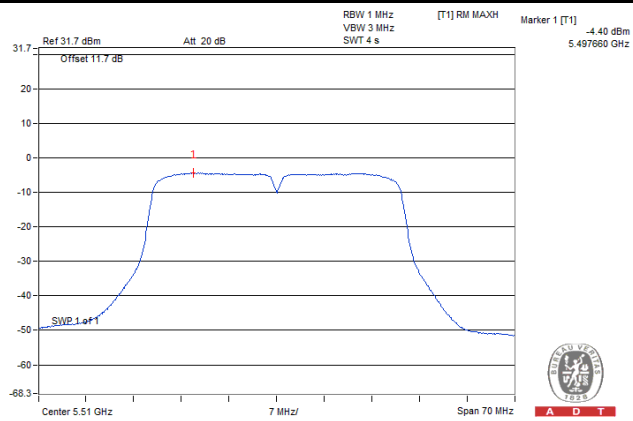

802.11ac (80MHz)

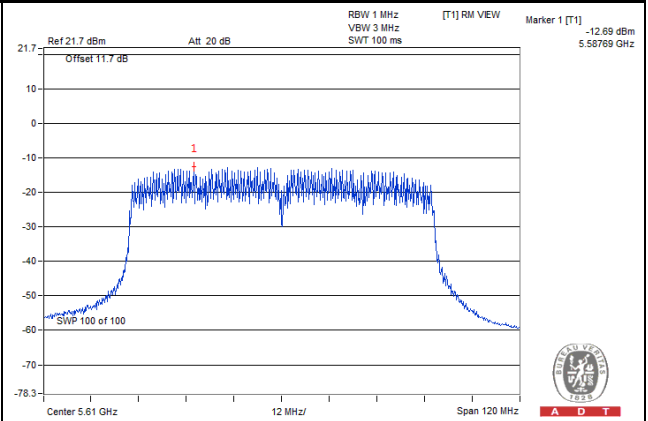

For U-NII-3 Band

802.11a

Channel	Frequency (MHz)	PSD w/o Duty Factor (dBm)	Duty Factor	PSD with Duty Factor (dBm)	Limit (dBm/500kHz)	Pass / Fail
149	5745	-3.66	0.80	-2.86	30	Pass
157	5785	-3.53	0.80	-2.73	30	Pass
165	5825	-2.92	0.80	-2.12	30	Pass

NOTE: Refer to section 3.3 for duty cycle spectrum plot.

802.11n (20MHz)

Channel	Frequency (MHz)	PSD w/o Duty Factor (dBm)	Duty Factor	PSD with Duty Factor (dBm)	Limit (dBm/500kHz)	Pass / Fail
149	5745	-4.86	0.85	-4.01	30	Pass
157	5785	-4.53	0.85	-3.68	30	Pass
165	5825	-4.32	0.85	-3.47	30	Pass

NOTE: Refer to section 3.3 for duty cycle spectrum plot.

802.11n (40MHz)

Channel	Frequency (MHz)	PSD w/o Duty Factor (dBm)	Duty Factor	PSD with Duty Factor (dBm)	Limit (dBm/500kHz)	Pass / Fail
151	5755	-8.24	1.64	-6.60	30	Pass
159	5795	-7.93	1.64	-6.29	30	Pass

NOTE: Refer to section 3.3 for duty cycle spectrum plot.

802.11ac (80MHz)

Channel	Frequency (MHz)	PSD w/o Duty Factor (dBm)	Duty Factor	PSD with Duty Factor (dBm)	Limit (dBm/500kHz)	Pass / Fail
155	5775	-13.77	2.60	-11.17	30	Pass

NOTE: Refer to section 3.3 for duty cycle spectrum plot.

Spectrum Plot of Worst Value

802.11a

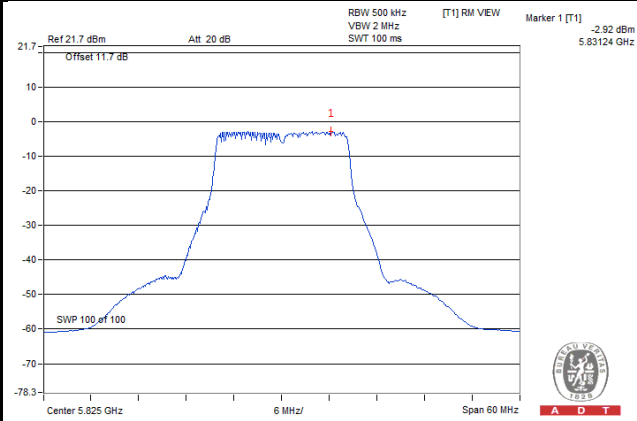

802.11n (20MHz)

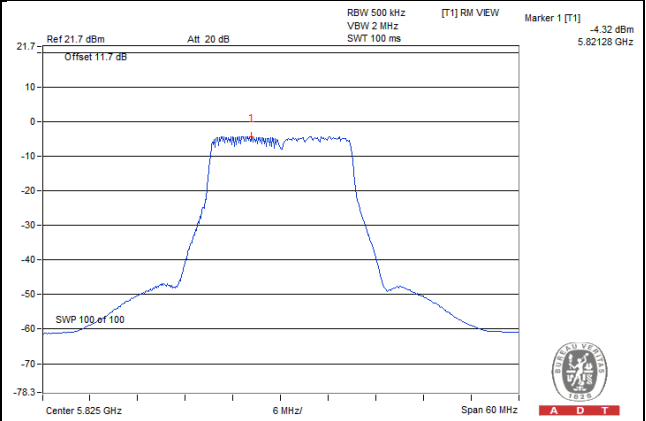

802.11n (40MHz)

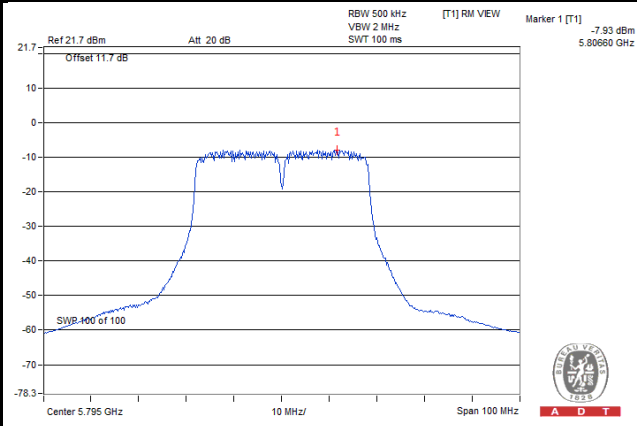

802.11ac (80MHz)

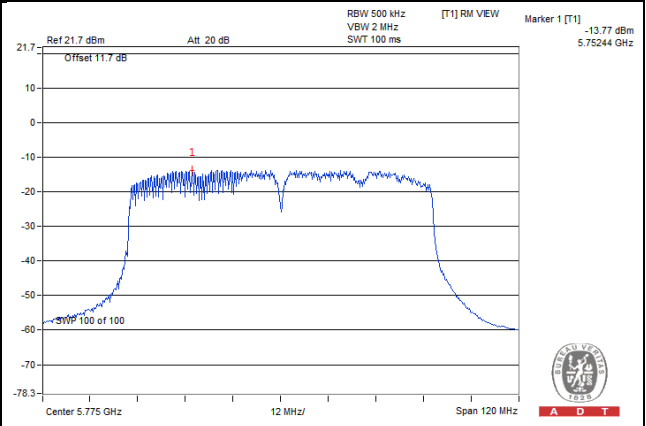

4.5 Frequency Stability

4.5.1 Limit of Frequency Stability Measurement

The frequency of the carrier signal shall be maintained within band of operation

4.5.2 Test Setup

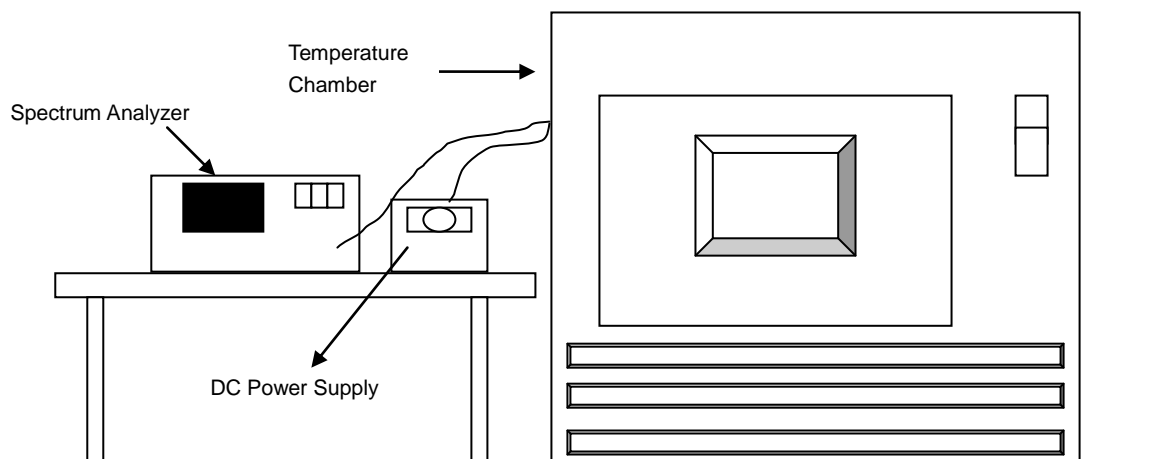

4.5.3 Test Instruments

Refer to section 4.1.3 to get information of above instrument.

4.5.4 Test Procedure

- To ensure emission at the band edge is maintained within the authorized band, those values shall be measured by radiation emissions at upper and lower frequency points, and finally compensated by frequency deviation as procedures below.
- The EUT was operated at the maximum output power, and connected to the spectrum analyzer, which is set to maximum hold function and peak detector. The peak value of the power envelope was measured and noted. The upper and lower frequency points were respectively measured relatively 10dB lower than the measured peak value.
- The frequency deviation was calculated by adding the upper frequency point and the lower frequency point divided by two. Those detailed values of frequency deviation are provided in table below.

4.5.5 Deviation from Test Standard

No deviation.

4.5.6 EUT Operating Condition

Set the EUT transmit at un-modulation mode to test frequency stability.

4.5.7 Test Results

Frequency Stability Versus Temp.									
Operating Frequency: 5320MHz									
Temp. (°C)	Power Supply (Vdc)	0 Minute		2 Minute		5 Minute		10 Minute	
		Measured Frequency (MHz)	Frequency Drift (%)	Measured Frequency (MHz)	Frequency Drift (%)	Measured Frequency (MHz)	Frequency Drift (%)	Measured Frequency (MHz)	Frequency Drift (%)
60	3.85	5320.037303	7.012	5320.036840	6.925	5320.036947	6.945	5320.037433	7.036
50	3.85	5320.038203	7.181	5320.037470	7.043	5320.037865	7.117	5320.037804	7.106
40	3.85	5320.038008	7.144	5320.037855	7.116	5320.037879	7.120	5320.038226	7.185
30	3.85	5320.039110	7.352	5320.038989	7.329	5320.039286	7.385	5320.039272	7.382
20	3.85	5320.038228	7.186	5320.038474	7.232	5320.038224	7.185	5320.037939	7.131
10	3.85	5320.041417	7.785	5320.041554	7.811	5320.041890	7.874	5320.041138	7.733
0	3.85	5320.040041	7.527	5320.040206	7.558	5320.040038	7.526	5320.040191	7.555
-10	3.85	5320.038441	7.226	5320.039044	7.339	5320.038133	7.168	5320.038447	7.227
-20	3.85	5320.038265	7.193	5320.038422	7.222	5320.037732	7.092	5320.038019	7.146
-30	3.85	5320.036761	6.910	5320.037432	7.036	5320.037337	7.018	5320.036991	6.953

Frequency Stability Versus Temp.									
Operating Frequency: 5320MHz									
Temp. (°C)	Power Supply (Vdc)	0 Minute		2 Minute		5 Minute		10 Minute	
		Measured Frequency (MHz)	Frequency Drift (%)	Measured Frequency (MHz)	Frequency Drift (%)	Measured Frequency (MHz)	Frequency Drift (%)	Measured Frequency (MHz)	Frequency Drift (%)
20	3.6	5320.037744	7.095	5320.037521	7.053	5320.037775	7.101	5320.037647	7.077
	3.85	5320.038228	7.186	5320.038474	7.232	5320.038224	7.185	5320.037939	7.131
	4.40	5320.039228	7.374	5320.039504	7.426	5320.039049	7.340	5320.039440	7.414

4.6 6dB Bandwidth Measurement

4.6.1 Limits of 6dB Bandwidth Measurement

The minimum of 6dB Bandwidth Measurement is 0.5MHz.

4.6.2 Test Setup

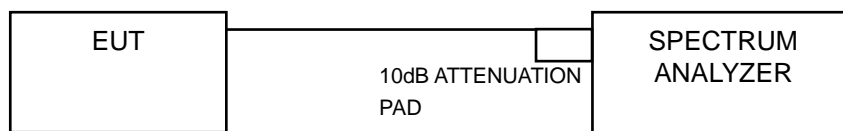

4.6.3 Test Instruments

Refer to section 4.1.3 to get information of above instrument.

4.6.4 Test Procedure

MEASUREMENT PROCEDURE REF

- Set resolution bandwidth (RBW) = 100kHz
- Set the video bandwidth (VBW) $\geq 3 \times$ RBW, Detector = Peak.
- Trace mode = max hold.
- Sweep = auto couple.
- Measure the maximum width of the emission that is constrained by the frequencies associated with the two amplitude points (upper and lower) that are attenuated by 6 dB relative to the maximum level measured in the fundamental emission

4.6.5 Deviation from Test Standard

No deviation.

4.6.6 EUT Operating Condition

The software provided by client to enable the EUT under transmission condition continuously at lowest, middle and highest channel frequencies individually.

4.6.7 Test Results

802.11a

Channel	Frequency (MHz)	6dB Bandwidth (MHz)	Minimum Limit (MHz)	Pass / Fail
149	5745	16.42	0.5	Pass
157	5785	16.42	0.5	Pass
165	5825	16.42	0.5	Pass

802.11n (20MHz)

Channel	Frequency (MHz)	6dB Bandwidth (MHz)	Minimum Limit (MHz)	Pass / Fail
149	5745	17.64	0.5	Pass
157	5785	17.63	0.5	Pass
165	5825	17.64	0.5	Pass

802.11n (40MHz)

Channel	Frequency (MHz)	6dB Bandwidth (MHz)	Minimum Limit (MHz)	Pass / Fail
151	5755	35.28	0.5	Pass
159	5795	35.48	0.5	Pass

802.11ac (80MHz)

Channel	Frequency (MHz)	6dB Bandwidth (MHz)	Minimum Limit (MHz)	Pass / Fail
155	5775	75.28	0.5	Pass

Spectrum Plot of Worst Value

802.11a

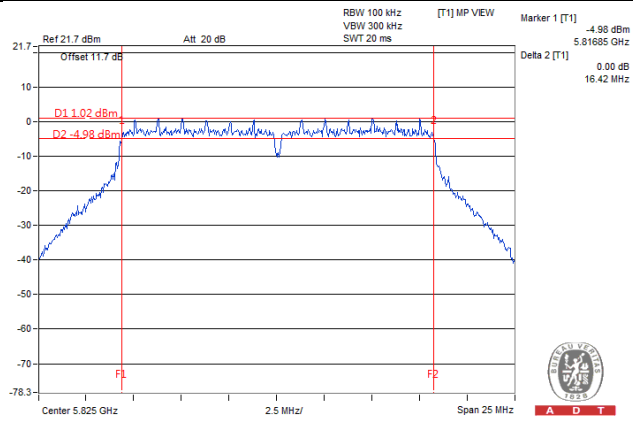

802.11n (20MHz)

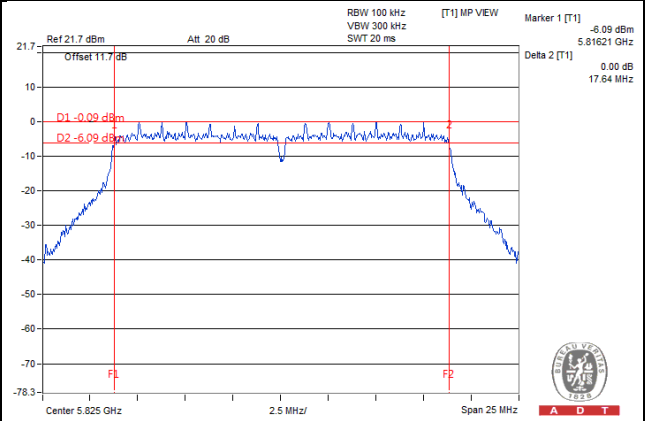

802.11n (40MHz)

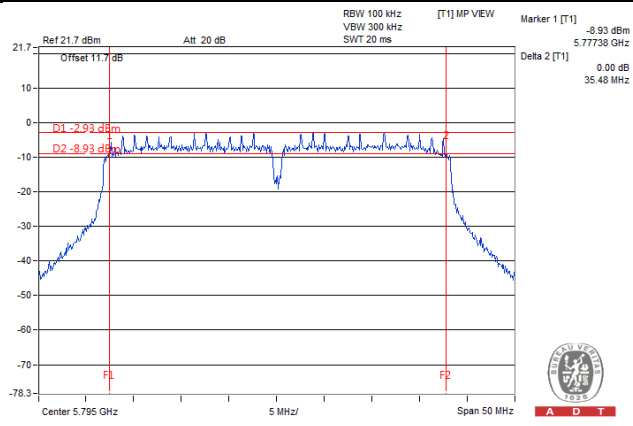

802.11ac (80MHz)

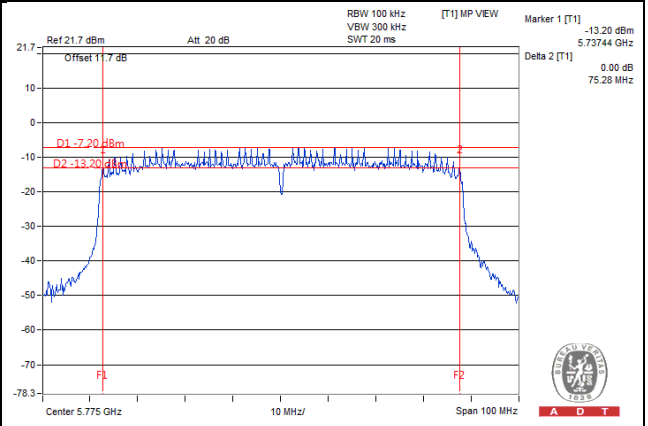



5 Pictures of Test Arrangements

Please refer to the attached file (Test Setup Photo).



Appendix – Information on the Testing Laboratories

We, Bureau Veritas Consumer Products Services (H.K.) Ltd., Taoyuan Branch, were founded in 1988 to provide our best service in EMC, Radio, Telecom and Safety consultation. Our laboratories are accredited and approved according to ISO/IEC 17025.

If you have any comments, please feel free to contact us at the following:

Linko EMC/RF Lab

Tel: 886-2-26052180

Fax: 886-2-26051924

Hsin Chu EMC/RF Lab/Telecom Lab

Tel: 886-3-5935343

Fax: 886-3-5935342

Hwa Ya EMC/RF/Safety

Tel: 886-3-3183232

Fax: 886-3-3270892

Email: service.adt@tw.bureauveritas.com

Web Site: www.bureauveritas-adt.com

The address and road map of all our labs can be found in our web site also.

--- END ---