



FCC TEST REPORT (15.247)

REPORT NO.: RF150324C22-3
MODEL NAME: OPM9400
FCC ID: NM80PM9400
RECEIVED: Mar. 24, 2015
TESTED: Apr. 24, 2015 ~ May 01, 2015
ISSUED: May 19, 2015

APPLICANT: HTC Corporation

ADDRESS: 1F, 6-3 Baoqiang Road, Xindian District, New Taipei City, Taiwan 231

ISSUED BY: Bureau Veritas Consumer Products Services (H.K.) Ltd., Taoyuan Branch

LAB ADDRESS: No. 47-2, 14th Ling, Chia Pau Vil., Lin Kou Dist., New Taipei City, Taiwan (R.O.C)

TEST LOCATION: No. 19, Hwa Ya 2nd Rd, Wen Hwa Vil., Kwei Shan Dist., Taoyuan City 333, Taiwan, R.O.C.

This report should not be used by the client to claim product certification, approval, or endorsement by TAF or any government agencies.



This report is for your exclusive use. Any copying or replication of this report to or for any other person or entity, or use of our name or trademark, is permitted only with our prior written permission. This report sets forth our findings solely with respect to the test samples identified herein. The results set forth in this report are not indicative or representative of the quality or characteristics of the lot from which a test sample was taken or any similar or identical product unless specifically and expressly noted. Our report includes all of the tests requested by you and the results thereof based upon the information that you provided to us. You have 60 days from date of issuance of this report to notify us of any material error or omission caused by our negligence, provided, however, that such notice shall be in writing and shall specifically address the issue you wish to raise. A failure to raise such issue within the prescribed time shall constitute your unqualified acceptance of the completeness of this report, the tests conducted and the correctness of the report contents. Unless specific mention, the uncertainty of measurement has been explicitly taken into account to declare the compliance or non-compliance to the specification.



TABLE OF CONTENTS

- RELEASE CONTROL RECORD4
- 1. CERTIFICATION.....5
- 2. SUMMARY OF TEST RESULTS6
 - 2.1 MEASUREMENT UNCERTAINTY.....6
- 3. GENERAL INFORMATION7
 - 3.1 GENERAL DESCRIPTION OF EUT7
 - 3.2 DESCRIPTION OF TEST MODES8
 - 3.2.1 TEST MODE APPLICABILITY AND TESTED CHANNEL DETAIL9
 - 3.3 DESCRIPTION OF SUPPORT UNITS11
 - 3.3.1 CONFIGURATION OF SYSTEM UNDER TEST11
 - 3.4 DUTY CYCLE TEST SIGNAL12
 - 3.5 GENERAL DESCRIPTION OF APPLIED STANDARDS13
- 4. TEST TYPES AND RESULTS (FOR 2.4GHz BAND)14
 - 4.1 RADIATED EMISSION AND BANDEDGE MEASUREMENT14
 - 4.1.1 LIMITS OF RADIATED EMISSION AND BANDEDGE MEASUREMENT14
 - 4.1.2 TEST INSTRUMENTS15
 - 4.1.3 TEST PROCEDURES16
 - 4.1.4 DEVIATION FROM TEST STANDARD16
 - 4.1.5 TEST SETUP17
 - 4.1.6 EUT OPERATING CONDITIONS17
 - 4.1.7 TEST RESULTS.....18
 - 4.2 CONDUCTED EMISSION MEASUREMENT30
 - 4.2.1 LIMITS OF CONDUCTED EMISSION MEASUREMENT30
 - 4.2.2 TEST INSTRUMENTS.....30
 - 4.2.3 TEST PROCEDURES31
 - 4.2.4 DEVIATION FROM TEST STANDARD31
 - 4.2.5 TEST SETUP32
 - 4.2.6 EUT OPERATING CONDITIONS32
 - 4.2.7 TEST RESULTS.....33
 - 4.3 6dB BANDWIDTH MEASUREMENT37
 - 4.3.1 LIMITS OF 6dB BANDWIDTH MEASUREMENT37
 - 4.3.2 TEST SETUP37
 - 4.3.3 TEST INSTRUMENTS.....37
 - 4.3.4 TEST PROCEDURE37
 - 4.3.5 DEVIATION FROM TEST STANDARD37
 - 4.3.6 EUT OPERATING CONDITIONS37
 - 4.3.7 TEST RESULTS.....38
 - 4.4 CONDUCTED OUTPUT POWER40
 - 4.4.1 LIMITS OF CONDUCTED OUTPUT POWER MEASUREMENT40
 - 4.4.2 TEST SETUP40
 - 4.4.3 TEST INSTRUMENTS.....40
 - 4.4.4 TEST PROCEDURES40
 - 4.4.5 DEVIATION FROM TEST STANDARD40
 - 4.4.6 EUT OPERATING CONDITIONS40
 - 4.4.7 TEST RESULTS.....41
 - 4.5 POWER SPECTRAL DENSITY MEASUREMENT.....42
 - 4.5.1 LIMITS OF POWER SPECTRAL DENSITY MEASUREMENT42
 - 4.5.2 TEST SETUP42
 - 4.5.3 TEST INSTRUMENTS.....42
 - 4.5.4 TEST PROCEDURE42
 - 4.5.5 DEVIATION FROM TEST STANDARD42
 - 4.5.6 EUT OPERATING CONDITION.....42



A D T

4.5.7	TEST RESULTS.....	43
4.6	CONDUCTED OUT OF BAND EMISSION MEASUREMENT	45
4.6.1	LIMITS OF CONDUCTED OUT OF BAND EMISSION MEASUREMENT	45
4.6.2	TEST SETUP	45
4.6.3	TEST INSTRUMENTS	45
4.6.4	TEST PROCEDURE	45
4.6.5	DEVIATION FROM TEST STANDARD	45
4.6.6	EUT OPERATING CONDITION.....	45
4.6.7	TEST RESULTS.....	46
5.	PHOTOGRAPHS OF THE TEST CONFIGURATION.....	52
6.	INFORMATION ON THE TESTING LABORATORIES	53
7.	APPENDIX A – MODIFICATIONS RECORDERS FOR ENGINEERING CHANGES TO THE EUT BY THE LAB	54



A D T

RELEASE CONTROL RECORD

ISSUE NO.	REASON FOR CHANGE	DATE ISSUED
RF150324C22-3	Original release	May 19, 2015



1. CERTIFICATION

PRODUCT: Smartphone
MODEL: OPM9400
BRAND: HTC
APPLICANT: HTC Corporation
TESTED: Apr. 24, 2015 ~ May 01, 2015
TEST SAMPLE: Production Unit
STANDARDS: **FCC Part 15, Subpart C (Section 15.247)**
ANSI C63.10-2009

The above equipment (model: OPM9400) has been tested by **Bureau Veritas Consumer Products Services (H.K.) Ltd., Taoyuan Branch**, and found compliance with the requirement of the above standards. The test record, data evaluation & Equipment Under Test (EUT) configurations represented herein are true and accurate accounts of the measurements of the sample's EMC characteristics under the conditions specified in this report.

PREPARED BY : Ivonne Wu , **DATE** : May 19, 2015
Ivonne Wu / Supervisor

APPROVED BY : Sam Chen , **DATE** : May 19, 2015
Sam Chen / Senior Project Engineer

2. SUMMARY OF TEST RESULTS

The EUT has been tested according to the following specifications:

APPLIED STANDARD: FCC PART 15, SUBPART C (SECTION 15.247)			
STANDARD SECTION	TEST TYPE	RESULT	REMARK
15.207	AC Power Conducted Emission	PASS	Meet the requirement of limit. Minimum passing margin is -11.64dB at 0.15000MHz.
15.205 & 15.209	Radiated Emissions	PASS	Meet the requirement of limit. Minimum passing margin is -1.03dB at 2390.00MHz.
15.247(d)	Band Edge Measurement	PASS	Meet the requirement of limit.
15.247(d)	Antenna Port Emission	PASS	Meet the requirement of limit.
15.247(a)(2)	6dB bandwidth	PASS	Meet the requirement of limit.
15.247(b)	Conducted power	PASS	Meet the requirement of limit.
15.247(e)	Power Spectral Density	PASS	Meet the requirement of limit.
15.203	Antenna Requirement	PASS	No antenna connector is used.

2.1 MEASUREMENT UNCERTAINTY

Where relevant, the following measurement uncertainty levels have been estimated for tests performed on the EUT as specified in CISPR 16-4-2:

MEASUREMENT	FREQUENCY	UNCERTAINTY
Conducted emissions	9kHz~30MHz	2.44 dB
Radiated emissions	30MHz ~ 200MHz	2.93 dB
	200MHz ~1000MHz	2.95 dB
	1GHz ~ 18GHz	2.26 dB
	18GHz ~ 40GHz	1.94 dB

This uncertainty represents an expanded uncertainty expressed at approximately the 95% confidence level using a coverage factor of $k = 2$.



A D T

3. GENERAL INFORMATION

3.1 GENERAL DESCRIPTION OF EUT

EUT	Smartphone
MODEL NAME	OPM9400
POWER SUPPLY	5.0Vdc (adapter or host equipment) 3.8Vdc or 3.85Vdc (Li-ion battery)
MODULATION TYPE	CCK, DQPSK, DBPSK for DSSS 64QAM, 16QAM, QPSK, BPSK for OFDM
MODULATION TECHNOLOGY	DSSS, OFDM
TRANSFER RATE	802.11b: 11.0 / 5.5 / 2.0 / 1.0 Mbps 802.11g: 54.0 / 48.0 / 36.0 / 24.0 / 18.0 / 12.0 / 9.0 / 6.0 Mbps 802.11n: up to MCS7
OPERATING FREQUENCY	2412 ~ 2462MHz
NUMBER OF CHANNEL	11
OUTPUT POWER	243.78mW
ANTENNA TYPE	PIFA antenna with -0.5dBi gain
ANTENNA CONNECTOR	NA
DATA CABLE	Refer to Note as below
I/O PORTS	Refer to user's manual
ACCESSORY DEVICES	Refer to Note as below

NOTE:

- There're 2 configurations for the EUT listed as below.
Main sample (A): Phone + Battery 1 + LCD Panel 1
2nd sample (B): Phone + Battery 2 + LCD Panel 2
✧ Only the worst test data was presented in the report.
- The EUT's accessories list refers to Ext. Pho.
- The above EUT information is declared by the manufacturer and for more detailed features description, please refer to the manufacturer's specifications or User's Manual.

3.2 DESCRIPTION OF TEST MODES

FOR 2.4GHz:

11 channels are provided for 802.11b, 802.11g and 802.11n (20MHz):

CHANNEL	FREQUENCY	CHANNEL	FREQUENCY
1	2412MHz	7	2442MHz
2	2417MHz	8	2447MHz
3	2422MHz	9	2452MHz
4	2427MHz	10	2457MHz
5	2432MHz	11	2462MHz
6	2437MHz		

3.2.1 TEST MODE APPLICABILITY AND TESTED CHANNEL DETAIL

WLAN 2.4GHz:

EUT CONFIGURE MODE	APPLICABLE TO				DESCRIPTION
	RE≥1G	RE<1G	PLC	APCM	
A	√	√	√	√	Main sample
B	√	√	√	-	2 nd sample

Where **RE≥1G**: Radiated Emission above 1GHz **RE<1G**: Radiated Emission below 1GHz
PLC: Power Line Conducted Emission **APCM**: Antenna Port Conducted Measurement

NOTE: The EUT had been pre-tested on the positioned of each 3 axis. The worst case was found when positioned on **Z-plane**.

RADIATED EMISSION TEST (ABOVE 1GHz):

Pre-Scan has been conducted to determine the worst-case mode from all possible combinations between available modulations, data rates and antenna ports (if EUT with antenna diversity architecture).

Following channel(s) was (were) selected for the final test as listed below.

EUT CONFIGURE MODE	MODE	AVAILABLE CHANNEL	TESTED CHANNEL	MODULATION TECHNOLOGY	MODULATION TYPE	DATA RATE (Mbps)
A	802.11b	1 to 11	1, 6, 11	DSSS	DBPSK	1.0
	802.11g	1 to 11	1, 6, 11	OFDM	BPSK	6.0
	802.11n (20MHz)	1 to 11	1, 6, 11	OFDM	BPSK	MCS0
B	802.11n (20MHz)	1 to 11	1	OFDM	BPSK	MCS0

RADIATED EMISSION TEST (BELOW 1GHz):

Pre-Scan has been conducted to determine the worst-case mode from all possible combinations between available modulations, data rates and antenna ports (if EUT with antenna diversity architecture).

Following channel(s) was (were) selected for the final test as listed below.

EUT CONFIGURE MODE	MODE	AVAILABLE CHANNEL	TESTED CHANNEL	MODULATION TECHNOLOGY	MODULATION TYPE	DATA RATE (Mbps)
A, B	802.11n (20MHz)	1 to 11	1	OFDM	BPSK	MCS0

POWER LINE CONDUCTED EMISSION TEST:

Pre-Scan has been conducted to determine the worst-case mode from all possible combinations between available modulations, data rates and antenna ports (if EUT with antenna diversity architecture).

Following channel(s) was (were) selected for the final test as listed below.

EUT CONFIGURE MODE	MODE	AVAILABLE CHANNEL	TESTED CHANNEL	MODULATION TECHNOLOGY	MODULATION TYPE	DATA RATE (Mbps)
A, B	802.11n (20MHz)	1 to 11	1	OFDM	BPSK	MCS0



BANDEDGE MEASUREMENT:

- Pre-Scan has been conducted to determine the worst-case mode from all possible combinations between available modulations, data rates and antenna ports (if EUT with antenna diversity architecture).
- Following channel(s) was (were) selected for the final test as listed below.

EUT CONFIGURE MODE	MODE	AVAILABLE CHANNEL	TESTED CHANNEL	MODULATION TECHNOLOGY	MODULATION TYPE	DATA RATE (Mbps)
A	802.11b	1 to 11	1, 6, 11	DSSS	DBPSK	1.0
	802.11g	1 to 11	1, 6, 11	OFDM	BPSK	6.0
	802.11n (20MHz)	1 to 11	1, 6, 11	OFDM	BPSK	MCS0

ANTENNA PORT CONDUCTED MEASUREMENT:

- This item includes all test value of each mode, but only includes spectrum plot of worst value of each mode.
- Pre-Scan has been conducted to determine the worst-case mode from all possible combinations between available modulations, data rates and antenna ports (if EUT with antenna diversity architecture).
- Following channel(s) was (were) selected for the final test as listed below.

EUT CONFIGURE MODE	MODE	AVAILABLE CHANNEL	TESTED CHANNEL	MODULATION TECHNOLOGY	MODULATION TYPE	DATA RATE (Mbps)
A	802.11b	1 to 11	1, 6, 11	DSSS	DBPSK	1.0
	802.11g	1 to 11	1, 6, 11	OFDM	BPSK	6.0
	802.11n (20MHz)	1 to 11	1, 6, 11	OFDM	BPSK	MCS0

TEST CONDITION:

APPLICABLE TO	ENVIRONMENTAL CONDITIONS	INPUT POWER	TESTED BY
RE≥1G	25deg. C, 65%RH	120Vac, 60Hz	Will Chen
RE<1G	25deg. C, 65%RH	120Vac, 60Hz	Will Chen
PLC	25deg. C, 65%RH	120Vac, 60Hz	Toby Tien
APCM	25deg. C, 65%RH	3.8Vdc	Dylan Yang

3.3 DESCRIPTION OF SUPPORT UNITS

The EUT has been tested as an independent unit together with other necessary accessories or support units.

3.3.1 CONFIGURATION OF SYSTEM UNDER TEST

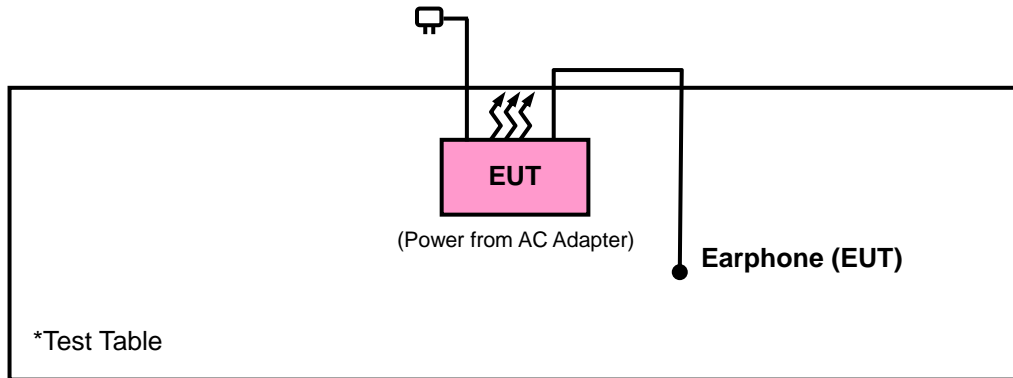

3.4 DUTY CYCLE TEST SIGNAL

WLAN 2.4GHz

802.11b: Duty cycle of test signal is 100 %

802.11g: Duty cycle of test signal is > 98 %

802.11n (20MHz): Duty cycle of test signal is > 98 %

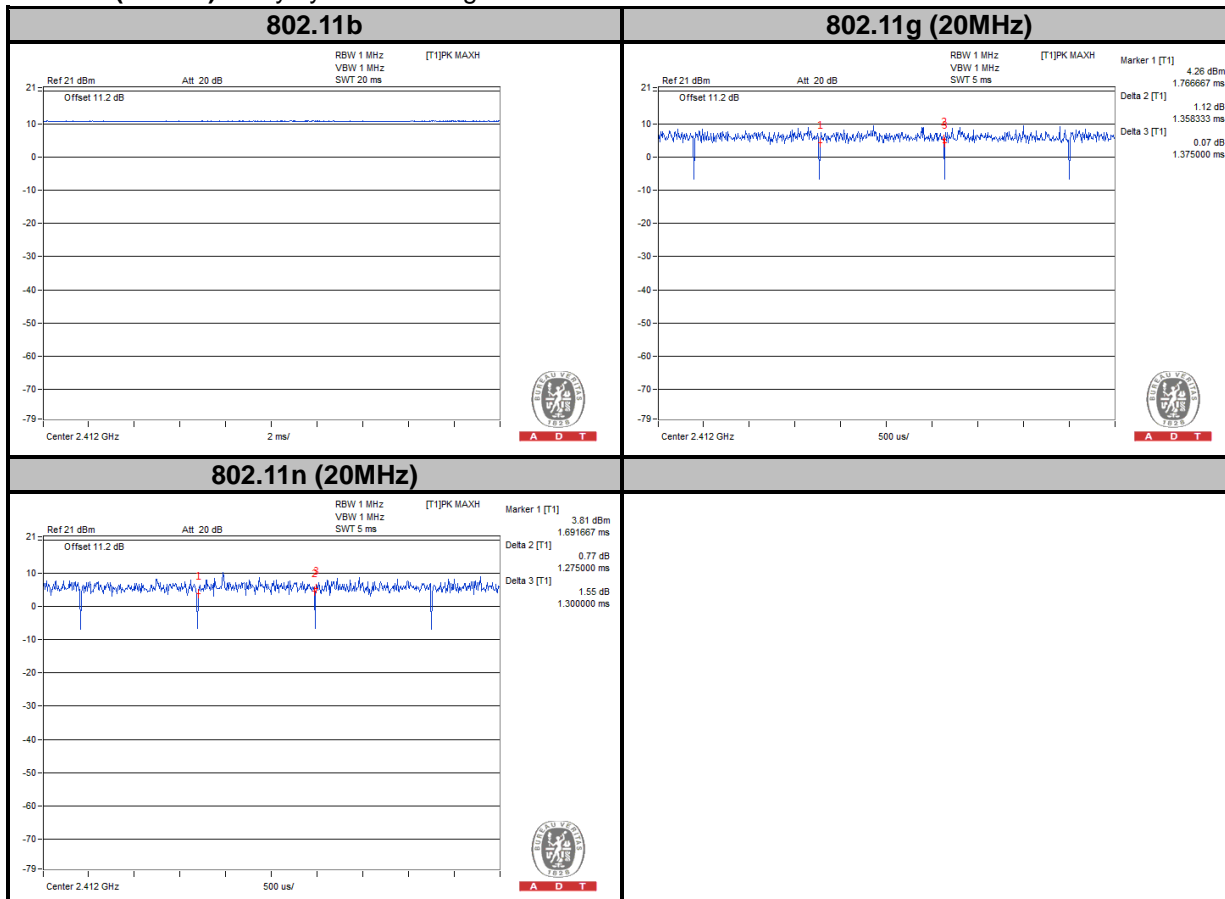



3.5 GENERAL DESCRIPTION OF APPLIED STANDARDS

The EUT is a RF Product. According to the specifications of the manufacturer, it must comply with the requirements of the following standards:

FCC Part 15, Subpart C (15.247)

558074 D01 DTS Meas Guidance v03r02

ANSI C63.10-2009

All test items have been performed and recorded as per the above standards.

NOTE: The EUT has been verified to comply with the requirements of FCC Part 15, Subpart B, Class B (DoC). The test report has been issued separately.

4. TEST TYPES AND RESULTS (FOR 2.4GHz BAND)

4.1 RADIATED EMISSION AND BANDEDGE MEASUREMENT

4.1.1 LIMITS OF RADIATED EMISSION AND BANDEDGE MEASUREMENT

Radiated emissions which fall in the restricted bands must comply with the radiated emission limits specified as below table. Other emissions shall be at least 20dB below the highest level of the desired power:

FREQUENCIES (MHz)	FIELD STRENGTH (microvolts/meter)	MEASUREMENT DISTANCE (meters)
0.009 ~ 0.490	2400/F(kHz)	300
0.490 ~ 1.705	24000/F(kHz)	30
1.705 ~ 30.0	30	30
30 ~ 88	100	3
88 ~ 216	150	3
216 ~ 960	200	3
Above 960	500	3

NOTE:

1. The lower limit shall apply at the transition frequencies.
2. Emission level (dBuV/m) = 20 log Emission level (uV/m).
3. For frequencies above 1000MHz, the field strength limits are based on average detector, however, the peak field strength of any emission shall not exceed the maximum permitted average limits, specified above by more than 20dB under any condition of modulation.



A D T

4.1.2 TEST INSTRUMENTS

DESCRIPTION & MANUFACTURER	MODEL NO.	SERIAL NO.	DATE OF CALIBRATION	DUE DATE OF CALIBRATION
Test Receiver Agilent	N9038A	MY51210203	Jan. 21, 2015	Jan. 21, 2016
Spectrum Analyzer Agilent	N9010A	MY52220314	Sep. 03, 2014	Sep. 02, 2015
Spectrum Analyzer ROHDE & SCHWARZ	FSU43	101261	Dec. 10, 2014	Dec. 09, 2015
BILOG Antenna SCHWARZBECK	VULB9168	9168-472	Feb. 04, 2015	Feb. 04, 2016
HORN Antenna SCHWARZBECK	BBHA 9120 D	9120D-969	Feb. 09, 2015	Feb. 09, 2016
HORN Antenna SCHWARZBECK	BBHA 9170	9170-480	Feb. 04, 2015	Feb. 04, 2016
Loop Antenna	EM-6879	269	Aug.13, 2014	Aug.12, 2015
Preamplifier EMCI	EMC 012645	980115	Dec. 12, 2014	Dec. 11, 2015
Preamplifier EMCI	EMC 184045	980116	Jan. 09, 2015	Jan. 08, 2016
Preamplifier EMCI	EMC 330H	980112	Dec. 27, 2014	Dec. 26, 2015
Power Meter Anritsu	ML2495A	1232002	Sep. 17, 2014	Sep. 16, 2015
Power Sensor Anritsu	MA2411B	1207325	Sep. 17, 2014	Sep. 16, 2015
RF signal cable HUBER+SUHNNER	SUCOFLEX 104	309219/4 2950114	Oct. 18, 2014	Oct. 17, 2015
RF signal cable HUBER+SUHNNER	SUCOFLEX 104	250130/4	Oct. 18, 2014	Oct. 17, 2015
RF Coaxial Cable Worken	8D-FB	Cable-Ch10-01	Nov. 07, 2014	Nov. 06, 2015
Software BV ADT	E3 6.120103	NA	NA	NA
Antenna Tower MF	MFA-440H	NA	NA	NA
Turn Table MF	MFT-201SS	NA	NA	NA
Antenna Tower & Turn Table Controller MF	MF-7802	NA	NA	NA
Bluetooth Tester	CBT	100946	Jul. 29, 2013	Jul. 28, 2015

- NOTE:**
1. The calibration interval of the above test instruments is 12 / 24 months and the calibrations are traceable to NML/ROC and NIST/USA.
 2. The test was performed in HwaYa Chamber 10.
 3. The horn antenna and HP preamplifier (model: 8449B) are used only for the measurement of emission frequency above 1GHz if tested.
 4. The FCC Site Registration No. is 690701.
 5. The IC Site Registration No. is IC 7450F-10.

4.1.3 TEST PROCEDURES

- a. The EUT was placed on the top of a rotating table 0.8 meters (for below 1GHz) / 1.5 meters (for above 1GHz) above the ground at 3 meter chamber room for test. The table was rotated 360 degrees to determine the position of the highest radiation.
- b. The EUT was set 3 meters away from the interference-receiving antenna, which was mounted on the top of a variable-height antenna tower.
- c. Height of receiving antenna is varied from one meter to four meters above the ground to determine the maximum value of the field strength. Both horizontal and vertical polarizations of the antenna are set to make the measurement.
- d. For each suspected emission, the EUT was arranged to its worst case and then the antenna was tuned to heights from 1 meter to 4 meters and the rotatable table was turned from 0 degrees to 360 degrees to find the maximum reading.
- e. The test-receiver system was set to Peak Detect Function and Specified Bandwidth with Maximum Hold Mode.
- f. If the emission level of the EUT in peak mode was lower than the limit specified, then testing could be stopped and the peak values of the EUT would be reported. Otherwise the emissions would be re-tested one by one using peak, quasi-peak or average method as specified and then reported in a data sheet.

NOTE:

1. The resolution bandwidth and video bandwidth of test receiver/spectrum analyzer is 120kHz for Quasi-peak detection at frequency below 1GHz.
2. The resolution bandwidth of test receiver/spectrum analyzer is 1MHz and video bandwidth is 3MHz for Peak detection at frequency above 1GHz.
3. The resolution bandwidth of test receiver/spectrum analyzer is 1MHz and the video bandwidth is 1kHz (Duty cycle < 98%) or 10Hz (Duty cycle > 98%) for Average detection (AV) at frequency above 1GHz.
4. All modes of operation were investigated and the worst-case emissions are reported.

4.1.4 DEVIATION FROM TEST STANDARD

No deviation.

4.1.5 TEST SETUP

<Frequency Range 30MHz ~ 1GHz>

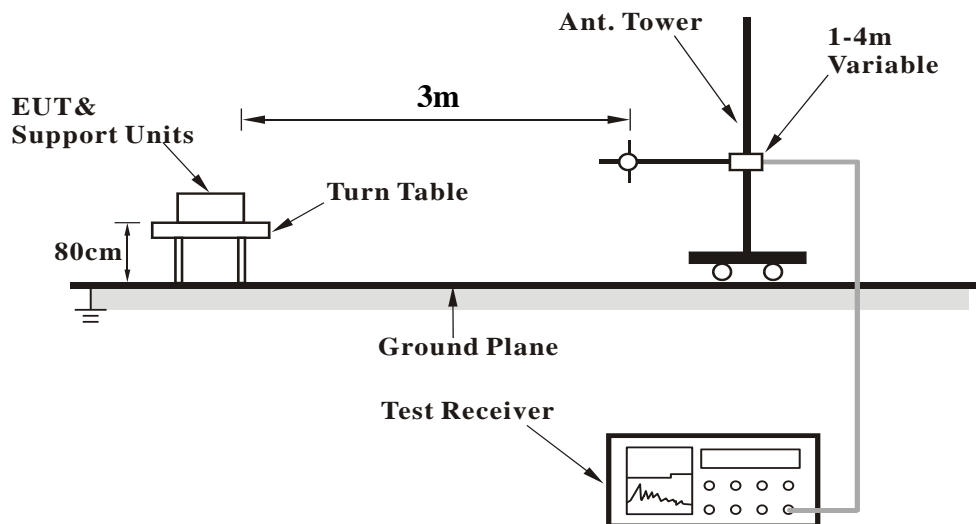

<Frequency Range above 1GHz>

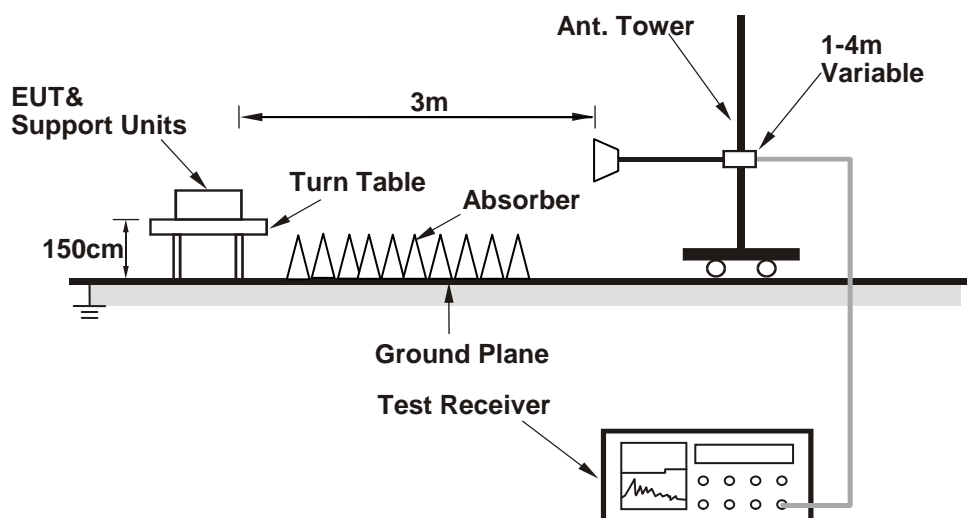

For the actual test configuration, please refer to the attached file (Test Setup Photo).

4.1.6 EUT OPERATING CONDITIONS

- a. Placed the EUT on a testing table.
- b. Use the software to control the EUT under transmission condition continuously at specific channel frequency.



A D T

4.1.7 TEST RESULTS

ABOVE 1GHz WORST-CASE DATA

MODE A

802.11b

EUT TEST CONDITION		MEASUREMENT DETAIL	
CHANNEL	Channel 1	FREQUENCY RANGE	1GHz ~ 25GHz
INPUT POWER	120Vac, 60 Hz	DETECTOR FUNCTION	Peak (PK) Average (AV)
ENVIRONMENTAL CONDITIONS	25deg. C, 65%RH	TESTED BY	Will Chen

ANTENNA POLARITY & TEST DISTANCE: HORIZONTAL AT 3 M										
FREQ. (MHz)	EMISSION LEVEL (dBuV/m)	READ LEVEL (dBuV)	LIMIT (dBuV/m)	MARGIN (dB)	ANTENNA FACTOR (dB/m)	CABLE LOSS (dB)	PREAMP FACTOR (dB)	ANTENNA HEIGHT (cm)	TABLE ANGLE (Degree)	REMARK
2390	44.38	42.65	54	-9.62	31.8	5.4	35.47	182	210	Average
2390	56.53	54.8	74	-17.47	31.8	5.4	35.47	182	210	Peak
2412	105.66	103.89			31.81	5.43	35.47	182	210	Average
2412	108.36	106.59			31.81	5.43	35.47	182	210	Peak
2494	39.83	37.81	54	-14.17	31.9	5.53	35.41	182	210	Average
2494	56.08	54.06	74	-17.92	31.9	5.53	35.41	182	210	Peak
ANTENNA POLARITY & TEST DISTANCE: VERTICAL AT 3 M										
FREQ. (MHz)	EMISSION LEVEL (dBuV/m)	READ LEVEL (dBuV)	LIMIT (dBuV/m)	MARGIN (dB)	ANTENNA FACTOR (dB/m)	CABLE LOSS (dB)	PREAMP FACTOR (dB)	ANTENNA HEIGHT (cm)	TABLE ANGLE (Degree)	REMARK
2388	49.88	48.17	54	-4.12	31.8	5.4	35.49	126	150	Average
2388	58.11	56.4	74	-15.89	31.8	5.4	35.49	126	150	Peak
2412	109.22	107.45			31.81	5.43	35.47	126	150	Average
2412	111.96	110.19			31.81	5.43	35.47	126	150	Peak
2498	39.92	37.9	54	-14.08	31.9	5.53	35.41	126	150	Average
2498	55.89	53.87	74	-18.11	31.9	5.53	35.41	126	150	Peak

REMARKS:

- Emission Level = Read Level + Antenna Factor + Cable Loss - Preamp Factor
Margin value = Emission level – Limit value
- 2412MHz: Fundamental frequency.



A D T

EUT TEST CONDITION		MEASUREMENT DETAIL	
CHANNEL	Channel 6	FREQUENCY RANGE	1GHz ~ 25GHz
INPUT POWER	120Vac, 60 Hz	DETECTOR FUNCTION	Peak (PK) Average (AV)
ENVIRONMENTAL CONDITIONS	25deg. C, 65%RH	TESTED BY	Will Chen

ANTENNA POLARITY & TEST DISTANCE: HORIZONTAL AT 3 M

FREQ. (MHz)	EMISSION LEVEL (dBuV/m)	READ LEVEL (dBuV)	LIMIT (dBuV/m)	MARGIN (dB)	ANTENNA FACTOR (dB/m)	CABLE LOSS (dB)	PREAMP FACTOR (dB)	ANTENNA HEIGHT (cm)	TABLE ANGLE (Degree)	REMARK
2380	40.21	38.55	54	-13.79	31.78	5.37	35.49	182	210	Average
2380	55.59	53.93	74	-18.41	31.78	5.37	35.49	182	210	Peak
2437	105.75	103.9			31.85	5.46	35.46	182	210	Average
2437	108.74	106.89			31.85	5.46	35.46	182	210	Peak
2486	40.31	38.32	54	-13.69	31.88	5.53	35.42	182	210	Average
2486	55.37	53.38	74	-18.63	31.88	5.53	35.42	182	210	Peak

ANTENNA POLARITY & TEST DISTANCE: VERTICAL AT 3 M

FREQ. (MHz)	EMISSION LEVEL (dBuV/m)	READ LEVEL (dBuV)	LIMIT (dBuV/m)	MARGIN (dB)	ANTENNA FACTOR (dB/m)	CABLE LOSS (dB)	PREAMP FACTOR (dB)	ANTENNA HEIGHT (cm)	TABLE ANGLE (Degree)	REMARK
2390	40.73	39	54	-13.27	31.8	5.4	35.47	140	151	Average
2390	55.71	53.98	74	-18.29	31.8	5.4	35.47	140	151	Peak
2437	108.46	106.61			31.85	5.46	35.46	140	151	Average
2437	111.01	109.16			31.85	5.46	35.46	140	151	Peak
2488	40.87	38.86	54	-13.13	31.9	5.53	35.42	140	151	Average
2488	55.88	53.87	74	-18.12	31.9	5.53	35.42	140	151	Peak

REMARKS:

- Emission Level = Read Level + Antenna Factor + Cable Loss - Preamp Factor
Margin value = Emission level – Limit value
- 2437MHz: Fundamental frequency.



A D T

EUT TEST CONDITION		MEASUREMENT DETAIL	
CHANNEL	Channel 11	FREQUENCY RANGE	1GHz ~ 25GHz
INPUT POWER	120Vac, 60 Hz	DETECTOR FUNCTION	Peak (PK) Average (AV)
ENVIRONMENTAL CONDITIONS	25deg. C, 65%RH	TESTED BY	Will Chen

ANTENNA POLARITY & TEST DISTANCE: HORIZONTAL AT 3 M

FREQ. (MHz)	EMISSION LEVEL (dBuV/m)	READ LEVEL (dBuV)	LIMIT (dBuV/m)	MARGIN (dB)	ANTENNA FACTOR (dB/m)	CABLE LOSS (dB)	PREAMP FACTOR (dB)	ANTENNA HEIGHT (cm)	TABLE ANGLE (Degree)	REMARK
2310	39.28	37.8	54	-14.72	31.71	5.3	35.53	162	204	Average
2310	55.58	54.1	74	-18.42	31.71	5.3	35.53	162	204	Peak
2462	105.91	103.98			31.87	5.5	35.44	162	204	Average
2462	108.43	106.5			31.87	5.5	35.44	162	204	Peak
2492	41.61	39.59	54	-12.39	31.9	5.53	35.41	162	204	Average
2492	55.53	53.51	74	-18.47	31.9	5.53	35.41	162	204	Peak

ANTENNA POLARITY & TEST DISTANCE: VERTICAL AT 3 M

FREQ. (MHz)	EMISSION LEVEL (dBuV/m)	READ LEVEL (dBuV)	LIMIT (dBuV/m)	MARGIN (dB)	ANTENNA FACTOR (dB/m)	CABLE LOSS (dB)	PREAMP FACTOR (dB)	ANTENNA HEIGHT (cm)	TABLE ANGLE (Degree)	REMARK
2388	40.61	38.9	54	-13.39	31.8	5.4	35.49	140	167	Average
2388	56.27	54.56	74	-17.73	31.8	5.4	35.49	140	167	Peak
2462	109.44	107.51			31.87	5.5	35.44	140	167	Average
2462	111.97	110.04			31.87	5.5	35.44	140	167	Peak
2484	44.51	42.55	54	-9.49	31.88	5.5	35.42	140	167	Average
2484	57.44	55.48	74	-16.56	31.88	5.5	35.42	140	167	Peak

REMARKS:

- Emission Level = Read Level + Antenna Factor + Cable Loss - Preamp Factor
Margin value = Emission level – Limit value
- 2462MHz: Fundamental frequency.



A D T

802.11g

EUT TEST CONDITION		MEASUREMENT DETAIL	
CHANNEL	Channel 1	FREQUENCY RANGE	1GHz ~ 25GHz
INPUT POWER	120Vac, 60 Hz	DETECTOR FUNCTION	Peak (PK) Average (AV)
ENVIRONMENTAL CONDITIONS	25deg. C, 65%RH	TESTED BY	Will Chen

ANTENNA POLARITY & TEST DISTANCE: HORIZONTAL AT 3 M

FREQ. (MHz)	EMISSION LEVEL (dBuV/m)	READ LEVEL (dBuV)	LIMIT (dBuV/m)	MARGIN (dB)	ANTENNA FACTOR (dB/m)	CABLE LOSS (dB)	PREAMP FACTOR (dB)	ANTENNA HEIGHT (cm)	TABLE ANGLE (Degree)	REMARK
2390	46.11	44.38	54	-7.89	31.8	5.4	35.47	182	209	Average
2390	59.54	57.81	74	-14.46	31.8	5.4	35.47	182	209	Peak
2412	96.38	94.61			31.81	5.43	35.47	182	209	Average
2412	103.58	101.81			31.81	5.43	35.47	182	209	Peak
2488	40.92	38.91	54	-13.08	31.9	5.53	35.42	182	209	Average
2488	55.59	53.58	74	-18.41	31.9	5.53	35.42	182	209	Peak

ANTENNA POLARITY & TEST DISTANCE: VERTICAL AT 3 M

FREQ. (MHz)	EMISSION LEVEL (dBuV/m)	READ LEVEL (dBuV)	LIMIT (dBuV/m)	MARGIN (dB)	ANTENNA FACTOR (dB/m)	CABLE LOSS (dB)	PREAMP FACTOR (dB)	ANTENNA HEIGHT (cm)	TABLE ANGLE (Degree)	REMARK
2390	52.22	50.49	54	-1.78	31.8	5.4	35.47	126	150	Average
2390	67.16	65.43	74	-6.84	31.8	5.4	35.47	126	150	Peak
2412	99.62	97.85			31.81	5.43	35.47	126	150	Average
2412	106.82	105.05			31.81	5.43	35.47	126	150	Peak
2488	40.72	38.71	54	-13.28	31.9	5.53	35.42	126	150	Average
2488	55.64	53.63	74	-18.36	31.9	5.53	35.42	126	150	Peak

REMARKS:

- Emission Level = Read Level + Antenna Factor + Cable Loss - Preamp Factor
Margin value = Emission level – Limit value
- 2412MHz: Fundamental frequency.



A D T

EUT TEST CONDITION		MEASUREMENT DETAIL	
CHANNEL	Channel 6	FREQUENCY RANGE	1GHz ~ 25GHz
INPUT POWER	120Vac, 60 Hz	DETECTOR FUNCTION	Peak (PK) Average (AV)
ENVIRONMENTAL CONDITIONS	25deg. C, 65%RH	TESTED BY	Will Chen

ANTENNA POLARITY & TEST DISTANCE: HORIZONTAL AT 3 M

FREQ. (MHz)	EMISSION LEVEL (dBuV/m)	READ LEVEL (dBuV)	LIMIT (dBuV/m)	MARGIN (dB)	ANTENNA FACTOR (dB/m)	CABLE LOSS (dB)	PREAMP FACTOR (dB)	ANTENNA HEIGHT (cm)	TABLE ANGLE (Degree)	REMARK
2388	41.01	39.3	54	-12.99	31.8	5.4	35.49	163	209	Average
2388	55.53	53.82	74	-18.47	31.8	5.4	35.49	163	209	Peak
2437	99.91	98.06			31.85	5.46	35.46	163	209	Average
2437	107.74	105.89			31.85	5.46	35.46	163	209	Peak
2486	40.73	38.74	54	-13.27	31.88	5.53	35.42	163	209	Average
2486	55.35	53.36	74	-18.65	31.88	5.53	35.42	163	209	Peak

ANTENNA POLARITY & TEST DISTANCE: VERTICAL AT 3 M

FREQ. (MHz)	EMISSION LEVEL (dBuV/m)	READ LEVEL (dBuV)	LIMIT (dBuV/m)	MARGIN (dB)	ANTENNA FACTOR (dB/m)	CABLE LOSS (dB)	PREAMP FACTOR (dB)	ANTENNA HEIGHT (cm)	TABLE ANGLE (Degree)	REMARK
2390	41.26	39.53	54	-12.74	31.8	5.4	35.47	140	151	Average
2390	55.5	53.77	74	-18.5	31.8	5.4	35.47	140	151	Peak
2437	102.53	100.68			31.85	5.46	35.46	140	151	Average
2437	110.26	108.41			31.85	5.46	35.46	140	151	Peak
2484	40.89	38.93	54	-13.11	31.88	5.5	35.42	140	151	Average
2484	55.41	53.45	74	-18.59	31.88	5.5	35.42	140	151	Peak

REMARKS:

- Emission Level = Read Level + Antenna Factor + Cable Loss - Preamp Factor
Margin value = Emission level – Limit value
- 2437MHz: Fundamental frequency.



A D T

EUT TEST CONDITION		MEASUREMENT DETAIL	
CHANNEL	Channel 11	FREQUENCY RANGE	1GHz ~ 25GHz
INPUT POWER	120Vac, 60 Hz	DETECTOR FUNCTION	Peak (PK) Average (AV)
ENVIRONMENTAL CONDITIONS	25deg. C, 65%RH	TESTED BY	Will Chen

ANTENNA POLARITY & TEST DISTANCE: HORIZONTAL AT 3 M

FREQ. (MHz)	EMISSION LEVEL (dBuV/m)	READ LEVEL (dBuV)	LIMIT (dBuV/m)	MARGIN (dB)	ANTENNA FACTOR (dB/m)	CABLE LOSS (dB)	PREAMP FACTOR (dB)	ANTENNA HEIGHT (cm)	TABLE ANGLE (Degree)	REMARK
2356	40.34	38.71	54	-13.66	31.76	5.37	35.5	160	183	Average
2356	55.34	53.71	74	-18.66	31.76	5.37	35.5	160	183	Peak
2462	97.32	95.39			31.87	5.5	35.44	160	183	Average
2462	105.23	103.3			31.87	5.5	35.44	160	183	Peak
2483.5	45.9	43.94	54	-8.1	31.88	5.5	35.42	160	183	Average
2483.5	63.99	62.03	74	-10.01	31.88	5.5	35.42	160	183	Peak

ANTENNA POLARITY & TEST DISTANCE: VERTICAL AT 3 M

FREQ. (MHz)	EMISSION LEVEL (dBuV/m)	READ LEVEL (dBuV)	LIMIT (dBuV/m)	MARGIN (dB)	ANTENNA FACTOR (dB/m)	CABLE LOSS (dB)	PREAMP FACTOR (dB)	ANTENNA HEIGHT (cm)	TABLE ANGLE (Degree)	REMARK
2370	40.47	38.81	54	-13.53	31.78	5.37	35.49	123	143	Average
2370	55.1	53.44	74	-18.9	31.78	5.37	35.49	123	143	Peak
2462	100.35	98.42			31.87	5.5	35.44	123	143	Average
2462	108.1	106.17			31.87	5.5	35.44	123	143	Peak
2483.5	52.84	50.88	54	-1.16	31.88	5.5	35.42	123	143	Average
2483.5	70.85	68.89	74	-3.15	31.88	5.5	35.42	123	143	Peak

REMARKS:

- Emission Level = Read Level + Antenna Factor + Cable Loss - Preamp Factor
Margin value = Emission level – Limit value
- 2462MHz: Fundamental frequency.



A D T

802.11n (20MHz)

EUT TEST CONDITION		MEASUREMENT DETAIL	
CHANNEL	Channel 1	FREQUENCY RANGE	1GHz ~ 25GHz
INPUT POWER	120Vac, 60 Hz	DETECTOR FUNCTION	Peak (PK) Average (AV)
ENVIRONMENTAL CONDITIONS	25deg. C, 65%RH	TESTED BY	Will Chen

ANTENNA POLARITY & TEST DISTANCE: HORIZONTAL AT 3 M

FREQ. (MHz)	EMISSION LEVEL (dBuV/m)	READ LEVEL (dBuV)	LIMIT (dBuV/m)	MARGIN (dB)	ANTENNA FACTOR (dB/m)	CABLE LOSS (dB)	PREAMP FACTOR (dB)	ANTENNA HEIGHT (cm)	TABLE ANGLE (Degree)	REMARK
2390	46.41	44.68	54	-7.59	31.8	5.4	35.47	182	210	Average
2390	58.12	56.39	74	-15.88	31.8	5.4	35.47	182	210	Peak
2412	95.42	93.65			31.81	5.43	35.47	182	210	Average
2412	103.36	101.59			31.81	5.43	35.47	182	210	Peak
2484	40.72	38.76	54	-13.28	31.88	5.5	35.42	182	210	Average
2484	55.59	53.63	74	-18.41	31.88	5.5	35.42	182	210	Peak

ANTENNA POLARITY & TEST DISTANCE: VERTICAL AT 3 M

FREQ. (MHz)	EMISSION LEVEL (dBuV/m)	READ LEVEL (dBuV)	LIMIT (dBuV/m)	MARGIN (dB)	ANTENNA FACTOR (dB/m)	CABLE LOSS (dB)	PREAMP FACTOR (dB)	ANTENNA HEIGHT (cm)	TABLE ANGLE (Degree)	REMARK
2390	52.97	51.24	54	-1.03	31.8	5.4	35.47	126	150	Average
2390	68.75	67.02	74	-5.25	31.8	5.4	35.47	126	150	Peak
2412	99.43	97.66			31.81	5.43	35.47	126	150	Average
2412	106.66	104.89			31.81	5.43	35.47	126	150	Peak
2486	40.24	38.25	54	-13.76	31.88	5.53	35.42	126	150	Average
2486	55.56	53.57	74	-18.44	31.88	5.53	35.42	126	150	Peak

REMARKS:

- Emission Level = Read Level + Antenna Factor + Cable Loss - Preamp Factor
Margin value = Emission level – Limit value
- 2412MHz: Fundamental frequency.



A D T

EUT TEST CONDITION		MEASUREMENT DETAIL	
CHANNEL	Channel 6	FREQUENCY RANGE	1GHz ~ 25GHz
INPUT POWER	120Vac, 60 Hz	DETECTOR FUNCTION	Peak (PK) Average (AV)
ENVIRONMENTAL CONDITIONS	25deg. C, 65%RH	TESTED BY	Will Chen

ANTENNA POLARITY & TEST DISTANCE: HORIZONTAL AT 3 M

FREQ. (MHz)	EMISSION LEVEL (dBuV/m)	READ LEVEL (dBuV)	LIMIT (dBuV/m)	MARGIN (dB)	ANTENNA FACTOR (dB/m)	CABLE LOSS (dB)	PREAMP FACTOR (dB)	ANTENNA HEIGHT (cm)	TABLE ANGLE (Degree)	REMARK
2382	41.2	39.51	54	-12.8	31.78	5.4	35.49	163	209	Average
2382	55.99	54.3	74	-18.01	31.78	5.4	35.49	163	209	Peak
2437	99.84	97.99			31.85	5.46	35.46	163	209	Average
2437	107.51	105.66			31.85	5.46	35.46	163	209	Peak
2488	40.87	38.86	54	-13.13	31.9	5.53	35.42	163	209	Average
2488	54.68	52.67	74	-19.32	31.9	5.53	35.42	163	209	Peak

ANTENNA POLARITY & TEST DISTANCE: VERTICAL AT 3 M

FREQ. (MHz)	EMISSION LEVEL (dBuV/m)	READ LEVEL (dBuV)	LIMIT (dBuV/m)	MARGIN (dB)	ANTENNA FACTOR (dB/m)	CABLE LOSS (dB)	PREAMP FACTOR (dB)	ANTENNA HEIGHT (cm)	TABLE ANGLE (Degree)	REMARK
2340	41.59	40.02	54	-12.41	31.74	5.33	35.5	140	151	Average
2340	55.98	54.41	74	-18.02	31.74	5.33	35.5	140	151	Peak
2437	102.83	100.98			31.85	5.46	35.46	140	151	Average
2437	110.2	108.35			31.85	5.46	35.46	140	151	Peak
2494	41.01	38.99	54	-12.99	31.9	5.53	35.41	140	151	Average
2494	55.05	53.03	74	-18.95	31.9	5.53	35.41	140	151	Peak

REMARKS:

- Emission Level = Read Level + Antenna Factor + Cable Loss - Preamp Factor
Margin value = Emission level – Limit value
- 2437MHz: Fundamental frequency.



A D T

EUT TEST CONDITION		MEASUREMENT DETAIL	
CHANNEL	Channel 11	FREQUENCY RANGE	1GHz ~ 25GHz
INPUT POWER	120Vac, 60 Hz	DETECTOR FUNCTION	Peak (PK) Average (AV)
ENVIRONMENTAL CONDITIONS	25deg. C, 65%RH	TESTED BY	Will Chen

ANTENNA POLARITY & TEST DISTANCE: HORIZONTAL AT 3 M

FREQ. (MHz)	EMISSION LEVEL (dBuV/m)	READ LEVEL (dBuV)	LIMIT (dBuV/m)	MARGIN (dB)	ANTENNA FACTOR (dB/m)	CABLE LOSS (dB)	PREAMP FACTOR (dB)	ANTENNA HEIGHT (cm)	TABLE ANGLE (Degree)	REMARK
2322	39.26	37.75	54	-14.74	31.73	5.3	35.52	160	183	Average
2322	56.14	54.63	74	-17.86	31.73	5.3	35.52	160	183	Peak
2462	96.89	94.96			31.87	5.5	35.44	160	183	Average
2462	104.72	102.79			31.87	5.5	35.44	160	183	Peak
2483.5	45.95	43.99	54	-8.05	31.88	5.5	35.42	160	183	Average
2483.5	60.86	58.9	74	-13.14	31.88	5.5	35.42	160	183	Peak

ANTENNA POLARITY & TEST DISTANCE: VERTICAL AT 3 M

FREQ. (MHz)	EMISSION LEVEL (dBuV/m)	READ LEVEL (dBuV)	LIMIT (dBuV/m)	MARGIN (dB)	ANTENNA FACTOR (dB/m)	CABLE LOSS (dB)	PREAMP FACTOR (dB)	ANTENNA HEIGHT (cm)	TABLE ANGLE (Degree)	REMARK
2390	40.31	38.58	54	-13.69	31.8	5.4	35.47	124	142	Average
2390	55.46	53.73	74	-18.54	31.8	5.4	35.47	124	142	Peak
2462	99.59	97.66			31.87	5.5	35.44	124	142	Average
2462	107.27	105.34			31.87	5.5	35.44	124	142	Peak
2483.5	52.69	50.73	54	-1.31	31.88	5.5	35.42	124	142	Average
2483.5	70.18	68.22	74	-3.82	31.88	5.5	35.42	124	142	Peak

REMARKS:

- Emission Level = Read Level + Antenna Factor + Cable Loss - Preamp Factor
Margin value = Emission level – Limit value
- 2462MHz: Fundamental frequency.



A D T

MODE B

802.11n (20MHz)

EUT TEST CONDITION		MEASUREMENT DETAIL	
CHANNEL	Channel 1	FREQUENCY RANGE	1GHz ~ 25GHz
INPUT POWER	120Vac, 60 Hz	DETECTOR FUNCTION	Peak (PK) Average (AV)
ENVIRONMENTAL CONDITIONS	25deg. C, 65%RH	TESTED BY	Will Chen

ANTENNA POLARITY & TEST DISTANCE: HORIZONTAL AT 3 M

FREQ. (MHz)	EMISSION LEVEL (dBuV/m)	READ LEVEL (dBuV)	LIMIT (dBuV/m)	MARGIN (dB)	ANTENNA FACTOR (dB/m)	CABLE LOSS (dB)	PREAMP FACTOR (dB)	ANTENNA HEIGHT (cm)	TABLE ANGLE (Degree)	REMARK
2390	49.47	47.74	54	-4.53	31.8	5.4	35.47	180	346	Average
2390	67.94	66.21	74	-6.06	31.8	5.4	35.47	180	346	Peak
2412	96.35	94.58			31.81	5.43	35.47	180	346	Average
2412	103.83	102.06			31.81	5.43	35.47	180	346	Peak
2496	40.82	38.8	54	-13.18	31.9	5.53	35.41	180	346	Average
2496	56.2	54.18	74	-17.8	31.9	5.53	35.41	180	346	Peak

ANTENNA POLARITY & TEST DISTANCE: VERTICAL AT 3 M

FREQ. (MHz)	EMISSION LEVEL (dBuV/m)	READ LEVEL (dBuV)	LIMIT (dBuV/m)	MARGIN (dB)	ANTENNA FACTOR (dB/m)	CABLE LOSS (dB)	PREAMP FACTOR (dB)	ANTENNA HEIGHT (cm)	TABLE ANGLE (Degree)	REMARK
2390	50.78	49.05	54	-3.22	31.8	5.4	35.47	110	142	Average
2390	69.24	67.51	74	-4.76	31.8	5.4	35.47	110	142	Peak
2412	98.15	96.38			31.81	5.43	35.47	110	142	Average
2412	106.12	104.35			31.81	5.43	35.47	110	142	Peak
2498	40.7	38.68	54	-13.3	31.9	5.53	35.41	110	142	Average
2498	55.57	53.55	74	-18.43	31.9	5.53	35.41	110	142	Peak

REMARKS:

- Emission Level = Read Level + Antenna Factor + Cable Loss - Preamp Factor
Margin value = Emission level – Limit value
- 2412MHz: Fundamental frequency.



A D T

BELOW 1GHz WORST-CASE DATA:

MODE A

802.11n (20MHz)

EUT TEST CONDITION		MEASUREMENT DETAIL	
CHANNEL	Channel 1	FREQUENCY RANGE	30MHz ~ 1GHz
INPUT POWER	120Vac, 60 Hz	DETECTOR FUNCTION	Peak (PK) Average (AV)
ENVIRONMENTAL CONDITIONS	25deg. C, 65%RH	TESTED BY	Will Chen

ANTENNA POLARITY & TEST DISTANCE: HORIZONTAL AT 3 M										
FREQ. (MHz)	EMISSION LEVEL (dBuV/m)	READ LEVEL (dBuV)	LIMIT (dBuV/m)	MARGIN (dB)	ANTENNA FACTOR (dB/m)	CABLE LOSS (dB)	PREAMP FACTOR (dB)	ANTENNA HEIGHT (cm)	TABLE ANGLE (Degree)	REMARK
101.28	27.02	45.69	43.5	-16.48	12.31	1.28	32.26	184	194	Peak
140.16	26.19	48.66	43.5	-17.31	8.42	1.38	32.27	173	63	Peak
216.3	26.31	45.62	46	-19.69	11.27	1.65	32.23	121	317	Peak
384	23.35	38.52	46	-22.65	14.67	2.34	32.18	175	218	Peak
683.6	20.37	30.44	46	-25.63	18.99	3.05	32.11	131	353	Peak
888	23.14	29.82	46	-22.86	21.39	3.49	31.56	197	225	Peak
ANTENNA POLARITY & TEST DISTANCE: VERTICAL AT 3 M										
FREQ. (MHz)	EMISSION LEVEL (dBuV/m)	READ LEVEL (dBuV)	LIMIT (dBuV/m)	MARGIN (dB)	ANTENNA FACTOR (dB/m)	CABLE LOSS (dB)	PREAMP FACTOR (dB)	ANTENNA HEIGHT (cm)	TABLE ANGLE (Degree)	REMARK
30	35.63	55.6	40	-4.37	11.56	0.74	32.27	134	273	Peak
47.55	33.11	49.92	40	-6.89	14.51	0.9	32.22	185	258	Peak
81.03	23.03	45.67	40	-16.97	8.41	1.11	32.16	117	97	Peak
384	19.43	34.6	46	-26.57	14.67	2.34	32.18	109	152	Peak
697.6	20.74	30.52	46	-25.26	19.2	3.11	32.09	126	313	Peak
919.5	23.43	29.68	46	-22.57	21.56	3.53	31.34	107	234	Peak

REMARKS: Emission Level = Read Level + Antenna Factor + Cable Loss - Preamp Factor

Margin value = Emission level – Limit value



A D T

MODE B

802.11n (20MHz)

EUT TEST CONDITION		MEASUREMENT DETAIL	
CHANNEL	Channel 1	FREQUENCY RANGE	30MHz ~ 1GHz
INPUT POWER	120Vac, 60 Hz	DETECTOR FUNCTION	Peak (PK) Average (AV)
ENVIRONMENTAL CONDITIONS	25deg. C, 65%RH	TESTED BY	Will Chen

ANTENNA POLARITY & TEST DISTANCE: HORIZONTAL AT 3 M

FREQ. (MHz)	EMISSION LEVEL (dBuV/m)	READ LEVEL (dBuV)	LIMIT (dBuV/m)	MARGIN (dB)	ANTENNA FACTOR (dB/m)	CABLE LOSS (dB)	PREAMP FACTOR (dB)	ANTENNA HEIGHT (cm)	TABLE ANGLE (Degree)	REMARK
103.17	31.03	49.65	43.5	-12.47	12.36	1.28	32.26	119	49	Peak
143.13	27.37	49.87	43.5	-16.13	8.39	1.38	32.27	159	168	Peak
214.95	29.43	48.77	43.5	-14.07	11.25	1.65	32.24	151	136	Peak
384	28.53	43.7	46	-17.47	14.67	2.34	32.18	139	182	Peak
708.8	20.86	30.49	46	-25.14	19.36	3.11	32.1	169	296	Peak
970.6	24.27	29.44	54	-29.73	21.92	3.67	30.76	183	294	Peak

ANTENNA POLARITY & TEST DISTANCE: VERTICAL AT 3 M

FREQ. (MHz)	EMISSION LEVEL (dBuV/m)	READ LEVEL (dBuV)	LIMIT (dBuV/m)	MARGIN (dB)	ANTENNA FACTOR (dB/m)	CABLE LOSS (dB)	PREAMP FACTOR (dB)	ANTENNA HEIGHT (cm)	TABLE ANGLE (Degree)	REMARK
32.16	36.02	55.88	40	-3.98	11.66	0.74	32.26	186	306	Peak
46.47	36.26	53.12	40	-3.74	14.46	0.9	32.22	102	118	Peak
103.44	25.56	44.15	43.5	-17.94	12.39	1.28	32.26	107	347	Peak
384	20	35.17	46	-26	14.67	2.34	32.18	172	264	Peak
712.3	22.04	31.63	46	-23.96	19.4	3.11	32.1	119	7	Peak
906.9	23.42	29.83	46	-22.58	21.49	3.53	31.43	198	72	Peak

REMARKS: Emission Level = Read Level + Antenna Factor + Cable Loss - Preamp Factor

Margin value = Emission level – Limit value



4.2 CONDUCTED EMISSION MEASUREMENT

4.2.1 LIMITS OF CONDUCTED EMISSION MEASUREMENT

FREQUENCY OF EMISSION (MHz)	CONDUCTED LIMIT (dB μ V)	
	Quasi-peak	Average
0.15 ~ 0.5	66 to 56	56 to 46
0.5 ~ 5	56	46
5 ~ 30	60	50

- NOTE:**
1. The lower limit shall apply at the transition frequencies.
 2. The limit decreases in line with the logarithm of the frequency in the range of 0.15 to 0.50MHz.
 3. All emanations from a class A/B digital device or system, including any network of conductors and apparatus connected thereto, shall not exceed the level of field strengths specified above.

4.2.2 TEST INSTRUMENTS

DESCRIPTION & MANUFACTURER	MODEL NO.	SERIAL NO.	DATE OF CALIBRATION	DUE DATE OF CALIBRATION
Test Receiver ROHDE & SCHWARZ	ESCI	100613	Nov. 11, 2014	Nov. 10, 2015
RF signal cable Woken	5D-FB	Cable-HYC01-01	Dec. 26, 2014	Dec. 25, 2015
LISN ROHDE & SCHWARZ (EUT)	ESH3-Z5	835239/001	Mar. 02, 2015	Mar. 01, 2016
LISN ROHDE & SCHWARZ (Peripheral)	ESH3-Z5	100311	Jul. 21, 2014	Jul. 20, 2015
Software ADT	BV ADT_Cond_ V7.3.7.3	NA	NA	NA

- NOTE:**
1. The calibration interval of the above test instruments is 12 months and the calibrations are traceable to NML/ROC and NIST/USA.
 2. The test was performed in HwaYa Shielded Room 1.
 3. The VCCI Site Registration No. is C-2040.



A D T

4.2.3 TEST PROCEDURES

- a. The EUT was placed 0.4 meters from the conducting wall of the shielded room with EUT being connected to the power mains through a line impedance stabilization network (LISN). Other support units were connected to the power mains through another LISN. The two LISNs provide 50 ohm/ 50uH of coupling impedance for the measuring instrument.
- b. Both lines of the power mains connected to the EUT were checked for maximum conducted interference.
- c. The frequency range from 150kHz to 30MHz was searched. Emission levels under (Limit - 20dB) was not recorded.

NOTE: All modes of operation were investigated and the worst-case emissions are reported.

4.2.4 DEVIATION FROM TEST STANDARD

No deviation.

4.2.5 TEST SETUP

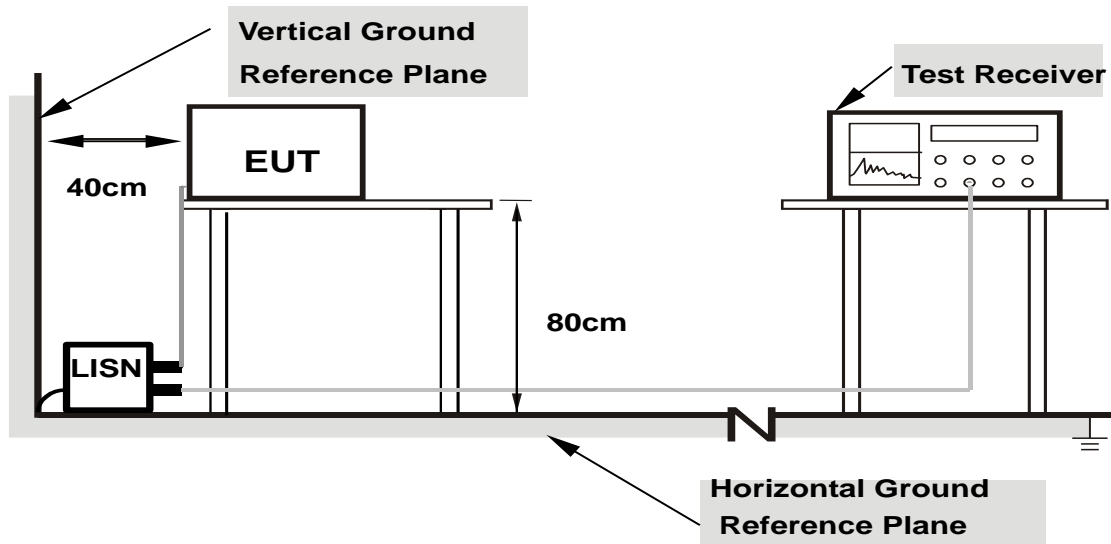

- Note: 1.Support units were connected to second LISN.**
2.Both of LISNs (AMN) are 80 cm from EUT and at least 80 from other units and other metal planes

For the actual test configuration, please refer to the attached file (Test Setup Photo).

4.2.6 EUT OPERATING CONDITIONS

Same as section 4.1.6.



A D T

4.2.7 TEST RESULTS

CONDUCTED WORST-CASE DATA :

MODE A

Frequency Range	150kHz ~ 30MHz	Detector Function & Resolution Bandwidth	Quasi-Peak (QP) / Average (AV), 9kHz
Input Power	120Vac, 60Hz	Environmental Conditions	25°C, 65%RH
Tested by	Toby Tien	Test Date	2015/4/24

Phase Of Power : Line (L)										
No	Frequency (MHz)	Correction Factor (dB)	Reading Value (dBuV)		Emission Level (dBuV)		Limit (dBuV)		Margin (dB)	
			Q.P.	AV.	Q.P.	AV.	Q.P.	AV.	Q.P.	AV.
1	0.15000	0.05	54.31	33.87	54.36	33.92	66.00	56.00	-11.64	-22.08
2	0.19692	0.06	50.91	31.67	50.97	31.73	63.74	53.74	-12.77	-22.01
3	0.39242	0.06	40.63	30.85	40.69	30.91	58.01	48.01	-17.32	-17.10
4	1.03757	0.08	43.16	31.91	43.24	31.99	56.00	46.00	-12.76	-14.01
5	2.04639	0.12	41.94	31.73	42.06	31.85	56.00	46.00	-13.94	-14.15
6	3.16461	0.16	41.89	31.11	42.05	31.27	56.00	46.00	-13.95	-14.73

Remarks:

1. Q.P. and AV. are abbreviations of quasi-peak and average individually.
2. The emission levels of other frequencies were very low against the limit.
3. Margin value = Emission level – Limit value
4. Correction factor = Insertion loss + Cable loss
5. Emission Level = Correction Factor + Reading Value

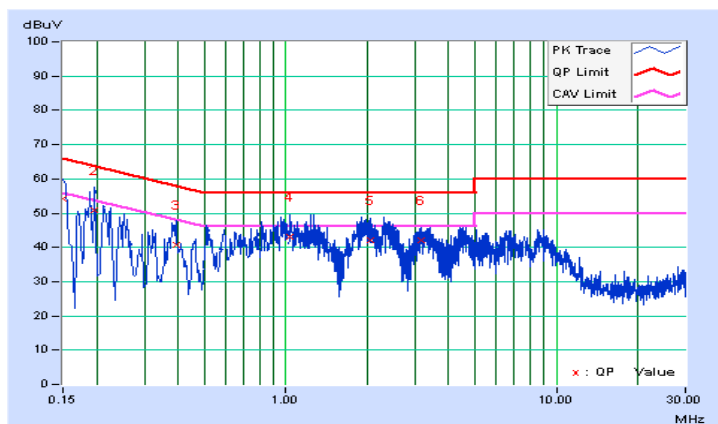



A D T

Frequency Range	150kHz ~ 30MHz	Detector Function & Resolution Bandwidth	Quasi-Peak (QP) / Average (AV), 9kHz
Input Power	120Vac, 60Hz	Environmental Conditions	25°C, 65%RH
Tested by	Toby Tien	Test Date	2015/4/24

Phase Of Power : Neutral (N)										
No	Frequency (MHz)	Correction Factor (dB)	Reading Value (dBuV)		Emission Level (dBuV)		Limit (dBuV)		Margin (dB)	
			Q.P.	AV.	Q.P.	AV.	Q.P.	AV.	Q.P.	AV.
1	0.15000	0.05	51.74	31.65	51.79	31.70	66.00	56.00	-14.21	-24.30
2	0.18122	0.05	45.47	26.35	45.52	26.40	64.43	54.43	-18.91	-28.03
3	0.22024	0.05	42.63	24.27	42.68	24.32	62.81	52.81	-20.13	-28.49
4	0.93982	0.08	39.26	27.65	39.34	27.73	56.00	46.00	-16.66	-18.27
5	2.41780	0.13	38.23	28.39	38.36	28.52	56.00	46.00	-17.64	-17.48
6	3.12942	0.16	37.49	27.46	37.65	27.62	56.00	46.00	-18.35	-18.38

Remarks:

1. Q.P. and AV. are abbreviations of quasi-peak and average individually.
2. The emission levels of other frequencies were very low against the limit.
3. Margin value = Emission level – Limit value
4. Correction factor = Insertion loss + Cable loss
5. Emission Level = Correction Factor + Reading Value

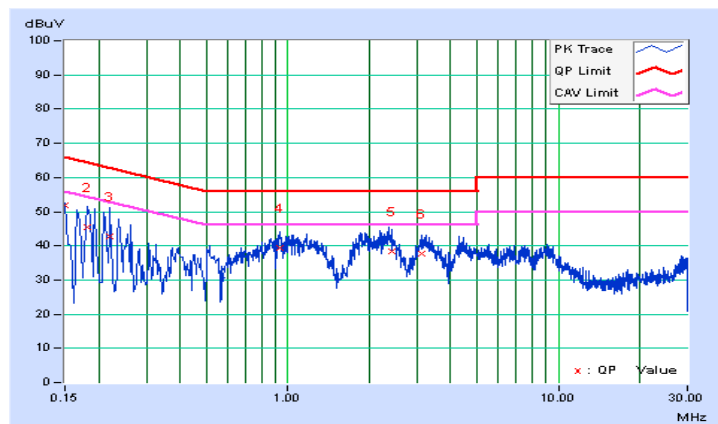



A D T

MODE B

Frequency Range	150kHz ~ 30MHz	Detector Function & Resolution Bandwidth	Quasi-Peak (QP) / Average (AV), 9kHz
Input Power	120Vac, 60Hz	Environmental Conditions	25°C, 65%RH
Tested by	Toby Tian	Test Date	2015/5/9

Phase Of Power : Line (L)										
No	Frequency (MHz)	Correction Factor (dB)	Reading Value (dBuV)		Emission Level (dBuV)		Limit (dBuV)		Margin (dB)	
			Q.P.	AV.	Q.P.	AV.	Q.P.	AV.	Q.P.	AV.
1	0.15000	0.05	52.06	39.18	52.11	39.23	66.00	56.00	-13.89	-16.77
2	0.15782	0.05	49.49	33.77	49.54	33.82	65.58	55.58	-16.04	-21.76
3	0.22851	0.06	44.06	31.66	44.12	31.72	62.50	52.50	-18.38	-20.78
4	1.18224	0.09	41.61	31.80	41.70	31.89	56.00	46.00	-14.30	-14.11
5	2.33569	0.13	42.43	32.14	42.56	32.27	56.00	46.00	-13.44	-13.73
6	3.27097	0.16	40.65	30.58	40.81	30.74	56.00	46.00	-15.19	-15.26

Remarks:

1. Q.P. and AV. are abbreviations of quasi-peak and average individually.
2. The emission levels of other frequencies were very low against the limit.
3. Margin value = Emission level – Limit value
4. Correction factor = Insertion loss + Cable loss
5. Emission Level = Correction Factor + Reading Value

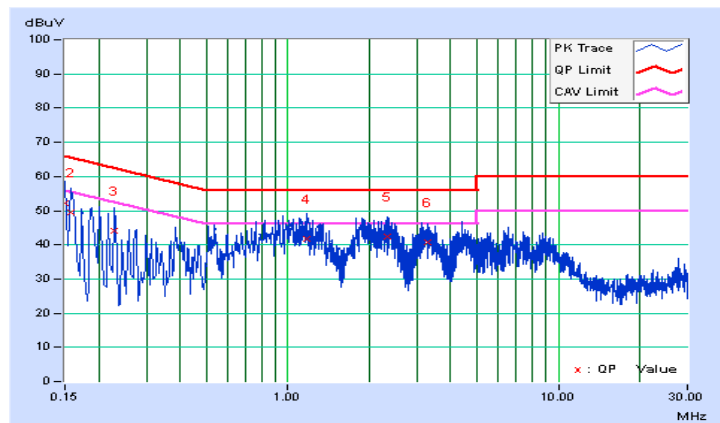



A D T

Frequency Range	150kHz ~ 30MHz	Detector Function & Resolution Bandwidth	Quasi-Peak (QP) / Average (AV), 9kHz
Input Power	120Vac, 60Hz	Environmental Conditions	25°C, 65%RH
Tested by	Toby Tian	Test Date	2015/5/9

Phase Of Power : Neutral (N)										
No	Frequency (MHz)	Correction Factor (dB)	Reading Value (dBuV)		Emission Level (dBuV)		Limit (dBuV)		Margin (dB)	
			Q.P.	AV.	Q.P.	AV.	Q.P.	AV.	Q.P.	AV.
1	0.15391	0.05	48.87	39.07	48.92	39.12	65.79	55.79	-16.87	-16.67
2	0.19717	0.05	45.80	28.31	45.85	28.36	63.73	53.73	-17.88	-25.37
3	0.22820	0.05	40.85	30.92	40.90	30.97	62.51	52.51	-21.61	-21.54
4	0.26765	0.05	36.03	21.05	36.08	21.10	61.19	51.19	-25.11	-30.09
5	0.94764	0.08	37.49	26.32	37.57	26.40	56.00	46.00	-18.43	-19.60
6	1.87040	0.11	37.29	27.15	37.40	27.26	56.00	46.00	-18.60	-18.74

Remarks:

1. Q.P. and AV. are abbreviations of quasi-peak and average individually.
2. The emission levels of other frequencies were very low against the limit.
3. Margin value = Emission level – Limit value
4. Correction factor = Insertion loss + Cable loss
5. Emission Level = Correction Factor + Reading Value

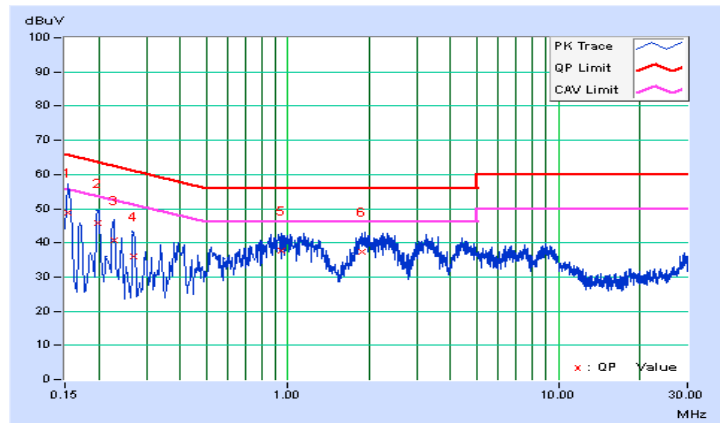

4.3 6dB BANDWIDTH MEASUREMENT

4.3.1 LIMITS OF 6dB BANDWIDTH MEASUREMENT

The minimum of 6dB Bandwidth Measurement is 0.5 MHz.

4.3.2 TEST SETUP

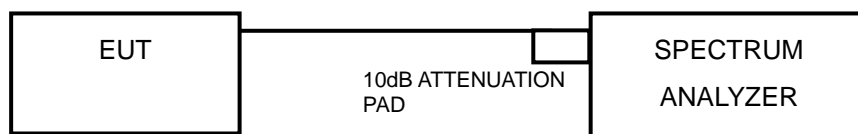

4.3.3 TEST INSTRUMENTS

Refer to section 4.1.2 to get information of above instrument.

4.3.4 TEST PROCEDURE

- Set resolution bandwidth (RBW) = 100kHz
- Set the video bandwidth (VBW) $\geq 3 \times$ RBW, Detector = Peak.
- Trace mode = max hold.
- Sweep = auto couple.
- Measure the maximum width of the emission that is constrained by the frequencies associated with the two amplitude points (upper and lower) that are attenuated by 6 dB relative to the maximum level measured in the fundamental emission

4.3.5 DEVIATION FROM TEST STANDARD

No deviation.

4.3.6 EUT OPERATING CONDITIONS

The software provided by client to enable the EUT under transmission condition continuously at lowest, middle and highest channel frequencies individually.



A D T

4.3.7 TEST RESULTS

802.11b

CHANNEL	FREQUENCY (MHz)	6dB BANDWIDTH (MHz)	MINIMUM LIMIT (MHz)	PASS / FAIL
1	2412	8.09	0.5	PASS
6	2437	8.11	0.5	PASS
11	2462	8.59	0.5	PASS

802.11g

CHANNEL	FREQUENCY (MHz)	6dB BANDWIDTH (MHz)	MINIMUM LIMIT (MHz)	PASS / FAIL
1	2412	16.37	0.5	PASS
6	2437	16.42	0.5	PASS
11	2462	16.13	0.5	PASS

802.11n (20MHz)

CHANNEL	FREQUENCY (MHz)	6dB BANDWIDTH (MHz)	MINIMUM LIMIT (MHz)	PASS / FAIL
1	2412	17.63	0.5	PASS
6	2437	17.64	0.5	PASS
11	2462	17.22	0.5	PASS



A D T

SPECTRUM PLOT OF WORST VALUE

802.11b

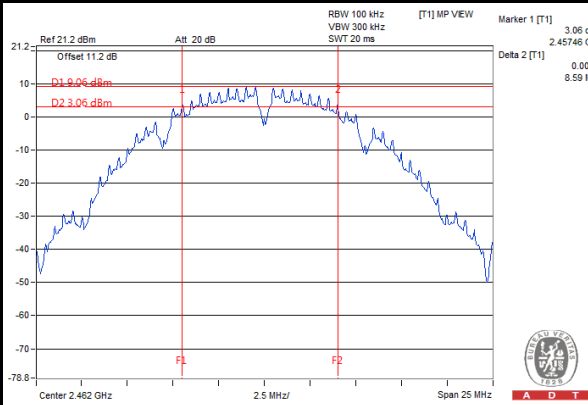

802.11g

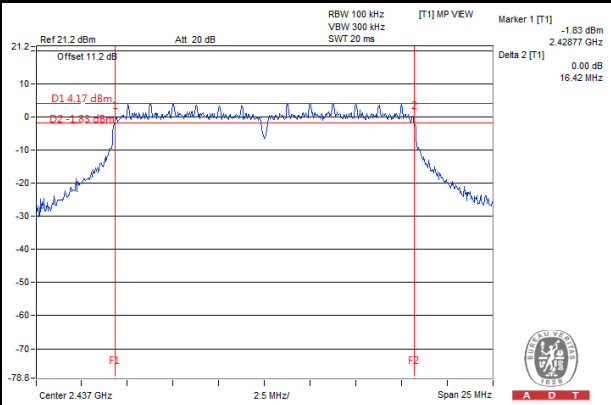

802.11n (20MHz)

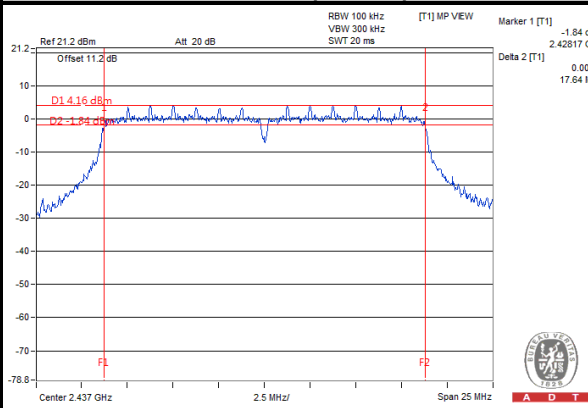

4.4 CONDUCTED OUTPUT POWER

4.4.1 LIMITS OF CONDUCTED OUTPUT POWER MEASUREMENT

For systems using digital modulation in the 2400–2483.5 MHz bands: 1 Watt (30dBm)

4.4.2 TEST SETUP

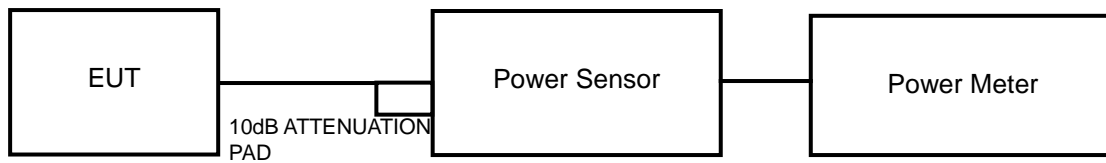

4.4.3 TEST INSTRUMENTS

Refer to section 4.1.2 to get information of above instrument.

4.4.4 TEST PROCEDURES

A peak power sensor was used on the output port of the EUT. A power meter was used to read the response of the peak power sensor. Record the peak power level.

4.4.5 DEVIATION FROM TEST STANDARD

No deviation.

4.4.6 EUT OPERATING CONDITIONS

Same as section 4.3.6.



A D T

4.4.7 TEST RESULTS

802.11b

CHANNEL	FREQUENCY (MHz)	PEAK POWER (mW)	PEAK POWER (dBm)	LIMIT (dBm)	PASS / FAIL
1	2412	108.89	20.37	30	PASS
6	2437	116.95	20.68	30	PASS
11	2462	102.57	20.11	30	PASS

802.11g

CHANNEL	FREQUENCY (MHz)	PEAK POWER (mW)	PEAK POWER (dBm)	LIMIT (dBm)	PASS / FAIL
1	2412	145.55	21.63	30	PASS
6	2437	240.99	23.82	30	PASS
11	2462	152.41	21.83	30	PASS

802.11n (20MHz)

CHANNEL	FREQUENCY (MHz)	PEAK POWER (mW)	PEAK POWER (dBm)	LIMIT (dBm)	PASS / FAIL
1	2412	132.13	21.21	30	PASS
6	2437	243.78	23.87	30	PASS
11	2462	148.94	21.73	30	PASS

4.5 POWER SPECTRAL DENSITY MEASUREMENT

4.5.1 LIMITS OF POWER SPECTRAL DENSITY MEASUREMENT

The Maximum of Power Spectral Density Measurement is 8dBm.

4.5.2 TEST SETUP

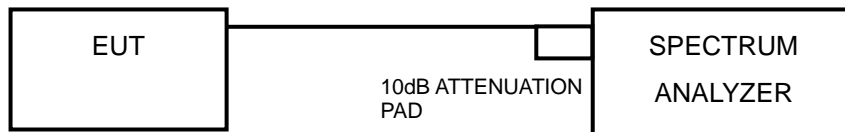

4.5.3 TEST INSTRUMENTS

Refer to section 4.1.2 to get information of above instrument.

4.5.4 TEST PROCEDURE

- Set the RBW = 3 kHz, VBW =10 kHz, Detector = peak.
- Sweep time = auto couple, Trace mode = max hold, allow trace to fully stabilize.
- Use the peak marker function to determine the maximum power level in any 100 kHz band segment within the fundamental EBW.

4.5.5 DEVIATION FROM TEST STANDARD

No deviation.

4.5.6 EUT OPERATING CONDITION

Same as section 4.3.6.



A D T

4.5.7 TEST RESULTS

802.11b

CHANNEL	FREQUENCY (MHz)	PSD (dBm/3kHz)	LIMIT (dBm/3kHz)	PASS / FAIL
1	2412	-5.24	8	PASS
6	2437	-5.51	8	PASS
11	2462	-5.47	8	PASS

802.11g

CHANNEL	FREQUENCY (MHz)	PSD (dBm/3kHz)	LIMIT (dBm/3kHz)	PASS / FAIL
1	2412	-13.88	8	PASS
6	2437	-9.67	8	PASS
11	2462	-11.39	8	PASS

802.11n (20MHz)

CHANNEL	FREQUENCY (MHz)	PSD (dBm/3kHz)	LIMIT (dBm/3kHz)	PASS / FAIL
1	2412	-13.99	8	PASS
6	2437	-8.91	8	PASS
11	2462	-12.98	8	PASS



A D T

SPECTRUM PLOT OF WORST VALUE

802.11b

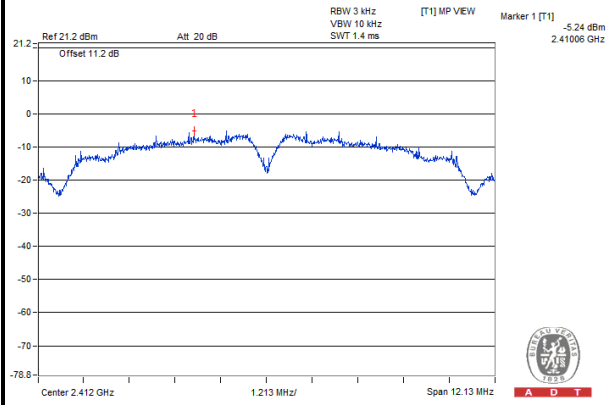

802.11g

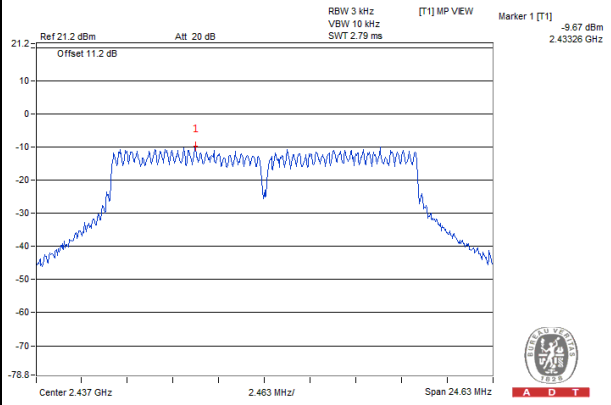

802.11n (20MHz)

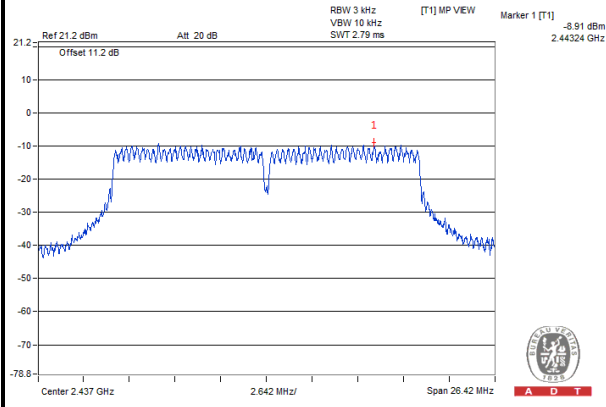

4.6 CONDUCTED OUT OF BAND EMISSION MEASUREMENT

4.6.1 LIMITS OF CONDUCTED OUT OF BAND EMISSION MEASUREMENT

Below -20dB of the highest emission level of operating band (in 100kHz Resolution Bandwidth).

4.6.2 TEST SETUP

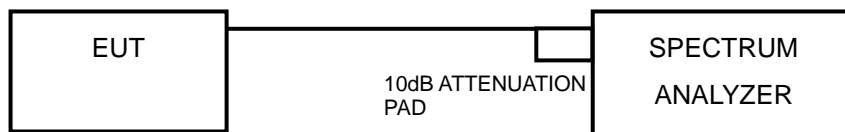

4.6.3 TEST INSTRUMENTS

Refer to section 4.1.2 to get information of above instrument.

4.6.4 TEST PROCEDURE

MEASUREMENT PROCEDURE REF

1. Set the RBW = 100 kHz.
2. Set the VBW \geq 300 kHz.
3. Detector = peak.
4. Sweep time = auto couple.
5. Trace mode = max hold.
6. Allow trace to fully stabilize.
7. Use the peak marker function to determine the maximum power level in any 100 kHz band segment within the fundamental EBW.

MEASUREMENT PROCEDURE OOB

1. Set RBW = 100 kHz.
2. Set VBW \geq 300 kHz.
3. Detector = peak.
4. Sweep = auto couple.
5. Trace Mode = max hold.
6. Allow trace to fully stabilize.
7. Use the peak marker function to determine the maximum amplitude level.

4.6.5 DEVIATION FROM TEST STANDARD

No deviation.

4.6.6 EUT OPERATING CONDITION

Same as section 4.3.6.



A D T

4.6.7 TEST RESULTS

The spectrum plots are attached on the following images. D1 line indicates the highest level, and D2 line indicates the 20dB offset below D1. It shows compliance with the requirement.

802.11b

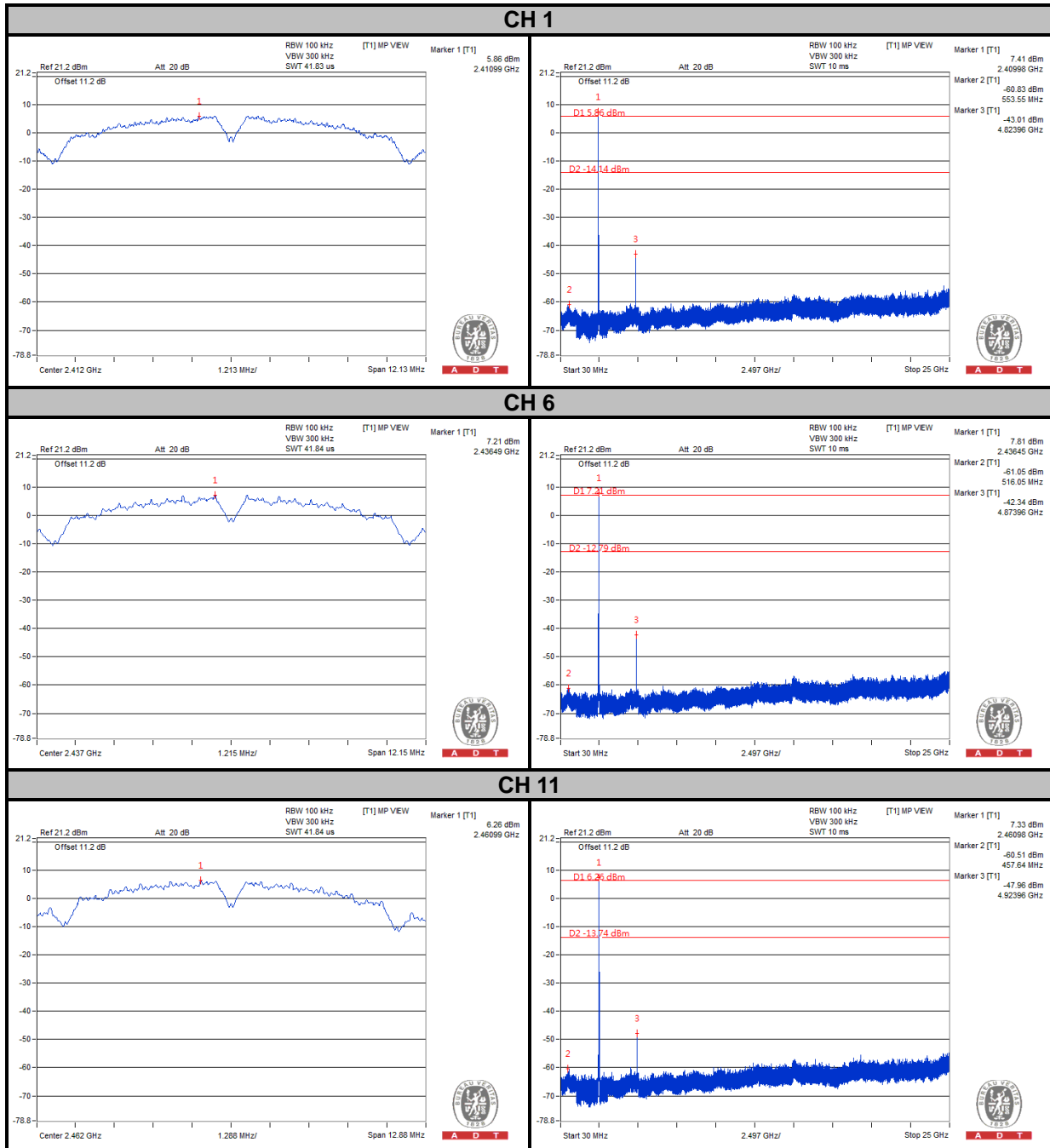



A D T

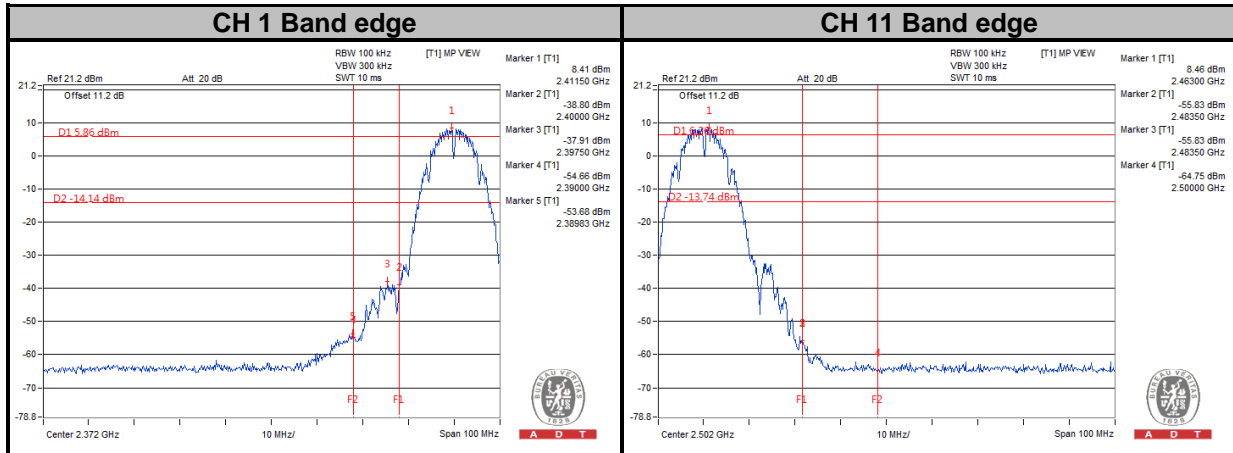



A D T

802.11g

CH 1

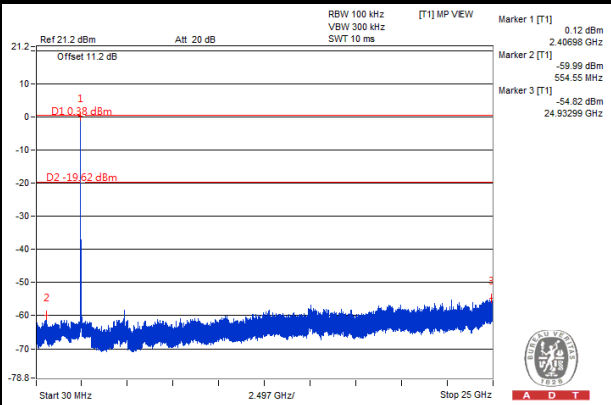
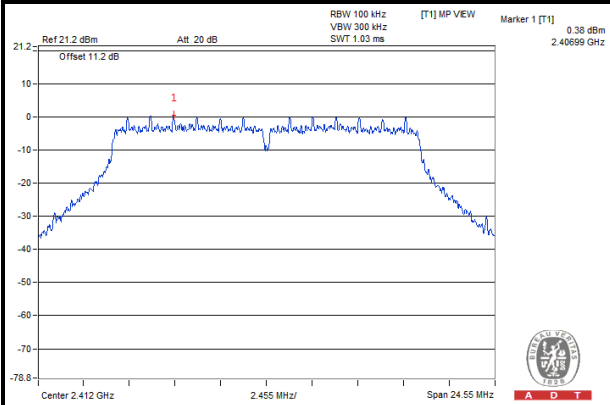

CH 6

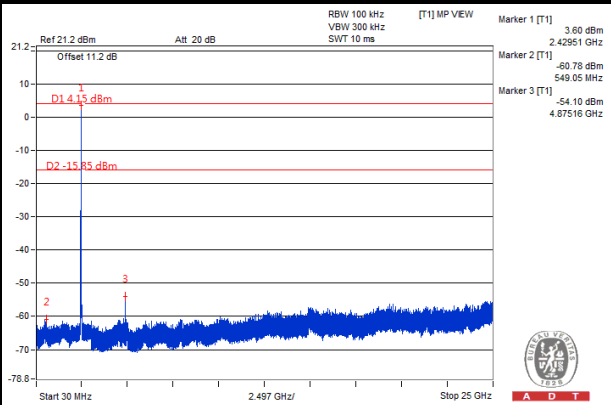
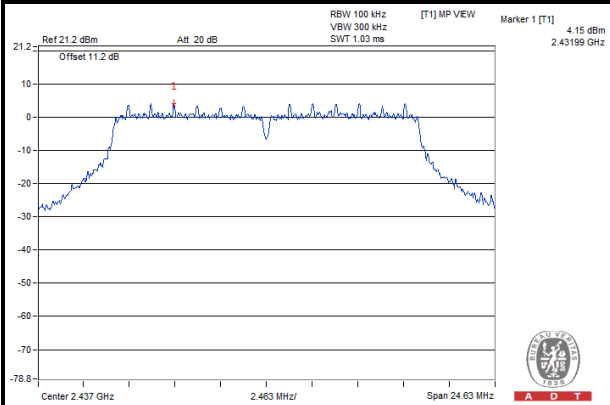

CH 11

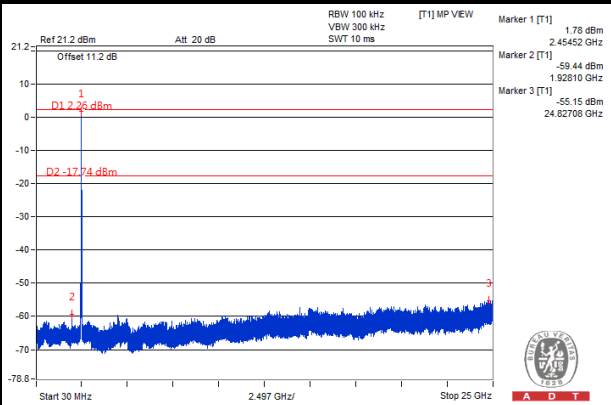
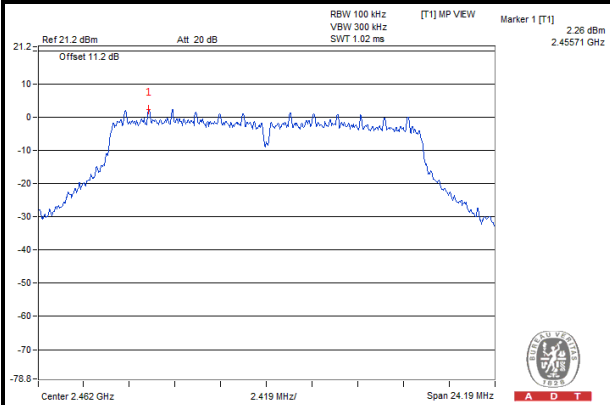



A D T

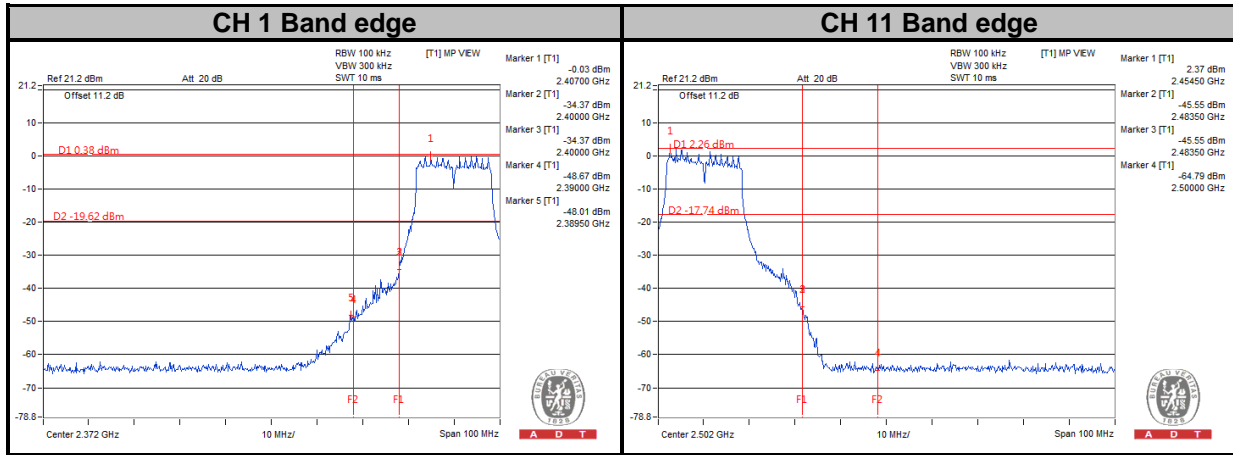



A D T

802.11n (20MHz)

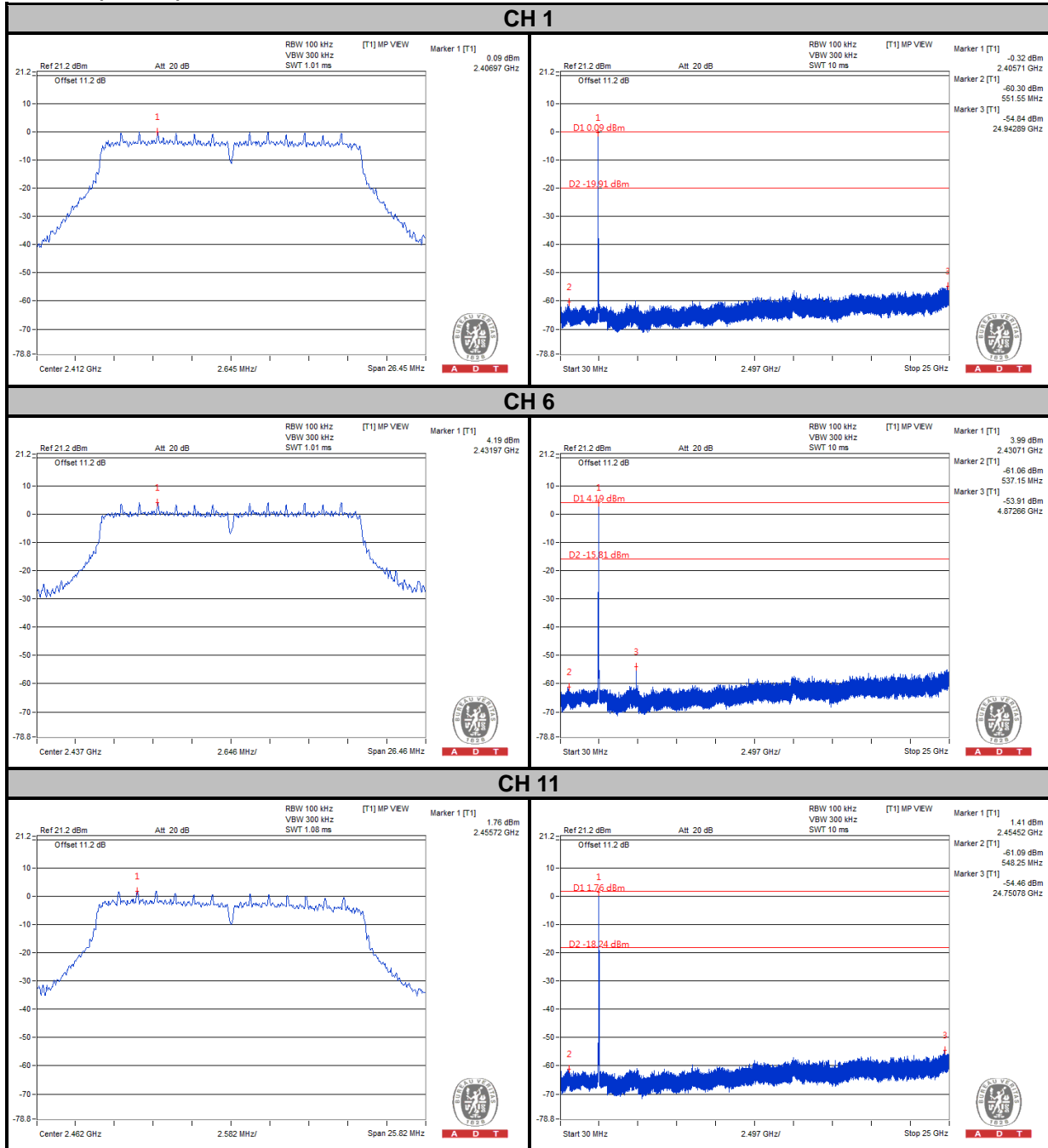



A D T

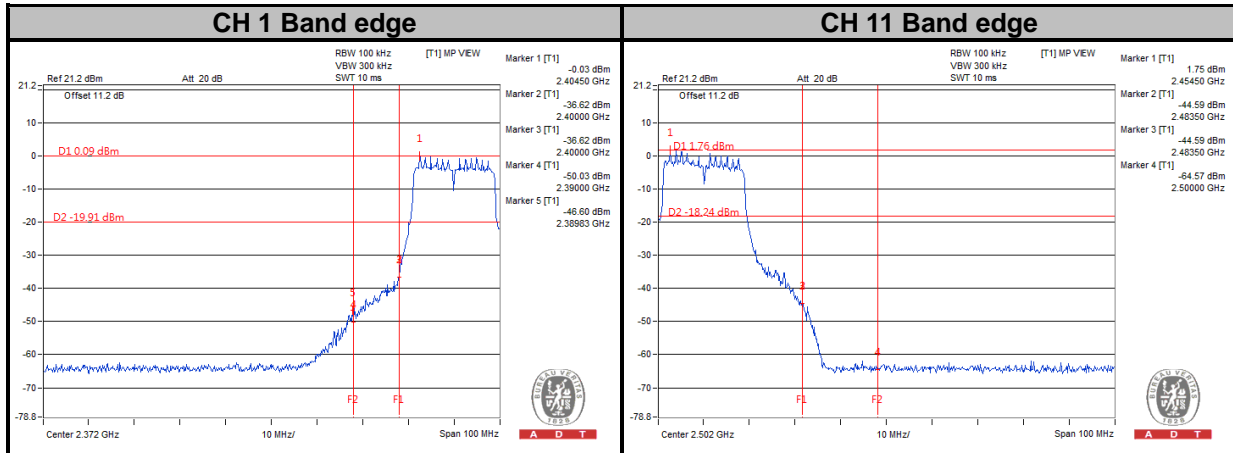



A D T

5. PHOTOGRAPHS OF THE TEST CONFIGURATION

Please refer to the attached file (Test Setup Photo).



6. INFORMATION ON THE TESTING LABORATORIES

We, Bureau Veritas Consumer Products Services (H.K.) Ltd., Taoyuan Branch, were founded in 1988 to provide our best service in EMC, Radio, Telecom and Safety consultation. Our laboratories are accredited and approved according to ISO/IEC 17025.

If you have any comments, please feel free to contact us at the following:

Linko EMC/RF Lab:

Tel: 886-2-26052180

Fax: 886-2-26051924

Hsin Chu EMC/RF/Telecom Lab:

Tel: 886-3-5935343

Fax: 886-3-5935342

Hwa Ya EMC/RF/Safety Lab:

Tel: 886-3-3183232

Fax: 886-3-3270892

Email: service.adt@tw.bureauveritas.com

Web Site: www.bureauveritas-adt.com

The address and road map of all our labs can be found in our web site also.



A D T

7. APPENDIX A – MODIFICATIONS RECORDERS FOR ENGINEERING CHANGES TO THE EUT BY THE LAB

No any modifications are made to the EUT by the lab during the test.

---END---