



A D T

FCC TEST REPORT

REPORT NO.: RF150714C29-5
MODEL NAME: OPM9310
FCC ID: NM80PM9310
RECEIVED: Mar. 24, 2015
TESTED: May 08, 2015 ~ May 15, 2015
ISSUED: Jul. 31, 2015

APPLICANT: HTC Corporation

ADDRESS: 1F, 6-3 Baoqiang Road, Xindian District, New Taipei City, Taiwan 231

ISSUED BY: Bureau Veritas Consumer Products Services (H.K.) Ltd., Taoyuan Branch

LAB ADDRESS: No. 47-2, 14th Ling, Chia Pau Vil., Lin Kou Dist., New Taipei City, Taiwan (R.O.C)

TEST LOCATION: No. 19, Hwa Ya 2nd Rd, Wen Hwa Vil., Kwei Shan Dist., Taoyuan City 333, Taiwan, R.O.C.

This report should not be used by the client to claim product certification, approval, or endorsement by TAF or any government agencies.



This report is for your exclusive use. Any copying or replication of this report to or for any other person or entity, or use of our name or trademark, is permitted only with our prior written permission. This report sets forth our findings solely with respect to the test samples identified herein. The results set forth in this report are not indicative or representative of the quality or characteristics of the lot from which a test sample was taken or any similar or identical product unless specifically and expressly noted. Our report includes all of the tests requested by you and the results thereof based upon the information that you provided to us. You have 60 days from date of issuance of this report to notify us of any material error or omission caused by our negligence, provided, however, that such notice shall be in writing and shall specifically address the issue you wish to raise. A failure to raise such issue within the prescribed time shall constitute your unqualified acceptance of the completeness of this report, the tests conducted and the correctness of the report contents. Unless specific mention, the uncertainty of measurement has been explicitly taken into account to declare the compliance or non-compliance to the specification.



TABLE OF CONTENTS

- RELEASE CONTROL RECORD4
- 1. CERTIFICATION.....5
- 2. SUMMARY OF TEST RESULTS6
 - 2.1 MEASUREMENT UNCERTAINTY.....6
- 3. GENERAL INFORMATION7
 - 3.1 GENERAL DESCRIPTION OF EUT7
 - 3.2 DESCRIPTION OF TEST MODES8
 - 3.2.1 TEST MODE APPLICABILITY AND TESTED CHANNEL DETAIL9
 - 3.3 DESCRIPTION OF SUPPORT UNITS11
 - 3.3.1 CONFIGURATION OF SYSTEM UNDER TEST11
 - 3.4 GENERAL DESCRIPTION OF APPLIED STANDARDS12
- 4. TEST TYPES AND RESULTS (FOR BLUETOOTH EDR)13
 - 4.1 RADIATED EMISSION AND BANDEDGE MEASUREMENT13
 - 4.1.1 LIMITS OF RADIATED EMISSION AND BANDEDGE MEASUREMENT13
 - 4.1.2 TEST INSTRUMENTS14
 - 4.1.3 TEST PROCEDURES15
 - 4.1.4 DEVIATION FROM TEST STANDARD15
 - 4.1.5 TEST SETUP16
 - 4.1.6 EUT OPERATING CONDITIONS16
 - 4.1.7 TEST RESULTS.....17
 - 4.2 CONDUCTED EMISSION MEASUREMENT21
 - 4.2.1 LIMITS OF CONDUCTED EMISSION MEASUREMENT21
 - 4.2.2 TEST INSTRUMENTS21
 - 4.2.3 TEST PROCEDURES22
 - 4.2.4 DEVIATION FROM TEST STANDARD22
 - 4.2.5 TEST SETUP23
 - 4.2.6 EUT OPERATING CONDITIONS23
 - 4.2.7 TEST RESULTS.....24
 - 4.3 NUMBER OF HOPPING FREQUENCY USED26
 - 4.3.1 LIMIT OF HOPPING FREQUENCY USED26
 - 4.3.2 TEST SETUP26
 - 4.3.3 TEST INSTRUMENTS26
 - 4.3.4 TEST PROCEDURE26
 - 4.3.5 DEVIATION FROM TEST STANDARD26
 - 4.3.6 TEST RESULTS.....26
 - 4.4 DWELL TIME ON EACH CHANNEL28
 - 4.4.1 LIMITS OF DWELL TIME USED28
 - 4.4.2 TEST SETUP28
 - 4.4.3 TEST INSTRUMENTS28
 - 4.4.4 TEST PROCEDURES28
 - 4.4.5 DEVIATION FROM TEST STANDARD28
 - 4.4.6 TEST RESULTS.....29
 - 4.5 CHANNEL BANDWIDTH32
 - 4.5.1 LIMITS OF CHANNEL BANDWIDTH32
 - 4.5.2 TEST SETUP32
 - 4.5.3 TEST INSTRUMENTS32
 - 4.5.4 TEST PROCEDURE32
 - 4.5.5 DEVIATION FROM TEST STANDARD32
 - 4.5.6 EUT OPERATING CONDITION32
 - 4.5.7 TEST RESULTS.....33
 - 4.6 HOPPING CHANNEL SEPARATION34
 - 4.6.1 LIMITS OF HOPPING CHANNEL SEPARATION34



4.6.2	TEST SETUP	34
4.6.3	TEST INSTRUMENTS	34
4.6.4	TEST PROCEDURE	34
4.6.5	DEVIATION FROM TEST STANDARD	34
4.6.6	TEST RESULTS.....	35
4.7	MAXIMUM OUTPUT POWER	36
4.7.1	LIMITS OF MAXIMUM OUTPUT POWER MEASUREMENT	36
4.7.2	TEST SETUP	36
4.7.3	TEST INSTRUMENTS	36
4.7.4	TEST PROCEDURE	36
4.7.5	DEVIATION FROM TEST STANDARD	36
4.7.6	EUT OPERATING CONDITION.....	36
4.7.7	TEST RESULTS.....	37
4.8	CONDUCTED OUT OF BAND EMISSION MEASUREMENT	38
4.8.1	LIMITS OF CONDUCTED OUT OF BAND EMISSION MEASUREMENT	38
4.8.2	TEST INSTRUMENTS.....	38
4.8.3	TEST PROCEDURE	38
4.8.4	DEVIATION FROM TEST STANDARD	38
4.8.5	EUT OPERATING CONDITION.....	38
4.8.6	TEST RESULTS.....	38
5.	PHOTOGRAPHS OF THE TEST CONFIGURATION.....	42
6.	INFORMATION ON THE TESTING LABORATORIES	43
7.	APPENDIX A – MODIFICATIONS RECORDERS FOR ENGINEERING CHANGES TO THE EUT BY THE LAB	44



A D T

RELEASE CONTROL RECORD

ISSUE NO.	REASON FOR CHANGE	DATE ISSUED
RF150714C29-5	Original release	Jul. 31, 2015



1. CERTIFICATION

PRODUCT: Smartphone
MODEL: OPM9310
BRAND: HTC
APPLICANT: HTC Corporation
TESTED: May 08, 2015 ~ May 15, 2015
TEST SAMPLE: Production Unit
STANDARDS: **FCC Part 15, Subpart C (Section 15.247)**
ANSI C63.10-2009

The above equipment (model: OPM9310) has been tested by **Bureau Veritas Consumer Products Services (H.K.) Ltd., Taoyuan Branch**, and found compliance with the requirement of the above standards. The test record, data evaluation & Equipment Under Test (EUT) configurations represented herein are true and accurate accounts of the measurements of the sample's EMC characteristics under the conditions specified in this report.

PREPARED BY : Ivonne Wu , **DATE :** Jul. 31, 2015
Ivonne Wu / Supervisor

APPROVED BY : Kay Wu , **DATE :** Jul. 31, 2015
Kay Wu / Supervisor

2. SUMMARY OF TEST RESULTS

The EUT has been tested according to the following specifications:

APPLIED STANDARD: FCC Part 15, Subpart C (Bluetooth 3.0)			
STANDARD SECTION	TEST TYPE AND LIMIT	RESULT	REMARK
15.207	AC Power Conducted Emission	PASS	Meet the requirement of limit. Minimum passing margin is -13.40dB at 1.11577MHz.
15.247(a)(1) (iii)	Number of Hopping Frequency Used	PASS	Meet the requirement of limit.
15.247(a)(1) (iii)	Dwell Time on Each Channel	PASS	Meet the requirement of limit.
15.247(a)(1)	1. Hopping Channel Separation 2. Spectrum Bandwidth of a Frequency Hopping Sequence Spread Spectrum System	PASS	Meet the requirement of limit.
15.247(b)	Maximum Peak Output Power	PASS	Meet the requirement of limit.
15.247(d)	Transmitter Radiated Emissions	PASS	Meet the requirement of limit. Minimum passing margin is -3.80dB at 32.16MHz.
15.247(d)	Band Edge Measurement	PASS	Meet the requirement of limit.
15.203	Antenna Requirement	PASS	No antenna connector is used.

NOTE: If The Frequency Hopping System operating in 2400-2483.5MHz band and the output power less than 125mW. The hopping channel carrier frequencies separated by a minimum of 25kHz or two-thirds of the 20dB bandwidth of hopping channel whichever is greater.

2.1 MEASUREMENT UNCERTAINTY

Where relevant, the following measurement uncertainty levels have been estimated for tests performed on the EUT as specified in CISPR 16-4-2:

MEASUREMENT	FREQUENCY	UNCERTAINTY
Conducted emissions	9kHz~30MHz	2.44 dB
Radiated emissions	30MHz ~ 200MHz	2.93 dB
	200MHz ~1000MHz	2.95 dB
	1GHz ~ 18GHz	2.26 dB
	18GHz ~ 40GHz	1.94 dB

This uncertainty represents an expanded uncertainty expressed at approximately the 95% confidence level using a coverage factor of $k = 2$.

3. GENERAL INFORMATION

3.1 GENERAL DESCRIPTION OF EUT

EUT	Smartphone	
MODEL NAME	OPM9310	
POWER SUPPLY	5.0Vdc (adapter or host equipment) 3.85Vdc (Li-ion battery)	
MODULATION TYPE	Bluetooth 3.0	GFSK, π /4-DQPSK, 8DPSK
TRANSFER RATE	Bluetooth 3.0	1/2/3Mbps
OPERATING FREQUENCY	2402 ~ 2480MHz	
NUMBER OF CHANNEL	Bluetooth 3.0	79
CHANNEL SPACING	Bluetooth 3.0	1MHz
OUTPUT POWER	Bluetooth 3.0	14.723mW
ANTENNA TYPE	PIFA antenna with -0.5dBi gain	
ANTENNA CONNECTOR	NA	
DATA CABLE	Refer to Note as below	
I/O PORTS	Refer to user's manual	
ACCESSORY DEVICES	Refer to Note as below	

NOTE:

1. The EUT's accessories list refers to Ext. Pho.
2. The above EUT information is declared by the manufacturer and for more detailed features description, please refer to the manufacturer's specifications or User's Manual.



3.2 DESCRIPTION OF TEST MODES

Bluetooth 3.0:

79 channels are provided to this EUT:

CHANNEL	FREQ. (MHz)	CHANNEL	FREQ. (MHz)	CHANNEL	FREQ. (MHz)	CHANNEL	FREQ. (MHz)
0	2402	20	2422	40	2442	60	2462
1	2403	21	2423	41	2443	61	2463
2	2404	22	2424	42	2444	62	2464
3	2405	23	2425	43	2445	63	2465
4	2406	24	2426	44	2446	64	2466
5	2407	25	2427	45	2447	65	2467
6	2408	26	2428	46	2448	66	2468
7	2409	27	2429	47	2449	67	2469
8	2410	28	2430	48	2450	68	2470
9	2411	29	2431	49	2451	69	2471
10	2412	30	2432	50	2452	70	2472
11	2413	31	2433	51	2453	71	2473
12	2414	32	2434	52	2454	72	2474
13	2415	33	2435	53	2455	73	2475
14	2416	34	2436	54	2456	74	2476
15	2417	35	2437	55	2457	75	2477
16	2418	36	2438	56	2458	76	2478
17	2419	37	2439	57	2459	77	2479
18	2420	38	2440	58	2460	78	2480
19	2421	39	2441	59	2461		



3.2.1 TEST MODE APPLICABILITY AND TESTED CHANNEL DETAIL

BLUETOOTH 3.0

EUT CONFIGURE MODE	APPLICABLE TO				DESCRIPTION
	RE \geq 1G	RE<1G	PLC	APCM	
-	√	√	√	√	-

Where **RE \geq 1G**: Radiated Emission above 1GHz **RE<1G**: Radiated Emission below 1GHz
PLC: Power Line Conducted Emission **APCM**: Antenna Port Conducted Measurement

- NOTE:** 1. For Radiated emission test, pre-tested GFSK, $\pi/4$ -DQPSK, 8DPSK modulation type and found $\pi/4$ -DQPSK was the worse, therefore chosen for the final test and presented in the test report.
2. The EUT had been pre-tested on the positioned of each 3 axis. The worst case was found when positioned on **X-plane**.

RADIATED EMISSION TEST (ABOVE 1GHz):

- Pre-Scan has been conducted to determine the worst-case mode from all possible combinations between available modulations, data rates and antenna ports (if EUT with antenna diversity architecture).
- Following channel(s) was (were) selected for the final test as listed below.

EUT CONFIGURE MODE	AVAILABLE CHANNEL	TESTED CHANNEL	MODULATION TYPE	PACKET TYPE
-	0 to 78	0, 39, 78	$\pi/4$ -DQPSK	DH5

RADIATED EMISSION TEST (BELOW 1GHz):

- Pre-Scan has been conducted to determine the worst-case mode from all possible combinations between available modulations, data rates and antenna ports (if EUT with antenna diversity architecture).
- Following channel(s) was (were) selected for the final test as listed below.

EUT CONFIGURE MODE	AVAILABLE CHANNEL	TESTED CHANNEL	MODULATION TYPE	PACKET TYPE
-	0 to 78	0	$\pi/4$ -DQPSK	DH5

POWER LINE CONDUCTED EMISSION TEST:

- Pre-Scan has been conducted to determine the worst-case mode from all possible combinations between available modulations, data rates and antenna ports (if EUT with antenna diversity architecture).
- Following channel(s) was (were) selected for the final test as listed below.

EUT CONFIGURE MODE	AVAILABLE CHANNEL	TESTED CHANNEL	MODULATION TYPE	PACKET TYPE
-	0 to 78	0	$\pi/4$ -DQPSK	DH5



A D T

ANTENNA PORT CONDUCTED MEASUREMENT:

- This item includes all test value of each mode, but only includes spectrum plot of worst value of each mode.
- Pre-Scan has been conducted to determine the worst-case mode from all possible combinations between available modulations, data rates and antenna ports (if EUT with antenna diversity architecture).
- Following channel(s) was (were) selected for the final test as listed below.

EUT CONFIGURE MODE	AVAILABLE CHANNEL	TESTED CHANNEL	MODULATION TYPE	PACKET TYPE
-	0 to 78	0, 39, 78	GFSK	DH5
	0 to 78	0, 39, 78	$\pi/4$ -DQPSK	DH5
	0 to 78	0, 39, 78	8DPSK	DH5

TEST CONDITION:

APPLICABLE TO	ENVIRONMENTAL CONDITIONS	INPUT POWER	TESTED BY
RE \geq 1G	25deg. C, 65%RH	120Vac, 60Hz	Harry Hsueh
RE<1G	25deg. C, 65%RH	120Vac, 60Hz	Harry Hsueh
PLC	25deg. C, 65%RH	120Vac, 60Hz	Toby Tian
APCM	25deg. C, 65%RH	3.85Vdc	Taylor Liu

3.3 DESCRIPTION OF SUPPORT UNITS

The EUT has been tested as an independent unit together with other necessary accessories or support units.

3.3.1 CONFIGURATION OF SYSTEM UNDER TEST

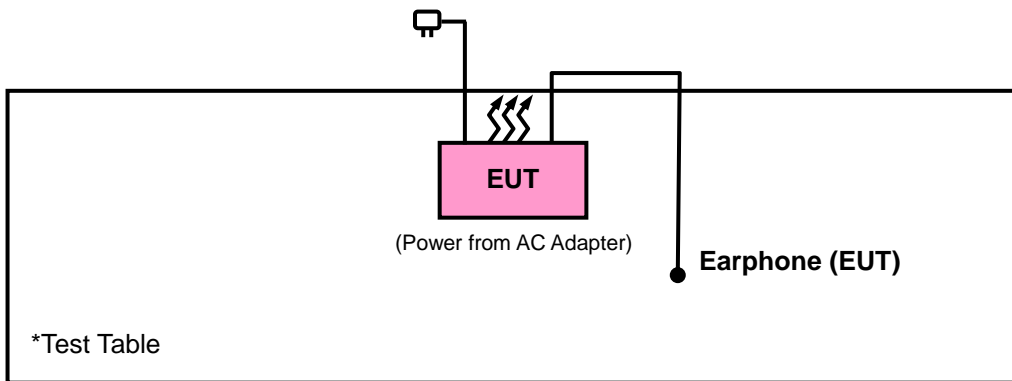



3.4 GENERAL DESCRIPTION OF APPLIED STANDARDS

The EUT is a RF Product. According to the specifications of the manufacturer, it must comply with the requirements of the following standards:

FCC Part 15, Subpart C (15.247)

ANSI C63.10-2009

FCC Public Notice DA 00-705

All test items have been performed and recorded as per the above standards.

NOTE: The EUT has been verified to comply with the requirements of FCC Part 15, Subpart B, Class B (DoC). The test report has been issued separately.

4. TEST TYPES AND RESULTS (FOR BLUETOOTH EDR)

4.1 RADIATED EMISSION AND BANDEDGE MEASUREMENT

4.1.1 LIMITS OF RADIATED EMISSION AND BANDEDGE MEASUREMENT

Radiated emissions which fall in the restricted bands must comply with the radiated emission limits specified as below table. Other emissions shall be at least 20dB below the highest level of the desired power:

FREQUENCIES (MHz)	FIELD STRENGTH (microvolts/meter)	MEASUREMENT DISTANCE (meters)
0.009 ~ 0.490	2400/F(kHz)	300
0.490 ~ 1.705	24000/F(kHz)	30
1.705 ~ 30.0	30	30
30 ~ 88	100	3
88 ~ 216	150	3
216 ~ 960	200	3
Above 960	500	3

NOTE:

1. The lower limit shall apply at the transition frequencies.
2. Emission level (dBuV/m) = 20 log Emission level (uV/m).
3. For frequencies above 1000MHz, the field strength limits are based on average detector, however, the peak field strength of any emission shall not exceed the maximum permitted average limits, specified above by more than 20dB under any condition of modulation.



A D T

4.1.2 TEST INSTRUMENTS

DESCRIPTION & MANUFACTURER	MODEL NO.	SERIAL NO.	DATE OF CALIBRATION	DUE DATE OF CALIBRATION
Test Receiver Agilent	N9038A	MY51210203	Jan. 21, 2015	Jan. 21, 2016
Spectrum Analyzer Agilent	N9010A	MY52220314	Sep. 03, 2014	Sep. 02, 2015
Spectrum Analyzer ROHDE & SCHWARZ	FSU43	101261	Dec. 10, 2014	Dec. 09, 2015
BILOG Antenna SCHWARZBECK	VULB9168	9168-472	Feb. 04, 2015	Feb. 04, 2016
HORN Antenna SCHWARZBECK	BBHA 9120 D	9120D-969	Feb. 09, 2015	Feb. 09, 2016
HORN Antenna SCHWARZBECK	BBHA 9170	9170-480	Feb. 04, 2015	Feb. 04, 2016
Loop Antenna	EM-6879	269	Aug. 13, 2014	Aug. 12, 2015
Preamplifier EMCI	EMC 012645	980115	Dec. 12, 2014	Dec. 11, 2015
Preamplifier EMCI	EMC 184045	980116	Jan. 09, 2015	Jan. 08, 2016
Preamplifier EMCI	EMC 330H	980112	Dec. 27, 2014	Dec. 26, 2015
Power Meter Anritsu	ML2495A	1232002	Sep. 17, 2014	Sep. 16, 2015
Power Sensor Anritsu	MA2411B	1207325	Sep. 17, 2014	Sep. 16, 2015
RF signal cable HUBER+SUHNNER	SUCOFLEX 104	309219/4 2950114	Oct. 18, 2014	Oct. 17, 2015
RF signal cable HUBER+SUHNNER	SUCOFLEX 104	250130/4	Oct. 18, 2014	Oct. 17, 2015
RF Coaxial Cable Worken	8D-FB	Cable-Ch10-01	Nov. 07, 2014	Nov. 06, 2015
Software BV ADT	E3 6.120103	NA	NA	NA
Antenna Tower MF	MFA-440H	NA	NA	NA
Turn Table MF	MFT-201SS	NA	NA	NA
Antenna Tower & Turn Table Controller MF	MF-7802	NA	NA	NA
Bluetooth Tester R&S	CBT	100980	Apr. 27, 2015	Apr. 26, 2017

- NOTE:**
1. The calibration interval of the above test instruments is 12 / 24 months and the calibrations are traceable to NML/ROC and NIST/USA.
 2. The test was performed in HwaYa Chamber 10.
 3. The horn antenna and HP preamplifier (model: 8449B) are used only for the measurement of emission frequency above 1GHz if tested.
 4. The FCC Site Registration No. is 690701.
 5. The IC Site Registration No. is IC 7450F-10.

4.1.3 TEST PROCEDURES

- a. The EUT was placed on the top of a rotating table 0.8 meters (for below 1GHz) / 1.5 meters (for above 1GHz) above the ground at 3 meter chamber room for test. The table was rotated 360 degrees to determine the position of the highest radiation.
- b. The EUT was set 3 meters away from the interference-receiving antenna, which was mounted on the top of a variable-height antenna tower.
- c. The antenna is a broadband antenna, and its height is varied from one meter to four meters above the ground to determine the maximum value of the field strength. Both horizontal and vertical polarizations of the antenna are set to make the measurement.
- d. For each suspected emission, the EUT was arranged to its worst case and then the antenna was tuned to heights from 1 meter to 4 meters and the rotatable table was turned from 0 degrees to 360 degrees to find the maximum reading.
- e. The test-receiver system was set to Peak Detect Function and Specified Bandwidth with Maximum Hold Mode.
- f. If the emission level of the EUT in peak mode was lower than the limit specified, then testing could be stopped and the peak values of the EUT would be reported. Otherwise the emissions would be re-tested one by one using peak, quasi-peak or average method as specified and then reported in a data sheet.

NOTE:

1. The resolution bandwidth and video bandwidth of test receiver/spectrum analyzer is 120kHz for Quasi-peak detection at frequency below 1GHz.
2. The resolution bandwidth of test receiver/spectrum analyzer is 1MHz and video bandwidth is 3MHz for Peak detection at frequency above 1GHz.
3. The resolution bandwidth of test receiver/spectrum analyzer is 1MHz and the video bandwidth is 10Hz for Average detection (AV) at frequency above 1GHz.

4.1.4 DEVIATION FROM TEST STANDARD

No deviation.

4.1.5 TEST SETUP

<Frequency Range 30MHz ~ 1GHz>

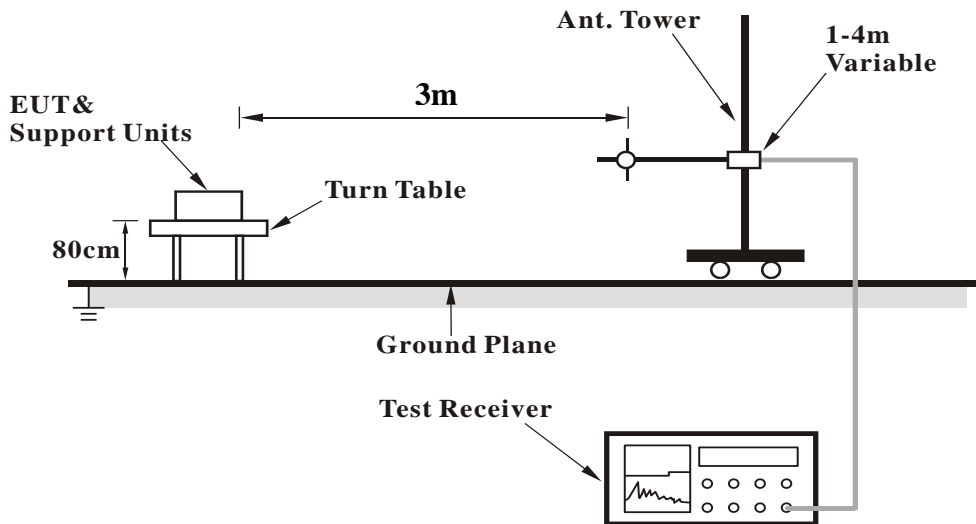

<Frequency Range above 1GHz>

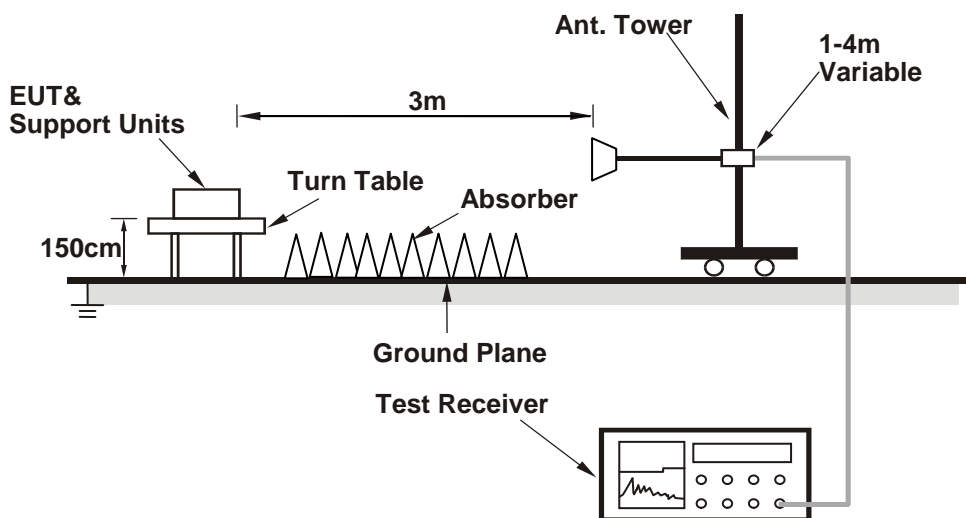

For the actual test configuration, please refer to the attached file (Test Setup Photo).

4.1.6 EUT OPERATING CONDITIONS

- a. Placed the EUT on a testing table.
- b. Use the software to control the EUT under transmission condition continuously at specific channel frequency.



A D T

4.1.7 TEST RESULTS

ABOVE 1GHz WORST-CASE DATA

$\pi/4$ -DQPSK

EUT TEST CONDITION		MEASUREMENT DETAIL	
CHANNEL	Channel 0	FREQUENCY RANGE	1GHz ~ 25GHz
INPUT POWER	120Vac, 60 Hz	DETECTOR FUNCTION	Peak (PK) Average (AV)
ENVIRONMENTAL CONDITIONS	25deg. C, 65%RH	TESTED BY	Harry Hsueh

ANTENNA POLARITY & TEST DISTANCE: HORIZONTAL AT 3 M										
FREQ. (MHz)	EMISSION LEVEL (dBuV/m)	READ LEVEL (dBuV)	LIMIT (dBuV/m)	MARGIN (dB)	ANTENNA FACTOR (dB/m)	CABLE LOSS (dB)	PREAMP FACTOR (dB)	ANTENNA HEIGHT (cm)	TABLE ANGLE (Degree)	REMARK
2378	40.47	38.81	54	-13.53	31.78	5.37	35.49	281	55	Average
2378	61.85	60.19	74	-12.15	31.78	5.37	35.49	281	55	Peak
2402	101.43	99.7			31.8	5.4	35.47	281	55	Average
2402	104.05	102.32			31.8	5.4	35.47	281	55	Peak
2500	40.66	38.64	54	-13.34	31.9	5.53	35.41	281	55	Average
2500	62.59	60.57	74	-11.41	31.9	5.53	35.41	281	55	Peak
ANTENNA POLARITY & TEST DISTANCE: VERTICAL AT 3 M										
FREQ. (MHz)	EMISSION LEVEL (dBuV/m)	READ LEVEL (dBuV)	LIMIT (dBuV/m)	MARGIN (dB)	ANTENNA FACTOR (dB/m)	CABLE LOSS (dB)	PREAMP FACTOR (dB)	ANTENNA HEIGHT (cm)	TABLE ANGLE (Degree)	REMARK
2386	40.43	38.72	54	-13.57	31.8	5.4	35.49	247	331	Average
2386	61.2	59.49	74	-12.8	31.8	5.4	35.49	247	331	Peak
2402	97.43	95.7			31.8	5.4	35.47	247	331	Average
2402	100.43	98.7			31.8	5.4	35.47	247	331	Peak
2500	40	37.98	54	-14	31.9	5.53	35.41	247	331	Average
2500	61.93	59.91	74	-12.07	31.9	5.53	35.41	247	331	Peak

REMARKS:

- Emission Level = Read Level + Antenna Factor + Cable Loss - Preamp Factor
Margin value = Emission level – Limit value
- 2402MHz: Fundamental frequency.



A D T

EUT TEST CONDITION		MEASUREMENT DETAIL	
CHANNEL	Channel 39	FREQUENCY RANGE	1GHz ~ 25GHz
INPUT POWER	120Vac, 60 Hz	DETECTOR FUNCTION	Peak (PK) Average (AV)
ENVIRONMENTAL CONDITIONS	25deg. C, 65%RH	TESTED BY	Harry Hsueh

ANTENNA POLARITY & TEST DISTANCE: HORIZONTAL AT 3 M										
FREQ. (MHz)	EMISSION LEVEL (dBuV/m)	READ LEVEL (dBuV)	LIMIT (dBuV/m)	MARGIN (dB)	ANTENNA FACTOR (dB/m)	CABLE LOSS (dB)	PREAMP FACTOR (dB)	ANTENNA HEIGHT (cm)	TABLE ANGLE (Degree)	REMARK
2334	39.3	37.76	54	-14.7	31.73	5.33	35.52	300	87	Average
2334	61.52	59.98	74	-12.48	31.73	5.33	35.52	300	87	Peak
2441	102.84	100.97			31.85	5.46	35.44	300	87	Average
2441	106.24	104.37			31.85	5.46	35.44	300	87	Peak
2486	40.54	38.55	54	-13.46	31.88	5.53	35.42	300	87	Average
2486	61.92	59.93	74	-12.08	31.88	5.53	35.42	300	87	Peak

ANTENNA POLARITY & TEST DISTANCE: VERTICAL AT 3 M										
FREQ. (MHz)	EMISSION LEVEL (dBuV/m)	READ LEVEL (dBuV)	LIMIT (dBuV/m)	MARGIN (dB)	ANTENNA FACTOR (dB/m)	CABLE LOSS (dB)	PREAMP FACTOR (dB)	ANTENNA HEIGHT (cm)	TABLE ANGLE (Degree)	REMARK
2342	40.31	38.74	54	-13.69	31.74	5.33	35.5	198	330	Average
2342	61.35	59.78	74	-12.65	31.74	5.33	35.5	198	330	Peak
2441	98.84	96.97			31.85	5.46	35.44	198	330	Average
2441	102.08	100.21			31.85	5.46	35.44	198	330	Peak
2494	39.96	37.94	54	-14.04	31.9	5.53	35.41	198	330	Average
2494	61.61	59.59	74	-12.39	31.9	5.53	35.41	198	330	Peak

REMARKS:

- Emission Level = Read Level + Antenna Factor + Cable Loss - Preamp Factor
Margin value = Emission level – Limit value
- 2441MHz: Fundamental frequency.



A D T

EUT TEST CONDITION		MEASUREMENT DETAIL	
CHANNEL	Channel 78	FREQUENCY RANGE	1GHz ~ 25GHz
INPUT POWER	120Vac, 60 Hz	DETECTOR FUNCTION	Peak (PK) Average (AV)
ENVIRONMENTAL CONDITIONS	25deg. C, 65%RH	TESTED BY	Harry Hsueh

ANTENNA POLARITY & TEST DISTANCE: HORIZONTAL AT 3 M

FREQ. (MHz)	EMISSION LEVEL (dBuV/m)	READ LEVEL (dBuV)	LIMIT (dBuV/m)	MARGIN (dB)	ANTENNA FACTOR (dB/m)	CABLE LOSS (dB)	PREAMP FACTOR (dB)	ANTENNA HEIGHT (cm)	TABLE ANGLE (Degree)	REMARK
2314	40.25	38.76	54	-13.75	31.71	5.3	35.52	200	88	Average
2314	62.53	61.04	74	-11.47	31.71	5.3	35.52	200	88	Peak
2480	99.91	97.95			31.88	5.5	35.42	200	88	Average
2480	103.27	101.31			31.88	5.5	35.42	200	88	Peak
2483.5	41.05	39.09	54	-12.95	31.88	5.5	35.42	200	88	Average
2483.5	61.2	59.24	74	-12.8	31.88	5.5	35.42	200	88	Peak

ANTENNA POLARITY & TEST DISTANCE: VERTICAL AT 3 M

FREQ. (MHz)	EMISSION LEVEL (dBuV/m)	READ LEVEL (dBuV)	LIMIT (dBuV/m)	MARGIN (dB)	ANTENNA FACTOR (dB/m)	CABLE LOSS (dB)	PREAMP FACTOR (dB)	ANTENNA HEIGHT (cm)	TABLE ANGLE (Degree)	REMARK
2310	39.25	37.77	54	-14.75	31.71	5.3	35.53	111	338	Average
2310	61.02	59.54	74	-12.98	31.71	5.3	35.53	111	338	Peak
2480	95.71	93.75			31.88	5.5	35.42	111	338	Average
2480	99.15	97.19			31.88	5.5	35.42	111	338	Peak
2494	40.96	38.94	54	-13.04	31.9	5.53	35.41	111	338	Average
2494	62.47	60.45	74	-11.53	31.9	5.53	35.41	111	338	Peak

REMARKS:

- Emission Level = Read Level + Antenna Factor + Cable Loss - Preamp Factor
Margin value = Emission level – Limit value
- 2480MHz: Fundamental frequency.



A D T

BELOW 1GHz WORST-CASE DATA:

EUT TEST CONDITION		MEASUREMENT DETAIL	
CHANNEL	Channel 0	FREQUENCY RANGE	30MHz ~ 1GHz
INPUT POWER	120Vac, 60 Hz	DETECTOR FUNCTION	Peak (PK) Quasi-peak (QP)
ENVIRONMENTAL CONDITIONS	25deg. C, 65%RH	TESTED BY	Harry Hsueh

ANTENNA POLARITY & TEST DISTANCE: HORIZONTAL AT 3 M

FREQ. (MHz)	EMISSION LEVEL (dBuV/m)	READ LEVEL (dBuV)	LIMIT (dBuV/m)	MARGIN (dB)	ANTENNA FACTOR (dB/m)	CABLE LOSS (dB)	PREAMP FACTOR (dB)	ANTENNA HEIGHT (cm)	TABLE ANGLE (Degree)	REMARK
102.09	28.61	47.25	43.5	-14.89	12.34	1.28	32.26	168	188	Peak
137.46	25.83	48.17	43.5	-17.67	8.54	1.38	32.26	173	273	Peak
216.03	26.57	45.88	46	-19.43	11.27	1.65	32.23	171	267	Peak
384	18.14	33.31	46	-27.86	14.67	2.34	32.18	127	37	Peak
705.3	20.38	30.05	46	-25.62	19.31	3.11	32.09	178	306	Peak
941.9	23.68	29.54	46	-22.32	21.69	3.62	31.17	144	284	Peak

ANTENNA POLARITY & TEST DISTANCE: VERTICAL AT 3 M

FREQ. (MHz)	EMISSION LEVEL (dBuV/m)	READ LEVEL (dBuV)	LIMIT (dBuV/m)	MARGIN (dB)	ANTENNA FACTOR (dB/m)	CABLE LOSS (dB)	PREAMP FACTOR (dB)	ANTENNA HEIGHT (cm)	TABLE ANGLE (Degree)	REMARK
32.16	36.2	56.06	40	-3.8	11.66	0.74	32.26	104	224	Peak
48.09	34.65	51.41	40	-5.35	14.56	0.9	32.22	121	321	Peak
143.4	18.72	41.22	43.5	-24.78	8.39	1.38	32.27	175	84	Peak
384	18.98	34.15	46	-27.02	14.67	2.34	32.18	169	112	Peak
689.9	19.92	29.89	46	-26.08	19.08	3.05	32.1	167	317	Peak
960.8	25.06	30.47	54	-28.94	21.84	3.67	30.92	114	355	Peak

REMARKS: Emission Level = Read Level + Antenna Factor + Cable Loss - Preamp Factor
Margin value = Emission level – Limit value

4.2 CONDUCTED EMISSION MEASUREMENT

4.2.1 LIMITS OF CONDUCTED EMISSION MEASUREMENT

FREQUENCY OF EMISSION (MHz)	CONDUCTED LIMIT (dB μ V)	
	Quasi-peak	Average
0.15 ~ 0.5	66 to 56	56 to 46
0.5 ~ 5	56	46
5 ~ 30	60	50

- NOTE:**
1. The lower limit shall apply at the transition frequencies.
 2. The limit decreases in line with the logarithm of the frequency in the range of 0.15 to 0.50MHz.
 3. All emanations from a class A/B digital device or system, including any network of conductors and apparatus connected thereto, shall not exceed the level of field strengths specified above.

4.2.2 TEST INSTRUMENTS

DESCRIPTION & MANUFACTURER	MODEL NO.	SERIAL NO.	DATE OF CALIBRATION	DUE DATE OF CALIBRATION
Test Receiver ROHDE & SCHWARZ	ESCI	100613	Nov. 11, 2014	Nov. 10, 2015
RF signal cable Woken	5D-FB	Cable-HYC01-01	Dec. 26, 2014	Dec. 25, 2015
LISN ROHDE & SCHWARZ (EUT)	ESH3-Z5	835239/001	Mar. 02, 2015	Mar. 01, 2016
LISN ROHDE & SCHWARZ (Peripheral)	ESH3-Z5	100311	Jul. 21, 2014	Jul. 20, 2015
Software ADT	BV ADT_Cond_ V7.3.7.3	NA	NA	NA

- NOTE:**
1. The calibration interval of the above test instruments is 12 months and the calibrations are traceable to NML/ROC and NIST/USA.
 2. The test was performed in HwaYa Shielded Room 1.
 3. The VCCI Site Registration No. is C-2040.

4.2.3 TEST PROCEDURES

- a. The EUT was placed 0.4 meters from the conducting wall of the shielded room with EUT being connected to the power mains through a line impedance stabilization network (LISN). Other support units were connected to the power mains through another LISN. The two LISNs provide 50 ohm/ 50uH of coupling impedance for the measuring instrument.
- b. Both lines of the power mains connected to the EUT were checked for maximum conducted interference.
- c. The frequency range from 150kHz to 30MHz was searched. Emission levels under (Limit - 20dB) was not recorded.

NOTE: All modes of operation were investigated and the worst-case emissions are reported.

4.2.4 DEVIATION FROM TEST STANDARD

No deviation.

4.2.5 TEST SETUP

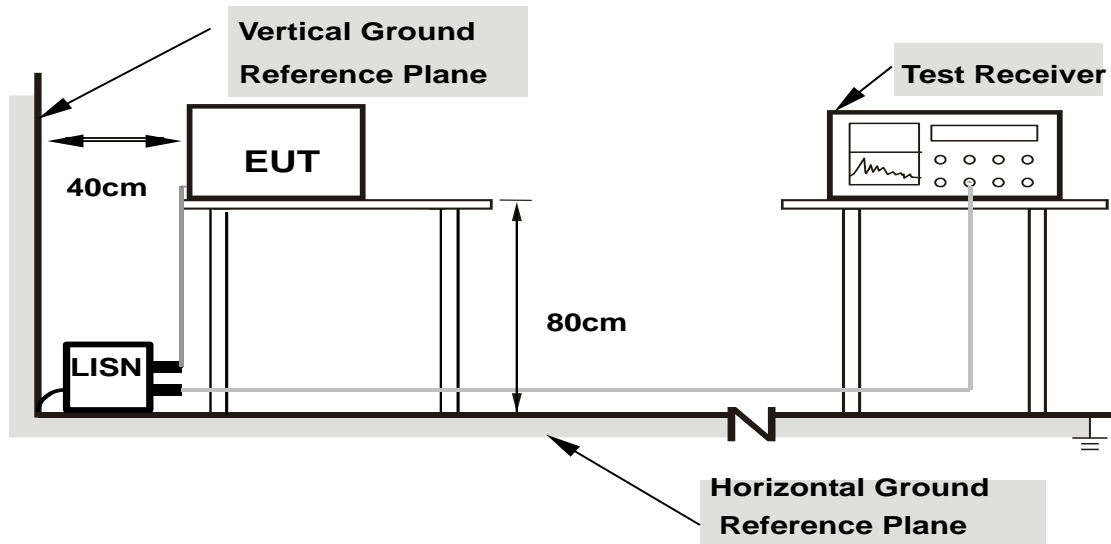

- Note: 1. Support units were connected to second LISN.**
2. Both of LISNs (AMN) are 80 cm from EUT and at least 80 cm from other units and other metal planes

For the actual test configuration, please refer to the attached file (Test Setup Photo).

4.2.6 EUT OPERATING CONDITIONS

Same as section 4.1.6.

4.2.7 TEST RESULTS

CONDUCTED WORST-CASE DATA :

Frequency Range	150kHz ~ 30MHz	Detector Function & Resolution Bandwidth	Quasi-Peak (QP) / Average (AV), 9kHz
Input Power	120Vac, 60Hz	Environmental Conditions	25°C, 65%RH
Tested by	Toby Tian	Test Date	2015/5/15

Phase Of Power : Line (L)										
No	Frequency (MHz)	Correction Factor (dB)	Reading Value (dBuV)		Emission Level (dBuV)		Limit (dBuV)		Margin (dB)	
			Q.P.	AV.	Q.P.	AV.	Q.P.	AV.	Q.P.	AV.
1	0.16173	0.05	36.93	22.18	36.98	22.23	65.37	55.37	-28.39	-33.14
2	0.23216	0.06	38.44	23.17	38.50	23.23	62.37	52.37	-23.87	-29.14
3	0.37287	0.06	41.77	25.17	41.83	25.23	58.44	48.44	-16.61	-23.21
4	0.51363	0.06	40.26	26.28	40.32	26.34	56.00	46.00	-15.68	-19.66
5	1.11577	0.08	42.52	28.56	42.60	28.64	56.00	46.00	-13.40	-17.36
6	1.63577	0.11	39.05	26.00	39.16	26.11	56.00	46.00	-16.84	-19.89

Remarks:

1. Q.P. and AV. are abbreviations of quasi-peak and average individually.
2. The emission levels of other frequencies were very low against the limit.
3. Margin value = Emission level – Limit value
4. Correction factor = Insertion loss + Cable loss
5. Emission Level = Correction Factor + Reading Value

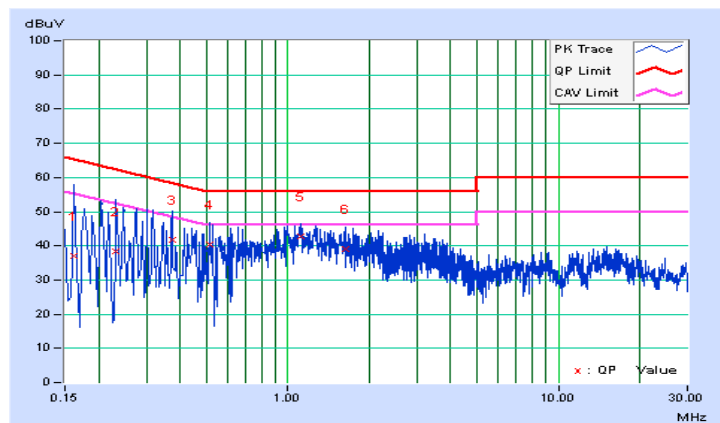



A D T

Frequency Range	150kHz ~ 30MHz	Detector Function & Resolution Bandwidth	Quasi-Peak (QP) / Average (AV), 9kHz
Input Power	120Vac, 60Hz	Environmental Conditions	25°C, 65%RH
Tested by	Toby Tian	Test Date	2015/5/15

Phase Of Power : Neutral (N)										
No	Frequency (MHz)	Correction Factor (dB)	Reading Value (dBuV)		Emission Level (dBuV)		Limit (dBuV)		Margin (dB)	
			Q.P.	AV.	Q.P.	AV.	Q.P.	AV.	Q.P.	AV.
1	0.15000	0.05	51.06	37.72	51.11	37.77	66.00	56.00	-14.89	-18.23
2	0.19978	0.05	48.01	34.79	48.06	34.84	63.62	53.62	-15.56	-18.78
3	0.25458	0.05	42.06	28.98	42.11	29.03	61.61	51.61	-19.49	-22.57
4	0.50972	0.06	36.99	20.77	37.05	20.83	56.00	46.00	-18.95	-25.17
5	1.04148	0.08	38.62	27.43	38.70	27.51	56.00	46.00	-17.30	-18.49
6	2.78531	0.14	36.68	26.02	36.82	26.16	56.00	46.00	-19.18	-19.84

Remarks:

1. Q.P. and AV. are abbreviations of quasi-peak and average individually.
2. The emission levels of other frequencies were very low against the limit.
3. Margin value = Emission level – Limit value
4. Correction factor = Insertion loss + Cable loss
5. Emission Level = Correction Factor + Reading Value

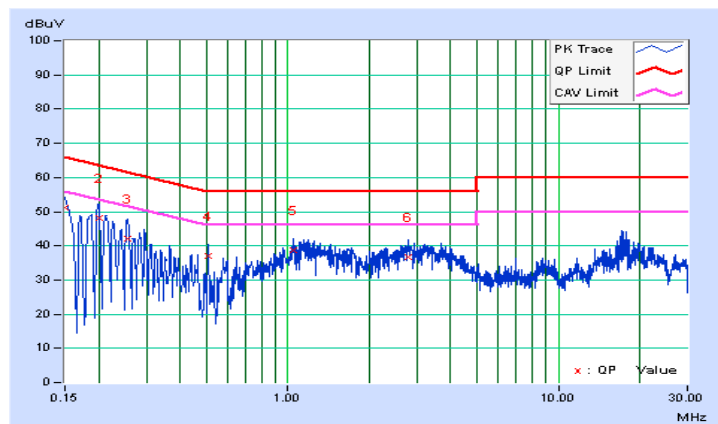

4.3 NUMBER OF HOPPING FREQUENCY USED

4.3.1 LIMIT OF HOPPING FREQUENCY USED

At least 15 channels frequencies, and should be equally spaced.

4.3.2 TEST SETUP

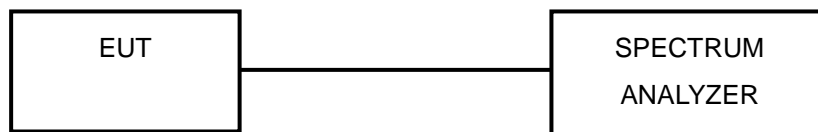

4.3.3 TEST INSTRUMENTS

Refer to section 4.1.2 to get information of above instrument.

4.3.4 TEST PROCEDURE

- Check the calibration of the measuring instrument (SA) using either an internal calibrator or a known signal from an external generator.
- Turn on the EUT and connect its antenna terminal to measurement via a low loss cable. Then set it to any one measured frequency within its operating range and make sure the instrument is operated in its linear range.
- Set the SA on MaxHold Mode, and then keep the EUT in hopping mode. Record all the signals from each channel until each one has been recorded.
- Set the SA on View mode and then plot the result on SA screen.
- Repeat above procedures until all frequencies measured were complete.

4.3.5 DEVIATION FROM TEST STANDARD

No deviation.

4.3.6 TEST RESULTS

There are 79 hopping frequencies in the hopping mode. Please refer to next page for the test result. On the plot, it shows that the hopping frequencies are equally spaced.



A D T

$\pi/4$ -DQPSK

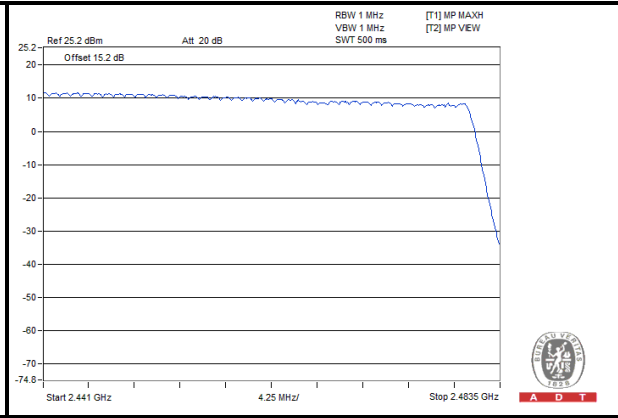
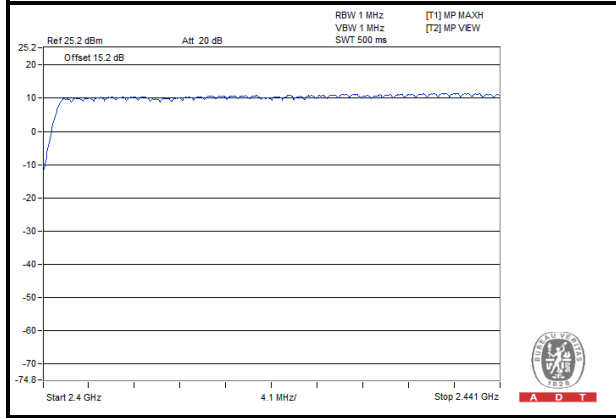

4.4 DWELL TIME ON EACH CHANNEL

4.4.1 LIMITS OF DWELL TIME USED

The average time of occupancy on any channel shall not be greater than 0.4 seconds within a period of 0.4 seconds multiplied by the number of hopping channels employed.

4.4.2 TEST SETUP

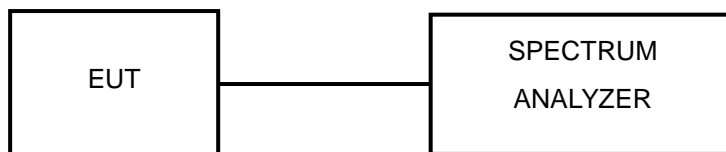

4.4.3 TEST INSTRUMENTS

Refer to section 4.1.2 to get information of above instrument.

4.4.4 TEST PROCEDURES

- a. Check the calibration of the measuring instrument (SA) using either an internal calibrator or a known signal from an external generator.
- b. Turn on the EUT and connect its antenna terminal to measurement via a low loss cable. Then set it to any one measured frequency within its operating range and make sure the instrument is operated in its linear range.
- c. Adjust the center frequency of SA on any frequency be measured and set SA to zero span mode. And then, set RBW and VBW of spectrum analyzer to proper value.
- d. Measure the time duration of one transmission on the measured frequency. And then plot the result with time difference of this time duration.
- e. Repeat above procedures until all different time-slot modes have been completed.

4.4.5 DEVIATION FROM TEST STANDARD

No deviation.



A D T

4.4.6 TEST RESULTS

GFSK

Mode	Average Hopping Channel	Package Transfer Time (usec)	Result (sec)	Limit (sec)
DH1	10.20	413.00	0.13	0.4
DH3	5.40	1700.00	0.29	0.4
DH5	3.20	2956.00	0.30	0.4

NOTE:

1. Dwell Time=79(channels) x 0.4(s) x average hopping channel x package transfer time
2. 79 channels come from the Hopping Channel number
3. Average Hopping Channel = hops/sweep time
4. t: Package Transfer Time(us)
5. Test plots of the transmitting time slot are shown as below.

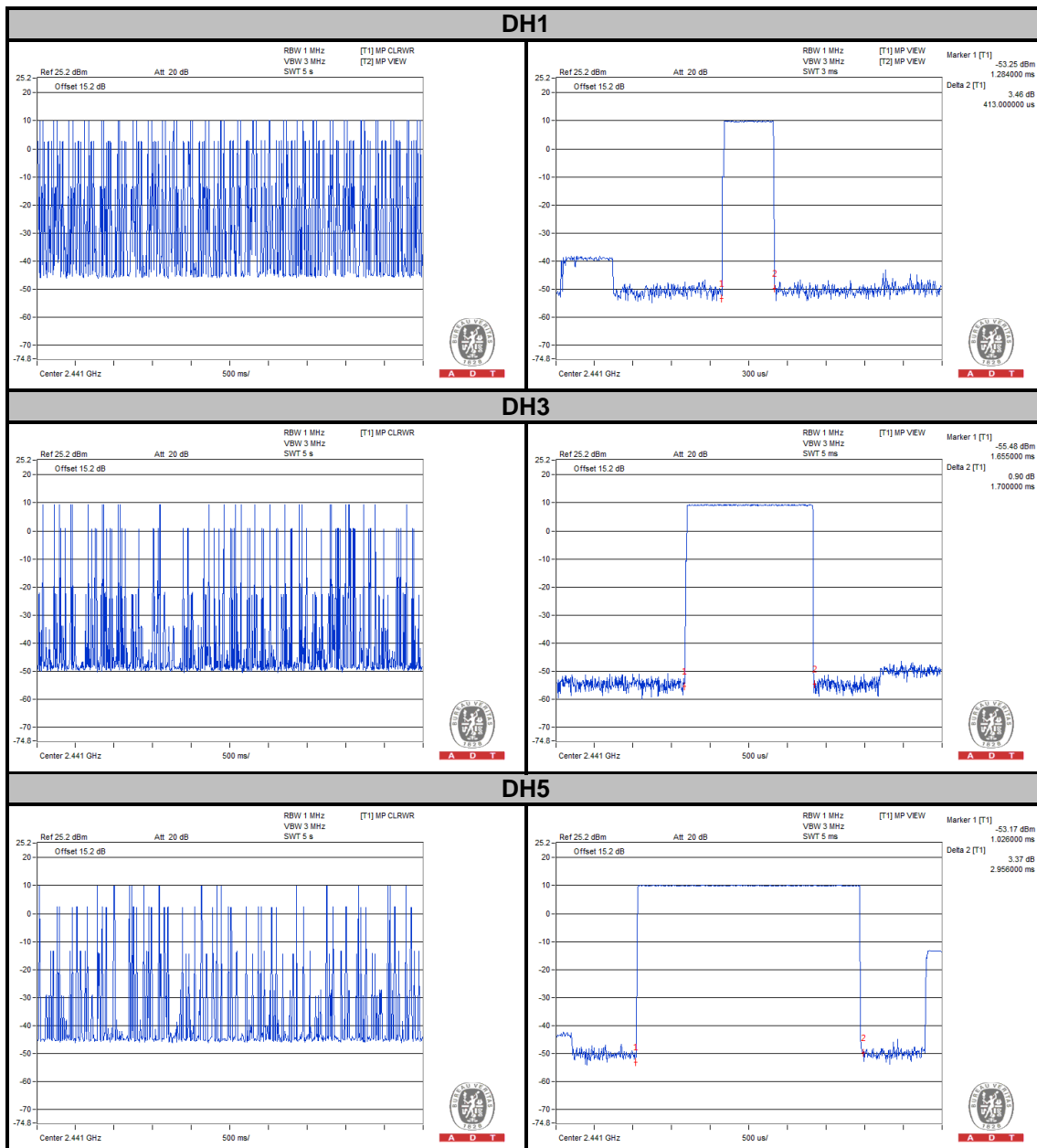



A D T

$\pi/4$ -DQPSK

Mode	Average Hopping Channel	Package Transfer Time (usec)	Result (sec)	Limit (sec)
2DH1	10.00	414.00	0.13	0.4
2DH3	5.40	1714.00	0.29	0.4
2DH5	3.40	2980.00	0.32	0.4

NOTE:

1. Dwell Time=79(channels) x 0.4(s) x average hopping channel x package transfer time
2. 79 channels come from the Hopping Channel number
3. Average Hopping Channel = hops/sweep time
4. t: Package Transfer Time(us)
5. Test plots of the transmitting time slot are shown as below.

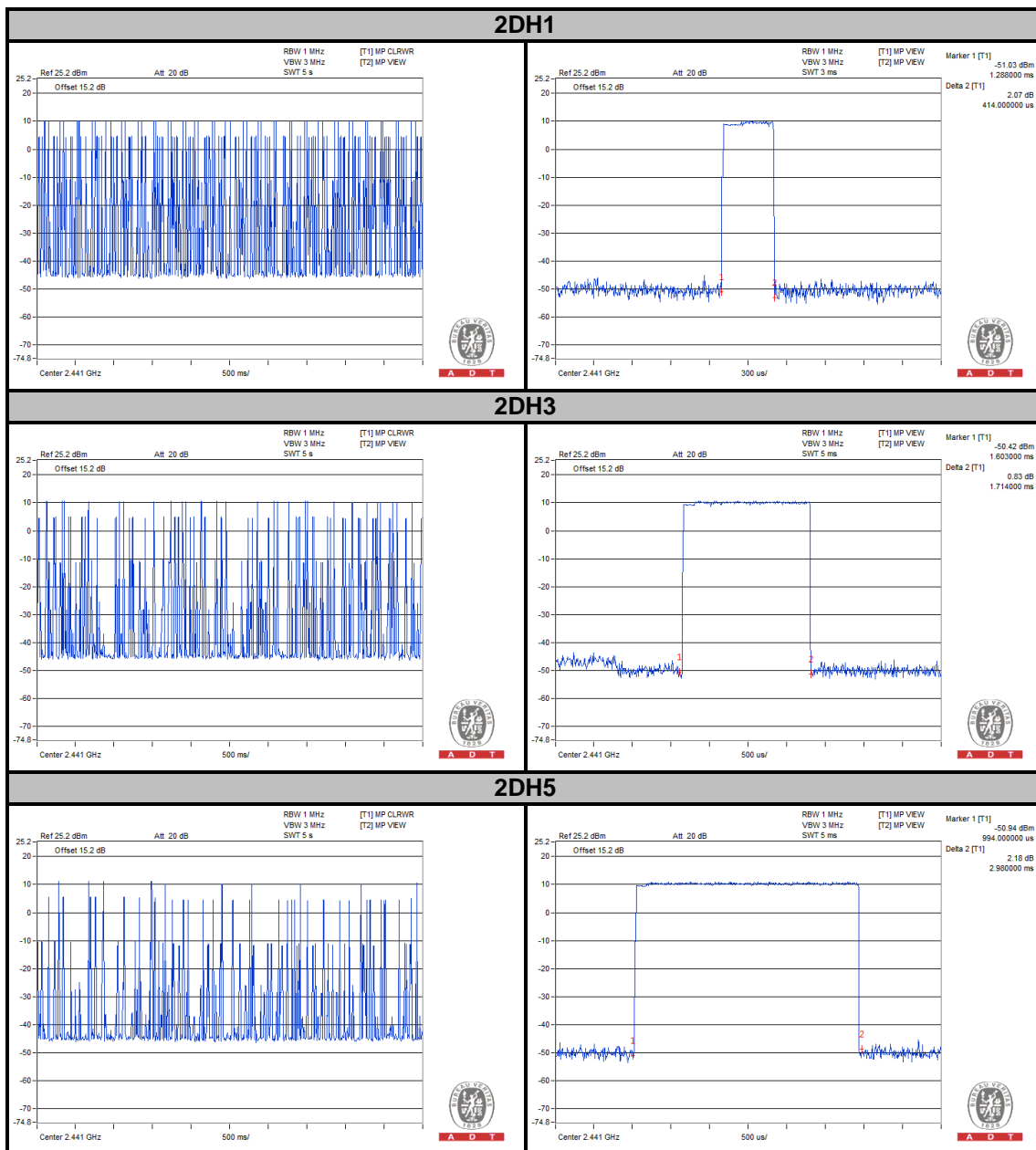



A D T

8DPSK

Mode	Average Hopping Channel	Package Transfer Time (usec)	Result (sec)	Limit (sec)
3DH1	10.00	438.00	0.14	0.4
3DH3	5.00	1674.00	0.26	0.4
3DH5	3.40	2932.00	0.32	0.4

NOTE:

1. Dwell Time=79(channels) x 0.4(s) x average hopping channel x package transfer time
2. 79 channels come from the Hopping Channel number
3. Average Hopping Channel = hops/sweep time
4. t: Package Transfer Time(us)
5. Test plots of the transmitting time slot are shown as below.



4.5 CHANNEL BANDWIDTH

4.5.1 LIMITS OF CHANNEL BANDWIDTH

For frequency hopping system operating in the 2400-2483.5MHz, If the 20dB bandwidth of hopping channel is greater than 25kHz, two-thirds 20dB bandwidth of hopping channel shall be a minimum limit for the hopping channel separation.

4.5.2 TEST SETUP

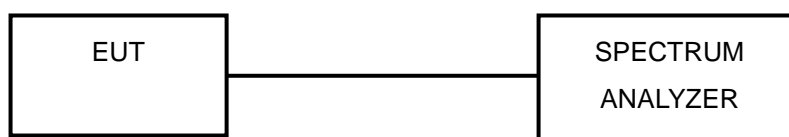

4.5.3 TEST INSTRUMENTS

Refer to section 4.1.2 to get information of above instrument.

4.5.4 TEST PROCEDURE

- a. Check the calibration of the measuring instrument using either an internal calibrator or a known signal from an external generator.
- b. Turn on the EUT and connect it to measurement instrument. Then set it to any one convenient frequency within its operating range. Set a reference level on the measuring instrument equal to the highest peak value.
- c. Measure the frequency difference of two frequencies that were attenuated 20dB from the reference level. Record the frequency difference as the emission bandwidth.
- d. Repeat above procedures until all frequencies measured were complete.

4.5.5 DEVIATION FROM TEST STANDARD

No deviation.

4.5.6 EUT OPERATING CONDITION

The software provided by client enabled the EUT to transmit and receive data at lowest, middle and highest channel frequencies individually.



A D T

4.5.7 TEST RESULTS

CHANNEL	FREQUENCY (MHz)	20dB BANDWIDTH (MHz)		
		GFSK	$\pi/4$ -DQPSK	8DPSK
0	2402	0.962	1.32	1.28
39	2441	1.300	1.32	1.30
78	2480	0.977	1.32	1.31

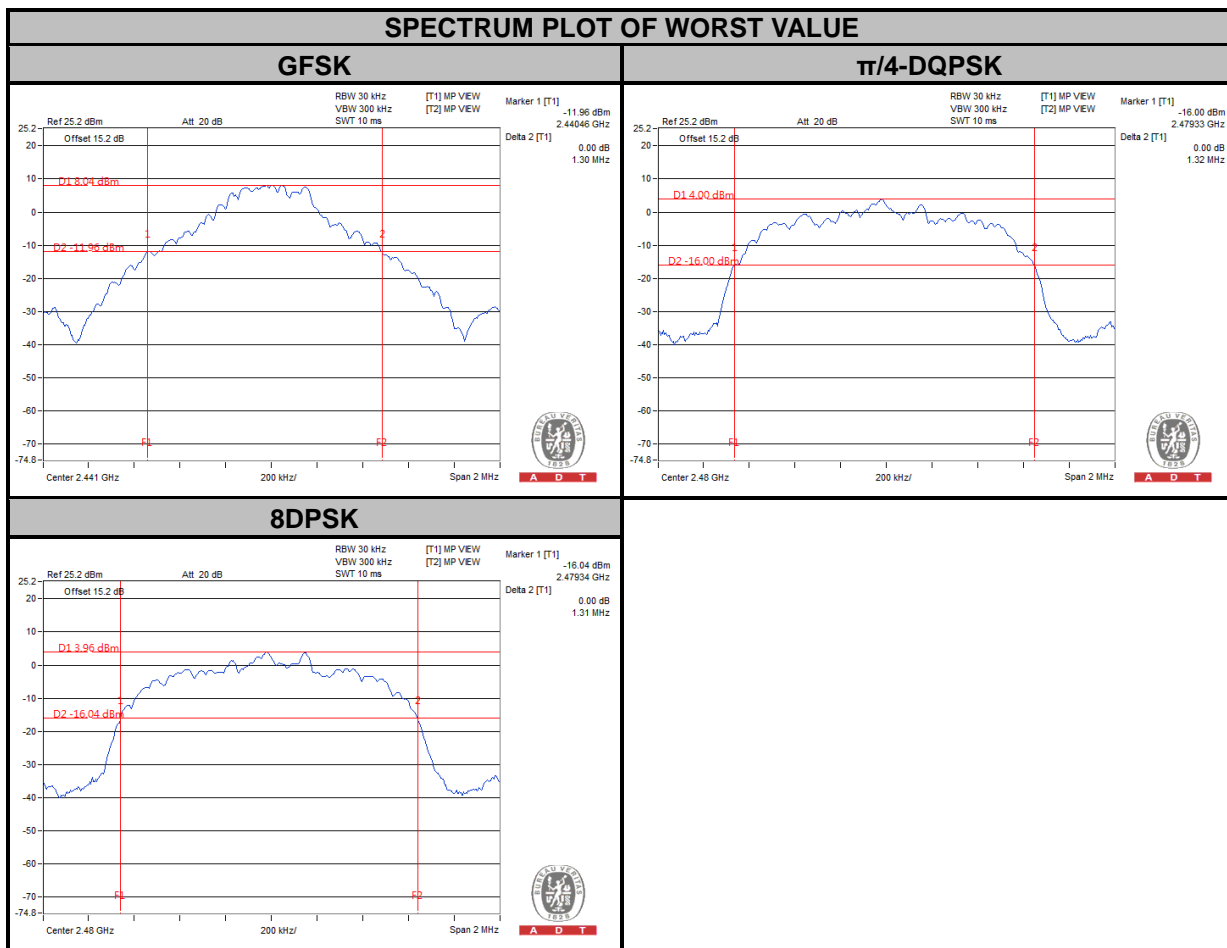

4.6 HOPPING CHANNEL SEPARATION

4.6.1 LIMITS OF HOPPING CHANNEL SEPARATION

At least 25kHz or two-third of 20dB hopping channel bandwidth (whichever is greater).

4.6.2 TEST SETUP

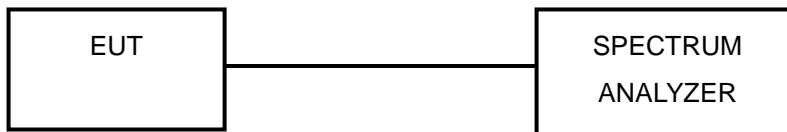

4.6.3 TEST INSTRUMENTS

Refer to section 4.1.2 to get information of above instrument.

4.6.4 TEST PROCEDURE

- a. Check the calibration of the measuring instrument using either an internal calibrator or a known signal from an external generator.
- b. Turn on the EUT and connect it to measurement instrument. Then set it to any one convenient frequency within its operating range.
- c. By using the MaxHold function record the separation of two adjacent channels.
- d. Measure the frequency difference of these two adjacent channels by SA MARK function. And then plot the result on SA screen.
- e. Repeat above procedures until all frequencies measured were complete.

4.6.5 DEVIATION FROM TEST STANDARD

No deviation.



A D T

4.6.6 TEST RESULTS

CHAN.	FREQ. (MHz)	ADJACENT CHANNEL SEPARATION (MHz)			20dB BANDWIDTH (MHz)			MINIMUM LIMIT (MHz)			PASS / FAIL
		GFSK	$\pi/4$ -DQPSK	8DPSK	GFSK	$\pi/4$ -DQPSK	8DPSK	GFSK	$\pi/4$ -DQPSK	8DPSK	
0	2402	1.00	1.10	1.10	0.962	1.32	1.28	0.641	0.880	0.853	PASS
39	2441	1.00	1.10	1.00	1.300	1.32	1.30	0.867	0.880	0.867	PASS
78	2480	1.10	1.00	1.10	0.977	1.32	1.31	0.651	0.880	0.873	PASS

NOTE:

- The minimum limit is two-third 20dB bandwidth.

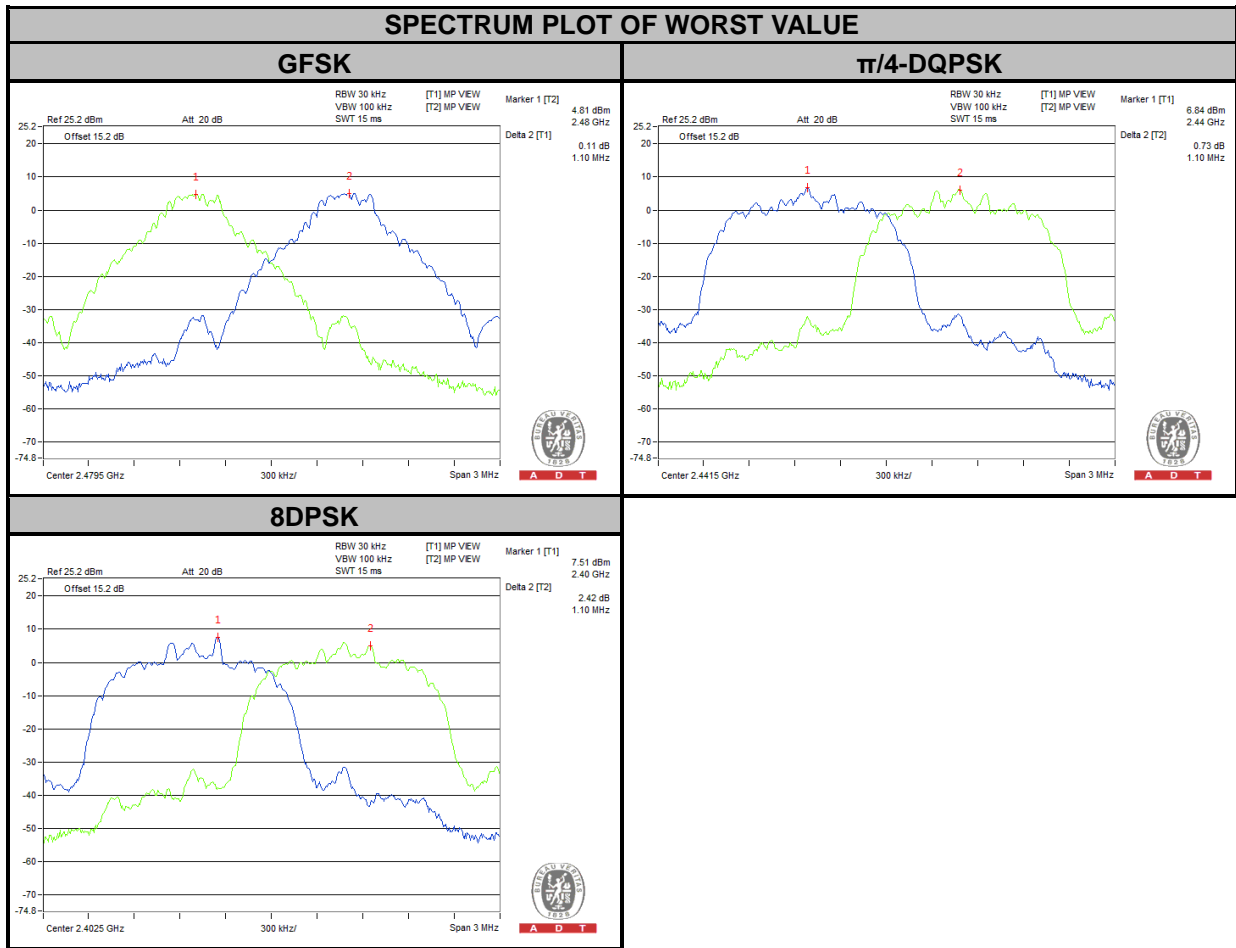

4.7 MAXIMUM OUTPUT POWER

4.7.1 LIMITS OF MAXIMUM OUTPUT POWER MEASUREMENT

The Maximum Output Power Measurement is 125mW.

4.7.2 TEST SETUP

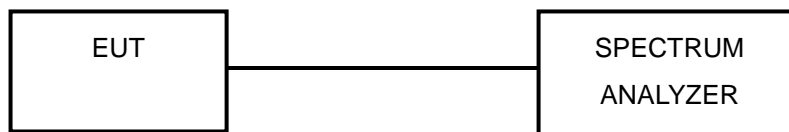

4.7.3 TEST INSTRUMENTS

Refer to section 4.1.2 to get information of above instrument.

4.7.4 TEST PROCEDURE

- a. Check the calibration of the measuring instrument using either an internal calibrator or a known signal from an external generator.
- b. Turn on the EUT and connect it to measurement instrument. Then set it to any one convenient frequency within its operating range. Set a reference level on the measuring instrument equal to the highest peak value.
- c. The center frequency of the spectrum analyzer is set to the fundamental frequency and using 3MHz RBW and 10 MHz VBW.
- d. Measure the captured power within the band and recording the plot.
- e. Repeat above procedures until all frequencies required were complete.

4.7.5 DEVIATION FROM TEST STANDARD

No deviation.

4.7.6 EUT OPERATING CONDITION

The software provided by client enabled the EUT to transmit and receive data at lowest, middle and highest channel frequencies individually.



A D T

4.7.7 TEST RESULTS

CHANNEL	FREQUENCY (MHz)	OUTPUT POWER (mW)			OUTPUT POWER (dBm)			POWER LIMIT (mW)	PASS / FAIL
		GFSK	$\pi/4$ -DQPSK	8DPSK	GFSK	$\pi/4$ -DQPSK	8DPSK		
0	2402	7.031	9.908	9.727	8.47	9.96	9.88	125	PASS
39	2441	11.298	14.723	13.092	10.53	11.68	11.17	125	PASS
78	2480	4.819	6.950	6.457	6.83	8.42	8.10	125	PASS

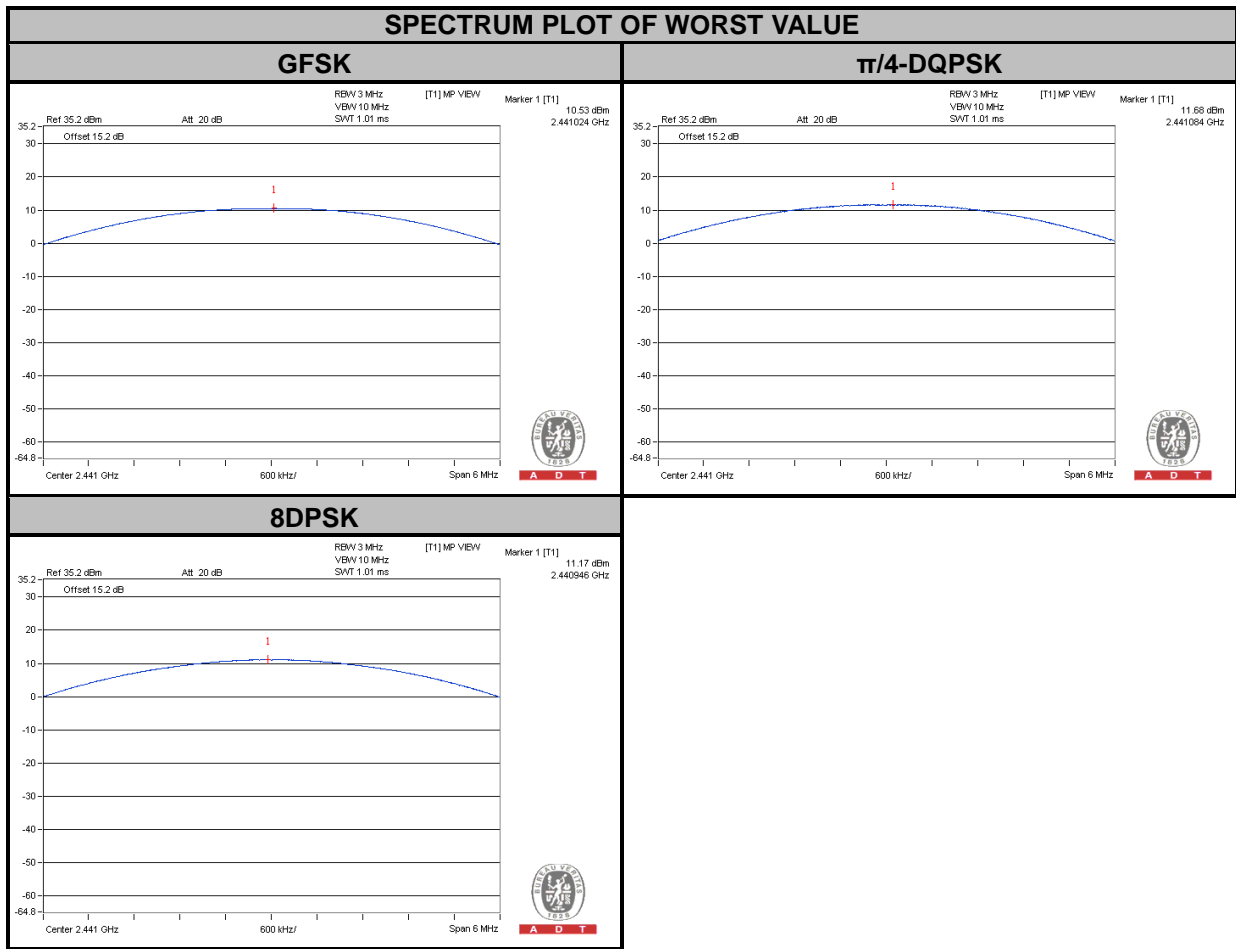



A D T

4.8 CONDUCTED OUT OF BAND EMISSION MEASUREMENT

4.8.1 LIMITS OF CONDUCTED OUT OF BAND EMISSION MEASUREMENT

Below -20dB of the highest emission level of operating band (in 100KHz RBW).

4.8.2 TEST INSTRUMENTS

Refer to section 4.1.2 to get information of above instrument.

4.8.3 TEST PROCEDURE

1. Set RBW = 100 kHz.
2. Set VBW = 300 kHz.
3. Set span to encompass the spectrum to be examined.
4. Detector = peak.
5. Trace Mode = max hold.
6. Sweep = auto couple.

4.8.4 DEVIATION FROM TEST STANDARD

No deviation.

4.8.5 EUT OPERATING CONDITION

The software provided by client enabled the EUT to transmit continuously.

4.8.6 TEST RESULTS

The spectrum plots are attached on the following images. D1 line indicates the highest level, D2 line indicates the 20dB offset below D1. It shows compliance with the requirement.



A D T

GFSK

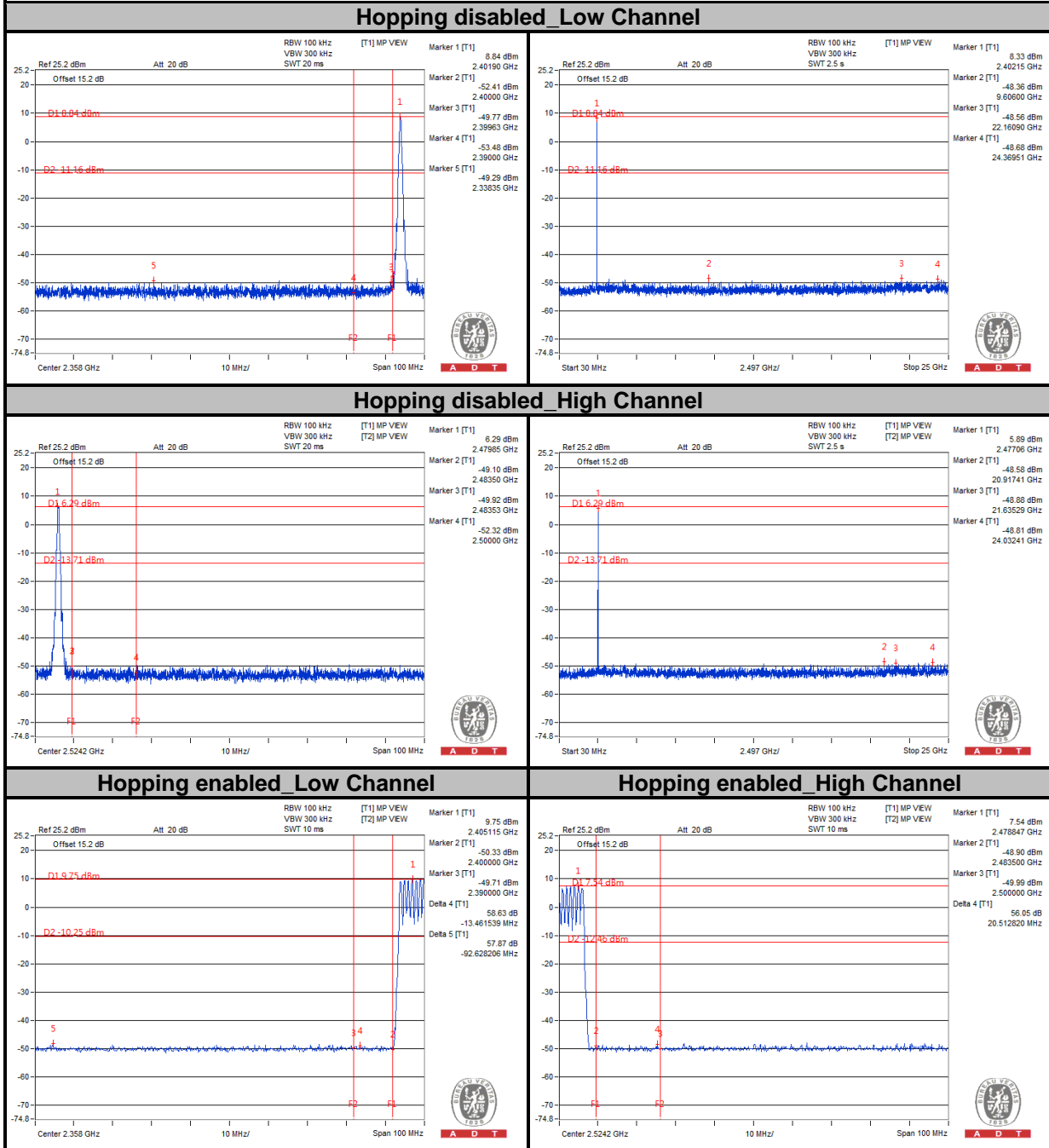



A D T

$\pi/4$ -DQPSK

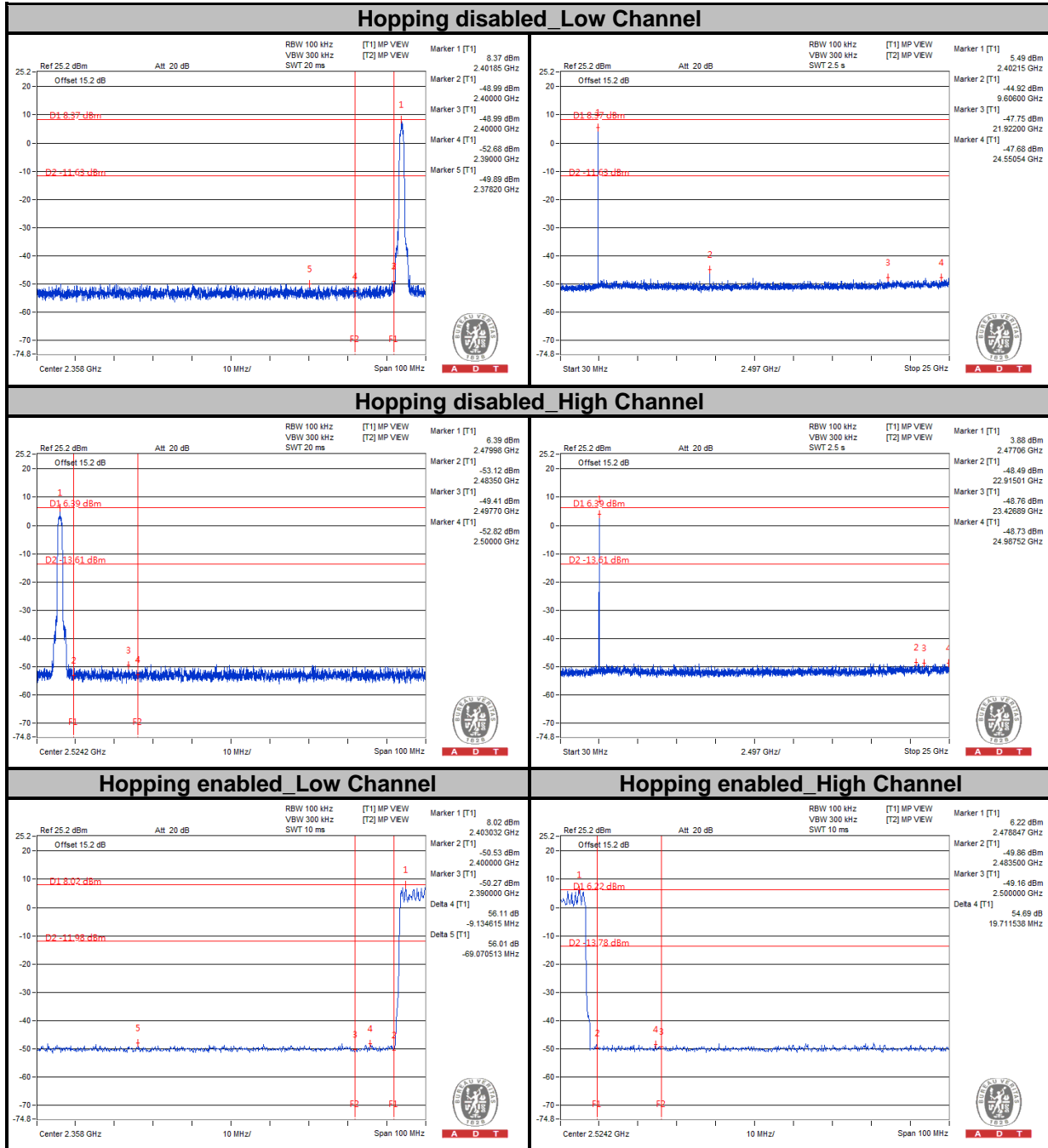



A D T

8DPSK

Hopping disabled_Low Channel

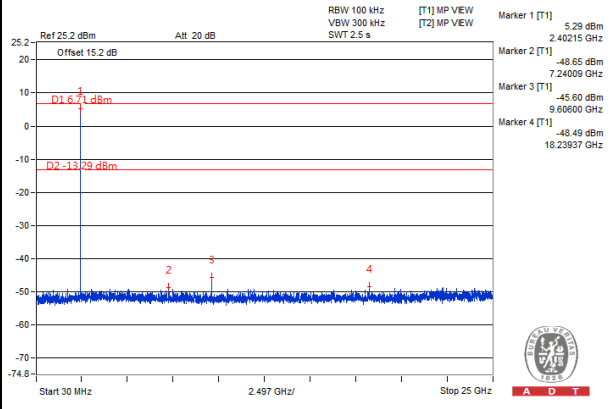
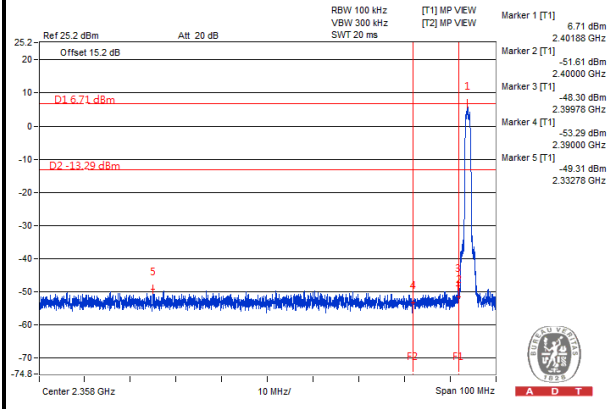

Hopping disabled_High Channel

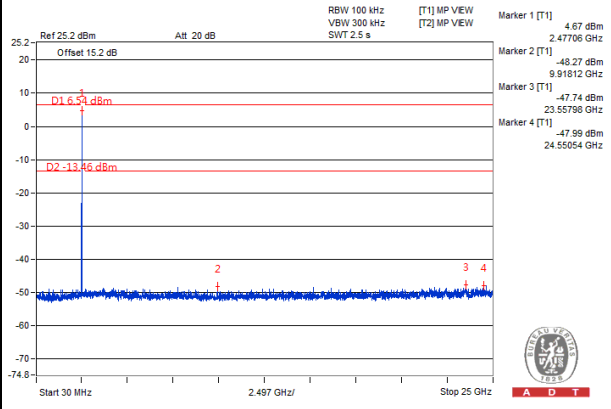
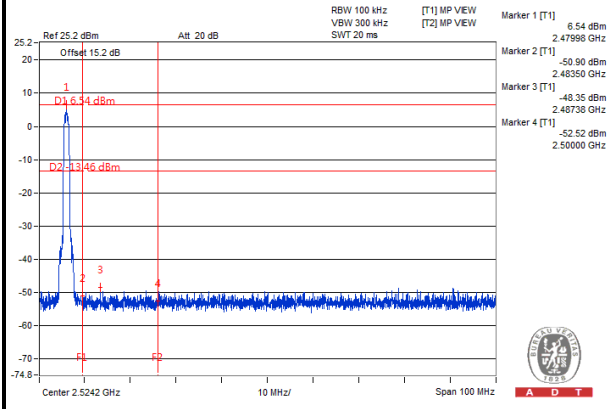

Hopping enabled_Low Channel

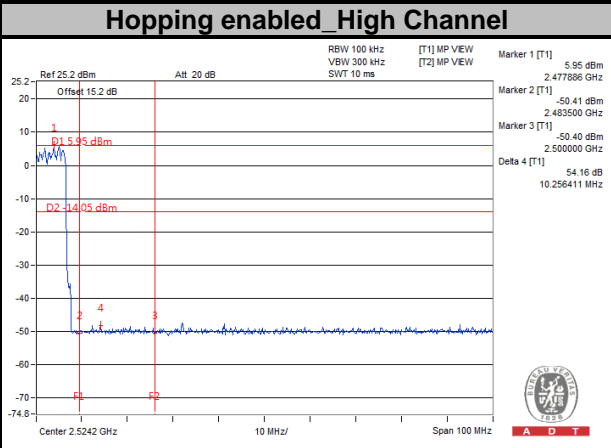
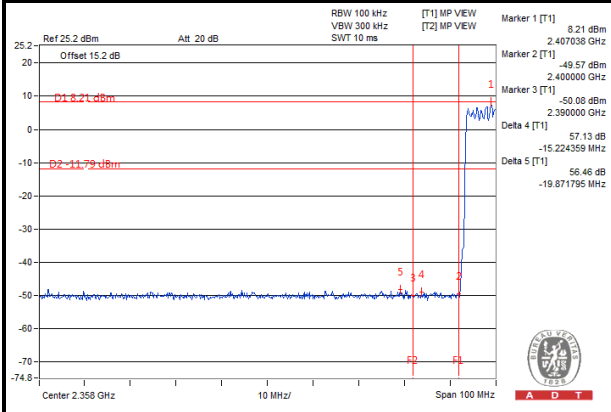



A D T

5. PHOTOGRAPHS OF THE TEST CONFIGURATION

Please refer to the attached file (Test Setup Photo).



6. INFORMATION ON THE TESTING LABORATORIES

We, Bureau Veritas Consumer Products Services (H.K.) Ltd., Taoyuan Branch, were founded in 1988 to provide our best service in EMC, Radio, Telecom and Safety consultation. Our laboratories are accredited and approved according to ISO/IEC 17025.

If you have any comments, please feel free to contact us at the following:

Linko EMC/RF Lab:

Tel: 886-2-26052180

Fax: 886-2-26051924

Hsin Chu EMC/RF/Telecom Lab:

Tel: 886-3-5935343

Fax: 886-3-5935342

Hwa Ya EMC/RF/Safety Lab:

Tel: 886-3-3183232

Fax: 886-3-3270892

Email: service.adt@tw.bureauveritas.com

Web Site: www.bureauveritas-adt.com

The address and road map of all our labs can be found in our web site also.



A D T

7. APPENDIX A – MODIFICATIONS RECORDERS FOR ENGINEERING CHANGES TO THE EUT BY THE LAB

No any modifications are made to the EUT by the lab during the test.

---END---