



FCC TEST REPORT (15.247)

REPORT NO.: RF150714C29-4
MODEL NAME: OPM9310
FCC ID: NM80PM9310
RECEIVED: Mar. 24, 2015
TESTED: May 08, 2015 ~ May 15, 2015
ISSUED: Jul. 31, 2015

APPLICANT: HTC Corporation

ADDRESS: 1F, 6-3 Baoqiang Road, Xindian District, New Taipei City, Taiwan 231

ISSUED BY: Bureau Veritas Consumer Products Services (H.K.) Ltd., Taoyuan Branch

LAB ADDRESS: No. 47-2, 14th Ling, Chia Pau Vil., Lin Kou Dist., New Taipei City, Taiwan (R.O.C)

TEST LOCATION: No. 19, Hwa Ya 2nd Rd, Wen Hwa Vil., Kwei Shan Dist., Taoyuan City 333, Taiwan, R.O.C.

This report should not be used by the client to claim product certification, approval, or endorsement by TAF or any government agencies.



This report is for your exclusive use. Any copying or replication of this report to or for any other person or entity, or use of our name or trademark, is permitted only with our prior written permission. This report sets forth our findings solely with respect to the test samples identified herein. The results set forth in this report are not indicative or representative of the quality or characteristics of the lot from which a test sample was taken or any similar or identical product unless specifically and expressly noted. Our report includes all of the tests requested by you and the results thereof based upon the information that you provided to us. You have 60 days from date of issuance of this report to notify us of any material error or omission caused by our negligence, provided, however, that such notice shall be in writing and shall specifically address the issue you wish to raise. A failure to raise such issue within the prescribed time shall constitute your unqualified acceptance of the completeness of this report, the tests conducted and the correctness of the report contents. Unless specific mention, the uncertainty of measurement has been explicitly taken into account to declare the compliance or non-compliance to the specification.



TABLE OF CONTENTS

- RELEASE CONTROL RECORD4
- 1. CERTIFICATION.....5
- 2. SUMMARY OF TEST RESULTS6
 - 2.1 MEASUREMENT UNCERTAINTY.....6
- 3. GENERAL INFORMATION7
 - 3.1 GENERAL DESCRIPTION OF EUT7
 - 3.2 DESCRIPTION OF TEST MODES8
 - 3.2.1 TEST MODE APPLICABILITY AND TESTED CHANNEL DETAIL9
 - 3.3 DESCRIPTION OF SUPPORT UNITS11
 - 3.3.1 CONFIGURATION OF SYSTEM UNDER TEST11
 - 3.4 DUTY CYCLE TEST SIGNAL12
 - 3.5 GENERAL DESCRIPTION OF APPLIED STANDARDS13
- 4. TEST TYPES AND RESULTS (FOR 2.4GHz BAND)14
 - 4.1 RADIATED EMISSION AND BANDEDGE MEASUREMENT14
 - 4.1.1 LIMITS OF RADIATED EMISSION AND BANDEDGE MEASUREMENT14
 - 4.1.2 TEST INSTRUMENTS15
 - 4.1.3 TEST PROCEDURES16
 - 4.1.4 DEVIATION FROM TEST STANDARD16
 - 4.1.5 TEST SETUP17
 - 4.1.6 EUT OPERATING CONDITIONS17
 - 4.1.7 TEST RESULTS.....18
 - 4.2 CONDUCTED EMISSION MEASUREMENT28
 - 4.2.1 LIMITS OF CONDUCTED EMISSION MEASUREMENT28
 - 4.2.2 TEST INSTRUMENTS.....28
 - 4.2.3 TEST PROCEDURES29
 - 4.2.4 DEVIATION FROM TEST STANDARD29
 - 4.2.5 TEST SETUP30
 - 4.2.6 EUT OPERATING CONDITIONS30
 - 4.2.7 TEST RESULTS.....31
 - 4.3 6dB BANDWIDTH MEASUREMENT33
 - 4.3.1 LIMITS OF 6dB BANDWIDTH MEASUREMENT33
 - 4.3.2 TEST SETUP33
 - 4.3.3 TEST INSTRUMENTS.....33
 - 4.3.4 TEST PROCEDURE33
 - 4.3.5 DEVIATION FROM TEST STANDARD33
 - 4.3.6 EUT OPERATING CONDITIONS33
 - 4.3.7 TEST RESULTS.....34
 - 4.4 CONDUCTED OUTPUT POWER36
 - 4.4.1 LIMITS OF CONDUCTED OUTPUT POWER MEASUREMENT36
 - 4.4.2 TEST SETUP36
 - 4.4.3 TEST INSTRUMENTS.....36
 - 4.4.4 TEST PROCEDURES36
 - 4.4.5 DEVIATION FROM TEST STANDARD36
 - 4.4.6 EUT OPERATING CONDITIONS36
 - 4.4.7 TEST RESULTS.....37
 - 4.5 POWER SPECTRAL DENSITY MEASUREMENT.....38
 - 4.5.1 LIMITS OF POWER SPECTRAL DENSITY MEASUREMENT38
 - 4.5.2 TEST SETUP38
 - 4.5.3 TEST INSTRUMENTS.....38
 - 4.5.4 TEST PROCEDURE38
 - 4.5.5 DEVIATION FROM TEST STANDARD38
 - 4.5.6 EUT OPERATING CONDITION.....38



A D T

4.5.7	TEST RESULTS.....	39
4.6	CONDUCTED OUT OF BAND EMISSION MEASUREMENT	41
4.6.1	LIMITS OF CONDUCTED OUT OF BAND EMISSION MEASUREMENT	41
4.6.2	TEST SETUP	41
4.6.3	TEST INSTRUMENTS	41
4.6.4	TEST PROCEDURE	41
4.6.5	DEVIATION FROM TEST STANDARD	41
4.6.6	EUT OPERATING CONDITION.....	41
4.6.7	TEST RESULTS.....	42
5.	PHOTOGRAPHS OF THE TEST CONFIGURATION.....	48
6.	INFORMATION ON THE TESTING LABORATORIES	49
7.	APPENDIX A – MODIFICATIONS RECORDERS FOR ENGINEERING CHANGES TO THE EUT BY THE LAB	50



A D T

RELEASE CONTROL RECORD

ISSUE NO.	REASON FOR CHANGE	DATE ISSUED
RF150714C29-4	Original release	Jul. 31, 2015

2. SUMMARY OF TEST RESULTS

The EUT has been tested according to the following specifications:

APPLIED STANDARD: FCC PART 15, SUBPART C (SECTION 15.247)			
STANDARD SECTION	TEST TYPE	RESULT	REMARK
15.207	AC Power Conducted Emission	PASS	Meet the requirement of limit. Minimum passing margin is -9.55dB at 0.23993MHz.
15.205 & 15.209	Radiated Emissions	PASS	Meet the requirement of limit. Minimum passing margin is -1.13dB at 2483.50MHz.
15.247(d)	Band Edge Measurement	PASS	Meet the requirement of limit.
15.247(d)	Antenna Port Emission	PASS	Meet the requirement of limit.
15.247(a)(2)	6dB bandwidth	PASS	Meet the requirement of limit.
15.247(b)	Conducted power	PASS	Meet the requirement of limit.
15.247(e)	Power Spectral Density	PASS	Meet the requirement of limit.
15.203	Antenna Requirement	PASS	No antenna connector is used.

2.1 MEASUREMENT UNCERTAINTY

Where relevant, the following measurement uncertainty levels have been estimated for tests performed on the EUT as specified in CISPR 16-4-2:

MEASUREMENT	FREQUENCY	UNCERTAINTY
Conducted emissions	9kHz~30MHz	2.44 dB
Radiated emissions	30MHz ~ 200MHz	2.93 dB
	200MHz ~1000MHz	2.95 dB
	1GHz ~ 18GHz	2.26 dB
	18GHz ~ 40GHz	1.94 dB

This uncertainty represents an expanded uncertainty expressed at approximately the 95% confidence level using a coverage factor of $k = 2$.



A D T

3. GENERAL INFORMATION

3.1 GENERAL DESCRIPTION OF EUT

EUT	Smartphone
MODEL NAME	OPM9310
POWER SUPPLY	5.0Vdc (adapter or host equipment) 3.85Vdc (Li-ion battery)
MODULATION TYPE	CCK, DQPSK, DBPSK for DSSS 64QAM, 16QAM, QPSK, BPSK for OFDM
MODULATION TECHNOLOGY	DSSS, OFDM
TRANSFER RATE	802.11b: 11.0 / 5.5 / 2.0 / 1.0 Mbps 802.11g: 54.0 / 48.0 / 36.0 / 24.0 / 18.0 / 12.0 / 9.0 / 6.0 Mbps 802.11n: up to MCS7
OPERATING FREQUENCY	2412 ~ 2462MHz
NUMBER OF CHANNEL	11
OUTPUT POWER	213.80mW
ANTENNA TYPE	PIFA antenna with -0.5dBi gain
ANTENNA CONNECTOR	NA
DATA CABLE	Refer to Note as below
I/O PORTS	Refer to user's manual
ACCESSORY DEVICES	Refer to Note as below

NOTE:

1. The EUT's accessories list refers to Ext. Pho.
2. The above EUT information is declared by the manufacturer and for more detailed features description, please refer to the manufacturer's specifications or User's Manual.

3.2 DESCRIPTION OF TEST MODES

FOR 2.4GHz:

11 channels are provided for 802.11b, 802.11g and 802.11n (20MHz):

CHANNEL	FREQUENCY	CHANNEL	FREQUENCY
1	2412MHz	7	2442MHz
2	2417MHz	8	2447MHz
3	2422MHz	9	2452MHz
4	2427MHz	10	2457MHz
5	2432MHz	11	2462MHz
6	2437MHz		



A D T

3.2.1 TEST MODE APPLICABILITY AND TESTED CHANNEL DETAIL

WLAN 2.4GHz:

EUT CONFIGURE MODE	APPLICABLE TO				DESCRIPTION
	RE≥1G	RE<1G	PLC	APCM	
-	√	√	√	√	-

Where **RE≥1G**: Radiated Emission above 1GHz **RE<1G**: Radiated Emission below 1GHz
PLC: Power Line Conducted Emission **APCM**: Antenna Port Conducted Measurement

NOTE: The EUT had been pre-tested on the positioned of each 3 axis. The worst case was found when positioned on **Y-plane**.

RADIATED EMISSION TEST (ABOVE 1GHz):

Pre-Scan has been conducted to determine the worst-case mode from all possible combinations between available modulations, data rates and antenna ports (if EUT with antenna diversity architecture).

Following channel(s) was (were) selected for the final test as listed below.

EUT CONFIGURE MODE	MODE	AVAILABLE CHANNEL	TESTED CHANNEL	MODULATION TECHNOLOGY	MODULATION TYPE	DATA RATE (Mbps)
-	802.11b	1 to 11	1, 6, 11	DSSS	DBPSK	1.0
	802.11g	1 to 11	1, 6, 11	OFDM	BPSK	6.0
	802.11n (20MHz)	1 to 11	1, 6, 11	OFDM	BPSK	MCS0

RADIATED EMISSION TEST (BELOW 1GHz):

Pre-Scan has been conducted to determine the worst-case mode from all possible combinations between available modulations, data rates and antenna ports (if EUT with antenna diversity architecture).

Following channel(s) was (were) selected for the final test as listed below.

EUT CONFIGURE MODE	MODE	AVAILABLE CHANNEL	TESTED CHANNEL	MODULATION TECHNOLOGY	MODULATION TYPE	DATA RATE (Mbps)
-	802.11n (20MHz)	1 to 11	11	OFDM	BPSK	MCS0

POWER LINE CONDUCTED EMISSION TEST:

Pre-Scan has been conducted to determine the worst-case mode from all possible combinations between available modulations, data rates and antenna ports (if EUT with antenna diversity architecture).

Following channel(s) was (were) selected for the final test as listed below.

EUT CONFIGURE MODE	MODE	AVAILABLE CHANNEL	TESTED CHANNEL	MODULATION TECHNOLOGY	MODULATION TYPE	DATA RATE (Mbps)
-	802.11n (20MHz)	1 to 11	11	OFDM	BPSK	MCS0



BANDEDGE MEASUREMENT:

- Pre-Scan has been conducted to determine the worst-case mode from all possible combinations between available modulations, data rates and antenna ports (if EUT with antenna diversity architecture).
- Following channel(s) was (were) selected for the final test as listed below.

EUT CONFIGURE MODE	MODE	AVAILABLE CHANNEL	TESTED CHANNEL	MODULATION TECHNOLOGY	MODULATION TYPE	DATA RATE (Mbps)
-	802.11b	1 to 11	1, 6, 11	DSSS	DBPSK	1.0
	802.11g	1 to 11	1, 6, 11	OFDM	BPSK	6.0
	802.11n (20MHz)	1 to 11	1, 6, 11	OFDM	BPSK	MCS0

ANTENNA PORT CONDUCTED MEASUREMENT:

- This item includes all test value of each mode, but only includes spectrum plot of worst value of each mode.
- Pre-Scan has been conducted to determine the worst-case mode from all possible combinations between available modulations, data rates and antenna ports (if EUT with antenna diversity architecture).
- Following channel(s) was (were) selected for the final test as listed below.

EUT CONFIGURE MODE	MODE	AVAILABLE CHANNEL	TESTED CHANNEL	MODULATION TECHNOLOGY	MODULATION TYPE	DATA RATE (Mbps)
-	802.11b	1 to 11	1, 6, 11	DSSS	DBPSK	1.0
	802.11g	1 to 11	1, 6, 11	OFDM	BPSK	6.0
	802.11n (20MHz)	1 to 11	1, 6, 11	OFDM	BPSK	MCS0

TEST CONDITION:

APPLICABLE TO	ENVIRONMENTAL CONDITIONS	INPUT POWER	TESTED BY
RE≥1G	25deg. C, 65%RH	120Vac, 60Hz	Will Chen
RE<1G	25deg. C, 65%RH	120Vac, 60Hz	Will Chen
PLC	25deg. C, 65%RH	120Vac, 60Hz	Toby Tian
APCM	25deg. C, 65%RH	3.85Vdc	Taylor Liu

3.3 DESCRIPTION OF SUPPORT UNITS

The EUT has been tested as an independent unit together with other necessary accessories or support units.

3.3.1 CONFIGURATION OF SYSTEM UNDER TEST

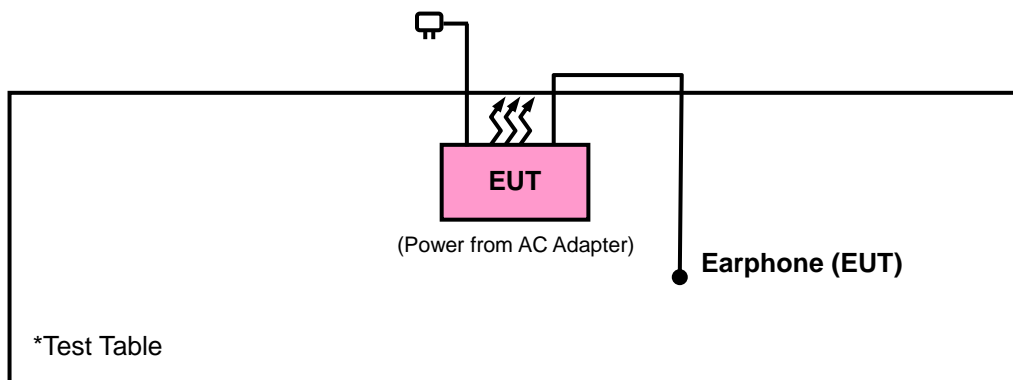

3.4 DUTY CYCLE TEST SIGNAL

WLAN 2.4GHz

802.11b: Duty cycle of test signal is 100 %

802.11g: Duty cycle = $1.350/1.383 = 0.976$, Duty factor = $10 * \log(1/0.976) = 0.11$

802.11n (20MHz): Duty cycle of test signal is > 98 %

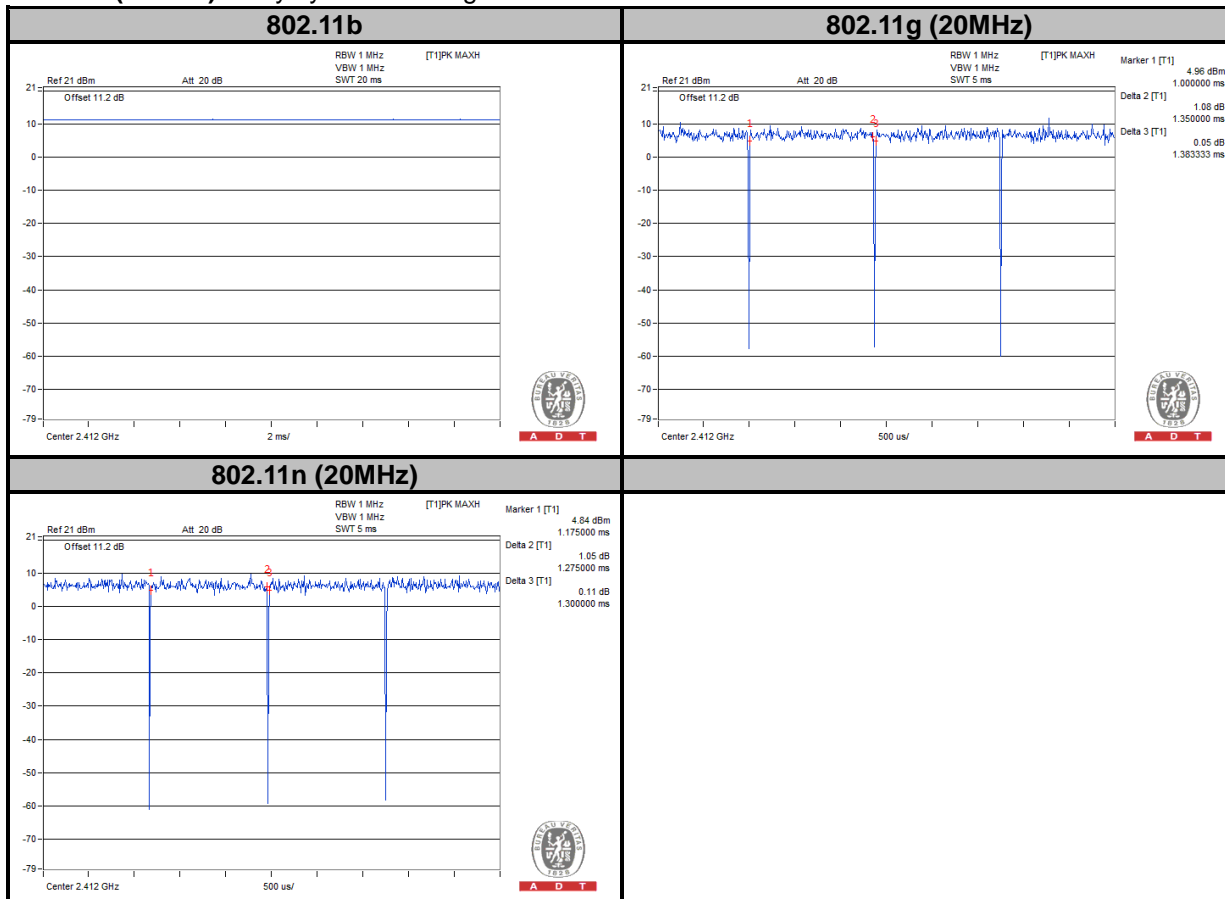



3.5 GENERAL DESCRIPTION OF APPLIED STANDARDS

The EUT is a RF Product. According to the specifications of the manufacturer, it must comply with the requirements of the following standards:

FCC Part 15, Subpart C (15.247)

558074 D01 DTS Meas Guidance v03r02

ANSI C63.10-2009

All test items have been performed and recorded as per the above standards.

NOTE: The EUT has been verified to comply with the requirements of FCC Part 15, Subpart B, Class B (DoC). The test report has been issued separately.

4. TEST TYPES AND RESULTS (FOR 2.4GHz BAND)

4.1 RADIATED EMISSION AND BANDEDGE MEASUREMENT

4.1.1 LIMITS OF RADIATED EMISSION AND BANDEDGE MEASUREMENT

Radiated emissions which fall in the restricted bands must comply with the radiated emission limits specified as below table. Other emissions shall be at least 20dB below the highest level of the desired power:

FREQUENCIES (MHz)	FIELD STRENGTH (microvolts/meter)	MEASUREMENT DISTANCE (meters)
0.009 ~ 0.490	2400/F(kHz)	300
0.490 ~ 1.705	24000/F(kHz)	30
1.705 ~ 30.0	30	30
30 ~ 88	100	3
88 ~ 216	150	3
216 ~ 960	200	3
Above 960	500	3

NOTE:

1. The lower limit shall apply at the transition frequencies.
2. Emission level (dBuV/m) = 20 log Emission level (uV/m).
3. For frequencies above 1000MHz, the field strength limits are based on average detector, however, the peak field strength of any emission shall not exceed the maximum permitted average limits, specified above by more than 20dB under any condition of modulation.



4.1.2 TEST INSTRUMENTS

DESCRIPTION & MANUFACTURER	MODEL NO.	SERIAL NO.	DATE OF CALIBRATION	DUE DATE OF CALIBRATION
Test Receiver Agilent	N9038A	MY51210203	Jan. 21, 2015	Jan. 21, 2016
Spectrum Analyzer Agilent	N9010A	MY52220314	Sep. 03, 2014	Sep. 02, 2015
Spectrum Analyzer ROHDE & SCHWARZ	FSU43	101261	Dec. 10, 2014	Dec. 09, 2015
BILOG Antenna SCHWARZBECK	VULB9168	9168-472	Feb. 04, 2015	Feb. 04, 2016
HORN Antenna SCHWARZBECK	BBHA 9120 D	9120D-969	Feb. 09, 2015	Feb. 09, 2016
HORN Antenna SCHWARZBECK	BBHA 9170	9170-480	Feb. 04, 2015	Feb. 04, 2016
Loop Antenna	EM-6879	269	Aug. 13, 2014	Aug. 12, 2015
Preamplifier EMCI	EMC 012645	980115	Dec. 12, 2014	Dec. 11, 2015
Preamplifier EMCI	EMC 184045	980116	Jan. 09, 2015	Jan. 08, 2016
Preamplifier EMCI	EMC 330H	980112	Dec. 27, 2014	Dec. 26, 2015
Power Meter Anritsu	ML2495A	1232002	Sep. 17, 2014	Sep. 16, 2015
Power Sensor Anritsu	MA2411B	1207325	Sep. 17, 2014	Sep. 16, 2015
RF signal cable HUBER+SUHNNER	SUCOFLEX 104	309219/4 2950114	Oct. 18, 2014	Oct. 17, 2015
RF signal cable HUBER+SUHNNER	SUCOFLEX 104	250130/4	Oct. 18, 2014	Oct. 17, 2015
RF Coaxial Cable Worken	8D-FB	Cable-Ch10-01	Nov. 07, 2014	Nov. 06, 2015
Software BV ADT	E3 6.120103	NA	NA	NA
Antenna Tower MF	MFA-440H	NA	NA	NA
Turn Table MF	MFT-201SS	NA	NA	NA
Antenna Tower & Turn Table Controller MF	MF-7802	NA	NA	NA

- NOTE:**
1. The calibration interval of the above test instruments is 12 months and the calibrations are traceable to NML/ROC and NIST/USA.
 2. The test was performed in HwaYa Chamber 10.
 3. The horn antenna and HP preamplifier (model: 8449B) are used only for the measurement of emission frequency above 1GHz if tested.
 4. The FCC Site Registration No. is 690701.
 5. The IC Site Registration No. is IC 7450F-10.

4.1.3 TEST PROCEDURES

- a. The EUT was placed on the top of a rotating table 0.8 meters (for below 1GHz) / 1.5 meters (for above 1GHz) above the ground at 3 meter chamber room for test. The table was rotated 360 degrees to determine the position of the highest radiation.
- b. The EUT was set 3 meters away from the interference-receiving antenna, which was mounted on the top of a variable-height antenna tower.
- c. Height of receiving antenna is varied from one meter to four meters above the ground to determine the maximum value of the field strength. Both horizontal and vertical polarizations of the antenna are set to make the measurement.
- d. For each suspected emission, the EUT was arranged to its worst case and then the antenna was tuned to heights from 1 meter to 4 meters and the rotatable table was turned from 0 degrees to 360 degrees to find the maximum reading.
- e. The test-receiver system was set to Peak Detect Function and Specified Bandwidth with Maximum Hold Mode.
- f. If the emission level of the EUT in peak mode was lower than the limit specified, then testing could be stopped and the peak values of the EUT would be reported. Otherwise the emissions would be re-tested one by one using peak, quasi-peak or average method as specified and then reported in a data sheet.

NOTE:

1. The resolution bandwidth and video bandwidth of test receiver/spectrum analyzer is 120kHz for Quasi-peak detection at frequency below 1GHz.
2. The resolution bandwidth of test receiver/spectrum analyzer is 1MHz and video bandwidth is 3MHz for Peak detection at frequency above 1GHz.
3. The resolution bandwidth of test receiver/spectrum analyzer is 1MHz and the video bandwidth is 1kHz (Duty cycle < 98%) or 10Hz (Duty cycle > 98%) for Average detection (AV) at frequency above 1GHz.
4. All modes of operation were investigated and the worst-case emissions are reported.

4.1.4 DEVIATION FROM TEST STANDARD

No deviation.

4.1.5 TEST SETUP

<Frequency Range 30MHz ~ 1GHz>

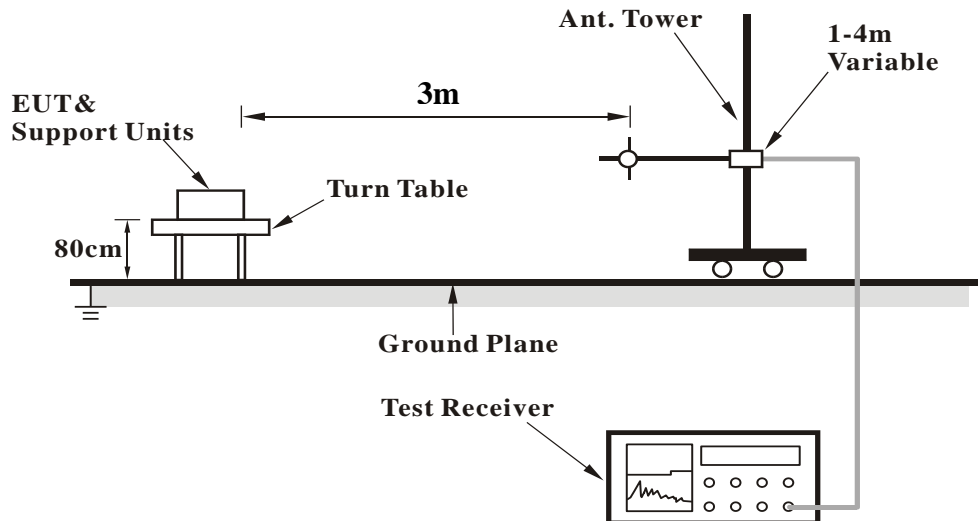

<Frequency Range above 1GHz>

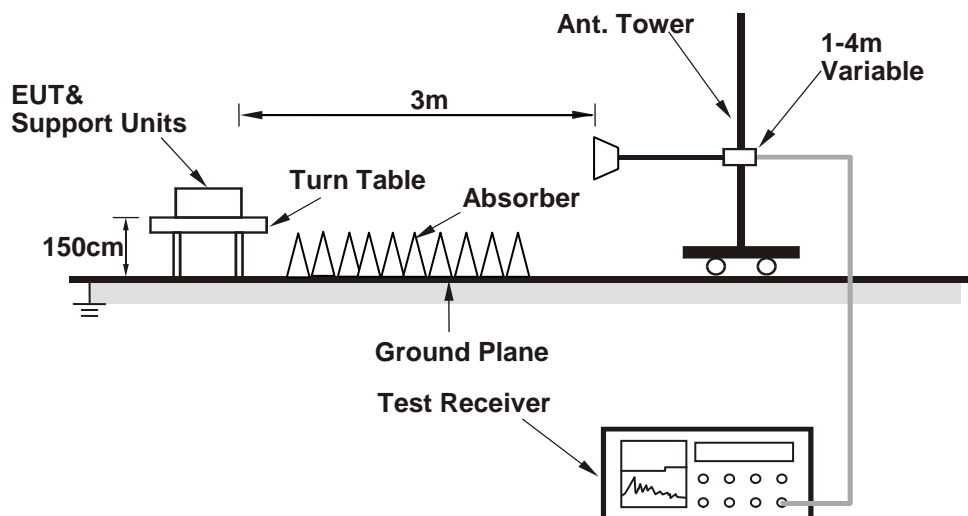

For the actual test configuration, please refer to the attached file (Test Setup Photo).

4.1.6 EUT OPERATING CONDITIONS

- Placed the EUT on a testing table.
- Use the software to control the EUT under transmission condition continuously at specific channel frequency.



A D T

4.1.7 TEST RESULTS

ABOVE 1GHz WORST-CASE DATA

802.11b

EUT TEST CONDITION		MEASUREMENT DETAIL	
CHANNEL	Channel 1	FREQUENCY RANGE	1GHz ~ 25GHz
INPUT POWER	120Vac, 60 Hz	DETECTOR FUNCTION	Peak (PK) Average (AV)
ENVIRONMENTAL CONDITIONS	25deg. C, 65%RH	TESTED BY	Will Chen

ANTENNA POLARITY & TEST DISTANCE: HORIZONTAL AT 3 M

FREQ. (MHz)	EMISSION LEVEL (dBuV/m)	READ LEVEL (dBuV)	LIMIT (dBuV/m)	MARGIN (dB)	ANTENNA FACTOR (dB/m)	CABLE LOSS (dB)	PREAMP FACTOR (dB)	ANTENNA HEIGHT (cm)	TABLE ANGLE (Degree)	REMARK
2386	43.36	41.65	54	-10.64	31.8	5.4	35.49	125	166	Average
2386	55.35	53.64	74	-18.65	31.8	5.4	35.49	125	166	Peak
2412	108.77	107			31.81	5.43	35.47	125	166	Average
2412	111.02	109.25			31.81	5.43	35.47	125	166	Peak
2486	40.96	38.97	54	-13.04	31.88	5.53	35.42	125	166	Average
2486	55.91	53.92	74	-18.09	31.88	5.53	35.42	125	166	Peak

ANTENNA POLARITY & TEST DISTANCE: VERTICAL AT 3 M

FREQ. (MHz)	EMISSION LEVEL (dBuV/m)	READ LEVEL (dBuV)	LIMIT (dBuV/m)	MARGIN (dB)	ANTENNA FACTOR (dB/m)	CABLE LOSS (dB)	PREAMP FACTOR (dB)	ANTENNA HEIGHT (cm)	TABLE ANGLE (Degree)	REMARK
2390	41.43	39.7	54	-12.57	31.8	5.4	35.47	102	280	Average
2390	55.31	53.58	74	-18.69	31.8	5.4	35.47	102	280	Peak
2412	103.77	102			31.81	5.43	35.47	102	280	Average
2412	105.94	104.17			31.81	5.43	35.47	102	280	Peak
2500	40.67	38.65	54	-13.33	31.9	5.53	35.41	102	280	Average
2500	55.46	53.44	74	-18.54	31.9	5.53	35.41	102	280	Peak

REMARKS:

- Emission Level = Read Level + Antenna Factor + Cable Loss - Preamp Factor
Margin value = Emission level – Limit value
- 2412MHz: Fundamental frequency.



A D T

EUT TEST CONDITION		MEASUREMENT DETAIL	
CHANNEL	Channel 6	FREQUENCY RANGE	1GHz ~ 25GHz
INPUT POWER	120Vac, 60 Hz	DETECTOR FUNCTION	Peak (PK) Average (AV)
ENVIRONMENTAL CONDITIONS	25deg. C, 65%RH	TESTED BY	Will Chen

ANTENNA POLARITY & TEST DISTANCE: HORIZONTAL AT 3 M

FREQ. (MHz)	EMISSION LEVEL (dBuV/m)	READ LEVEL (dBuV)	LIMIT (dBuV/m)	MARGIN (dB)	ANTENNA FACTOR (dB/m)	CABLE LOSS (dB)	PREAMP FACTOR (dB)	ANTENNA HEIGHT (cm)	TABLE ANGLE (Degree)	REMARK
2378	40.36	38.7	54	-13.64	31.78	5.37	35.49	125	166	Average
2378	54.94	53.28	74	-19.06	31.78	5.37	35.49	125	166	Peak
2437	108.88	107.03			31.85	5.46	35.46	125	166	Average
2437	111.68	109.83			31.85	5.46	35.46	125	166	Peak
2486	40.65	38.66	54	-13.35	31.88	5.53	35.42	125	166	Average
2486	55.74	53.75	74	-18.26	31.88	5.53	35.42	125	166	Peak

ANTENNA POLARITY & TEST DISTANCE: VERTICAL AT 3 M

FREQ. (MHz)	EMISSION LEVEL (dBuV/m)	READ LEVEL (dBuV)	LIMIT (dBuV/m)	MARGIN (dB)	ANTENNA FACTOR (dB/m)	CABLE LOSS (dB)	PREAMP FACTOR (dB)	ANTENNA HEIGHT (cm)	TABLE ANGLE (Degree)	REMARK
2390	40.42	38.69	54	-13.58	31.8	5.4	35.47	102	280	Average
2390	54.97	53.24	74	-19.03	31.8	5.4	35.47	102	280	Peak
2437	103.34	101.49			31.85	5.46	35.46	102	280	Average
2437	106.02	104.17			31.85	5.46	35.46	102	280	Peak
2492	40.55	38.53	54	-13.45	31.9	5.53	35.41	102	280	Average
2492	55.11	53.09	74	-18.89	31.9	5.53	35.41	102	280	Peak

REMARKS:

- Emission Level = Read Level + Antenna Factor + Cable Loss - Preamp Factor
Margin value = Emission level – Limit value
- 2437MHz: Fundamental frequency.



A D T

EUT TEST CONDITION		MEASUREMENT DETAIL	
CHANNEL	Channel 11	FREQUENCY RANGE	1GHz ~ 25GHz
INPUT POWER	120Vac, 60 Hz	DETECTOR FUNCTION	Peak (PK) Average (AV)
ENVIRONMENTAL CONDITIONS	25deg. C, 65%RH	TESTED BY	Will Chen

ANTENNA POLARITY & TEST DISTANCE: HORIZONTAL AT 3 M

FREQ. (MHz)	EMISSION LEVEL (dBuV/m)	READ LEVEL (dBuV)	LIMIT (dBuV/m)	MARGIN (dB)	ANTENNA FACTOR (dB/m)	CABLE LOSS (dB)	PREAMP FACTOR (dB)	ANTENNA HEIGHT (cm)	TABLE ANGLE (Degree)	REMARK
2328	39.26	37.75	54	-14.74	31.73	5.3	35.52	125	166	Average
2328	55.19	53.68	74	-18.81	31.73	5.3	35.52	125	166	Peak
2462	108.89	106.96			31.87	5.5	35.44	125	166	Average
2462	111.84	109.91			31.87	5.5	35.44	125	166	Peak
2483.5	43.95	41.99	54	-10.05	31.88	5.5	35.42	125	166	Average
2483.5	56.13	54.17	74	-17.87	31.88	5.5	35.42	125	166	Peak

ANTENNA POLARITY & TEST DISTANCE: VERTICAL AT 3 M

FREQ. (MHz)	EMISSION LEVEL (dBuV/m)	READ LEVEL (dBuV)	LIMIT (dBuV/m)	MARGIN (dB)	ANTENNA FACTOR (dB/m)	CABLE LOSS (dB)	PREAMP FACTOR (dB)	ANTENNA HEIGHT (cm)	TABLE ANGLE (Degree)	REMARK
2382	39.41	37.72	54	-14.59	31.78	5.4	35.49	102	280	Average
2382	54.75	53.06	74	-19.25	31.78	5.4	35.49	102	280	Peak
2462	103.6	101.67			31.87	5.5	35.44	102	280	Average
2462	106.3	104.37			31.87	5.5	35.44	102	280	Peak
2488	41	38.99	54	-13	31.9	5.53	35.42	102	280	Average
2488	55.06	53.05	74	-18.94	31.9	5.53	35.42	102	280	Peak

REMARKS:

- Emission Level = Read Level + Antenna Factor + Cable Loss - Preamp Factor
Margin value = Emission level – Limit value
- 2462MHz: Fundamental frequency.



A D T

802.11g

EUT TEST CONDITION		MEASUREMENT DETAIL	
CHANNEL	Channel 1	FREQUENCY RANGE	1GHz ~ 25GHz
INPUT POWER	120Vac, 60 Hz	DETECTOR FUNCTION	Peak (PK) Average (AV)
ENVIRONMENTAL CONDITIONS	25deg. C, 65%RH	TESTED BY	Will Chen

ANTENNA POLARITY & TEST DISTANCE: HORIZONTAL AT 3 M										
FREQ. (MHz)	EMISSION LEVEL (dBuV/m)	READ LEVEL (dBuV)	LIMIT (dBuV/m)	MARGIN (dB)	ANTENNA FACTOR (dB/m)	CABLE LOSS (dB)	PREAMP FACTOR (dB)	ANTENNA HEIGHT (cm)	TABLE ANGLE (Degree)	REMARK
2390	52.73	51	54	-1.27	31.8	5.4	35.47	125	166	Average
2390	67.78	66.05	74	-6.22	31.8	5.4	35.47	125	166	Peak
2412	101.77	100			31.81	5.43	35.47	125	166	Average
2412	109.32	107.55			31.81	5.43	35.47	125	166	Peak
2498	40.65	38.63	54	-13.35	31.9	5.53	35.41	125	166	Average
2498	54.78	52.76	74	-19.22	31.9	5.53	35.41	125	166	Peak
ANTENNA POLARITY & TEST DISTANCE: VERTICAL AT 3 M										
FREQ. (MHz)	EMISSION LEVEL (dBuV/m)	READ LEVEL (dBuV)	LIMIT (dBuV/m)	MARGIN (dB)	ANTENNA FACTOR (dB/m)	CABLE LOSS (dB)	PREAMP FACTOR (dB)	ANTENNA HEIGHT (cm)	TABLE ANGLE (Degree)	REMARK
2390	47.46	45.73	54	-6.54	31.8	5.4	35.47	102	280	Average
2390	60.89	59.16	74	-13.11	31.8	5.4	35.47	102	280	Peak
2412	96.77	95			31.81	5.43	35.47	102	280	Average
2412	104.7	102.93			31.81	5.43	35.47	102	280	Peak
2490	40.64	38.63	54	-13.36	31.9	5.53	35.42	102	280	Average
2490	55.65	53.64	74	-18.35	31.9	5.53	35.42	102	280	Peak

REMARKS:

- Emission Level = Read Level + Antenna Factor + Cable Loss - Preamp Factor
Margin value = Emission level – Limit value
- 2412MHz: Fundamental frequency.



A D T

EUT TEST CONDITION		MEASUREMENT DETAIL	
CHANNEL	Channel 6	FREQUENCY RANGE	1GHz ~ 25GHz
INPUT POWER	120Vac, 60 Hz	DETECTOR FUNCTION	Peak (PK) Average (AV)
ENVIRONMENTAL CONDITIONS	25deg. C, 65%RH	TESTED BY	Will Chen

ANTENNA POLARITY & TEST DISTANCE: HORIZONTAL AT 3 M

FREQ. (MHz)	EMISSION LEVEL (dBuV/m)	READ LEVEL (dBuV)	LIMIT (dBuV/m)	MARGIN (dB)	ANTENNA FACTOR (dB/m)	CABLE LOSS (dB)	PREAMP FACTOR (dB)	ANTENNA HEIGHT (cm)	TABLE ANGLE (Degree)	REMARK
2388	40.43	38.72	54	-13.57	31.8	5.4	35.49	125	166	Average
2388	56.1	54.39	74	-17.9	31.8	5.4	35.49	125	166	Peak
2437	101.88	100.03			31.85	5.46	35.46	125	166	Average
2437	109.24	107.39			31.85	5.46	35.46	125	166	Peak
2498	40.67	38.65	54	-13.33	31.9	5.53	35.41	125	166	Average
2498	55.74	53.72	74	-18.26	31.9	5.53	35.41	125	166	Peak

ANTENNA POLARITY & TEST DISTANCE: VERTICAL AT 3 M

FREQ. (MHz)	EMISSION LEVEL (dBuV/m)	READ LEVEL (dBuV)	LIMIT (dBuV/m)	MARGIN (dB)	ANTENNA FACTOR (dB/m)	CABLE LOSS (dB)	PREAMP FACTOR (dB)	ANTENNA HEIGHT (cm)	TABLE ANGLE (Degree)	REMARK
2364	40.36	38.73	54	-13.64	31.76	5.37	35.5	102	280	Average
2364	55.59	53.96	74	-18.41	31.76	5.37	35.5	102	280	Peak
2437	96.84	94.99			31.85	5.46	35.46	102	280	Average
2437	104.35	102.5			31.85	5.46	35.46	102	280	Peak
2492	40	37.98	54	-14	31.9	5.53	35.41	102	280	Average
2492	56.42	54.4	74	-17.58	31.9	5.53	35.41	102	280	Peak

REMARKS:

- Emission Level = Read Level + Antenna Factor + Cable Loss - Preamp Factor
Margin value = Emission level – Limit value
- 2437MHz: Fundamental frequency.



A D T

EUT TEST CONDITION		MEASUREMENT DETAIL	
CHANNEL	Channel 11	FREQUENCY RANGE	1GHz ~ 25GHz
INPUT POWER	120Vac, 60 Hz	DETECTOR FUNCTION	Peak (PK) Average (AV)
ENVIRONMENTAL CONDITIONS	25deg. C, 65%RH	TESTED BY	Will Chen

ANTENNA POLARITY & TEST DISTANCE: HORIZONTAL AT 3 M

FREQ. (MHz)	EMISSION LEVEL (dBuV/m)	READ LEVEL (dBuV)	LIMIT (dBuV/m)	MARGIN (dB)	ANTENNA FACTOR (dB/m)	CABLE LOSS (dB)	PREAMP FACTOR (dB)	ANTENNA HEIGHT (cm)	TABLE ANGLE (Degree)	REMARK
2358	40.36	38.73	54	-13.64	31.76	5.37	35.5	125	166	Average
2358	55.29	53.66	74	-18.71	31.76	5.37	35.5	125	166	Peak
2462	101.89	99.96			31.87	5.5	35.44	125	166	Average
2462	109.22	107.29			31.87	5.5	35.44	125	166	Peak
2483.5	52.5	50.54	54	-1.5	31.88	5.5	35.42	125	166	Average
2483.5	71.45	69.49	74	-2.55	31.88	5.5	35.42	125	166	Peak

ANTENNA POLARITY & TEST DISTANCE: VERTICAL AT 3 M

FREQ. (MHz)	EMISSION LEVEL (dBuV/m)	READ LEVEL (dBuV)	LIMIT (dBuV/m)	MARGIN (dB)	ANTENNA FACTOR (dB/m)	CABLE LOSS (dB)	PREAMP FACTOR (dB)	ANTENNA HEIGHT (cm)	TABLE ANGLE (Degree)	REMARK
2350	40.31	38.74	54	-13.69	31.74	5.33	35.5	102	280	Average
2350	55.63	54.06	74	-18.37	31.74	5.33	35.5	102	280	Peak
2462	96.89	94.96			31.87	5.5	35.44	102	280	Average
2462	104.78	102.85			31.87	5.5	35.44	102	280	Peak
2483.5	47.25	45.29	54	-6.75	31.88	5.5	35.42	102	280	Average
2483.5	65.92	63.96	74	-8.08	31.88	5.5	35.42	102	280	Peak

REMARKS:

- Emission Level = Read Level + Antenna Factor + Cable Loss - Preamp Factor
Margin value = Emission level – Limit value
- 2462MHz: Fundamental frequency.



A D T

802.11n (20MHz)

EUT TEST CONDITION		MEASUREMENT DETAIL	
CHANNEL	Channel 1	FREQUENCY RANGE	1GHz ~ 25GHz
INPUT POWER	120Vac, 60 Hz	DETECTOR FUNCTION	Peak (PK) Average (AV)
ENVIRONMENTAL CONDITIONS	25deg. C, 65%RH	TESTED BY	Will Chen

ANTENNA POLARITY & TEST DISTANCE: HORIZONTAL AT 3 M										
FREQ. (MHz)	EMISSION LEVEL (dBuV/m)	READ LEVEL (dBuV)	LIMIT (dBuV/m)	MARGIN (dB)	ANTENNA FACTOR (dB/m)	CABLE LOSS (dB)	PREAMP FACTOR (dB)	ANTENNA HEIGHT (cm)	TABLE ANGLE (Degree)	REMARK
2390	52.77	51.04	54	-1.23	31.8	5.4	35.47	125	166	Average
2390	69.98	68.25	74	-4.02	31.8	5.4	35.47	125	166	Peak
2412	101.3	99.53			31.81	5.43	35.47	125	166	Average
2412	109.14	107.37			31.81	5.43	35.47	125	166	Peak
2486	39.94	37.95	54	-14.06	31.88	5.53	35.42	125	166	Average
2486	54.52	52.53	74	-19.48	31.88	5.53	35.42	125	166	Peak
ANTENNA POLARITY & TEST DISTANCE: VERTICAL AT 3 M										
FREQ. (MHz)	EMISSION LEVEL (dBuV/m)	READ LEVEL (dBuV)	LIMIT (dBuV/m)	MARGIN (dB)	ANTENNA FACTOR (dB/m)	CABLE LOSS (dB)	PREAMP FACTOR (dB)	ANTENNA HEIGHT (cm)	TABLE ANGLE (Degree)	REMARK
2390	47.15	45.42	54	-6.85	31.8	5.4	35.47	102	280	Average
2390	61.3	59.57	74	-12.7	31.8	5.4	35.47	102	280	Peak
2412	95.81	94.04			31.81	5.43	35.47	102	280	Average
2412	103.93	102.16			31.81	5.43	35.47	102	280	Peak
2490	39.67	37.66	54	-14.33	31.9	5.53	35.42	102	280	Average
2490	54.65	52.64	74	-19.35	31.9	5.53	35.42	102	280	Peak

REMARKS:

- Emission Level = Read Level + Antenna Factor + Cable Loss - Preamp Factor
Margin value = Emission level – Limit value
- 2412MHz: Fundamental frequency.



A D T

EUT TEST CONDITION		MEASUREMENT DETAIL	
CHANNEL	Channel 6	FREQUENCY RANGE	1GHz ~ 25GHz
INPUT POWER	120Vac, 60 Hz	DETECTOR FUNCTION	Peak (PK) Average (AV)
ENVIRONMENTAL CONDITIONS	25deg. C, 65%RH	TESTED BY	Will Chen

ANTENNA POLARITY & TEST DISTANCE: HORIZONTAL AT 3 M

FREQ. (MHz)	EMISSION LEVEL (dBuV/m)	READ LEVEL (dBuV)	LIMIT (dBuV/m)	MARGIN (dB)	ANTENNA FACTOR (dB/m)	CABLE LOSS (dB)	PREAMP FACTOR (dB)	ANTENNA HEIGHT (cm)	TABLE ANGLE (Degree)	REMARK
2348	39.61	38.04	54	-14.39	31.74	5.33	35.5	125	166	Average
2348	55.53	53.96	74	-18.47	31.74	5.33	35.5	125	166	Peak
2437	101.88	100.03			31.85	5.46	35.46	125	166	Average
2437	109.39	107.54			31.85	5.46	35.46	125	166	Peak
2490	40.67	38.66	54	-13.33	31.9	5.53	35.42	125	166	Average
2490	55.41	53.4	74	-18.59	31.9	5.53	35.42	125	166	Peak

ANTENNA POLARITY & TEST DISTANCE: VERTICAL AT 3 M

FREQ. (MHz)	EMISSION LEVEL (dBuV/m)	READ LEVEL (dBuV)	LIMIT (dBuV/m)	MARGIN (dB)	ANTENNA FACTOR (dB/m)	CABLE LOSS (dB)	PREAMP FACTOR (dB)	ANTENNA HEIGHT (cm)	TABLE ANGLE (Degree)	REMARK
2356	40.65	39.02	54	-13.35	31.76	5.37	35.5	102	280	Average
2356	55.84	54.21	74	-18.16	31.76	5.37	35.5	102	280	Peak
2437	96.84	94.99			31.85	5.46	35.46	102	280	Average
2437	104.66	102.81			31.85	5.46	35.46	102	280	Peak
2492	40.67	38.65	54	-13.33	31.9	5.53	35.41	102	280	Average
2492	55.41	53.39	74	-18.59	31.9	5.53	35.41	102	280	Peak

REMARKS:

- Emission Level = Read Level + Antenna Factor + Cable Loss - Preamp Factor
Margin value = Emission level – Limit value
- 2437MHz: Fundamental frequency.



A D T

EUT TEST CONDITION		MEASUREMENT DETAIL	
CHANNEL	Channel 11	FREQUENCY RANGE	1GHz ~ 25GHz
INPUT POWER	120Vac, 60 Hz	DETECTOR FUNCTION	Peak (PK) Average (AV)
ENVIRONMENTAL CONDITIONS	25deg. C, 65%RH	TESTED BY	Will Chen

ANTENNA POLARITY & TEST DISTANCE: HORIZONTAL AT 3 M

FREQ. (MHz)	EMISSION LEVEL (dBuV/m)	READ LEVEL (dBuV)	LIMIT (dBuV/m)	MARGIN (dB)	ANTENNA FACTOR (dB/m)	CABLE LOSS (dB)	PREAMP FACTOR (dB)	ANTENNA HEIGHT (cm)	TABLE ANGLE (Degree)	REMARK
2384	40.41	38.72	54	-13.59	31.78	5.4	35.49	125	166	Average
2384	55.45	53.76	74	-18.55	31.78	5.4	35.49	125	166	Peak
2462	101.89	99.96			31.87	5.5	35.44	125	166	Average
2462	109.81	107.88			31.87	5.5	35.44	125	166	Peak
2483.5	52.87	50.91	54	-1.13	31.88	5.5	35.42	125	166	Average
2483.5	71.83	69.87	74	-2.17	31.88	5.5	35.42	125	166	Peak

ANTENNA POLARITY & TEST DISTANCE: VERTICAL AT 3 M

FREQ. (MHz)	EMISSION LEVEL (dBuV/m)	READ LEVEL (dBuV)	LIMIT (dBuV/m)	MARGIN (dB)	ANTENNA FACTOR (dB/m)	CABLE LOSS (dB)	PREAMP FACTOR (dB)	ANTENNA HEIGHT (cm)	TABLE ANGLE (Degree)	REMARK
2326	40.26	38.75	54	-13.74	31.73	5.3	35.52	102	280	Average
2326	55.59	54.08	74	-18.41	31.73	5.3	35.52	102	280	Peak
2462	96.89	94.96			31.87	5.5	35.44	102	280	Average
2462	104.58	102.65			31.87	5.5	35.44	102	280	Peak
2483.5	47.95	45.99	54	-6.05	31.88	5.5	35.42	102	280	Average
2483.5	61.64	59.68	74	-12.36	31.88	5.5	35.42	102	280	Peak

REMARKS:

- Emission Level = Read Level + Antenna Factor + Cable Loss - Preamp Factor
Margin value = Emission level – Limit value
- 2462MHz: Fundamental frequency.



A D T

BELOW 1GHz WORST-CASE DATA:

802.11n (20MHz)

EUT TEST CONDITION		MEASUREMENT DETAIL	
CHANNEL	Channel 11	FREQUENCY RANGE	30MHz ~ 1GHz
INPUT POWER	120Vac, 60 Hz	DETECTOR FUNCTION	Peak (PK) Average (AV)
ENVIRONMENTAL CONDITIONS	25deg. C, 65%RH	TESTED BY	Will Chen

ANTENNA POLARITY & TEST DISTANCE: HORIZONTAL AT 3 M

FREQ. (MHz)	EMISSION LEVEL (dBuV/m)	READ LEVEL (dBuV)	LIMIT (dBuV/m)	MARGIN (dB)	ANTENNA FACTOR (dB/m)	CABLE LOSS (dB)	PREAMP FACTOR (dB)	ANTENNA HEIGHT (cm)	TABLE ANGLE (Degree)	REMARK
101.55	31.98	50.62	43.5	-11.52	12.34	1.28	32.26	175	94	Peak
143.13	28.17	50.67	43.5	-15.33	8.39	1.38	32.27	173	184	Peak
214.68	30.81	50.17	43.5	-12.69	11.23	1.65	32.24	108	281	Peak
566	17.69	29.67	46	-28.31	17.4	2.82	32.2	184	255	Peak
759.2	21.39	30.39	46	-24.61	19.91	3.22	32.13	184	73	Peak
941.9	23.8	29.66	46	-22.2	21.69	3.62	31.17	111	207	Peak

ANTENNA POLARITY & TEST DISTANCE: VERTICAL AT 3 M

FREQ. (MHz)	EMISSION LEVEL (dBuV/m)	READ LEVEL (dBuV)	LIMIT (dBuV/m)	MARGIN (dB)	ANTENNA FACTOR (dB/m)	CABLE LOSS (dB)	PREAMP FACTOR (dB)	ANTENNA HEIGHT (cm)	TABLE ANGLE (Degree)	REMARK
31.89	36.38	56.24	40	-3.62	11.66	0.74	32.26	164	284	Peak
47.82	36.69	53.5	40	-3.31	14.51	0.9	32.22	139	43	Peak
96.69	24.61	43.55	43.5	-18.89	11.88	1.28	32.1	117	247	Peak
582.1	18.7	30.41	46	-27.3	17.67	2.82	32.2	136	113	Peak
732.6	21.04	30.38	46	-24.96	19.63	3.16	32.13	144	281	Peak
955.9	24.68	30.21	46	-21.32	21.8	3.67	31	106	175	Peak

REMARKS: Emission Level = Read Level + Antenna Factor + Cable Loss - Preamp Factor

Margin value = Emission level – Limit value

4.2 CONDUCTED EMISSION MEASUREMENT

4.2.1 LIMITS OF CONDUCTED EMISSION MEASUREMENT

FREQUENCY OF EMISSION (MHz)	CONDUCTED LIMIT (dB μ V)	
	Quasi-peak	Average
0.15 ~ 0.5	66 to 56	56 to 46
0.5 ~ 5	56	46
5 ~ 30	60	50

- NOTE:**
1. The lower limit shall apply at the transition frequencies.
 2. The limit decreases in line with the logarithm of the frequency in the range of 0.15 to 0.50MHz.
 3. All emanations from a class A/B digital device or system, including any network of conductors and apparatus connected thereto, shall not exceed the level of field strengths specified above.

4.2.2 TEST INSTRUMENTS

DESCRIPTION & MANUFACTURER	MODEL NO.	SERIAL NO.	DATE OF CALIBRATION	DUE DATE OF CALIBRATION
Test Receiver ROHDE & SCHWARZ	ESCI	100613	Nov. 11, 2014	Nov. 10, 2015
RF signal cable Woken	5D-FB	Cable-HYC01-01	Dec. 26, 2014	Dec. 25, 2015
LISN ROHDE & SCHWARZ (EUT)	ESH3-Z5	835239/001	Mar. 02, 2015	Mar. 01, 2016
LISN ROHDE & SCHWARZ (Peripheral)	ESH3-Z5	100311	Jul. 21, 2014	Jul. 20, 2015
Software ADT	BV ADT_Cond_ V7.3.7.3	NA	NA	NA

- NOTE:**
1. The calibration interval of the above test instruments is 12 months and the calibrations are traceable to NML/ROC and NIST/USA.
 2. The test was performed in HwaYa Shielded Room 1.
 3. The VCCI Site Registration No. is C-2040.

4.2.3 TEST PROCEDURES

- a. The EUT was placed 0.4 meters from the conducting wall of the shielded room with EUT being connected to the power mains through a line impedance stabilization network (LISN). Other support units were connected to the power mains through another LISN. The two LISNs provide 50 ohm/ 50uH of coupling impedance for the measuring instrument.
- b. Both lines of the power mains connected to the EUT were checked for maximum conducted interference.
- c. The frequency range from 150kHz to 30MHz was searched. Emission levels under (Limit - 20dB) was not recorded.

NOTE: All modes of operation were investigated and the worst-case emissions are reported.

4.2.4 DEVIATION FROM TEST STANDARD

No deviation.

4.2.5 TEST SETUP

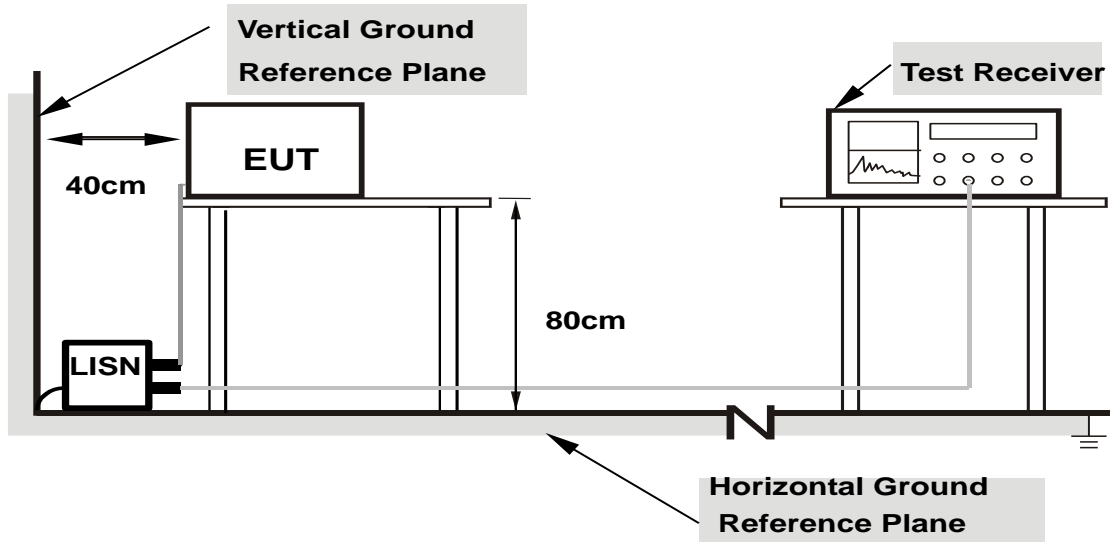

- Note:**
1. Support units were connected to second LISN.
 2. Both of LISNs (AMN) are 80 cm from EUT and at least 80 from other units and other metal planes

For the actual test configuration, please refer to the attached file (Test Setup Photo).

4.2.6 EUT OPERATING CONDITIONS

Same as section 4.1.6.

4.2.7 TEST RESULTS

CONDUCTED WORST-CASE DATA :

Frequency Range	150kHz ~ 30MHz	Detector Function & Resolution Bandwidth	Quasi-Peak (QP) / Average (AV), 9kHz
Input Power	120Vac, 60Hz	Environmental Conditions	25°C, 65%RH
Tested by	Toby Tian	Test Date	2015/5/15

Phase Of Power : Line (L)										
No	Frequency (MHz)	Correction Factor (dB)	Reading Value (dBuV)		Emission Level (dBuV)		Limit (dBuV)		Margin (dB)	
			Q.P.	AV.	Q.P.	AV.	Q.P.	AV.	Q.P.	AV.
1	0.21282	0.06	41.62	26.79	41.68	26.85	63.09	53.09	-21.41	-26.24
2	0.43924	0.06	38.91	30.55	38.97	30.61	57.08	47.08	-18.10	-16.46
3	0.50972	0.06	39.16	24.75	39.22	24.81	56.00	46.00	-16.78	-21.19
4	1.05321	0.08	43.49	29.32	43.57	29.40	56.00	46.00	-12.43	-16.60
5	1.54587	0.10	41.59	29.36	41.69	29.46	56.00	46.00	-14.31	-16.54
6	2.10891	0.12	38.67	25.46	38.79	25.58	56.00	46.00	-17.21	-20.42

Remarks:

1. Q.P. and AV. are abbreviations of quasi-peak and average individually.
2. The emission levels of other frequencies were very low against the limit.
3. Margin value = Emission level – Limit value
4. Correction factor = Insertion loss + Cable loss
5. Emission Level = Correction Factor + Reading Value

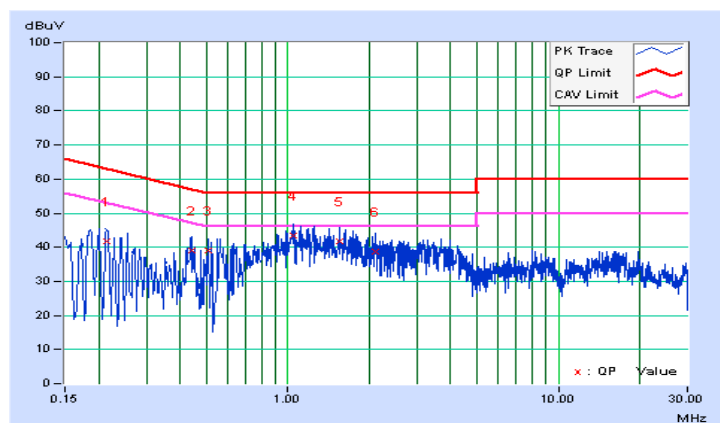



A D T

Frequency Range	150kHz ~ 30MHz	Detector Function & Resolution Bandwidth	Quasi-Peak (QP) / Average (AV), 9kHz
Input Power	120Vac, 60Hz	Environmental Conditions	25°C, 65%RH
Tested by	Toby Tian	Test Date	2015/5/15

Phase Of Power : Neutral (N)										
No	Frequency (MHz)	Correction Factor (dB)	Reading Value (dBuV)		Emission Level (dBuV)		Limit (dBuV)		Margin (dB)	
			Q.P.	AV.	Q.P.	AV.	Q.P.	AV.	Q.P.	AV.
1	0.16955	0.05	52.68	30.77	52.73	30.82	64.98	54.98	-12.25	-24.16
2	0.23993	0.05	52.50	28.97	52.55	29.02	62.10	52.10	-9.55	-23.08
3	0.26730	0.05	44.95	24.03	45.00	24.08	61.20	51.20	-16.20	-27.12
4	0.32986	0.06	44.59	22.77	44.65	22.83	59.45	49.45	-14.81	-26.63
5	0.42761	0.06	42.49	23.84	42.55	23.90	57.30	47.30	-14.75	-23.40
6	0.70913	0.07	39.40	26.65	39.47	26.72	56.00	46.00	-16.53	-19.28

Remarks:

1. Q.P. and AV. are abbreviations of quasi-peak and average individually.
2. The emission levels of other frequencies were very low against the limit.
3. Margin value = Emission level – Limit value
4. Correction factor = Insertion loss + Cable loss
5. Emission Level = Correction Factor + Reading Value

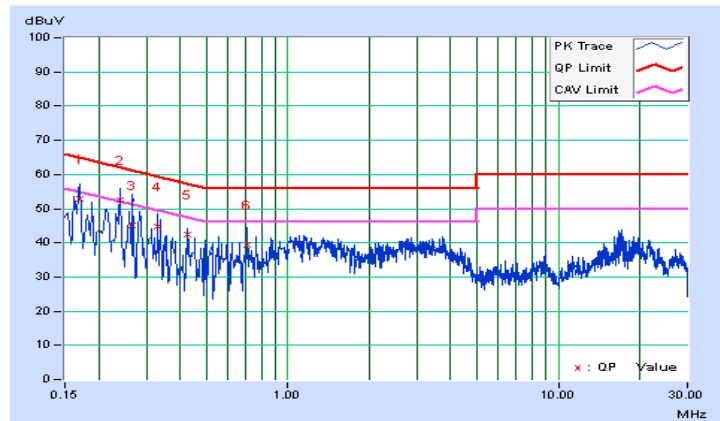

4.3 6dB BANDWIDTH MEASUREMENT

4.3.1 LIMITS OF 6dB BANDWIDTH MEASUREMENT

The minimum of 6dB Bandwidth Measurement is 0.5 MHz.

4.3.2 TEST SETUP

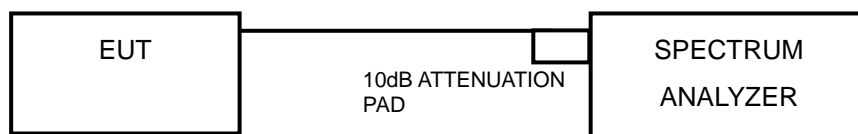

4.3.3 TEST INSTRUMENTS

Refer to section 4.1.2 to get information of above instrument.

4.3.4 TEST PROCEDURE

- a. Set resolution bandwidth (RBW) = 100kHz
- b. Set the video bandwidth (VBW) $\geq 3 \times$ RBW, Detector = Peak.
- c. Trace mode = max hold.
- d. Sweep = auto couple.
- e. Measure the maximum width of the emission that is constrained by the frequencies associated with the two amplitude points (upper and lower) that are attenuated by 6 dB relative to the maximum level measured in the fundamental emission

4.3.5 DEVIATION FROM TEST STANDARD

No deviation.

4.3.6 EUT OPERATING CONDITIONS

The software provided by client to enable the EUT under transmission condition continuously at lowest, middle and highest channel frequencies individually.



A D T

4.3.7 TEST RESULTS

802.11b

CHANNEL	FREQUENCY (MHz)	6dB BANDWIDTH (MHz)	MINIMUM LIMIT (MHz)	PASS / FAIL
1	2412	8.56	0.5	PASS
6	2437	8.11	0.5	PASS
11	2462	8.57	0.5	PASS

802.11g

CHANNEL	FREQUENCY (MHz)	6dB BANDWIDTH (MHz)	MINIMUM LIMIT (MHz)	PASS / FAIL
1	2412	16.35	0.5	PASS
6	2437	16.40	0.5	PASS
11	2462	15.82	0.5	PASS

802.11n (20MHz)

CHANNEL	FREQUENCY (MHz)	6dB BANDWIDTH (MHz)	MINIMUM LIMIT (MHz)	PASS / FAIL
1	2412	17.55	0.5	PASS
6	2437	17.61	0.5	PASS
11	2462	16.43	0.5	PASS



A D T

SPECTRUM PLOT OF WORST VALUE

802.11b

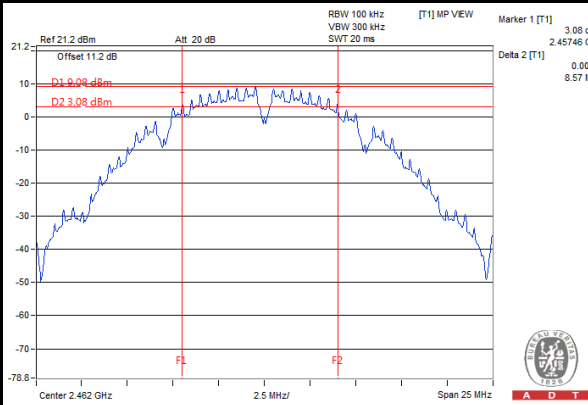

802.11g

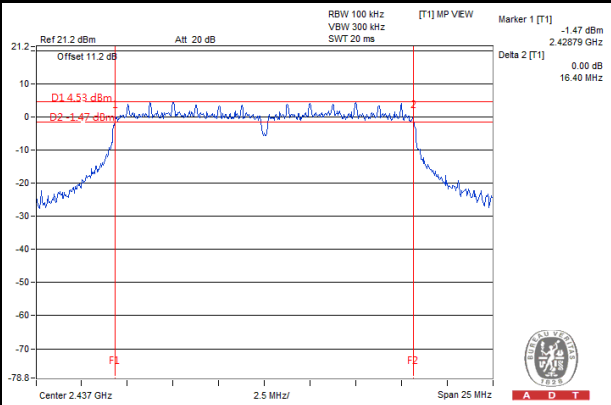

802.11n (20MHz)

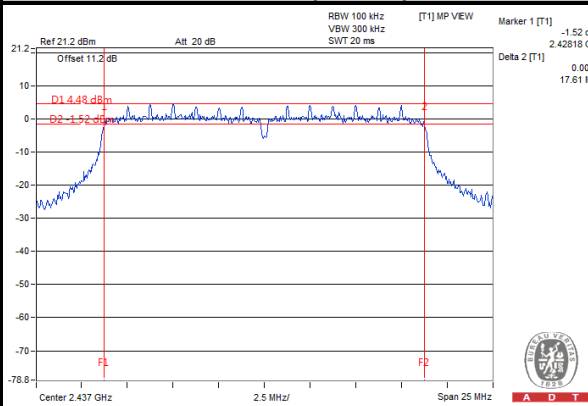

4.4 CONDUCTED OUTPUT POWER

4.4.1 LIMITS OF CONDUCTED OUTPUT POWER MEASUREMENT

For systems using digital modulation in the 2400–2483.5 MHz bands: 1 Watt (30dBm)

4.4.2 TEST SETUP

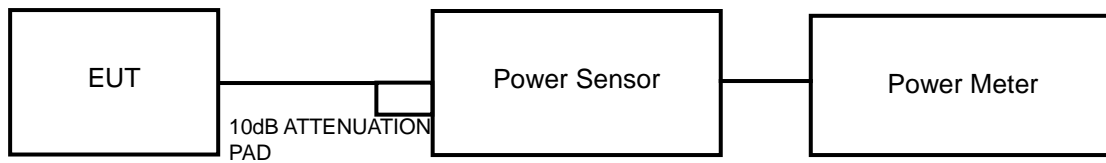

4.4.3 TEST INSTRUMENTS

Refer to section 4.1.2 to get information of above instrument.

4.4.4 TEST PROCEDURES

A peak power sensor was used on the output port of the EUT. A power meter was used to read the response of the peak power sensor. Record the peak power level.

4.4.5 DEVIATION FROM TEST STANDARD

No deviation.

4.4.6 EUT OPERATING CONDITIONS

Same as section 4.3.6.



A D T

4.4.7 TEST RESULTS

802.11b

CHANNEL	FREQUENCY (MHz)	PEAK POWER (mW)	PEAK POWER (dBm)	LIMIT (dBm)	PASS / FAIL
1	2412	110.41	20.43	30	PASS
6	2437	117.76	20.71	30	PASS
11	2462	103.28	20.14	30	PASS

802.11g

CHANNEL	FREQUENCY (MHz)	PEAK POWER (mW)	PEAK POWER (dBm)	LIMIT (dBm)	PASS / FAIL
1	2412	189.23	22.77	30	PASS
6	2437	213.80	23.30	30	PASS
11	2462	175.79	22.45	30	PASS

802.11n (20MHz)

CHANNEL	FREQUENCY (MHz)	PEAK POWER (mW)	PEAK POWER (dBm)	LIMIT (dBm)	PASS / FAIL
1	2412	181.13	22.58	30	PASS
6	2437	213.30	23.29	30	PASS
11	2462	178.24	22.51	30	PASS

4.5 POWER SPECTRAL DENSITY MEASUREMENT

4.5.1 LIMITS OF POWER SPECTRAL DENSITY MEASUREMENT

The Maximum of Power Spectral Density Measurement is 8dBm.

4.5.2 TEST SETUP

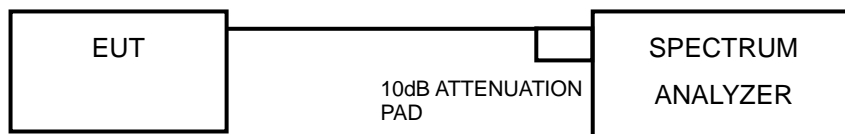

4.5.3 TEST INSTRUMENTS

Refer to section 4.1.2 to get information of above instrument.

4.5.4 TEST PROCEDURE

- Set the RBW = 3 kHz, VBW =10 kHz, Detector = peak.
- Sweep time = auto couple, Trace mode = max hold, allow trace to fully stabilize.
- Use the peak marker function to determine the maximum power level in any 100 kHz band segment within the fundamental EBW.

4.5.5 DEVIATION FROM TEST STANDARD

No deviation.

4.5.6 EUT OPERATING CONDITION

Same as section 4.3.6.



A D T

4.5.7 TEST RESULTS

802.11b

CHANNEL	FREQUENCY (MHz)	PSD (dBm/3kHz)	LIMIT (dBm/3kHz)	PASS / FAIL
1	2412	-5.33	8	PASS
6	2437	-4.49	8	PASS
11	2462	-4.86	8	PASS

802.11g

CHANNEL	FREQUENCY (MHz)	PSD (dBm/3kHz)	LIMIT (dBm/3kHz)	PASS / FAIL
1	2412	-9.51	8	PASS
6	2437	-9.40	8	PASS
11	2462	-9.14	8	PASS

802.11n (20MHz)

CHANNEL	FREQUENCY (MHz)	PSD (dBm/3kHz)	LIMIT (dBm/3kHz)	PASS / FAIL
1	2412	-9.92	8	PASS
6	2437	-10.35	8	PASS
11	2462	-9.56	8	PASS



A D T

SPECTRUM PLOT OF WORST VALUE

802.11b

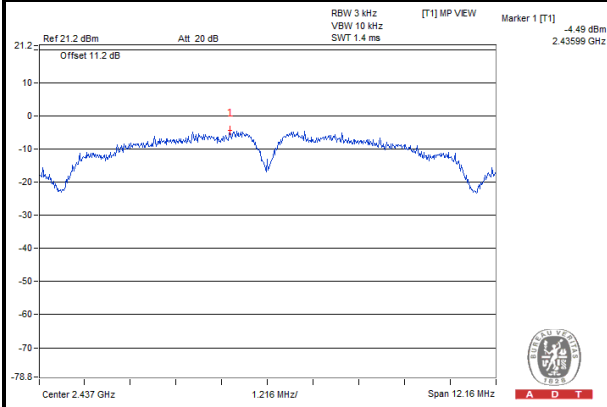

802.11g

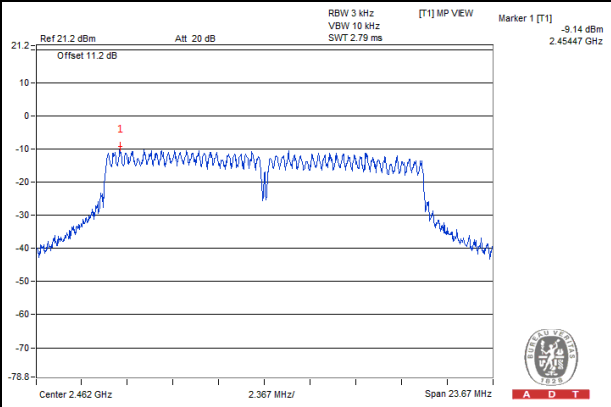

802.11n (20MHz)

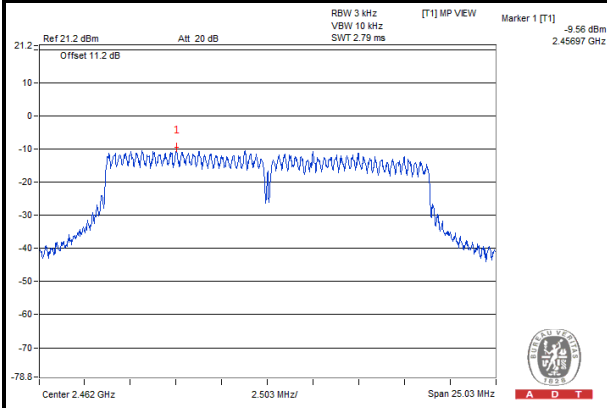

802.11n (40MHz)



4.6 CONDUCTED OUT OF BAND EMISSION MEASUREMENT

4.6.1 LIMITS OF CONDUCTED OUT OF BAND EMISSION MEASUREMENT

Below -20dB of the highest emission level of operating band (in 100kHz Resolution Bandwidth).

4.6.2 TEST SETUP

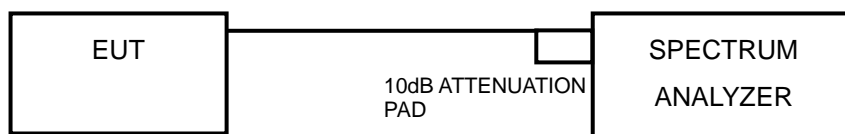

4.6.3 TEST INSTRUMENTS

Refer to section 4.1.2 to get information of above instrument.

4.6.4 TEST PROCEDURE

MEASUREMENT PROCEDURE REF

1. Set the RBW = 100 kHz.
2. Set the VBW \geq 300 kHz.
3. Detector = peak.
4. Sweep time = auto couple.
5. Trace mode = max hold.
6. Allow trace to fully stabilize.
7. Use the peak marker function to determine the maximum power level in any 100 kHz band segment within the fundamental EBW.

MEASUREMENT PROCEDURE OOB

1. Set RBW = 100 kHz.
2. Set VBW \geq 300 kHz.
3. Detector = peak.
4. Sweep = auto couple.
5. Trace Mode = max hold.
6. Allow trace to fully stabilize.
7. Use the peak marker function to determine the maximum amplitude level.

4.6.5 DEVIATION FROM TEST STANDARD

No deviation.

4.6.6 EUT OPERATING CONDITION

Same as section 4.3.6.



A D T

4.6.7 TEST RESULTS

The spectrum plots are attached on the following images. D1 line indicates the highest level, and D2 line indicates the 20dB offset below D1. It shows compliance with the requirement.

802.11b

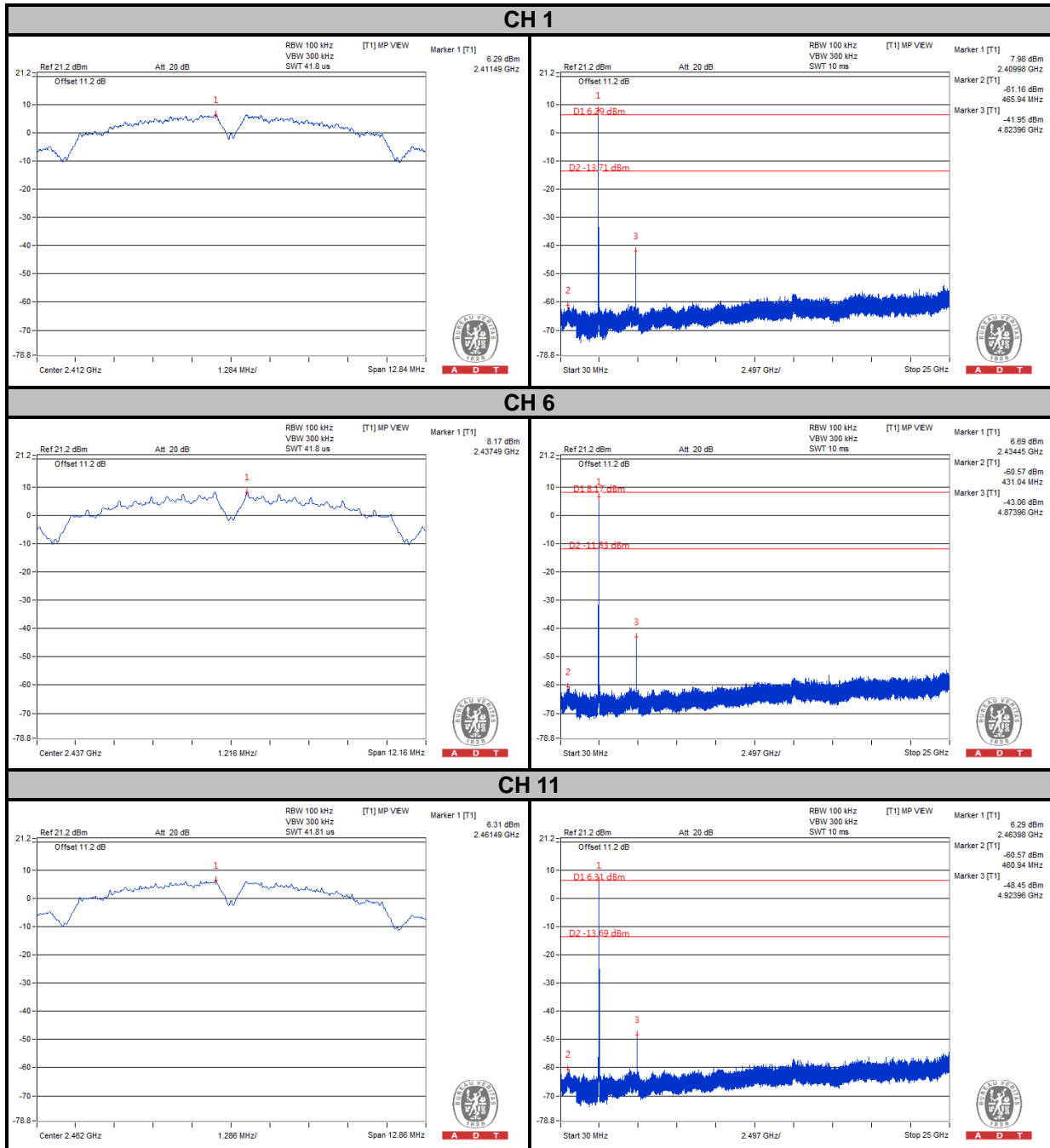



A D T

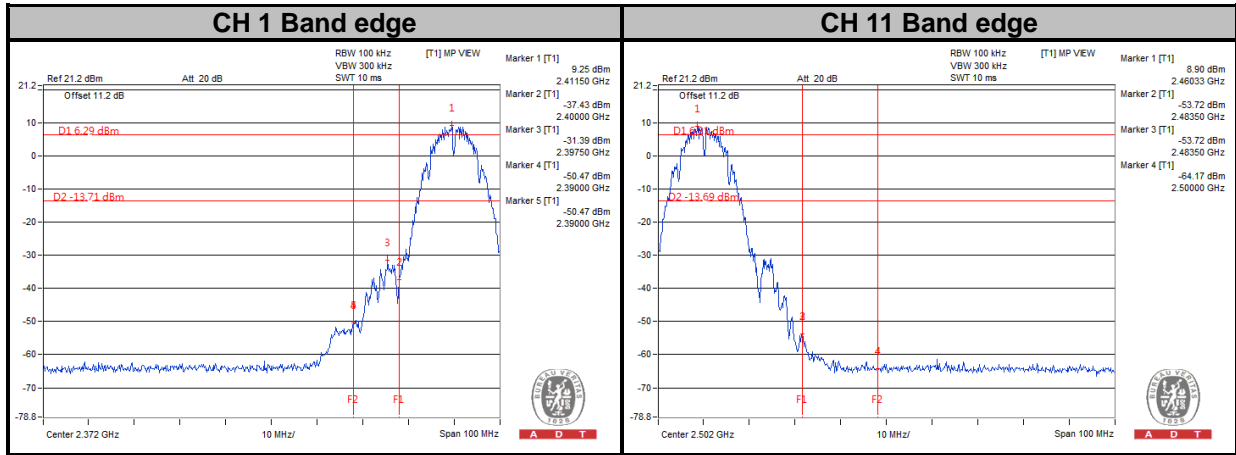



A D T

802.11g

CH 1

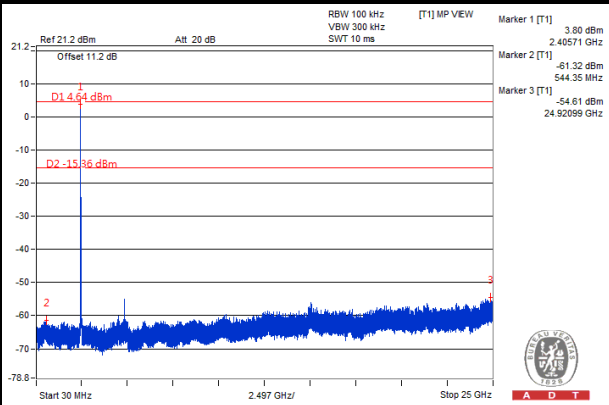
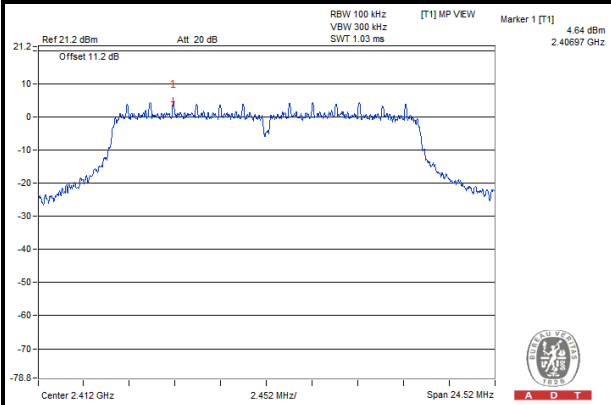

CH 6

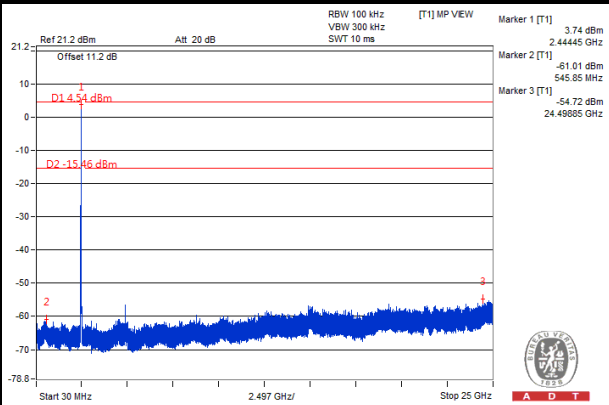
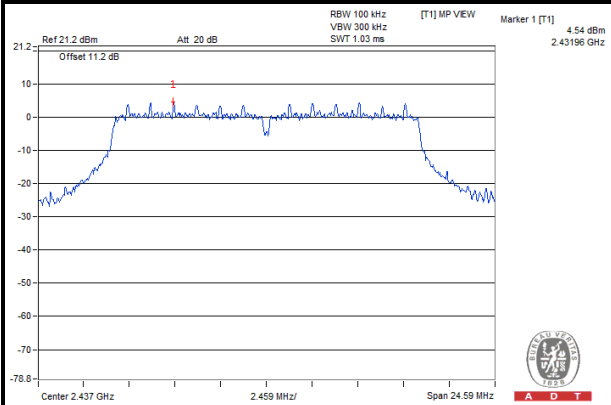

CH 11

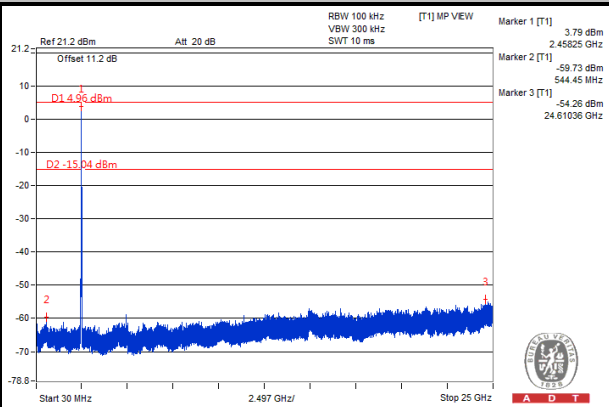
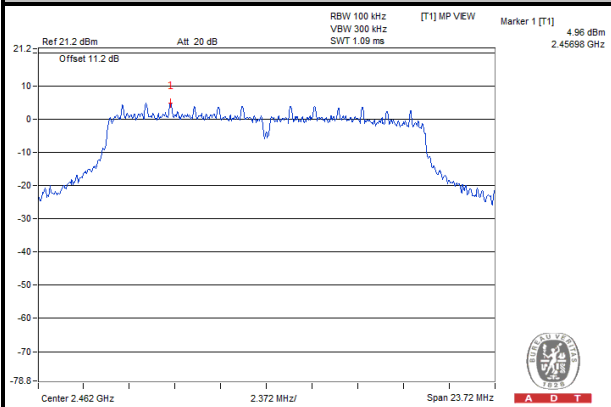



A D T

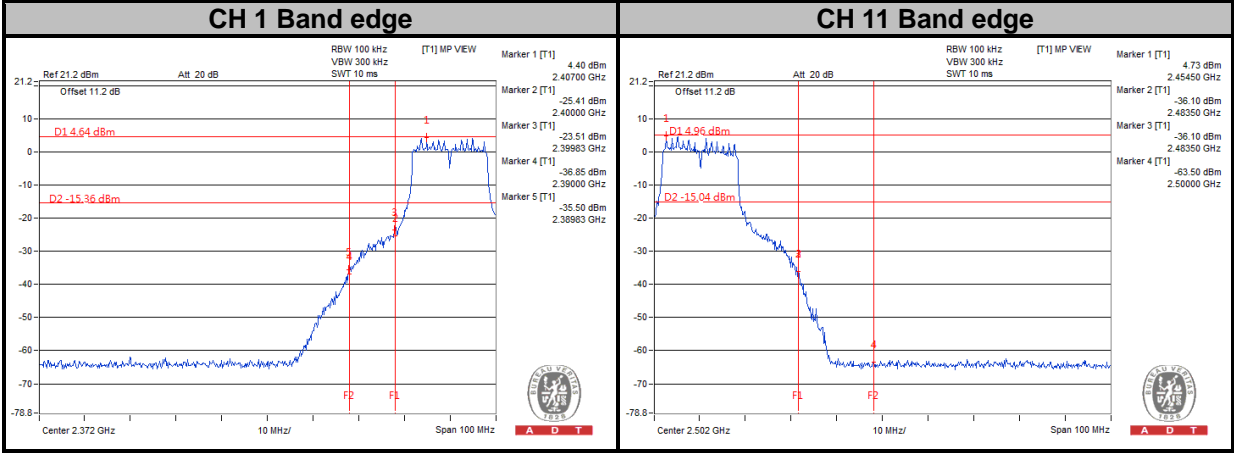



A D T

802.11n (20MHz)

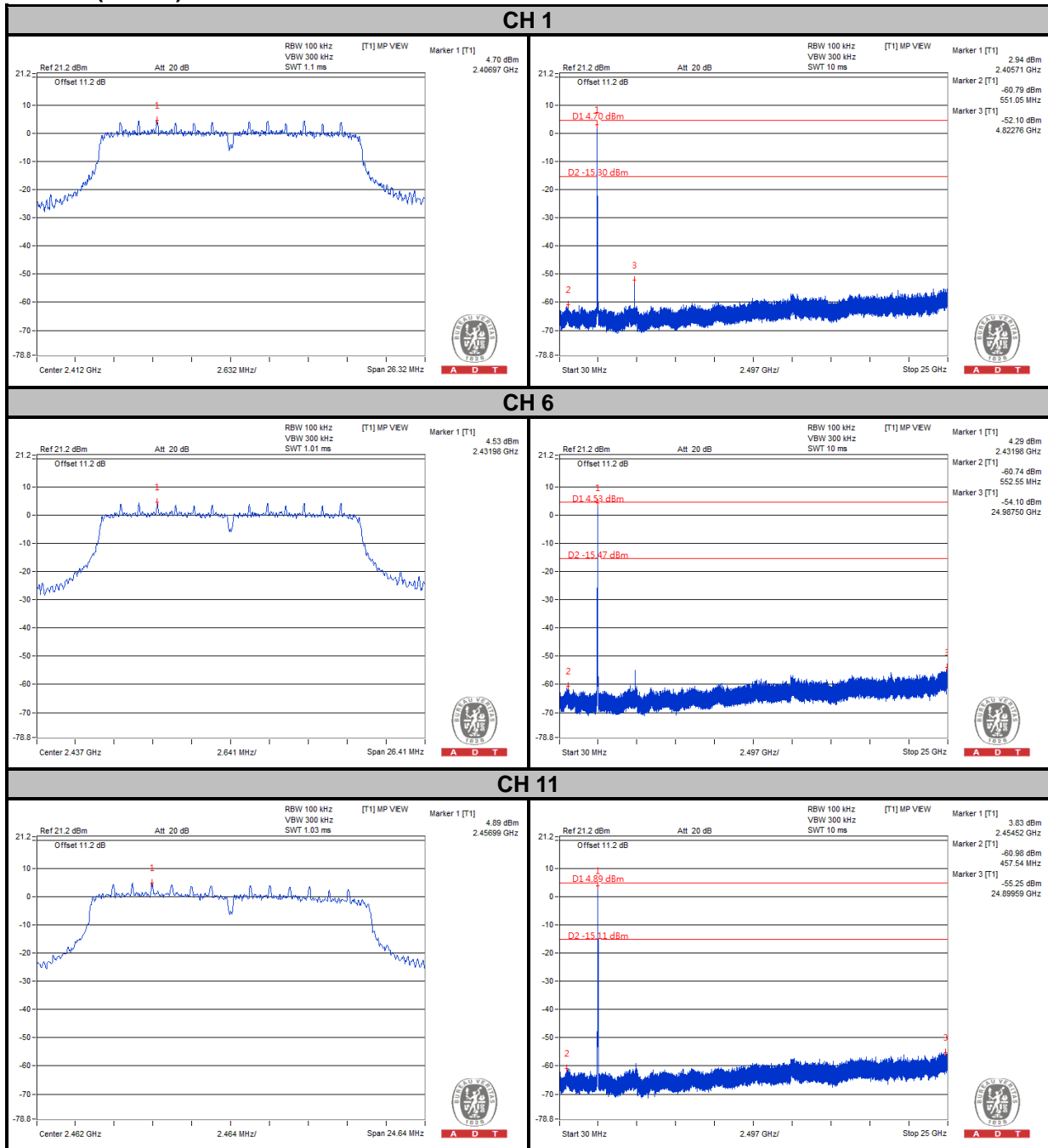



A D T

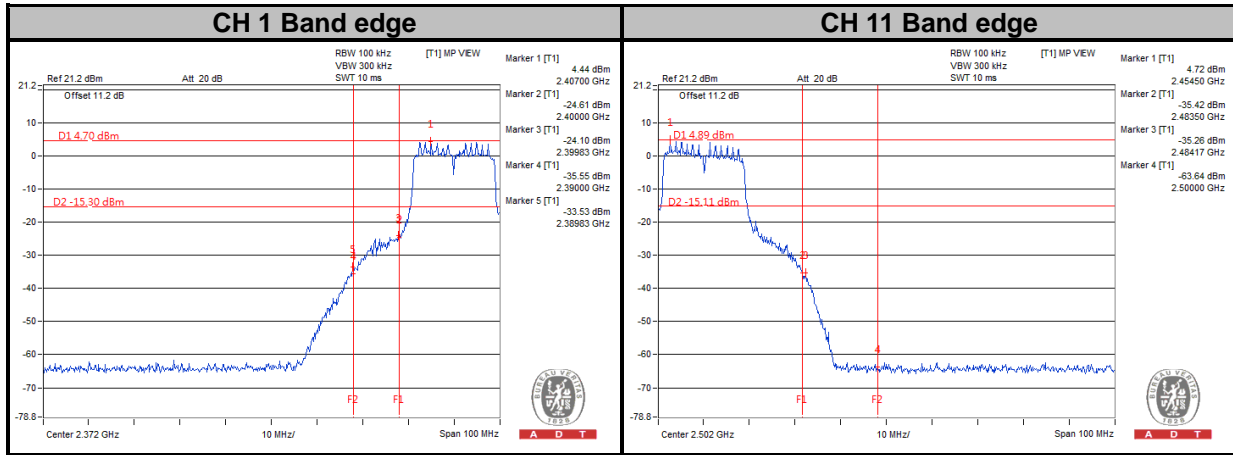



A D T

5. PHOTOGRAPHS OF THE TEST CONFIGURATION

Please refer to the attached file (Test Setup Photo).



6. INFORMATION ON THE TESTING LABORATORIES

We, Bureau Veritas Consumer Products Services (H.K.) Ltd., Taoyuan Branch, were founded in 1988 to provide our best service in EMC, Radio, Telecom and Safety consultation. Our laboratories are accredited and approved according to ISO/IEC 17025.

If you have any comments, please feel free to contact us at the following:

Linko EMC/RF Lab:

Tel: 886-2-26052180

Fax: 886-2-26051924

Hsin Chu EMC/RF/Telecom Lab:

Tel: 886-3-5935343

Fax: 886-3-5935342

Hwa Ya EMC/RF/Safety Lab:

Tel: 886-3-3183232

Fax: 886-3-3270892

Email: service.adt@tw.bureauveritas.com

Web Site: www.bureauveritas-adt.com

The address and road map of all our labs can be found in our web site also.



A D T

7. APPENDIX A – MODIFICATIONS RECORDERS FOR ENGINEERING CHANGES TO THE EUT BY THE LAB

No any modifications are made to the EUT by the lab during the test.

---END---