



A D T

FCC TEST REPORT (PART 24)

REPORT NO.: RF150714C29-1
MODEL NAME: OPM9310
FCC ID: NM80PM9310
RECEIVED: Mar. 24, 2015
TESTED: Apr. 30, 2015 ~ May 09, 2015
ISSUED: Jul. 31, 2015

APPLICANT: HTC Corporation

ADDRESS: 1F, 6-3 Baoqiang Road, Xindian District, New Taipei City, Taiwan 231

ISSUED BY: Bureau Veritas Consumer Products Services (H.K.) Ltd., Taoyuan Branch

LAB ADDRESS: No. 47-2, 14th Ling, Chia Pau Vil., Lin Kou Dist., New Taipei City, Taiwan (R.O.C.)

TEST LOCATION: No. 19, Hwa Ya 2nd Rd, Wen Hwa Vil., Kwei Shan Dist., Taoyuan City 333, Taiwan, R.O.C.

This report should not be used by the client to claim product certification, approval, or endorsement by TAF or any government agencies.



This report is for your exclusive use. Any copying or replication of this report to or for any other person or entity, or use of our name or trademark, is permitted only with our prior written permission. This report sets forth our findings solely with respect to the test samples identified herein. The results set forth in this report are not indicative or representative of the quality or characteristics of the lot from which a test sample was taken or any similar or identical product unless specifically and expressly noted. Our report includes all of the tests requested by you and the results thereof based upon the information that you provided to us. You have 60 days from date of issuance of this report to notify us of any material error or omission caused by our negligence, provided, however, that such notice shall be in writing and shall specifically address the issue you wish to raise. A failure to raise such issue within the prescribed time shall constitute your unqualified acceptance of the completeness of this report, the tests conducted and the correctness of the report contents. Unless specific mention, the uncertainty of measurement has been explicitly taken into account to declare the compliance or non-compliance to the specification



TABLE OF CONTENTS

RELEASE CONTROL RECORD	3
1 CERTIFICATION	4
2 SUMMARY OF TEST RESULTS.....	5
2.1 MEASUREMENT UNCERTAINTY	5
2.2 TEST SITE AND INSTRUMENTS	6
3 GENERAL INFORMATION	7
3.1 GENERAL DESCRIPTION OF EUT.....	7
3.2 CONFIGURATION OF SYSTEM UNDER TEST	9
3.3 DESCRIPTION OF SUPPORT UNITS.....	9
3.4 TEST ITEM AND TEST CONFIGURATION	10
3.5 EUT OPERATING CONDITIONS.....	13
3.6 GENERAL DESCRIPTION OF APPLIED STANDARDS	13
4 TEST TYPES AND RESULTS.....	14
4.1 OUTPUT POWER MEASUREMENT	14
4.1.1 LIMITS OF OUTPUT POWER MEASUREMENT	14
4.1.2 TEST PROCEDURES	14
4.1.3 TEST SETUP	15
4.1.4 TEST RESULTS	16
4.2 FREQUENCY STABILITY MEASUREMENT	25
4.2.1 LIMITS OF FREQUENCY STABILITY MEASUREMENT	25
4.2.2 TEST PROCEDURE	25
4.2.3 TEST SETUP	25
4.2.4 TEST RESULTS	26
4.3 OCCUPIED BANDWIDTH MEASUREMENT	28
4.3.1 TEST PROCEDURES	28
4.3.2 TEST SETUP	28
4.3.3 TEST RESULTS	29
4.4 PEAK TO AVERAGE RATIO.....	34
4.4.1 LIMITS OF PEAK TO AVERAGE RATIO MEASUREMENT	34
4.4.2 TEST SETUP	34
4.4.3 TEST PROCEDURES	34
4.4.4 TEST RESULTS	35
4.5 BAND EDGE MEASUREMENT	39
4.5.1 LIMITS OF BAND EDGE MEASUREMENT	39
4.5.2 TEST SETUP	39
4.5.3 TEST PROCEDURES	39
4.5.4 TEST RESULTS	40
4.6 CONDUCTED SPURIOUS EMISSIONS.....	48
4.6.1 LIMITS OF CONDUCTED SPURIOUS EMISSIONS MEASUREMENT.....	48
4.6.2 TEST PROCEDURE	48
4.6.3 TEST SETUP	48
4.6.4 TEST RESULTS	49
4.7 RADIATED EMISSION MEASUREMENT	51
4.7.1 LIMITS OF RADIATED EMISSION MEASUREMENT	51
4.7.2 TEST PROCEDURES.....	51
4.7.3 DEVIATION FROM TEST STANDARD.....	51
4.7.4 TEST SETUP	52
4.7.5 TEST RESULTS	53
5 PHOTOGRAPHS OF THE TEST CONFIGURATION	63
6 INFORMATION ON THE TESTING LABORATORIES	64
7 APPENDIX A – MODIFICATIONS RECORDERS FOR ENGINEERING CHANGES TO THE EUT BY THE LAB.....	65



A D T

RELEASE CONTROL RECORD

ISSUE NO.	REASON FOR CHANGE	DATE ISSUED
RF150714C29-1	Original release	Jul. 31, 2015



1 CERTIFICATION

PRODUCT: Smartphone

MODEL: OPM9310

BRAND: HTC

APPLICANT: HTC Corporation

TESTED: Apr. 30, 2015 ~ May 09, 2015

TEST SAMPLE: Production Unit

STANDARDS: FCC Part 24, Subpart E

The above equipment (model: OPM9310) has been tested by **Bureau Veritas Consumer Products Services (H.K.) Ltd., Taoyuan Branch**, and found compliance with the requirement of the above standards. The test record, data evaluation & Equipment Under Test (EUT) configurations represented herein are true and accurate accounts of the measurements of the sample's EMC characteristics under the conditions specified in this report.

PREPARED BY : Ivonne Wu , **DATE** : Jul. 31, 2015
Ivonne Wu / Supervisor

APPROVED BY : Kay Wu , **DATE** : Jul. 31, 2015
Kay Wu / Supervisor

2 SUMMARY OF TEST RESULTS

The EUT has been tested according to the following specifications:

APPLIED STANDARD: FCC Part 24 & Part 2			
STANDARD SECTION	TEST TYPE	RESULT	REMARK
2.1046 24.232	Equivalent Isotropic Radiated Power	PASS	Meet the requirement of limit.
2.1055 24.235	Frequency Stability	PASS	Meet the requirement of limit.
2.1049 24.238(b)	Occupied Bandwidth	PASS	Meet the requirement of limit.
24.232(d)	Peak to average ratio	PASS	Meet the requirement of limit.
24.238(b)	Band Edge Measurements	PASS	Meet the requirement of limit.
2.1051 24.238	Conducted Spurious Emissions	PASS	Meet the requirement of limit.
2.1053 24.238	Radiated Spurious Emissions	PASS	Meet the requirement of limit. Minimum passing margin is -22.39dB at 5640.00MHz.

2.1 MEASUREMENT UNCERTAINTY

Where relevant, the following measurement uncertainty levels have been estimated for tests performed on the EUT as specified in CISPR 16-4-2:

MEASUREMENT	FREQUENCY	UNCERTAINTY
Conducted emissions	9kHz~30MHz	2.44 dB
Radiated emissions	30MHz ~ 200MHz	2.93 dB
	200MHz ~1000MHz	2.95 dB
	1GHz ~ 18GHz	2.26 dB
	18GHz ~ 40GHz	1.94 dB

This uncertainty represents an expanded uncertainty expressed at approximately the 95% confidence level using a coverage factor of k=2.



2.2 TEST SITE AND INSTRUMENTS

DESCRIPTION & MANUFACTURER	MODEL NO.	SERIAL NO.	DATE OF CALIBRATION	DUE DATE OF CALIBRATION
Test Receiver Agilent	N9038A	MY51210203	Jan. 21, 2015	Jan. 21, 2016
Spectrum Analyzer Agilent	N9010A	MY52220314	Sep. 03, 2014	Sep. 02, 2015
Spectrum Analyzer ROHDE & SCHWARZ	FSU43	101261	Dec. 10, 2014	Dec. 09, 2015
BILOG Antenna SCHWARZBECK	VULB9168	9168-472	Feb. 04, 2015	Feb. 04, 2016
HORN Antenna SCHWARZBECK	BBHA 9120 D	9120D-969	Feb. 09, 2015	Feb. 09, 2016
HORN Antenna SCHWARZBECK	BBHA 9170	9170-480	Feb. 04, 2015	Feb. 04, 2016
Preamplifier EMCI	EMC 012645	980115	Dec. 12, 2014	Dec. 11, 2015
Preamplifier EMCI	EMC 184045	980116	Jan. 09, 2015	Jan. 08, 2016
Preamplifier EMCI	EMC 330H	980112	Dec. 27, 2014	Dec. 26, 2015
Power Meter Anritsu	ML2495A	1232002	Sep. 17, 2014	Sep. 16, 2015
Power Sensor Anritsu	MA2411B	1207325	Sep. 17, 2014	Sep. 16, 2015
RF signal cable HUBER+SUHNNER	SUCOFLEX 104	309219/4 2950114	Oct. 18, 2014	Oct. 17, 2015
RF signal cable HUBER+SUHNNER	SUCOFLEX 104	250130/4	Oct. 18, 2014	Oct. 17, 2015
RF Coaxial Cable Worken	8D-FB	Cable-Ch10-01	Nov. 07, 2014	Nov. 06, 2015
Software BV ADT	E3 6.120103	NA	NA	NA
Antenna Tower MF	MFA-440H	NA	NA	NA
Turn Table MF	MFT-201SS	NA	NA	NA
Antenna Tower & Turn Table Controller MF	MF-7802	NA	NA	NA
Radio Communication Analyzer	MT8820C	6201300640	Aug. 01, 2013	Jul. 31, 2015

- NOTE:**
1. The calibration interval of the above test instruments is 12 / 24 months and the calibrations are traceable to NML/ROC and NIST/USA.
 2. The test was performed in HwaYa Chamber 10.
 3. The horn antenna and HP preamplifier (model: 8449B) are used only for the measurement of emission frequency above 1GHz if tested.
 4. The FCC Site Registration No. is 690701.
 5. The IC Site Registration No. is IC 7450F-10.

3 GENERAL INFORMATION

3.1 GENERAL DESCRIPTION OF EUT

EUT	Smartphone	
MODEL NAME	0PM9310	
POWER SUPPLY	5.0Vdc (adapter or host equipment) 3.85Vdc (battery)	
MODULATION TYPE	GSM/GPRS	GMSK
	EDGE	GMSK, 8PSK
	WCDMA	BPSK
	CDMA	QPSK, OQPSK, HPSK
	LTE Band 2	QPSK, 16QAM
FREQUENCY RANGE	GSM/GPRS/EDGE	1850.2MHz ~ 1909.8MHz
	WCDMA	1852.4MHz ~ 1907.6MHz
	CDMA	1851.3MHz ~ 1908.8MHz
	LTE Band 2 (Channel Bandwidth: 1.4MHz)	1850.7MHz ~ 1909.3MHz
	LTE Band 2 (Channel Bandwidth: 3MHz)	1851.5MHz ~ 1908.5MHz
	LTE Band 2 (Channel Bandwidth: 5MHz)	1852.5MHz ~ 1907.5MHz
	LTE Band 2 (Channel Bandwidth: 10MHz)	1855.0MHz ~ 1905.0MHz
	LTE Band 2 (Channel Bandwidth: 15MHz)	1857.5MHz ~ 1902.5MHz
	LTE Band 2 (Channel Bandwidth: 20MHz)	1860.0MHz ~ 1900.0MHz
MAX. EIRP POWER	GSM	1253.14mW
	EDGE	468.81mW
	WCDMA	192.00mW
	CDMA	233.35mW
	LTE Band 2 (Channel Bandwidth: 1.4MHz)	160.81mW
	LTE Band 2 (Channel Bandwidth: 3MHz)	158.23mW
	LTE Band 2 (Channel Bandwidth: 5MHz)	152.05mW
	LTE Band 2 (Channel Bandwidth: 10MHz)	151.01mW
	LTE Band 2 (Channel Bandwidth: 15MHz)	161.18mW
	LTE Band 2 (Channel Bandwidth: 20MHz)	169.43mW



A D T

EMISSION DESIGNATOR	GSM	249KGXW
	EDGE	247KG7W
	WCDMA	4M17F9W
	CDMA	1M28F9W
	LTE Band 2 (Channel Bandwidth: 1.4MHz)	1M09G7D
	LTE Band 2 (Channel Bandwidth: 3MHz)	2M70G7D
	LTE Band 2 (Channel Bandwidth: 5MHz)	4M50G7D
	LTE Band 2 (Channel Bandwidth: 10MHz)	8M97G7D
	LTE Band 2 (Channel Bandwidth: 15MHz)	13M5G7D
	LTE Band 2 (Channel Bandwidth: 20MHz)	18M0W7D
ANTENNA TYPE	Fixed Internal Antenna	
I/O PORTS	Refer to users' manual	
DATA CABLE	Refer to NOTE as below	
ACCESSORY DEVICES	Refer to NOTE as below	

NOTE:

1. The EUT's accessories list refers to Ext. Pho.
2. The above EUT information was declared by manufacturer and for more detailed features description, please refer to the manufacturer's specifications or User's Manual.

3.2 CONFIGURATION OF SYSTEM UNDER TEST

FOR RADIATION EMISSION TEST

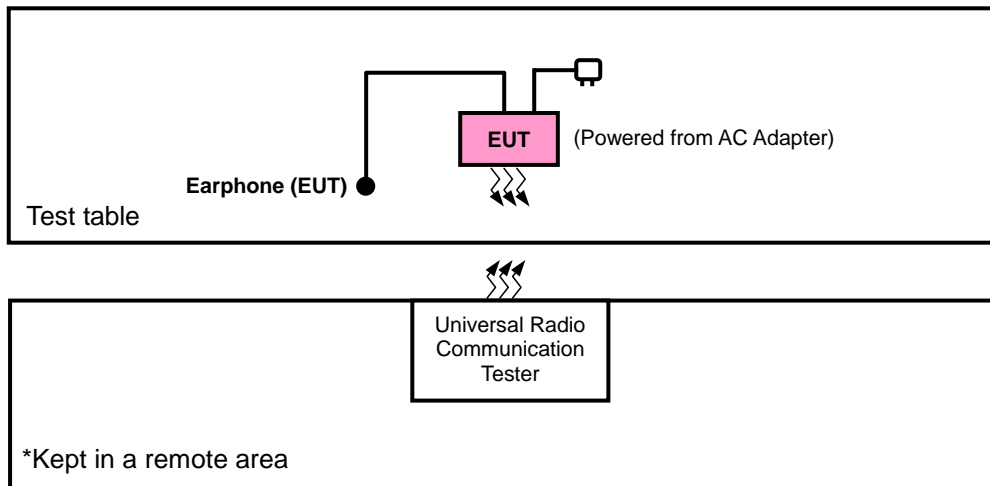

FOR E.I.R.P. TEST

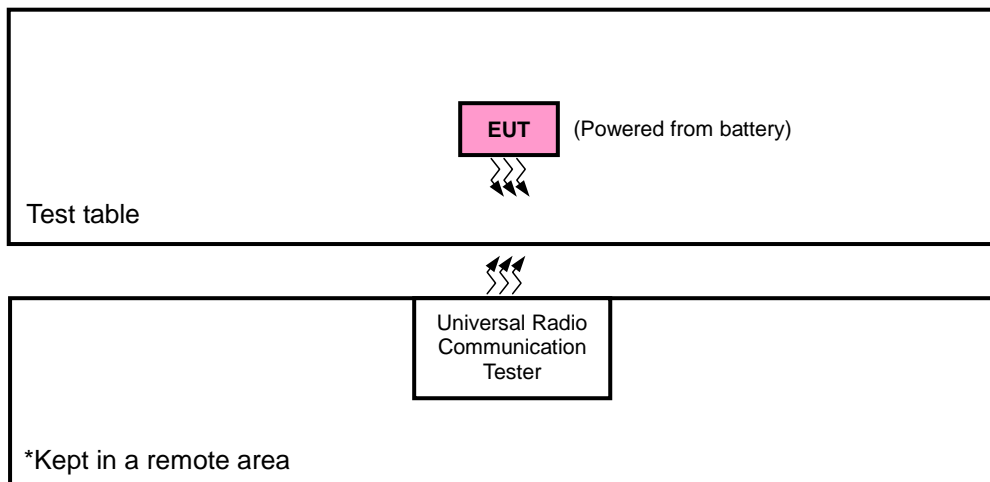

3.3 DESCRIPTION OF SUPPORT UNITS

The EUT has been tested as an independent unit together with other necessary accessories or support units.



3.4 TEST ITEM AND TEST CONFIGURATION

Pre-Scan has been conducted to determine the worst-case mode from all possible combinations between available modulations, data rates, XYZ axis and antenna ports. The worst case was found as the list below. Following channel(s) was (were) selected for the final test as listed below:

EUT CONFIGURE MODE	EIRP	RADIATED EMISSION
-	X-plane	Z-axis

GSM MODE

EUT CONFIGURE MODE	TEST ITEM	AVAILABLE CHANNEL	TESTED CHANNEL	MODE
-	EIRP	512 to 810	512, 661, 810	GSM, EDGE
-	FREQUENCY STABILITY	512 to 810	661	GSM, EDGE
-	OCCUPIED BANDWIDTH	512 to 810	512, 661, 810	GSM, EDGE
-	PEAK TO AVERAGE RATIO	512 to 810	512, 661, 810	GSM, EDGE
-	BAND EDGE	512 to 810	512, 810	GSM, EDGE
-	CONDUCTED EMISSION	512 to 810	661	GSM, EDGE
-	RADIATED EMISSION	512 to 810	661	GSM, EDGE

WCDMA MODE

EUT CONFIGURE MODE	TEST ITEM	AVAILABLE CHANNEL	TESTED CHANNEL	MODE
-	EIRP	9262 to 9538	9262, 9400, 9538	WCDMA
-	FREQUENCY STABILITY	9262 to 9538	9400	WCDMA
-	OCCUPIED BANDWIDTH	9262 to 9538	9262, 9400, 9538	WCDMA
-	PEAK TO AVERAGE RATIO	9262 to 9538	9262, 9400, 9538	WCDMA
-	BAND EDGE	9262 to 9538	9262, 9538	WCDMA
-	CONDUCTED EMISSION	9262 to 9538	9400	WCDMA
-	RADIATED EMISSION	9262 to 9538	9400	WCDMA



CDMA MODE

EUT CONFIGURE MODE	TEST ITEM	AVAILABLE CHANNEL	TESTED CHANNEL	MODE
-	EIRP	25 to 1175	25, 600, 1175	1xRTT
-	FREQUENCY STABILITY	25 to 1175	600	1xRTT
-	OCCUPIED BANDWIDTH	25 to 1175	25, 600, 1175	1xRTT
-	PEAK TO AVERAGE RATIO	25 to 1175	25, 600, 1175	1xRTT
-	BAND EDGE	25 to 1175	25, 1175	1xRTT
-	CONDUCTED EMISSION	25 to 1175	600	1xRTT
-	RADIATED EMISSION	25 to 1175	600	1xRTT

LTE BAND 2 MODE

EUT CONFIGURE MODE	TEST ITEM	AVAILABLE CHANNEL	TESTED CHANNEL	CHANNEL BANDWIDTH	MODULATION	MODE
-	EIRP	18607 to 19193	18607, 18900, 19193	1.4MHz	QPSK, 16QAM	3 RB / 0 RB Offset
		18615 to 19185	18615, 18900, 19185	3MHz	QPSK, 16QAM	1 RB / 0 RB Offset
		18625 to 19175	18625, 18900, 19175	5MHz	QPSK, 16QAM	1 RB / 0 RB Offset
		18650 to 19150	18650, 18900, 19150	10MHz	QPSK, 16QAM	1 RB / 0 RB Offset
		18675 to 19125	18675, 18900, 19125	15MHz	QPSK, 16QAM	1 RB / 0 RB Offset
		18700 to 19100	18700, 18900, 19100	20MHz	QPSK, 16QAM	1 RB / 0 RB Offset
-	FREQUENCY STABILITY	18607 to 19193	18900	1.4MHz	QPSK	3 RB / 0 RB Offset
		18615 to 19185	18900	3MHz	QPSK	1 RB / 0 RB Offset
		18625 to 19175	18900	5MHz	QPSK	1 RB / 0 RB Offset
		18650 to 19150	18900	10MHz	QPSK	1 RB / 0 RB Offset
		18675 to 19125	18900	15MHz	QPSK	1 RB / 0 RB Offset
		18700 to 19100	18900	20MHz	QPSK	1 RB / 0 RB Offset
-	OCCUPIED BANDWIDTH	18607 to 19193	18607, 18900, 19193	1.4MHz	QPSK, 16QAM	6 RB / 0 RB Offset
		18615 to 19185	18615, 18900, 19185	3MHz	QPSK, 16QAM	15 RB / 0 RB Offset
		18625 to 19175	18625, 18900, 19175	5MHz	QPSK, 16QAM	25 RB / 0 RB Offset
		18650 to 19150	18650, 18900, 19150	10MHz	QPSK, 16QAM	50 RB / 0 RB Offset
		18675 to 19125	18675, 18900, 19125	15MHz	QPSK, 16QAM	75 RB / 0 RB Offset
		18700 to 19100	18700, 18900, 19100	20MHz	QPSK, 16QAM	100 RB / 0 RB Offset
-	PEAK TO AVERAGE RATIO	18607 to 19193	18607, 18900, 19193	1.4MHz	QPSK, 16QAM	3 RB / 0 RB Offset
		18615 to 19185	18615, 18900, 19185	3MHz	QPSK, 16QAM	1 RB / 0 RB Offset
		18625 to 19175	18625, 18900, 19175	5MHz	QPSK, 16QAM	1 RB / 0 RB Offset
		18650 to 19150	18650, 18900, 19150	10MHz	QPSK, 16QAM	1 RB / 0 RB Offset
		18675 to 19125	18675, 18900, 19125	15MHz	QPSK, 16QAM	1 RB / 0 RB Offset
		18700 to 19100	18700, 18900, 19100	20MHz	QPSK, 16QAM	1 RB / 0 RB Offset



A D T

EUT CONFIGURE MODE	TEST ITEM	AVAILABLE CHANNEL	TESTED CHANNEL	CHANNEL BANDWIDTH	MODULATION	MODE		
-	BAND EDGE	18607 to 19193	18607	1.4MHz	QPSK	1 RB / 0 RB Offset 6 RB / 0 RB Offset		
			19193	1.4MHz	QPSK	1 RB / 5 RB Offset 6 RB / 0 RB Offset		
		18615 to 19185	18615	3MHz	QPSK	1 RB / 0 RB Offset 15 RB / 0 RB Offset		
			19185	3MHz	QPSK	1 RB / 14 RB Offset 15 RB / 0 RB Offset		
		18625 to 19175	18625	5MHz	QPSK	1 RB / 0 RB Offset 25 RB / 0 RB Offset		
			19175	5MHz	QPSK	1 RB / 24 RB Offset 25 RB / 0 RB Offset		
		18650 to 19150	18650	10MHz	QPSK	1 RB / 0 RB Offset 50 RB / 0 RB Offset		
			19150	10MHz	QPSK	1 RB / 49 RB Offset 50 RB / 0 RB Offset		
		18675 to 19125	18675	15MHz	QPSK	1 RB / 0 RB Offset 75 RB / 0 RB Offset		
			19125	15MHz	QPSK	1 RB / 74 RB Offset 75 RB / 0 RB Offset		
		18700 to 19100	18700	20MHz	QPSK	1 RB / 0 RB Offset 100 RB / 0 RB Offset		
			19100	20MHz	QPSK	1 RB / 99 RB Offset 100 RB / 0 RB Offset		
		-	CONDUCTED EMISSION	18607 to 19193	18900	1.4MHz	QPSK	1 RB / 0 RB Offset
				18615 to 19185	18900	3MHz	QPSK	1 RB / 0 RB Offset
				18625 to 19175	18900	5MHz	QPSK	1 RB / 0 RB Offset
				18650 to 19150	18900	10MHz	QPSK	1 RB / 0 RB Offset
18675 to 19125	18900			15MHz	QPSK	1 RB / 0 RB Offset		
18700 to 19100	18900			20MHz	QPSK	1 RB / 0 RB Offset		
-	RADIATED EMISSION	18700 to 19100	18900	20MHz	QPSK	1 RB / 0 RB Offset		

Note: This device was tested under all bandwidths, RB configurations and modulations. The worst case was found in QPSK modulation.



A D T

TEST CONDITION:

TEST ITEM	ENVIRONMENTAL CONDITIONS	INPUT POWER	TESTED BY
ERP	26deg. C, 58%RH	3.85Vdc	Will Chen
FREQUENCY STABILITY	26deg. C, 58%RH	3.85Vdc	Luke Chen
OCCUPIED BANDWIDTH	26deg. C, 58%RH	3.85Vdc	Luke Chen
PEAK TO AVERAGE RATIO	26deg. C, 58%RH	3.85Vdc	Luke Chen
BAND EDGE	26deg. C, 58%RH	3.85Vdc	Luke Chen
CONDUCTED EMISSION	26deg. C, 58%RH	3.85Vdc	Luke Chen
RADIATED EMISSION	25deg. C, 65%RH	120Vac, 60Hz	Will Chen / Charles Hsiao

3.5 EUT OPERATING CONDITIONS

The EUT makes a call to the communication simulator. The communication simulator station system controlled a EUT to export maximum output power under transmission mode and specific channel frequency

3.6 GENERAL DESCRIPTION OF APPLIED STANDARDS

The EUT is a RF product. According to the specifications of the manufacturer, it must comply with the requirements of the following standards:

FCC 47 CFR Part 2

FCC 47 CFR Part 24

ANSI/TIA/EIA-603-C 2004

NOTE: All test items have been performed and recorded as per the above standards.

4 TEST TYPES AND RESULTS

4.1 OUTPUT POWER MEASUREMENT

4.1.1 LIMITS OF OUTPUT POWER MEASUREMENT

Mobile and portable stations are limited to 2 watts EIRP.

4.1.2 TEST PROCEDURES

EIRP MEASUREMENT:

- a. All measurements were done at low, middle and high operational frequency range. RBW and VBW is 1MHz for GSM, GPRS & EDGE, 5MHz for CDMA & WCDMA, and 10MHz for LTE mode.
- b. Substitution method is used for E.I.R.P measurement. In the semi-anechoic chamber, EUT placed on the 0.8m height of Turn Table, rotated the table around 360 degrees to search the maximum radiation power and receiver antenna shall be rotated vertical and horizontal polarization and moved height from 1m to 4m to find the maximum polar radiated power. The “Read Value” is the spectrum reading the maximum power value.
- c. The substitution horn antenna is substituted for EUT at the same position and signals generator export the CW signal to the substitution antenna via a tx cable. Rotated the Turn Table and moved receiving antenna to find the maximum radiation power. Adjust output power level of S.G to get a Value of spectrum reading equal to “Read Value” of step b. Record the power level of S.G
- d. $EIRP = \text{Output power level of S.G} - \text{TX cable loss} + \text{Antenna gain of substitution horn}.$

CONDUCTED POWER MEASUREMENT:

The EUT was set up for the maximum power with GSM, GPRS, EDGE & WCDMA & LTE link data modulation and link up with simulator. Set the EUT to transmit under low, middle and high channel and record the power level shown on simulator.

4.1.3 TEST SETUP

EIRP / ERP MEASUREMENT:

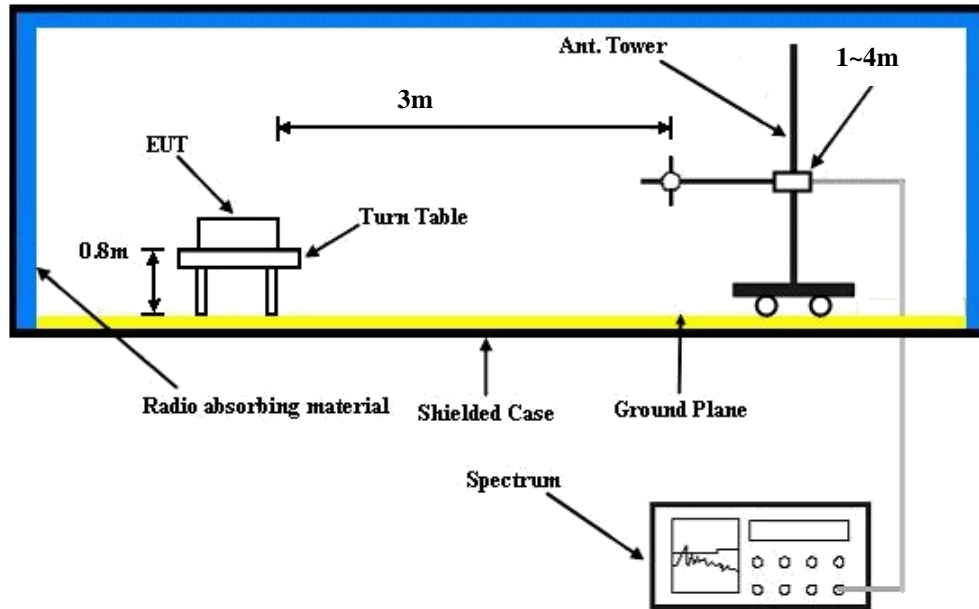

CONDUCTED POWER MEASUREMENT:

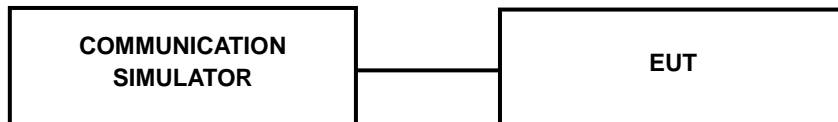



4.1.4 TEST RESULTS

CONDUCTED OUTPUT POWER (dBm)

Band	GSM1900		
Channel	512	661	810
Frequency (MHz)	1850.2	1880.0	1909.8
GSM (1 Uplink)	31.12	30.24	30.20
GPRS 8 (GMSK, 1 slot)	31.03	30.15	30.11
GPRS 10 (GMSK, 2 slot)	29.83	28.95	28.91
GPRS 11 (GMSK, 3 slot)	27.59	26.71	26.67
GPRS 12 (GMSK, 4 slot)	26.45	25.57	25.53
EDGE 8 (8PSK, 1 Uplink)	26.93	26.05	26.01
EDGE 10 (8PSK, 2 Uplink)	25.95	25.07	25.03
EDGE 11 (8PSK, 3 Uplink)	25.47	24.59	24.55
EDGE 12 (8PSK, 4 Uplink)	24.41	23.53	23.49

Band	WCDMA II		
Channel	9262	9400	9538
Frequency (MHz)	1852.4	1880.0	1907.6
RMC 12.2K	22.71	22.79	22.75
HSDPA Subtest-1	21.61	21.69	21.65
HSDPA Subtest-2	21.57	21.65	21.61
HSDPA Subtest-3	21.12	21.20	21.16
HSDPA Subtest-4	21.01	21.09	21.05
HSUPA Subtest-1	21.10	21.18	21.14
HSUPA Subtest-2	20.09	20.16	20.11
HSUPA Subtest-3	19.91	19.99	19.95
HSUPA Subtest-4	20.01	20.13	20.11
HSUPA Subtest-5	21.58	21.66	21.62

Band	CDMA		
Channel	25	600	1175
Frequency (MHz)	1851.25	1880	1908.75
RC1+SO55	23.61	23.44	23.63
RC3+SO55	23.51	23.34	23.73
RC3+SO32(+ F-SCH)	23.48	23.31	23.60
RC3+SO32(+SCH)	23.48	23.31	23.60
RTAP 153.6	23.53	23.36	23.65
RETAP 4096	23.50	23.33	23.62



A D T

Band / BW	RB Size	RB Offset	QPSK			3GPP MPR (dB)	16QAM			3GPP MPR (dB)
			Low CH 18607	Mid CH 18900	High CH 19193		Low CH 18607	Mid CH 18900	High CH 19193	
			1850.7 MHz	1880.0 MHz	1909.3 MHz		1850.7 MHz	1880.0 MHz	1909.3 MHz	
2 / 1.4M	1	0	21.97	21.95	21.58	0	21.36	21.34	20.97	1
	1	2	21.79	21.75	21.65	0	21.18	21.14	21.04	1
	1	5	21.73	21.52	21.15	0	21.12	20.91	20.54	1
	3	0	22.32	22.28	22.14	0	21.71	21.67	21.53	1
	3	1	22.10	22.20	22.19	0	21.49	21.59	21.58	1
	3	3	22.02	22.10	22.19	0	21.41	21.49	21.58	1
	6	0	21.22	21.21	21.25	1	20.61	20.60	20.64	2

Band / BW	RB Size	RB Offset	QPSK			3GPP MPR (dB)	16QAM			3GPP MPR (dB)
			Low CH 18615	Mid CH 18900	High CH 19185		Low CH 18615	Mid CH 18900	High CH 19185	
			1851.5 MHz	1880.0 MHz	1908.5 MHz		1851.5 MHz	1880.0 MHz	1908.5 MHz	
2 / 3M	1	0	22.12	22.10	21.73	0	21.38	21.36	20.99	1
	1	7	21.94	21.90	21.80	0	21.20	21.16	21.06	1
	1	14	21.88	21.67	21.30	0	21.14	20.93	20.56	1
	8	0	21.47	21.43	21.29	1	20.73	20.69	20.55	2
	8	3	21.25	21.35	21.34	1	20.51	20.61	20.60	2
	8	7	21.17	21.25	21.34	1	20.43	20.51	20.60	2
	15	0	21.37	21.36	21.40	1	20.63	20.62	20.66	2

Band / BW	RB Size	RB Offset	QPSK			3GPP MPR (dB)	16QAM			3GPP MPR (dB)
			Low CH 18625	Mid CH 18900	High CH 19175		Low CH 18625	Mid CH 18900	High CH 19175	
			1852.5 MHz	1880.0 MHz	1907.5 MHz		1852.5 MHz	1880.0 MHz	1907.5 MHz	
2 / 5M	1	0	22.25	22.23	21.86	0	21.44	21.42	21.05	1
	1	12	22.07	22.03	21.93	0	21.26	21.22	21.12	1
	1	24	22.01	21.80	21.43	0	21.20	20.99	20.62	1
	12	0	21.60	21.56	21.42	1	20.79	20.75	20.61	2
	12	6	21.38	21.48	21.47	1	20.57	20.67	20.66	2
	12	13	21.30	21.38	21.47	1	20.49	20.57	20.66	2
	25	0	21.50	21.49	21.53	1	20.69	20.68	20.72	2

Band / BW	RB Size	RB Offset	QPSK			3GPP MPR (dB)	16QAM			3GPP MPR (dB)
			Low CH 18650	Mid CH 18900	High CH 19150		Low CH 18650	Mid CH 18900	High CH 19150	
			1855.0 MHz	1880.0 MHz	1905.0 MHz		1855.0 MHz	1880.0 MHz	1905.0 MHz	
2 / 10M	1	0	22.36	22.34	21.97	0	21.48	21.46	21.09	1
	1	24	22.18	22.14	22.04	0	21.30	21.26	21.16	1
	1	49	22.12	21.91	21.54	0	21.24	21.03	20.66	1
	25	0	21.71	21.67	21.53	1	20.83	20.79	20.65	2
	25	12	21.49	21.59	21.58	1	20.61	20.71	20.70	2
	25	25	21.41	21.49	21.58	1	20.53	20.61	20.70	2
	50	0	21.61	21.60	21.64	1	20.73	20.72	20.76	2



A D T

Band / BW	RB Size	RB Offset	QPSK			3GPP MPR (dB)	16QAM			3GPP MPR (dB)
			Low CH 18675	Mid CH 18900	High CH 19125		Low CH 18675	Mid CH 18900	High CH 19125	
			1857.5 MHz	1880.0 MHz	1902.5 MHz		1857.5 MHz	1880.0 MHz	1902.5 MHz	
2 / 15M	1	0	22.50	22.48	22.11	0	21.56	21.54	21.17	1
	1	37	22.32	22.28	22.18	0	21.38	21.34	21.24	1
	1	74	22.26	22.05	21.68	0	21.32	21.11	20.74	1
	36	0	21.85	21.81	21.67	1	20.91	20.87	20.73	2
	36	19	21.63	21.73	21.72	1	20.69	20.79	20.78	2
	36	39	21.55	21.63	21.72	1	20.61	20.69	20.78	2
	75	0	21.75	21.74	21.78	1	20.81	20.80	20.84	2

Band / BW	RB Size	RB Offset	QPSK			3GPP MPR (dB)	16QAM			3GPP MPR (dB)
			Low CH 18700	Mid CH 18900	High CH 19100		Low CH 18700	Mid CH 18900	High CH 19100	
			1860.0 MHz	1880.0 MHz	1900.0 MHz		1860.0 MHz	1880.0 MHz	1900.0 MHz	
2 / 20M	1	0	22.66	22.64	22.27	0	21.59	21.57	21.20	1
	1	50	22.48	22.44	22.34	0	21.41	21.37	21.27	1
	1	99	22.42	22.21	21.84	0	21.35	21.14	20.77	1
	50	0	22.01	21.97	21.83	1	20.94	20.90	20.76	2
	50	25	21.79	21.89	21.88	1	20.72	20.82	20.81	2
	50	50	21.71	21.79	21.88	1	20.64	20.72	20.81	2
	100	0	21.91	21.90	21.94	1	20.84	20.83	20.87	2



A D T

EIRP POWER (dBm)

GSM							
Plane	Channel	Frequency (MHz)	LVL (dBm)	Correction Factor(dB)	EIRP(dBm)	EIRP(mW)	Polarization (H/V)
X	512	1850.2	-13.72	44.70	30.98	1253.14	H
	661	1880.0	-13.76	44.70	30.94	1241.65	H
	810	1909.8	-13.63	44.57	30.94	1242.51	H
	512	1850.2	-18.76	44.27	25.51	355.63	V
	661	1880.0	-19.78	44.87	25.09	322.85	V
	810	1909.8	-19.26	44.61	25.35	343.00	V

EDGE							
Plane	Channel	Frequency (MHz)	LVL (dBm)	Correction Factor(dB)	EIRP(dBm)	EIRP(mW)	Polarization (H/V)
X	512	1850.2	-18.05	44.70	26.65	462.38	H
	661	1880.0	-17.99	44.70	26.71	468.81	H
	810	1909.8	-18.56	44.57	26.01	399.30	H
	512	1850.2	-22.96	44.27	21.31	135.21	V
	661	1880.0	-23.58	44.87	21.29	134.59	V
	810	1909.8	-22.73	44.61	21.88	154.28	V

WCDMA							
Plane	Channel	Frequency (MHz)	LVL (dBm)	Correction Factor(dB)	EIRP(dBm)	EIRP(mW)	Polarization (H/V)
X	9262	1852.4	-22.07	44.70	22.63	183.23	H
	9400	1880.0	-22.53	44.70	22.17	164.82	H
	9538	1907.6	-21.74	44.57	22.83	192.00	H
	9262	1852.4	-27.21	44.27	17.06	50.82	V
	9400	1880.0	-27.31	44.87	17.56	57.02	V
	9538	1907.6	-26.90	44.61	17.71	59.06	V



A D T

CDMA							
Plane	Channel	Frequency (MHz)	LVL (dBm)	Correction Factor(dB)	EIRP(dBm)	EIRP(mW)	Polarization (H/V)
X	25	1851.25	-21.02	44.70	23.68	233.35	H
	600	1880.00	-21.59	44.70	23.11	204.64	H
	1175	1908.75	-21.53	44.57	23.04	201.51	H
	25	1851.25	-26.33	44.27	17.94	62.23	V
	600	1880.00	-27.67	44.87	17.20	52.48	V
	1175	1908.75	-27.06	44.61	17.55	56.92	V

LTE Band 2							
Channel Bandwidth: 1.4MHz / QPSK							
Plane	Channel	Frequency (MHz)	LVL (dBm)	Correction Factor(dB)	EIRP(dBm)	EIRP(mW)	Polarization (H/V)
X	18607	1850.7	-23.08	44.70	21.62	145.21	H
	18900	1880.0	-22.93	44.70	21.77	150.31	H
	19193	1909.3	-22.51	44.57	22.06	160.81	H
	18607	1850.7	-28.97	44.27	15.30	33.88	V
	18900	1880.0	-28.91	44.87	15.96	39.45	V
	19193	1909.3	-28.70	44.61	15.91	39.02	V

LTE Band 2							
Channel Bandwidth: 1.4MHz / 16QAM							
Plane	Channel	Frequency (MHz)	LVL (dBm)	Correction Factor(dB)	EIRP(dBm)	EIRP(mW)	Polarization (H/V)
X	18607	1850.7	-23.98	44.70	20.72	118.03	H
	18900	1880.0	-24.06	44.70	20.64	115.88	H
	19193	1909.3	-24.09	44.57	20.48	111.76	H
	18607	1850.7	-29.86	44.27	14.41	27.61	V
	18900	1880.0	-30.60	44.87	14.27	26.73	V
	19193	1909.3	-29.79	44.61	14.82	30.36	V



LTE Band 2							
Channel Bandwidth: 3MHz / QPSK							
Plane	Channel	Frequency (MHz)	LVL (dBm)	Correction Factor(dB)	EIRP(dBm)	EIRP(mW)	Polarization (H/V)
X	18615	1851.5	-23.54	44.70	21.16	130.62	H
	18900	1880.0	-23.15	44.70	21.55	142.89	H
	19185	1908.5	-22.58	44.57	21.99	158.23	H
	18615	1851.5	-29.14	44.27	15.13	32.58	V
	18900	1880.0	-29.63	44.87	15.24	33.42	V
	19185	1908.5	-29.57	44.61	15.04	31.94	V

LTE Band 2							
Channel Bandwidth: 3MHz / 16QAM							
Plane	Channel	Frequency (MHz)	LVL (dBm)	Correction Factor(dB)	EIRP(dBm)	EIRP(mW)	Polarization (H/V)
X	18615	1851.5	-24.63	44.70	20.07	101.62	H
	18900	1880.0	-23.71	44.70	20.99	125.60	H
	19185	1908.5	-23.79	44.57	20.78	119.76	H
	18615	1851.5	-29.68	44.27	14.59	28.77	V
	18900	1880.0	-30.20	44.87	14.67	29.31	V
	19185	1908.5	-29.91	44.61	14.70	29.53	V

LTE Band 2							
Channel Bandwidth: 5MHz / QPSK							
Plane	Channel	Frequency (MHz)	LVL (dBm)	Correction Factor(dB)	EIRP(dBm)	EIRP(mW)	Polarization (H/V)
X	18625	1852.5	-22.88	44.70	21.82	152.05	H
	18900	1880.0	-23.36	44.70	21.34	136.14	H
	19175	1907.5	-23.03	44.57	21.54	142.66	H
	18625	1852.5	-29.02	44.27	15.25	33.50	V
	18900	1880.0	-29.24	44.87	15.63	36.56	V
	19175	1907.5	-28.86	44.61	15.75	37.61	V



A D T

LTE Band 2							
Channel Bandwidth: 5MHz / 16QAM							
Plane	Channel	Frequency (MHz)	LVL (dBm)	Correction Factor(dB)	EIRP(dBm)	EIRP(mW)	Polarization (H/V)
X	18625	1852.5	-24.28	44.70	20.42	110.15	H
	18900	1880.0	-23.64	44.70	21.06	127.64	H
	19175	1907.5	-24.40	44.57	20.17	104.06	H
	18625	1852.5	-29.81	44.27	14.46	27.93	V
	18900	1880.0	-30.47	44.87	14.40	27.54	V
	19175	1907.5	-29.91	44.61	14.70	29.53	V

LTE Band 2							
Channel Bandwidth: 10MHz / QPSK							
Plane	Channel	Frequency (MHz)	LVL (dBm)	Correction Factor(dB)	EIRP(dBm)	EIRP(mW)	Polarization (H/V)
X	18650	1855.0	-23.23	44.70	21.47	140.28	H
	18900	1880.0	-22.91	44.70	21.79	151.01	H
	19150	1905.0	-23.16	44.57	21.41	138.45	H
	18650	1855.0	-29.22	44.27	15.05	31.99	V
	18900	1880.0	-29.02	44.87	15.85	38.46	V
	19150	1905.0	-29.10	44.61	15.51	35.59	V

LTE Band 2							
Channel Bandwidth: 10MHz / 16QAM							
Plane	Channel	Frequency (MHz)	LVL (dBm)	Correction Factor(dB)	EIRP(dBm)	EIRP(mW)	Polarization (H/V)
X	18650	1855.0	-23.83	44.70	20.87	122.18	H
	18900	1880.0	-24.24	44.70	20.46	111.17	H
	19150	1905.0	-24.36	44.57	20.21	105.03	H
	18650	1855.0	-29.35	44.27	14.92	31.05	V
	18900	1880.0	-30.50	44.87	14.37	27.35	V
	19150	1905.0	-30.34	44.61	14.27	26.75	V



A D T

LTE Band 2							
Channel Bandwidth: 15MHz / QPSK							
Plane	Channel	Frequency (MHz)	LVL (dBm)	Correction Factor(dB)	EIRP(dBm)	EIRP(mW)	Polarization (H/V)
X	18675	1857.5	-23.27	44.70	21.43	139.00	H
	18900	1880.0	-22.77	44.70	21.93	155.96	H
	19125	1902.5	-22.50	44.57	22.07	161.18	H
	18675	1857.5	-28.83	44.27	15.44	34.99	V
	18900	1880.0	-28.94	44.87	15.93	39.17	V
	19125	1902.5	-29.10	44.61	15.51	35.59	V

LTE Band 2							
Channel Bandwidth: 15MHz / 16QAM							
Plane	Channel	Frequency (MHz)	LVL (dBm)	Correction Factor(dB)	EIRP(dBm)	EIRP(mW)	Polarization (H/V)
X	18675	1857.5	-23.72	44.70	20.98	125.31	H
	18900	1880.0	-23.44	44.70	21.26	133.66	H
	19125	1902.5	-23.80	44.57	20.77	119.48	H
	18675	1857.5	-29.46	44.27	14.81	30.27	V
	18900	1880.0	-30.47	44.87	14.40	27.54	V
	19125	1902.5	-29.55	44.61	15.06	32.08	V

LTE Band 2							
Channel Bandwidth: 20MHz / QPSK							
Plane	Channel	Frequency (MHz)	LVL (dBm)	Correction Factor(dB)	EIRP(dBm)	EIRP(mW)	Polarization (H/V)
X	18700	1860.0	-22.41	44.70	22.29	169.43	H
	18900	1880.0	-22.81	44.70	21.89	154.53	H
	19100	1900.0	-22.36	44.57	22.21	166.46	H
	18700	1860.0	-28.84	44.27	15.43	34.91	V
	18900	1880.0	-29.21	44.87	15.66	36.81	V
	19100	1900.0	-29.02	44.61	15.59	36.25	V



A D T

LTE Band 2							
Channel Bandwidth: 20MHz / 16QAM							
Plane	Channel	Frequency (MHz)	LVL (dBm)	Correction Factor(dB)	EIRP(dBm)	EIRP(mW)	Polarization (H/V)
X	18700	1860.0	-24.14	44.70	20.56	113.76	H
	18900	1880.0	-23.97	44.70	20.73	118.30	H
	19100	1900.0	-23.78	44.57	20.79	120.03	H
	18700	1860.0	-29.06	44.27	15.21	33.19	V
	18900	1880.0	-30.54	44.87	14.33	27.10	V
	19100	1900.0	-30.31	44.61	14.30	26.93	V

4.2 FREQUENCY STABILITY MEASUREMENT

4.2.1 LIMITS OF FREQUENCY STABILITY MEASUREMENT

The frequency stability shall be sufficient to ensure that the fundamental emission stays within the authorized frequency block.

4.2.2 TEST PROCEDURE

- Device is placed at the oven room. The oven room could control the temperatures and humidity. Power warm up is at least 15 min and power applied should perform before recording frequency error.
- EUT is connected the external power supply to control the DC input power. The test voltage range is from minimum to maximum working voltage. Each step shall be record the frequency error rate.
- The temperature range step is 10 degrees in this test items. All temperature levels shall be hold the $\pm 0.5^{\circ}\text{C}$ during the measurement testing. The each temperature step shall be at least 0.5 hours, consider the EUT could be test under the stability condition.

NOTE: The frequency error was recorded frequency error from the communication simulator.

4.2.3 TEST SETUP

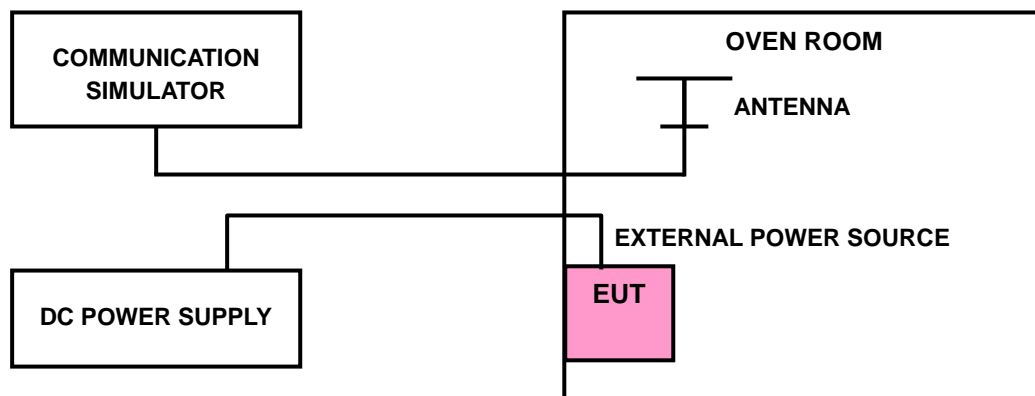

4.2.4 TEST RESULTS

FREQUENCY ERROR vs. VOLTAGE

VOLTAGE (Volts)	FREQUENCY ERROR (ppm)				LIMIT (ppm)
	GSM	EDGE	WCDMA	CDMA	
3.8	0.002	0.001	0.001	0.002	2.5
3.6	0.001	-0.001	0.002	0.001	2.5
4.4	-0.001	-0.002	0.003	-0.001	2.5

NOTE: The applicant defined the normal working voltage of the battery is from 3.6Vdc to 4.4Vdc.

FREQUENCY ERROR vs. TEMPERATURE

TEMP. (°C)	FREQUENCY ERROR (ppm)				LIMIT (ppm)
	GSM	EDGE	WCDMA	CDMA	
-35	0.001	0.002	0.001	0.001	2.5
-30	0.002	0.002	0.001	0.002	2.5
-20	0.001	0.002	0.002	0.001	2.5
-10	-0.001	0.001	0.003	0.001	2.5
0	-0.002	-0.002	0.002	-0.002	2.5
10	-0.003	-0.003	0.001	-0.001	2.5
20	-0.002	-0.001	0.001	-0.001	2.5
30	0.001	0.002	-0.002	0.001	2.5
40	0.001	0.001	-0.002	0.002	2.5
50	0.003	0.003	-0.001	0.002	2.5
60	0.003	0.001	-0.001	0.003	2.5



FREQUENCY ERROR vs. VOLTAGE

VOLTAGE (Volts)	FREQUENCY ERROR (ppm)						LIMIT (ppm)
	LTE Band 2						
	1.4MHz	3MHz	5MHz	10MHz	15MHz	20MHz	
3.8	0.001	0.003	0.001	0.001	0.002	0.001	2.5
3.6	0.002	0.002	-0.001	0.002	0.001	0.002	2.5
4.4	0.001	0.001	0.001	0.001	-0.001	0.002	2.5

NOTE: The applicant defined the normal working voltage of the battery is from 3.6Vdc to 4.4Vdc.

FREQUENCY ERROR vs. TEMPERATURE

TEMP. (°C)	FREQUENCY ERROR (ppm)						LIMIT (ppm)
	LTE Band 2						
	1.4MHz	3MHz	5MHz	10MHz	15MHz	20MHz	
-35	0.001	0.001	0.001	0.002	0.001	0.001	2.5
-30	0.002	0.002	0.001	0.001	0.002	0.002	2.5
-20	0.003	0.002	0.002	0.001	0.001	0.001	2.5
-10	0.004	0.001	0.001	-0.002	0.001	0.003	2.5
0	0.001	-0.002	0.001	-0.002	-0.002	0.003	2.5
10	-0.001	-0.001	-0.002	-0.003	-0.003	0.001	2.5
20	-0.002	-0.003	-0.002	-0.001	-0.002	-0.001	2.5
30	-0.002	-0.001	-0.003	0.001	0.001	-0.001	2.5
40	-0.001	0.001	-0.001	0.002	0.003	-0.002	2.5
50	0.001	0.001	0.002	0.003	0.002	-0.001	2.5
55	0.001	0.003	0.002	0.001	0.001	-0.001	2.5

4.3 OCCUPIED BANDWIDTH MEASUREMENT

4.3.1 TEST PROCEDURES

The EUT makes a call to the communication simulator. All measurements were done at low, middle and high operational frequency range. The communication simulator station system controlled a EUT to export maximum output power under transmission mode and specific channel frequency. Use OBW measurement function of Spectrum analyzer to measure 99 % occupied bandwidth.

4.3.2 TEST SETUP

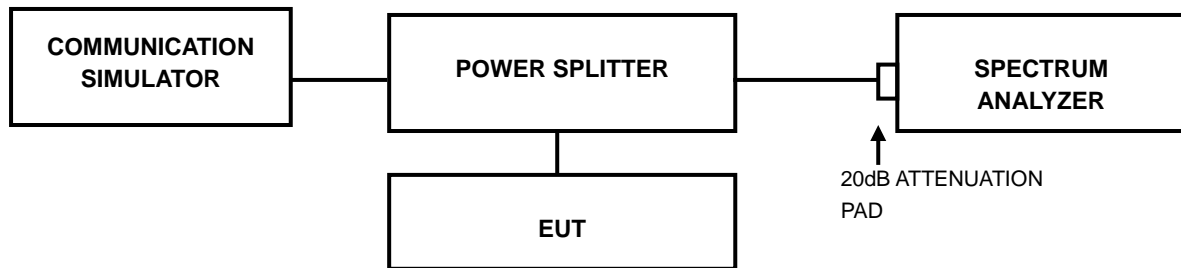



4.3.3 TEST RESULTS

CHANNEL	FREQUENCY	99% OCCUPIED BANDWIDTH (kHz)		CHANNEL	FREQUENCY	99% OCCUPIED BANDWIDTH (MHz)
		GSM	EDGE			WCDMA
512	1850.2	246.96	247.01	9262	1852.4	4.1709
661	1880.0	249.09	244.34	9400	1880.0	4.1697
810	1909.8	247.33	246.48	9538	1907.6	4.1743
CHANNEL	FREQUENCY	26dB BANDWIDTH (kHz)		CHANNEL	FREQUENCY	26dB BANDWIDTH (MHz)
		GSM	EDGE			WCDMA
512	1850.2	305.50	318.70	9262	1852.4	4.745
661	1880.0	314.90	318.80	9400	1880.0	4.748
810	1909.8	316.60	312.90	9538	1907.6	4.743

CDMA			
CHANNEL	FREQUENCY	99% OCCUPIED BANDWIDTH (MHz)	26dB BANDWIDTH (MHz)
25	1851.25	1.2748	1.426
600	1880.00	1.2750	1.430
1175	1908.75	1.2791	1.432



A D T

SPECTRUM PLOT OF WORST VALUE

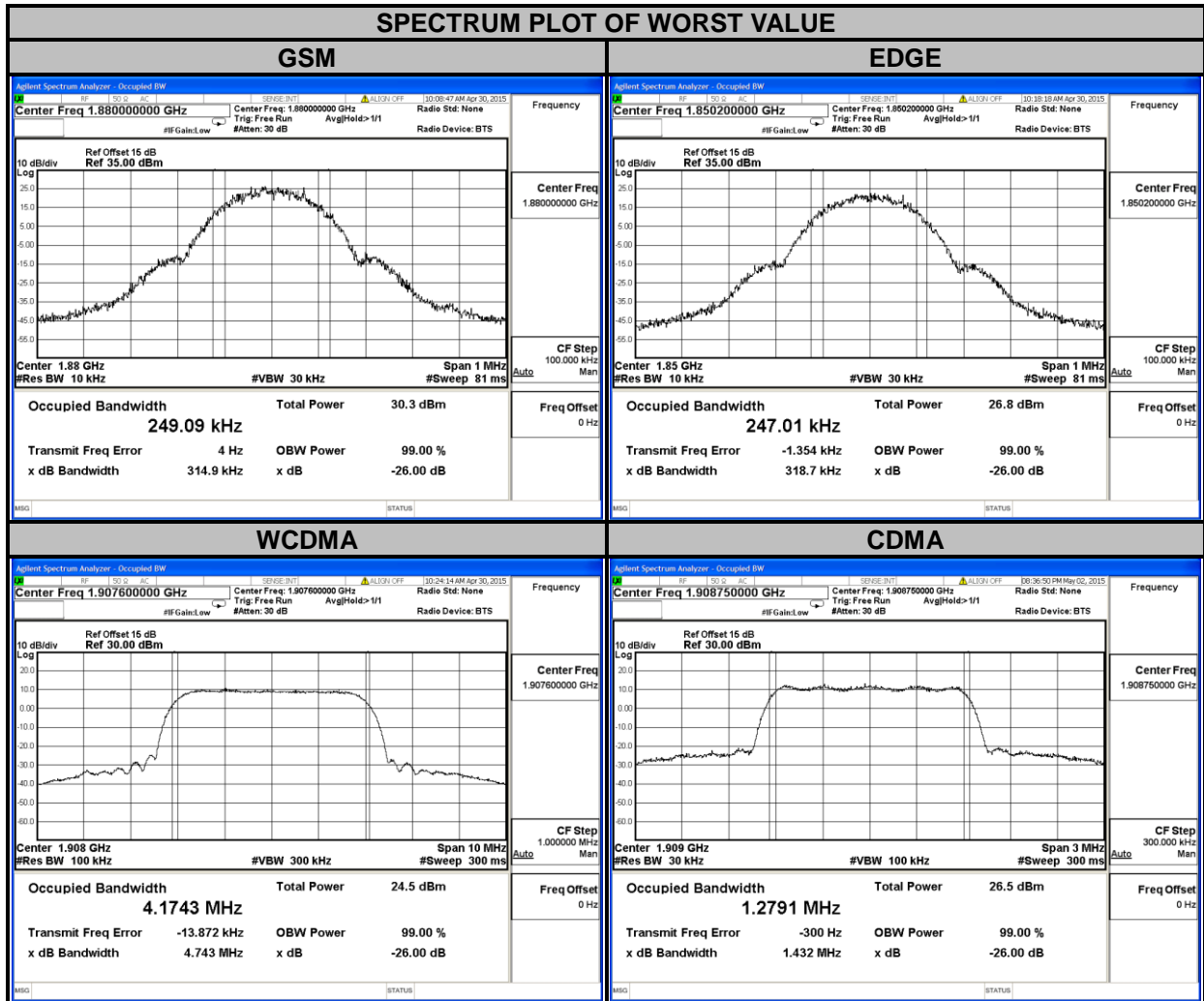



A D T

LTE BAND 2							
CHANNEL BANDWIDTH: 1.4MHz				CHANNEL BANDWIDTH: 3MHz			
CHANNEL	FREQUENCY	99% OCCUPIED BANDWIDTH (MHz)		CHANNEL	FREQUENCY	99% OCCUPIED BANDWIDTH (MHz)	
		QPSK	16QAM			QPSK	16QAM
18607	1850.7	1.0928	1.0907	18615	1851.5	2.6981	2.6988
18900	1880.0	1.0918	1.0909	18900	1880.0	2.6949	2.6983
19193	1909.3	1.0936	1.0902	19185	1908.5	2.7000	2.6974
CHANNEL	FREQUENCY	26dB BANDWIDTH (MHz)		CHANNEL	FREQUENCY	26dB BANDWIDTH (MHz)	
		QPSK	16QAM			QPSK	16QAM
18607	1850.7	1.282	1.254	18615	1851.5	2.916	2.941
18900	1880.0	1.285	1.261	18900	1880.0	2.921	2.930
19193	1909.3	1.309	1.280	19185	1908.5	2.920	2.927

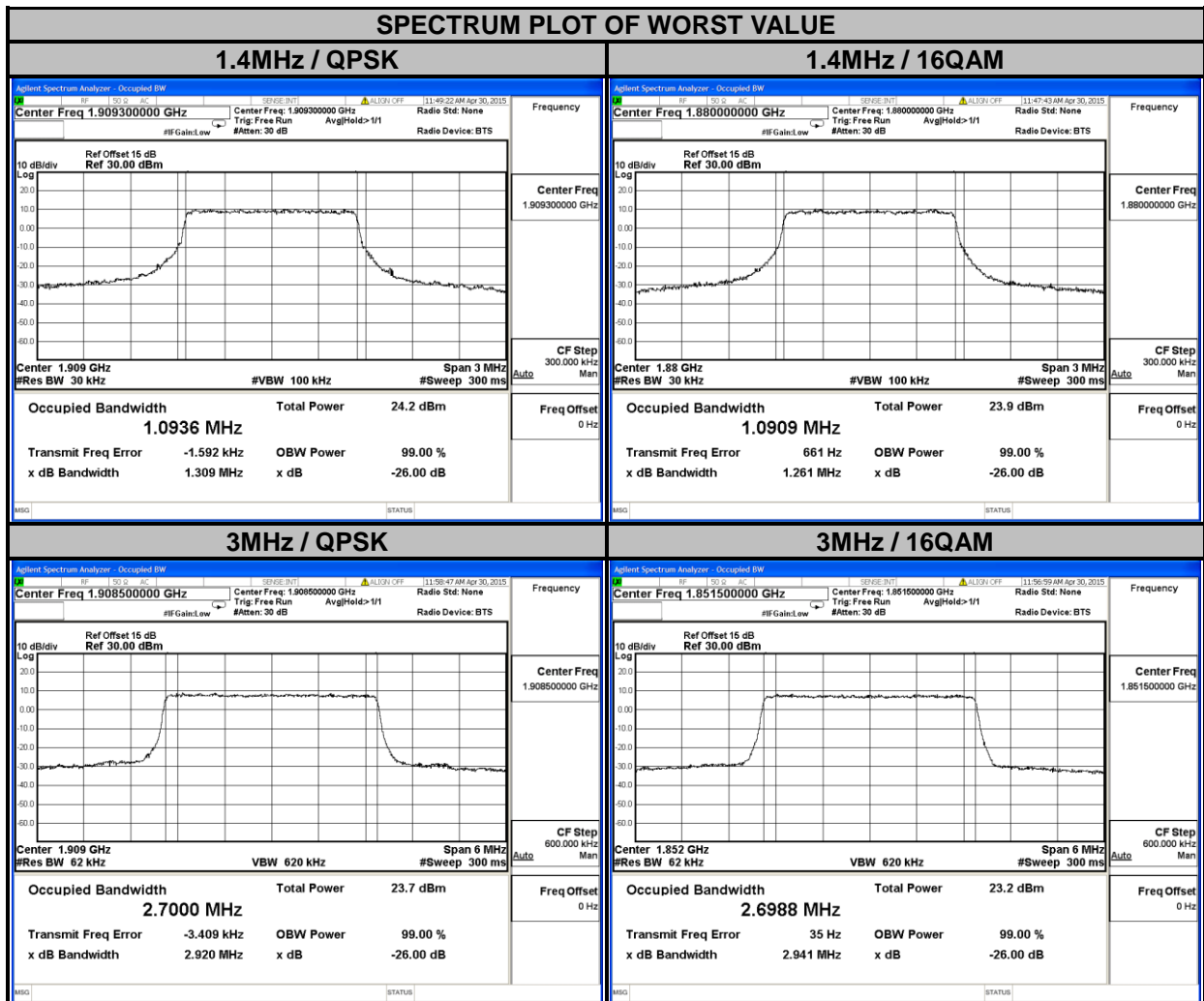



A D T

LTE BAND 2							
CHANNEL BANDWIDTH: 5MHz				CHANNEL BANDWIDTH: 10MHz			
CHANNEL	FREQUENCY	99% OCCUPIED BANDWIDTH (MHz)		CHANNEL	FREQUENCY	99% OCCUPIED BANDWIDTH (MHz)	
		QPSK	16QAM			QPSK	16QAM
18625	1852.5	4.4963	4.4964	18650	1855.0	8.9708	8.9659
18900	1880.0	4.4930	4.4928	18900	1880.0	8.9654	8.9631
19175	1907.5	4.4974	4.4957	19150	1905.0	8.9587	8.9588
CHANNEL	FREQUENCY	26dB BANDWIDTH (MHz)		CHANNEL	FREQUENCY	26dB BANDWIDTH (MHz)	
		QPSK	16QAM			QPSK	16QAM
18625	1852.5	4.862	4.827	18650	1855.0	9.542	9.520
18900	1880.0	4.852	4.822	18900	1880.0	9.516	9.513
19175	1907.5	4.864	4.840	19150	1905.0	9.505	9.530

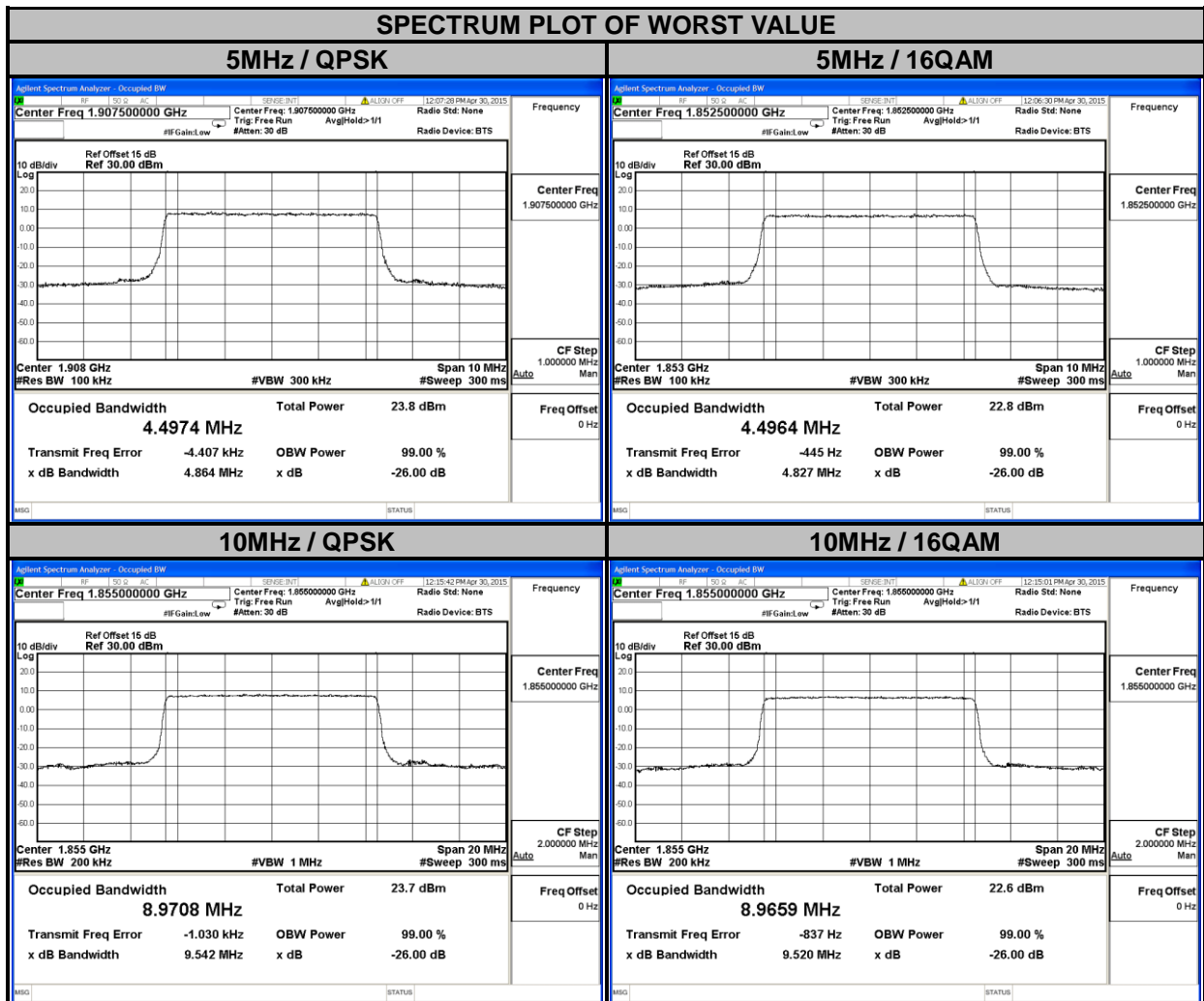



A D T

LTE BAND 2							
CHANNEL BANDWIDTH: 15MHz				CHANNEL BANDWIDTH: 20MHz			
CHANNEL	FREQUENCY	99% OCCUPIED BANDWIDTH (MHz)		CHANNEL	FREQUENCY	99% OCCUPIED BANDWIDTH (MHz)	
		QPSK	16QAM			QPSK	16QAM
18675	1857.5	13.467	13.463	18700	1860.0	17.946	17.955
18900	1880.0	13.453	13.452	18900	1880.0	17.926	17.933
19125	1902.5	13.455	13.442	19100	1900.0	17.927	17.942
CHANNEL	FREQUENCY	26dB BANDWIDTH (MHz)		CHANNEL	FREQUENCY	26dB BANDWIDTH (MHz)	
		QPSK	16QAM			QPSK	16QAM
18675	1857.5	14.26	14.27	18700	1860.0	19.03	19.04
18900	1880.0	14.25	14.26	18900	1880.0	19.03	19.01
19125	1902.5	14.25	14.26	19100	1900.0	19.05	19.04

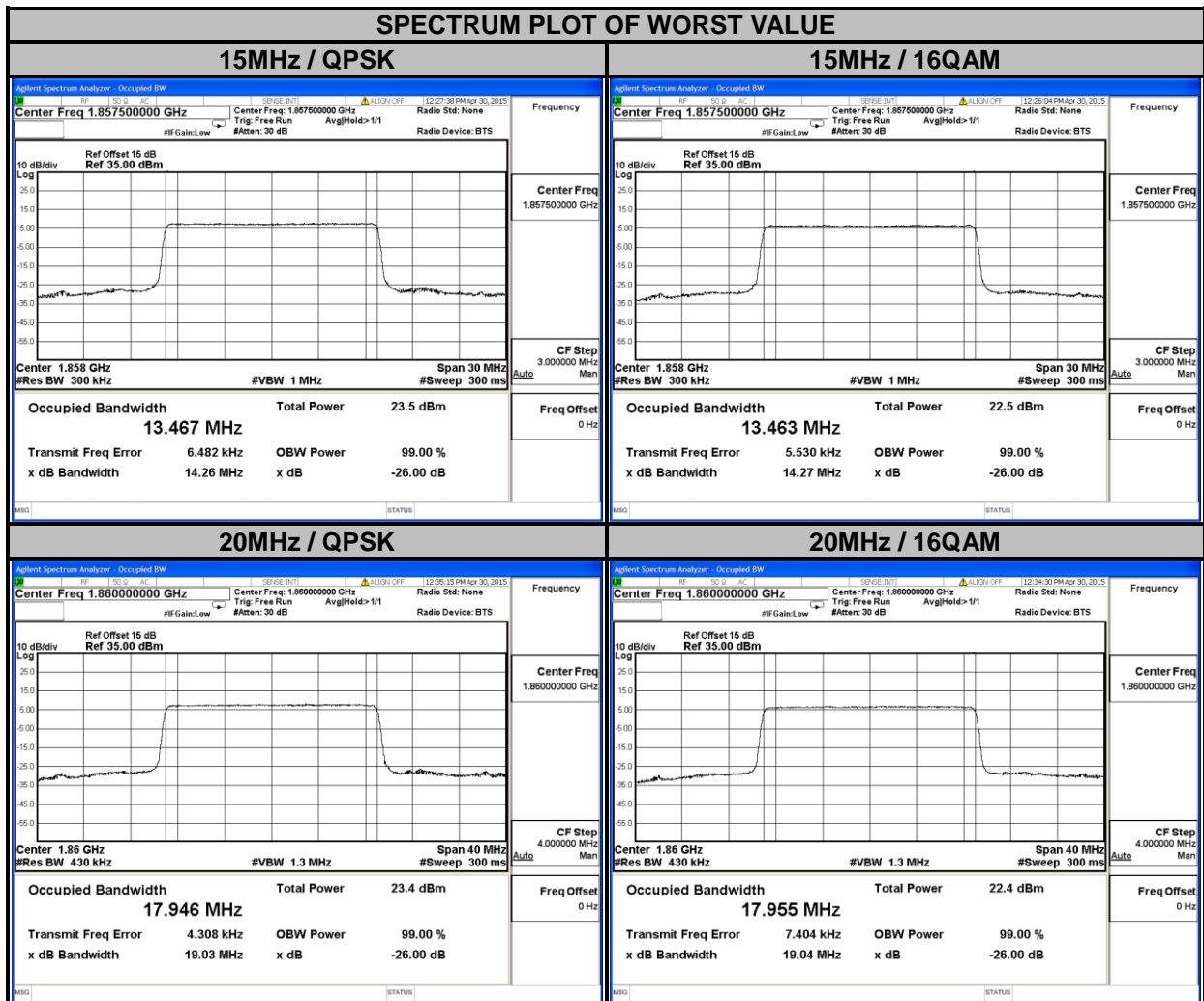

4.4 PEAK TO AVERAGE RATIO

4.4.1 LIMITS OF PEAK TO AVERAGE RATIO MEASUREMENT

In measuring transmissions in this band using an average power technique, the peak to-average ratio (PAR) of the transmission may not exceed 13 dB.

4.4.2 TEST SETUP

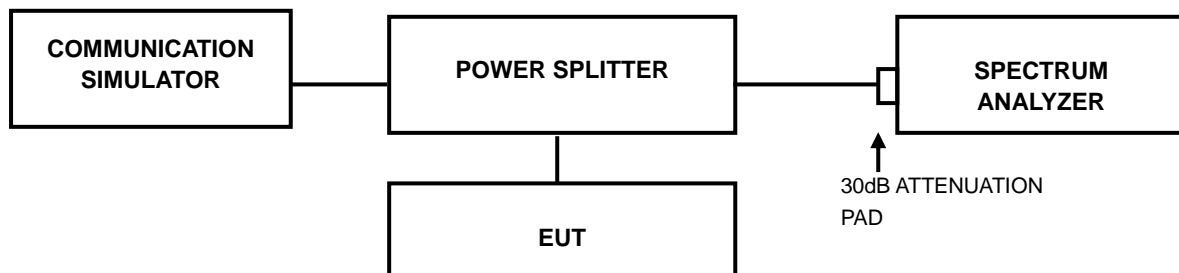

4.4.3 TEST PROCEDURES

1. Set resolution/measurement bandwidth \geq signal's occupied bandwidth;
2. Set the number of counts to a value that stabilizes the measured CCDF curve;
3. Record the maximum PAPR level associated with a probability of 0.1%.



4.4.4 TEST RESULTS

CHANNEL	FREQUENCY (MHz)	PEAK TO AVERAGE RATIO (dB)		CHANNEL	FREQUENCY (MHz)	PEAK TO AVERAGE RATIO (dB)
		GSM	EDGE			WCDMA
512	1850.2	0.27	0.27	9262	1852.4	2.98
661	1880.0	0.24	0.25	9400	1880.0	2.97
810	1909.8	0.22	0.24	9538	1907.6	2.91

CHANNEL	FREQUENCY (MHz)	PEAK TO AVERAGE RATIO (dB)
		CDMA
25	1851.25	3.53
600	1880.00	3.52
1175	1908.75	2.76

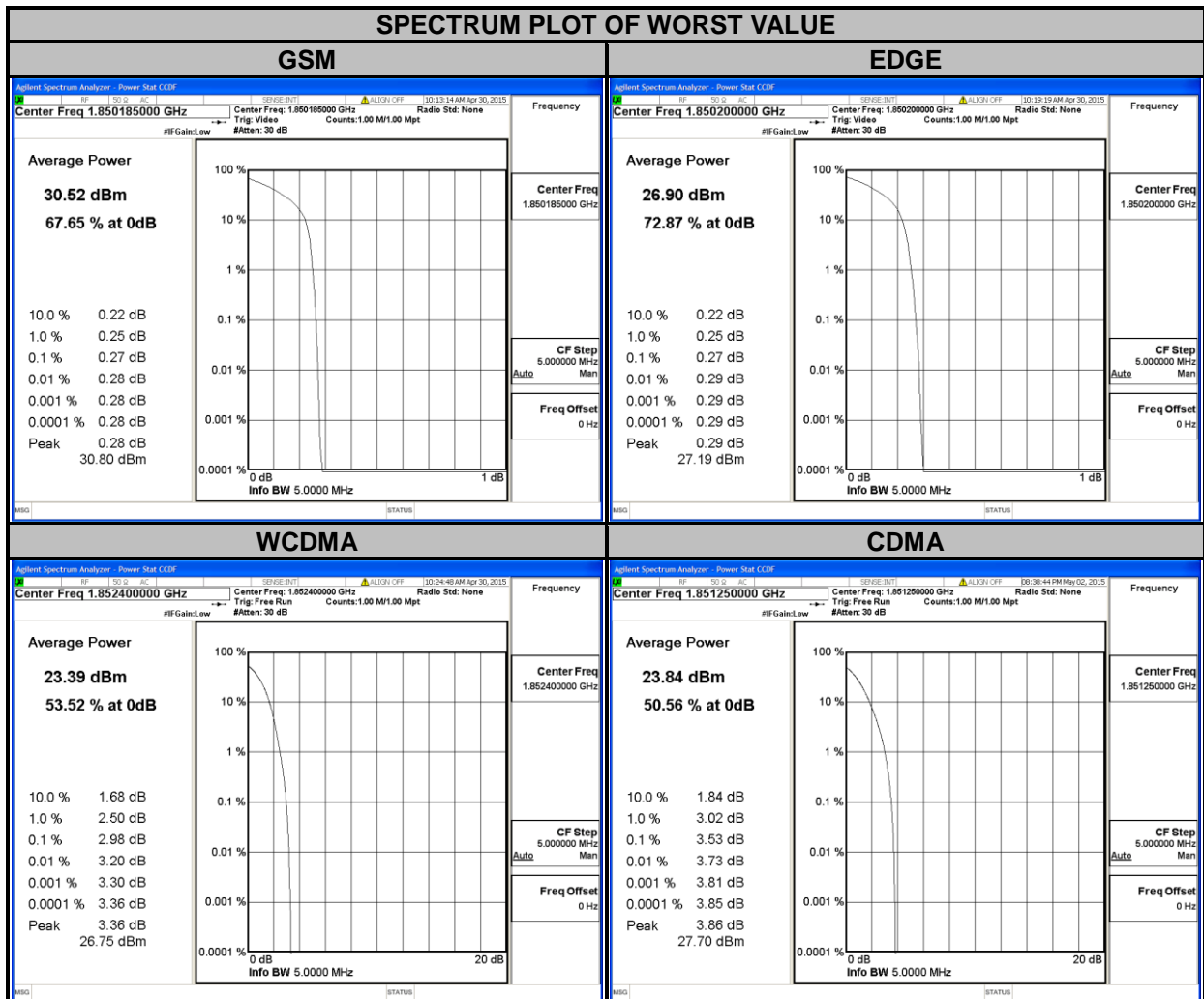



A D T

LTE BAND 2							
CHANNEL BANDWIDTH: 1.4MHz				CHANNEL BANDWIDTH: 3MHz			
CHANNEL	FREQUENCY (MHz)	PEAK TO AVERAGE RATIO (dB)		CHANNEL	FREQUENCY (MHz)	PEAK TO AVERAGE RATIO (dB)	
		QPSK	16QAM			QPSK	16QAM
18607	1850.7	4.86	5.83	18615	1851.5	4.47	4.92
18900	1880.0	4.91	5.82	18900	1880.0	4.26	5.11
19193	1909.3	4.66	5.48	19185	1908.5	4.13	4.52

SPECTRUM PLOT OF WORST VALUE

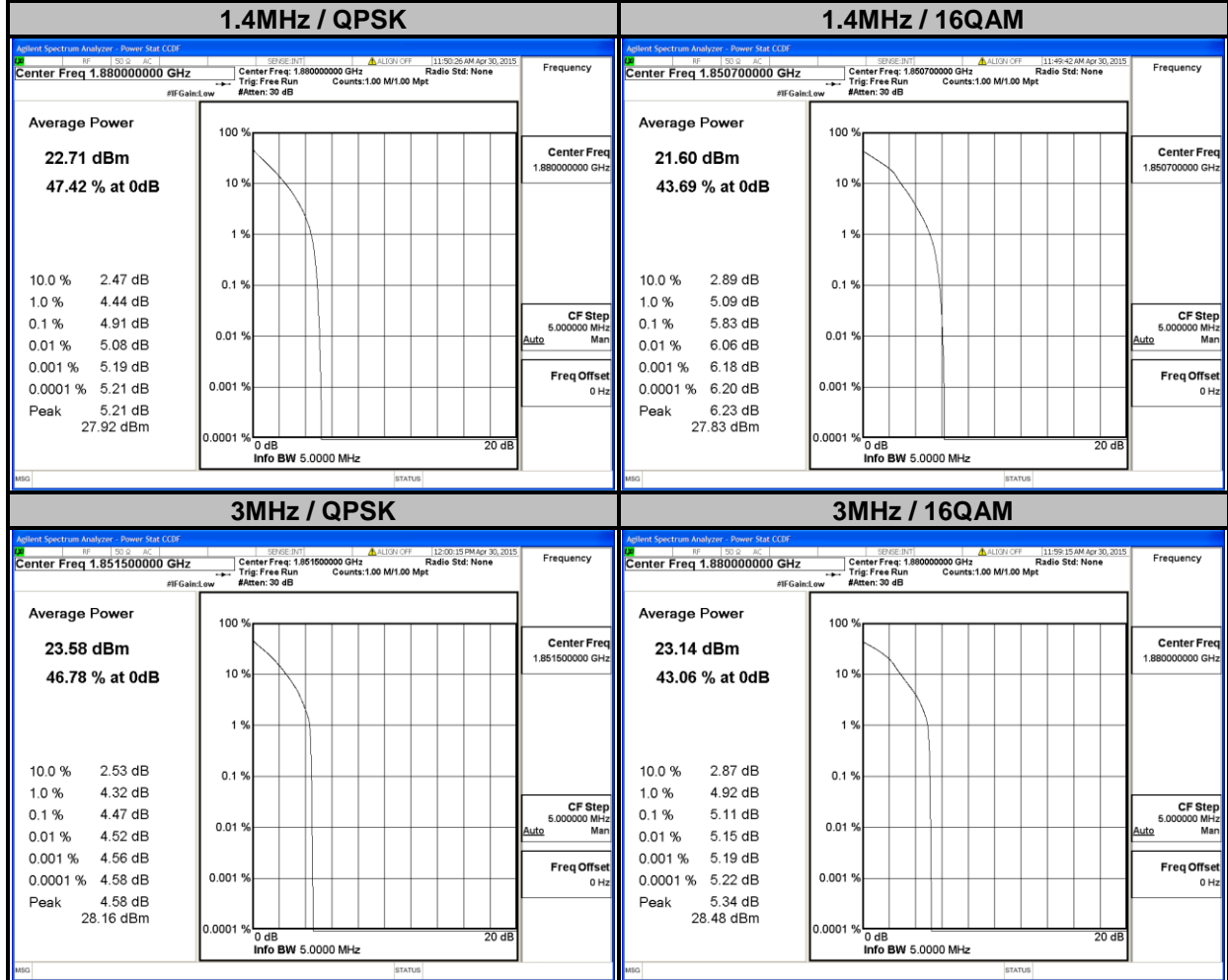



A D T

LTE BAND 2							
CHANNEL BANDWIDTH: 5MHz				CHANNEL BANDWIDTH: 10MHz			
CHANNEL	FREQUENCY (MHz)	PEAK TO AVERAGE RATIO (dB)		CHANNEL	FREQUENCY (MHz)	PEAK TO AVERAGE RATIO (dB)	
		QPSK	16QAM			QPSK	16QAM
18625	1852.5	4.21	5.06	18650	1855.0	3.96	4.71
18900	1880.0	4.07	4.87	18900	1880.0	3.86	4.81
19175	1907.5	4.12	4.54	19150	1905.0	4.24	4.71

SPECTRUM PLOT OF WORST VALUE

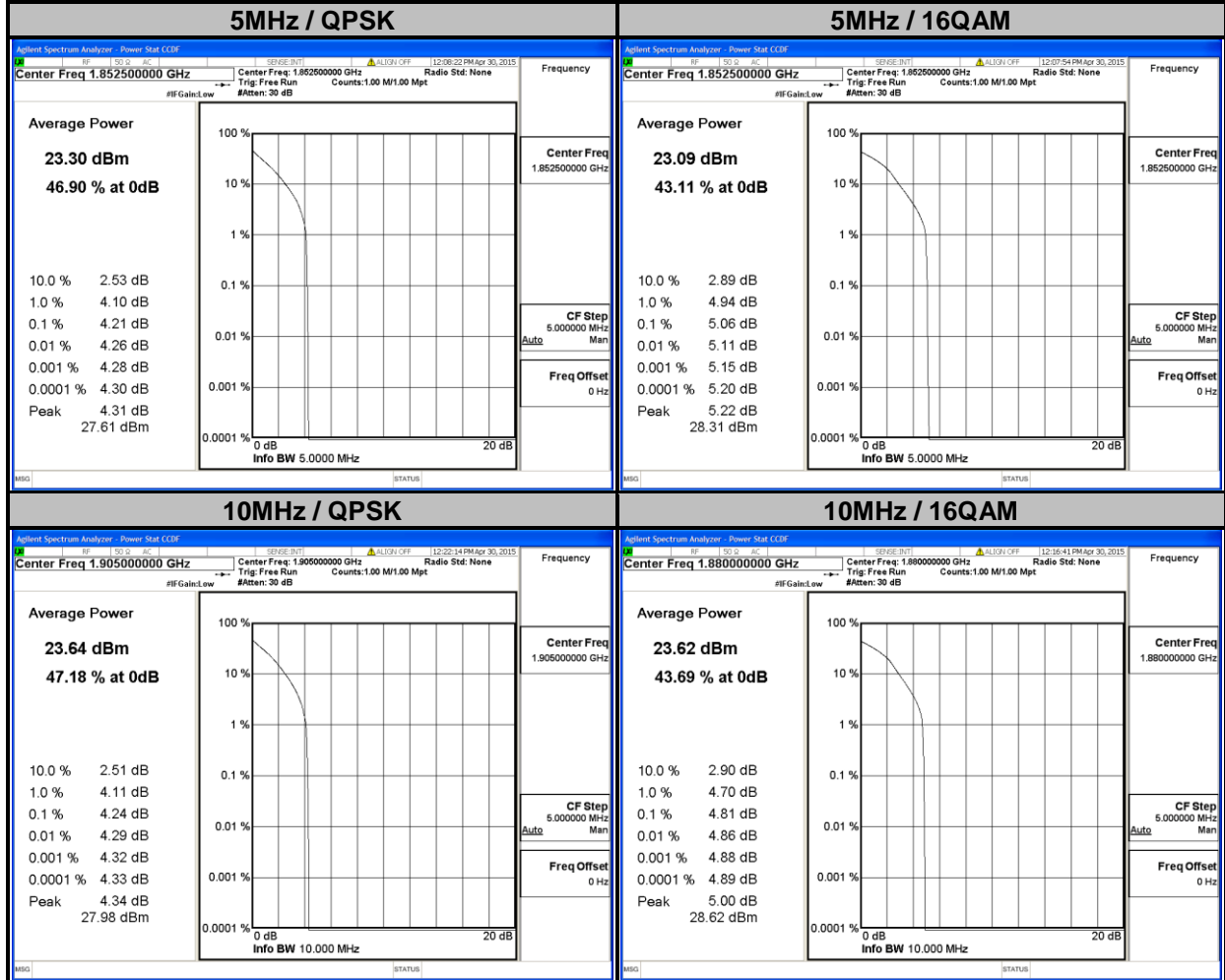



A D T

LTE BAND 2							
CHANNEL BANDWIDTH: 15MHz				CHANNEL BANDWIDTH: 20MHz			
CHANNEL	FREQUENCY (MHz)	PEAK TO AVERAGE RATIO (dB)		CHANNEL	FREQUENCY (MHz)	PEAK TO AVERAGE RATIO (dB)	
		QPSK	16QAM			QPSK	16QAM
18675	1857.5	4.33	4.83	18700	1860.0	4.26	5.02
18900	1880.0	4.02	4.83	18900	1880.0	4.28	5.00
19125	1902.5	4.28	4.91	19100	1900.0	4.29	4.95

SPECTRUM PLOT OF WORST VALUE

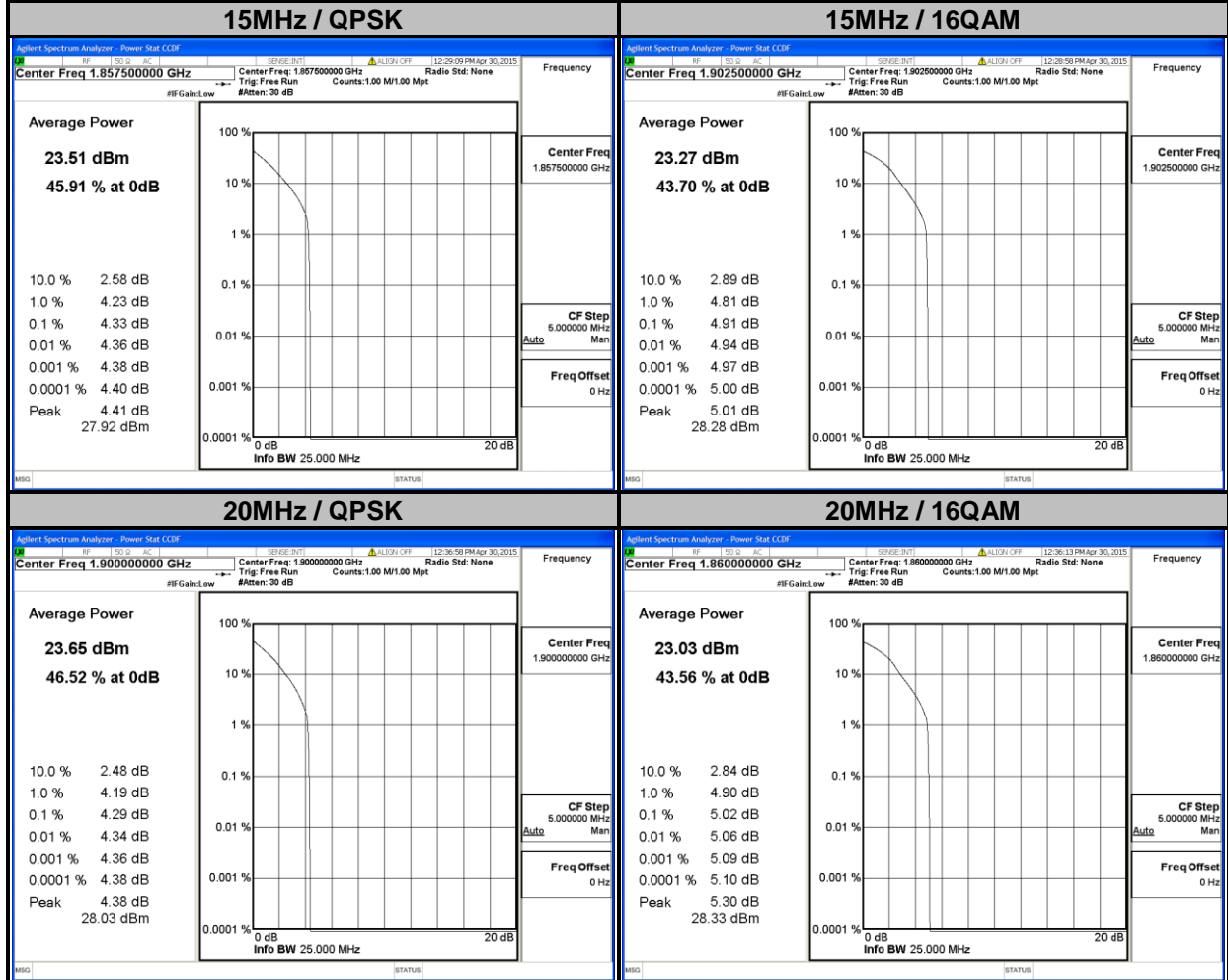

4.5 BAND EDGE MEASUREMENT

4.5.1 LIMITS OF BAND EDGE MEASUREMENT

Power of any emission outside of the authorized operating frequency ranges must be attenuated below the transmitting power (P) by a factor of at least $43 + 10 \log(P)$ dB. In the 1 MHz bands immediately outside and adjacent to the frequency block a resolution bandwidth of at least one percent of the emission bandwidth of the fundamental emission of the transmitter may be employed.

4.5.2 TEST SETUP

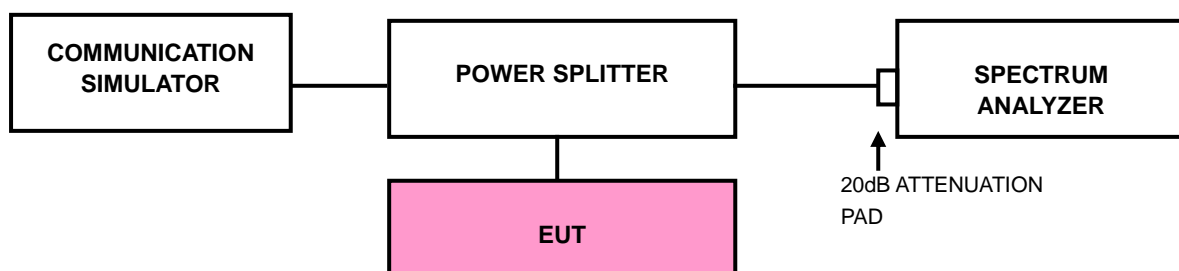

4.5.3 TEST PROCEDURES

- a. All measurements were done at low and high operational frequency range.
- b. The center frequency of spectrum is the band edge frequency and span is 1MHz. RB of the spectrum is 3.9kHz and VB of the spectrum is 12kHz (GSM/GPRS/EDGE).
- c. The center frequency of spectrum is the band edge frequency and span is 5MHz. RB of the spectrum is 100kHz and VB of the spectrum is 300kHz (WCDMA).
- d. The center frequency of spectrum is the band edge frequency and span is 1MHz. RB of the spectrum is 13kHz and VB of the spectrum is 51kHz (CDMA/LTE Bandwidth 1.4MHz).
- e. The center frequency of spectrum is the band edge frequency and span is 1MHz. RB of the spectrum is 30kHz and VB of the spectrum is 100kHz (LTE Bandwidth 3MHz).
- f. The center frequency of spectrum is the band edge frequency and span is 1MHz. RB of the spectrum is 100kHz and VB of the spectrum is 300kHz (LTE Bandwidth 5MHz/10MHz).
- g. The center frequency of spectrum is the band edge frequency and span is 1MHz. RB of the spectrum is 150kHz and VB of the spectrum is 470kHz (LTE Bandwidth 15MHz).
- h. The center frequency of spectrum is the band edge frequency and span is 1MHz. RB of the spectrum is 180kHz and VB of the spectrum is 560kHz (LTE Bandwidth 20MHz).
- i. Record the max trace plot into the test report.



A D T

4.5.4 TEST RESULTS

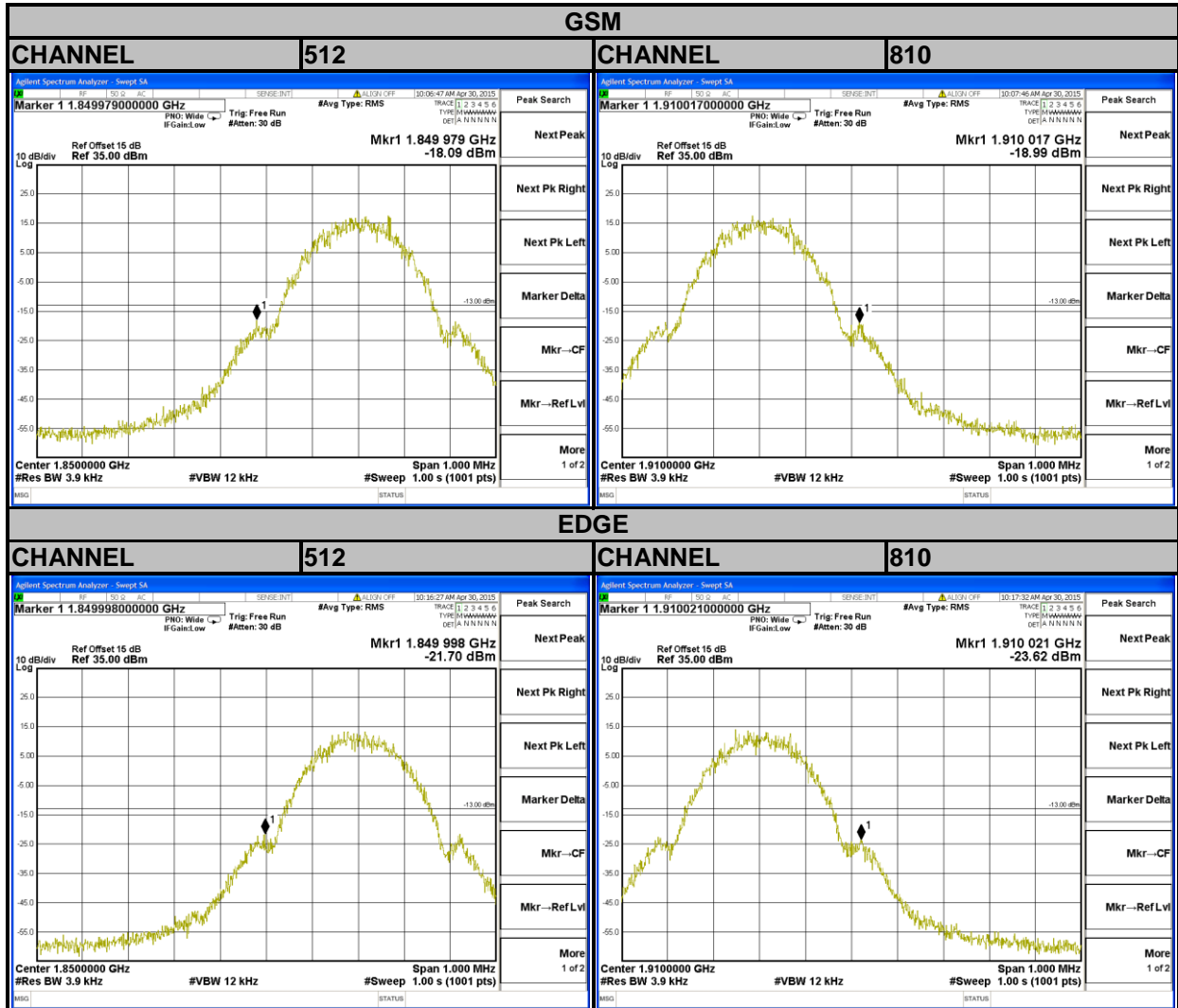



A D T

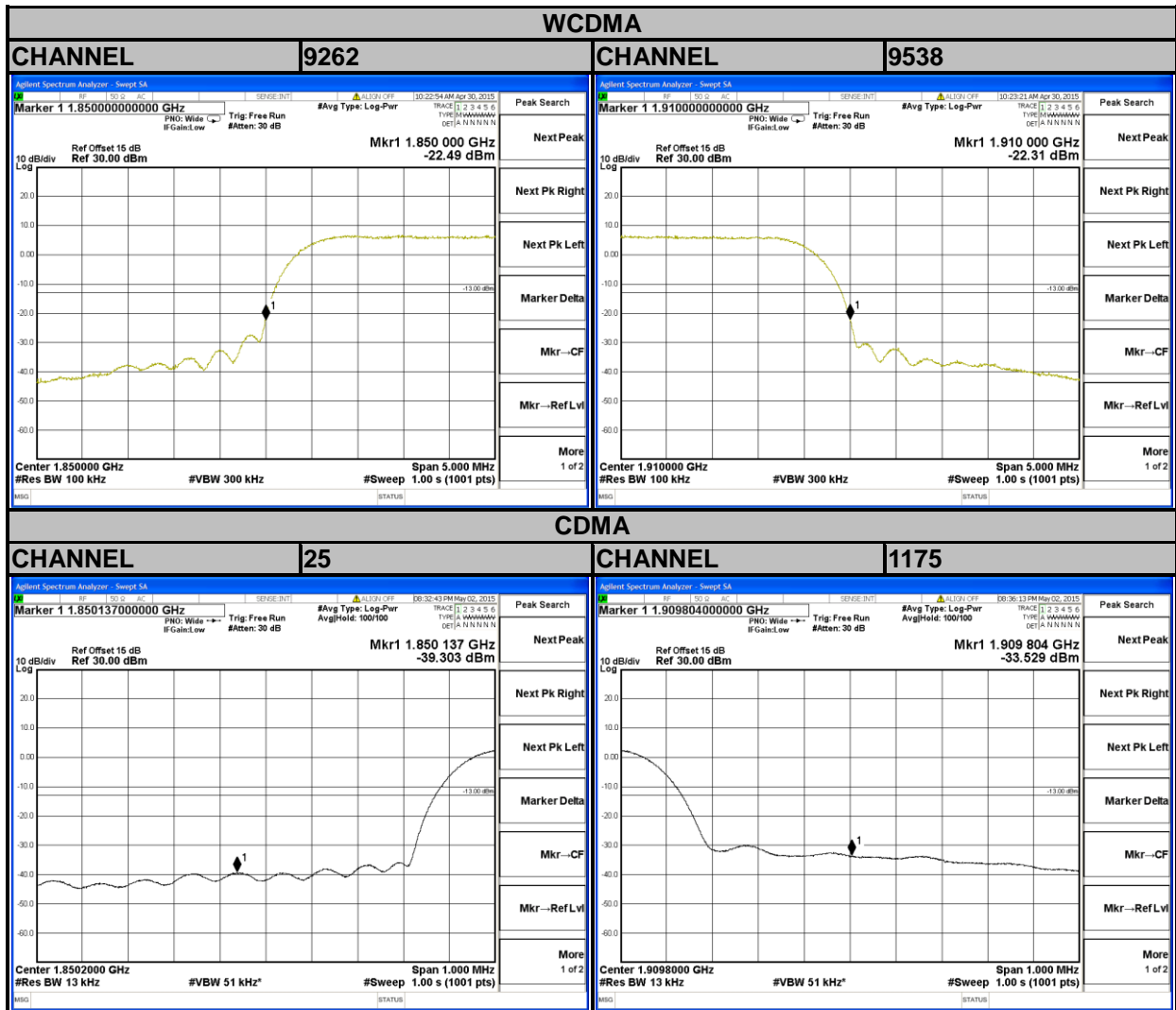



A D T

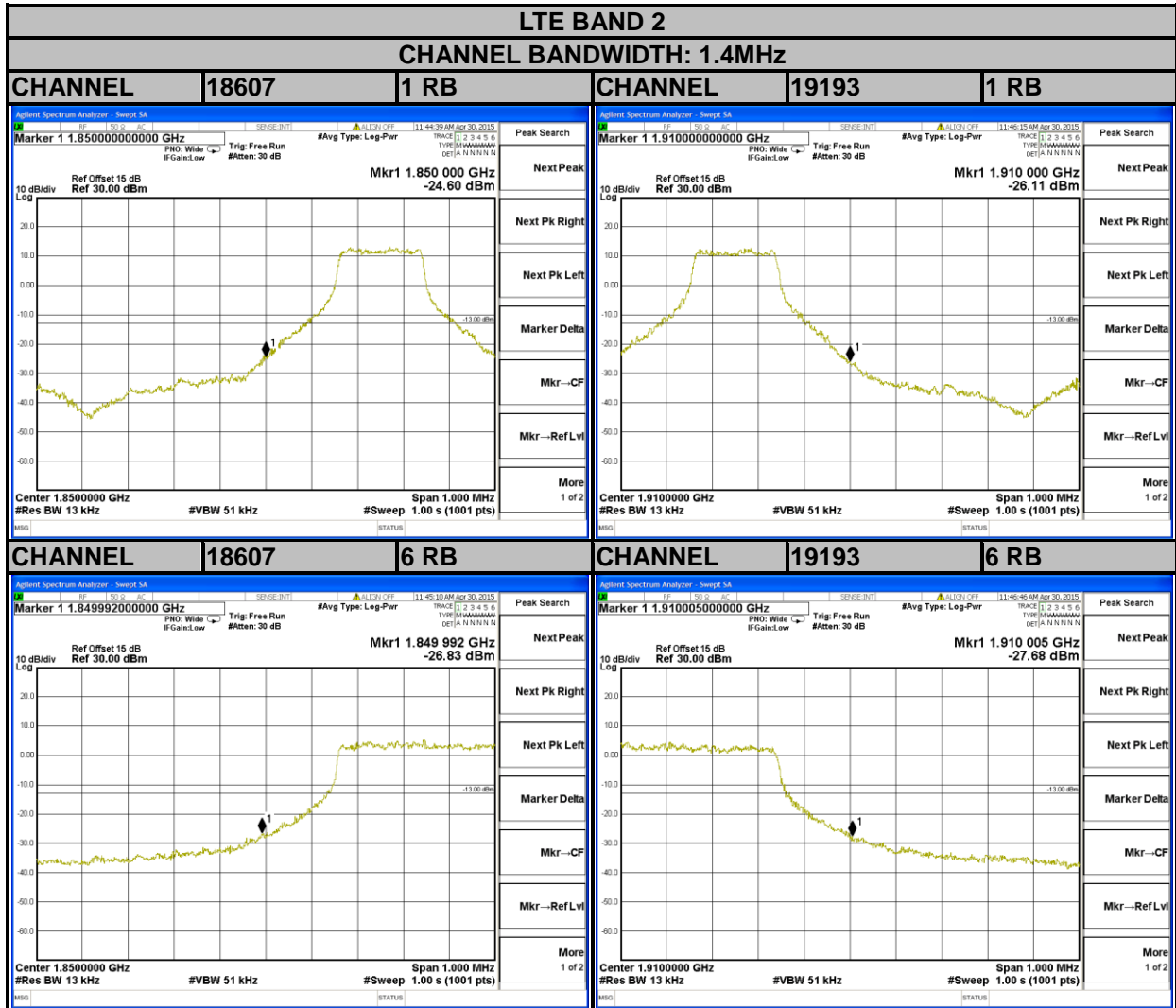



A D T

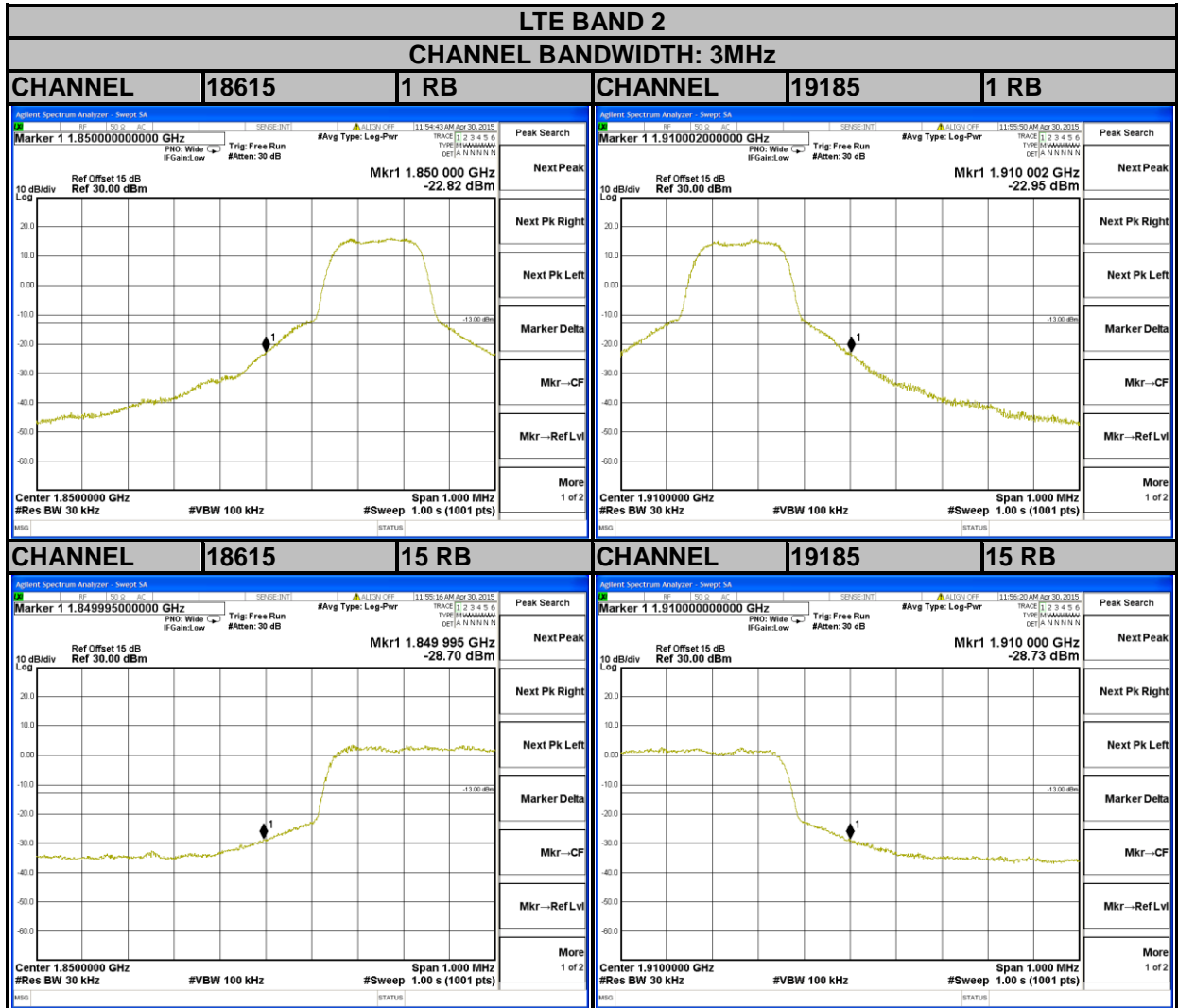

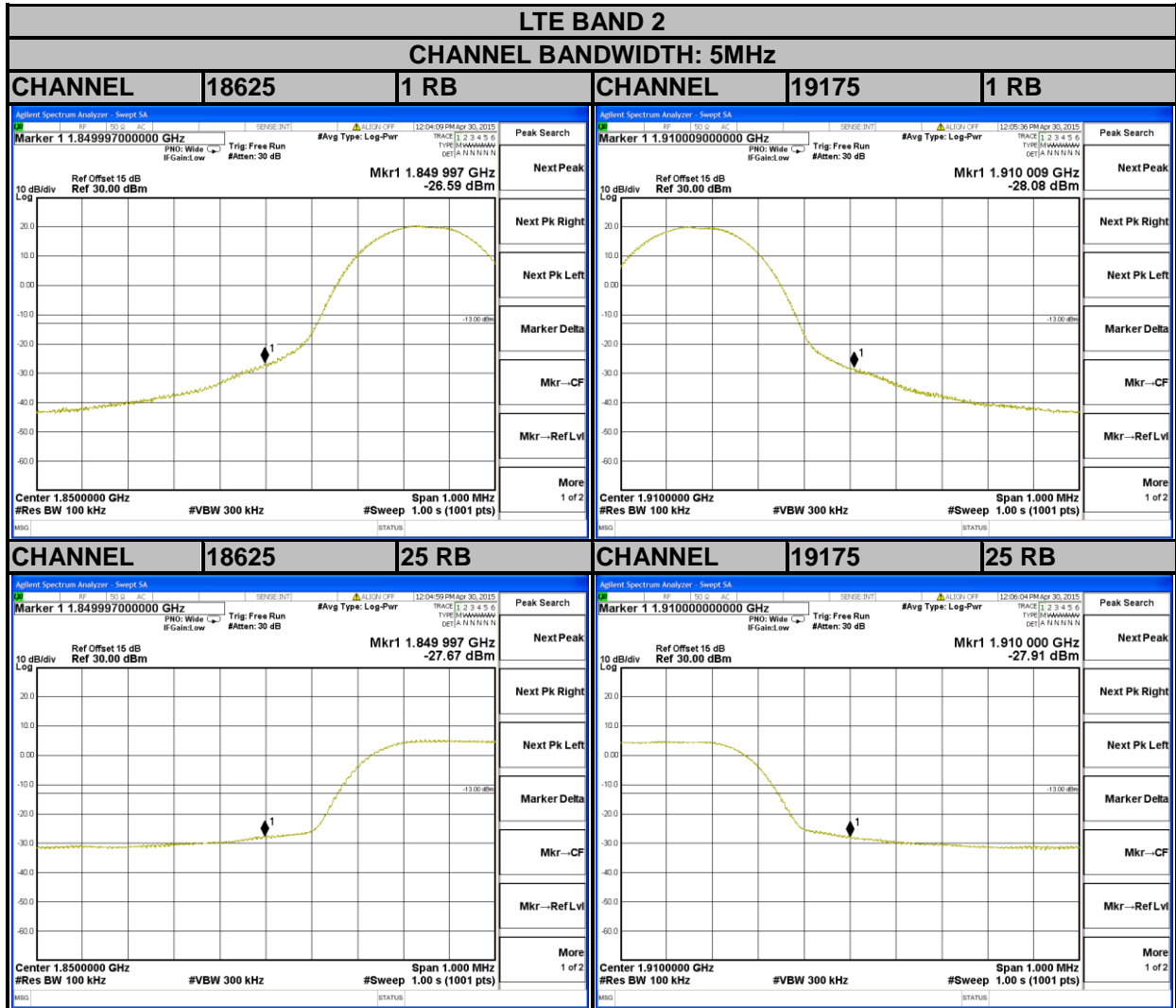



A D T

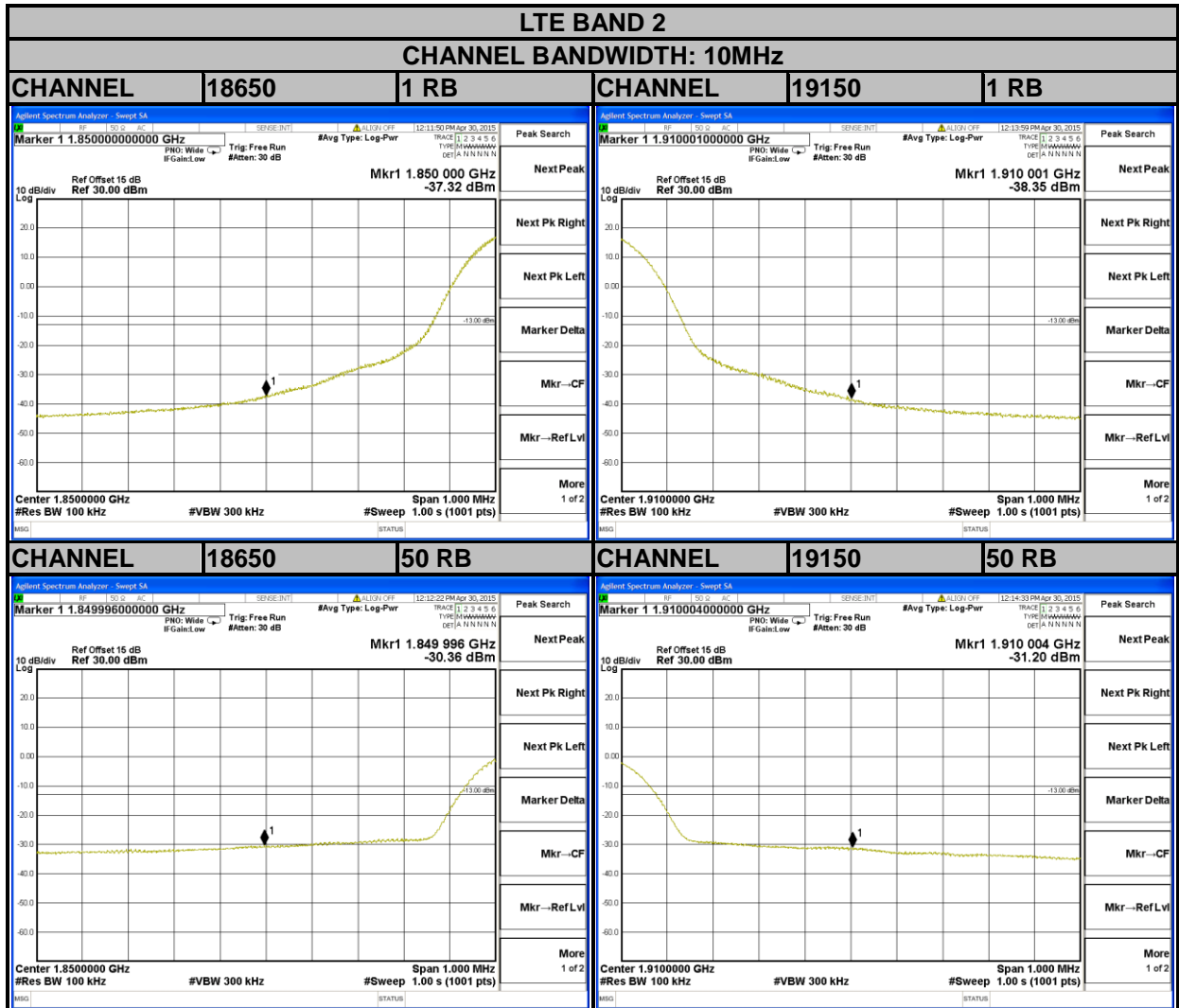



A D T

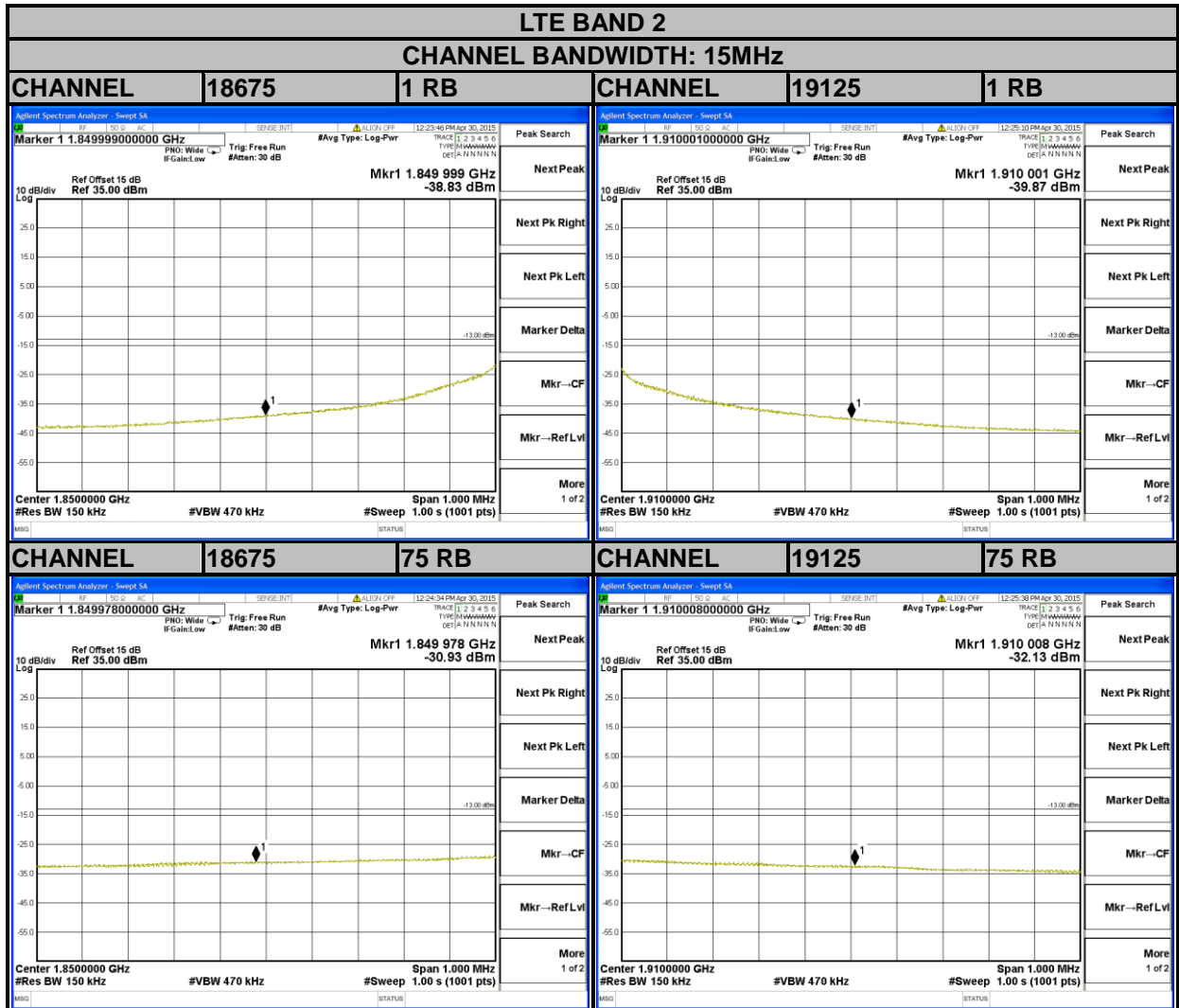



A D T

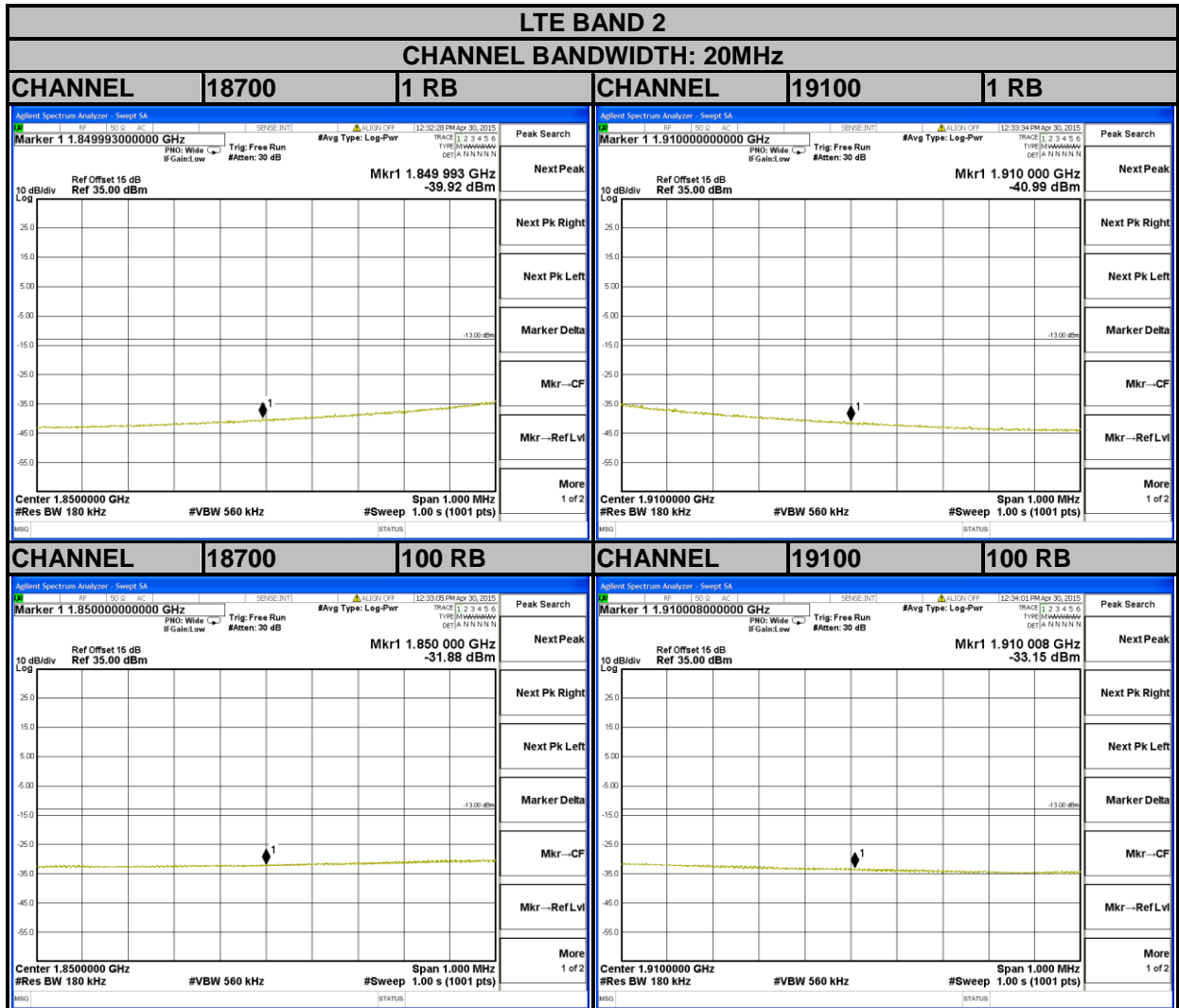

4.6 CONDUCTED SPURIOUS EMISSIONS

4.6.1 LIMITS OF CONDUCTED SPURIOUS EMISSIONS MEASUREMENT

The power of any emission outside of the authorized operating frequency ranges must be attenuated below the transmitting power (P) by a factor of at least $43 + 10 \log(P)$ dB. The emission limit is equal to -13dBm.

4.6.2 TEST PROCEDURE

- The EUT makes a phone call to the communication simulator. All measurements were done at low, middle and high operational frequency range.
- Measuring frequency range is from 30 MHz to 19.1GHz. 10dB attenuation pad is connected with spectrum. RBW=1MHz and VBW=3MHz is used for conducted emission measurement.

4.6.3 TEST SETUP

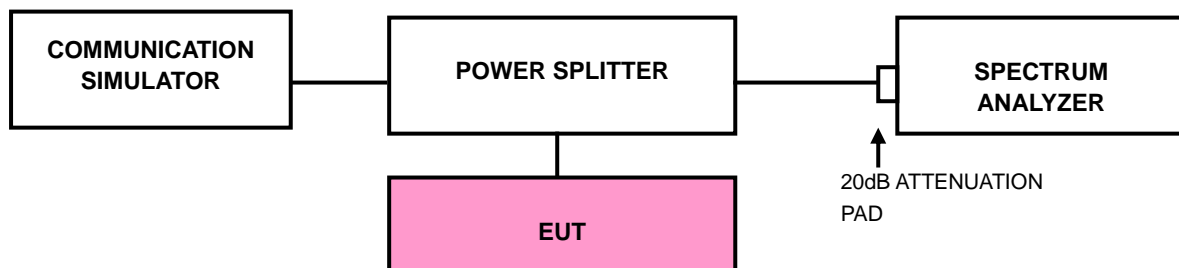



A D T

4.6.4 TEST RESULTS

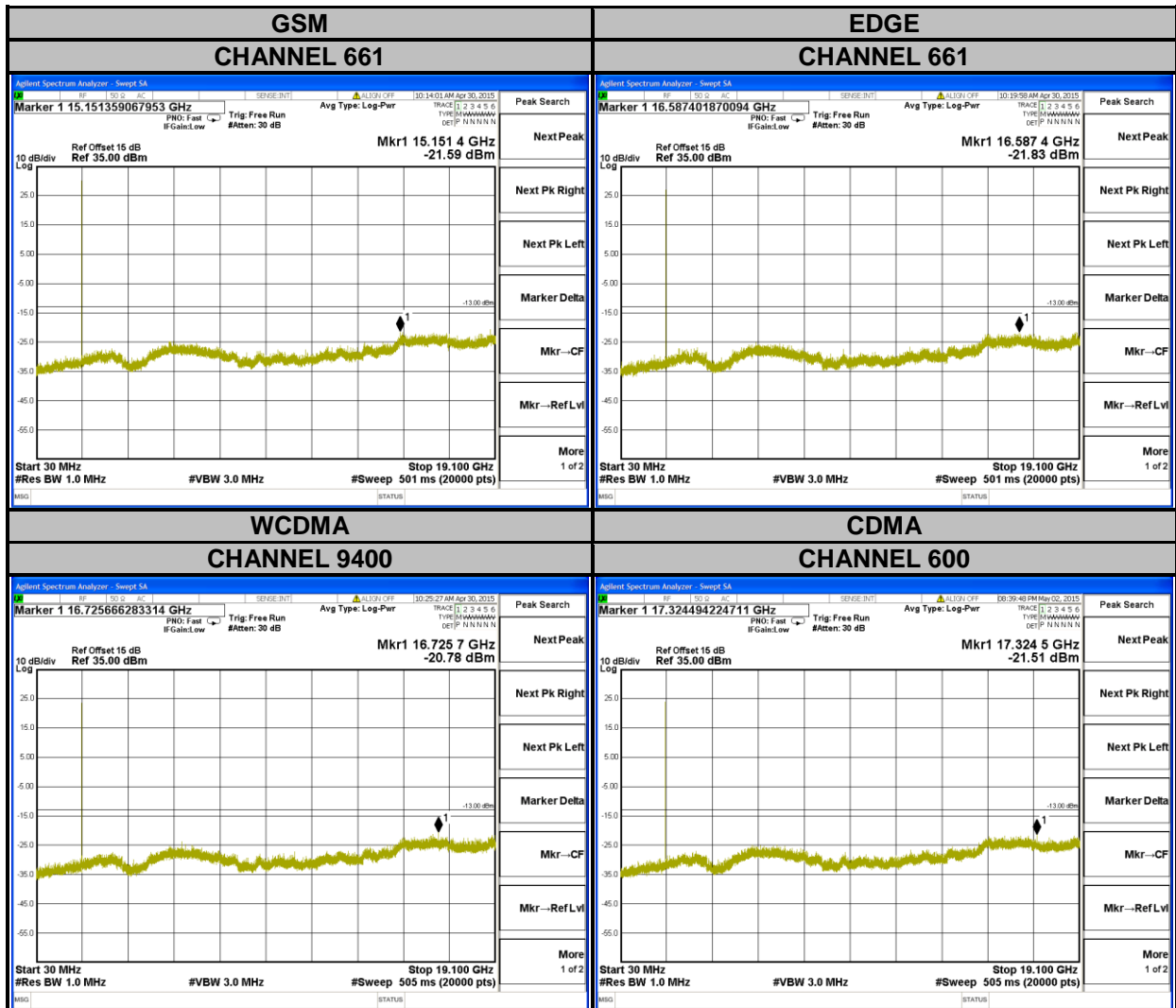



A D T

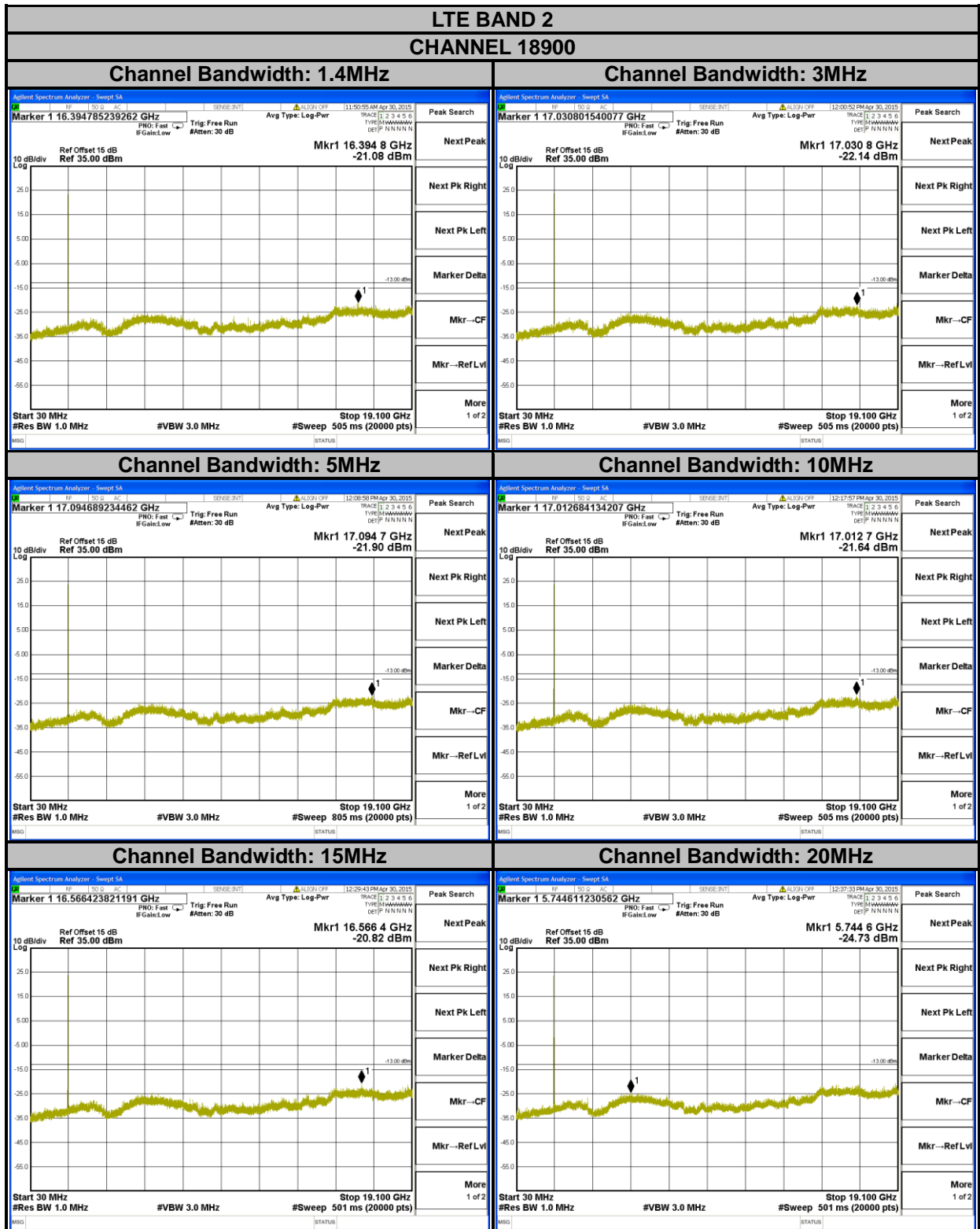

4.7 RADIATED EMISSION MEASUREMENT

4.7.1 LIMITS OF RADIATED EMISSION MEASUREMENT

The power of any emission outside of the authorized operating frequency ranges must be attenuated below the transmitting power (P) by a factor of at least $43 + 10 \log(P)$ dB. The emission limit is equal to -13dBm.

4.7.2 TEST PROCEDURES

- a. Substitution method is used for E.I.R.P measurement. In the semi-anechoic chamber, EUT placed on the 0.8m height of Turn Table, rotated the table around 360 degrees to search the maximum radiation power and receiver antenna shall be rotated vertical and horizontal polarization and moved height from 1m to 4m to find the maximum polar radiated power. The “Read Value” is the spectrum reading the maximum power value.
- b. The substitution horn antenna is substituted for EUT at the same position and signals generator export the CW signal to the substitution antenna via a TX cable. Rotated the Turn Table and moved receiving antenna to find the maximum radiation power. Adjust output power level of S.G to get a Value of spectrum reading equal to “Read Value” of step a. Record the power level of S.G
- c. $EIRP = \text{Output power level of S.G} - \text{TX cable loss} + \text{Antenna gain of substitution horn}$.
- d. E.R.P power can be calculated form E.I.R.P power by subtracting the gain of dipole, $E.R.P \text{ power} = E.I.R.P \text{ power} - 2.15\text{dBi}$.

NOTE: The resolution bandwidth and video bandwidth of test receiver/spectrum analyzer is 1MHz/3MHz.

4.7.3 DEVIATION FROM TEST STANDARD

No deviation

4.7.4 TEST SETUP

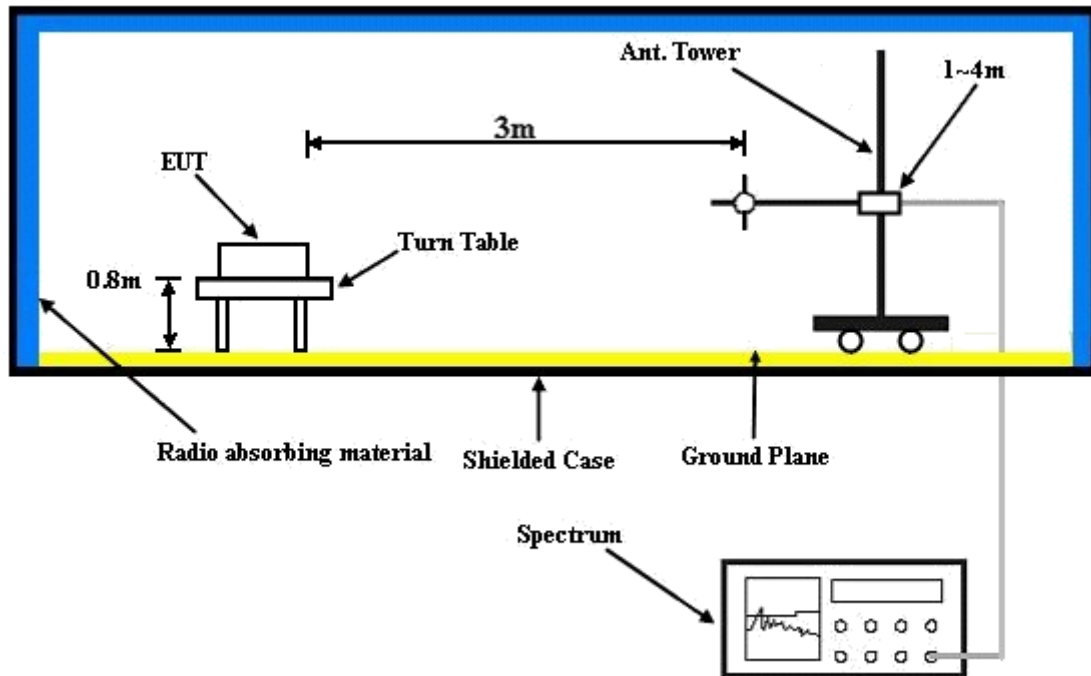

For the actual test configuration, please refer to the attached file (Test Setup Photo).



A D T

4.7.5 TEST RESULTS

GSM:



Bureau Veritas Consumer Products Services Ltd., Taoyuan Branch

A D T

Data: 13

Date: 2015-05-08

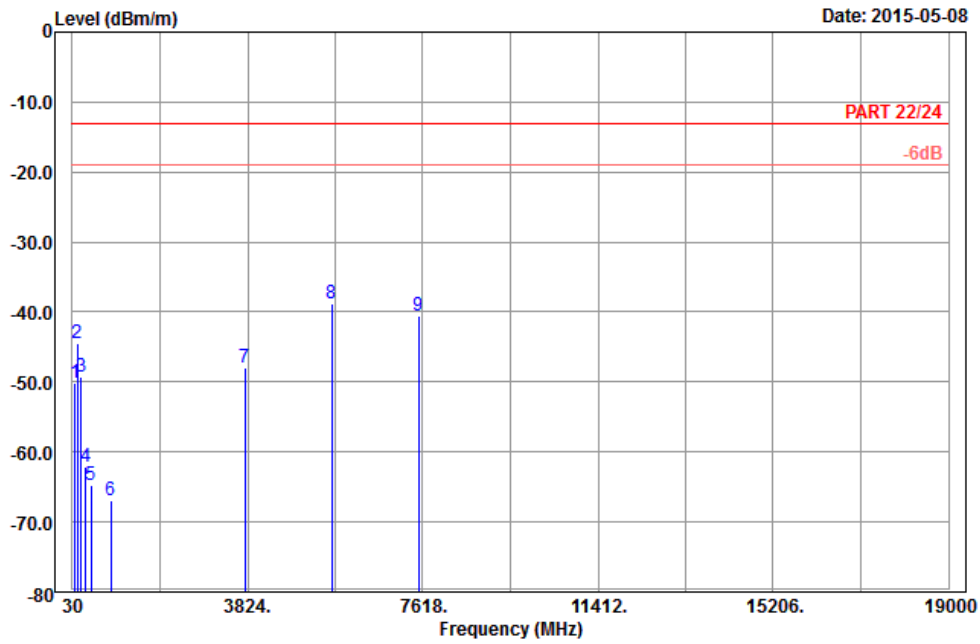

Site : 966 chamber 1
 Condition: PART 22/24 3m Horizontal
 Remark : PCS 1900_Link_CH661
 Tested by: Charles Hsiao
 Plane : Z

	Freq	Level	Read Level	Limit Line	Over Limit	Factor	Remark
	MHz	dBm/m	dBm	dBm/m	dB	dB/m	
1	95.88	-50.17	-39.83	-13.00	-37.17	-10.34	Peak
2	143.13	-44.39	-36.60	-13.00	-31.39	-7.79	Peak
3	213.87	-49.26	-43.27	-13.00	-36.26	-5.99	Peak
4	316.10	-62.15	-56.38	-13.00	-49.15	-5.77	Peak
5	431.60	-64.72	-61.28	-13.00	-51.72	-3.44	Peak
6	855.80	-66.86	-68.47	-13.00	-53.86	1.61	Peak
7	3760.00	-47.90	-64.04	-13.00	-34.90	16.14	Peak
8 pp	5640.00	-38.71	-59.18	-13.00	-25.71	20.47	Peak
9	7520.00	-40.50	-63.18	-13.00	-27.50	22.68	Peak



A D T



Bureau Veritas Consumer Products Services Ltd., Taoyuan Branch

A D T

Data: 14

Date: 2015-05-08

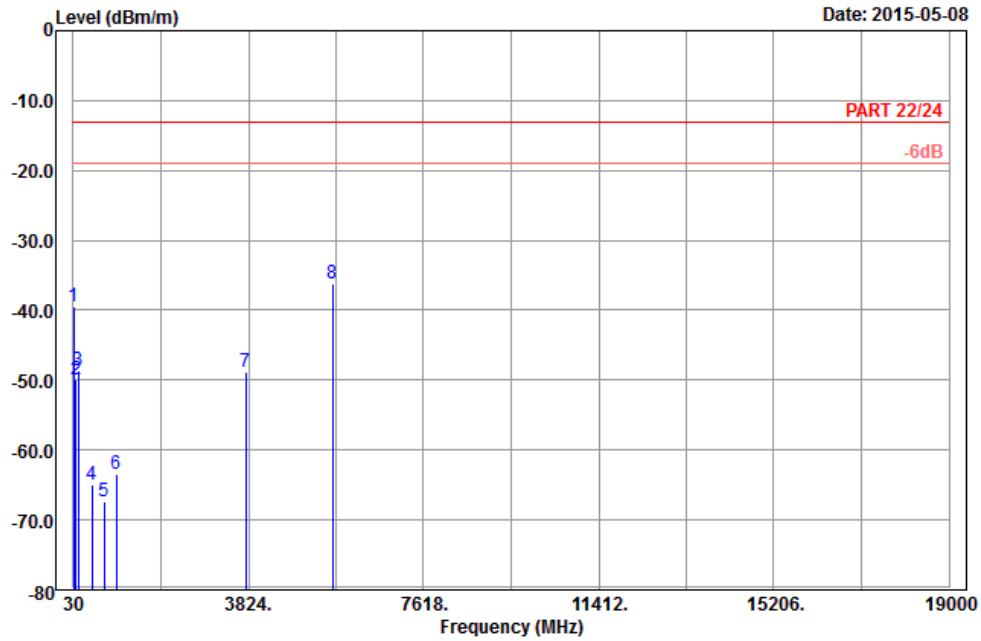

Site : 966 chamber 1
 Condition: PART 22/24 3m Vertical
 Remark : PCS 1900_Link_CH661
 Tested by: Charles Hsiao
 Plane : Z

	Freq	Level	Read Level	Limit	Over		Remark
	MHz	dBm/m	dBm	dBm/m	dB	dB/m	
1	31.62	-39.55	-28.79	-13.00	-26.55	-10.76	Peak
2	80.49	-49.86	-38.09	-13.00	-36.86	-11.77	Peak
3	144.21	-48.65	-40.84	-13.00	-35.65	-7.81	Peak
4	429.50	-64.96	-61.56	-13.00	-51.96	-3.40	Peak
5	691.30	-67.37	-67.03	-13.00	-54.37	-0.34	Peak
6	966.40	-63.42	-68.58	-13.00	-50.42	5.16	Peak
7	3760.00	-48.83	-64.97	-13.00	-35.83	16.14	Peak
8 pp	5640.00	-36.28	-56.75	-13.00	-23.28	20.47	Peak

EDGE:

Bureau Veritas Consumer Products Services Ltd., Taoyuan Branch

A D T

Data: 9

Date: 2015-05-08

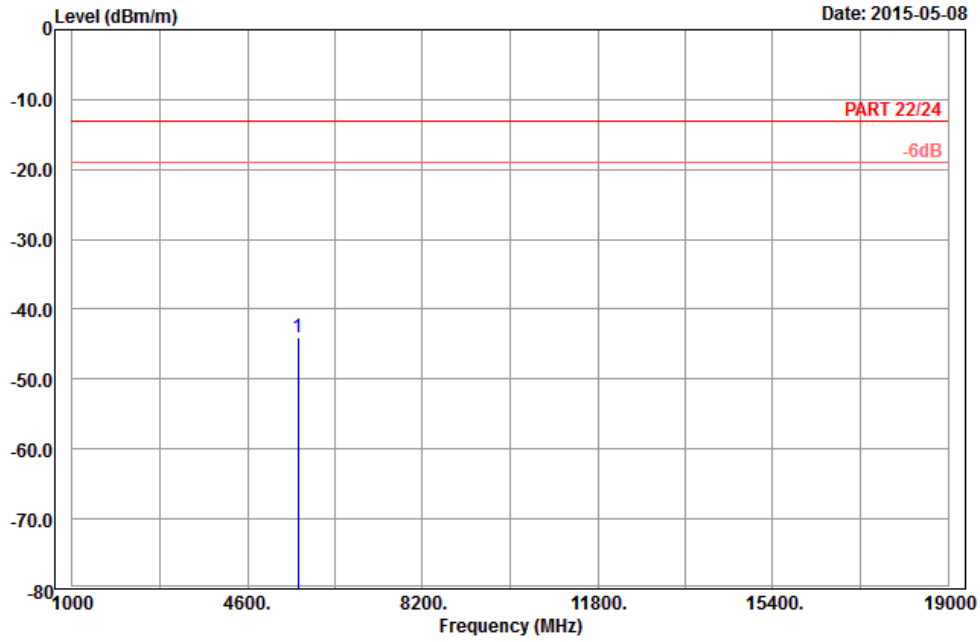

Site : 966 chamber 1
 Condition: PART 22/24 3m Horizontal
 Remark : EDGE 1900_Link_CH661
 Tested by: Will Chen
 Plane : Z

	Freq	Level	Read Level	Limit Line	Over Limit	Factor	Remark
	MHz	dBm/m	dBm	dBm/m	dB	dB/m	
1 pp	5640.00	-43.94	-64.41	-13.00	-30.94	20.47	Peak



A D T



Bureau Veritas Consumer Products Services Ltd., Taoyuan Branch

A D T

Data: 10

Date: 2015-05-08

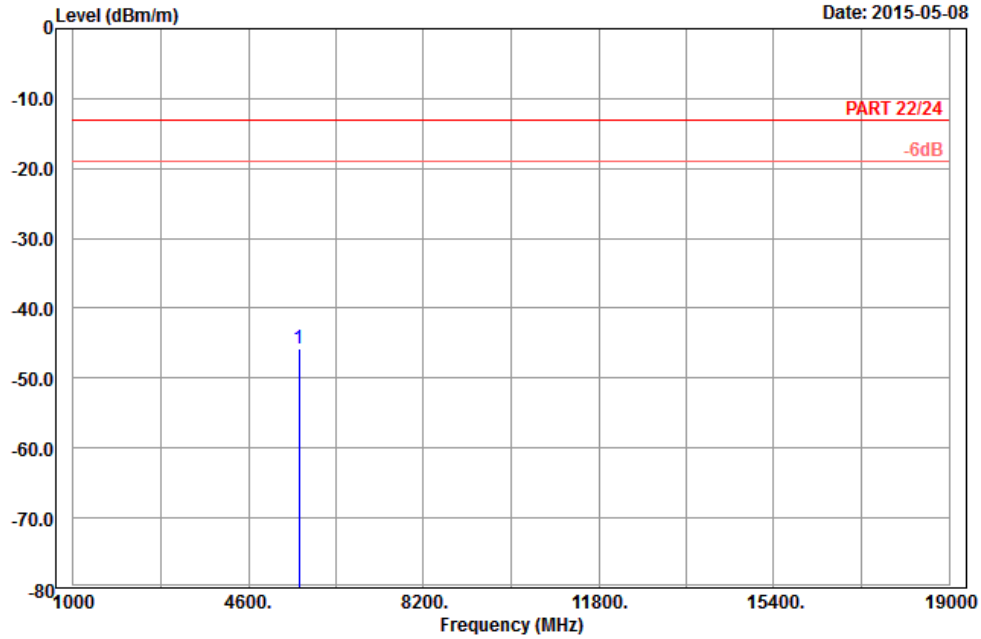

Site : 966 chamber 1
 Condition: PART 22/24 3m Vertical
 Remark : EDGE 1900_Link_CH661
 Tested by: Will Chen
 Plane : Z

Freq	Level	Read Level	Limit Line	Over Limit	Factor	Remark
MHz	dBm/m	dBm	dBm/m	dB	dB/m	
1 pp 5640.00	-45.76	-66.23	-13.00	-32.76	20.47	Peak

WCDMA:



Bureau Veritas Consumer Products Services Ltd., Taoyuan Branch

A D T

Data: 9

Date: 2015-05-08

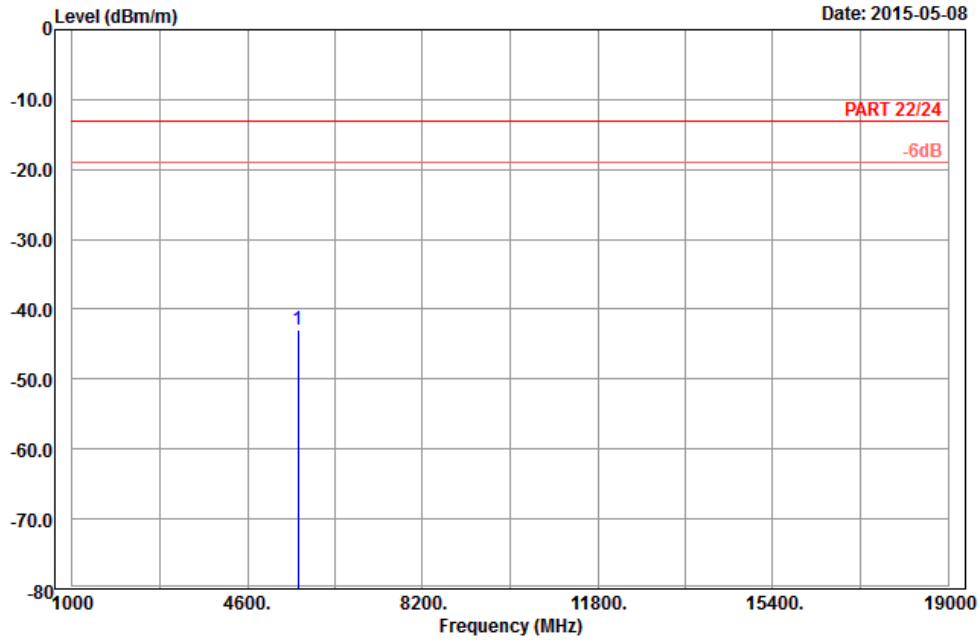

Site : 966 chamber 1
 Condition: PART 22/24 3m Horizontal
 Remark : Band II_Link_CH9400
 Tested by: Will Chen
 Plane : Z

	Freq	Level	Read Level	Limit Line	Over Limit	Factor	Remark
	MHz	dBm/m	dBm	dBm/m	dB	dB/m	
1 pp	5640.00	-42.92	-63.39	-13.00	-29.92	20.47	Peak



A D T



Bureau Veritas Consumer Products Services Ltd., Taoyuan Branch

A D T

Data: 10

Date: 2015-05-08

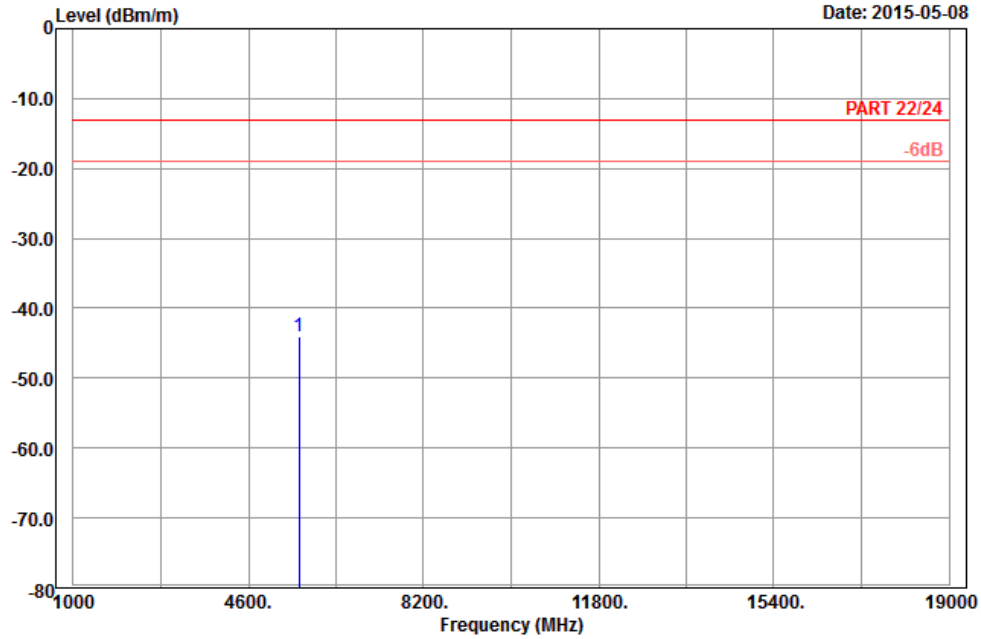

Site : 966 chamber 1
 Condition: PART 22/24 3m Vertical
 Remark : Band II_Link_CH9400
 Tested by: Will Chen
 Plane : Z

Freq	Level	Read Level	Limit Line	Over Limit	Factor	Remark
MHz	dBm/m	dBm	dBm/m	dB	dB/m	
1 pp 5640.00	-44.11	-64.58	-13.00	-31.11	20.47	Peak



A D T

CDMA:



Bureau Veritas Consumer Products Services Ltd., Taoyuan Branch

A D T

Data: 13

Date: 2015-05-08

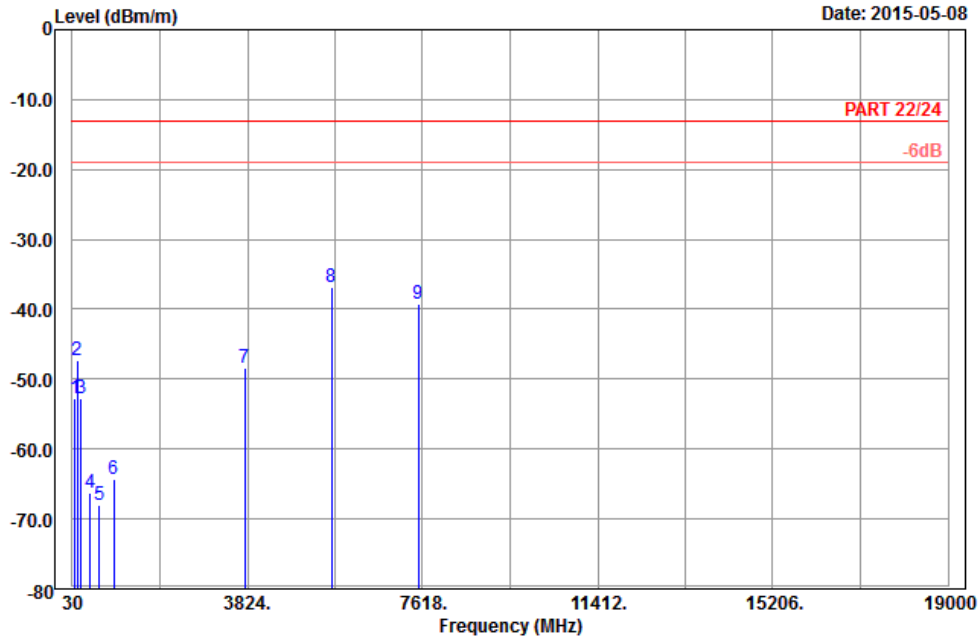

Site : 966 chamber 1
 Condition: PART 22/24 3m Horizontal
 Remark : BC1_Link_CH600
 Tested by: Charles Hsiao
 Plane : Z

	Freq	Level	Read Level	Limit Line	Over Limit	Factor	Remark
	MHz	dBm/m	dBm	dBm/m	dB	dB/m	
1	95.61	-52.67	-42.33	-13.00	-39.67	-10.34	Peak
2	137.73	-47.21	-39.53	-13.00	-34.21	-7.68	Peak
3	220.35	-52.81	-46.90	-13.00	-39.81	-5.91	Peak
4	419.70	-66.29	-63.10	-13.00	-53.29	-3.19	Peak
5	615.00	-67.91	-68.17	-13.00	-54.91	0.26	Peak
6	926.50	-64.33	-68.39	-13.00	-51.33	4.06	Peak
7	3760.00	-48.45	-64.59	-13.00	-35.45	16.14	Peak
8 pp	5640.00	-36.75	-57.22	-13.00	-23.75	20.47	Peak
9	7520.00	-39.30	-61.98	-13.00	-26.30	22.68	Peak



A D T



Bureau Veritas Consumer Products Services Ltd., Taoyuan Branch

A D T

Data: 14

Date: 2015-05-08

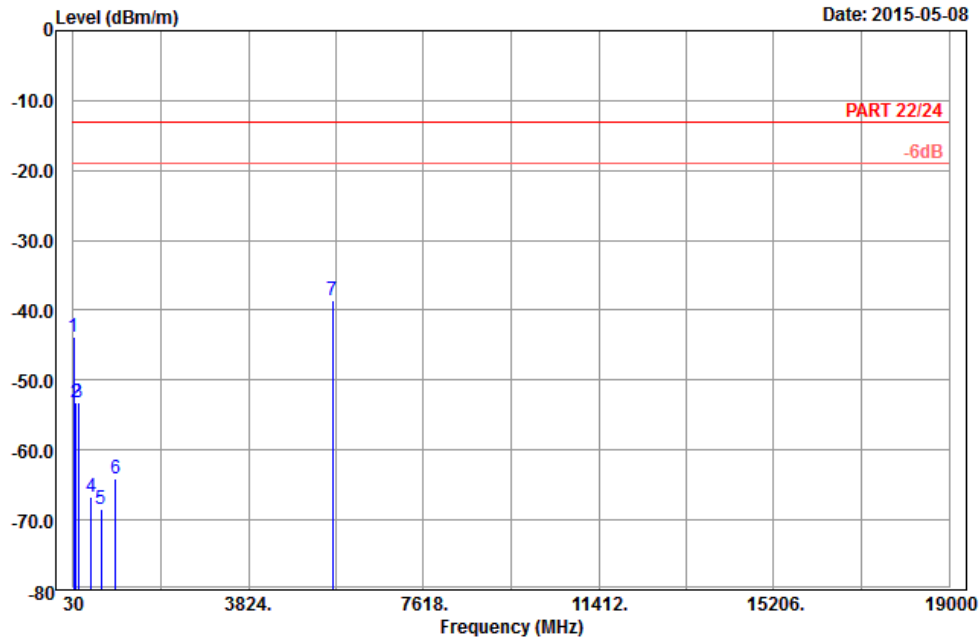

Site : 966 chamber 1
 Condition: PART 22/24 3m Vertical
 Remark : BC1_Link_CH600
 Tested by: Charles Hsiao
 Plane : Z

	Freq	Level	Read Level	Limit Line	Over Limit	Factor	Remark
	MHz	dBm/m	dBm	dBm/m	dB	dB/m	
1	31.89	-43.80	-33.04	-13.00	-30.80	-10.76	Peak
2	81.30	-53.26	-41.60	-13.00	-40.26	-11.66	Peak
3	143.13	-53.21	-45.42	-13.00	-40.21	-7.79	Peak
4	423.20	-66.61	-63.36	-13.00	-53.61	-3.25	Peak
5	628.30	-68.38	-68.49	-13.00	-55.38	0.11	Peak
6	951.70	-63.99	-69.10	-13.00	-50.99	5.11	Peak
7 pp	5640.00	-38.62	-59.09	-13.00	-25.62	20.47	Peak



A D T

LTE BAND 2
CHANNEL BANDWIDTH: 20MHz / QPSK



Bureau Veritas Consumer Products Services Ltd., Taoyuan Branch

A D T

Data: 13

Date: 2015-05-08

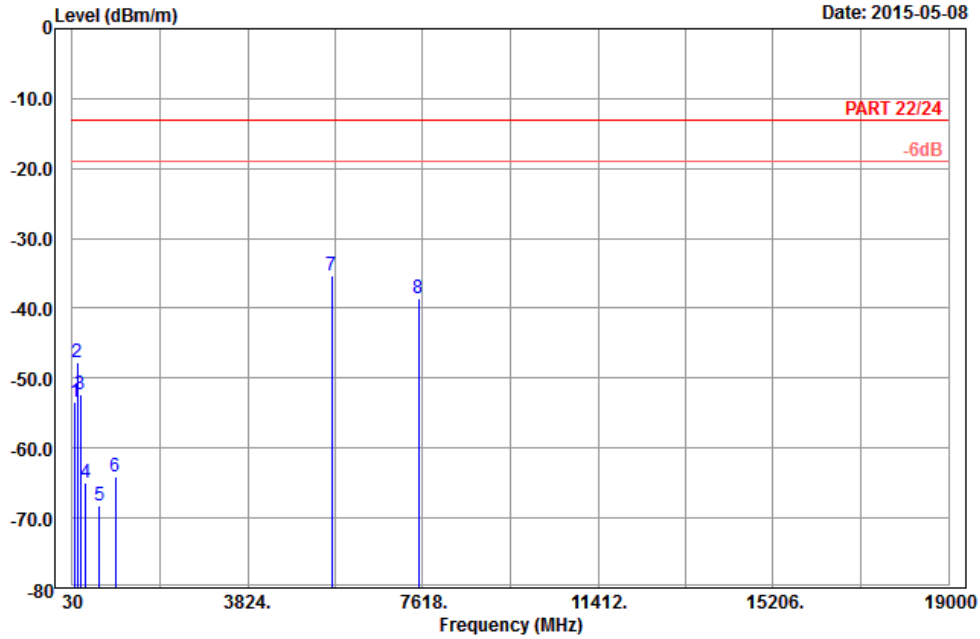

Site : 966 chamber 1
 Condition: PART 22/24 3m Horizontal
 Remark : LTE_Band 2_QPSK(1,0)_20M_CH18900
 Tested by: Charles Hsiao
 Plane : Z

	Freq	Level	Read Level	Limit	Over	Factor	Remark
	MHz	dBm/m	dBm	dBm/m	dB	dB/m	
1	94.26	-53.49	-43.04	-13.00	-40.49	-10.45	Peak
2	137.19	-47.65	-39.97	-13.00	-34.65	-7.68	Peak
3	203.07	-52.24	-46.10	-13.00	-39.24	-6.14	Peak
4	323.10	-64.86	-59.17	-13.00	-51.86	-5.69	Peak
5	623.40	-68.29	-68.45	-13.00	-55.29	0.16	Peak
6	966.40	-64.09	-69.25	-13.00	-51.09	5.16	Peak
7 pp	5640.00	-35.39	-55.86	-13.00	-22.39	20.47	Peak
8	7520.00	-38.57	-61.25	-13.00	-25.57	22.68	Peak



A D T



Bureau Veritas Consumer Products Services Ltd., Taoyuan Branch

A D T

Data: 14

Date: 2015-05-08

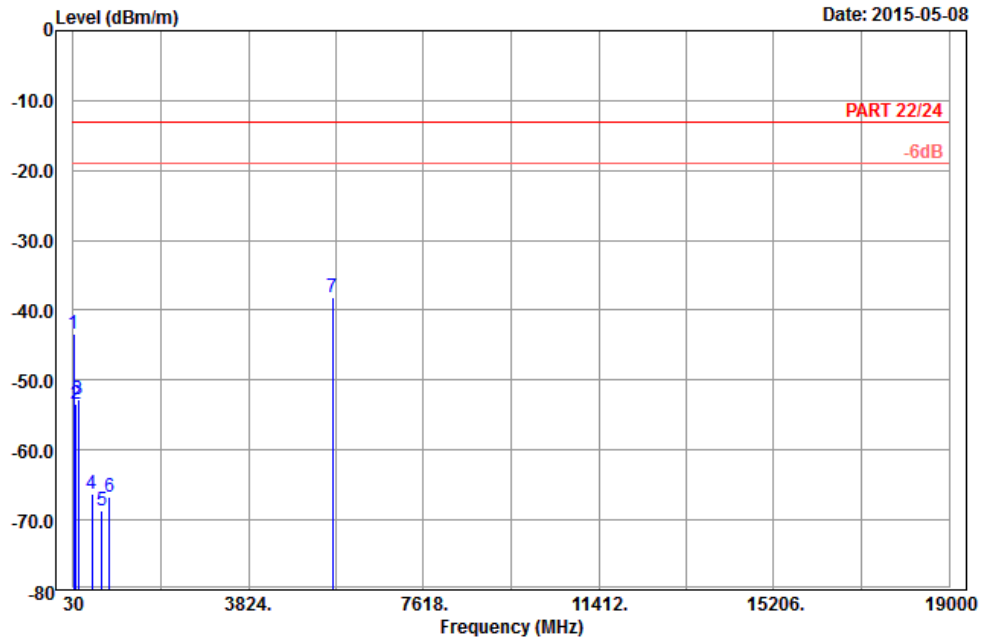

Site : 966 chamber 1
 Condition: PART 22/24 3m Vertical
 Remark : LTE_Band 2_QPSK(1,0)_20M_CH18900
 Tested by: Charles Hsiao
 Plane : Z

	Freq	Level	Read Level	Limit	Over	Factor	Remark
	MHz	dBm/m	dBm	dBm/m	dB	dB/m	
1	31.62	-43.35	-32.59	-13.00	-30.35	-10.76	Peak
2	81.84	-53.35	-41.69	-13.00	-40.35	-11.66	Peak
3	140.43	-52.84	-45.12	-13.00	-39.84	-7.72	Peak
4	433.00	-66.23	-62.77	-13.00	-53.23	-3.46	Peak
5	654.90	-68.68	-68.52	-13.00	-55.68	-0.16	Peak
6	806.80	-66.77	-68.70	-13.00	-53.77	1.93	Peak
7 pp	5640.00	-38.11	-58.58	-13.00	-25.11	20.47	Peak

5 PHOTOGRAPHS OF THE TEST CONFIGURATION

Please refer to the attached file (Test Setup Photo).



6 INFORMATION ON THE TESTING LABORATORIES

We, Bureau Veritas Consumer Products Services (H.K.) Ltd., Taoyuan Branch, were founded in 1988 to provide our best service in EMC, Radio, Telecom and Safety consultation. Our laboratories are accredited and approved according to ISO/IEC 17025.

If you have any comments, please feel free to contact us at the following:

Linko EMC/RF Lab:

Tel: 886-2-26052180

Fax: 886-2-26051924

Hsin Chu EMC/RF/Telecom Lab:

Tel: 886-3-5935343

Fax: 886-3-5935342

Hwa Ya EMC/RF/Safety Lab:

Tel: 886-3-3183232

Fax: 886-3-3270892

Email: service.adt@tw.bureauveritas.com

Web Site: www.bureauveritas-adt.com

The address and road map of all our labs can be found in our web site also.



A D T

7 APPENDIX A – MODIFICATIONS RECORDERS FOR ENGINEERING CHANGES TO THE EUT BY THE LAB

No any modifications were made to the EUT by the lab during the test.

---END---