



FCC TEST REPORT (PART 27)

REPORT NO.: RF150324C20-3
MODEL NAME: 0PM9300
FCC ID: NM80PM9300
RECEIVED: Mar. 24, 2015
TESTED: May 01, 2015 ~ May 08, 2015
ISSUED: May 25, 2015

APPLICANT: HTC Corporation

ADDRESS: 1F, 6-3 Baoqiang Road, Xindian District, New Taipei City, Taiwan 231

ISSUED BY: Bureau Veritas Consumer Products Services (H.K.) Ltd., Taoyuan Branch

LAB ADDRESS: No. 47-2, 14th Ling, Chia Pau Vil., Lin Kou Dist., New Taipei City, Taiwan, R.O.C.

TEST LOCATION: No. 19, Hwa Ya 2nd Rd, Wen Hwa Vil., Kwei Shan Dist., Taoyuan City 333, Taiwan, R.O.C.

This report should not be used by the client to claim product certification, approval, or endorsement by TAF or any government agencies.



This report is for your exclusive use. Any copying or replication of this report to or for any other person or entity, or use of our name or trademark, is permitted only with our prior written permission. This report sets forth our findings solely with respect to the test samples identified herein. The results set forth in this report are not indicative or representative of the quality or characteristics of the lot from which a test sample was taken or any similar or identical product unless specifically and expressly noted. Our report includes all of the tests requested by you and the results thereof based upon the information that you provided to us. You have 60 days from date of issuance of this report to notify us of any material error or omission caused by our negligence, provided, however, that such notice shall be in writing and shall specifically address the issue you wish to raise. A failure to raise such issue within the prescribed time shall constitute your unqualified acceptance of the completeness of this report, the tests conducted and the correctness of the report contents. Unless specific mention, the uncertainty of measurement has been explicitly taken into account to declare the compliance or non-compliance to the specification

TABLE OF CONTENTS

RELEASE CONTROL RECORD.....	3
1 CERTIFICATION	4
2 SUMMARY OF TEST RESULTS.....	5
2.1 MEASUREMENT UNCERTAINTY	5
2.2 TEST SITE AND INSTRUMENTS	6
3 GENERAL INFORMATION	7
3.1 GENERAL DESCRIPTION OF EUT.....	7
3.2 CONFIGURATION OF SYSTEM UNDER TEST	8
3.3 DESCRIPTION OF SUPPORT UNITS.....	8
3.4 DESCRIPTION OF TEST MODES.....	9
3.5 GENERAL DESCRIPTION OF APPLIED STANDARDS	10
4 TEST TYPES AND RESULTS.....	11
4.1 OUTPUT POWER MEASUREMENT	11
4.1.1 LIMITS OF OUTPUT POWER MEASUREMENT	11
4.1.2 TEST PROCEDURES	11
4.1.3 TEST SETUP	12
4.1.4 TEST RESULTS	13
4.2 FREQUENCY STABILITY MEASUREMENT	17
4.2.1 LIMITS OF FREQUENCY STABILITY MEASUREMENT	17
4.2.2 TEST PROCEDURE	17
4.2.3 TEST SETUP	17
4.2.4 TEST RESULTS	18
4.3 OCCUPIED BANDWIDTH MEASUREMENT.....	19
4.3.1 LIMITS OF OCCUPIED BANDWIDTH MEASUREMENT.....	19
4.3.2 TEST SETUP	19
4.3.3 TEST PROCEDURES	19
4.3.4 TEST RESULTS	20
4.4 PEAK TO AVERAGE RATIO.....	22
4.4.1 LIMITS OF PEAK TO AVERAGE RATIO MEASUREMENT	22
4.4.2 TEST SETUP	22
4.4.3 TEST PROCEDURES.....	22
4.4.4 TEST RESULTS	23
4.5 BAND EDGE MEASUREMENT	25
4.5.1 LIMITS OF BAND EDGE MEASUREMENT	25
4.5.2 TEST SETUP	25
4.5.3 TEST PROCEDURES.....	26
4.5.4 TEST RESULTS	27
4.6 CONDUCTED SPURIOUS EMISSIONS.....	35
4.6.1 LIMITS OF CONDUCTED SPURIOUS EMISSIONS MEASUREMENT.....	35
4.6.2 TEST PROCEDURE	35
4.6.3 TEST SETUP	35
4.6.4 TEST RESULTS	36
4.7 RADIATED EMISSION MEASUREMENT	38
4.7.1 LIMITS OF RADIATED EMISSION MEASUREMENT	38
4.7.2 TEST PROCEDURES.....	38
4.7.3 DEVIATION FROM TEST STANDARD.....	38
4.7.4 TEST SETUP	39
4.7.5 TEST RESULTS	40
5 INFORMATION ON THE TESTING LABORATORIES	42
6 APPENDIX A – MODIFICATIONS RECORDERS FOR ENGINEERING CHANGES TO THE EUT BY THE LAB.....	43



A D T

RELEASE CONTROL RECORD

ISSUE NO.	REASON FOR CHANGE	DATE ISSUED
RF150324C20-3	Original release	May 25, 2015

1 CERTIFICATION

PRODUCT: Smartphone
MODEL: OPM9300
BRAND: HTC
APPLICANT: HTC Corporation
TESTED: May 01, 2015 ~ May 08, 2015
TEST SAMPLE: Production Unit
TEST STANDARDS: **FCC Part 27, Subpart C, M**
FCC Part 2

The above equipment (model: OPM9300) has been tested by **Bureau Veritas Consumer Products Services (H.K.) Ltd., Taoyuan Branch**, and found compliance with the requirement of the above standards. The test record, data evaluation & Equipment Under Test (EUT) configurations represented herein are true and accurate accounts of the measurements of the sample's EMC characteristics under the conditions specified in this report.

PREPARED BY :  , **DATE:** May 25, 2015
Ivonne Wu / Supervisor

APPROVED BY :  , **DATE:** May 25, 2015
Sam Chen / Senior Project Engineer

2 SUMMARY OF TEST RESULTS

The EUT has been tested according to the following specifications:

STANDARD SECTION	TEST TYPE AND LIMIT	RESULT	REMARK
2.1046 27.50(h)	Equivalent Isotropic Radiated Power	PASS	Meet the requirement of limit.
2.1055 27.54	Frequency Stability	PASS	Meet the requirement of limit.
2.1049	Occupied Bandwidth	PASS	Meet the requirement of limit.
27.50(d)(5)	Peak to average ratio	PASS	Meet the requirement of limit.
2.1051 27.53(l)	Band Edge Measurements	PASS	Meet the requirement of limit.
2.1051 27.53(l)	Conducted Spurious Emissions	PASS	Meet the requirement of limit.
2.1053 27.53(l)	Radiated Spurious Emissions	PASS	Meet the requirement of limit. Minimum passing margin is -17.98dB at 31.35MHz.

2.1 MEASUREMENT UNCERTAINTY

Where relevant, the following measurement uncertainty levels have been estimated for tests performed on the EUT as specified in CISPR 16-4-2:

MEASUREMENT	FREQUENCY	UNCERTAINTY
Conducted emissions	9kHz~30MHz	2.44 dB
Radiated emissions	30MHz ~ 200MHz	2.93 dB
	200MHz ~1000MHz	2.95 dB
	1GHz ~ 18GHz	2.26 dB
	18GHz ~ 40GHz	1.94 dB

This uncertainty represents an expanded uncertainty expressed at approximately the 95% confidence level using a coverage factor of $k=2$.

2.2 TEST SITE AND INSTRUMENTS

DESCRIPTION & MANUFACTURER	MODEL NO.	SERIAL NO.	DATE OF CALIBRATION	DUE DATE OF CALIBRATION
Test Receiver Agilent	N9038A	MY51210203	Jan. 21, 2015	Jan. 21, 2016
Spectrum Analyzer Agilent	N9010A	MY52220314	Sep. 03, 2014	Sep. 02, 2015
Spectrum Analyzer ROHDE & SCHWARZ	FSU43	101261	Dec. 10, 2014	Dec. 09, 2015
BILOG Antenna SCHWARZBECK	VULB9168	9168-472	Feb. 04, 2015	Feb. 04, 2016
HORN Antenna SCHWARZBECK	BBHA 9120 D	9120D-969	Feb. 09, 2015	Feb. 09, 2016
HORN Antenna SCHWARZBECK	BBHA 9170	9170-480	Feb. 04, 2015	Feb. 04, 2016
Preamplifier EMCI	EMC 012645	980115	Dec. 12, 2014	Dec. 11, 2015
Preamplifier EMCI	EMC 184045	980116	Jan. 09, 2015	Jan. 08, 2016
Preamplifier EMCI	EMC 330H	980112	Dec. 27, 2014	Dec. 26, 2015
Power Meter Anritsu	ML2495A	1232002	Sep. 17, 2014	Sep. 16, 2015
Power Sensor Anritsu	MA2411B	1207325	Sep. 17, 2014	Sep. 16, 2015
RF signal cable HUBER+SUHNNER	SUCOFLEX 104	309219/4 2950114	Oct. 18, 2014	Oct. 17, 2015
RF signal cable HUBER+SUHNNER	SUCOFLEX 104	250130/4	Oct. 18, 2014	Oct. 17, 2015
RF Coaxial Cable Worken	8D-FB	Cable-Ch10-01	Nov. 07, 2014	Nov. 06, 2015
Software BV ADT	E3 6.120103	NA	NA	NA
Antenna Tower MF	MFA-440H	NA	NA	NA
Turn Table MF	MFT-201SS	NA	NA	NA
Antenna Tower & Turn Table Controller MF	MF-7802	NA	NA	NA
Radio Communication Analyzer	MT8820C	6201300640	Aug. 01, 2013	Jul. 31, 2015

- NOTE:**
1. The calibration interval of the above test instruments is 12 / 24 months and the calibrations are traceable to NML/ROC and NIST/USA.
 2. The test was performed in HwaYa Chamber 10.
 3. The horn antenna and HP preamplifier (model: 8449B) are used only for the measurement of emission frequency above 1GHz if tested.
 4. The FCC Site Registration No. is 690701.
 5. The IC Site Registration No. is IC 7450F-10.

3 GENERAL INFORMATION

3.1 GENERAL DESCRIPTION OF EUT

PRODUCT	Smartphone	
MODEL NAME	OPM9300	
POWER SUPPLY	5Vdc (adapter or host equipment) 3.85Vdc or 3.8Vdc (battery)	
MODULATION TECHNOLOGY	LTE Band 7	QPSK, 16QAM
FREQUENCY RANGE	LTE Band 7 Channel Bandwidth: 5MHz	2502.5MHz ~ 2567.5MHz
	LTE Band 7 Channel Bandwidth: 10MHz	2505MHz ~ 2565MHz
	LTE Band 7 Channel Bandwidth: 15MHz	2507.5MHz ~ 2562.5MHz
	LTE Band 7 Channel Bandwidth: 20MHz	2510MHz ~ 2560MHz
EMISSION DESIGNATOR	LTE Band 7 Channel Bandwidth: 5MHz	4M50G7D
	LTE Band 7 Channel Bandwidth: 10MHz	8M97W7D
	LTE Band 7 Channel Bandwidth: 15MHz	13M5G7D
	LTE Band 7 Channel Bandwidth: 20MHz	18M0W7D
MAX. EIRP POWER	LTE Band 7 Channel Bandwidth: 5MHz	77.39mW
	LTE Band 7 Channel Bandwidth: 10MHz	71.99mW
	LTE Band 7 Channel Bandwidth: 15MHz	78.31mW
	LTE Band 7 Channel Bandwidth: 20MHz	79.43mW
ANTENNA TYPE	Fixed Internal Antenna	
DATA CABLE	Refer to Note as below	
I/O PORTS	Refer to users' manual	
ACCESSORY DEVICES	Refer to Note as below	

NOTE:

- There're 2 configurations for the EUT listed as below.
Main sample (A): Phone + Battery 1 + LCD Panel 1
2nd sample (B): Phone + Battery 2 + LCD Panel 2
✧ Only the worst test data was presented in the report.
- The EUT's accessories list refers to Ext. Pho.
- The above EUT information is declared by manufacturer and for more detailed features description, please refer to the manufacturer's specifications or User's Manual.

3.2 CONFIGURATION OF SYSTEM UNDER TEST FOR RADIATION EMISSION TEST

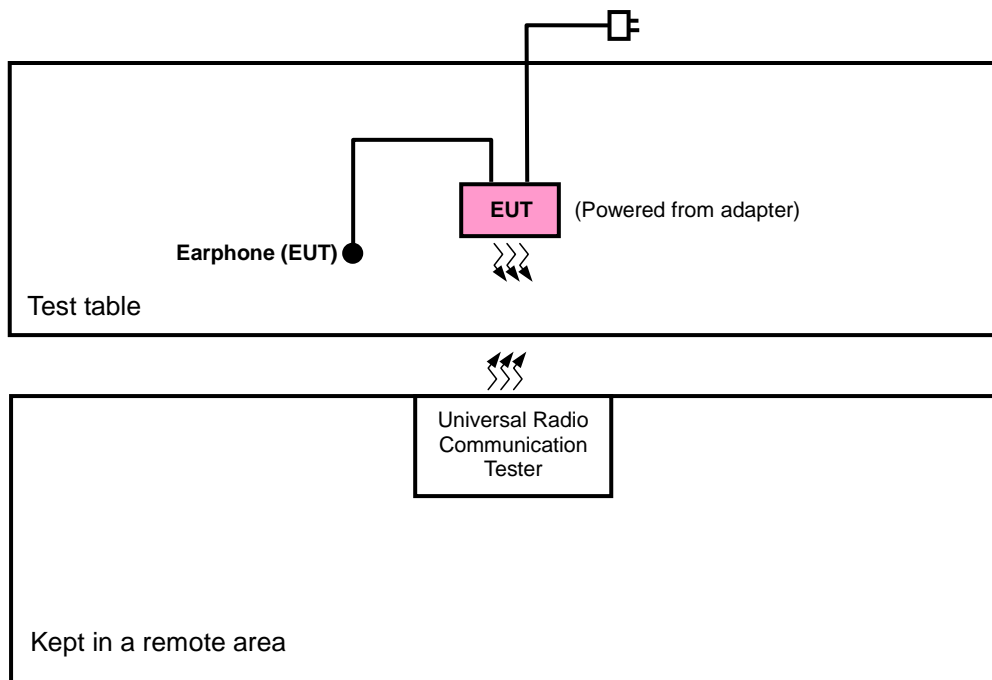

FOR E.I.R.P. TEST

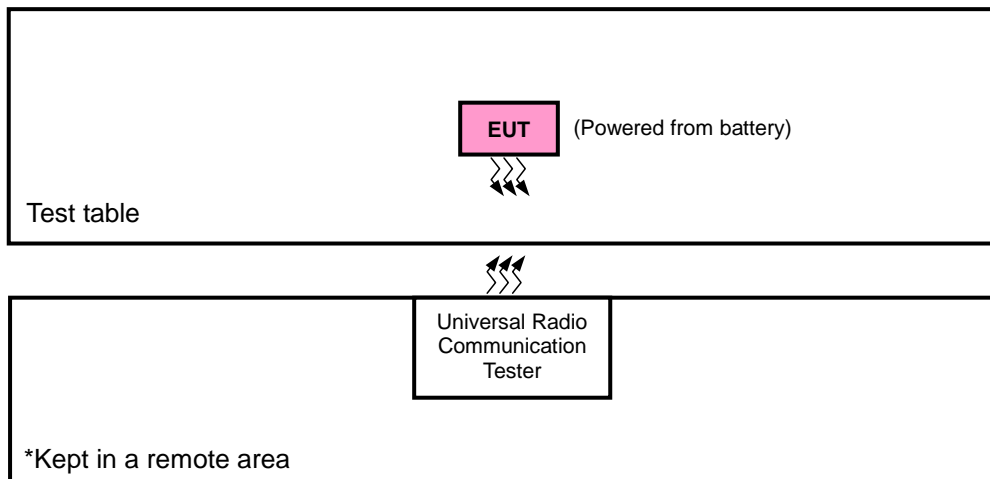

3.3 DESCRIPTION OF SUPPORT UNITS

The EUT has been tested as an independent unit together with other necessary accessories or support units.

3.4 DESCRIPTION OF TEST MODES

Pre-Scan has been conducted to determine the worst-case mode from all possible combinations between available modulations, data rates, XYZ axis and antenna ports. The worst case was found when positioned on Y-plane for EIRP and X-axis for radiated emission. Following channel(s) was (were) selected for the final test as listed below:

EUT CONFIGURE MODE	DESCRIPTION
A	Main sample
B	2 nd sample

LTE BAND 7

EUT CONFIGURE MODE	TEST ITEM	AVAILABLE CHANNEL	TESTED CHANNEL	CHANNEL BANDWIDTH	MODULATION	MODE
A	EIRP	20775 to 21425	20775, 21100, 21425	5MHz	QPSK, 16QAM	1 RB / 12 RB Offset
		20800 to 21400	20800, 21100, 21400	10MHz	QPSK, 16QAM	1 RB / 24 RB Offset
		20825 to 21375	20825, 21100, 21375	15MHz	QPSK, 16QAM	1 RB / 37 RB Offset
		20850 to 21350	20850, 21100 21350	20MHz	QPSK, 16QAM	1 RB / 50 RB Offset
A	FREQUENCY STABILITY	20775 to 21425	21100	5MHz	QPSK	1 RB / 12 RB Offset
		20800 to 21400	21100	10MHz	QPSK	1 RB / 24 RB Offset
		20825 to 21375	21100	15MHz	QPSK	1 RB / 37 RB Offset
		20850 to 21350	21100	20MHz	QPSK	1 RB / 50 RB Offset
A	OCCUPIED BANDWIDTH	20775 to 21425	20775, 21100, 21425	5MHz	QPSK, 16QAM	25 RB / 0 RB Offset
		20800 to 21400	20800, 21100, 21400	10MHz	QPSK, 16QAM	50 RB / 0 RB Offset
		20825 to 21375	20825, 21100, 21375	15MHz	QPSK, 16QAM	75 RB / 0 RB Offset
		20850 to 21350	20850, 21100 21350	20MHz	QPSK, 16QAM	100 RB / 0 RB Offset
A	PEAK TO AVERAGE RATIO	20775 to 21425	20775, 21100, 21425	5MHz	QPSK, 16QAM	1 RB / 12 RB Offset
		20800 to 21400	20800, 21100, 21400	10MHz	QPSK, 16QAM	1 RB / 24 RB Offset
		20825 to 21375	20825, 21100, 21375	15MHz	QPSK, 16QAM	1 RB / 37 RB Offset
		20850 to 21350	20850, 21100 21350	20MHz	QPSK, 16QAM	1 RB / 50 RB Offset
A	BAND EDGE	20775 to 21425	20775, 21425	5MHz	QPSK, 16QAM	25 RB / 0 RB Offset
		20800 to 21400	20800, 21400	10MHz	QPSK, 16QAM	50 RB / 0 RB Offset
		20825 to 21375	20825, 21375	15MHz	QPSK, 16QAM	75 RB / 0 RB Offset
		20850 to 21350	20850, 21350	20MHz	QPSK, 16QAM	100 RB / 0 RB Offset
A	CONDUCTED EMISSION	20775 to 21425	21100	5MHz	QPSK	1 RB / 0 RB Offset
		20800 to 21400	21100	10MHz	QPSK	1 RB / 0 RB Offset
		20825 to 21375	21100	15MHz	QPSK	1 RB / 0 RB Offset
		20850 to 21350	21100	20MHz	QPSK	1 RB / 0 RB Offset
A	RADIATED EMISSION	20850 to 21350	21100	20MHz	QPSK	1 RB / 50 RB Offset

Note: This device was tested under all bandwidths, RB configurations and modulations. The worst case was found in QPSK modulation.

TEST CONDITION:

TEST ITEM	ENVIRONMENTAL CONDITIONS	INPUT POWER	TESTED BY
ERP/EIRP	26deg. C, 58%RH	3.8Vdc	Charles Hsiao
FREQUENCY STABILITY	26deg. C, 58%RH	3.8Vdc	Luke Chen
OCCUPIED BANDWIDTH	26deg. C, 58%RH	3.8Vdc	Luke Chen
PEAK TO AVERAGE RATIO	26deg. C, 58%RH	3.8Vdc	Luke Chen
BAND EDGE	26deg. C, 58%RH	3.8Vdc	Luke Chen
CONDUCTED EMISSION	26deg. C, 58%RH	3.8Vdc	Luke Chen
RADIATED EMISSION	25deg. C, 65%RH	120Vac, 60Hz	Charles Hsiao

3.5 GENERAL DESCRIPTION OF APPLIED STANDARDS

The EUT is a RF product. According to the specifications of the manufacturer, it must comply with the requirements of the following standards:

FCC 47 CFR Part 2

FCC 47 CFR Part 27

ANSI/TIA/EIA-603-C 2004

NOTE: All test items have been performed and recorded as per the above standards.

4 TEST TYPES AND RESULTS

4.1 OUTPUT POWER MEASUREMENT

4.1.1 LIMITS OF OUTPUT POWER MEASUREMENT

The radiated peak output power shall be according to the specific rule Part 27.50(h)(2) that “User stations are limited to 2 watts” and 27.50(i) specific that “Peak transmit power must be measure over any interval of continuous transmission using instrumentation calibration in terms of rms-equivalent voltage.”

4.1.2 TEST PROCEDURES

EIRP MEASUREMENT:

- a. All measurements were done at low, middle and high operational frequency range. RBW and VBW is 10MHz for LTE mode.
- b. Substitution method is used for E.I.R.P measurement. In the semi-anechoic chamber, EUT placed on the 0.8m height of Turn Table, rotated the table around 360 degrees to search the maximum radiation power and receiver antenna shall be rotated vertical and horizontal polarization and moved height from 1m to 4m to find the maximum polar radiated power. The “Read Value” is the spectrum reading the maximum power value.
- c. The substitution horn antenna is substituted for EUT at the same position and signals generator export the CW signal to the substitution antenna via a tx cable. Rotated the Turn Table and moved receiving antenna to find the maximum radiation power. Adjust output power level of S.G to get a Value of spectrum reading equal to “Read Value” of step b. Record the power level of S.G.
- d. $EIRP = \text{Output power level of S.G} - \text{TX cable loss} + \text{Antenna gain of substitution horn}.$

CONDUCTED POWER MEASUREMENT:

- a. The EUT was set up for the maximum power with LTE link data modulation and link up with simulator.
- b. Set the EUT to transmit under low, middle and high channel and record the power level shown on simulator.

4.1.3 TEST SETUP

EIRP / ERP MEASUREMENT:

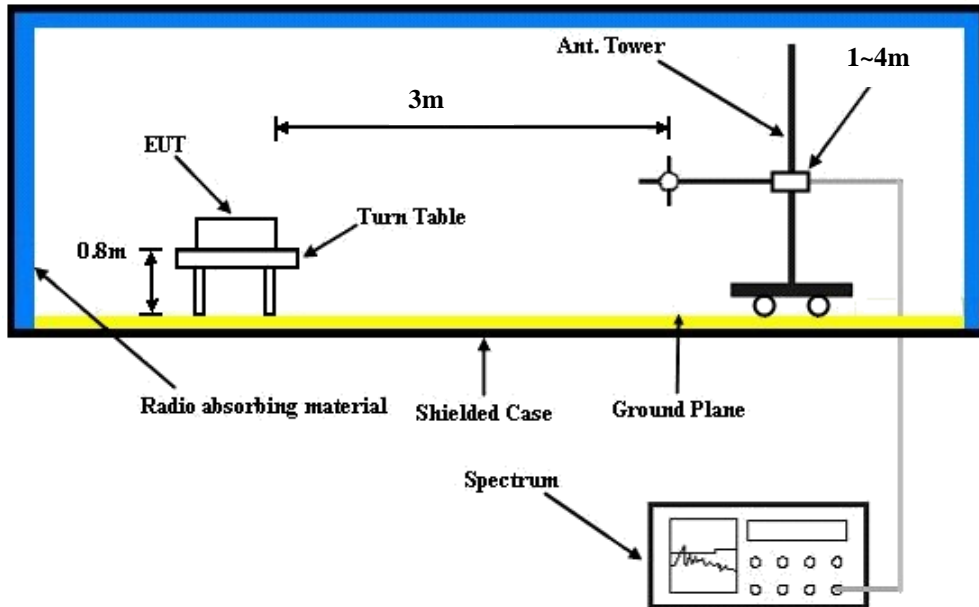

CONDUCTED POWER MEASUREMENT:

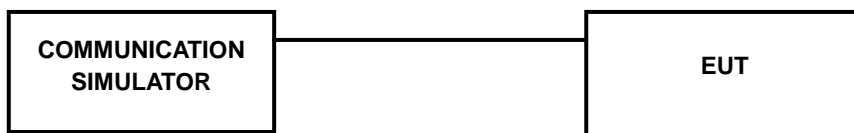

4.1.4 TEST RESULTS

AVERAGE CONDUCTED OUTPUT POWER (dBm)

Band / BW	RB Size	RB Offset	QPSK			3GPP MPR (dB)	16QAM			3GPP MPR (dB)
			Low CH 20775	Mid CH 21100	High CH 21425		Low CH 20775	Mid CH 21100	High CH 21425	
			2502.5 MHz	2535.0 MHz	2567.5 MHz		2502.5 MHz	2535.0 MHz	2567.5 MHz	
7 / 5M	1	0	21.20	21.23	21.10	0	20.38	20.41	20.28	1
	1	12	21.47	21.16	21.37	0	20.65	20.34	20.55	1
	1	24	21.28	20.89	21.09	0	20.46	20.07	20.27	1
	12	0	20.27	20.24	20.05	1	19.45	19.42	19.23	2
	12	6	20.29	20.19	20.14	1	19.47	19.37	19.32	2
	12	13	20.27	20.16	20.02	1	19.45	19.34	19.20	2
	25	0	20.28	20.18	20.06	1	19.46	19.36	19.24	2

Band / BW	RB Size	RB Offset	QPSK			3GPP MPR (dB)	16QAM			3GPP MPR (dB)
			Low CH 20800	Mid CH 21100	High CH 21400		Low CH 20800	Mid CH 21100	High CH 21400	
			2505.0 MHz	2535.0 MHz	2565.0 MHz		2505.0 MHz	2535.0 MHz	2565.0 MHz	
7 / 10M	1	0	21.38	21.41	21.28	0	20.44	20.47	20.34	1
	1	24	21.65	21.34	21.55	0	20.71	20.40	20.61	1
	1	49	21.46	21.07	21.27	0	20.52	20.13	20.33	1
	25	0	20.45	20.42	20.23	1	19.51	19.48	19.29	2
	25	12	20.47	20.37	20.32	1	19.53	19.43	19.38	2
	25	25	20.45	20.34	20.20	1	19.51	19.40	19.26	2
	50	0	20.46	20.36	20.24	1	19.52	19.42	19.30	2

Band / BW	RB Size	RB Offset	QPSK			3GPP MPR (dB)	16QAM			3GPP MPR (dB)
			Low CH 20825	Mid CH 21100	High CH 21375		Low CH 20825	Mid CH 21100	High CH 21375	
			2507.5 MHz	2535.0 MHz	2562.5 MHz		2507.5 MHz	2535.0 MHz	2562.5 MHz	
7 / 15M	1	0	21.50	21.53	21.40	0	20.51	20.54	20.41	1
	1	37	21.77	21.46	21.67	0	20.78	20.47	20.68	1
	1	74	21.58	21.19	21.39	0	20.59	20.20	20.40	1
	36	0	20.57	20.54	20.35	1	19.58	19.55	19.36	2
	36	19	20.59	20.49	20.44	1	19.60	19.50	19.45	2
	36	39	20.57	20.46	20.32	1	19.58	19.47	19.33	2
	75	0	20.58	20.48	20.36	1	19.59	19.49	19.37	2

Band / BW	RB Size	RB Offset	QPSK			3GPP MPR (dB)	16QAM			3GPP MPR (dB)
			Low CH 20850	Mid CH 21100	High CH 21350		Low CH 20850	Mid CH 21100	High CH 21350	
			2510.0 MHz	2535.0 MHz	2560.0 MHz		2510.0 MHz	2535.0 MHz	2560.0 MHz	
7 / 20M	1	0	21.65	21.68	21.55	0	20.56	20.59	20.46	1
	1	50	21.92	21.61	21.82	0	20.83	20.52	20.73	1
	1	99	21.73	21.34	21.54	0	20.64	20.25	20.45	1
	50	0	20.72	20.69	20.50	1	19.63	19.60	19.41	2
	50	25	20.74	20.64	20.59	1	19.65	19.55	19.50	2
	50	50	20.72	20.61	20.47	1	19.63	19.52	19.38	2
	100	0	20.73	20.63	20.51	1	19.64	19.54	19.42	2



A D T

AVERAGE EIRP (dBm)

LTE Band 7							
Channel Bandwidth: 5MHz / QPSK							
Plane	Channel	Frequency (MHz)	LVL (dBm)	Correction Factor(dB)	EIRP(dBm)	EIRP(mW)	Polarization (H/V)
Y	20775	2502.5	-25.75	44.24	18.49	70.60	H
	21100	2535.0	-25.31	44.20	18.89	77.39	
	21425	2567.5	-25.96	44.80	18.84	76.58	
	20775	2502.5	-27.56	44.19	16.63	46.04	V
	21100	2535.0	-27.90	44.09	16.19	41.57	
	21425	2567.5	-28.13	44.50	16.37	43.34	

LTE Band 7							
Channel Bandwidth: 5MHz / 16QAM							
Plane	Channel	Frequency (MHz)	LVL (dBm)	Correction Factor(dB)	EIRP(dBm)	EIRP(mW)	Polarization (H/V)
Y	20775	2502.5	-27.13	44.24	17.11	51.38	H
	21100	2535.0	-27.09	44.20	17.11	51.37	
	21425	2567.5	-27.15	44.80	17.65	58.22	
	20775	2502.5	-28.48	44.19	15.71	37.25	V
	21100	2535.0	-28.35	44.09	15.74	37.48	
	21425	2567.5	-29.29	44.50	15.21	33.18	

LTE Band 7							
Channel Bandwidth: 10MHz / QPSK							
Plane	Channel	Frequency (MHz)	LVL (dBm)	Correction Factor(dB)	EIRP(dBm)	EIRP(mW)	Polarization (H/V)
Y	20800	2505.0	-26.06	44.34	18.28	67.31	H
	21100	2535.0	-25.75	44.20	18.45	69.94	
	21400	2565.0	-26.15	44.72	18.57	71.99	
	20800	2505.0	-27.94	44.23	16.29	42.52	V
	21100	2535.0	-27.39	44.09	16.70	46.75	
	21400	2565.0	-27.69	44.41	16.72	46.95	

LTE Band 7							
Channel Bandwidth: 10MHz / 16QAM							
Plane	Channel	Frequency (MHz)	LVL (dBm)	Correction Factor(dB)	EIRP(dBm)	EIRP(mW)	Polarization (H/V)
Y	20800	2505.0	-26.91	44.34	17.43	55.35	H
	21100	2535.0	-27.19	44.20	17.01	50.20	
	21400	2565.0	-26.87	44.72	17.85	61.00	
	20800	2505.0	-28.97	44.23	15.26	33.54	V
	21100	2535.0	-28.20	44.09	15.89	38.80	
	21400	2565.0	-29.05	44.41	15.36	34.32	

LTE Band 7							
Channel Bandwidth: 15MHz / QPSK							
Plane	Channel	Frequency (MHz)	LVL (dBm)	Correction Factor(dB)	EIRP(dBm)	EIRP(mW)	Polarization (H/V)
Y	20825	2507.5	-26.21	44.32	18.11	64.68	H
	21100	2535.0	-25.54	44.20	18.66	73.40	
	21375	2562.5	-25.91	44.85	18.94	78.31	
	20825	2507.5	-27.14	43.99	16.85	48.44	V
	21100	2535.0	-27.27	44.09	16.82	48.06	
	21375	2562.5	-28.06	44.51	16.45	44.16	

LTE Band 7							
Channel Bandwidth: 15MHz / 16QAM							
Plane	Channel	Frequency (MHz)	LVL (dBm)	Correction Factor(dB)	EIRP(dBm)	EIRP(mW)	Polarization (H/V)
Y	20825	2507.5	-26.60	44.32	17.72	59.13	H
	21100	2535.0	-26.33	44.20	17.87	61.19	
	21375	2562.5	-27.22	44.85	17.63	57.92	
	20825	2507.5	-27.98	43.99	16.01	39.92	V
	21100	2535.0	-28.19	44.09	15.90	38.89	
	21375	2562.5	-29.27	44.51	15.24	33.42	



A D T

LTE Band 7							
Channel Bandwidth: 20MHz / QPSK							
Plane	Channel	Frequency (MHz)	LVL (dBm)	Correction Factor(dB)	EIRP(dBm)	EIRP(mW)	Polarization (H/V)
Y	20850.0	2510.0	-25.16	44.16	19.00	79.43	H
	21100.0	2535.0	-25.23	44.20	18.97	78.83	
	21350.0	2560.0	-26.13	44.81	18.68	73.74	
	20850.0	2510.0	-28.28	44.78	16.50	44.67	V
	21100.0	2535.0	-27.42	44.09	16.67	46.43	
	21350.0	2560.0	-27.94	44.72	16.78	47.64	

LTE Band 7							
Channel Bandwidth: 20MHz / 16QAM							
Plane	Channel	Frequency (MHz)	LVL (dBm)	Correction Factor(dB)	EIRP(dBm)	EIRP(mW)	Polarization (H/V)
Y	20850.0	2510.0	-26.49	44.16	17.67	58.48	H
	21100.0	2535.0	-26.26	44.20	17.94	62.19	
	21350.0	2560.0	-27.42	44.81	17.39	54.79	
	20850.0	2510.0	-29.39	44.78	15.39	34.59	V
	21100.0	2535.0	-28.44	44.09	15.65	36.71	
	21350.0	2560.0	-28.74	44.72	15.98	39.63	

4.2 FREQUENCY STABILITY MEASUREMENT

4.2.1 LIMITS OF FREQUENCY STABILITY MEASUREMENT

The frequency stability shall be sufficient to ensure that the fundamental emissions stay within the authorized bands of operation.

4.2.2 TEST PROCEDURE

- a. Device is placed at the oven room. The oven room could control the temperatures and humidity. Power warm up is at least 15 min and power applied should perform before recording frequency error.
- b. EUT is connected the external power supply to control the DC input power. The test voltage range is from minimum to maximum working voltage. Each step shall be record the frequency error rate.
- c. The temperature range step is 10 degrees in this test items. All temperature levels shall be hold the $\pm 0.5^{\circ}\text{C}$ during the measurement testing. The each temperature step shall be at least 0.5 hours, consider the EUT could be test under the stability condition.

NOTE: The frequency error was recorded frequency error from the communication simulator.

4.2.3 TEST SETUP

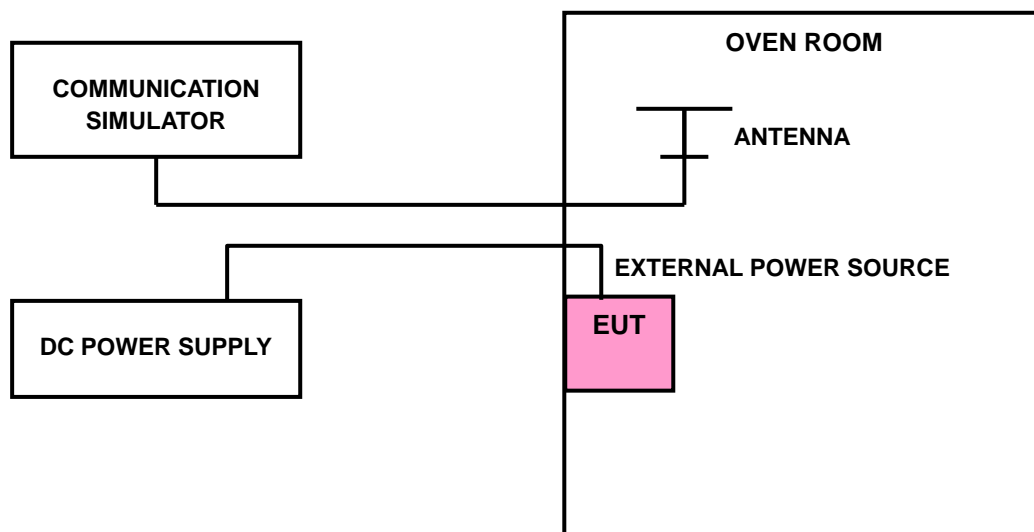

4.2.4 TEST RESULTS

FREQUENCY ERROR vs. VOLTAGE

VOLTAGE (Volts)	FREQUENCY ERROR (ppm)				LIMIT (ppm)
	LTE BAND 7				
	5MHz	10MHz	15MHz	20MHz	
3.8	0.0017	0.0007	0.0018	-0.0013	2.5
3.6	0.0005	0.0009	0.0006	-0.0006	2.5
4.4	-0.0009	0.0015	0.0011	-0.0010	2.5

NOTE: The applicant defined the normal working voltage of the battery is from 3.6Vdc to 4.4Vdc.

FREQUENCY ERROR vs. TEMPERATURE

TEMP. (°C)	FREQUENCY ERROR (ppm)				LIMIT (ppm)
	LTE BAND 7				
	5MHz	10MHz	15MHz	20MHz	
-35	0.0013	0.0007	0.0011	0.0007	2.5
-30	0.0009	0.0009	0.0017	0.0017	2.5
-20	0.0005	0.0013	0.0009	0.0005	2.5
-10	0.0017	0.0020	0.0007	0.0013	2.5
0	0.0011	0.0005	-0.0017	-0.0009	2.5
10	-0.0013	-0.0013	-0.0021	-0.0017	2.5
20	-0.0008	-0.0005	-0.0009	-0.0005	2.5
30	-0.0006	-0.0017	-0.0007	0.0010	2.5
40	0.0009	-0.0009	0.0009	0.0013	2.5
50	0.0021	0.0017	0.0021	0.0005	2.5
60	0.0013	0.0013	0.0013	0.0018	2.5

4.3 OCCUPIED BANDWIDTH MEASUREMENT

4.3.1 LIMITS OF OCCUPIED BANDWIDTH MEASUREMENT

The width of a frequency band such that, below the lower and above the upper frequency limits, the mean powers emitted are each equal to a specified percentage 0.5 %of the total mean power of a given emission.

4.3.2 TEST SETUP

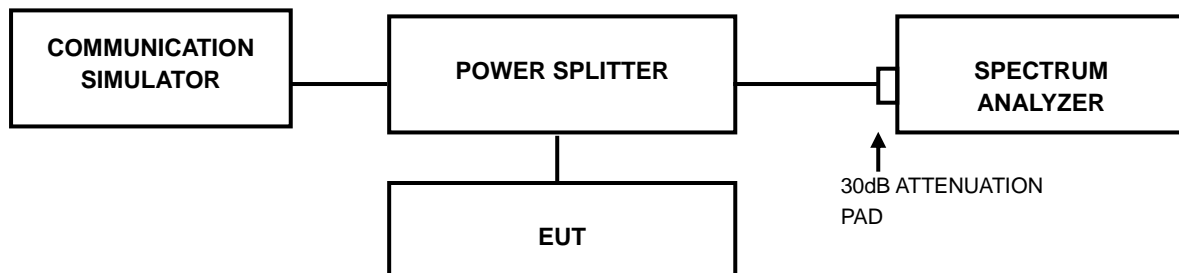

4.3.3 TEST PROCEDURES

- The conducted occupied bandwidth used the power splitter via EUT RF power connector between simulation base station and spectrum analyzer.
- Use OBW measurement function of Spectrum analyzer to measure 99 % occupied bandwidth.



A D T

4.3.4 TEST RESULTS

LTE BAND 7							
CHANNEL BANDWIDTH: 5MHz				CHANNEL BANDWIDTH: 10MHz			
CHANNEL	FREQUENCY (MHz)	99% OCCUPIED BANDWIDTH (MHz)		CHANNEL	FREQUENCY (MHz)	99% OCCUPIED BANDWIDTH (MHz)	
		QPSK	16QAM			QPSK	16QAM
20775	2502.5	4.4986	4.4963	20800	2505.0	8.9684	8.9704
21100	2535.0	4.4970	4.4956	21100	2535.0	8.9675	8.9745
21425	2567.5	4.4974	4.4951	21400	2565.0	8.9631	8.9637

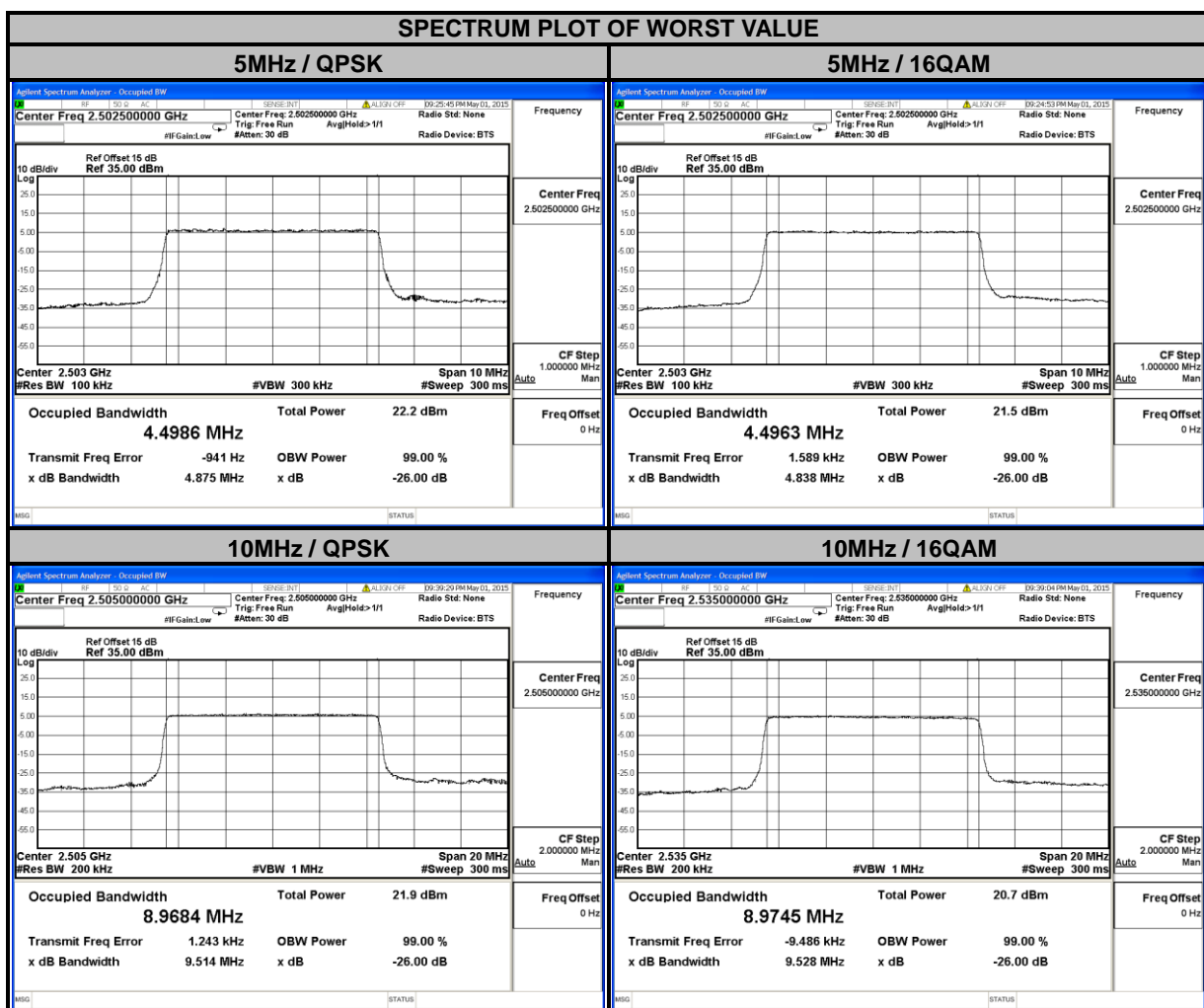



A D T

LTE BAND 7							
CHANNEL BANDWIDTH: 15MHz				CHANNEL BANDWIDTH: 20MHz			
CHANNEL	FREQUENCY (MHz)	99% OCCUPIED BANDWIDTH (MHz)		CHANNEL	FREQUENCY (MHz)	99% OCCUPIED BANDWIDTH (MHz)	
		QPSK	16QAM			QPSK	16QAM
20825	2507.5	13.479	13.465	20850	2510.0	17.935	17.946
21100	2535.0	13.472	13.469	21100	2535.0	17.967	17.971
21375	2562.5	13.461	13.451	21350	2560.0	17.941	17.953

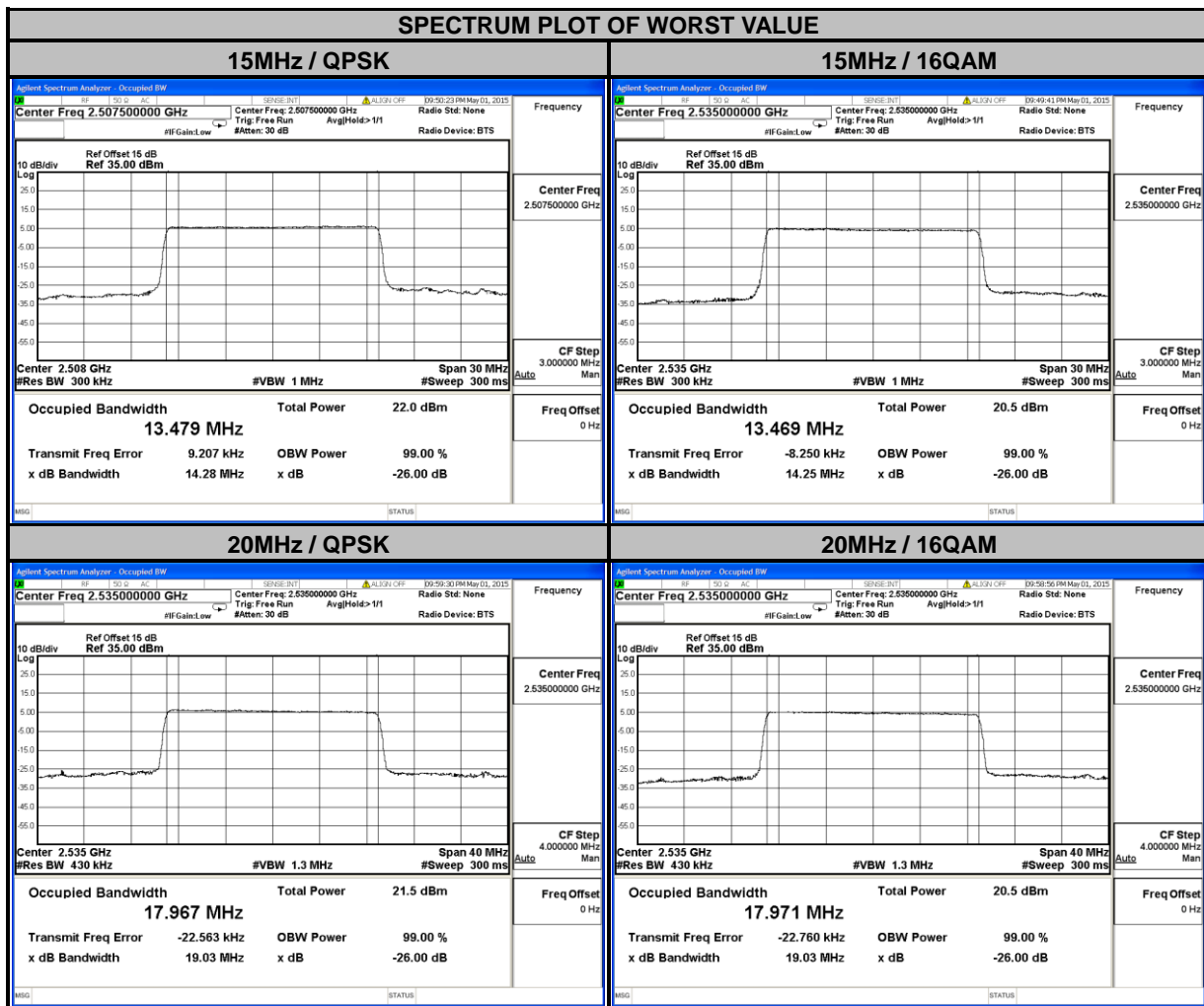

4.4 PEAK TO AVERAGE RATIO

4.4.1 LIMITS OF PEAK TO AVERAGE RATIO MEASUREMENT

In measuring transmissions in this band using an average power technique, the peak to-average ratio (PAR) of the transmission may not exceed 13 dB.

4.4.2 TEST SETUP

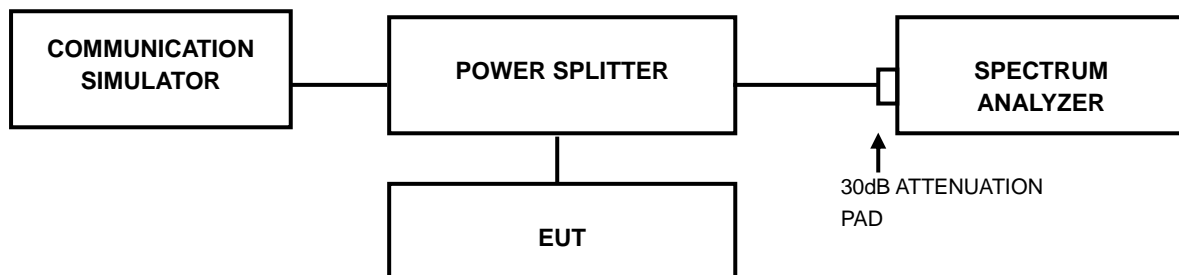

4.4.3 TEST PROCEDURES

1. Set resolution/measurement bandwidth \geq signal's occupied bandwidth;
2. Set the number of counts to a value that stabilizes the measured CCDF curve;
3. Record the maximum PAPR level associated with a probability of 0.1%.



A D T

4.4.4 TEST RESULTS

LTE BAND 7							
CHANNEL BANDWIDTH: 5MHz				CHANNEL BANDWIDTH: 10MHz			
CHANNEL	FREQUENCY (MHz)	PEAK TO AVERAGE RATIO (dB)		CHANNEL	FREQUENCY (MHz)	PEAK TO AVERAGE RATIO (dB)	
		QPSK	16QAM			QPSK	16QAM
20775	2502.5	3.84	4.68	20800	2505.0	3.80	4.73
21100	2535.0	4.13	4.95	21100	2535.0	4.16	4.95
21425	2567.5	4.02	5.06	21400	2565.0	4.12	5.04

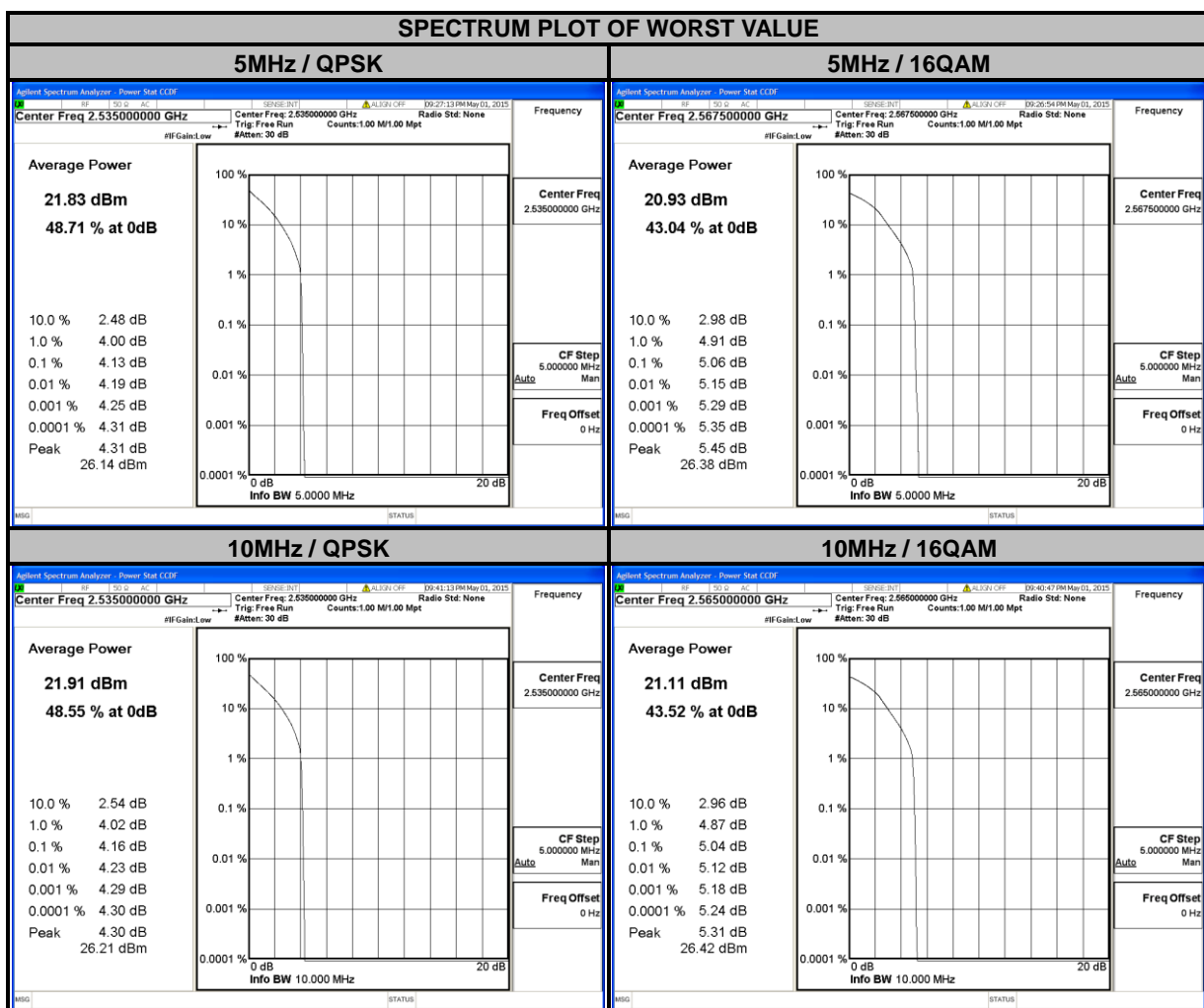

LTE BAND 7							
CHANNEL BANDWIDTH: 15MHz				CHANNEL BANDWIDTH: 20MHz			
CHANNEL	FREQUENCY (MHz)	PEAK TO AVERAGE RATIO (dB)		CHANNEL	FREQUENCY (MHz)	PEAK TO AVERAGE RATIO (dB)	
		QPSK	16QAM			QPSK	16QAM
20825	2507.5	3.85	4.66	20850	2510.0	3.73	4.70
21100	2535.0	4.07	4.91	21100	2535.0	4.08	4.95
21375	2562.5	3.99	5.12	21350	2560.0	4.04	4.82

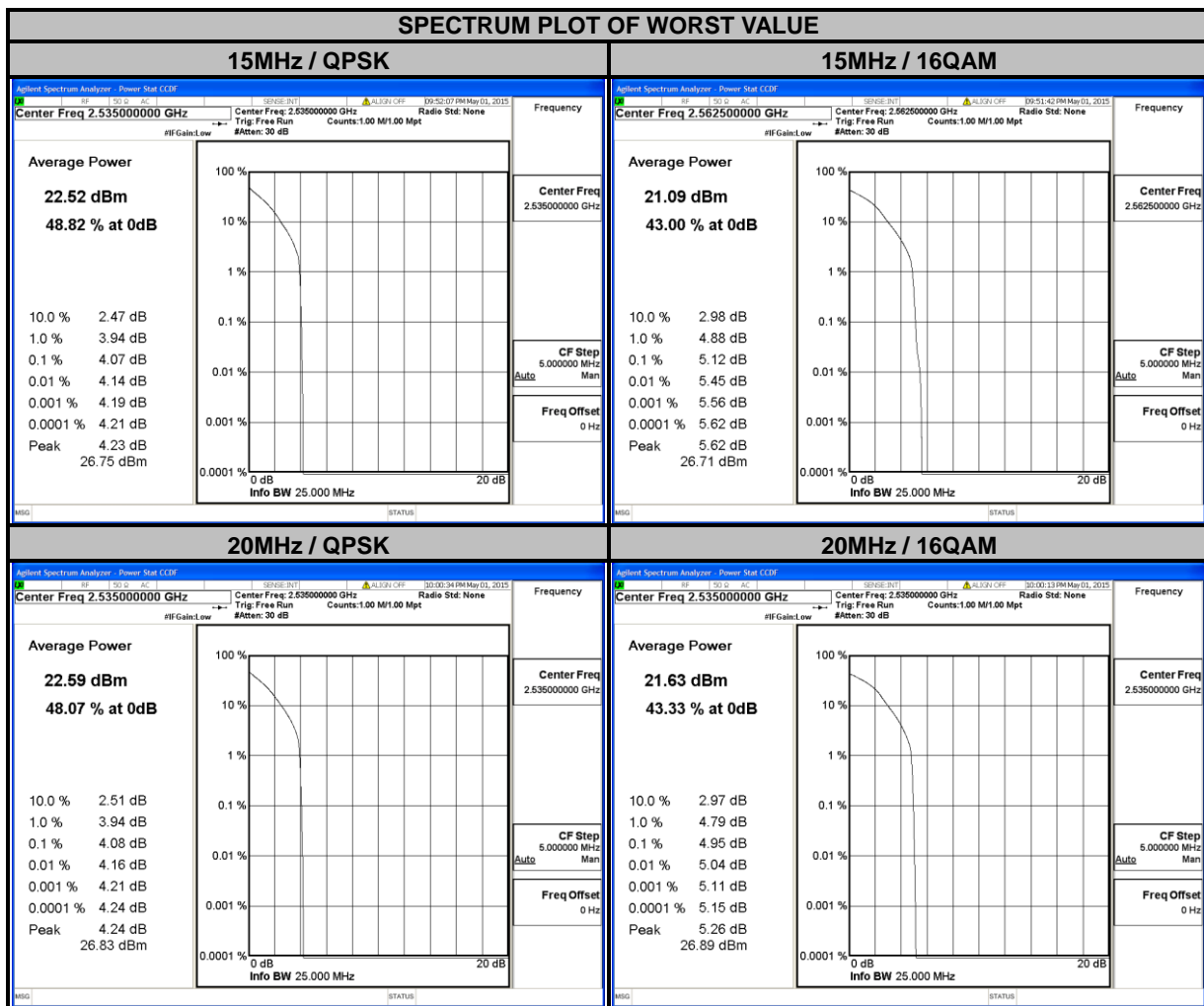

4.5 BAND EDGE MEASUREMENT

4.5.1 LIMITS OF BAND EDGE MEASUREMENT

According to FCC 27.53(l)(4) specified that power of any emission outside of the channel edge must be attenuated below the transmitting power (P) by a factor shall be not less than $40 + 10 \log (P)$ dB on all frequencies between the channel edge and 5 megahertz from the channel edge, $43 + 10 \log (P)$ dB on all frequencies between 5 megahertz and X megahertz from the channel edge, and $55 + 10 \log (P)$ dB on all frequencies more than X megahertz from the channel edge, where X is the greater of 6 megahertz or the actual emission bandwidth. In addition, the attenuation factor shall not be less that $43 + 10 \log (P)$ dB on all frequencies between 2490.5 MHz and 2496 MHz and $55 + 10 \log (P)$ dB at or below 2490.5 MHz. In the 1MHz bands immediately outside and adjacent to the frequency block a resolution bandwidth of at least two percent may be employed, except when the 1 megahertz band is 2495-2496 MHz, in which case a resolution bandwidth of at least one percent may be employed.

4.5.2 TEST SETUP

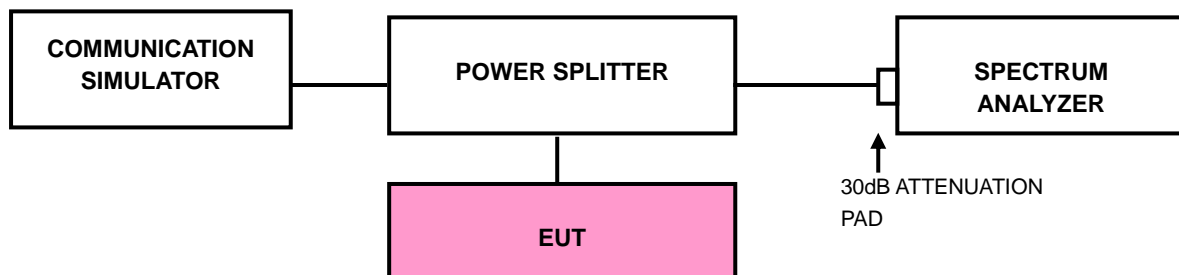

4.5.3 TEST PROCEDURES

- a. The EUT was set up for the maximum peak power with LTE link data modulation. The power was measured with R&S Spectrum Analyzer. All measurements were done at 2 channels (low and high operational frequency range.).
- b. The band edge measurement used the power splitter via EUT RF power connector between simulation base station and spectrum analyzer.
- c. The center frequency of spectrum is the band edge frequency and span is 8MHz. RB of the spectrum is 100kHz and VB of the spectrum is 300kHz (Channel bandwidth 5MHz/10MHz).
- d. The center frequency of spectrum is the band edge frequency and span is 8MHz. RB of the spectrum is 150kHz and VB of the spectrum is 470kHz (Channel bandwidth 15MHz).
- e. The center frequency of spectrum is the band edge frequency and span is 8MHz. RB of the spectrum is 180kHz and VB of the spectrum is 560kHz (Channel bandwidth 20MHz).
- f. Record the max trace plot into the test report.

4.5.4 TEST RESULTS





A D T

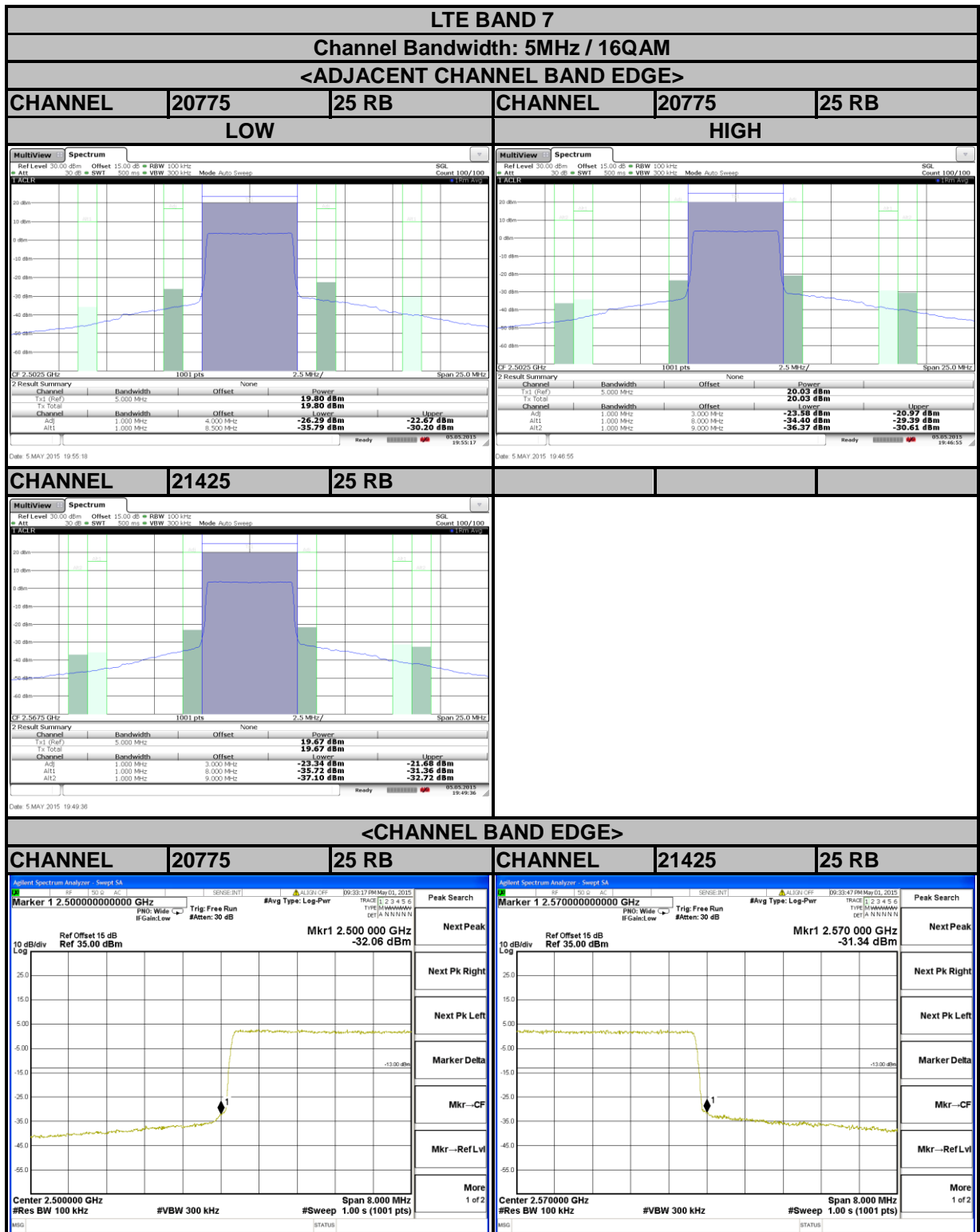



A D T



LTE BAND 7
Channel Bandwidth: 10MHz / 16QAM
<ADJACENT CHANNEL BAND EDGE>

CHANNEL	20800	50 RB	CHANNEL	20800	50 RB
	LOW			HIGH	

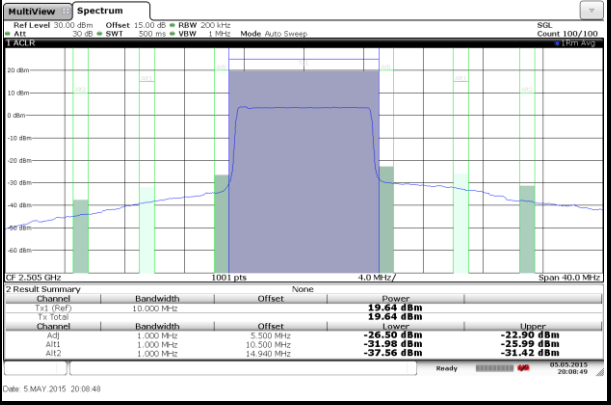
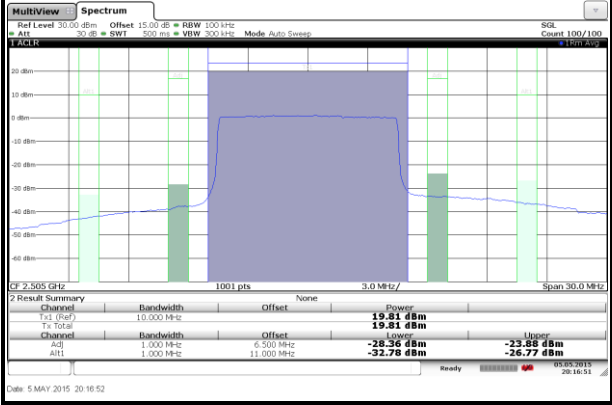

CHANNEL	21400	50 RB			
---------	-------	-------	--	--	--

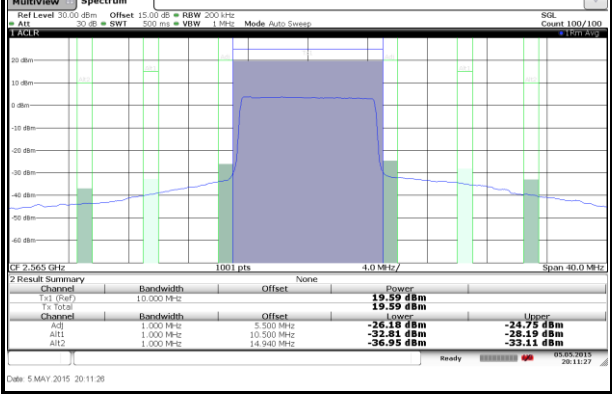

<CHANNEL BAND EDGE>

CHANNEL	20800	50 RB	CHANNEL	21400	50 RB
---------	-------	-------	---------	-------	-------

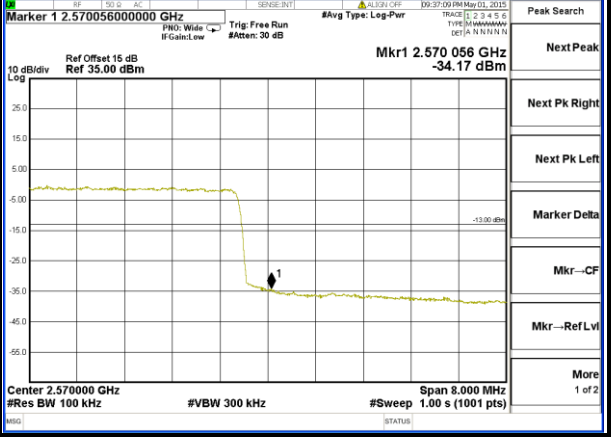
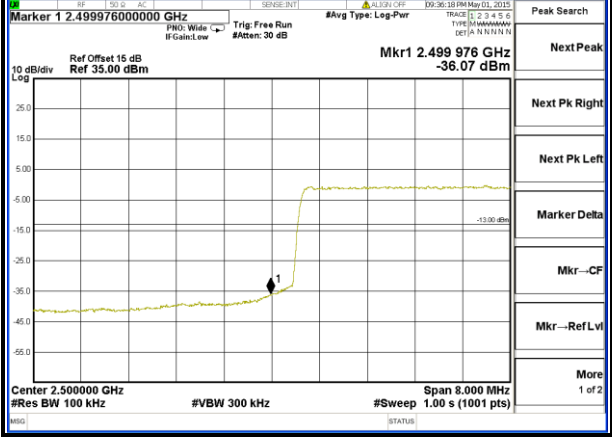

LTE BAND 7
Channel Bandwidth: 15MHz / QPSK
<ADJACENT CHANNEL BAND EDGE>

CHANNEL	20825	75 RB	CHANNEL	20825	75 RB
----------------	--------------	--------------	----------------	--------------	--------------

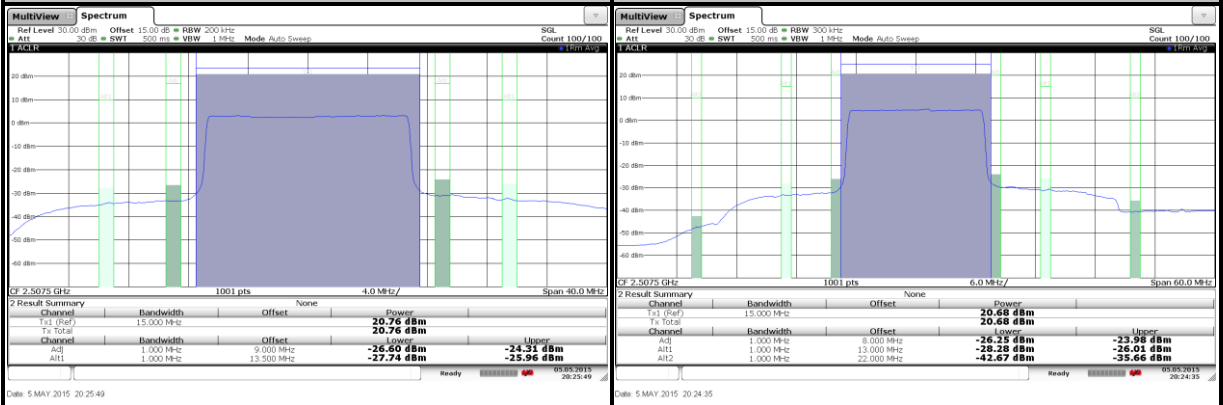

CHANNEL	21375	75 RB			
----------------	--------------	--------------	--	--	--

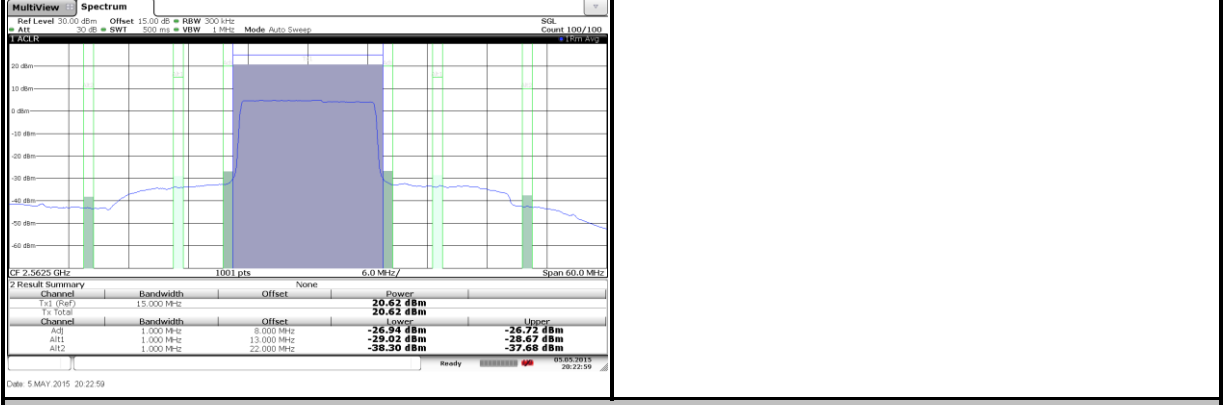

<CHANNEL BAND EDGE>

CHANNEL	20825	75 RB	CHANNEL	21375	75 RB
----------------	--------------	--------------	----------------	--------------	--------------

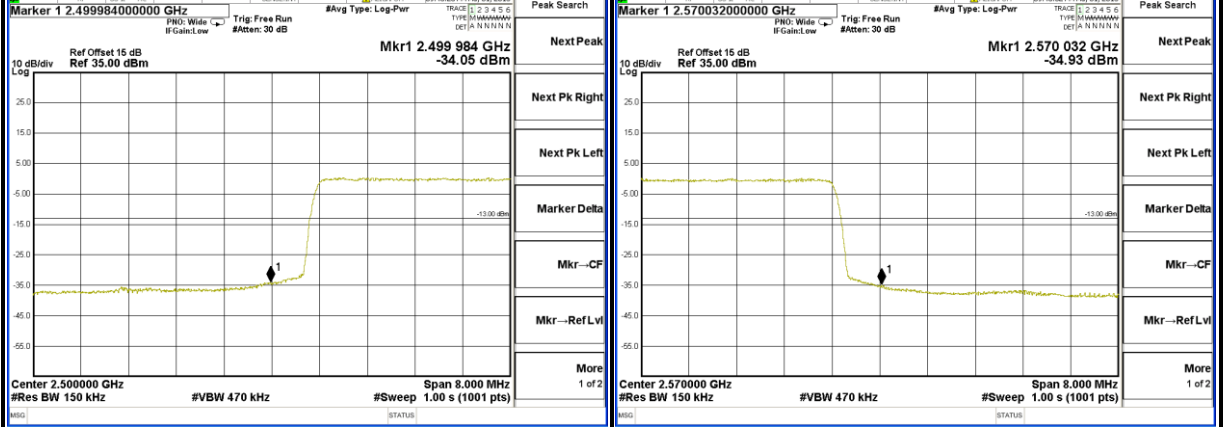

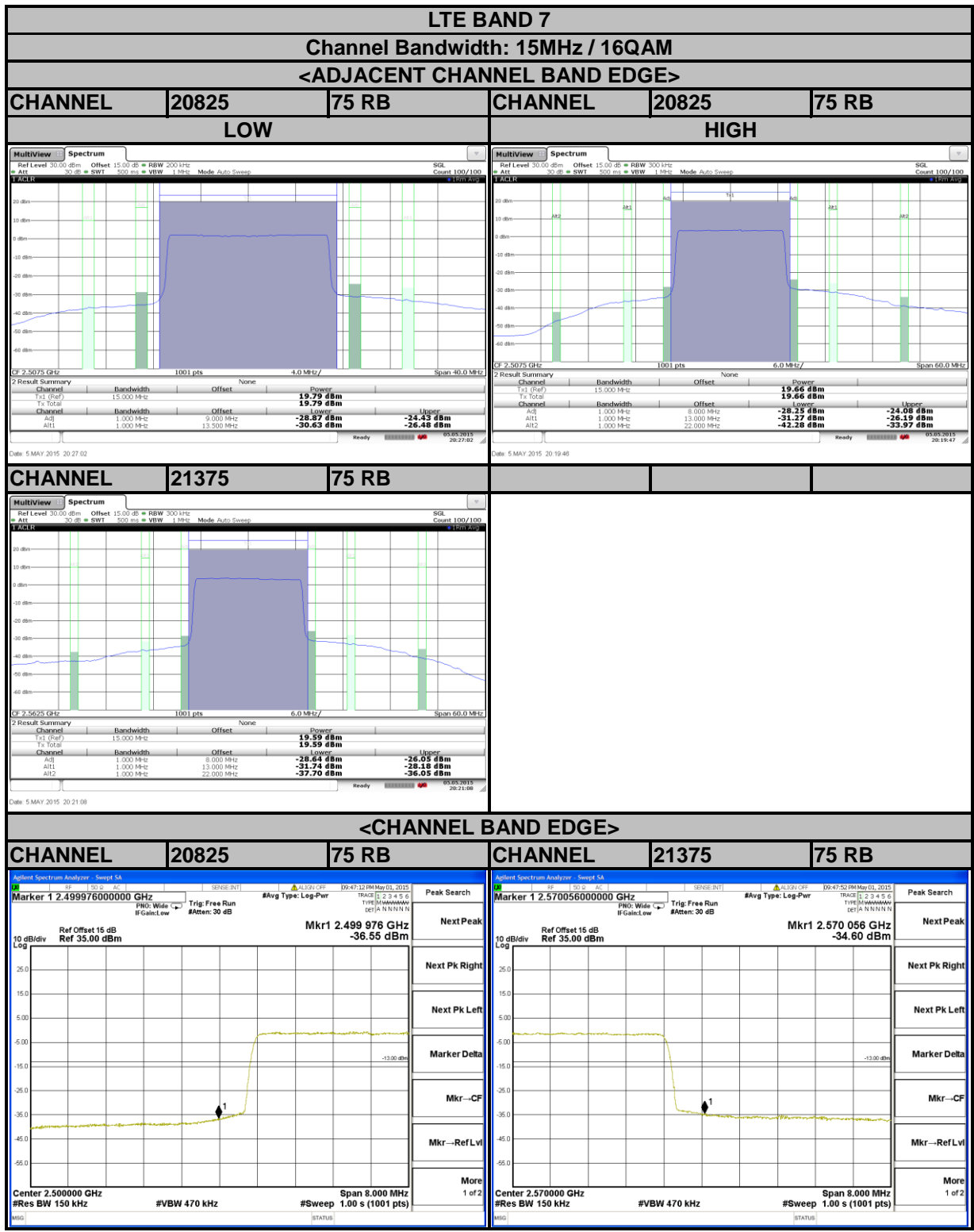



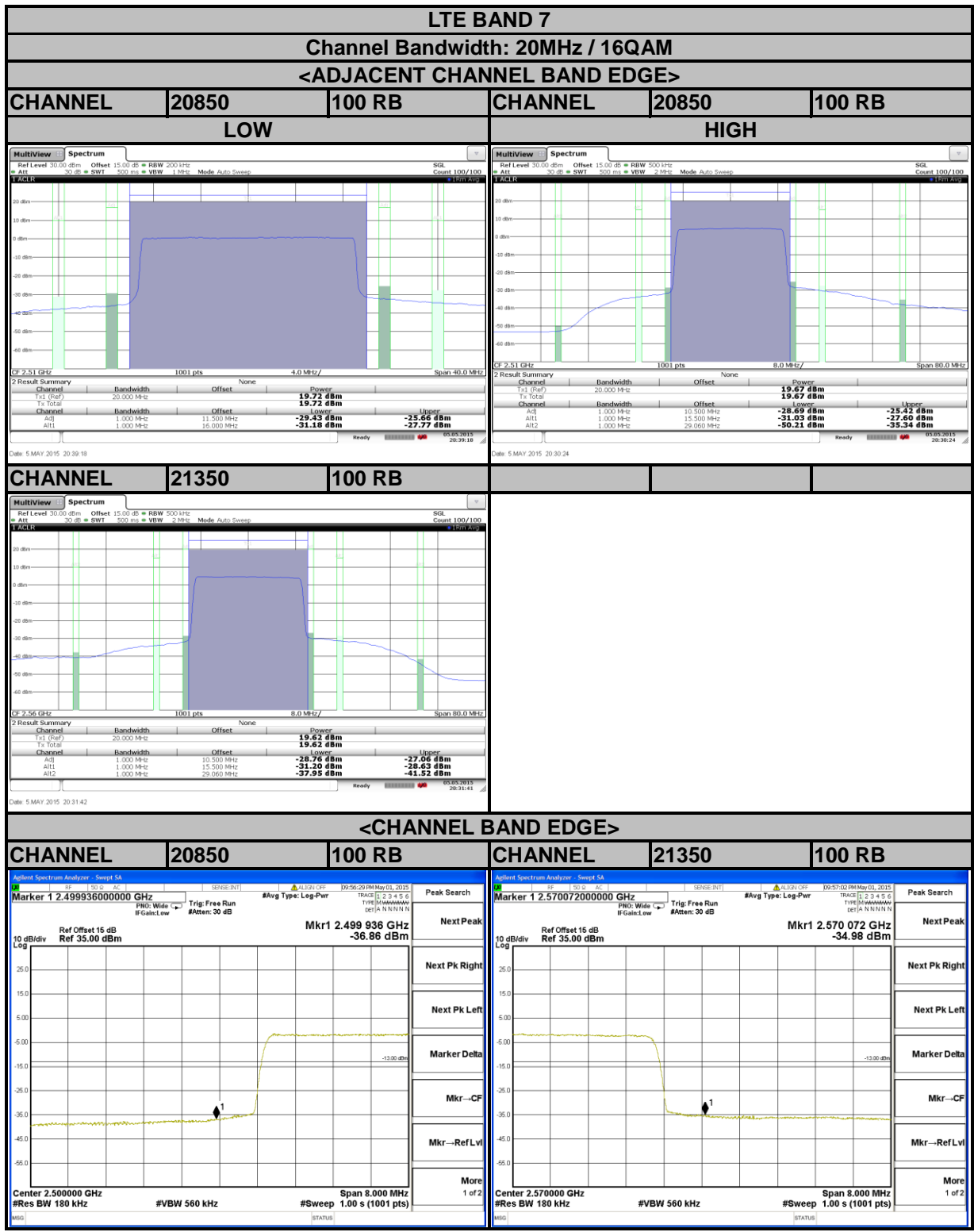

4.6 CONDUCTED SPURIOUS EMISSIONS

4.6.1 LIMITS OF CONDUCTED SPURIOUS EMISSIONS MEASUREMENT

The power of any emission outside a licensee's frequency block shall be attenuated below the transmitter power (P) by at least $55 + 10 \log_{10}(P)$ dB. The limit of emission is equal to -25dBm.

4.6.2 TEST PROCEDURE

- a. The EUT makes a phone call to the communication simulator. All measurements were done at low, middle and high operational frequency range.
- b. Measuring frequency range is from 30MHz to 26GHz. 10dB attenuation pad is connected with spectrum. RBW=1MHz and VBW=3MHz are used for conducted emission measurement.

4.6.3 TEST SETUP

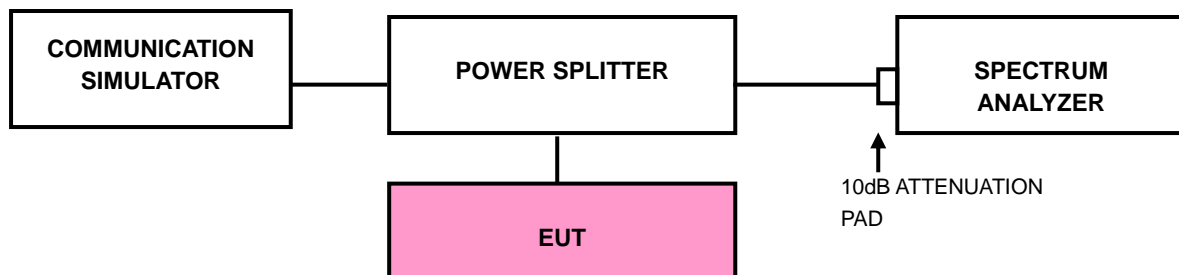



A D T

4.6.4 TEST RESULTS

FREQUENCY RANGE: 30MHz~26GHz

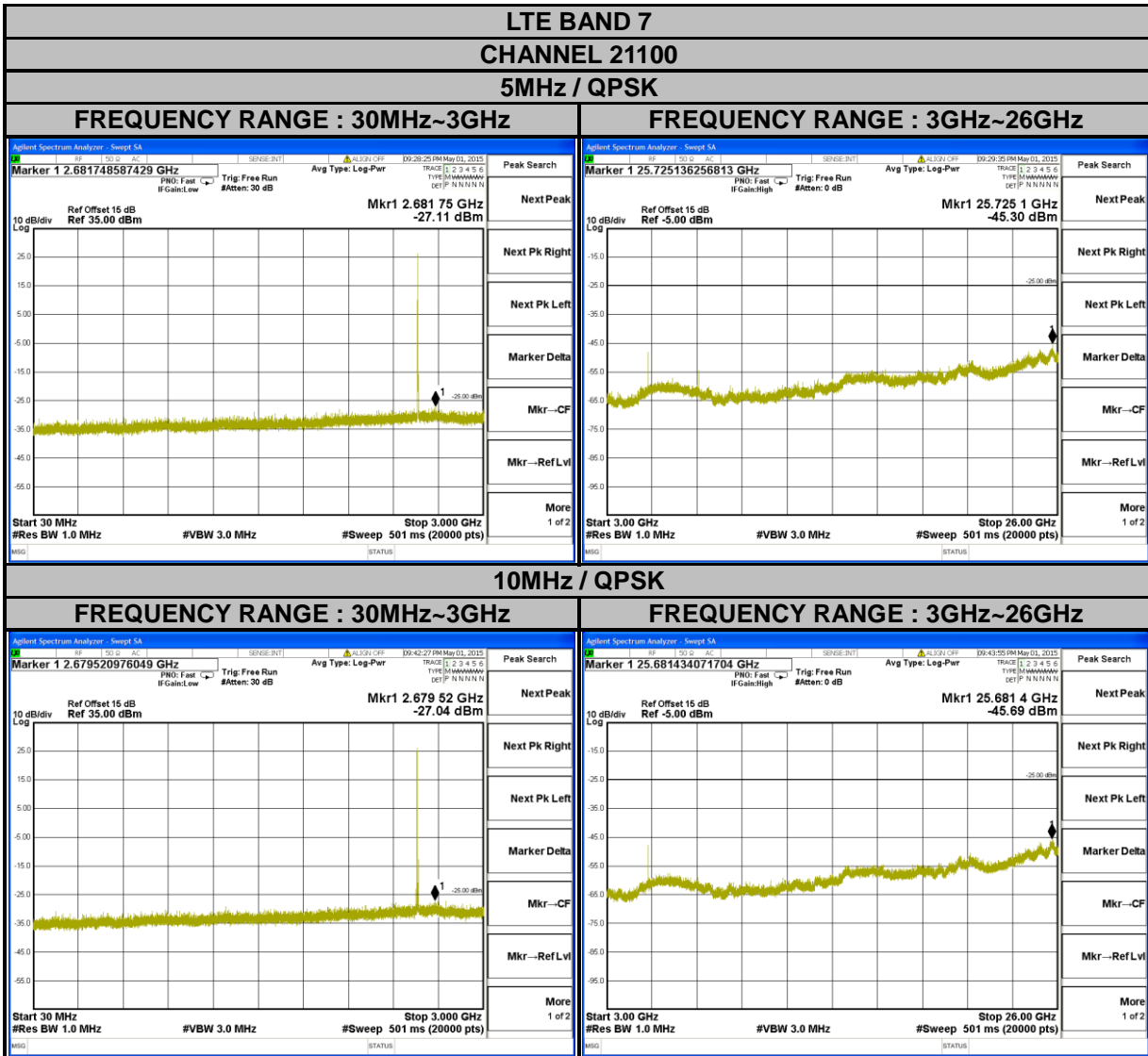



A D T

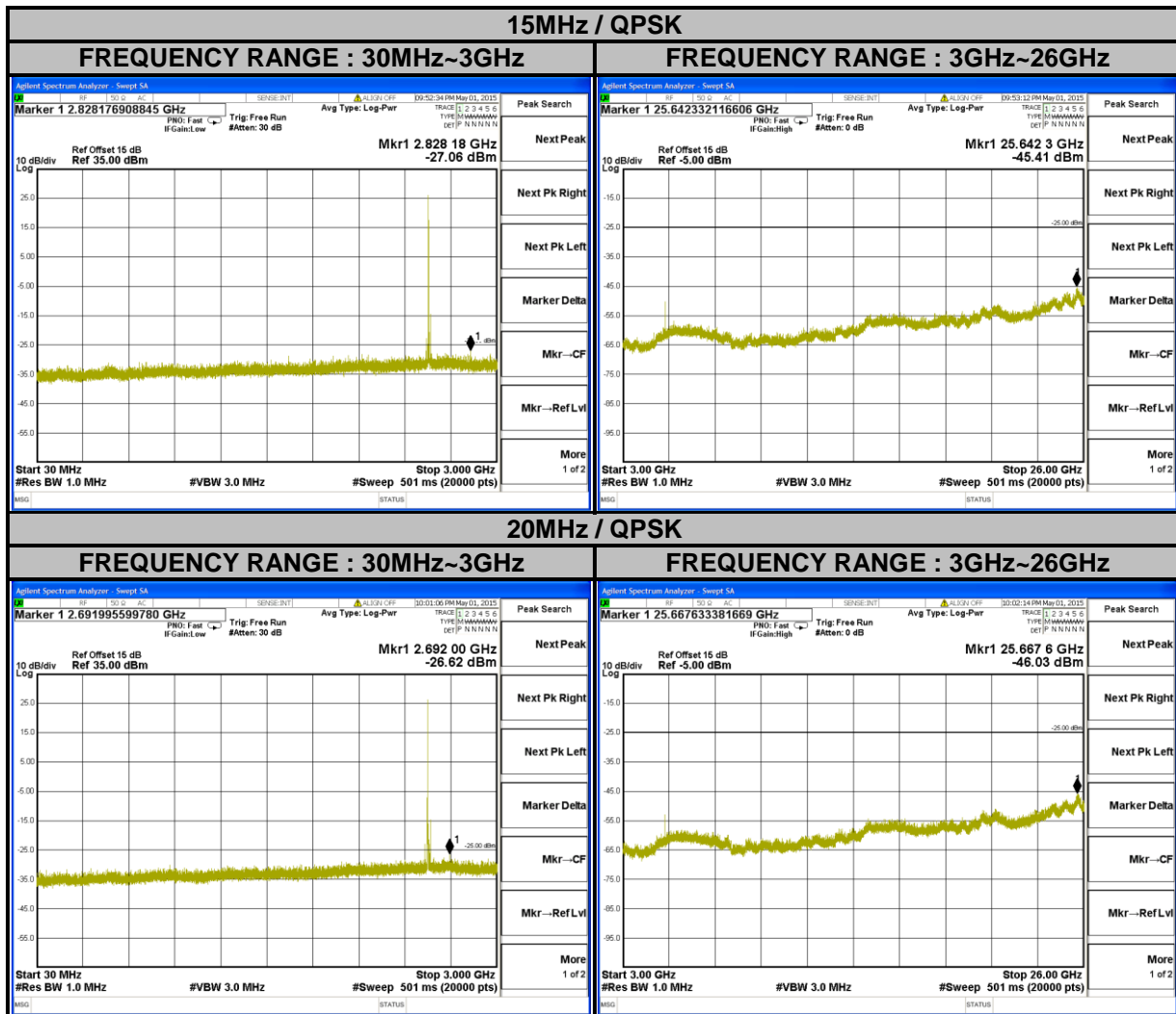

4.7 RADIATED EMISSION MEASUREMENT

4.7.1 LIMITS OF RADIATED EMISSION MEASUREMENT

The power of any emission outside a licensee's frequency block shall be attenuated below the transmitter power (P) by at least $55 + 10 \log_{10}(P)$ dB. The limit of emission is equal to -25dBm.

4.7.2 TEST PROCEDURES

- a. Substitution method is used for E.I.R.P measurement. In the semi-anechoic chamber, EUT placed on the 0.8m height of Turn Table, rotated the table around 360 degrees to search the maximum radiation power and receiver antenna shall be rotated vertical and horizontal polarization and moved height from 1m to 4m to find the maximum polar radiated power. The "Read Value" is the spectrum reading the maximum power value.
- b. The substitution horn antenna is substituted for EUT at the same position and signals generator export the CW signal to the substitution antenna via a TX cable. Rotated the Turn Table and moved receiving antenna to find the maximum radiation power. Adjust output power level of S.G to get a Value of spectrum reading equal to "Read Value " of step a. Record the power level of S.G.
- c. $EIRP = \text{Output power level of S.G} - \text{TX cable loss} + \text{Antenna gain of substitution horn}$.
- d. E.R.P power can be calculated form E.I.R.P power by subtracting the gain of dipole, $E.R.P \text{ power} = E.I.P.R \text{ power} - 2.15dBi$.

NOTE: The resolution bandwidth of spectrum analyzer is 1 MHz and the video bandwidth is 3 MHz.

4.7.3 DEVIATION FROM TEST STANDARD

No deviation

4.7.4 TEST SETUP

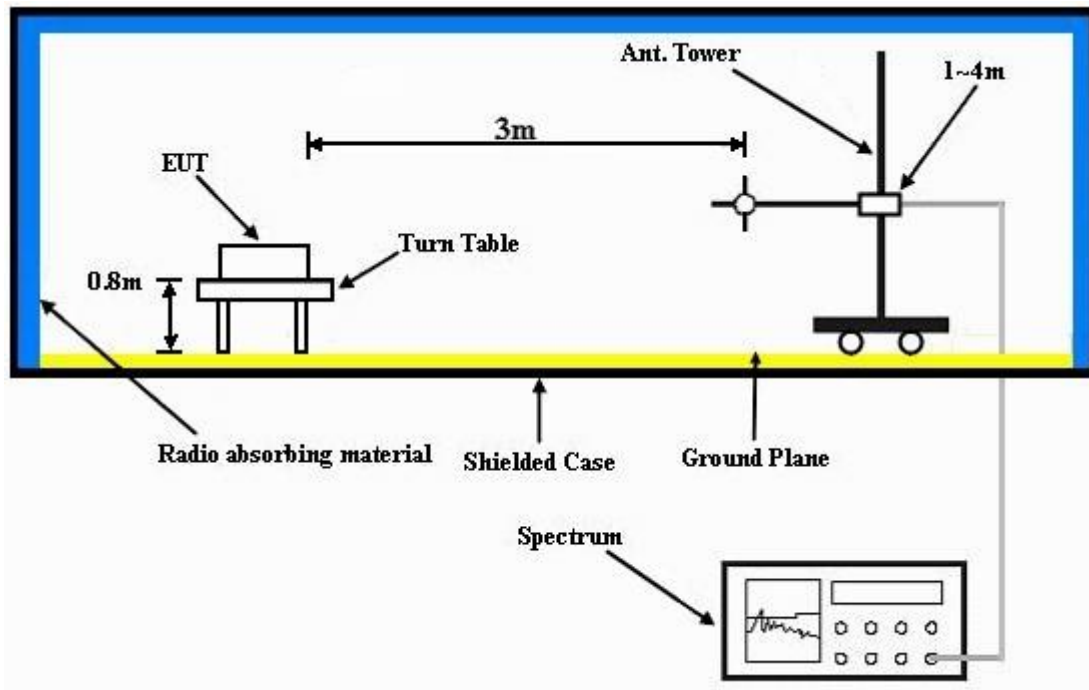

For the actual test configuration, please refer to the attached file (Test Setup Photo).

4.7.5 TEST RESULTS

LTE BAND 7

CHANNEL BANDWIDTH: 20MHz / QPSK



Bureau Veritas Consumer Products Services Ltd., Taoyuan Branch

A D T

Data: 13

Date: 2015-05-08

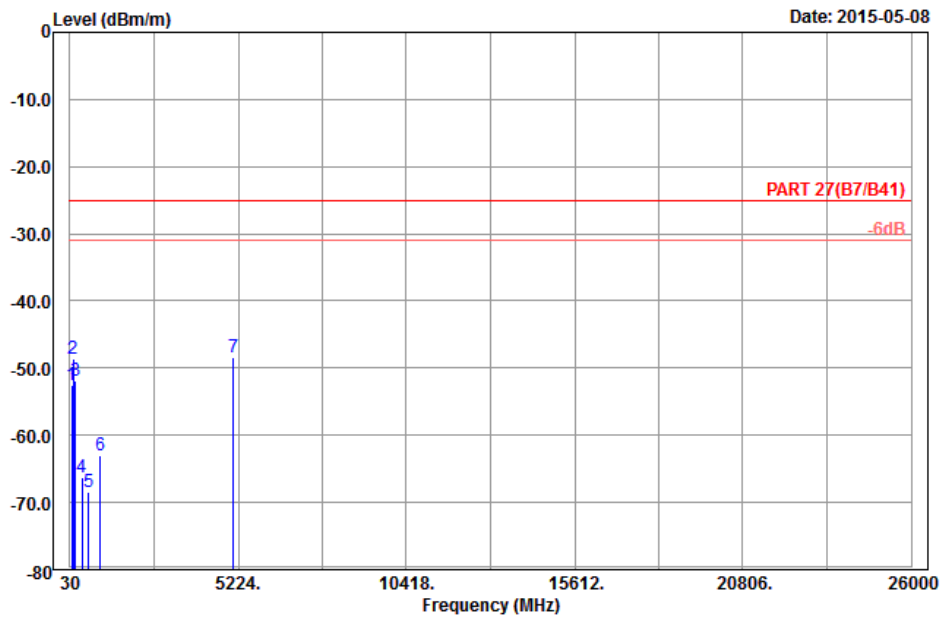

Site : 966 chamber 1
 Condition: PART 27(B7/B41) 3m Horizontal
 Remark : LTE_Band 7_QPSK(1,50)_20M_CH21100
 Tested by: Charles Hsiao
 Plane : X

	Read	Limit	Over			
Freq	Level	Level	Line	Limit	Factor	Remark
MHz	dBm/m	dBm	dBm/m	dB	dB/m	
1	93.45	-52.63	-42.12	-25.00	-27.63	-10.51 Peak
2	136.11	-48.54	-40.87	-25.00	-23.54	-7.67 Peak
3	210.63	-51.96	-45.92	-25.00	-26.96	-6.04 Peak
4	396.60	-66.25	-63.35	-25.00	-41.25	-2.90 Peak
5	609.40	-68.41	-68.74	-25.00	-43.41	0.33 Peak
6	970.60	-62.95	-68.12	-25.00	-37.95	5.17 Peak
7 pp	5070.00	-48.35	-67.74	-25.00	-23.35	19.39 Peak



A D T



Bureau Veritas Consumer Products Services Ltd., Taoyuan Branch

A D T

Data: 14

Date: 2015-05-08

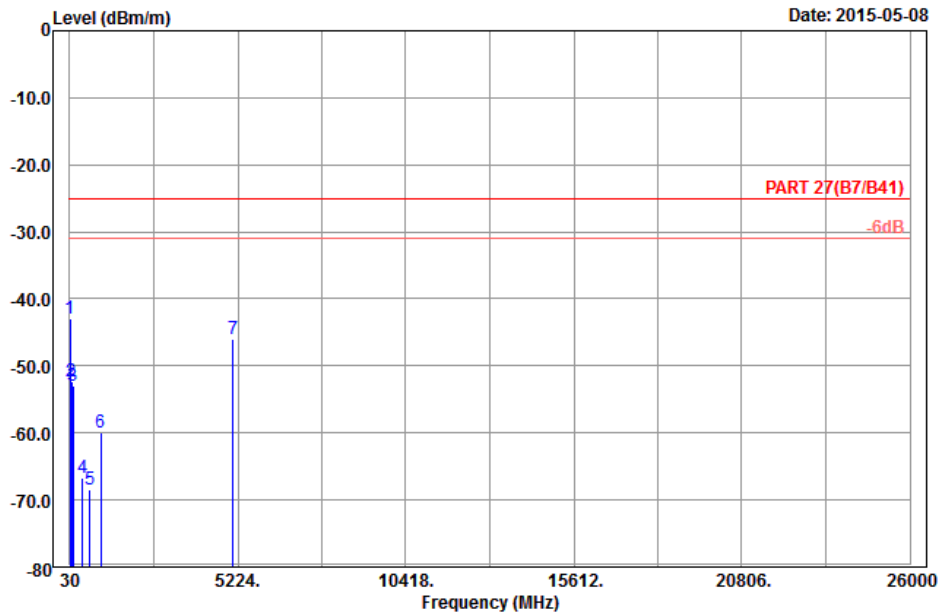

Site : 966 chamber 1
 Condition: PART 27(B7/B41) 3m Vertical
 Remark : LTE_Band 7_QPSK(1,50)_20M_CH21100
 Tested by: Charles Hsiao
 Plane : X

	Freq	Level	Read Level	Limit	Over	Factor	Remark
	MHz	dBm/m	dBm	dBm/m	dB	dB/m	
1	pp	31.35	-42.98	-32.33	-25.00	-17.98	-10.65 Peak
2		81.03	-52.21	-40.55	-25.00	-27.21	-11.66 Peak
3		139.35	-53.01	-45.32	-25.00	-28.01	-7.69 Peak
4		430.20	-66.74	-63.32	-25.00	-41.74	-3.42 Peak
5		655.60	-68.40	-68.24	-25.00	-43.40	-0.16 Peak
6		990.20	-59.99	-65.23	-25.00	-34.99	5.24 Peak
7		5070.00	-45.96	-65.35	-25.00	-20.96	19.39 Peak



5 INFORMATION ON THE TESTING LABORATORIES

We, Bureau Veritas Consumer Products Services (H.K.) Ltd., Taoyuan Branch, were founded in 1988 to provide our best service in EMC, Radio, Telecom and Safety consultation. Our laboratories are accredited and approved according to ISO/IEC 17025.

If you have any comments, please feel free to contact us at the following:

Linko EMC/RF Lab:

Tel: 886-2-26052180

Fax: 886-2-26051924

Hsin Chu EMC/RF/Telecom Lab:

Tel: 886-3-5935343

Fax: 886-3-5935342

Hwa Ya EMC/RF/Safety Lab:

Tel: 886-3-3183232

Fax: 886-3-3270892

Email: service.adt@tw.bureauveritas.com

Web Site: www.adt.com.tw

The address and road map of all our labs can be found in our web site also.



A D T

6 APPENDIX A – MODIFICATIONS RECORDERS FOR ENGINEERING CHANGES TO THE EUT BY THE LAB

No modifications were made to the EUT by the lab during the test.

---END---