



# FCC RF Test Report

**APPLICANT** : HTC Corporation  
**EQUIPMENT** : Smartphone  
**MODEL NAME** : OPL4200  
**FCC ID** : NM80PL4200  
**STANDARD** : FCC Part 15 Subpart C §15.247  
**CLASSIFICATION** : (DSS) Spread Spectrum Transmitter

The product was received on Dec. 08, 2014 and testing was completed on Jan. 02, 2015. We, SPORTON INTERNATIONAL (KUNSHAN) INC., would like to declare that the tested sample has been evaluated in accordance with the test procedures and has been in compliance with the applicable technical standards.

The test results in this report apply exclusively to the tested model / sample. Without written approval of SPORTON INTERNATIONAL (KUNSHAN) INC., the test report shall not be reproduced except in full.

Reviewed by: Joseph Lin / Supervisor

Approved by: Jones Tsai / Manager



**SPORTON INTERNATIONAL (KUNSHAN) INC.**  
**No. 3-2, PingXiang Road, Kunshan, Jiangsu Province, P. R. China**



## TABLE OF CONTENTS

<b>SUMMARY OF TEST RESULT .....</b>	<b>4</b>
<b>1 GENERAL DESCRIPTION.....</b>	<b>5</b>
1.1 Applicant.....	5
1.2 Manufacturer.....	5
1.3 Product Feature of Equipment Under Test.....	5
1.4 Product Specification subjective to this standard .....	6
1.5 Modification of EUT .....	6
1.6 Testing Location .....	6
1.7 Applicable Standards.....	7
<b>2 TEST CONFIGURATION OF EQUIPMENT UNDER TEST.....</b>	<b>8</b>
2.1 Descriptions of Test Mode .....	8
2.2 Test Mode.....	9
2.3 Connection Diagram of Test System.....	10
2.4 Support Unit used in test configuration and system.....	11
2.5 EUT Operation Test Setup .....	11
2.6 Measurement Results Explanation Example.....	11
<b>3 TEST RESULT .....</b>	<b>12</b>
3.1 Number of Channel Measurement .....	12
3.2 Hopping Channel Separation Measurement .....	14
3.3 Dwell Time Measurement.....	21
3.4 20dB Bandwidth Measurement .....	24
3.5 Peak Output Power Measurement .....	31
3.6 Conducted Band Edges Measurement .....	33
3.7 Conducted Spurious Emission Measurement .....	40
3.8 Radiated Band Edges and Spurious Emission Measurement .....	50
3.9 AC Conducted Emission Measurement.....	56
3.10 Antenna Requirements.....	62
<b>4 LIST OF MEASURING EQUIPMENT.....</b>	<b>63</b>
<b>5 UNCERTAINTY OF EVALUATION.....</b>	<b>64</b>
<b>APPENDIX A. RADIATED SPURIOUS EMISSION</b>	



### REVISION HISTORY

REPORT NO.	VERSION	DESCRIPTION	ISSUED DATE
FR4D0804A	Rev. 01	Initial issue of report	Feb. 02, 2015



### SUMMARY OF TEST RESULT

Report Section	FCC Rule	Description	Limit	Result	Remark
3.1	15.247(a)(1)	Number of Channels	$\geq 15\text{Chs}$	Pass	-
3.2	15.247(a)(1)	Hopping Channel Separation	$\geq 2/3$ of 20dB BW	Pass	-
3.3	15.247(a)(1)	Dwell Time of Each Channel	$\leq 0.4\text{sec}$ in 31.6sec period	Pass	-
3.4	15.247(a)(1)	20dB Bandwidth	NA	Pass	-
3.5	15.247(b)(1)	Peak Output Power	$\leq 125\text{ mW}$	Pass	-
3.6	15.247(d)	Conducted Band Edges	$\leq 20\text{dBc}$	Pass	-
3.7	15.247(d)	Conducted Spurious Emission	$\leq 20\text{dBc}$	Pass	-
3.8	15.247(d)	Radiated Band Edges and Radiated Spurious Emission	15.209(a) & 15.247(d)	Pass	Under limit 11.32 dB at 36.790 MHz
3.9	15.207	AC Conducted Emission	15.207(a)	Pass	Under limit 6.94 dB at 0.950 MHz
3.10	15.203 & 15.247(b)	Antenna Requirement	N/A	Pass	-



# 1 General Description

## 1.1 Applicant

**HTC Corporation**

1F, 6-3 Baoqiang Road, Xindian District, New Taipei City, Taiwan 231

## 1.2 Manufacturer

**Shanghai Huaqin Telecom Technology Co., Ltd**

Building 1, NO.399, keyuan Road, Shanghai, 201203

## 1.3 Product Feature of Equipment Under Test

Product Feature	
<b>Equipment</b>	Smartphone
<b>Model Name</b>	0PL4200
<b>FCC ID</b>	NM80PL4200
<b>EUT supports Radios application</b>	GSM/GPRS/EGPRS/WCDMA/HSPA/HSPA+(Downlink Only) WLAN 2.4GHz 802.11b/g/n HT20 Bluetooth v3.0 + EDR/Bluetooth v4.0 LE
<b>Sample 1</b>	EUT with LCD panel 1, front camera 1 and back camera 1
<b>Sample 2</b>	EUT with LCD panel 2, front camera 2 and back camera 2
<b>Sample 3</b>	EUT with LCD panel 3, front camera 2 and back camera 1
<b>Sample 4</b>	EUT with LCD panel 4, front camera 2 and back camera 1
<b>EUT Stage</b>	Identical Prototype

**Remark:** The above EUT's information was declared by manufacturer. Please refer to the specifications or user's manual for more detailed description.



### 1.4 Product Specification subjective to this standard

Product Specification subjective to this standard	
<b>Tx/Rx Frequency Range</b>	2402 MHz ~ 2480 MHz
<b>Number of Channels</b>	79
<b>Carrier Frequency of Each Channel</b>	2402+n*1 MHz; n=0~78
<b>Maximum Output Power to Antenna</b>	Bluetooth BR(1Mbps) : 5.47 dBm (0.00352 W) Bluetooth EDR (2Mbps) : 5.29 dBm (0.00338 W) Bluetooth EDR (3Mbps) : 5.44 dBm (0.00350 W)
<b>Antenna Type</b>	PIFA Antenna with gain -3.30 dBi
<b>Type of Modulation</b>	Bluetooth BR (1Mbps) : GFSK Bluetooth EDR (2Mbps) : $\pi/4$ -DQPSK Bluetooth EDR (3Mbps) : 8-DPSK

### 1.5 Modification of EUT

No modifications are made to the EUT during all test items.

### 1.6 Testing Location

<b>Test Site</b>	SPORTON INTERNATIONAL (KUNSHAN) INC.			
<b>Test Site Location</b>	No. 3-2, PingXiang Road, Kunshan, Jiangsu Province, P.R.C. TEL: +86-0512-5790-0158 FAX: +86-0512-5790-0958			
<b>Test Site No.</b>	<b>Sporton Site No.</b>			<b>FCC Registration No.</b>
	TH01-KS	CO01-KS	03CH01-KS	149928

**Note:** The test site complies with ANSI C63.4 2009 requirement.



## 1.7 Applicable Standards

According to the specifications of the manufacturer, the EUT must comply with the requirements of the following standards:

- ♦ FCC Part 15 Subpart C §15.247
- ♦ FCC Public Notice DA 00-705
- ♦ ANSI C63.10-2009

### **Remark:**

1. All test items were verified and recorded according to the standards and without any deviation during the test.
2. This EUT has also been tested and complied with the requirements of FCC Part 15, Subpart B, recorded in a separate test report.



## 2 Test Configuration of Equipment Under Test

### 2.1 Descriptions of Test Mode

Preliminary tests were performed in different data rates and recorded the RF output power in the following table:

Channel	Frequency	Bluetooth RF Output Power		
		Data Rate / Modulation		
		GFSK	$\pi/4$ -DQPSK	8-DPSK
		1Mbps	2Mbps	3Mbps
Ch00	2402MHz	4.51 dBm	4.37 dBm	4.60 dBm
Ch39	2441MHz	5.47 dBm	5.29 dBm	5.44 dBm
Ch78	2480MHz	5.12 dBm	4.98 dBm	5.18 dBm

**Remark:**

1. All the test data for each data rate were verified, but only the worst case was reported.
  2. The data rate was set in 1Mbps for all the test items due to the highest RF output power.
- a. The EUT has been associated with peripherals and configuration operated in a manner tended to maximize its emission characteristics in a typical application. Frequency range investigated: conduction (150 kHz to 30 MHz), radiation (9 kHz to the 10th harmonic of the highest fundamental frequency or to 40 GHz, whichever is lower). Pre-scanned tests, X, Y, Z in three orthogonal panels, and different data rates were conducted to determine the final configuration (Y plane as worst plane) from all possible combinations, and the worst mode of radiated spurious emissions is Bluetooth 1Mbps mode, and recorded in this report.
- b. AC power line Conducted Emission was tested under maximum output power.



## 2.2 Test Mode

The following summary table is showing all test modes to demonstrate in compliance with the standard.

Summary table of Test Cases			
Test Item	Data Rate / Modulation		
	Bluetooth BR 1Mbps GFSK	Bluetooth EDR 2Mbps $\pi/4$ -DQPSK	Bluetooth EDR 3Mbps 8-DPSK
Conducted Test Cases	Mode 1: CH00_2402 MHz	Mode 4: CH00_2402 MHz	Mode 7: CH00_2402 MHz
	Mode 2: CH39_2441 MHz	Mode 5: CH39_2441 MHz	Mode 8: CH39_2441 MHz
	Mode 3: CH78_2480 MHz	Mode 6: CH78_2480 MHz	Mode 9: CH78_2480 MHz
Radiated Test Cases	Bluetooth BR 1Mbps GFSK		
	Mode 1: CH00_2402 MHz		
	Mode 2: CH39_2441 MHz		
	Mode 3: CH78_2480 MHz		
AC Conducted Emission	Mode 1 :GSM850 Idle + Bluetooth Link + WLAN Link + Earphone 1 + USB Cable 1 (Charging from Adapter 1)		
	Mode 2 :GSM850 Idle + Bluetooth Link + WLAN Link + Earphone 2 + USB Cable 2 (Charging from Adapter 2)		
<b>Remark:</b> <ol style="list-style-type: none"> <li>For radiated test cases, the worst mode data rate 1Mbps was reported only, because this data rate has the highest RF output power at preliminary tests, and no other significantly frequencies found in conducted spurious emission.</li> <li>The worst case of conducted emission is mode 1; only the test data of it was reported.</li> <li>For Radiated Test Cases, The tests were performance with Adapter 1, Earphone 1 and USB Cable 1.</li> </ol>			

## 2.3 Connection Diagram of Test System

### <Bluetooth Tx Mode>

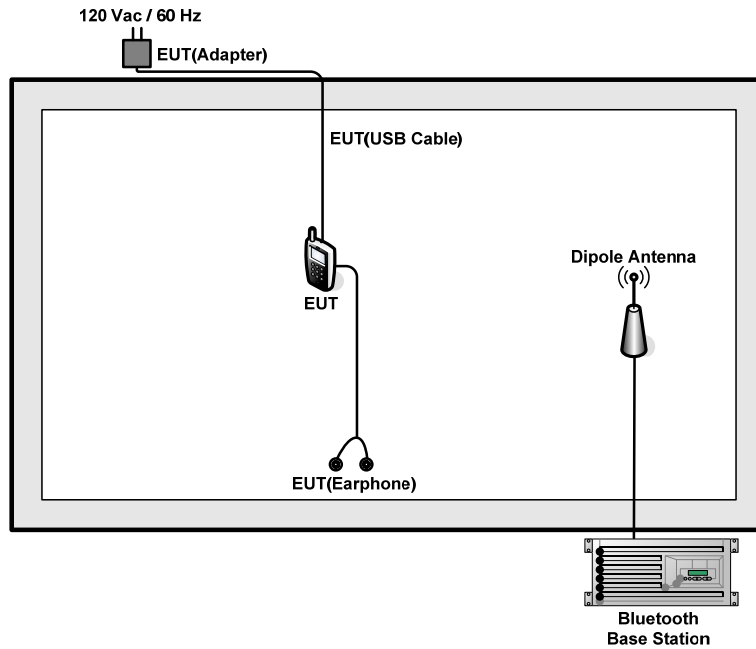

### <AC Conducted Emission Mode>

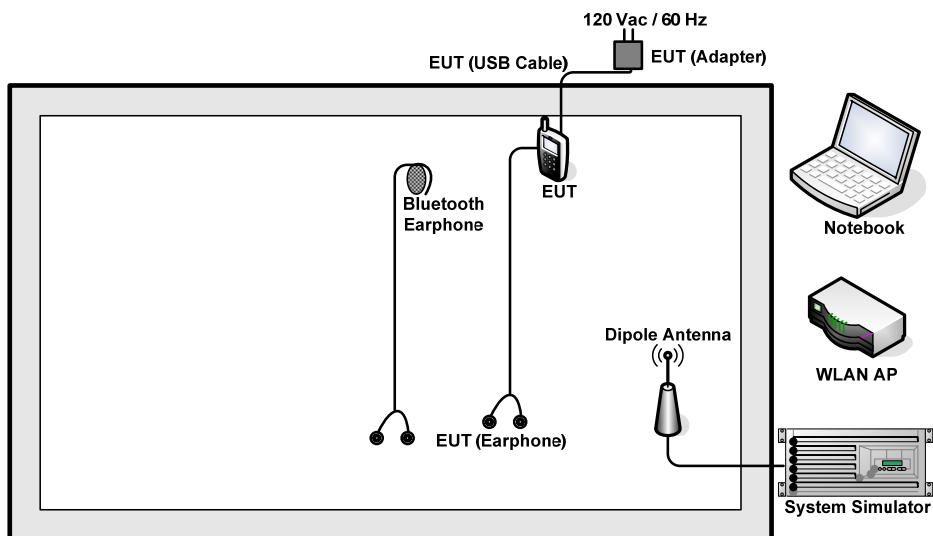

## 2.4 Support Unit used in test configuration and system

Item	Equipment	Trade Name	Model Name	FCC ID	Data Cable	Power Cord
1.	System Simulator	R&S	CMU 200	N/A	N/A	Unshielded, 1.8 m
2.	Bluetooth Base Station	R&S	CBT	N/A	N/A	Unshielded, 1.8 m
3.	WLAN AP	D-Link	DIR-855	KA2DIR855A2	N/A	Unshielded, 1.8 m
4.	Notebook	Lenovo	G480	PRC4	N/A	AC I/P: Unshielded, 1.8 m DC O/P: Shielded, 1.8 m
5.	Bluetooth Earphone	Nokia	BH-102	PYAHS-107W	N/A	N/A

## 2.5 EUT Operation Test Setup

For Bluetooth function, the engineering test program was provided and enabled to make EUT connect with Bluetooth base station to continuous transmit/receive.

For AC power line conducted emissions, the EUT was set to connect with the WLAN AP under large package sizes transmission.

## 2.6 Measurement Results Explanation Example

**For all conducted test items:**

The offset level is set in the spectrum analyzer to compensate the RF cable loss between EUT conducted output port and spectrum analyzer. With the offset compensation, the spectrum analyzer reading level is exactly the EUT RF output level.

Example:

The spectrum analyzer offset is derived from RF cable loss.

*Offset = RF cable loss.*

Following shows an offset computation example with cable loss 5.5 dB.

Offset(dB) = RF cable loss(dB) = 5.5 (dB)

### 3 Test Result

#### 3.1 Number of Channel Measurement

##### 3.1.1 Limits of Number of Hopping Frequency

Frequency hopping systems in the 2400-2483.5 MHz band shall use at least 15 channels.

##### 3.1.2 Measuring Instruments

The measuring equipment is listed in the section 4 of this test report.

##### 3.1.3 Test Procedure

1. The testing follows FCC Public Notice DA 00-705 Measurement Guidelines.
2. The RF output of EUT was connected to the spectrum analyzer by RF cable and attenuator. The path loss was compensated to the results for each measurement.
3. Set to the maximum power setting and enable the EUT transmit continuously.
4. Enable the EUT hopping function.
5. Use the following spectrum analyzer settings: Span = the frequency band of operation; RBW  $\geq$  1% of the span; VBW  $\geq$  RBW; Sweep = auto; Detector function = peak; Trace = max hold.
6. The number of hopping frequency used is defined as the number of total channel.
7. Record the measurement data derived from spectrum analyzer.

##### 3.1.4 Test Setup

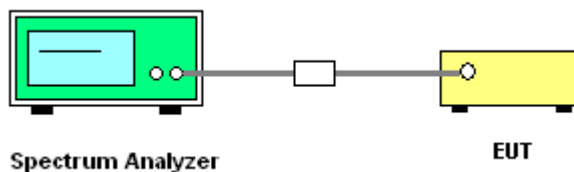

##### 3.1.5 Test Result of Number of Hopping Frequency

Test Mode :	1Mbps	Temperature :	24~25°C
Test Engineer :	Issac Song	Relative Humidity :	49~51%
Number of Hopping (Channel)	Adaptive Frequency Hopping (Channel)	Limits (Channel)	Pass/Fail
79	20	> 15	Pass



Number of Hopping Channel Plot on Channel 00 - 78

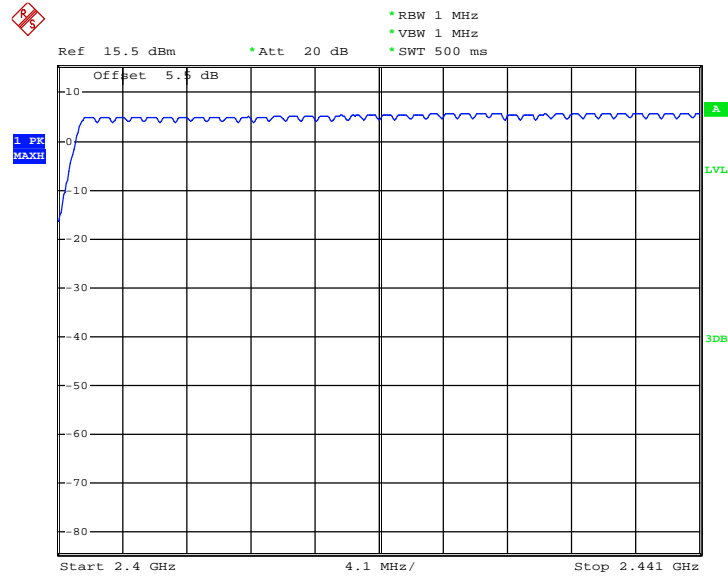

Date: 11.DEC.2014 10:49:31

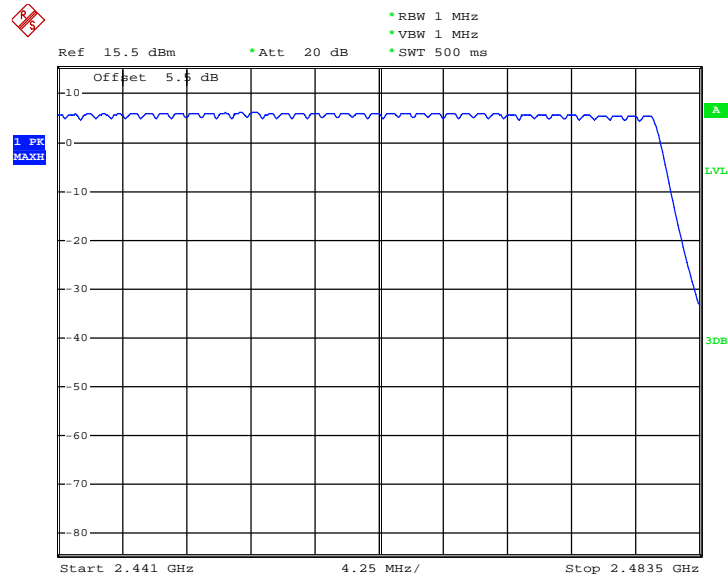

Date: 11.DEC.2014 10:53:43

## 3.2 Hopping Channel Separation Measurement

### 3.2.1 Limit of Hopping Channel Separation

Frequency hopping systems operating in the 2400-2483.5 MHz band may have hopping channel carrier frequencies that are separated by 25 kHz or two-thirds of the 20 dB bandwidth of the hopping channel, whichever is greater.

### 3.2.2 Measuring Instruments

The measuring equipment is listed in the section 4 of this test report.

### 3.2.3 Test Procedures

1. The testing follows FCC Public Notice DA 00-705 Measurement Guidelines.
2. The RF output of EUT was connected to the spectrum analyzer by RF cable and attenuator. The path loss was compensated to the results for each measurement.
3. Set to the maximum power setting and enable the EUT transmit continuously.
4. Enable the EUT hopping function.
5. Use the following spectrum analyzer settings:  
Span = wide enough to capture the peaks of two adjacent channels; RBW  $\geq$  1% of the span;  
VBW  $\geq$  RBW; Sweep = auto; Detector function = peak; Trace = max hold.
6. Measure and record the results in the test report.

### 3.2.4 Test Setup

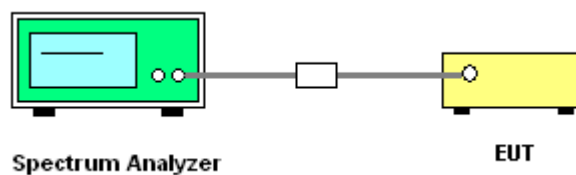



### 3.2.5 Test Result of Hopping Channel Separation

Test Mode :	1Mbps	Temperature :	24~25°C
Test Engineer :	Issac Song	Relative Humidity :	49~51%

Channel	Frequency (MHz)	Frequency Separation (MHz)	(2/3 of 20dB BW) Limits (MHz)	Pass/Fail
00	2402	1.002	0.6480	Pass
39	2441	1.008	0.6507	Pass
78	2480	1.008	0.6320	Pass

Channel Separation Plot on Channel 00 - 01

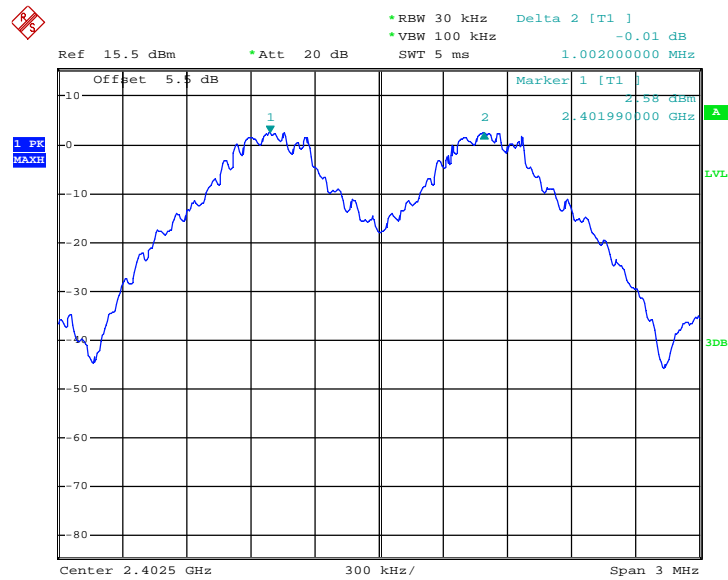

Date: 11.DEC.2014 10:16:55



Channel Separation Plot on Channel 39 - 40

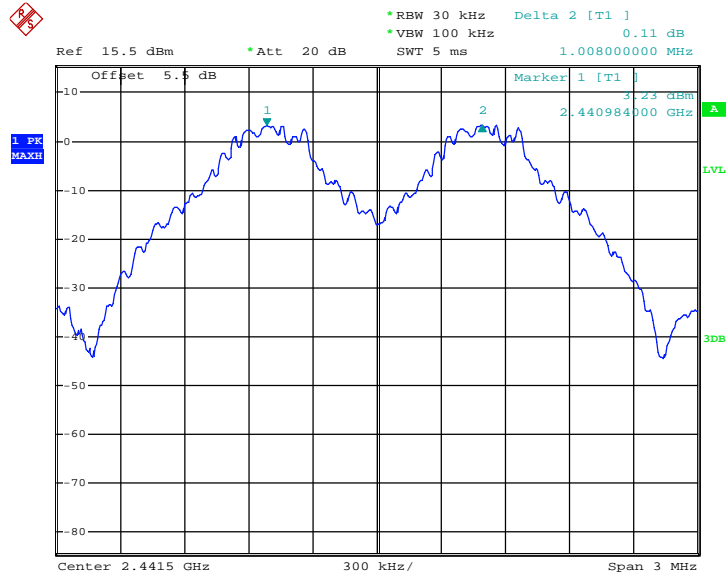

Date: 11.DEC.2014 10:17:37

Channel Separation Plot on Channel 77 - 78

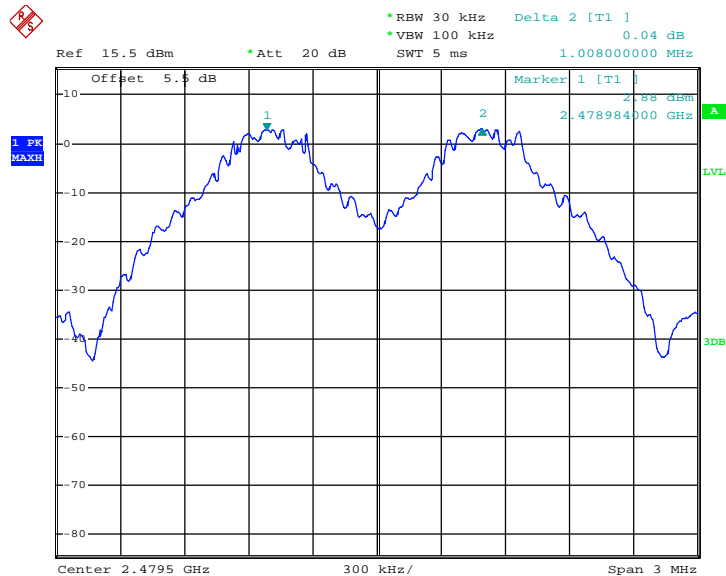

Date: 11.DEC.2014 10:19:09





Test Mode :	2Mbps	Temperature :	24~25°C
Test Engineer :	Issac Song	Relative Humidity :	49~51%

Channel	Frequency (MHz)	Frequency Separation (MHz)	(2/3 of 20dB BW) Limits (MHz)	Pass/Fail
00	2402	1.008	0.8440	Pass
39	2441	1.002	0.8440	Pass
78	2480	1.002	0.8160	Pass

Channel Separation Plot on Channel 00 - 01

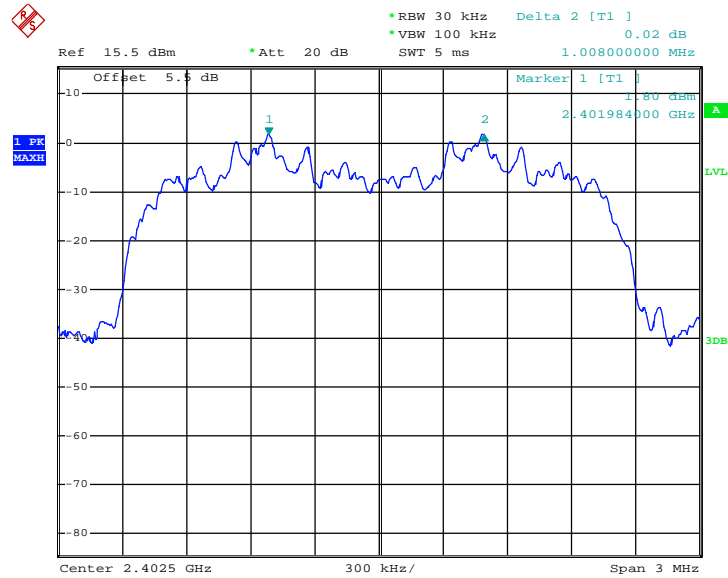

Date: 11.DEC.2014 10:20:36



Channel Separation Plot on Channel 39 - 40

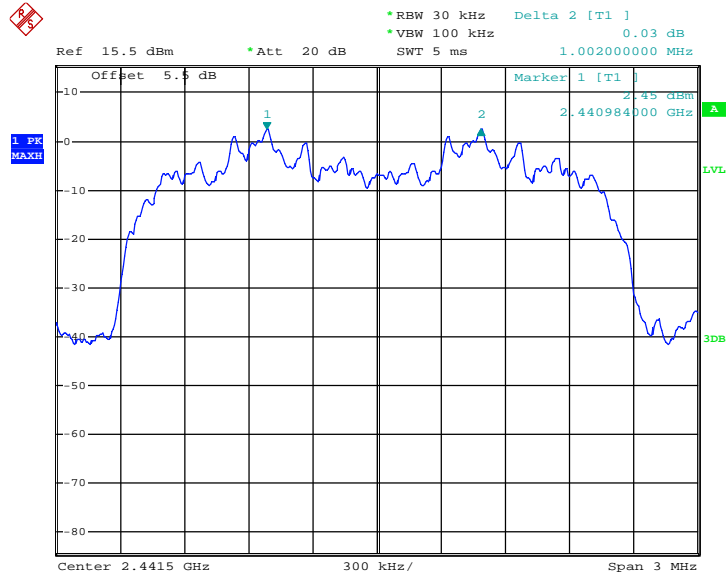

Date: 11.DEC.2014 10:21:32

Channel Separation Plot on Channel 77 - 78

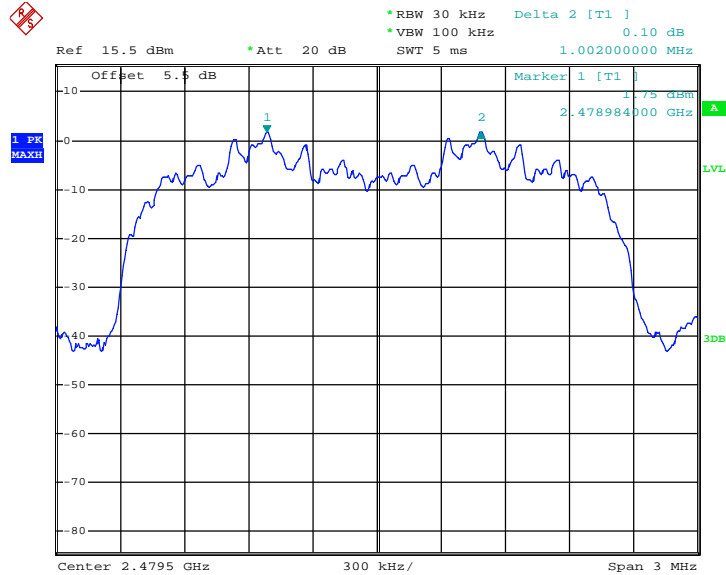

Date: 11.DEC.2014 10:23:49



Test Mode :	3Mbps	Temperature :	24~25°C
Test Engineer :	Issac Song	Relative Humidity :	49~51%

Channel	Frequency (MHz)	Frequency Separation (MHz)	(2/3 of 20dB BW) Limits (MHz)	Pass/Fail
00	2402	1.002	0.8280	Pass
39	2441	1.008	0.8320	Pass
78	2480	1.002	0.8320	Pass

Channel Separation Plot on Channel 00 - 01

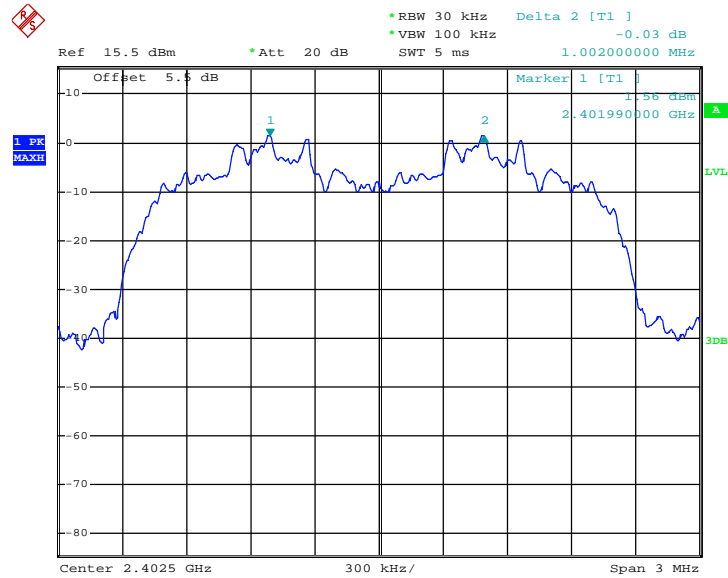

Date: 11.DEC.2014 10:24:46



Channel Separation Plot on Channel 39 - 40

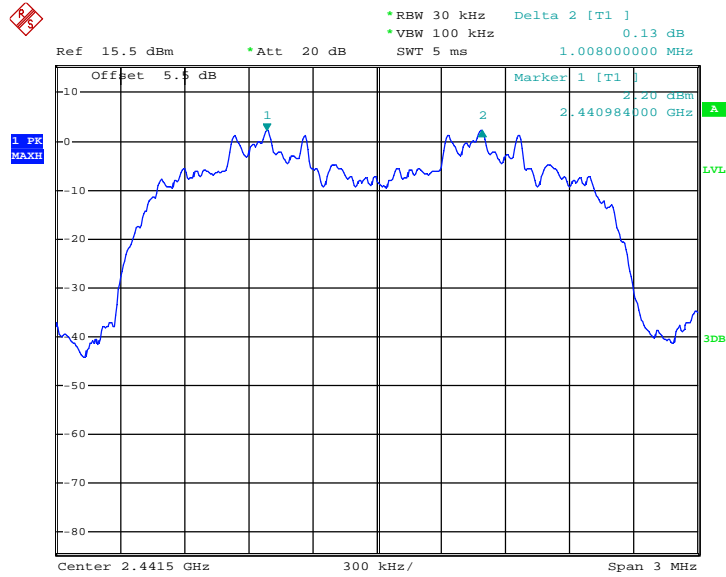

Date: 11.DEC.2014 10:25:32

Channel Separation Plot on Channel 77 - 78

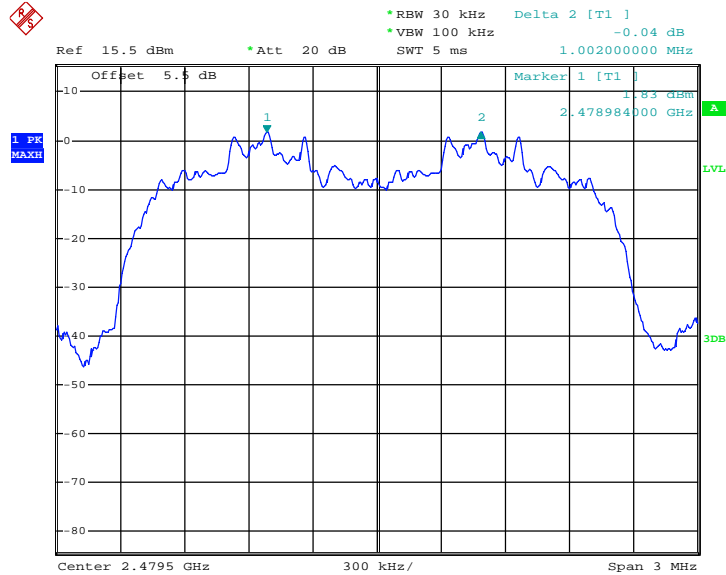

Date: 11.DEC.2014 10:26:56

### 3.3 Dwell Time Measurement

#### 3.3.1 Limit of Dwell Time

The average time of occupancy on any channel shall not be greater than 0.4 seconds within a period of 0.4 seconds multiplied by the number of hopping channels employed.

#### 3.3.2 Measuring Instruments

The measuring equipment is listed in the section 4 of this test report.

#### 3.3.3 Test Procedures

1. The testing follows FCC Public Notice DA 00-705 Measurement Guidelines.
2. The RF output of EUT was connected to the spectrum analyzer by RF cable and attenuator. The path loss was compensated to the results for each measurement.
3. Set to the maximum power setting and enable the EUT transmit continuously.
4. Enable the EUT hopping function.
5. Use the following spectrum analyzer settings: Span = zero span, centered on a hopping channel; RBW = 1 MHz; VBW  $\geq$  RBW; Sweep = as necessary to capture the entire dwell time per hopping channel; Detector function = peak; Trace = max hold.
6. Measure and record the results in the test report.

#### 3.3.4 Test Setup

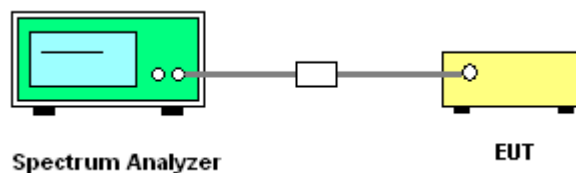



3.3.5 Test Result of Dwell Time

Test Mode :	DH5	Temperature :	24~25°C
Test Engineer :	Issac Song	Relative Humidity :	49~51%

Mode	Hopping Channel Number	Hops Over Occupancy Time(hops)	Package Transfer Time (msec)	Dwell Time (sec)	Limits (sec)	Pass/Fail
Normal	79	106.67	2.882	0.31	0.4	Pass
AFH	20	53.33	2.882	0.15	0.4	Pass

Remark:

- In normal mode, hopping rate is 1600 hops/s with 6 slots in 79 hopping channels.  
With channel hopping rate (1600 / 6 / 79) in Occupancy Time Limit (0.4 x 79) (s),  
Hops Over Occupancy Time comes to (1600 / 6 / 79) x (0.4 x 79) = 106.67 hops.
- In AFH mode, hopping rate is 800 hops/s with 6 slots in 20 hopping channels.  
With channel hopping rate (800 / 6 / 20) in Occupancy Time Limit (0.4 x 20) (s),  
Hops Over Occupancy Time comes to (800 / 6 / 20) x (0.4 x 20) = 53.33 hops.
- Dwell Time(s) = Hops Over Occupancy Time (hops) x Package Transfer Time



Package Transfer Time Plot

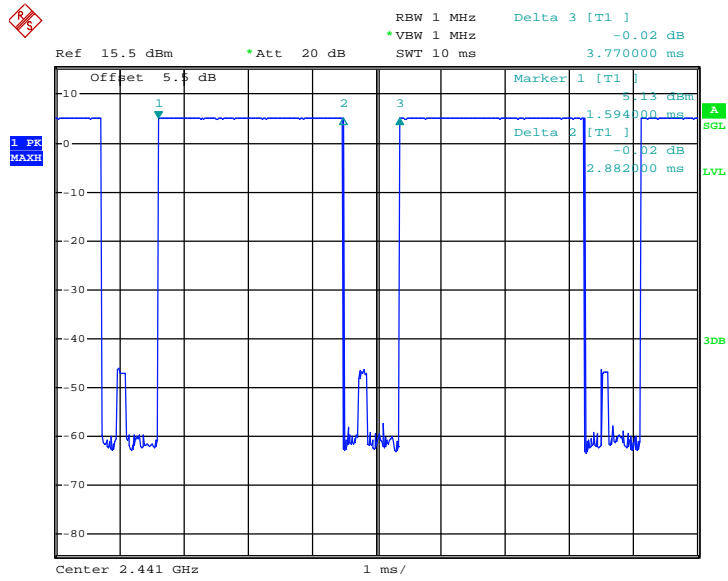

Date: 10.DEC.2014 17:32:59

### 3.4 20dB Bandwidth Measurement

#### 3.4.1 Limit of 20dB Bandwidth

Reporting only

#### 3.4.2 Measuring Instruments

The measuring equipment is listed in the section 4 of this test report.

#### 3.4.3 Test Procedures

1. The testing follows FCC Public Notice DA 00-705 Measurement Guidelines.
2. The RF output of EUT was connected to the spectrum analyzer by RF cable and attenuator. The path loss was compensated to the results for each measurement.
3. Set to the maximum power setting and enable the EUT transmit continuously.
4. Use the following spectrum analyzer settings for 20dB Bandwidth measurement.  
Span = approximately 2 to 3 times the 20 dB bandwidth, centered on a hopping channel;  
RBW  $\geq$  1% of the 20 dB bandwidth; VBW  $\geq$  RBW; Sweep = auto; Detector function = peak;  
Trace = max hold.
5. Measure and record the results in the test report.

#### 3.4.4 Test Setup

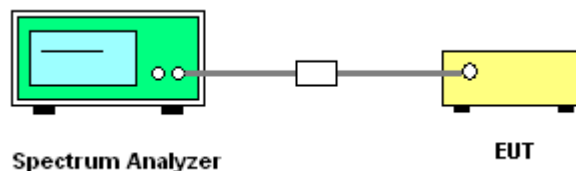





### 3.4.5 Test Result of 20dB Bandwidth

Test Mode :	1Mbps	Temperature :	24~25°C
Test Engineer :	Issac Song	Relative Humidity :	49~51%

Channel	Frequency (MHz)	20dB Bandwidth (MHz)
00	2402	0.972
39	2441	0.976
78	2480	0.948

20 dB Bandwidth Plot on Channel 00

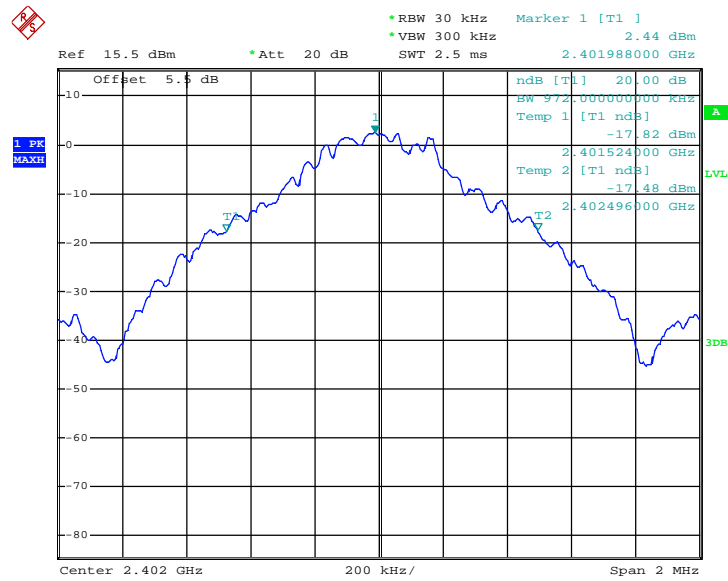

Date: 11.DEC.2014 10:27:27



20 dB Bandwidth Plot on Channel 39

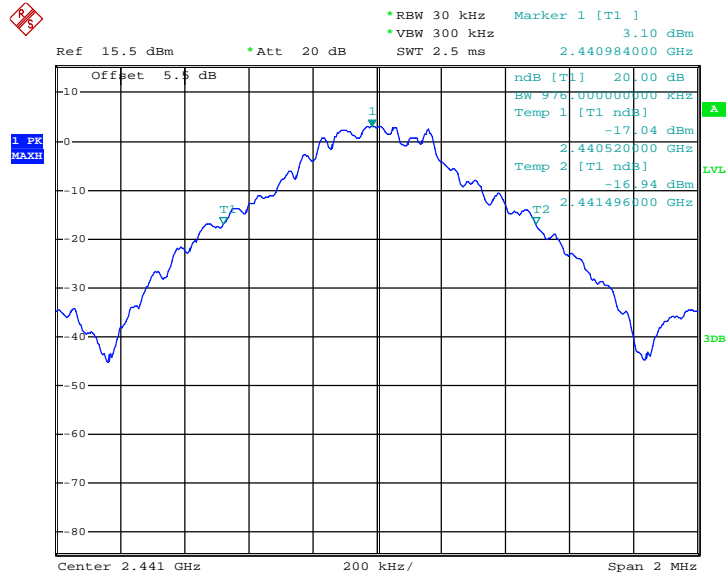

Date: 11.DEC.2014 10:27:50

20 dB Bandwidth Plot on Channel 78

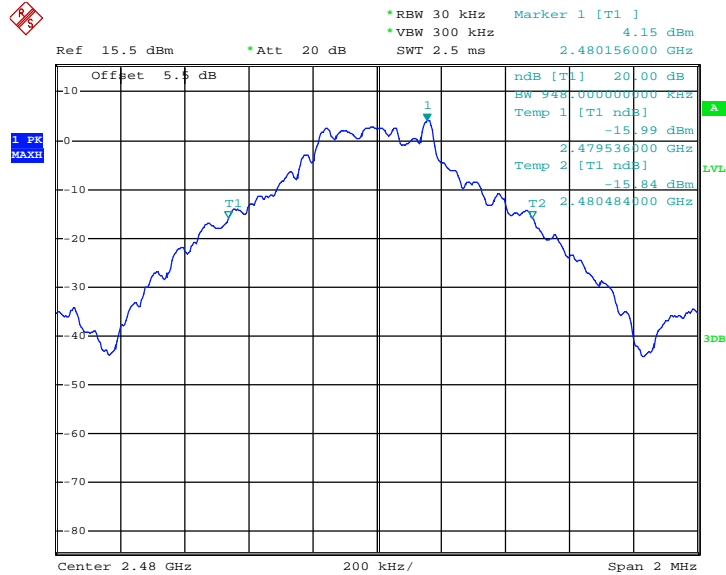

Date: 11.DEC.2014 10:28:16



Test Mode :	2Mbps	Temperature :	24~25°C
Test Engineer :	Issac Song	Relative Humidity :	49~51%

Channel	Frequency (MHz)	20dB Bandwidth (MHz)
00	2402	1.266
39	2441	1.266
78	2480	1.224

20 dB Bandwidth Plot on Channel 00

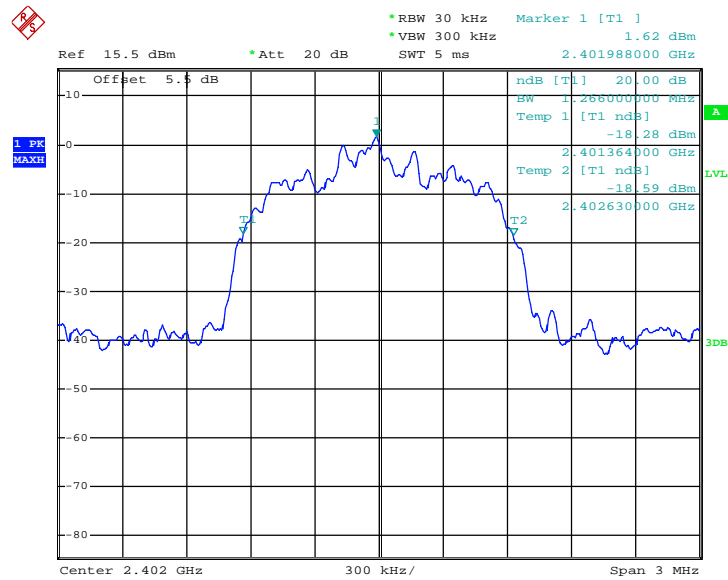

Date: 11.DEC.2014 10:28:35



20 dB Bandwidth Plot on Channel 39

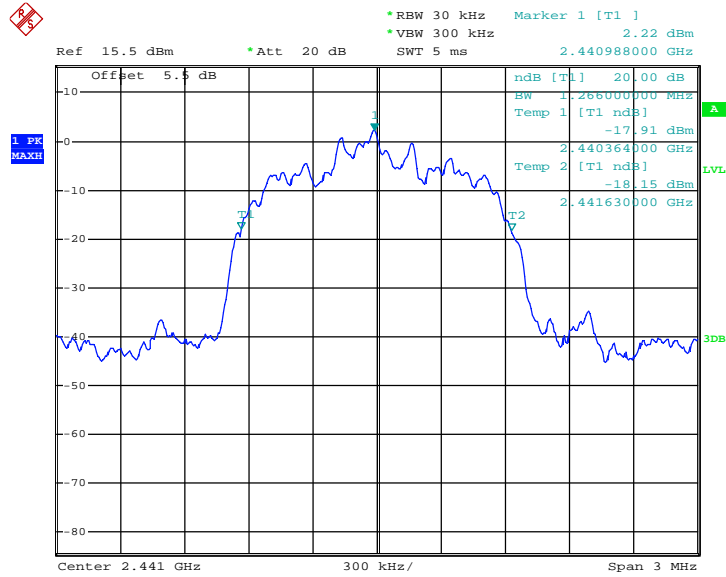

Date: 11.DEC.2014 10:28:51

20 dB Bandwidth Plot on Channel 78

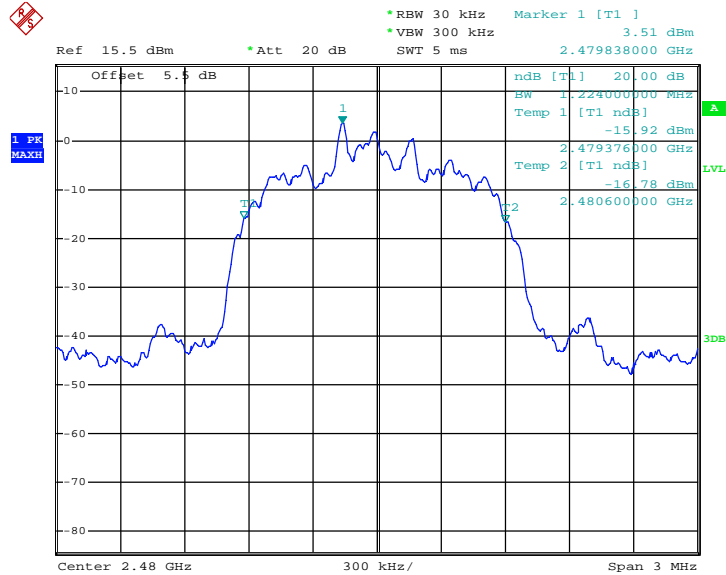

Date: 11.DEC.2014 10:29:15



Test Mode :	3Mbps	Temperature :	24~25°C
Test Engineer :	Issac Song	Relative Humidity :	49~51%

Channel	Frequency (MHz)	20dB Bandwidth (MHz)
00	2402	1.242
39	2441	1.248
78	2480	1.248

20 dB Bandwidth Plot on Channel 00

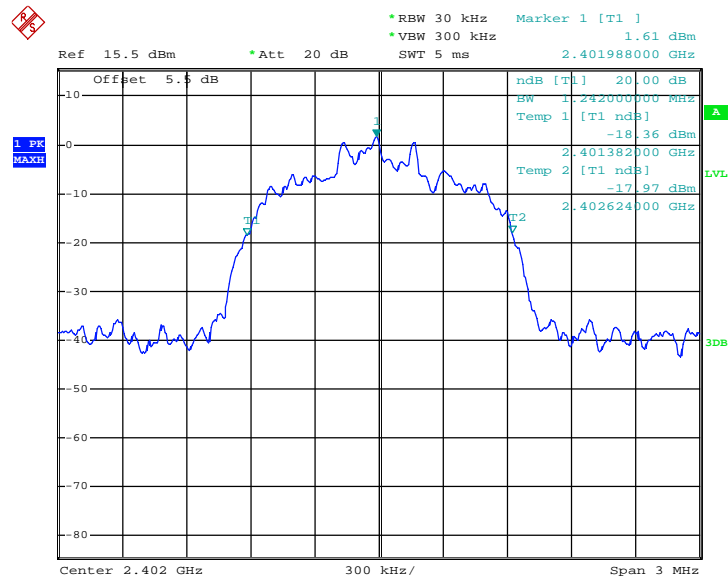

Date: 11.DEC.2014 10:29:32



20 dB Bandwidth Plot on Channel 39

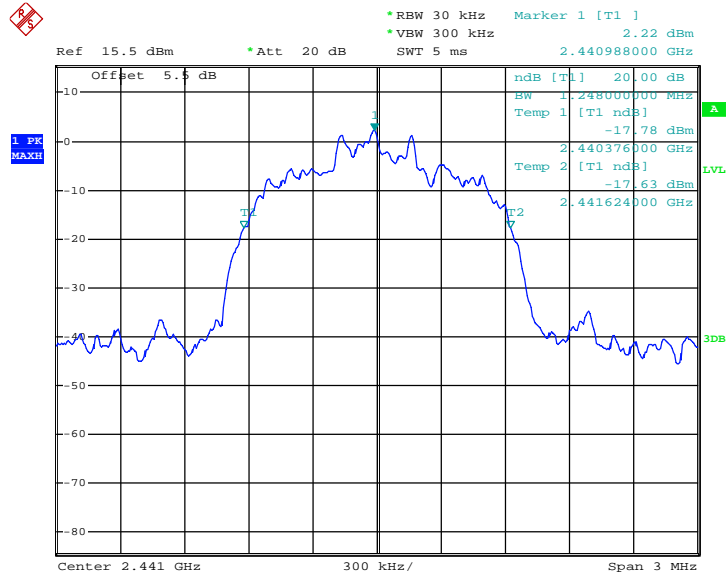

Date: 11.DEC.2014 10:29:51

20 dB Bandwidth Plot on Channel 78

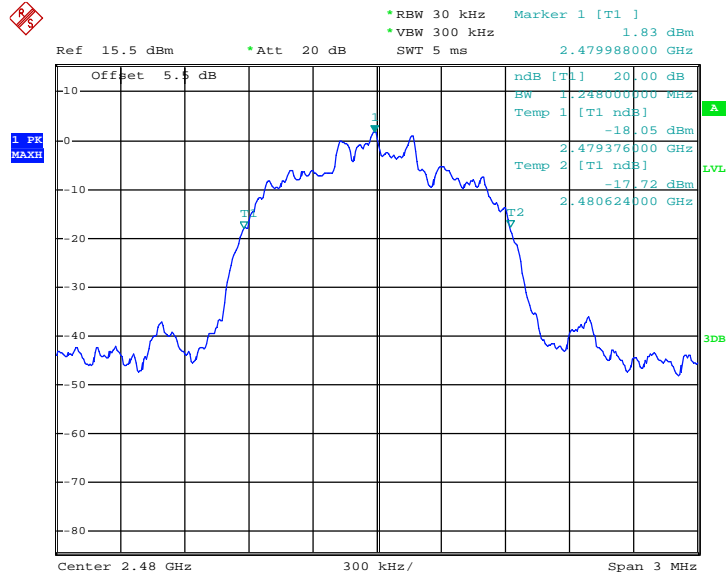

Date: 11.DEC.2014 10:30:15

### 3.5 Peak Output Power Measurement

#### 3.5.1 Limit of Peak Output Power

Section 15.247 (b) The maximum peak conducted output power of the intentional radiator shall not exceed the following: (1) For frequency hopping systems operating in the 2400-2483.5 MHz band employing at least 75 non-overlapping hopping channels, and all frequency hopping systems in the 5725-5850 MHz band: 1 watt. For all other frequency hopping systems in the 2400-2483.5 MHz band 0.125 watts.

#### 3.5.2 Measuring Instruments

The measuring equipment is listed in the section 4 of this test report.

#### 3.5.3 Test Procedures

1. The testing follows FCC Public Notice DA 00-705 Measurement Guidelines.
2. The RF output of EUT was connected to the power meter by RF cable and attenuator. The path loss was compensated to the results for each measurement.
3. Set to the maximum power setting and enable the EUT transmit continuously.
4. Measure the conducted output power with cable loss and record the results in the test report.
5. Measure and record the results in the test report.

#### 3.5.4 Test Setup

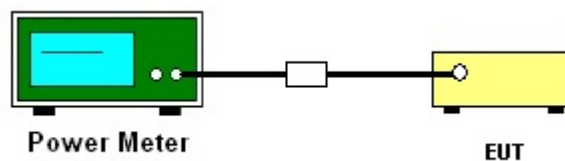



3.5.5 Test Result of Peak Output Power

Test Mode :	1Mbps	Temperature :	24~25°C
Test Engineer :	Issac Song	Relative Humidity :	49~51%

Channel	Frequency (MHz)	RF Power (dBm)		
		GFSK	Max. Limits (dBm)	Pass/Fail
		1 Mbps		
00	2402	4.51	20.97	Pass
39	2441	5.47	20.97	Pass
78	2480	5.12	20.97	Pass

Test Mode :	2Mbps	Temperature :	24~25°C
Test Engineer :	Issac Song	Relative Humidity :	49~51%

Channel	Frequency (MHz)	RF Power (dBm)		
		$\pi/4$ -DQPSK	Max. Limits (dBm)	Pass/Fail
		2 Mbps		
00	2402	4.37	20.97	Pass
39	2441	5.29	20.97	Pass
78	2480	4.98	20.97	Pass

Test Mode :	3Mbps	Temperature :	24~25°C
Test Engineer :	Issac Song	Relative Humidity :	49~51%

Channel	Frequency (MHz)	RF Power (dBm)		
		8-DPSK	Max. Limits (dBm)	Pass/Fail
		3 Mbps		
00	2402	4.60	20.97	Pass
39	2441	5.44	20.97	Pass
78	2480	5.18	20.97	Pass



## 3.6 Conducted Band Edges Measurement

### 3.6.1 Limit of Band Edges

In any 100 kHz bandwidth outside the intentional radiation frequency band, the radio frequency power shall be at least 20 dB below the highest level of the radiated power. In addition, radiated emissions which fall in the restricted bands must also comply with the radiated emission limits.

### 3.6.2 Measuring Instruments

The measuring equipment is listed in the section 4 of this test report.

### 3.6.3 Test Procedures

1. The testing follows the guidelines in Band-edge Compliance of RF Conducted Emissions of FCC Public Notice DA 00-705 Measurement Guidelines.
2. Set to the maximum power setting and enable the EUT transmit continuously.
3. Set RBW = 100kHz ( $\geq 1\%$  span=10MHz ), VBW = 300kHz ( $\geq$  RBW). Band edge emissions must be at least 20 dB down from the highest emission level within the authorized band as measured with a 100kHz RBW. The attenuation shall be 30 dB instead of 20 dB when RMS conducted output power procedure is used.
4. Enable hopping function of the EUT and then repeat step 2. and 3.
5. Measure and record the results in the test report.

### 3.6.4 Test Setup

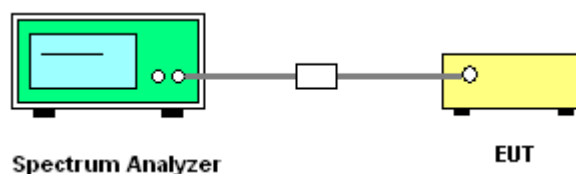



### 3.6.5 Test Result of Conducted Band Edges

Test Mode :	1Mbps	Temperature :	24~25°C
Test Channel :	00 and 78	Relative Humidity :	49~51%
		Test Engineer :	Issac Song

Low Band Edge Plot on Channel 00

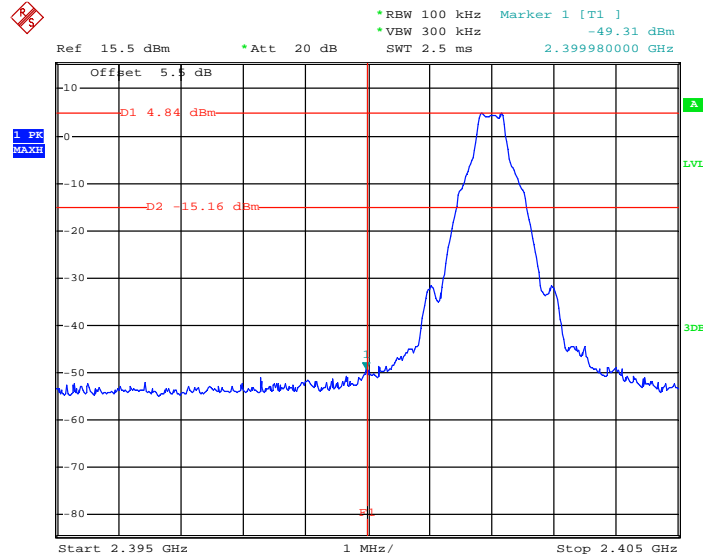

Date: 11.DEC.2014 10:31:09

High Band Edge Plot on Channel 78

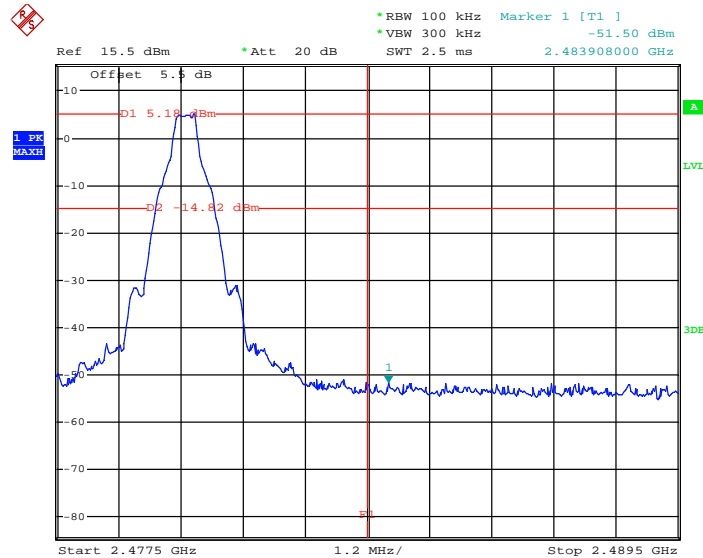

Date: 11.DEC.2014 10:32:01



Test Mode :	2Mbps	Temperature :	24~25°C
Test Channel :	00 and 78	Relative Humidity :	49~51%
		Test Engineer :	Issac Song

Low Band Edge Plot on Channel 00

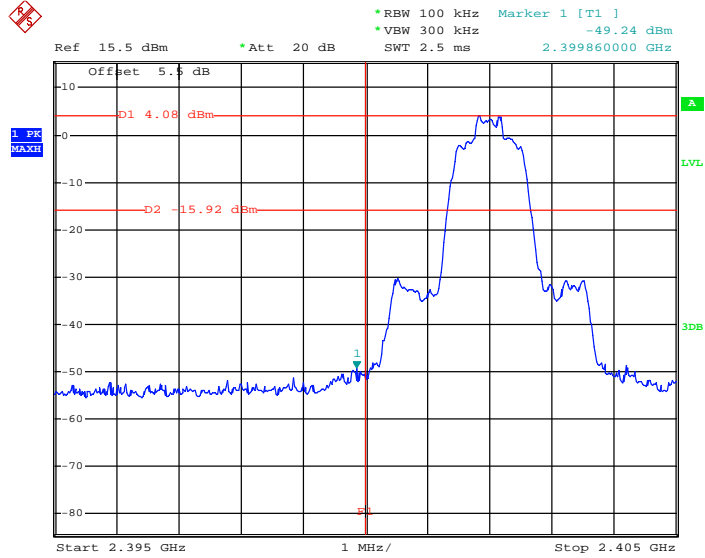

Date: 11,DEC.2014 10:32:52

High Band Edge Plot on Channel 78

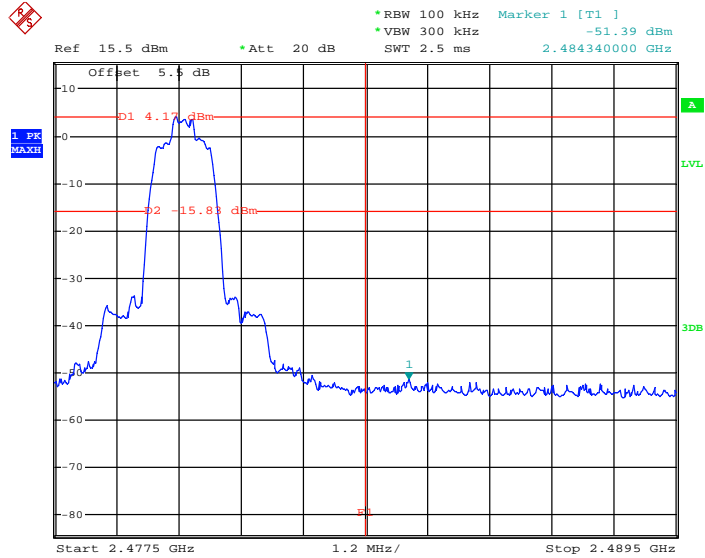

Date: 11,DEC.2014 10:33:44



Test Mode :	3Mbps	Temperature :	24~25°C
Test Channel :	00 and 78	Relative Humidity :	49~51%
		Test Engineer :	Issac Song

Low Band Edge Plot on Channel 00

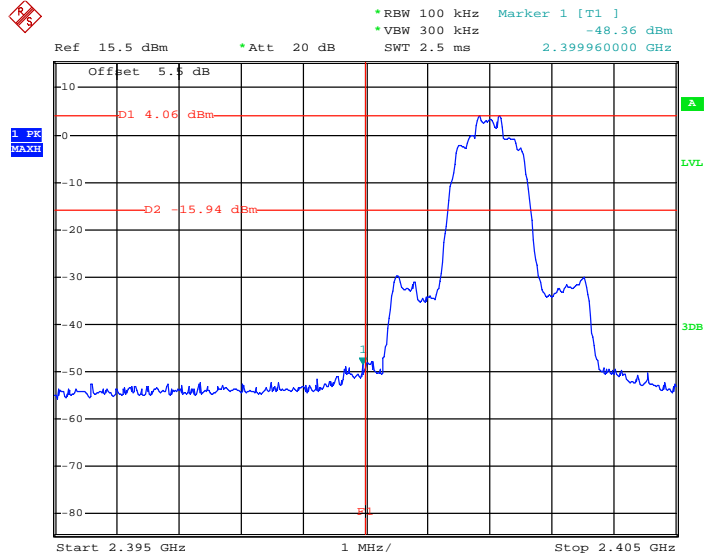

Date: 11,DEC.2014 10:34:36

High Band Edge Plot on Channel 78

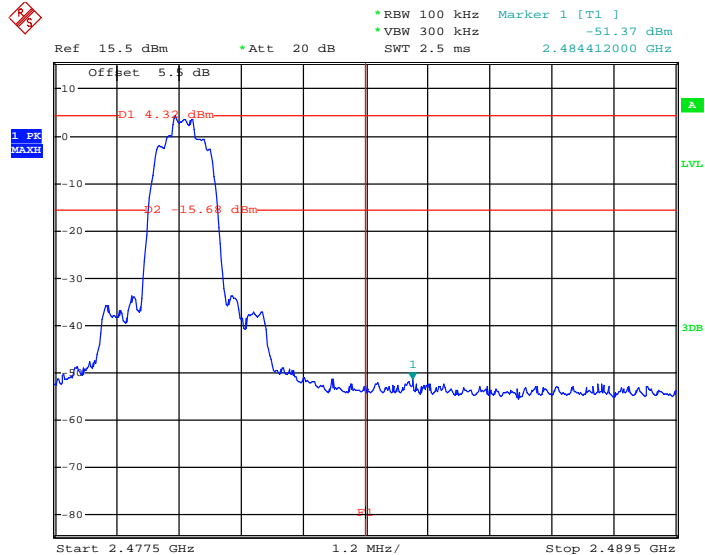

Date: 11,DEC.2014 10:35:27



### 3.6.6 Test Result of Conducted Hopping Mode Band Edges

Test Mode :	1Mbps	Temperature :	24~25°C
Test Engineer :	Issac Song	Relative Humidity :	49~51%

#### 1Mbps Hopping Mode Low Band Edge Plot

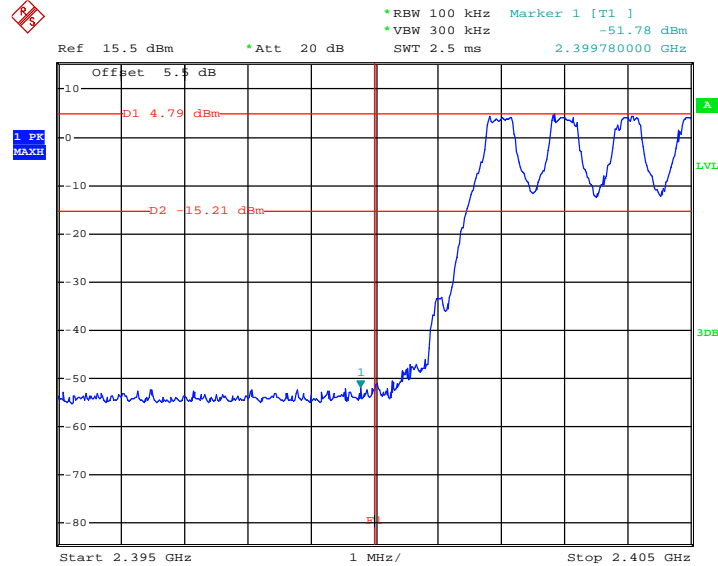

Date: 11.DEC.2014 11:26:45

#### 1Mbps Hopping Mode High Band Edge Plot

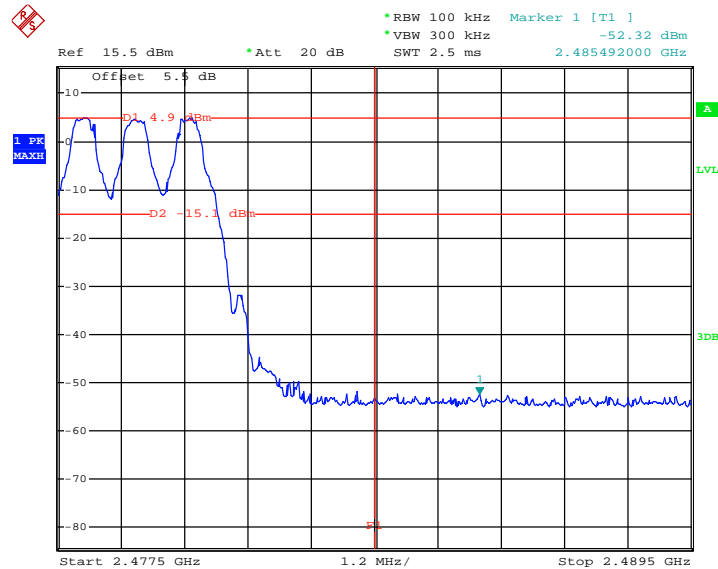

Date: 11.DEC.2014 11:28:25



Test Mode :	2Mbps	Temperature :	24~25°C
Test Engineer :	Issac Song	Relative Humidity :	49~51%

2Mbps Hopping Mode Low Band Edge Plot

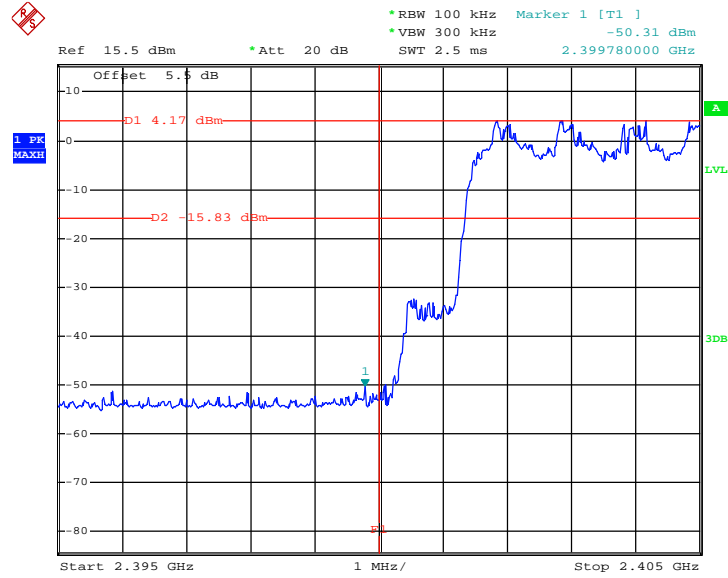

Date: 11.DEC.2014 11:34:29

2Mbps Hopping Mode High Band Edge Plot

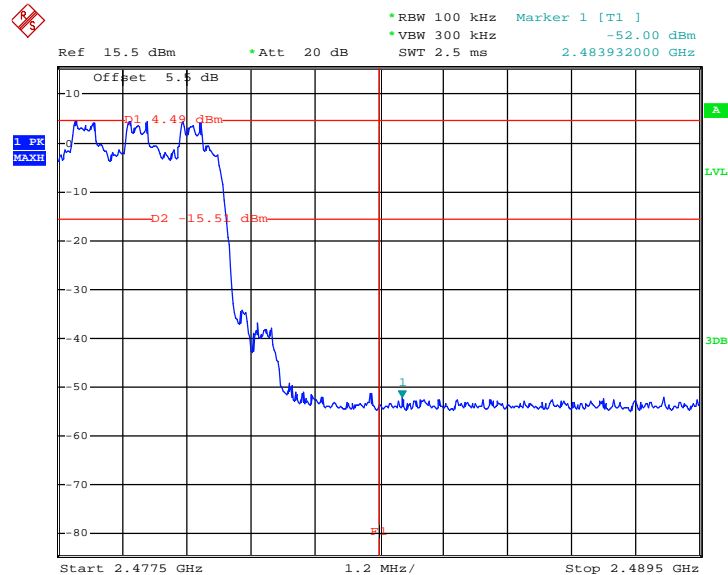

Date: 11.DEC.2014 11:31:02



Test Mode :	3Mbps	Temperature :	24~25°C
Test Engineer :	Issac Song	Relative Humidity :	49~51%

### 3Mbps Hopping Mode Low Band Edge Plot

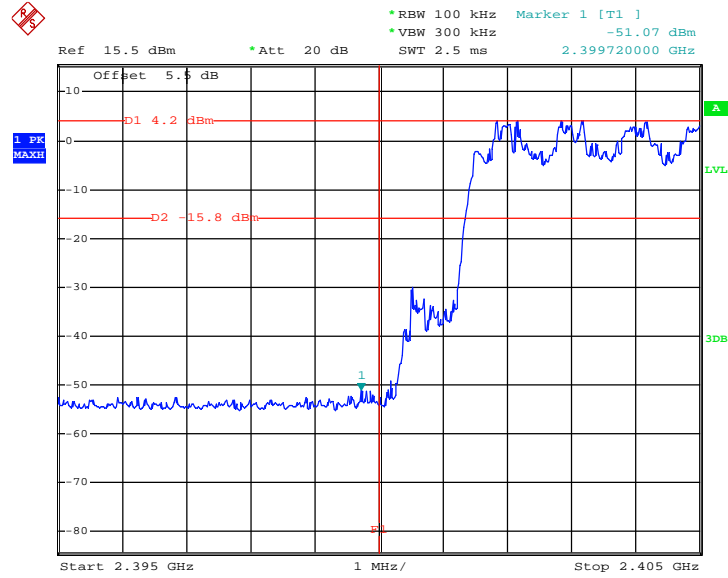

Date: 11.DEC.2014 11:43:32

### 3Mbps Hopping Mode High Band Edge Plot

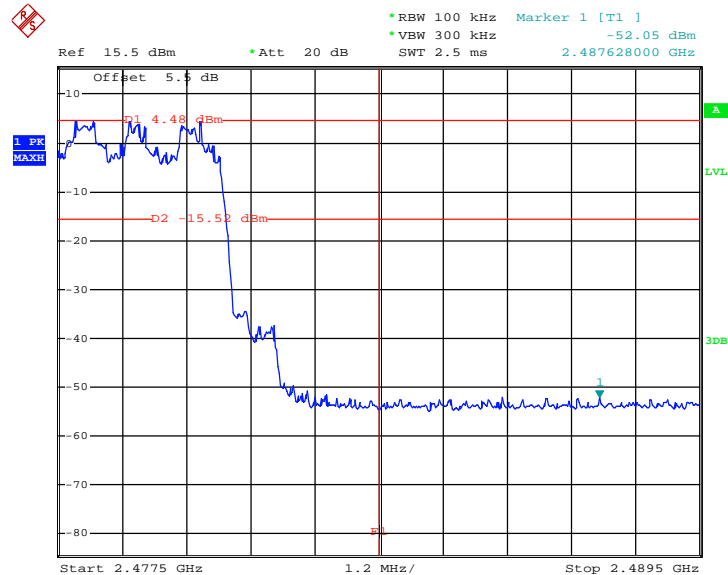

Date: 11.DEC.2014 11:41:05

## 3.7 Conducted Spurious Emission Measurement

### 3.7.1 Limit of Spurious Emission Measurement

In any 100 kHz bandwidth outside the intentional radiation frequency band, the radio frequency power shall be at least 20 dB below the highest level of the radiated power. In addition, radiated emissions which fall in the restricted bands must also comply with the radiated emission limits.

### 3.7.2 Measuring Instruments

The measuring equipment is listed in the section 4 of this test report.

### 3.7.3 Test Procedure

1. The testing follows the guidelines in Spurious RF Conducted Emissions of FCC Public Notice DA 00-705 Measurement Guidelines
2. The RF output of EUT was connected to the spectrum analyzer by RF cable and attenuator. The path loss was compensated to the results for each measurement.
3. Set to the maximum power setting and enable the EUT transmit continuously.
4. Set RBW = 100 kHz, VBW = 300kHz, scan up through 10th harmonic. All harmonics / spurs must be at least 20 dB down from the highest emission level within the authorized band as measured with a 100 kHz RBW.
5. Measure and record the results in the test report.
6. The RF fundamental frequency should be excluded against the limit line in the operating frequency band.

### 3.7.4 Test Setup

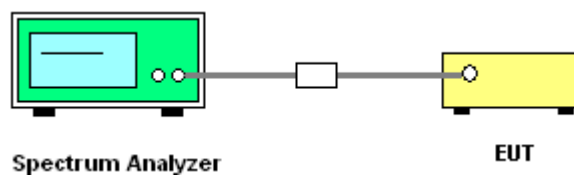





### 3.7.5 Test Result of Conducted Spurious Emission

Test Mode :	1Mbps	Temperature :	24~25°C
Test Channel :	00	Relative Humidity :	49~51%
		Test Engineer :	Issac Song

1Mbps CSE Plot on Ch 00 between 30MHz ~ 3 GHz

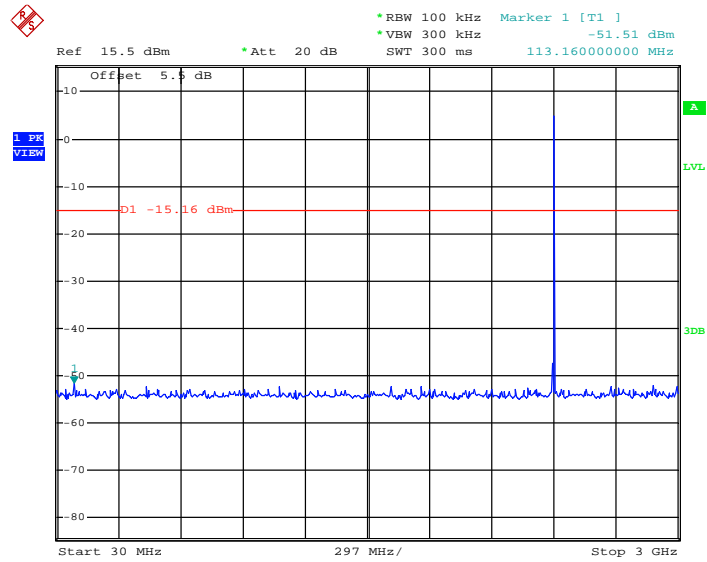

Date: 11.DEC.2014 10:41:48

1Mbps CSE Plot on Ch 00 between 2 GHz ~ 25 GHz

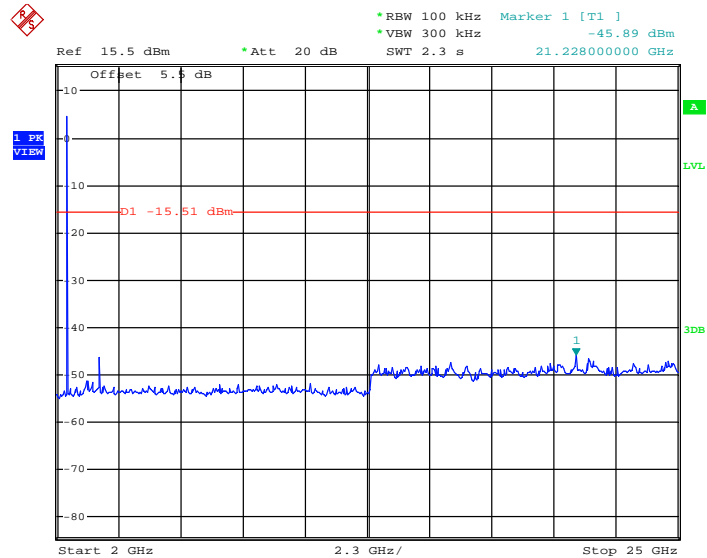

Date: 11.DEC.2014 10:42:40



Test Mode :	1Mbps	Temperature :	24~25°C
Test Channel :	39	Relative Humidity :	49~51%
		Test Engineer :	Issac Song

1Mbps CSE Plot on Ch 39 between 30MHz ~ 3 GHz

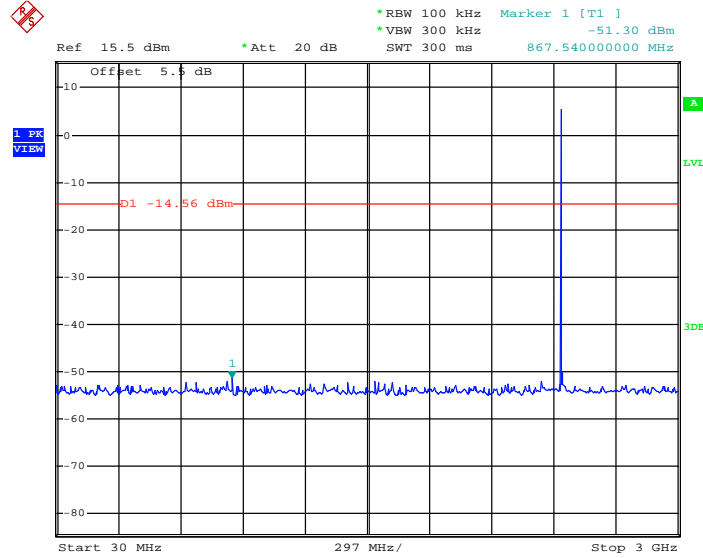

Date: 11,DEC.2014 10:43:32

1Mbps CSE Plot on Ch 39 between 2 GHz ~ 25 GHz

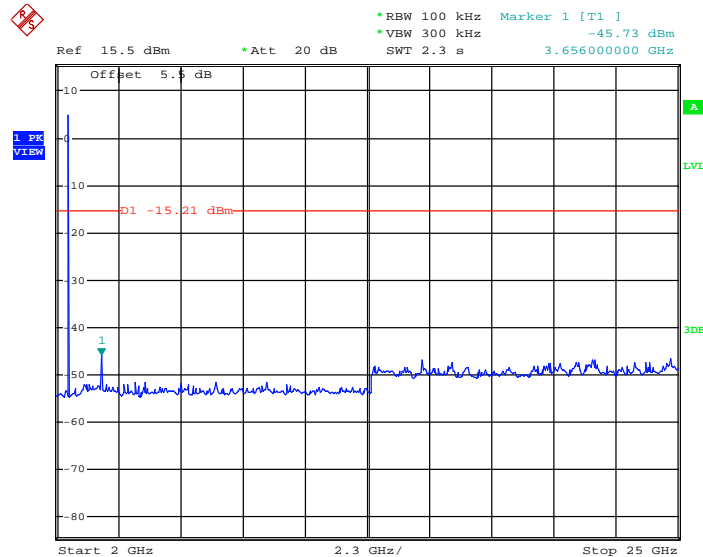

Date: 11,DEC.2014 10:44:24



Test Mode :	1Mbps	Temperature :	24~25°C
Test Channel :	78	Relative Humidity :	49~51%
		Test Engineer :	Issac Song

1Mbps CSE Plot on Ch 78 between 30MHz ~ 3 GHz

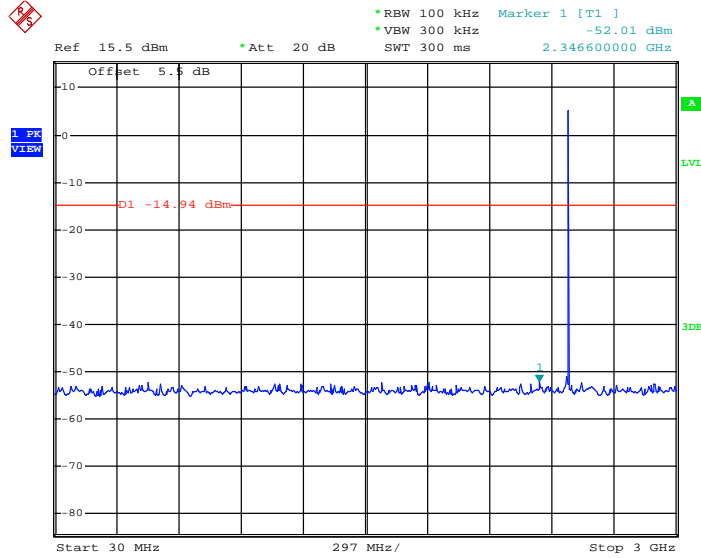

Date: 11,DEC.2014 10:45:16

1Mbps CSE Plot on Ch 78 between 2 GHz ~ 25 GHz

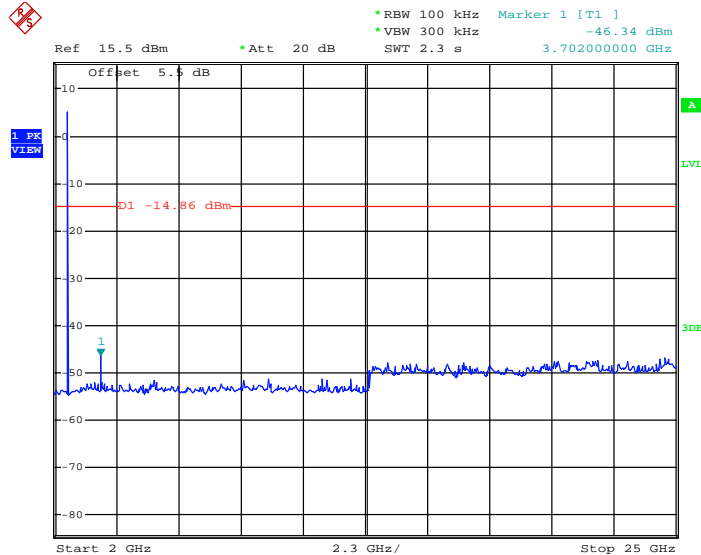

Date: 11,DEC.2014 10:46:08



Test Mode :	2Mbps	Temperature :	24~25°C
Test Channel :	00	Relative Humidity :	49~51%
		Test Engineer :	Issac Song

2Mbps CSE Plot on Ch 00 between 30MHz ~ 3 GHz

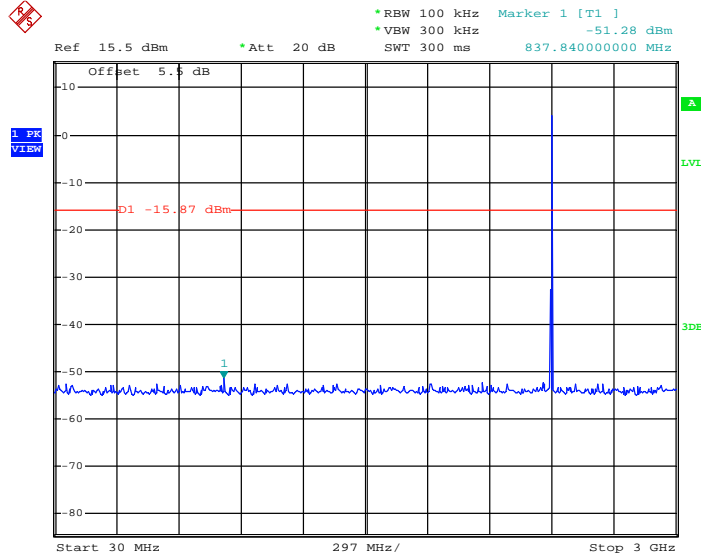

Date: 11,DEC.2014 10:55:33

2Mbps CSE Plot on Ch 00 between 2 GHz ~ 25 GHz

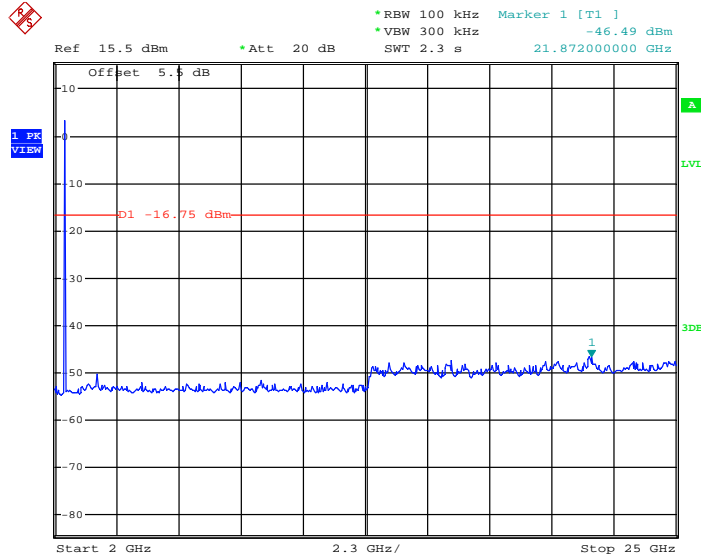

Date: 11,DEC.2014 10:56:25



Test Mode :	2Mbps	Temperature :	24~25°C
Test Channel :	39	Relative Humidity :	49~51%
		Test Engineer :	Issac Song

2Mbps CSE Plot on Ch 39 between 30MHz ~ 3 GHz

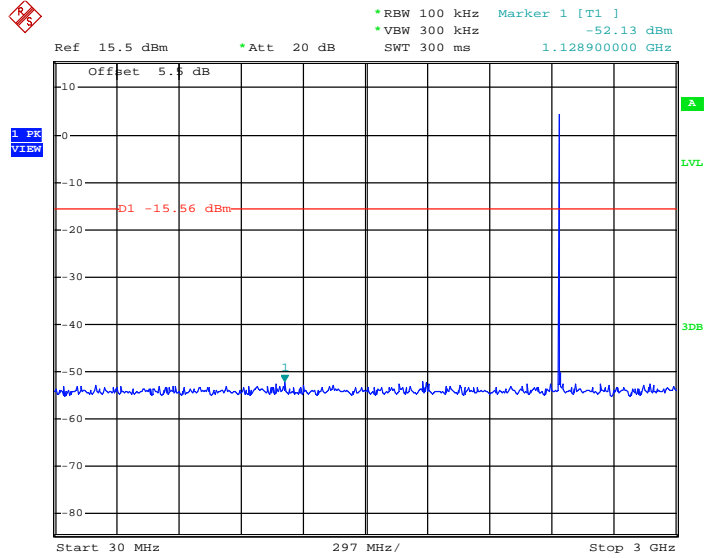

Date: 11.DEC.2014 10:57:17

2Mbps CSE Plot on Ch 39 between 2 GHz ~ 25 GHz

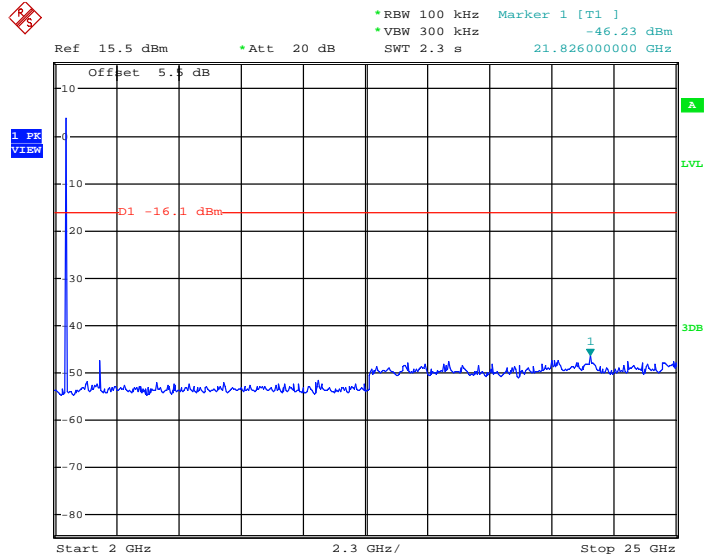

Date: 11.DEC.2014 10:58:09



Test Mode :	2Mbps	Temperature :	24~25°C
Test Channel :	78	Relative Humidity :	49~51%
		Test Engineer :	Issac Song

2Mbps CSE Plot on Ch 78 between 30MHz ~ 3 GHz

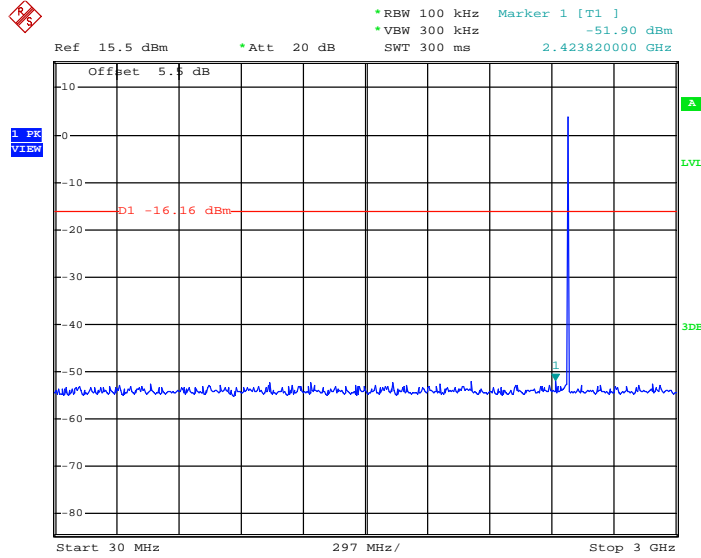

Date: 11.DEC.2014 10:59:01

2Mbps CSE Plot on Ch 78 between 2 GHz ~ 25 GHz

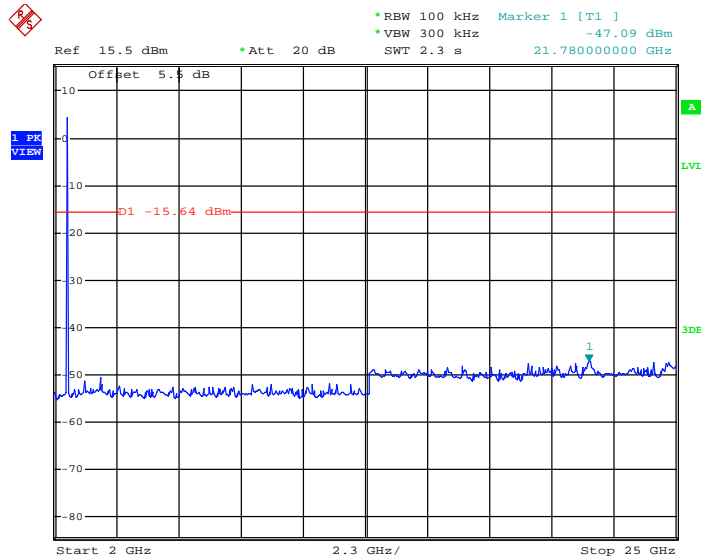

Date: 11.DEC.2014 11:24:39



Test Mode :	3Mbps	Temperature :	24~25°C
Test Channel :	00	Relative Humidity :	49~51%
		Test Engineer :	Issac Song

3Mbps CSE Plot on Ch 00 between 30MHz ~ 3 GHz

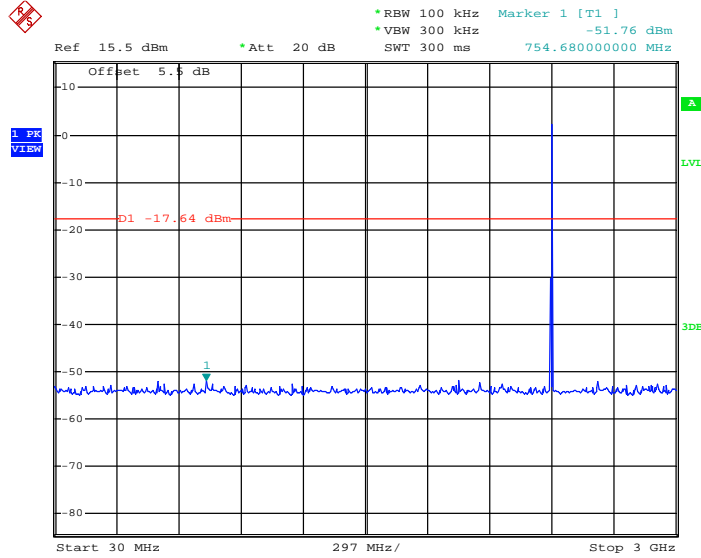

Date: 11.DEC.2014 11:01:35

3Mbps CSE Plot on Ch 00 between 2 GHz ~ 25 GHz

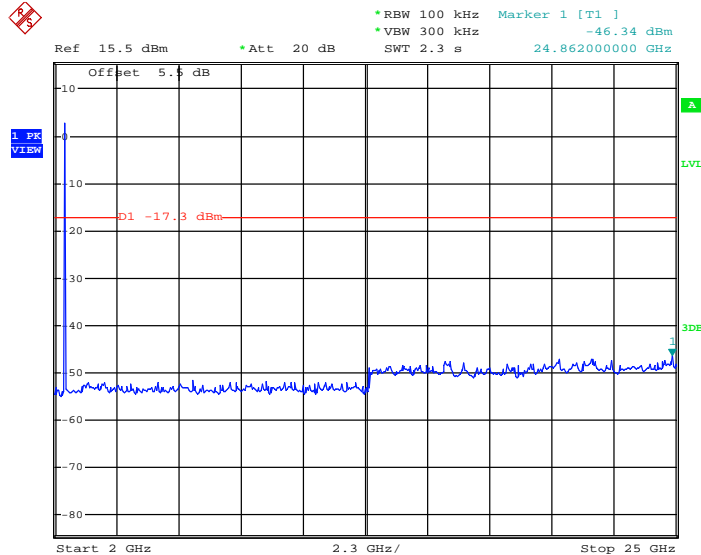

Date: 11.DEC.2014 11:08:09



Test Mode :	3Mbps	Temperature :	24~25°C
Test Channel :	39	Relative Humidity :	49~51%
		Test Engineer :	Issac Song

3Mbps CSE Plot on Ch 39 between 30MHz ~ 3 GHz

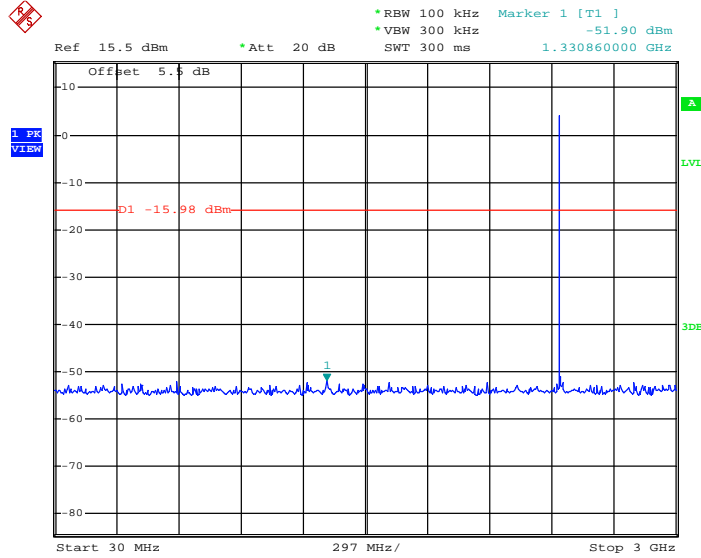

Date: 11,DEC.2014 11:03:18

3Mbps CSE Plot on Ch 39 between 2 GHz ~ 25 GHz

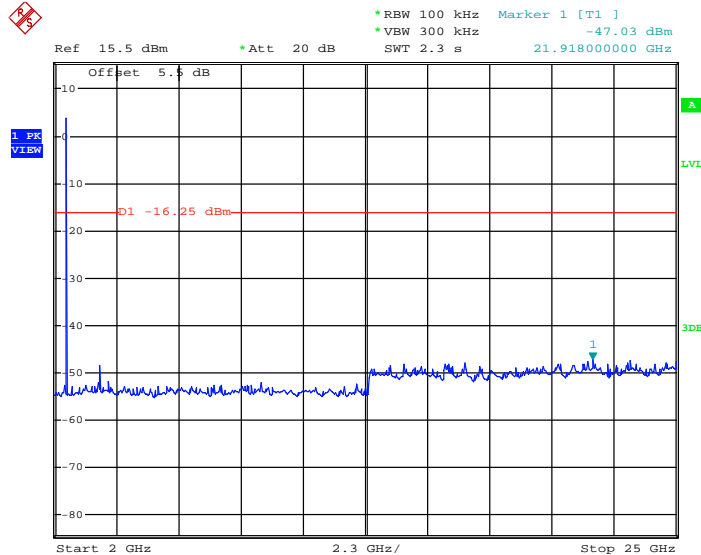

Date: 11,DEC.2014 11:21:49





Test Mode :	3Mbps	Temperature :	24~25°C
Test Channel :	78	Relative Humidity :	49~51%
		Test Engineer :	Issac Song

3Mbps CSE Plot on Ch 78 between 30MHz ~ 3 GHz

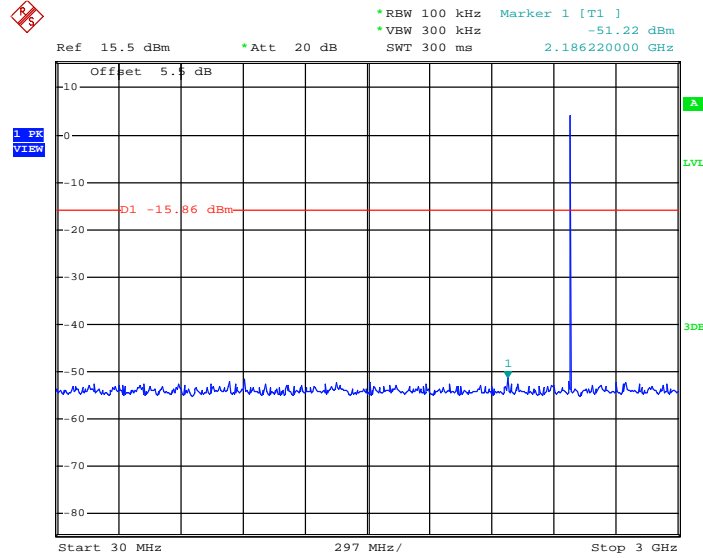

Date: 11,DEC.2014 11:05:02

3Mbps CSE Plot on Ch 78 between 2 GHz ~ 25 GHz

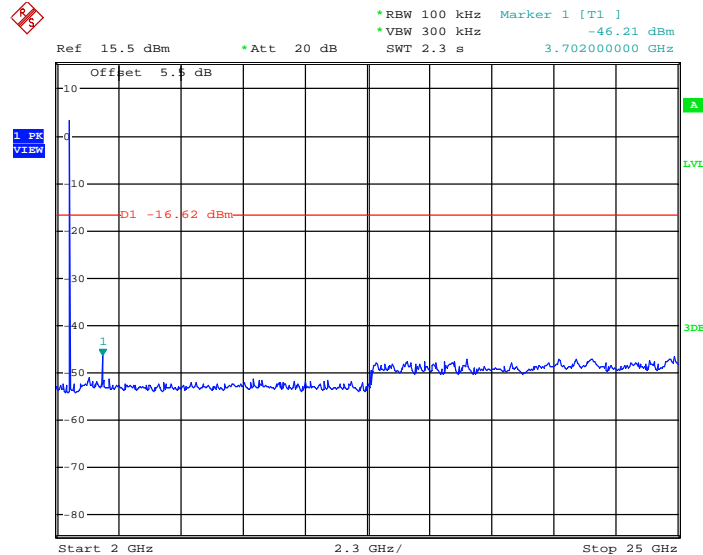

Date: 11,DEC.2014 11:19:28



### 3.8 Radiated Band Edges and Spurious Emission Measurement

#### 3.8.1 Limit of Radiated Band Edges and Spurious Emission

In any 100 kHz bandwidth outside the intentional radiator frequency band, all harmonics/spurious must be at least 20 dB below the highest emission level within the authorized band. In addition, radiated emissions which fall in the restricted bands must also comply with the FCC section 15.209 limits as below.

Frequency (MHz)	Field Strength (microvolts/meter)	Measurement Distance (meters)
0.009 – 0.490	2400/F(kHz)	300
0.490 – 1.705	24000/F(kHz)	30
1.705 – 30.0	30	30
30 – 88	100	3
88 – 216	150	3
216 - 960	200	3
Above 960	500	3

#### 3.8.2 Measuring Instruments

The measuring equipment is listed in the section 4 of this test report.



### 3.8.3 Test Procedures

1. The testing follows the guidelines in Spurious Radiated Emissions of FCC Public Notice DA 00-705 Measurement Guidelines.
2. The EUT was placed on a turntable with 0.8 meter above ground.
3. The EUT was set 3 meters from the interference receiving antenna, which was mounted on the top of a variable height antenna tower.
4. For each suspected emission, the EUT was arranged to its worst case and then tune the Antenna tower (from 1 m to 4 m) and turntable (from 0 degree to 360 degrees) to find the maximum reading. A pre-amp and a high pass filter are used for the test in order to get better signal level to comply with the guidelines.
5. Set to the maximum power setting and enable the EUT transmit continuously.
6. Use the following spectrum analyzer settings:
  - (1) Span shall wide enough to fully capture the emission being measured;
  - (2) Set RBW=100 kHz for  $f < 1$  GHz, RBW=1MHz for  $f > 1$ GHz ; VBW  $\geq$  RBW; Sweep = auto; Detector function = peak; Trace = max hold for peak
  - (3) For average measurement: use duty cycle correction factor method per 15.35(c).  
Duty cycle = On time/100 milliseconds  
On time =  $N_1 * L_1 + N_2 * L_2 + \dots + N_{n-1} * L_{n-1} + N_n * L_n$   
Where  $N_1$  is number of type 1 pulses,  $L_1$  is length of type 1 pulses, etc.  
Average Emission Level = Peak Emission Level +  $20 * \log(\text{Duty cycle})$
7. Corrected Reading: Antenna Factor + Cable Loss + Read Level - Preamp Factor = Level

Note: The average levels were calculated from the peak level corrected with duty cycle correction factor (-24.79dB) derived from  $20 \log(\text{dwell time}/100\text{ms})$ . This correction is only for signals that hop with the fundamental signal, such as band-edge and harmonic. Other spurious signals that are independent of the hopping signal would not use this correction.

### 3.8.4 Test Setup

For radiated emissions below 30MHz

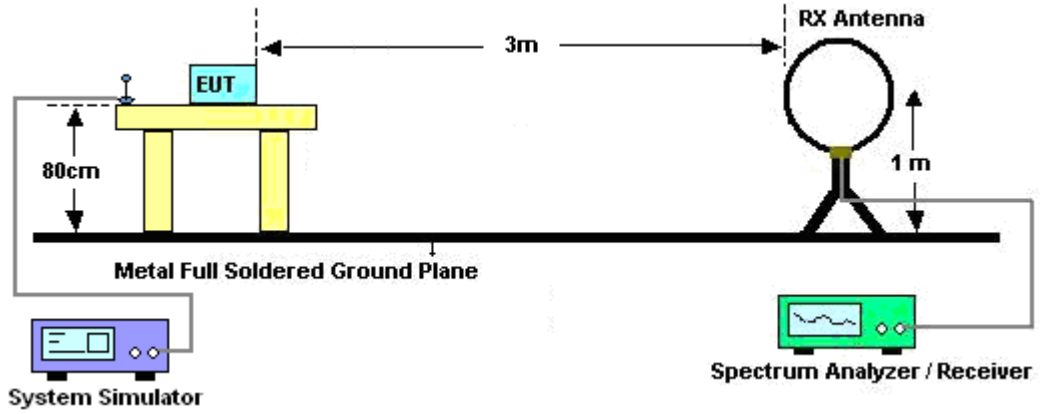

For radiated emissions from 30MHz to 1GHz

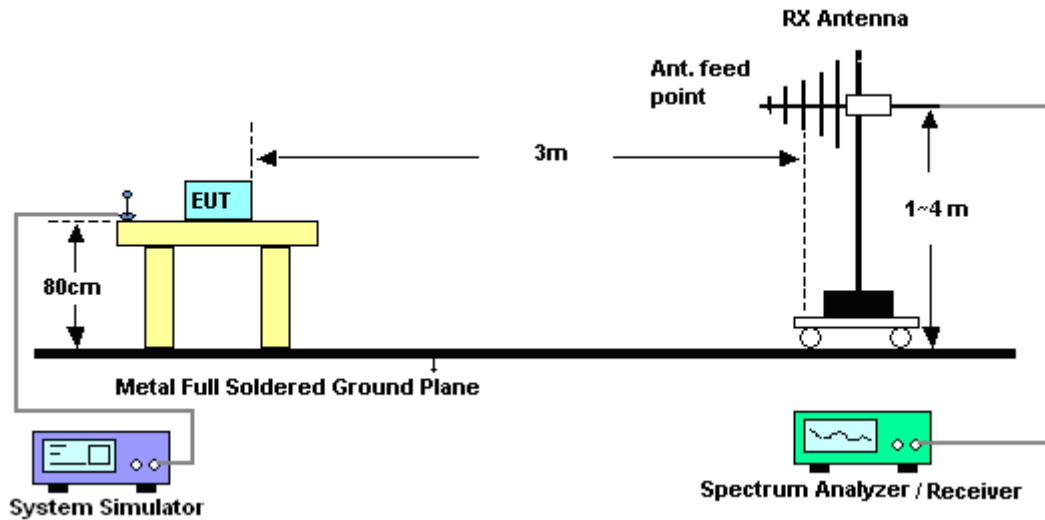

For radiated emissions above 1GHz

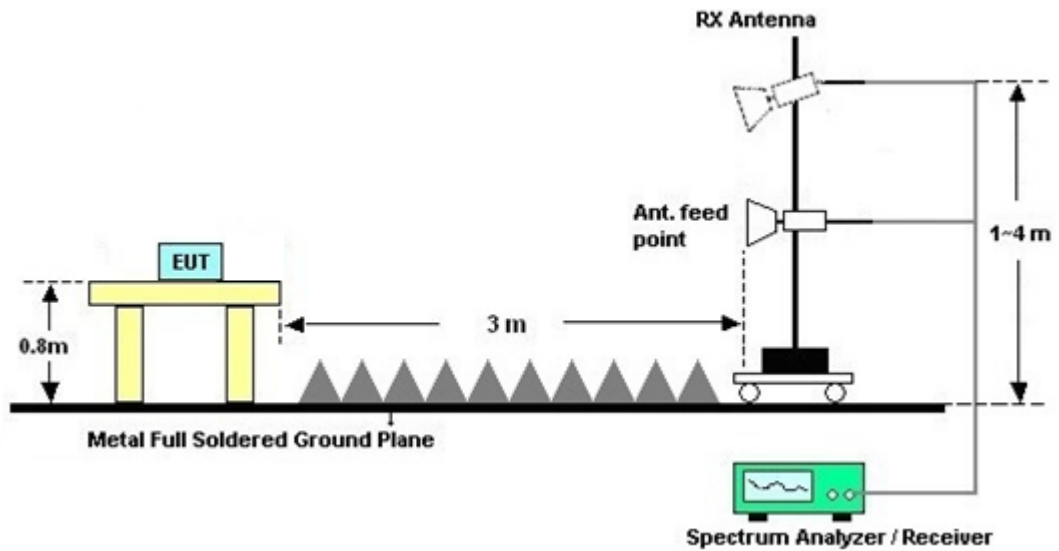

### 3.8.5 Test Results of Radiated Spurious Emissions (9 kHz ~ 30 MHz)

The low frequency, which started from 9 kHz to 30MHz, was pre-scanned and the result which was 20dB lower than the limit line per 15.31(o) was not reported.

### 3.8.6 Duty cycle correction factor for average measurement

DH5 on time (One Pulse) Plot on Channel 39

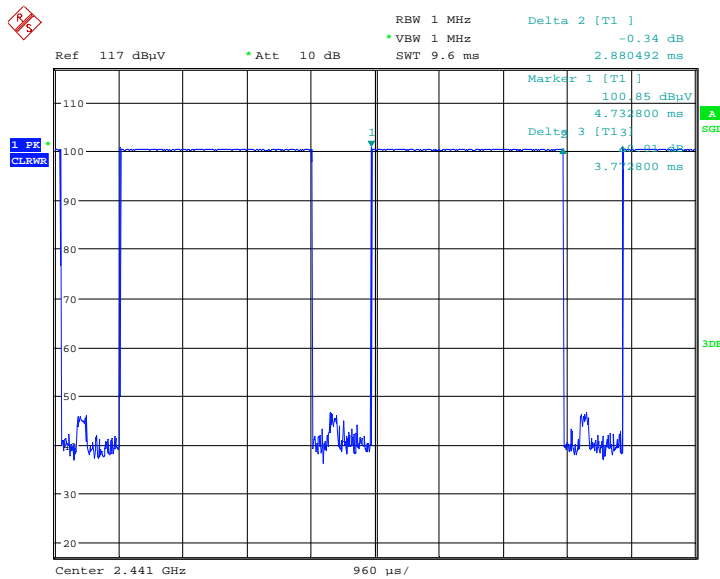

Date: 2.JAN.2015 05:40:59

DH5 on time (Count Pulses) Plot on Channel 39

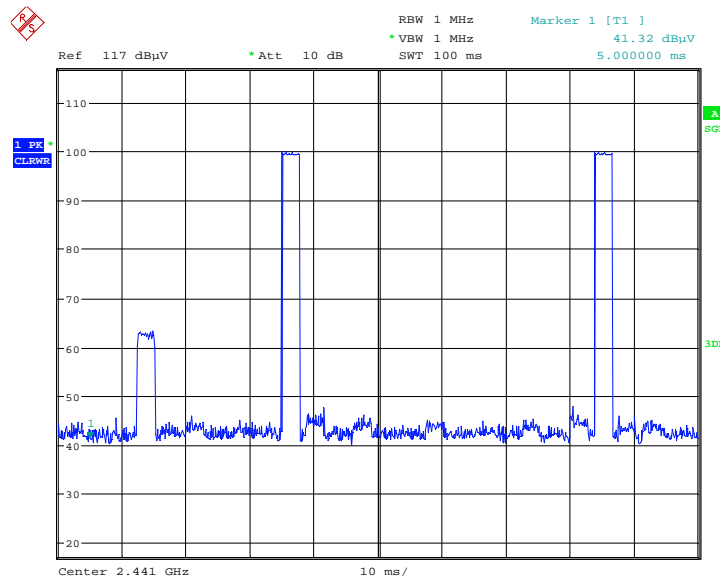

Date: 2.JAN.2015 05:50:21

**Note:**

1. Worst case Duty cycle = on time/100 milliseconds =  $2 * 2.88 / 100 = 5.76 \%$
2. Worst case Duty cycle correction factor =  $20 * \log(\text{Duty cycle}) = -24.79 \text{ dB}$
3. DH5 has the highest duty cycle worst case and is reported.



**Duty Cycle Correction Factor Consideration for AFH mode:**

Bluetooth normal hopping rate is 1600Hz and reduced to 800Hz in AFH mode; due to the reduced number of hopping frequencies, with the same packet configuration the dwell time in each channel frequency within 100msec period is longer in AFH mode than normal mode.

In AFH mode, the minimum hopping frequencies are 20, to get the longest dwell time DH5 packet is observed; the period to have DH5 packet completing one hopping sequence is

$$2.88 \text{ ms} \times 20 \text{ channels} = 57.6 \text{ ms}$$

There cannot be 2 complete hopping sequences within 100ms period, considering the random hopping behavior, maximum 2 hops can be possibly observed within the period.  $[100\text{ms} / 57.6\text{ms}] = 2$  hops

Thus, the maximum possible ON time:

$$2.88 \text{ ms} \times 2 = 5.76 \text{ ms}$$

Worst case Duty Cycle Correction factor, which is derived from the maximum possible ON time,

$$20 \times \log(5.76 \text{ ms}/100\text{ms}) = -24.79 \text{ dB}$$

**3.8.7 Test Result of Radiated Spurious at Band Edges**

Please refer to Appendix A.

**3.8.8 Test Result of Radiated Spurious Emission (30MHz ~ 10<sup>th</sup> Harmonic)**

Please refer to Appendix A.

### 3.9 AC Conducted Emission Measurement

#### 3.9.1 Limit of AC Conducted Emission

For equipment that is designed to be connected to the public utility (AC) power line, the radio frequency voltage that is conducted back onto the AC power line on any frequency or frequencies within the band 150 kHz to 30 MHz shall not exceed the limits in the following table.

Frequency of emission (MHz)	Conducted limit (dB $\mu$ V)	
	Quasi-peak	Average
0.15-0.5	66 to 56*	56 to 46*
0.5-5	56	46
5-30	60	50

\*Decreases with the logarithm of the frequency.

#### 3.9.2 Measuring Instruments

The measuring equipment is listed in the section 4 of this test report.

#### 3.9.3 Test Procedures

1. The EUT was placed 0.4 meter from the conducting wall of the shielding room was kept at least 80 centimeters from any other grounded conducting surface.
2. Connect EUT to the power mains through a line impedance stabilization network (LISN).
3. All the support units are connecting to the other LISN.
4. The LISN provides 50 ohm coupling impedance for the measuring instrument.
5. The FCC states that a 50 ohm, 50 microhenry LISN should be used.
6. Both sides of AC line were checked for maximum conducted interference.
7. The frequency range from 150 kHz to 30 MHz was searched.
8. Set the test-receiver system to Peak Detect Function and specified bandwidth (IF Bandwidth = 9kHz) with Maximum Hold Mode. Then measurement is also conducted by Average Detector and Quasi-Peak Detector Function respectively.



### 3.9.4 Test Setup

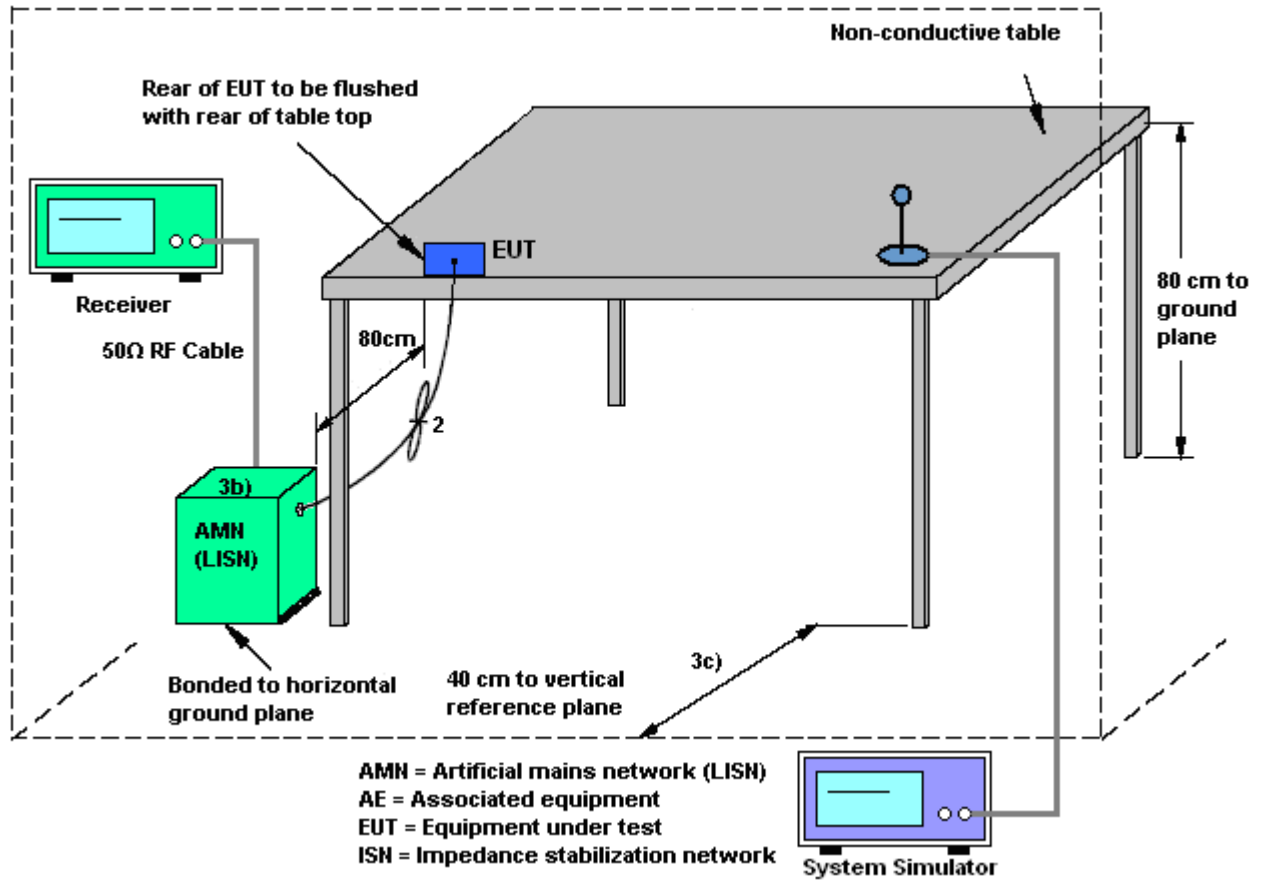



3.9.5 Test Result of AC Conducted Emission

Test Mode :	Mode 1	Temperature :	22~24°C
Test Engineer :	Eligah Wang	Relative Humidity :	37~39%
Test Voltage :	120Vac / 60Hz	Phase :	Line
Function Type :	GSM850 Idle + Bluetooth Link + WLAN Link + Earphone 1 + USB Cable 1 (Charging from Adapter 1)		
Remark :	All emissions not reported here are more than 10 dB below the prescribed limit.		

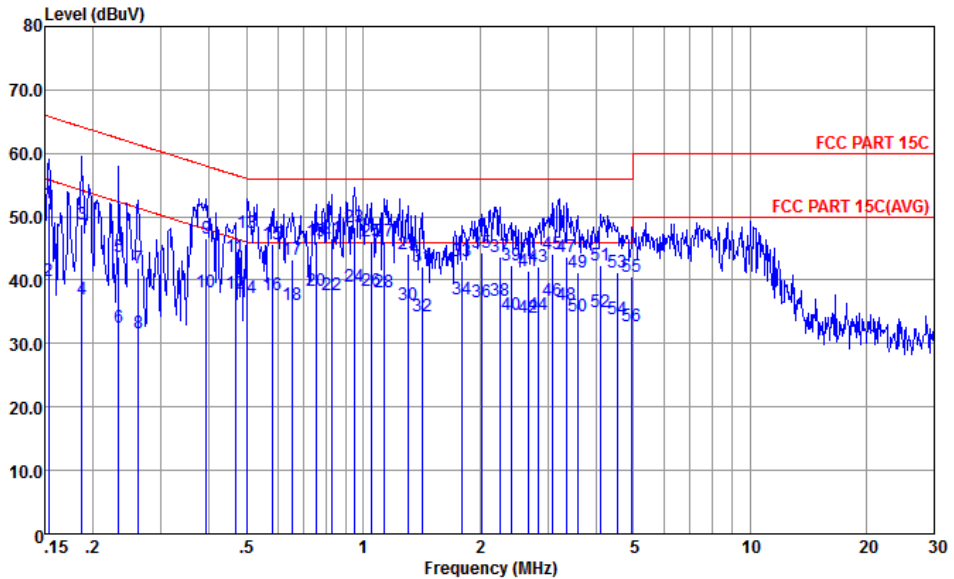

Site : CO01-KS  
 Condition : FCC PART 15C LISN-L20140306 LINE

mode	Freq	Level	Over Limit	Limit Line	Read Level	LISN Factor	Cable Loss	Remark
	MHz	dBuV	dB	dBuV	dBuV	dB	dB	
1	0.15	52.18	-13.64	65.82	39.90	1.90	10.38	QP
2	0.15	39.88	-15.94	55.82	27.60	1.90	10.38	Average
3	0.19	48.84	-15.31	64.15	37.20	1.16	10.48	QP
4	0.19	36.94	-17.21	54.15	25.30	1.16	10.48	Average
5	0.23	43.64	-18.71	62.35	32.20	0.92	10.52	QP
6	0.23	32.54	-19.81	52.35	21.10	0.92	10.52	Average
7	0.26	41.98	-19.40	61.38	30.60	0.84	10.54	QP
8	0.26	31.68	-19.70	51.38	20.30	0.84	10.54	Average
9	0.39	46.55	-11.44	57.99	35.60	0.33	10.62	QP
10	0.39	38.15	-9.84	47.99	27.20	0.33	10.62	Average
11	0.47	43.65	-12.93	56.58	32.80	0.23	10.62	QP
12	0.47	37.95	-8.63	46.58	27.10	0.23	10.62	Average
13	0.50	47.42	-8.58	56.00	36.60	0.20	10.62	QP
14	0.50	37.22	-8.78	46.00	26.40	0.20	10.62	Average
15	0.58	45.63	-10.37	56.00	34.80	0.20	10.63	QP
16	0.58	37.63	-8.37	46.00	26.80	0.20	10.63	Average
17	0.66	43.24	-12.76	56.00	32.40	0.20	10.64	QP
18	0.66	36.14	-9.86	46.00	25.30	0.20	10.64	Average
19	0.75	46.03	-9.97	56.00	35.21	0.18	10.64	QP
20	0.75	38.43	-7.57	46.00	27.61	0.18	10.64	Average
21	0.83	46.60	-9.40	56.00	35.80	0.15	10.65	QP
22	0.83	37.70	-8.30	46.00	26.90	0.15	10.65	Average
23	0.95	48.26	-7.74	56.00	37.50	0.11	10.65	QP
24 *	0.95	39.06	-6.94	46.00	28.30	0.11	10.65	Average
25	1.05	46.05	-9.95	56.00	35.30	0.10	10.65	QP



Test Mode :	Mode 1	Temperature :	22~24°C
Test Engineer :	Eligah Wang	Relative Humidity :	37~39%
Test Voltage :	120Vac / 60Hz	Phase :	Line
Function Type :	GSM850 Idle + Bluetooth Link + WLAN Link + Earphone 1 + USB Cable 1 (Charging from Adapter 1)		
Remark :	All emissions not reported here are more than 10 dB below the prescribed limit.		

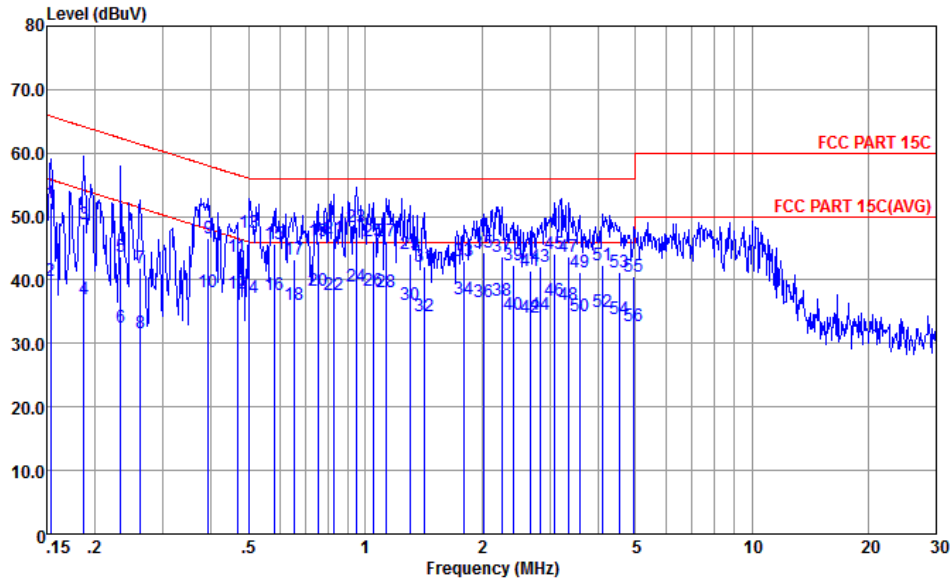

Site : CO01-KS  
 Condition : FCC PART 15C LISN-L20140306 LINE

mode : Mode 1

	Freq	Level	Over	Limit	Read	LISN	Cable	
	MHz	dBuV	Limit	Line	Level	Factor	Loss	Remark
			dB	dBuV	dBuV	dB	dB	
26	1.05	38.35	-7.65	46.00	27.60	0.10	10.65	Average
27	1.14	46.06	-9.94	56.00	35.30	0.10	10.66	QP
28	1.14	38.06	-7.94	46.00	27.30	0.10	10.66	Average
29	1.30	44.06	-11.94	56.00	33.30	0.10	10.66	QP
30	1.30	36.06	-9.94	46.00	25.30	0.10	10.66	Average
31	1.43	42.18	-13.82	56.00	31.40	0.10	10.68	QP
32	1.43	34.28	-11.72	46.00	23.50	0.10	10.68	Average
33	1.80	43.10	-12.90	56.00	32.30	0.10	10.70	QP
34	1.80	37.10	-8.90	46.00	26.30	0.10	10.70	Average
35	2.02	44.40	-11.60	56.00	33.60	0.10	10.70	QP
36	2.02	36.60	-9.40	46.00	25.80	0.10	10.70	Average
37	2.26	43.72	-12.28	56.00	32.90	0.11	10.71	QP
38	2.26	36.72	-9.28	46.00	25.90	0.11	10.71	Average
39	2.41	42.34	-13.66	56.00	31.51	0.11	10.72	QP
40	2.41	34.64	-11.36	46.00	23.81	0.11	10.72	Average
41	2.66	41.47	-14.53	56.00	30.60	0.12	10.75	QP
42	2.66	34.07	-11.93	46.00	23.20	0.12	10.75	Average
43	2.84	42.20	-13.80	56.00	31.30	0.13	10.77	QP
44	2.84	34.50	-11.50	46.00	23.60	0.13	10.77	Average
45	3.07	44.13	-11.87	56.00	33.20	0.14	10.79	QP
46	3.07	36.83	-9.17	46.00	25.90	0.14	10.79	Average
47	3.36	43.57	-12.43	56.00	32.60	0.16	10.81	QP
48	3.36	36.07	-9.93	46.00	25.10	0.16	10.81	Average
49	3.60	41.19	-14.81	56.00	30.20	0.17	10.82	QP
50	3.60	34.29	-11.71	46.00	23.30	0.17	10.82	Average
51	4.11	42.32	-13.68	56.00	31.30	0.19	10.83	QP
52	4.11	34.92	-11.08	46.00	23.90	0.19	10.83	Average
53	4.55	41.33	-14.67	56.00	30.30	0.19	10.84	QP
54	4.55	33.83	-12.17	46.00	22.80	0.19	10.84	Average
55	4.95	40.55	-15.45	56.00	29.50	0.20	10.85	QP
56	4.95	32.65	-13.35	46.00	21.60	0.20	10.85	Average



Test Mode :	Mode 1	Temperature :	22~24°C
Test Engineer :	Eligah Wang	Relative Humidity :	37~39%
Test Voltage :	120Vac / 60Hz	Phase :	Neutral
Function Type :	GSM850 Idle + Bluetooth Link + WLAN Link + Earphone 1 + USB Cable 1 (Charging from Adapter 1)		
Remark :	All emissions not reported here are more than 10 dB below the prescribed limit.		

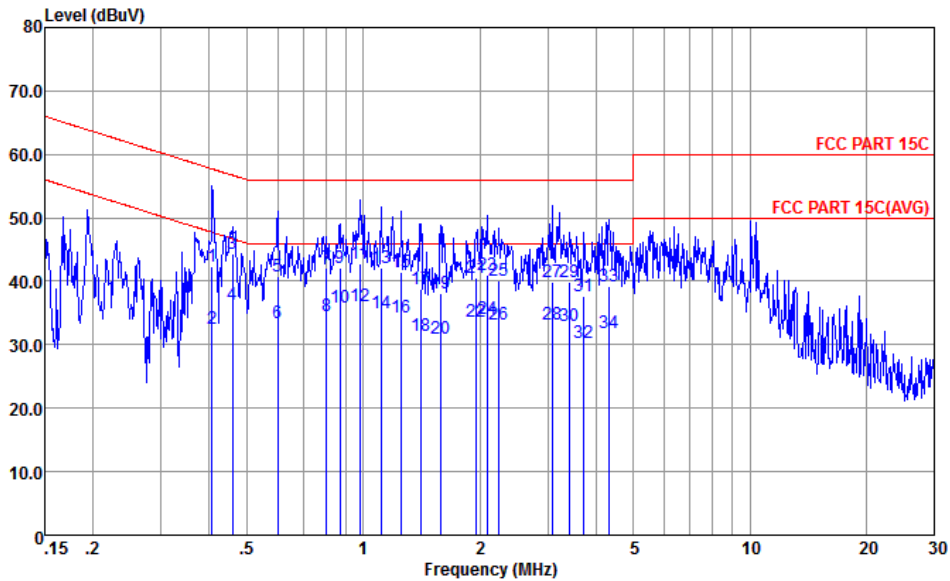

Site : CO01-KS  
 Condition : FCC PART 15C LISN-N20140306 NEUTRAL

mode : Mode 1

Freq	Level	Over	Limit	Read	LISN	Cable	Remark
MHz	dBuV	Limit	Line	Level	Factor	Loss	
		dB	dBuV	dBuV	dB	dB	
1	0.41	42.31	-15.42	57.73	31.30	0.39	10.62 QP
2	0.41	32.61	-15.12	47.73	21.60	0.39	10.62 Average
3	0.46	44.26	-12.45	56.71	33.31	0.33	10.62 QP
4	0.46	36.26	-10.45	46.71	25.31	0.33	10.62 Average
5	0.60	40.67	-15.33	56.00	29.80	0.24	10.63 QP
6	0.60	33.47	-12.53	46.00	22.60	0.24	10.63 Average
7	0.80	42.01	-13.99	56.00	31.19	0.17	10.65 QP
8	0.80	34.51	-11.49	46.00	23.69	0.17	10.65 Average
9	0.87	42.08	-13.92	56.00	31.30	0.13	10.65 QP
10	0.87	35.98	-10.02	46.00	25.20	0.13	10.65 Average
11	0.98	42.75	-13.25	56.00	32.00	0.10	10.65 QP
12 *	0.98	36.05	-9.95	46.00	25.30	0.10	10.65 Average
13	1.11	42.05	-13.95	56.00	31.30	0.10	10.65 QP
14	1.11	35.05	-10.95	46.00	24.30	0.10	10.65 Average
15	1.26	41.46	-14.54	56.00	30.70	0.10	10.66 QP
16	1.26	34.36	-11.64	46.00	23.60	0.10	10.66 Average
17	1.41	38.87	-17.13	56.00	28.10	0.10	10.67 QP
18	1.41	31.37	-14.63	46.00	20.60	0.10	10.67 Average
19	1.59	38.09	-17.91	56.00	27.30	0.10	10.69 QP
20	1.59	30.99	-15.01	46.00	20.20	0.10	10.69 Average
21	1.96	40.60	-15.40	56.00	29.80	0.10	10.70 QP
22	1.96	33.60	-12.40	46.00	22.80	0.10	10.70 Average
23	2.09	41.01	-14.99	56.00	30.21	0.10	10.70 QP
24	2.09	34.11	-11.89	46.00	23.31	0.10	10.70 Average
25	2.25	40.02	-15.98	56.00	29.20	0.11	10.71 QP



Test Mode :	Mode 1	Temperature :	22~24°C
Test Engineer :	Eligah Wang	Relative Humidity :	37~39%
Test Voltage :	120Vac / 60Hz	Phase :	Neutral
Function Type :	GSM850 Idle + Bluetooth Link + WLAN Link + Earphone 1 + USB Cable 1 (Charging from Adapter 1)		
Remark :	All emissions not reported here are more than 10 dB below the prescribed limit.		

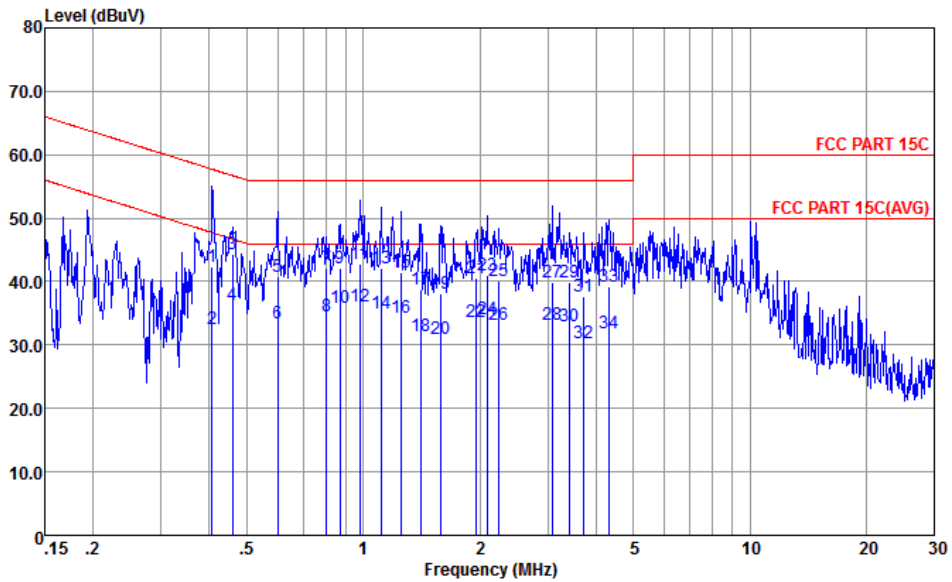

Site : CO01-KS  
 Condition : FCC PART 15C LISN-N20140306 NEUTRAL

mode : Mode 1

	Freq	Level	Over Limit	Limit Line	Read Level	LISN Factor	Cable Loss	Remark
	MHz	dBuV	dB	dBuV	dBuV	dB	dB	
26	2.25	33.12	-12.88	46.00	22.30	0.11	10.71	Average
27	3.07	39.83	-16.17	56.00	28.90	0.14	10.79	QP
28	3.07	33.23	-12.77	46.00	22.30	0.14	10.79	Average
29	3.42	39.88	-16.12	56.00	28.90	0.17	10.81	QP
30	3.42	32.88	-13.12	46.00	21.90	0.17	10.81	Average
31	3.72	37.60	-18.40	56.00	26.60	0.18	10.82	QP
32	3.72	30.30	-15.70	46.00	19.30	0.18	10.82	Average
33	4.31	39.33	-16.67	56.00	28.30	0.19	10.84	QP
34	4.31	31.93	-14.07	46.00	20.90	0.19	10.84	Average



## **3.10 Antenna Requirements**

### **3.10.1 Standard Applicable**

If directional gain of transmitting antennas is greater than 6dBi, the power shall be reduced by the same level in dB comparing to gain minus 6dBi. The use of a permanently attached antenna or of an antenna that uses a unique coupling to the intentional radiator shall be considered sufficient to comply with the FCC rule.

### **3.10.2 Antenna Anti-Replacement Construction**

An embedded-in antenna design is used.

### **3.10.3 Antenna Gain**

The antenna peak gain of EUT is less than 6 dBi. Therefore, it is not necessary to reduce maximum peak output power limit.



## 4 List of Measuring Equipment

Instrument	Manufacturer	Model No.	Serial No.	Characteristics	Calibration Date	Test Date	Due Date	Remark
Spectrum Analyzer	R&S	FSP40	100319	9kHz~40GHz	Oct. 28, 2014	Dec. 10, 2014~ Dec. 11, 2014	Oct. 27, 2015	Conducted (TH01-KS)
Pulse Power Sensor	Anritsu	MA2411B	0917070	30MHz~40GHz	Feb. 27, 2014	Dec. 10, 2014~ Dec. 11, 2014	Feb. 26, 2015	Conducted (TH01-KS)
Power Meter	Anritsu	ML2495A	1005002	50MHz Bandwidth	Feb. 27, 2014	Dec. 10, 2014~ Dec. 11, 2014	Feb. 26, 2015	Conducted (TH01-KS)
EMI Test Receiver	R&S	ESCI	100534	9kHz~3GHz	Oct. 25, 2014	Jan. 02, 2015	Oct. 24, 2015	Radiation (03CH01-KS)
Spectrum Analyzer	R&S	FSP30	101399	9kHz~30GHz	May 04, 2014	Jan. 02, 2015	May 03, 2015	Radiation (03CH01-KS)
Loop Antenna	R&S	HFH2-Z2	100321	9kHz~30MHz	Nov. 13, 2014	Jan. 02, 2015	Nov. 12, 2015	Radiation (03CH01-KS)
Bilog Antenna	SCHAFFNER	CBL6112D	23182	25MHz~2GHz	Jan. 08, 2014	Jan. 02, 2015	Jan. 07, 2015	Radiation (03CH01-KS)
Double Ridge Horn Antenna	ETS-Lindgren	3117	75957	1GHz~18GHz	Nov. 08, 2014	Jan. 02, 2015	Nov. 07, 2015	Radiation (03CH01-KS)
Active Horn Antenna	com-power	AHA-118	701030	1GHz~18GHz	Nov. 08, 2014	Jan. 02, 2015	Nov. 07, 2015	Radiation (03CH01-KS)
SHF-EHF Horn	Schwarzbeck	BBHA 9170	BBHA1702 49	15GHz~40GHz	Mar. 10, 2014	Jan. 02, 2015	Mar. 09, 2015	Radiation (03CH01-KS)
Amplifier	com-power	PA-103A	161073	1MHz~1GHz	May 04, 2014	Jan. 02, 2015	May 03, 2015	Radiation (03CH01-KS)
Amplifier	Agilent	8449B	3008A023 71	1GHz~26.5GHz	Oct. 28, 2014	Jan. 02, 2015	Oct. 27, 2015	Radiation (03CH01-KS)
AC Power Source	Chroma	61601	F1040900 04	N/A	NCR	Jan. 02, 2015	NCR	Radiation (03CH01-KS)
Turn Table	MF	MF7802	N/A	0~360 degree	NCR	Jan. 02, 2015	NCR	Radiation (03CH01-KS)
Antenna Mast	MF	MF7802	N/A	1 m~4 m	NCR	Jan. 02, 2015	NCR	Radiation (03CH01-KS)
EMI Receiver	R&S	ESCI7	100768	9kHz~7GHz;	May 04, 2014	Dec. 12, 2014	May 03, 2015	Conduction (CO01-KS)
AC LISN	MessTec	AN3016	060103	9kHz~30MHz	Oct. 25, 2014	Dec. 12, 2014	Oct. 24, 2015	Conduction (CO01-KS)
AC LISN (for auxiliary equipment)	MessTec	AN3016	060105	9kHz~30MHz	Oct. 25, 2014	Dec. 12, 2014	Oct. 24, 2015	Conduction (CO01-KS)
AC Power Source	Chroma	61602	ABP00000 0811	AC 0V~300V, 45Hz~1000Hz	Oct. 25, 2014	Dec. 12, 2014	Oct. 24, 2015	Conduction (CO01-KS)



## 5 Uncertainty of Evaluation

### Uncertainty of Conducted Emission Measurement (150 kHz ~ 30 MHz)

Measuring Uncertainty for a Level of Confidence of 95% ( $U = 2Uc(y)$ )	2.3
---	-----

### Uncertainty of Radiated Emission Measurement (30 MHz ~ 1000 MHz)

Measuring Uncertainty for a Level of Confidence of 95% ( $U = 2Uc(y)$ )	4.7
---	-----





## Appendix A. Radiated Spurious Emission

15C 2.4GHz 2400~2483.5MHz

BT (Band Edge @ 3m)

BT	Note	Frequency	Level	Over	Limit	Read	Antenna	Cable	Preamp	Ant	Table	Peak	Pol.
				Limit	Line	Level	Factor	Loss	Factor	Pos	Pos	Avg.	
		( MHz )	( dBμV/m )	( dB )	( dBμV/m )	( dBμV )	( dB/m )	( dB )	( dB )	( cm )	( deg )	(P/A)	(H/V)
BT CH00 2402MHz		2320.92	50.87	-23.13	74	49.95	31.23	6.12	36.43	100	203	P	H
		2320.92	26.08	-27.92	54	-	-	-	-	-	-	A	H
		2402.04	102.08	-	-	100.64	31.3	6.22	36.08	100	203	P	H
		2402.04	77.29	-	-	-	-	-	-	-	-	A	H
		2347.57	48	-26	74	46.97	31.25	6.12	36.34	173	150	P	V
		2347.57	23.21	-30.79	54	-	-	-	-	-	-	A	V
		2402.17	95.84	-	-	94.4	31.3	6.22	36.08	173	150	P	V
		2402.17	71.05	-	-	-	-	-	-	-	-	A	V
BT CH 39 2441MHz		2440.91	102.33	-	-	100.62	31.34	6.28	35.91	100	205	P	H
		2440.91	77.54	-	-	-	-	-	-	-	-	A	H
		2440.91	96.3	-	-	94.59	31.34	6.28	35.91	173	71	P	V
		2440.91	71.51	-	-	-	-	-	-	-	-	A	V
BT CH 78 2480MHz		2479.84	98.88	-	-	96.97	31.37	6.33	35.79	100	344	P	H
		2479.84	74.09	-	-	-	-	-	-	-	-	A	H
		2483.5	56.77	-17.23	74	54.86	31.37	6.33	35.79	100	344	P	H
		2483.5	31.98	-22.02	54	-	-	-	-	-	-	A	H
		2479.84	98	-	-	96.09	31.37	6.33	35.79	141	67	P	V
		2479.84	73.21	-	-	-	-	-	-	-	-	A	V
		2483.5	55.89	-18.11	74	53.98	31.37	6.33	35.79	141	67	P	V
		2483.5	31.1	-22.9	54	-	-	-	-	-	-	A	V
Remark	<ol style="list-style-type: none"> <li>No other spurious found.</li> <li>All results are PASS against Peak and Average limit line.</li> </ol>												



15C 2.4GHz 2400~2483.5MHz  
BT (Harmonic @ 3m)

BT	Note	Frequency	Level	Over	Limit	Read	Antenna	Cable	Preamp	Ant	Table	Peak	Pol.
		( MHz )	( dBμV/m )	( dB )	( dBμV/m )	( dBμV )	( dB/m )	( dB )	( dB )	( cm )	( deg )	( P/A )	( H/V )
BT CH 00 2402MHz		4803	45.36	-28.64	74	38.36	34.88	8.71	36.59	104	230	P	H
		4803	48.89	-25.11	74	41.89	34.88	8.71	36.59	115	216	P	V
BT CH 39 2441MHz		4881	45.1	-28.9	74	38.26	34.92	8.76	36.84	120	235	P	H
		7323	46.32	-27.68	74	38.83	35.57	10.84	38.92	145	120	P	H
		4881	45.84	-28.16	74	39	34.92	8.76	36.84	125	56	P	V
		7323	45.29	-28.71	74	37.8	35.57	10.84	38.92	178	89	P	V
BT CH 78 2480MHz		4959	47.1	-26.9	74	40.47	34.97	8.81	37.15	100	0	P	H
		7440	48.18	-25.82	74	40.58	35.59	10.92	38.91	125	301	P	H
		4959	48.6	-25.4	74	41.97	34.97	8.81	37.15	168	216	P	V
		7440	47.35	-26.65	74	39.75	35.59	10.92	38.91	154	206	P	V
Remark	<ol style="list-style-type: none"> <li>No other spurious found.</li> <li>All results are PASS against Peak and Average limit line.</li> </ol>												



15C Emission below 1GHz

2.4GHz BT (LF)

BT	Note	Frequency	Level	Over	Limit	Read	Antenna	Cable	Preamp	Ant	Table	Peak	Pol.
		( MHz )	( dBμV/m )	( dB )	( dBμV/m )	( dBμV )	( dB/m )	( dB )	( dB )	( cm )	( deg )	Avg.	
					Limit Line	Level	Factor	Loss	Factor	Pos	Pos	(P/A)	(H/V)
2.4GHz BT LF		30.97	18.45	-21.55	40	31.61	18.71	0.79	32.66			P	H
		73.65	17.1	-22.9	40	40.18	8.53	1.04	32.65			P	H
		96.93	22.6	-20.9	43.5	43.2	10.97	1.04	32.61			P	H
		106.63	25.11	-18.39	43.5	45.36	11.35	1.04	32.64	200	131	P	H
		225.94	23.27	-22.73	46	43.16	10.99	1.61	32.49			P	H
		232.73	26.39	-19.61	46	45.83	11.3	1.75	32.49			P	H
		36.79	28.68	-11.32	40	44.73	15.77	0.79	32.61	100	0	P	V
		48.43	26.73	-13.27	40	48.85	9.72	0.79	32.63			P	V
		59.1	25.47	-14.53	40	50.92	6.36	0.79	32.6			P	V
		96.93	21.08	-22.42	43.5	41.68	10.97	1.04	32.61			P	V
		106.63	22.16	-21.34	43.5	42.41	11.35	1.04	32.64			P	V
		225.94	17.66	-28.34	46	37.55	10.99	1.61	32.49			P	V
Remark	1. No other spurious found. 2. All results are PASS against limit line.												



**Note symbol**

*	<b>Fundamental Frequency</b> which can be ignored. However, the level of any unwanted emissions shall not exceed the level of the fundamental frequency per 15.209(c).
!	Test result is <b>over limit</b> line.
P/A	<b>Peak</b> or <b>Average</b>
H/V	<b>Horizontal</b> or <b>Vertical</b>



A calculation example for radiated spurious emission is shown as below:

WIFI	Note	Frequency	Level	Over	Limit	Read	Antenna	Cable	Preamp	Ant	Table	Peak	Pol.
Ant.				Limit	Line	Level	Factor	Loss	Factor	Pos	Pos	Avg.	
1+2		( MHz )	( dBμV/m )	( dB )	( dBμV/m )	( dBμV )	( dB/m )	( dB )	( dB )	( cm )	( deg )	( P/A )	( H/V )
802.11b		2390	55.45	-18.55	74	54.51	32.22	4.58	35.86	103	308	P	H
CH 01													
2412MHz		2390	43.54	-10.46	54	42.6	32.22	4.58	35.86	103	308	A	H

1. Level(dBμV/m) =

Antenna Factor(dB/m) + Cable Loss(dB) + Read Level(dBμV) - Preamp Factor(dB)

2. Over Limit(dB) = Level(dBμV/m) – Limit Line(dBμV/m)

**For Peak Limit @ 2390MHz:**

1. Level(dBμV/m)

= Antenna Factor(dB/m) + Cable Loss(dB) + Read Level(dBμV) - Preamp Factor(dB)

= 32.22(dB/m) + 4.58(dB) + 54.51(dBμV) – 35.86 (dB)

= 55.45 (dBμV/m)

2. Over Limit(dB)

= Level(dBμV/m) – Limit Line(dBμV/m)

= 55.45(dBμV/m) – 74(dBμV/m)

= -18.55(dB)

**For Average Limit @ 2390MHz:**

1. Level(dBμV/m)

= Antenna Factor(dB/m) + Cable Loss(dB) + Read Level(dBμV) - Preamp Factor(dB)

= 32.22(dB/m) + 4.58(dB) + 42.6(dBμV) – 35.86 (dB)

= 43.54 (dBμV/m)

2. Over Limit(dB)

= Level(dBμV/m) – Limit Line(dBμV/m)

= 43.54(dBμV/m) – 54(dBμV/m)

= -10.46(dB)

**Both peak and average measured complies with the limit line, so test result is “PASS”.**