



FCC RF Test Report

APPLICANT : HTC Corporation
EQUIPMENT : Smartphone
MODEL NAME : 0PKV100
FCC ID : NM80PKV100
STANDARD : FCC Part 15 Subpart E §15.407
CLASSIFICATION : (NII) Unlicensed National Information Infrastructure

The product was received on Jan. 12, 2015 and testing was completed on Mar. 13, 2015. We, SPORTON INTERNATIONAL INC., would like to declare that the tested sample has been evaluated in accordance with the test procedures and has been in compliance with the applicable technical standards.

The test results in this report apply exclusively to the tested model / sample. Without written approval of SPORTON INTERNATIONAL INC., the test report shall not be reproduced except in full.

Reviewed by: Joseph Lin / Supervisor

Approved by: Jones Tsai / Manager



SPORTON INTERNATIONAL INC.

No. 52, Hwa Ya 1st Rd., Hwa Ya Technology Park, Kwei-Shan District, Tao Yuan City, Taiwan, R.O.C.

SPORTON INTERNATIONAL INC.

TEL : 886-3-327-3456

FAX : 886-3-328-4978

FCC ID : NM80PKV100

Page Number : 1 of 38

Report Issued Date : Mar. 17, 2015

Report Version : Rev. 01

Report Template No.: BU5-FR15EWL Version 1.0



TABLE OF CONTENTS

SUMMARY OF TEST RESULT 4

1 GENERAL DESCRIPTION 5

1.1 Applicant 5

1.2 Manufacturer 5

1.3 Feature of Equipment Under Test 5

1.4 Product Specification of Equipment Under Test 6

1.5 Modification of EUT 6

1.6 Testing Location 7

1.7 Applicable Standards 7

2 TEST CONFIGURATION OF EQUIPMENT UNDER TEST 8

2.1 Carrier Frequency Channel 9

2.2 Pre-Scanned RF Power 10

2.3 Test Mode 11

2.4 Connection Diagram of Test System 14

2.5 Support Unit used in test configuration and system 15

2.6 EUT Operation Test Setup 15

2.7 Measurement Results Explanation Example 15

3 TEST RESULT 16

3.1 26dB & 99% Occupied Bandwidth Measurement 16

3.2 Maximum Conducted Output Power Measurement 18

3.3 Power Spectral Density Measurement 21

3.4 Unwanted Radiated Emission Measurement 24

3.5 AC Conducted Emission Measurement 30

3.6 Frequency Stability Measurement 34

3.7 Automatically Discontinue Transmission 35

3.8 Antenna Requirements 36

4 LIST OF MEASURING EQUIPMENTS 37

5 UNCERTAINTY OF EVALUATION 38

APPENDIX A. CONDUCTED TEST RESULTS

APPENDIX B. RADIATED TEST RESULTS



SUMMARY OF TEST RESULT

Report Section	FCC Rule	IC Rule	Description	Limit	Result	Remark
3.1	2.1049 15.403(i)	RSS-210 A9.2	26dB & 99% Bandwidth	-	Pass	-
3.2	15.407(a)	RSS-210 A9.2	Maximum Conducted Output Power	FCC ≤ 24 dBm (depend on band) IC RSS-210 A9.2 Limit	Pass	-
3.3	15.407(a)	RSS-210 A9.2	Power Spectral Density	FCC ≤ 11 dBm (depend on band) IC RSS-210 A9.2 Limit	Pass	-
3.4	15.407(b)	RSS-210 A9.3	Unwanted Emissions	≤ -17, -27 dBm (depend on band)&15.209(a)	Pass	Under limit 9.82 dB at 5743.400 MHz
3.5	15.207	RSS-Gen 7.2.4	AC Conducted Emission	15.207(a)	Pass	Under limit 11.30 dB at 0.190 MHz
3.6	15.407(g)	-	Frequency Stability	Within Operation Band	Pass	-
3.7	15.407(c)	RSS-210 A9.4	Automatically Discontinue Transmission	Discontinue Transmission	Pass	-
3.8	15.203 & 15.407(a)	RSS-210 A9.2	Antenna Requirement	N/A	Pass	-



1 General Description

1.1 Applicant

HTC Corporation

1F, 6-3 Baoqiang Road, Xindian District, New Taipei City, Taiwan 231

1.2 Manufacturer

HTC Corporation

1F, 6-3 Baoqiang Road, Xindian District, New Taipei City, Taiwan 231

1.3 Feature of Equipment Under Test

Product Feature & Specification	
Equipment	Smartphone
Model Name	0PKV100
FCC ID	NM80PKV100
EUT supports Radios application	GSM/EGPRS/WCDMA/HSPA/LTE/NFC WLAN 2.4GHz 802.11b/g/n (HT20) WLAN 5GHz 802.11a/n (HT20/HT40) WLAN 5GHz 802.11ac (VHT20/VHT40/VHT80) Bluetooth v4.0 EDR/LE
EUT Stage	Identical Prototype

Remark: The above EUT's information was declared by manufacturer. Please refer to the specifications or user's manual for more detailed description.



1.4 Product Specification of Equipment Under Test

Product Specification subjective to this standard	
Tx/Rx Frequency Range	5180 MHz ~ 5240 MHz 5260 MHz ~ 5320 MHz 5500 MHz ~ 5580 MHz and 5660 MHz ~ 5700 MHz
Maximum Output Power to Antenna	<p><5180 MHz ~ 5240 MHz> 802.11a : 11.93 dBm / 0.0156 W 802.11n HT20 : 11.93 dBm / 0.0156 W 802.11n HT40 : 11.93 dBm / 0.0156 W 802.11ac VHT20 : 9.99 dBm / 0.0100 W 802.11ac VHT40 : 9.70 dBm / 0.0093 W 802.11ac VHT80 : 9.98 dBm / 0.0100 W</p> <p><5260 MHz ~ 5320 MHz> 802.11a : 11.97 dBm / 0.0157 W 802.11n HT20 : 11.91 dBm / 0.0155 W 802.11n HT40 : 12.00 dBm / 0.0158 W 802.11ac VHT20 : 9.98 dBm / 0.0100 W 802.11ac VHT40 : 9.94 dBm / 0.0099 W 802.11ac VHT80 : 9.80 dBm / 0.0095 W</p> <p><5500 MHz ~ 5580 MHz and 5660 MHz ~ 5700 MHz > 802.11a : 11.89 dBm / 0.0155 W 802.11n HT20 : 11.94 dBm / 0.0156 W 802.11n HT40 : 11.91 dBm / 0.0155 W 802.11ac VHT20 : 9.63 dBm / 0.0092 W 802.11ac VHT40 : 9.72 dBm / 0.0094 W 802.11ac VHT80 : 9.86 dBm / 0.0097 W</p>
Antenna Type	PIFA Antenna
Antenna Gain	5150 MHz ~ 5250 MHz : -3.00 dBi 5250 MHz ~ 5350 MHz : -3.00 dBi 5470 MHz ~ 5725 MHz : -3.00 dBi
Type of Modulation	802.11a/n : OFDM (BPSK / QPSK / 16QAM / 64QAM) 802.11ac : OFDM (BPSK / QPSK / 16QAM / 64QAM / 256QAM)

1.5 Modification of EUT

No modifications are made to the EUT during all test items.



1.6 Testing Location

Sporton Lab is accredited to ISO 17025 by Taiwan Accreditation Foundation (TAF code : 1190) and the FCC designation No. TW1022 under the FCC 2.948(e) by Mutual Recognition Agreement (MRA) in FCC Test.

Test Site	SPORTON INTERNATIONAL INC.		
Test Site Location	No. 52, Hwa Ya 1 st Rd., Hwa Ya Technology Park, Kwei-Shan District, Tao Yuan City, Taiwan, R.O.C. TEL: +886-3-327-3456 FAX: +886-3-328-4978		
Test Site No.	Sporton Site No.		
	TH02-HY	CO05-HY	03CH05-HY

Note: The test site complies with ANSI C63.4 2009 requirement.

1.7 Applicable Standards

According to the specifications of the manufacturer, the EUT must comply with the requirements of the following standards:

- ♦ FCC Part 15 Subpart E
- ♦ FCC KDB 789033 D02 General UNII Test Procedures New Rules v01
- ♦ ANSI C63.10-2013

Remark:

1. All test items were verified and recorded according to the standards and without any deviation during the test.
2. FCC permits the use of the 1.5 meter table as an alternative in C63.10-2013 through inquiry tracking number 961829.
3. This EUT has also been tested and complied with the requirements of FCC Part 15, Subpart B, recorded in a separate test report.



2 Test Configuration of Equipment Under Test

The EUT has been associated with peripherals and configuration operated in a manner tended to maximize its emission characteristics in a typical application. Frequency range investigated: conducted emission (150 kHz to 30 MHz) and radiated emission (9 kHz to the 10th harmonic of the highest fundamental frequency or to 40 GHz, whichever is lower). For radiated measurement, pre-scanned in three orthogonal panels, X, Y, Z. The worst cases (Y plane) were recorded in this report.

The final configuration from all the combinations and the worst-case data rates were investigated by measuring the maximum power across all the data rates and modulation modes under section 2.2.

Based on the worst configuration found above, the RF power setting is set individually to meet FCC compliance limit for the final conducted and radiated tests shown in section 2.3.



2.1 Carrier Frequency Channel

Frequency Band	Channel	Freq. (MHz)	Channel	Freq. (MHz)
5150-5250 MHz Band 1 (U-NII-1)	36	5180	44	5220
	38	5190	46	5230
	40	5200	48	5240
	42	5210		

Frequency Band	Channel	Freq. (MHz)	Channel	Freq. (MHz)
5250-5350 MHz Band 2 (U-NII-2A)	52	5260	60	5300
	54	5270	62	5310
	56	5280	64	5320
	58	5290		

Frequency Band	Channel	Freq. (MHz)	Channel	Freq. (MHz)
5470-5600 MHz and 5650-5725 MHz Band 3 (U-NII-2C)	100	5500	116	5580
	102	5510	132	5660
	104	5520	134	5670
	108	5540	136	5680
	110	5550	140	5700
	112	5560		

Frequency Band	Channel	Freq. (MHz)	Channel	Freq. (MHz)
Straddle Channel	144	5720	142	5710
	138	5690		

Note: The above Frequency and Channel in boldface were 802.11n HT40.



2.2 Pre-Scanned RF Power

Preliminary tests were performed in different data rate and data rate associated with the highest power were chosen for full test in the following tables. Final Output Power equals to Measured Output Power adds the duty factor.

5GHz 802.11a mode								
Data Rate (MHz)	6M bps	9M bps	12M bps	18M bps	24M bps	36M bps	48M bps	54M bps
Average Power (dBm)	11.97	11.61	11.62	11.74	11.63	11.84	11.76	11.80

5GHz 802.11n HT20 mode								
Data Rate (MHz)	MCS0	MCS1	MCS2	MCS3	MCS4	MCS5	MCS6	MCS7
Average Power (dBm)	11.94	11.92	11.85	11.78	11.84	11.92	11.86	11.76

5GHz 802.11n HT40 mode								
Data Rate (MHz)	MCS0	MCS1	MCS2	MCS3	MCS4	MCS5	MCS6	MCS7
Average Power (dBm)	12.00	11.99	11.66	11.71	11.68	11.87	11.69	11.41

5GHz 802.11ac VHT20 mode									
Data Rate (MHz)	MCS 0	MCS 1	MCS 2	MCS 3	MCS 4	MCS 5	MCS 6	MCS 7	MCS 8
Avg. Power (dBm)	9.99	9.98	9.96	9.88	9.94	9.96	9.95	9.94	9.94

5GHz 802.11ac VHT40 mode										
Data Rate (MHz)	MCS 0	MCS 1	MCS 2	MCS 3	MCS 4	MCS 5	MCS 6	MCS 7	MCS 8	MCS 9
Avg. Power (dBm)	9.94	9.91	9.89	9.85	9.83	9.86	9.88	9.89	9.84	9.87

5GHz 802.11ac VHT80 mode										
Data Rate (MHz)	MCS 0	MCS 1	MCS 2	MCS 3	MCS 4	MCS 5	MCS 6	MCS 7	MCS 8	MCS 9
Avg. Power (dBm)	9.98	9.94	9.92	9.96	9.95	9.91	9.88	9.93	9.91	9.92



2.3 Test Mode

Final test mode of conducted test items and radiated spurious emissions are considering the modulation and worse data rates from the power table described in section 2.2.

Modulation	Data Rate
802.11a	6 Mbps
802.11n HT20	MCS0
802.11n HT40	MCS0
802.11ac VHT20	MCS0
802.11ac VHT40	MCS0
802.11ac VHT80	MCS0

AC Conducted Emission	Mode 1 : WCDMA Band II Idle + Bluetooth Link + WLAN (5GHz) Link + Earphone 1 + USB Cable 2 (Data Link with Notebook) + GPS Rx
Remark: All the radiated test cases were performance with Adapter 1, USB Cable 1 and Earphone 1.	



Ch. #		Band I : 5150-5250 MHz	Band II : 5250-5350 MHz	Band III : 5470-5600 MHz and 5650-5725MHz
		802.11a	802.11a	802.11a
L	Low	36	52	100
M	Middle	44	60	116
H	High	48	64	140
Straddle		-	-	144

Ch. #		Band I : 5150-5250 MHz	Band II : 5250-5350 MHz	Band III : 5470-5600 MHz and 5650-5725MHz
		802.11n HT20	802.11n HT20	802.11n HT20
L	Low	36	52	100
M	Middle	44	60	116
H	High	48	64	140
Straddle		-	-	144

Ch. #		Band I : 5150-5250 MHz	Band II : 5250-5350 MHz	Band III : 5470-5600 MHz and 5650-5725MHz
		802.11n HT40	802.11n HT40	802.11n HT40
L	Low	38	54	102
M	Middle	-	-	110
H	High	46	62	134
Straddle		-	-	142



Ch. #		Band I : 5150-5250 MHz	Band II : 5250-5350 MHz	Band III : 5470-5600 MHz and 5650-5725MHz
		802.11ac VHT20	802.11ac VHT20	802.11ac VHT20
L	Low	36	52	100
M	Middle	44	60	116
H	High	48	64	140
Straddle		-	-	144

Ch. #		Band I : 5150-5250 MHz	Band II : 5250-5350 MHz	Band III : 5470-5600 MHz and 5650-5725MHz
		802.11ac VHT40	802.11ac VHT40	802.11ac VHT40
L	Low	38	54	102
M	Middle	-	-	110
H	High	46	62	134
Straddle		-	-	142

Ch. #		Band I : 5150-5250 MHz	Band II : 5250-5350 MHz	Band III : 5470-5600 MHz and 5650-5725MHz
		802.11ac VHT80	802.11ac VHT80	802.11ac VHT80
L	Low	-	-	-
M	Middle	42	58	106
H	High	-	-	-
Straddle		-	-	138

2.4 Connection Diagram of Test System

<WLAN Tx Mode>

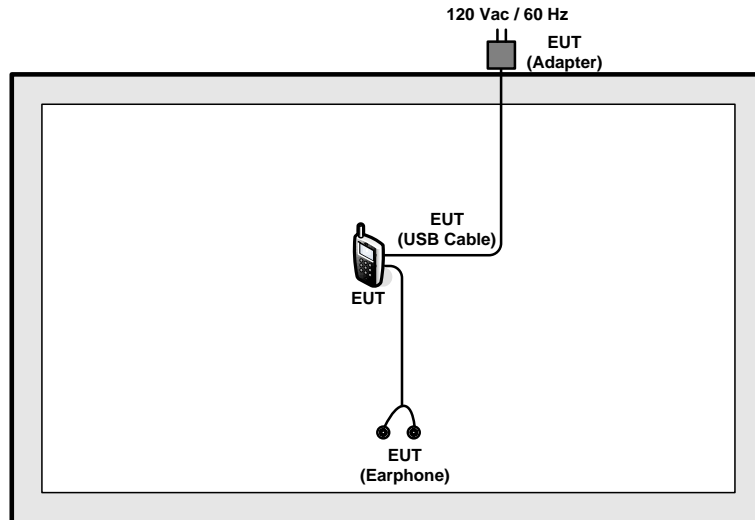

<AC Conducted Emission Mode>

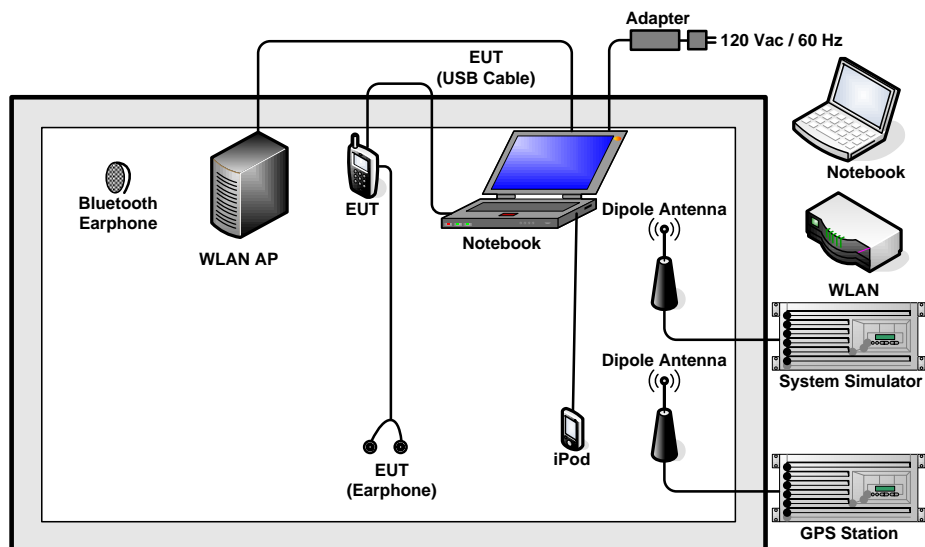



2.5 Support Unit used in test configuration and system

Item	Equipment	Trade Name	Model Name	FCC ID	Data Cable	Power Cord
1.	System Simulator	Anritsu	MT8820C	N/A	N/A	Unshielded, 1.8 m
2.	GPS Station	Pendulum	GSG-54	N/A	N/A	Unshielded, 1.8 m
3.	Bluetooth Earphone	Sony Ericsson	MW600	PY7DDA-2029	N/A	N/A
4.	WLAN AP	D-Link	DIR-865L	KA2IR865LA1	N/A	Unshielded, 1.8 m
5.	WLAN AP	D-Link	DIR-628	KA2DIR628A2	N/A	Unshielded, 1.8 m
6.	iPod	Apple	A1285	FCC DoC	Shielded, 1.0 m	N/A
7.	Notebook	DELL	P20G	FCC DoC/ Contains FCC ID:QDS-BRCM1051	N/A	AC I/P: Unshielded, 1.2 m DC O/P: Shielded, 1.8 m
8.	Notebook	DELL	Latitude E6320	FCC DoC/ Contains FCC ID: QDS-BRCM1054	N/A	AC I/P: Unshielded, 1.2 m DC O/P: Shielded, 1.8 m
9.	SD Card	SanDisk	MicroSD HC	FCC DoC	N/A	N/A

2.6 EUT Operation Test Setup

The programmed RF utility “HTC SSD”, is installed in EUT to provide channel selection, power level, data rate and the application type. RF Utility can send transmitting signal for all testing. The RF output power selection is for the setting of RF output power expected by the customer and is going to be fixed on the firmware of the final end product.

2.7 Measurement Results Explanation Example

For all conducted test items:

The offset level is set in the spectrum analyzer to compensate the RF cable loss and attenuator factor between EUT conducted output port and spectrum analyzer. With the offset compensation, the spectrum analyzer reading level is exactly the EUT RF output level.

Example :

The spectrum analyzer offset is derived from RF cable loss and attenuator factor.

$$\text{Offset} = \text{RF cable loss} + \text{attenuator factor}.$$

Following shows an offset computation example with cable loss 4.2 dB and 10dB attenuator.

$$\begin{aligned} \text{Offset(dB)} &= \text{RF cable loss(dB)} + \text{attenuator factor(dB)}. \\ &= 4.2 + 10 = 14.2 \text{ (dB)} \end{aligned}$$

3 Test Result

3.1 26dB & 99% Occupied Bandwidth Measurement

3.1.1 Description of 26dB & 99% Occupied Bandwidth

This section is for reporting purpose only.

There is no restriction limits for bandwidth.

For Straddle Channel, U-NII procedures were applied for operations in the frequency band in accordance with FCC KDB 644545 D03.

3.1.2 Measuring Instruments

The measuring equipment is listed in the section 4 of this test report.

3.1.3 Test Procedures

1. The testing follows FCC KDB 789033 D02 General UNII Test Procedures New Rules v01. Section C) Emission bandwidth
2. Set RBW = approximately 1% of the emission bandwidth.
3. Set the VBW > RBW.
4. Detector = Peak.
5. Trace mode = max hold
6. Measure the maximum width of the emission that is 26 dB down from the peak of the emission. Compare this with the RBW setting of the analyzer. Readjust RBW and repeat measurement as needed until the RBW/EBW ratio is approximately 1%.
7. For 99% Bandwidth Measurement, the spectrum analyzer's resolution bandwidth (RBW) is set 1MHz and set the Video bandwidth (VBW) $\geq 3 * RBW$.
8. Measure and record the results in the test report.

3.1.4 Test Setup

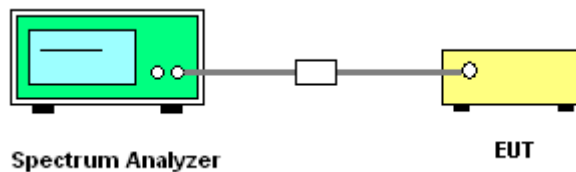



3.1.5 Test Result of 26dB & 99% Occupied Bandwidth Plots

Please refer to Appendix A.

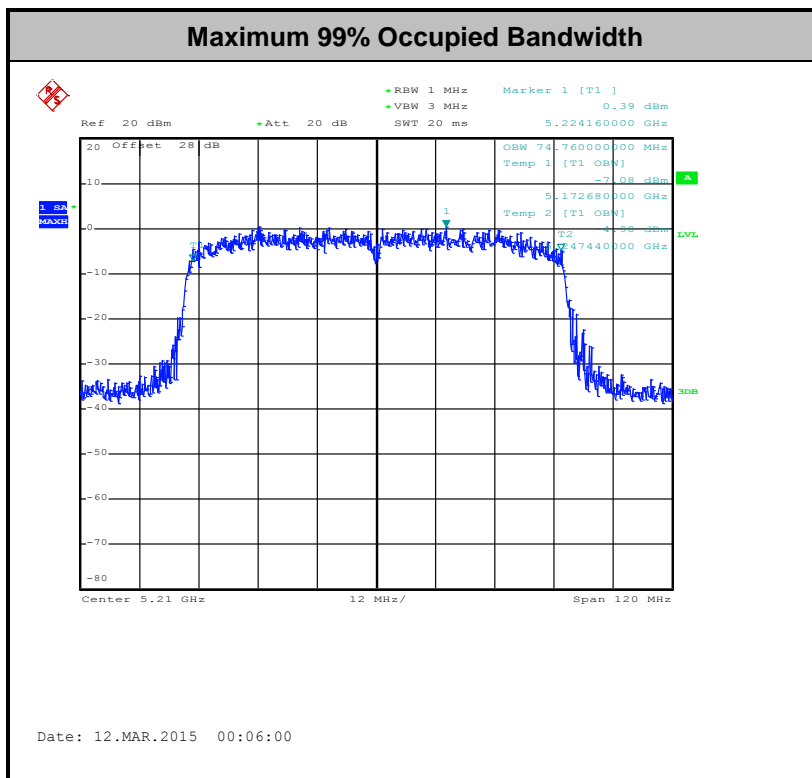
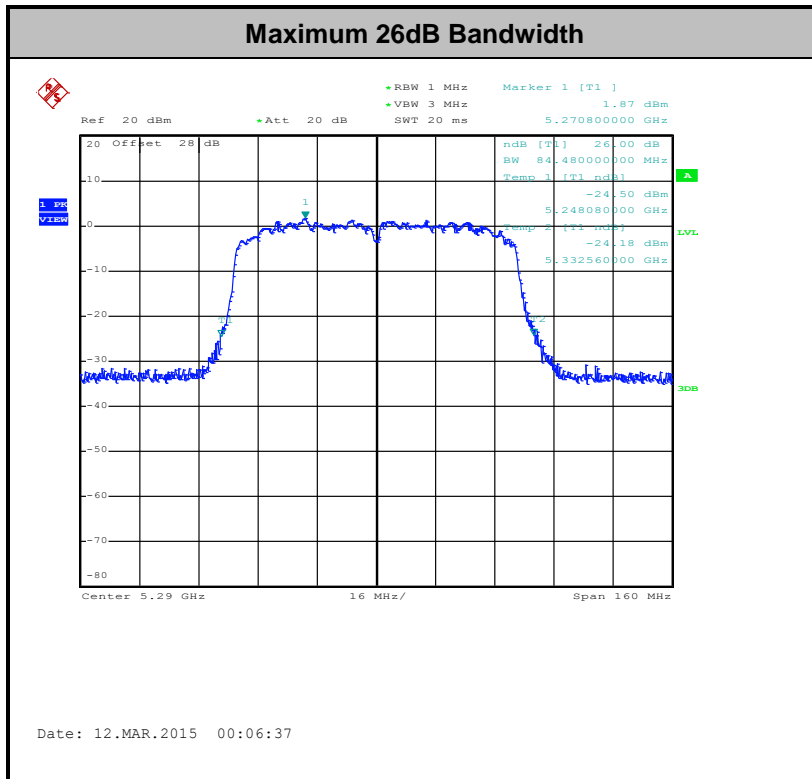



3.2 Maximum Conducted Output Power Measurement

3.2.1 Limit of Maximum Conducted Output Power

<FCC 14-30 CFR 15.407>

For mobile and portable client devices in the 5.15–5.25 GHz band, the maximum conducted output power over the frequency band of operation shall not exceed 250 mW.

For the 5.25–5.35 GHz and 5.47–5.725 GHz bands, the maximum conducted output power over the frequency bands of operation shall not exceed the lesser of 250 mW or 11 dBm 10 log B, where B is the 26 dB emission bandwidth in megahertz.

For the band 5.725–5.85 GHz, the maximum conducted output power over the frequency band of operation shall not exceed 1 W.

For Straddle Channel, U-NII procedures and limits were applied for operations in the frequency band in accordance with FCC KDB 644545 D03.

If transmitting antennas of directional gain greater than 6 dBi are used, the peak output power shall be reduced by the amount in dB that the directional gain of the antenna exceeds 6 dBi.

Note that U-NII-2 band, devices with a maximum e.i.r.p. greater than 500 mW shall implement TPC in order to have the capability to operate at least 6 dB below the maximum permitted e.i.r.p. of 1 W.

3.2.2 Measuring Instruments

The measuring equipment is listed in the section 4 of this test report.

3.2.3 Test Procedures

The testing follows Method PM of FCC KDB 789033 D02 General UNII Test Procedures New Rules v01.

Method PM (Measurement using an RF average power meter):

1. Measurement is performed using a wideband RF power meter.
2. The EUT is configured to transmit continuously with a consistent duty cycle at its maximum power control level.
3. Measure the average power of the transmitter, and the average power is corrected with duty factor, $10 \log(1/x)$, where x is the duty cycle.

For straddle channel, the testing follows Method SA-3 (RMS detection with max hold) of FCC KDB 789033 D02 General UNII Test Procedures New Rules v01.

Compute power by integrating the spectrum across the 99% occupied bandwidth of the signal using the instrument's band power measurement function.

3.2.4 Test Setup

For normal channel:

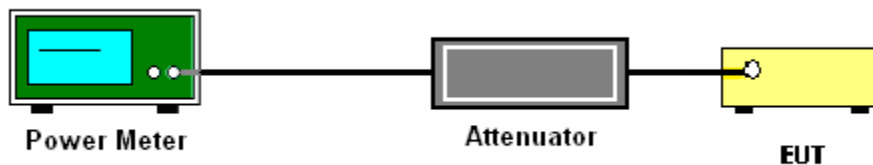

For straddle channel:

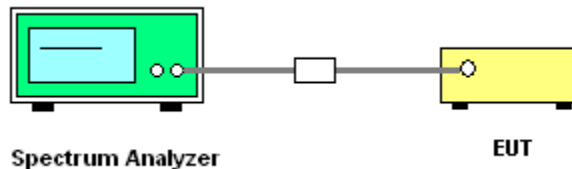

3.2.5 Test Result of Maximum Conducted Output Power

Please refer to Appendix A.

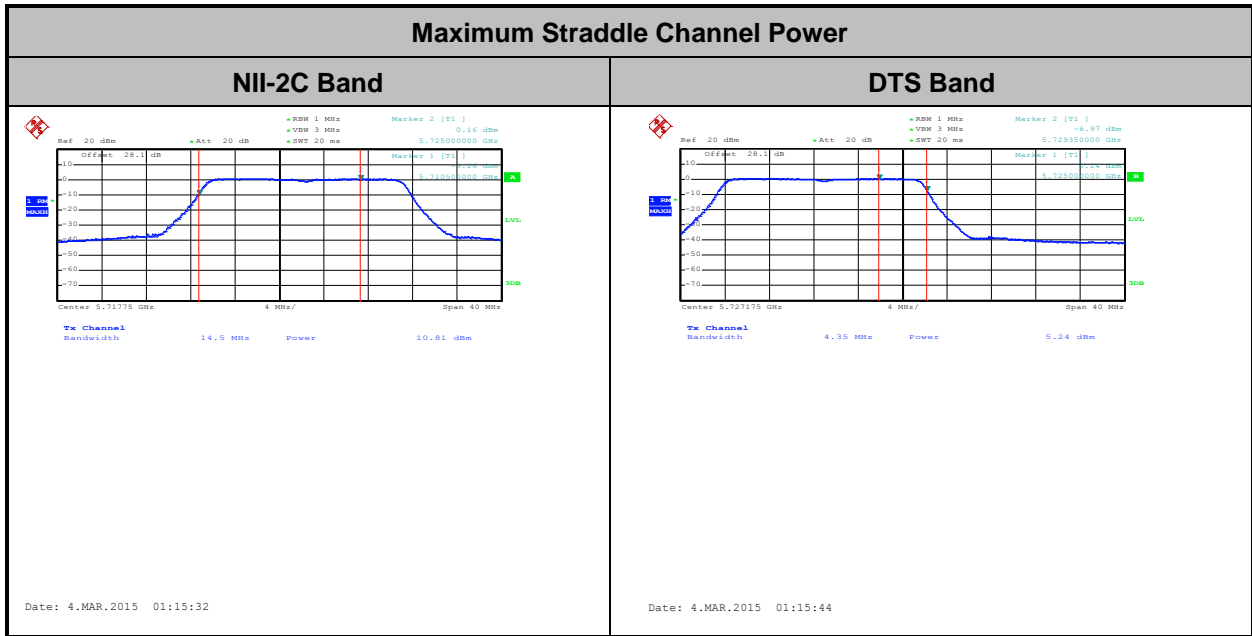



3.3 Power Spectral Density Measurement

3.3.1 Limit of Power Spectral Density

<FCC 14-30 CFR 15.407>

For mobile and portable client devices in the 5.15–5.25 GHz band, the maximum power spectral density shall not exceed 11dBm in any 1 megahertz band.

For the 5.25–5.35 GHz and 5.47–5.725 GHz bands, the maximum power spectral density shall not exceed 11 dBm in any 1 megahertz band.

For the band 5.725–5.85 GHz, the maximum power spectral density shall not exceed 30 dBm in any 500-kHz band.

For Straddle Channel, U-NII procedures and limits were applied for operations in the frequency band in accordance with FCC KDB 644545 D03.

If transmitting antennas of directional gain greater than 6 dBi are used, the peak output power shall be reduced by the amount in dB that the directional gain of the antenna exceeds 6 dBi.

3.3.2 Measuring Instruments

The measuring equipment is listed in the section 4 of this test report.

3.3.3 Test Procedures

The testing follows FCC KDB 789033 D02 General UNII Test Procedures New Rules v01.
Section F) Maximum power spectral density.

Method SA-2

(trace averaging across on and off times of the EUT transmissions, followed by duty cycle correction).

1. The testing follows Method SA-2 of FCC KDB 789033 D02 General UNII Test Procedures New Rules v01.
 - Measure the duty cycle.
 - Set span to encompass the entire emission bandwidth (EBW) of the signal.
 - Set RBW = 1 MHz.
 - Set VBW \geq 3 MHz.
 - Number of points in sweep \geq 2 Span / RBW.
 - Sweep time = auto.
 - Detector = RMS
 - Trace average at least 100 traces in power averaging mode.
 - Add $10 \log(1/x)$, where x is the duty cycle, to the measured power in order to compute the average power during the actual transmission times. For example, add $10 \log(1/0.25) = 6$ dB if the duty cycle is 25 percent.
2. The RF output of EUT was connected to the spectrum analyzer by a low loss cable.
3. Each plot has already offset with cable loss, and attenuator loss. Measure the PPSD and record it.

3.3.4 Test Setup

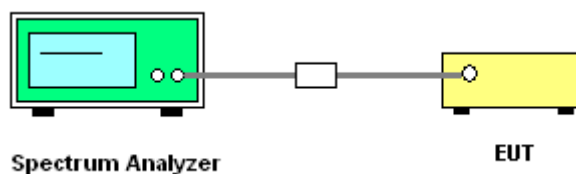



3.3.5 Test Result of Power Spectral Density

Please refer to Appendix A.

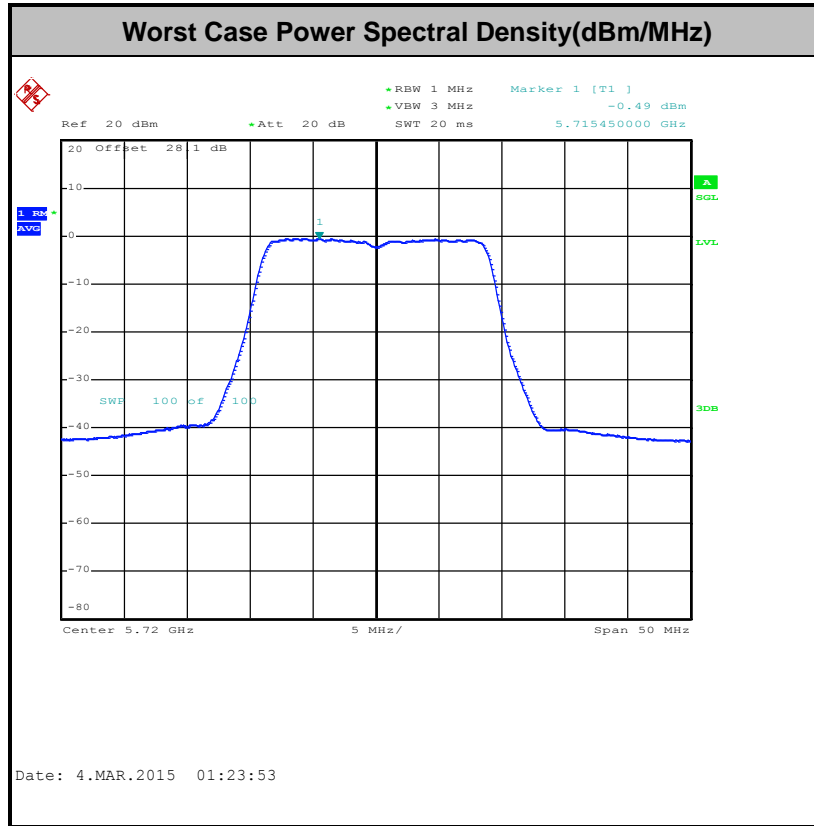

Note: Average Power Density (dB) = Measured value+ Duty Factor



3.4 Unwanted Radiated Emission Measurement

This section as specified in FCC Part 15.407(b) is to measure unwanted emissions through radiated measurement for band edge spurious emissions and out of band emissions measurement. The unwanted emissions shall comply with 15.407(b)(1) to (6), and restricted bands per FCC Part15.205.

3.4.1 Limit of Unwanted Emissions

(1) For transmitters operating in the 5150-5250 MHz band: all emissions outside of the 5150-5350 MHz band shall not exceed an EIRP of -27dBm/MHz.

For transmitters operating in the 5250-5350 MHz band: all emissions outside of the 5150-5350 MHz band shall not exceed an EIRP of -27 dBm/MHz. Devices operating in the 5250-5350 MHz band that generate emissions in the 5150-5250 MHz band must meet all applicable technical requirements for operation in the 5150-5250 MHz band (including indoor use) or alternatively meet an out-of-band emission EIRP limit of -27 dBm/MHz in the 5150-5250 MHz band.

For transmitters operating in the 5470-5600 MHz and 5650-5725MHz band: all emissions outside of the 5470-5600 MHz and 5650-5725MHz band shall not exceed an EIRP of -27 dBm/MHz.

(2) Unwanted spurious emissions fallen in restricted bands per FCC Part15.205 shall comply with the general field strength limits set forth in § 15.209 as below table,

Frequency (MHz)	Field Strength (microvolts/meter)	Measurement Distance (meters)
0.009 – 0.490	2400/F(kHz)	300
0.490 – 1.705	24000/F(kHz)	30
1.705 – 30.0	30	30
30 – 88	100	3
88 – 216	150	3
216 - 960	200	3
Above 960	500	3

Note: The following formula is used to convert the EIRP to field strength.

$$E = \frac{1000000\sqrt{30P}}{3} \mu\text{V/m, where P is the eirp (Watts)}$$



EIRP (dBm)	Field Strength at 3m (dBµV/m)
-17	78.3
- 27	68.3

(3) KDB789033 v01 G)2)c) As specified in 15.407(b), emissions above 1000 MHz that are outside of the restricted bands are subject to a peak emission limit of -27 dBm/MHz (or -17 dBm/MHz as specified in 15.407(b)(4)). However, an out-of-band emission that complies with both the average and peak limits of 15.209 is not required to satisfy the -27 dBm/MHz or -17 dBm/MHz peak emission limit.

3.4.2 Measuring Instruments

The measuring equipment is listed in the section 4 of this test report.



3.4.3 Test Procedures

1. The testing follows FCC KDB 789033 D02 General UNII Test Procedures New Rules v01. Section G) Unwanted emissions measurement.

(1) Procedure for Unwanted Emissions Measurements Below 1000MHz

- RBW = 120 kHz
• VBW = 300 kHz
• Detector = Peak
• Trace mode = max hold

(2) Procedure for Peak Unwanted Emissions Measurements Above 1000 MHz

- RBW = 1 MHz
• VBW ≥ 3 MHz
• Detector = Peak
• Sweep time = auto
• Trace mode = max hold

(3) Procedures for Average Unwanted Emissions Measurements Above 1000MHz

- RBW = 1 MHz
• VBW = 10 Hz, when duty cycle is no less than 98 percent.
• VBW ≥ 1/T, when duty cycle is less than 98 percent where T is the minimum transmission duration over which the transmitter is on and is transmitting at its maximum power control level for the tested mode of operation.

Table with 5 columns: Band, Duty Cycle(%), T(μs), 1/T(kHz), VBW Setting. Rows include 802.11a, 802.11n HT20, 802.11n HT40, 802.11n VHT20, 802.11n VHT40, and 802.11n VHT80.

- 2. The EUT was placed on a turntable with 0.8 meter for frequency below 1GHz and 1.5 meter for frequency above 1GHz respectively above ground.
3. The EUT was set 3 meters from the interference receiving antenna which was mounted on the top of a variable height antenna tower.
4. The antenna is a broadband antenna and its height is adjusted between one meter and four meters above ground to find the maximum value of the field strength for both horizontal polarization and vertical polarization of the antenna.

5. For each suspected emission, the EUT was arranged to its worst case and then adjust the antenna tower (from 1 m to 4 m) and turntable (from 0 degree to 360 degrees) to find the maximum reading.
6. For testing below 1GHz, if the emission level of the EUT in peak mode was 3 dB lower than the limit specified, then peak values of EUT will be reported, otherwise, the emissions will be repeated one by one using the CISPR quasi-peak method and reported.
7. For testing above 1GHz, the emission level of the EUT in peak mode was 20dB lower than average limit (that means the emission level in average mode also complies with the limit in average mode), then peak values of EUT will be reported, otherwise, the emissions will be measured in average mode again and reported.

3.4.4 Test Setup

For radiated emissions below 30MHz

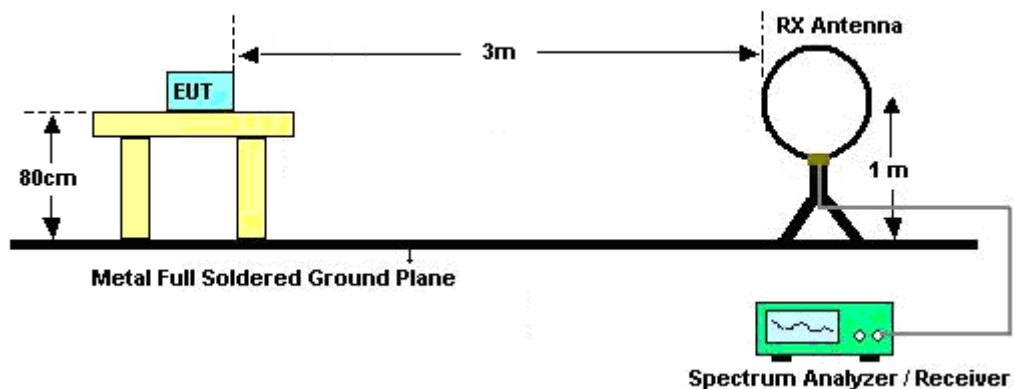

For radiated emissions from 30MHz to 1GHz

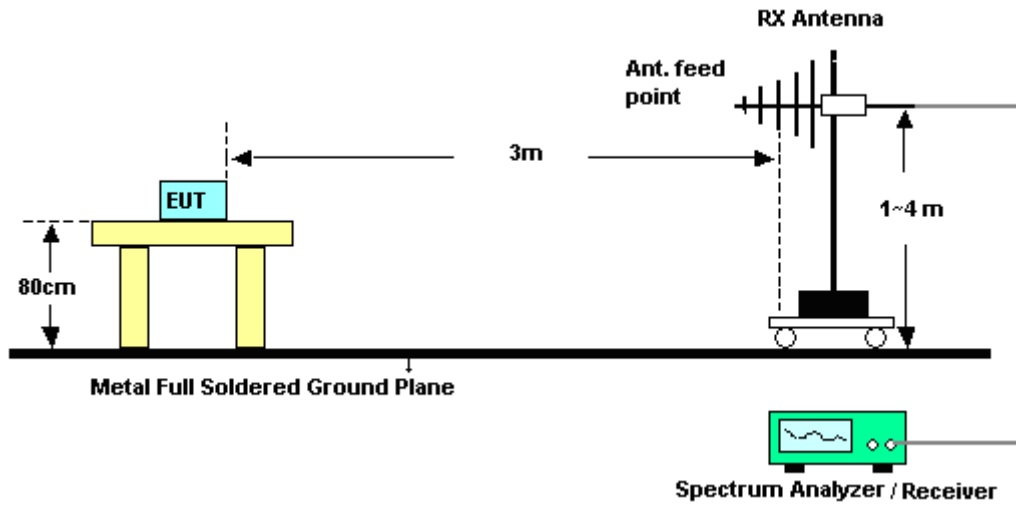

For radiated emissions above 1GHz

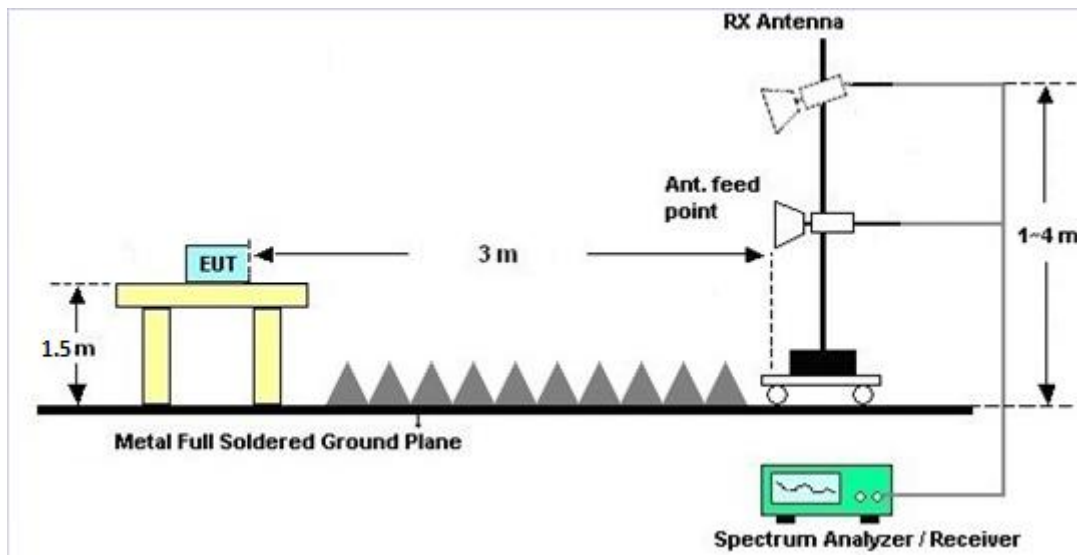

3.4.5 Test Results of Radiated Emissions (9 kHz ~ 30 MHz)

The low frequency, which started from 9 kHz to 30MHz, was pre-scanned and the result which was 20dB lower than the limit line per 15.31(o) was not reported.



3.4.6 Test Result of Radiated Band Edges

Please refer to Appendix B.

3.4.7 Test Result of Unwanted Radiated Emission (30MHz ~ 10th Harmonic)

Please refer to Appendix B.



3.5 AC Conducted Emission Measurement

3.5.1 Limit of AC Conducted Emission

For equipment that is designed to be connected to the public utility (AC) power line, the radio frequency voltage that is conducted back onto the AC power line on any frequency or frequencies within the band 150 kHz to 30 MHz shall not exceed the limits in the following table.

Frequency of emission (MHz)	Conducted limit (dB μ V)	
	Quasi-peak	Average
0.15-0.5	66 to 56*	56 to 46*
0.5-5	56	46
5-30	60	50

*Decreases with the logarithm of the frequency.

3.5.2 Measuring Instruments

The measuring equipment is listed in the section 4 of this test report.

3.5.3 Test Procedures

1. The EUT was placed 0.4 meter from the conducting wall of the shielding room was kept at least 80 centimeters from any other grounded conducting surface.
2. Connect EUT to the power mains through a line impedance stabilization network (LISN).
3. All the support units are connecting to the other LISN.
4. The LISN provides 50 ohm coupling impedance for the measuring instrument.
5. The FCC states that a 50 ohm, 50 microhenry LISN should be used.
6. Both sides of AC line were checked for maximum conducted interference.
7. The frequency range from 150 kHz to 30 MHz was searched.
8. Set the test-receiver system to Peak Detect Function and specified bandwidth with Maximum Hold Mode.

3.5.4 Test Setup

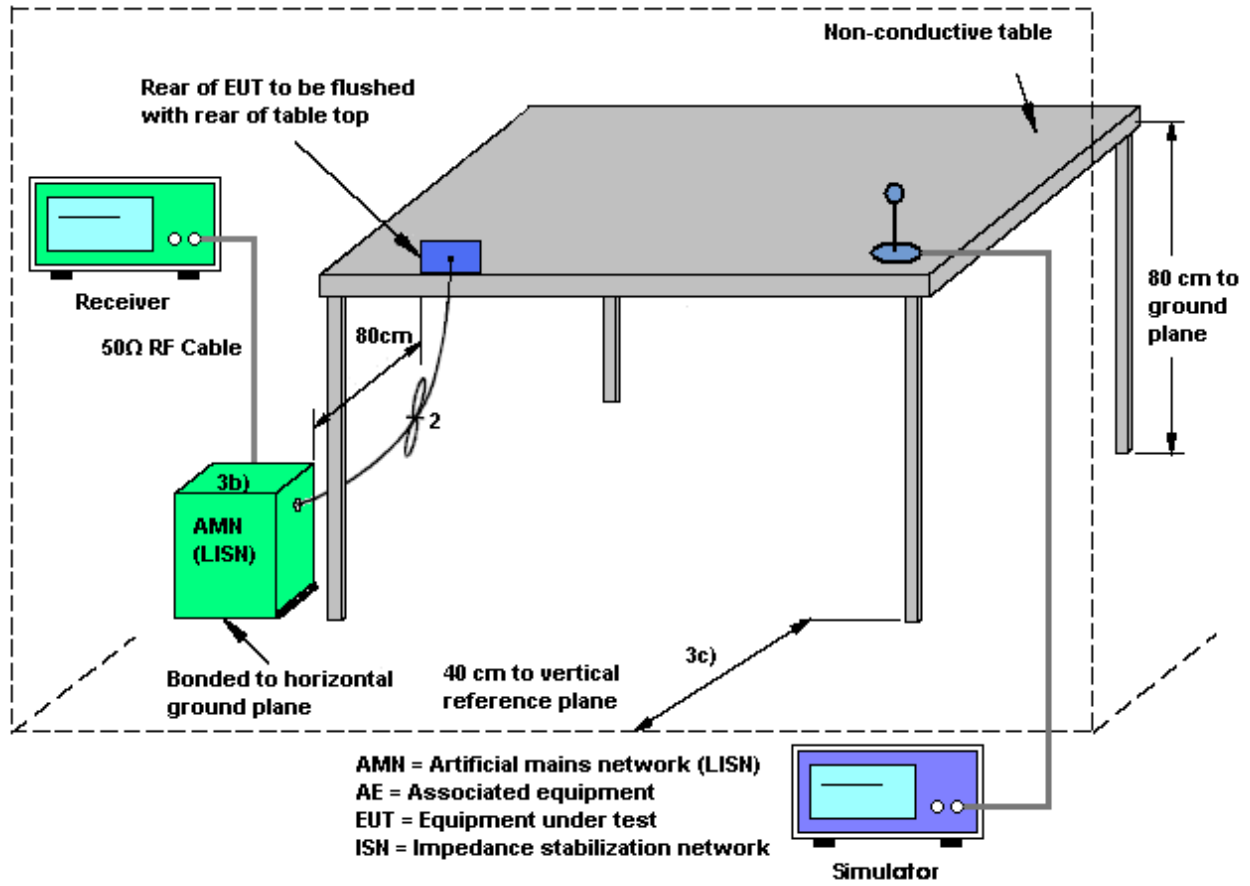



3.5.5 Test Result of AC Conducted Emission

Test Mode :	Mode 1	Temperature :	21~23°C
Test Engineer :	Eric Jeng	Relative Humidity :	46~48%
Test Voltage :	120Vac / 60Hz	Phase :	Line
Function Type :	WCDMA Band II Idle + Bluetooth Link + WLAN (5GHz) Link + Earphone 1 + USB Cable 2 (Data Link with Notebook) + GPS Rx		

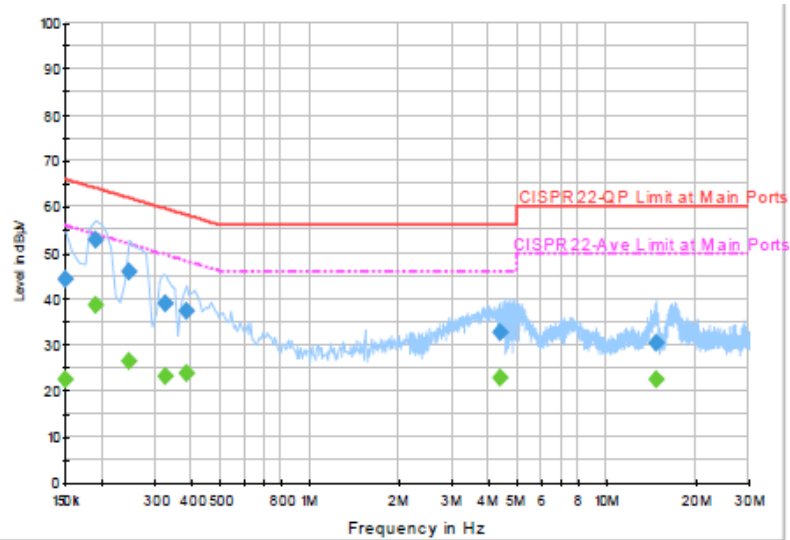

Final Result : QuasiPeak

Frequency (MHz)	QuasiPeak (dBµV)	Filter	Line	Corr. (dB)	Margin (dB)	Limit (dBµV)
0.150000	44.3	Off	L1	19.5	21.7	66.0
0.190000	52.7	Off	L1	19.4	11.3	64.0
0.246000	45.7	Off	L1	19.4	16.2	61.9
0.326000	39.0	Off	L1	19.5	20.6	59.6
0.382000	37.4	Off	L1	19.5	20.8	58.2
4.350000	32.8	Off	L1	19.7	23.2	56.0
14.582000	30.4	Off	L1	19.9	29.6	60.0

Final Result : Average

Frequency (MHz)	Average (dBµV)	Filter	Line	Corr. (dB)	Margin (dB)	Limit (dBµV)
0.150000	22.4	Off	L1	19.5	33.6	56.0
0.190000	38.7	Off	L1	19.4	15.3	54.0
0.246000	26.4	Off	L1	19.4	25.5	51.9
0.326000	23.2	Off	L1	19.5	26.4	49.6
0.382000	23.9	Off	L1	19.5	24.3	48.2
4.350000	22.9	Off	L1	19.7	23.1	46.0
14.582000	22.3	Off	L1	19.9	27.7	50.0



Test Mode :	Mode 1	Temperature :	21~23°C
Test Engineer :	Eric Jeng	Relative Humidity :	46~48%
Test Voltage :	120Vac / 60Hz	Phase :	Neutral
Function Type :	WCDMA Band II Idle + Bluetooth Llnk + WLAN (5GHz) Link + Earphone 1 + USB Cable 2 (Data Link with Notebook) + GPS Rx		

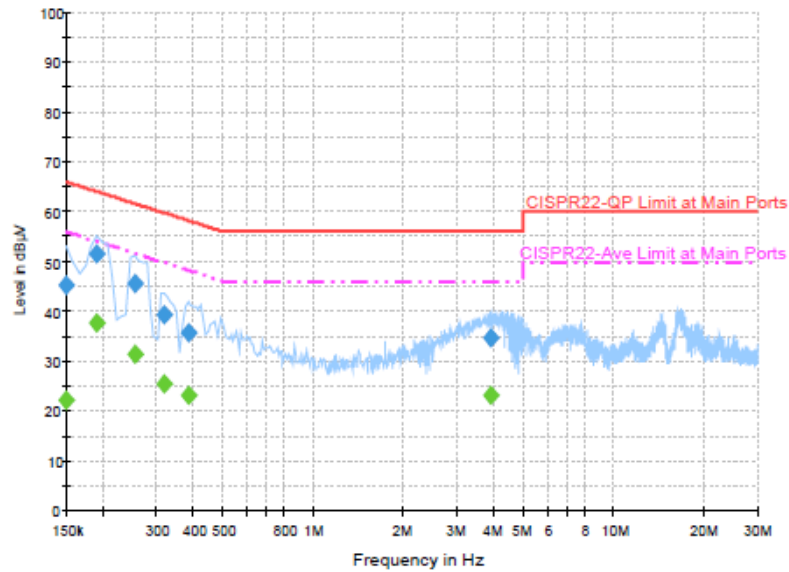

Final Result : QuasiPeak

Frequency (MHz)	QuasiPeak (dBµV)	Filter	Line	Corr. (dB)	Margin (dB)	Limit (dBµV)
0.150000	45.2	Off	N	19.5	20.8	66.0
0.190000	51.5	Off	N	19.4	12.5	64.0
0.254000	45.7	Off	N	19.5	15.9	61.6
0.318000	39.3	Off	N	19.5	20.5	59.8
0.382000	35.5	Off	N	19.5	22.7	58.2
3.894000	34.6	Off	N	19.7	21.4	56.0

Final Result : Average

Frequency (MHz)	Average (dBµV)	Filter	Line	Corr. (dB)	Margin (dB)	Limit (dBµV)
0.150000	22.1	Off	N	19.5	33.9	56.0
0.190000	37.6	Off	N	19.4	16.4	54.0
0.254000	31.4	Off	N	19.5	20.2	51.6
0.318000	25.4	Off	N	19.5	24.4	49.8
0.382000	23.0	Off	N	19.5	25.2	48.2
3.894000	23.1	Off	N	19.7	22.9	46.0

3.6 Frequency Stability Measurement

3.6.1 Limit of Frequency Stability

Manufacturers of U-NII devices are responsible for ensuring frequency stability such that an emission is maintained within the band of operation under all conditions of normal operation as specified in the user's manual.

3.6.2 Measuring Instruments

The measuring equipment is listed in the section 4 of this test report.

3.6.3 Test Procedures

1. To ensure emission at the band edge is maintained within the authorized band, those values shall be measured by radiation emissions at upper and lower frequency points, and finally compensated by frequency deviation as procedures below.
2. The EUT was operated at the maximum output power, and connected to the spectrum analyzer, which is set to maximum hold function and peak detector. The peak value of the power envelope was measured and noted. The upper and lower frequency points were respectively measured relatively 10dB lower than the measured peak value.
3. The frequency deviation was calculated by adding the upper frequency point and the lower frequency point divided by two. Those detailed values of frequency deviation are provided in table below.

3.6.4 Test Setup

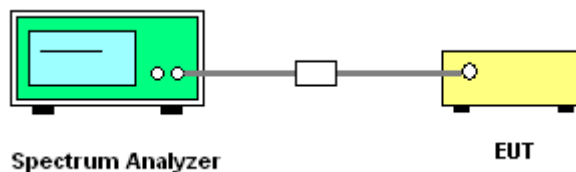

3.6.5 Test Result of Frequency Stability

Please refer to Appendix A.



3.7 Automatically Discontinue Transmission

3.7.1 Limit of Automatically Discontinue Transmission

The device shall automatically discontinue transmission in case of either absence of information to transmit or operational failure. These provisions are not intended to preclude the transmission of control or signaling information or the use of repetitive codes used by certain digital technologies to complete frame or burst intervals. Applicants shall include in their application for equipment authorization to describe how this requirement is met.

3.7.2 Measuring Instruments

The measuring equipment is listed in the section 4 of this test report.

3.7.3 Test Result of Automatically Discontinue Transmission

While the EUT is not transmitting any information, the EUT can automatically discontinue transmission and become standby mode for power saving. The EUT can detect the controlling signal of ACK message transmitting from remote device and verify whether it shall resend or discontinue transmission.



3.8 Antenna Requirements

3.8.1 Standard Applicable

According to FCC 47 CFR Section 15.407(a)(1)(2) ,if transmitting antenna directional gain is greater than 6 dBi, both the peak transmit power and the peak power spectral density shall be reduced by the amount in dB that the directional gain of the antenna exceeds 6 dBi.

3.8.2 Antenna Anti-Replacement Construction

An embedded-in antenna design is used.

3.8.3 Antenna Gain

The antenna gain is less than 6 dBi. Therefore, it is not necessary to reduce maximum peak output power limit.



4 List of Measuring Equipments

Instrument	Manufacturer	Model No.	Serial No.	Characteristics	Calibration Date	Test Date	Due Date	Remark
Spectrum Analyzer	Rohde & Schwarz	FSP40	100055	9kHz~40GHz	Jun. 09, 2014	Feb. 09, 2015~ Mar. 12, 2015	Jun. 08, 2015	Conducted (TH02-HY)
Power Meter	Anritsu	ML2495A	1036004	300MHz~40GHz	Aug. 09, 2014	Feb. 09, 2015~ Mar. 12, 2015	Aug. 08, 2015	Conducted (TH02-HY)
Power Sensor	Anritsu	MA2411B	1027253	300MHz~40GHz	Aug. 09, 2014	Feb. 09, 2015~ Mar. 12, 2015	Aug. 08, 2015	Conducted (TH02-HY)
Spectrum Analyzer	Rohde & Schwarz	FSP40	100055	9kHz~40GHz	Jun. 09, 2014	Feb. 15, 2015~ Mar. 13, 2015	Jun. 08, 2015	Radiation (03CH07-HY)
EMI Test Receiver	Rohde & Schwarz	ESCI 7	100724	9 kHz~7 GHz	Aug. 30, 2014	Feb. 15, 2015~ Mar. 13, 2015	Aug. 29, 2015	Radiation (03CH07-HY)
Loop Antenna	R&S	HFH2-Z2	100315	9 kHz~30 MHz	Jul. 28, 2014	Feb. 15, 2015~ Mar. 13, 2015	Jul. 27, 2015	Radiation (03CH07-HY)
Bilog Antenna	Schaffner	CBL6111C	2726	30MHz ~ 1GHz	Sep. 27, 2014	Feb. 15, 2015~ Mar. 13, 2015	Sep. 26, 2015	Radiation (03CH07-HY)
Double Ridge Horn Antenna	ESCO	3117	75962	1GHz~18GHz	Aug. 19, 2014	Feb. 15, 2015~ Mar. 13, 2015	Aug. 18, 2015	Radiation (03CH07-HY)
SHF-EHF Horn Antenna	SCHWARZBECK	BBHA 9170	BBHA9170251	18GHz~40GHz	Oct. 02, 2014	Feb. 15, 2015~ Mar. 13, 2015	Oct. 01, 2015	Radiation (03CH07-HY)
Preamplifier	COM-POWER	PA-103A	161241	10 MHz ~ 1000MHz	Mar. 17, 2014	Feb. 15, 2015~ Mar. 13, 2015	Mar. 16, 2015	Radiation (03CH07-HY)
Preamplifier	Agilent	8449B	3008A02362	1 GHz~26.5 GHz	Oct. 21, 2014	Feb. 15, 2015~ Mar. 13, 2015	Oct. 20, 2015	Radiation (03CH07-HY)
Preamplifier	MITEQ	AMF-7D-0010 1800-30-10P	1590074	DC~18 GHz	Jul. 07, 2014	Feb. 15, 2015~ Mar. 13, 2015	Jul. 06, 2015	Radiation (03CH07-HY)
Preamplifier	MITEQ	AMF-7D-0010 1800-30-10P	1590075	DC~18 GHz	Apr. 21, 2014	Feb. 15, 2015~ Mar. 13, 2015	Apr. 20, 2015	Radiation (03CH07-HY)
Turn Table	ChainTek	ChainTek 3000	N/A	0 ~ 360 degree	N/A	Feb. 15, 2015~ Mar. 13, 2015	N/A	Radiation (03CH07-HY)
Antenna Mast	ChainTek	ChainTek 3000	N/A	N/A	N/A	Feb. 15, 2015~ Mar. 13, 2015	N/A	Radiation (03CH07-HY)
EMI Test Receiver	Rohde & Schwarz	ESCS 30	100356	9kHz ~ 2.75GHz	Dec. 01, 2014	Feb. 17, 2015	Nov. 30, 2015	Conduction (CO05-HY)
LISN (for auxiliary equipment)	Rohde & Schwarz	ENV216	100081	9kHz ~ 30MHz	Dec. 08, 2014	Feb. 17, 2015	Dec. 07, 2015	Conduction (CO05-HY)
LISN	Rohde & Schwarz	ENV216	100080	9kHz ~ 30MHz	Dec. 02, 2014	Feb. 17, 2015	Dec. 01, 2015	Conduction (CO05-HY)
AC Power Source	ChainTek	APC-1000W	N/A	N/A	N/A	Feb. 17, 2015	N/A	Conduction (CO05-HY)



5 Uncertainty of Evaluation

Uncertainty of Conducted Emission Measurement (150kHz ~ 30MHz)

Measuring Uncertainty for a Level of Confidence of 95% ($U = 2Uc(y)$)	2.26
---	------

Uncertainty of Radiated Emission Measurement (30 MHz ~ 1000 MHz)

Measuring Uncertainty for a Level of Confidence of 95% ($U = 2Uc(y)$)	4.50
---	------



Appendix A. Conducted Test Results