



A D T

# FCC SAR Test Report

**Report No.** : SA141203C11  
**Applicant** : HTC Corporation  
**Address** : 1F, 6-3 Baoqiang Road, Xindian District, New Taipei City, Taiwan 231  
**Product** : Smartphone  
**FCC ID** : NM80PJA200  
**Brand** : HTC  
**Model No.** : 0PJA200  
**Standards** : FCC 47 CFR Part 2 (2.1093) / IEEE C95.1:1992 / IEEE 1528:2003  
IEEE 1528a-2005 / KDB 865664 D01 v01r03 / KDB 248227 D01 v01r02  
KDB 447498 D01 v05r02 / KDB 648474 D04 v01r02 / KDB 941225 D01 v02  
KDB 941225 D05 v02r03 / KDB 941225 D06 v01r01  
**Sample Received Date** : Dec. 03, 2014  
**Date of Testing** : Jan. 04, 2015 ~ Jan. 24, 2015

**CERTIFICATION:** The above equipment have been tested by **Bureau Veritas Consumer Products Services (H.K.) Ltd., Taoyuan Branch – Lin Kou Laboratories**, and found compliance with the requirement of the above standards. The test record, data evaluation & Equipment Under Test (EUT) configurations represented herein are true and accurate accounts of the measurements of the sample's SAR characteristics under the conditions specified in this report. It should not be reproduced except in full, without the written approval of our laboratory. The client should not use it to claim product certification, approval, or endorsement by TAF or any government agencies.

**Prepared By :**   
Ivonne Wu / Supervisor

**Approved By :**   
Roy Wu / Manager



This report is for your exclusive use. Any copying or replication of this report to or for any other person or entity, or use of our name or trademark, is permitted only with our prior written permission. This report sets forth our findings solely with respect to the test samples identified herein. The results set forth in this report are not indicative or representative of the quality or characteristics of the lot from which a test sample was taken or any similar or identical product unless specifically and expressly noted. Our report includes all of the tests requested by you and the results thereof based upon the information that you provided to us. You have 60 days from date of issuance of this report to notify us of any material error or omission caused by our negligence, provided, however, that such notice shall be in writing and shall specifically address the issue you wish to raise. A failure to raise such issue within the prescribed time shall constitute your unqualified acceptance of the completeness of this report, the tests conducted and the correctness of the report contents. Unless specific mention, the uncertainty of measurement has been explicitly taken into account to declare the compliance or non-compliance to the specification.



## Table of Contents

Release Control Record .....	3
1. Summary of Maximum SAR Value .....	4
2. Description of Equipment Under Test .....	5
3. SAR Measurement System .....	6
3.1 Definition of Specific Absorption Rate (SAR) .....	6
3.2 SPEAG DASY System .....	6
3.2.1 Robot .....	7
3.2.2 Probes .....	8
3.2.3 Data Acquisition Electronics (DAE) .....	8
3.2.4 Phantoms .....	9
3.2.5 Device Holder .....	10
3.2.6 System Validation Dipoles .....	10
3.2.7 Tissue Simulating Liquids .....	11
3.3 SAR System Verification .....	14
3.4 SAR Measurement Procedure .....	15
3.4.1 Area & Zoom Scan Procedure .....	15
3.4.2 Volume Scan Procedure .....	15
3.4.3 Power Drift Monitoring .....	16
3.4.4 Spatial Peak SAR Evaluation .....	16
3.4.5 SAR Averaged Methods .....	16
4. SAR Measurement Evaluation .....	17
4.1 EUT Configuration and Setting .....	17
4.2 EUT Testing Position .....	19
4.2.1 Head Exposure Conditions .....	19
4.2.2 Body-Worn Accessory Exposure Conditions .....	21
4.2.3 Hotspot Mode Exposure conditions .....	22
4.2.4 SAR Test Exclusions .....	22
4.3 Tissue Verification .....	23
4.4 System Validation .....	24
4.5 System Verification .....	25
4.6 Maximum Output Power .....	26
4.6.1 Maximum Conducted Power .....	26
4.6.2 Measured Conducted Power Result .....	26
4.7 SAR Testing Results .....	37
4.7.1 SAR Results for Head .....	37
4.7.2 SAR Results for Body-Worn (Separation Distance is 1.0 cm Gap) .....	40
4.7.3 SAR Results for Hotspot (Separation Distance is 1.0 cm Gap) .....	42
4.7.4 SAR Measurement Variability .....	46
4.7.5 Simultaneous Multi-band Transmission Evaluation .....	46
5. Calibration of Test Equipment .....	56
6. Measurement Uncertainty .....	57
7. Information on the Testing Laboratories .....	59

- Appendix A. SAR Plots of System Verification
- Appendix B. SAR Plots of SAR Measurement
- Appendix C. Calibration Certificate for Probe and Dipole
- Appendix D. Photographs of EUT and Setup



## Release Control Record

Report No.	Reason for Change	Date Issued
SA141203C11	Initial release	Feb. 08, 2015



# FCC SAR Test Report

## 1. Summary of Maximum SAR Value

Equipment Class	Mode	Highest Reported Head SAR <sub>1g</sub> (W/kg)	Highest Reported Body-Worn SAR <sub>1g</sub> (1.0 cm Gap) (W/kg)	Highest Reported Hotspot SAR <sub>1g</sub> (1.0 cm Gap) (W/kg)
PCE	CDMA BC0	0.56	0.35	0.35
	CDMA BC1	0.37	0.13	0.22
	CDMA BC10	0.54	0.27	0.27
	LTE 2	0.27	0.11	0.18
	LTE 4	0.38	0.13	0.13
	LTE 12	0.20	0.11	0.11
	LTE 25	0.28	0.17	0.19
	LTE 26	0.56	0.21	0.21
	LTE 41	0.25	0.13	0.13
DTS	2.4G WLAN	0.24	0.03	0.03
NII	5.2G WLAN	0.55	0.06	N/A
	5.3G WLAN	0.58	0.08	N/A
	5.6G WLAN	0.36	0.04	N/A
	5.8G WLAN	0.31	0.04	N/A
DSS	Bluetooth	N/A	N/A	N/A
DXX	NFC	N/A	N/A	N/A
Highest Simultaneous Transmission SAR		Head (W/kg)	Body-Worn (W/kg)	Hotspot (W/kg)
PCE+DTS		0.64	0.36	0.36
PCE+NII		0.89	0.38	N/A
PCE+DSS		N/A	0.54	N/A

### Note:

- The SAR limit (Head & Body: SAR<sub>1g</sub> 1.6 W/kg) for general population / uncontrolled exposure is specified in FCC 47 CFR part 2 (2.1093) and ANSI/IEEE C95.1-1992.



# FCC SAR Test Report

## 2. Description of Equipment Under Test

<b>EUT Type</b>	Smartphone
<b>FCC ID</b>	NM80PJA200
<b>Brand Name</b>	HTC
<b>Model Name</b>	0PJA200
<b>Tx Frequency Bands (Unit: MHz)</b>	CDMA BC0 : 824.7 ~ 848.31 CDMA BC1 : 1851.25 ~ 1908.75 CDMA BC10 : 817.9 ~ 823.1 LTE Band 2 : 1850.7 ~ 1909.3 (1.4M), 1851.5 ~ 1908.5 (3M), 1852.5 ~ 1907.5 (5M), 1855 ~ 1905 (10M), 1857.5 ~ 1902.5 (15M), 1860 ~ 1900 (20M) LTE Band 4 : 1710.7 ~ 1754.3 (1.4M), 1711.5 ~ 1753.5 (3M), 1712.5 ~ 1752.5 (5M), 1715 ~ 1750 (10M), 1717.5 ~ 1747.5 (15M), 1720 ~ 1745 (20M) LTE Band 12 : 699.7 ~ 715.3 (1.4M), 700.5 ~ 714.5 (3M), 701.5 ~ 713.5 (5M), 704 ~ 711 (10M) LTE Band 25 : 1850.7 ~ 1914.3 (1.4M), 1851.5 ~ 1913.5 (3M), 1852.5 ~ 1912.5 (5M), 1855 ~ 1910 (10M), 1857.5 ~ 1907.5 (15M), 1860 ~ 1905 (20M) LTE Band 26 : 814.7 ~ 848.3 (1.4M), 815.5 ~ 847.5 (3M), 816.5 ~ 846.5 (5M), 819 ~ 844 (10M), 821.5 ~ 841.5 (15M) LTE Band 41 : 2498.5 ~ 2687.5 (5M), 2501 ~ 2685 (10M), 2503.5 ~ 2682.5 (15M), 2506 ~ 2680 (20M) WLAN : 2412 ~ 2462, 5180 ~ 5240, 5260 ~ 5320, 5500 ~ 5700, 5745 ~ 5825 Bluetooth : 2402 ~ 2480 NFC : 13.56
<b>Uplink Modulations</b>	CDMA : QPSK LTE : QPSK, 16QAM 802.11b : DSSS 802.11a/g/n/ac : OFDM Bluetooth : GFSK NFC : ASK
<b>Maximum Tune-up Conducted Power (Unit: dBm)</b>	CDMA BC0 : 25.0 CDMA BC1 : 24.5 CDMA BC10 : 24.5 LTE Band 2 : 24.5 LTE Band 4 : 23.5 LTE Band 12 : 22.5 LTE Band 25 : 24.5 LTE Band 26 : 22.5 LTE Band 41 : 24.5 WLAN 2.4G : 18.5 WLAN 5.2G : 16.0 WLAN 5.3G : 16.5 WLAN 5.6G : 16.5 WLAN 5.8G : 16.0 Bluetooth : 9.6
<b>Antenna Type</b>	Fixed Internal Antenna
<b>EUT Stage</b>	Identical Prototype

### Note:

1. The above EUT information is declared by manufacturer and for more detailed features description please refers to the manufacturer's specifications or User's Manual.

### **3. SAR Measurement System**

#### **3.1 Definition of Specific Absorption Rate (SAR)**

SAR is related to the rate at which energy is absorbed per unit mass in an object exposed to a radio field. The SAR distribution in a biological body is complicated and is usually carried out by experimental techniques or numerical modeling. The standard recommends limits for two tiers of groups, occupational/controlled and general population/uncontrolled, based on a person's awareness and ability to exercise control over his or her exposure. In general, occupational/controlled exposure limits are higher than the limits for general population/uncontrolled.

The SAR definition is the time derivative (rate) of the incremental energy (dW) absorbed by (dissipated in) an incremental mass (dm) contained in a volume element (dv) of a given density ( $\rho$ ). The equation description is as below:

$$SAR = \frac{d}{dt} \left( \frac{dW}{dm} \right) = \frac{d}{dt} \left( \frac{dW}{\rho dv} \right)$$

SAR is expressed in units of Watts per kilogram (W/kg)

SAR measurement can be related to the electrical field in the tissue by

$$SAR = \frac{\sigma |E|^2}{\rho}$$

Where:  $\sigma$  is the conductivity of the tissue,  $\rho$  is the mass density of the tissue and E is the RMS electrical field strength.

#### **3.2 SPEAG DASY System**

DASY system consists of high precision robot, probe alignment sensor, phantom, robot controller, controlled measurement server and near-field probe. The robot includes six axes that can move to the precision position of the DASY4/5 software defined. The DASY software can define the area that is detected by the probe. The robot is connected to controlled box. Controlled measurement server is connected to the controlled robot box. The DAE includes amplifier, signal multiplexing, AD converter, offset measurement and surface detection. It is connected to the Electro-optical coupler (ECO). The ECO performs the conversion from the optical into digital electric signal of the DAE and transfers data to the PC.

# FCC SAR Test Report

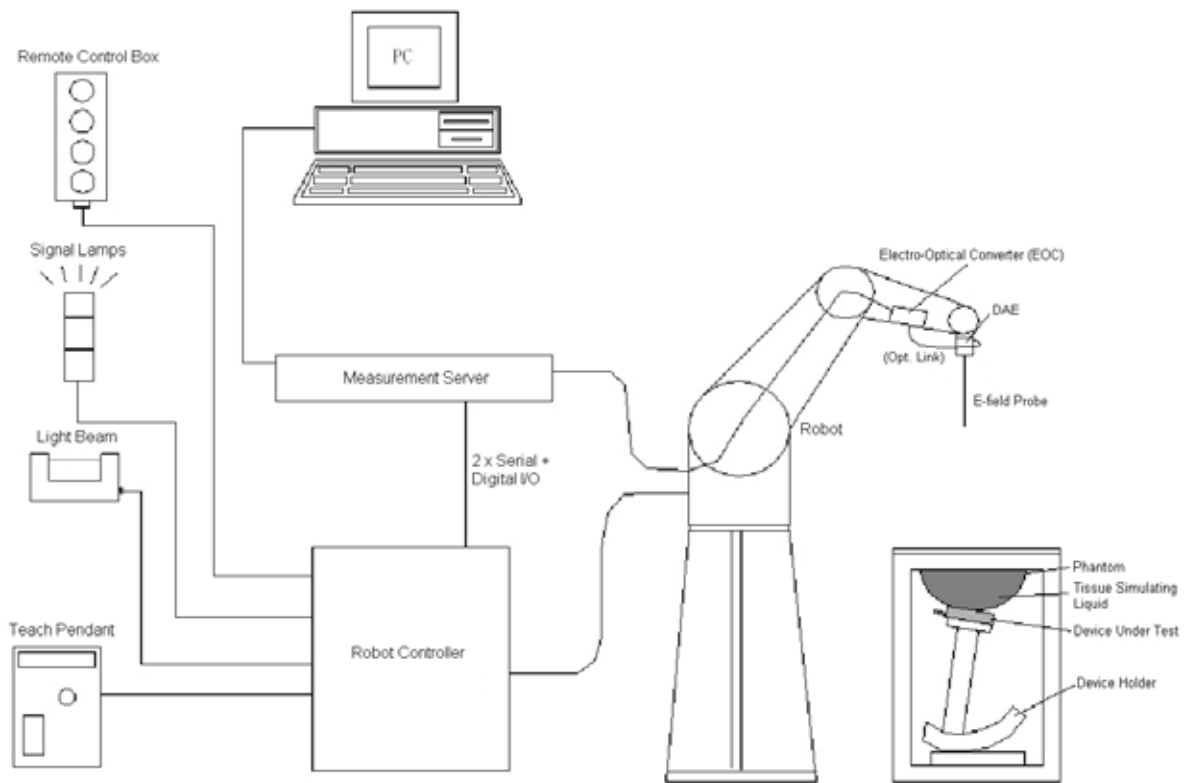

**Fig-3.1 DASY System Setup**

### 3.2.1 Robot

The DASY system uses the high precision robots from Stäubli SA (France). For the 6-axis controller system, the robot controller version (DASY4: CS7MB; DASY5: CS8c) from Stäubli is used. The Stäubli robot series have many features that are important for our application:

- High precision (repeatability  $\pm 0.035$  mm)
- High reliability (industrial design)
- Jerk-free straight movements
- Low ELF interference (the closed metallic construction shields against motor control fields)



**Fig-3.2 DASY4**





**Fig-3.3 DASY5**

## FCC SAR Test Report

### 3.2.2 Probes

The SAR measurement is conducted with the dosimetric probe. The probe is specially designed and calibrated for use in liquid with high permittivity. The dosimetric probe has special calibration in liquid at different frequency.

<b>Model</b>	EX3DV4	
<b>Construction</b>	Symmetrical design with triangular core. Built-in shielding against static charges. PEEK enclosure material (resistant to organic solvents, e.g., DGBE).	
<b>Frequency</b>	10 MHz to 6 GHz Linearity: $\pm 0.2$ dB	
<b>Directivity</b>	$\pm 0.3$ dB in HSL (rotation around probe axis) $\pm 0.5$ dB in tissue material (rotation normal to probe axis)	
<b>Dynamic Range</b>	10 $\mu$ W/g to 100 mW/g Linearity: $\pm 0.2$ dB (noise: typically $< 1$ $\mu$ W/g)	
<b>Dimensions</b>	Overall length: 337 mm (Tip: 20 mm) Tip diameter: 2.5 mm (Body: 12 mm) Typical distance from probe tip to dipole centers: 1 mm	

<b>Model</b>	ES3DV3	
<b>Construction</b>	Symmetrical design with triangular core. Interleaved sensors. Built-in shielding against static charges. PEEK enclosure material (resistant to organic solvents, e.g., DGBE).	
<b>Frequency</b>	10 MHz to 4 GHz Linearity: $\pm 0.2$ dB	
<b>Directivity</b>	$\pm 0.2$ dB in HSL (rotation around probe axis) $\pm 0.3$ dB in tissue material (rotation normal to probe axis)	
<b>Dynamic Range</b>	5 $\mu$ W/g to 100 mW/g Linearity: $\pm 0.2$ dB	
<b>Dimensions</b>	Overall length: 337 mm (Tip: 20 mm) Tip diameter: 3.9 mm (Body: 12 mm) Distance from probe tip to dipole centers: 2.0 mm	

### 3.2.3 Data Acquisition Electronics (DAE)

<b>Model</b>	DAE3, DAE4	
<b>Construction</b>	Signal amplifier, multiplexer, A/D converter and control logic. Serial optical link for communication with DASY embedded system (fully remote controlled). Two step probe touch detector for mechanical surface detection and emergency robot stop.	
<b>Measurement Range</b>	-100 to +300 mV (16 bit resolution and two range settings: 4mV, 400mV)	
<b>Input Offset Voltage</b>	$< 5\mu$ V (with auto zero)	
<b>Input Bias Current</b>	$< 50$ fA	
<b>Dimensions</b>	60 x 60 x 68 mm	



# FCC SAR Test Report

## 3.2.4 Phantoms

<b>Model</b>	Twin SAM	
<b>Construction</b>	The shell corresponds to the specifications of the Specific Anthropomorphic Mannequin (SAM) phantom defined in IEEE 1528 and IEC 62209-1. It enables the dosimetric evaluation of left and right hand phone usage as well as body mounted usage at the flat phantom region. A cover prevents evaporation of the liquid. Reference markings on the phantom allow the complete setup of all predefined phantom positions and measurement grids by teaching three points with the robot.	
<b>Material</b>	Vinylester, glass fiber reinforced (VE-GF)	
<b>Shell Thickness</b>	2 ± 0.2 mm (6 ± 0.2 mm at ear point)	
<b>Dimensions</b>	Length: 1000 mm Width: 500 mm Height: adjustable feet	
<b>Filling Volume</b>	approx. 25 liters	

<b>Model</b>	ELI	
<b>Construction</b>	Phantom for compliance testing of handheld and body-mounted wireless devices in the frequency range of 30 MHz to 6 GHz. ELI is fully compatible with the IEC 62209-2 standard and all known tissue simulating liquids. ELI has been optimized regarding its performance and can be integrated into our standard phantom tables. A cover prevents evaporation of the liquid. Reference markings on the phantom allow installation of the complete setup, including all predefined phantom positions and measurement grids, by teaching three points. The phantom is compatible with all SPEAG dosimetric probes and dipoles.	
<b>Material</b>	Vinylester, glass fiber reinforced (VE-GF)	
<b>Shell Thickness</b>	2.0 ± 0.2 mm (bottom plate)	
<b>Dimensions</b>	Major axis: 600 mm Minor axis: 400 mm	
<b>Filling Volume</b>	approx. 30 liters	

## FCC SAR Test Report

### 3.2.5 Device Holder

<b>Model</b>	Mounting Device	
<b>Construction</b>	In combination with the Twin SAM Phantom or ELI4, the Mounting Device enables the rotation of the mounted transmitter device in spherical coordinates. Rotation point is the ear opening point. Transmitter devices can be easily and accurately positioned according to IEC, IEEE, FCC or other specifications. The device holder can be locked for positioning at different phantom sections (left head, right head, flat).	
<b>Material</b>	POM	

<b>Model</b>	Laptop Extensions Kit	
<b>Construction</b>	Simple but effective and easy-to-use extension for Mounting Device that facilitates the testing of larger devices according to IEC 62209-2 (e.g., laptops, cameras, etc.). It is lightweight and fits easily on the upper part of the Mounting Device in place of the phone positioner.	
<b>Material</b>	POM, Acrylic glass, Foam	

### 3.2.6 System Validation Dipoles

<b>Model</b>	D-Serial	
<b>Construction</b>	Symmetrical dipole with 1/4 balun. Enables measurement of feed point impedance with NWA. Matched for use near flat phantoms filled with tissue simulating solutions.	
<b>Frequency</b>	750 MHz to 5800 MHz	
<b>Return Loss</b>	> 20 dB	
<b>Power Capability</b>	> 100 W (f < 1GHz), > 40 W (f > 1GHz)	

## FCC SAR Test Report

### 3.2.7 Tissue Simulating Liquids

For SAR measurement of the field distribution inside the phantom, the phantom must be filled with homogeneous tissue simulating liquid to a depth of at least 15 cm. For head SAR testing, the liquid height from the ear reference point (ERP) of the phantom to the liquid top surface is larger than 15 cm. For body SAR testing, the liquid height from the center of the flat phantom to the liquid top surface is larger than 15 cm. The nominal dielectric values of the tissue simulating liquids in the phantom and the tolerance of 5% are listed in Table-3.1.



The dielectric properties of the head tissue simulating liquids are defined in IEEE 1528, and KDB 865664 D01 Appendix A. For the body tissue simulating liquids, the dielectric properties are defined in KDB 865664 D01 Appendix A. The dielectric properties of the tissue simulating liquids were verified prior to the SAR evaluation using a dielectric assessment kit and a network analyzer.



Table-3.1 Targets of Tissue Simulating Liquid

Frequency (MHz)	Target Permittivity	Range of $\pm 5\%$	Target Conductivity	Range of $\pm 5\%$
<b>For Head</b>				
750	41.9	39.8 ~ 44.0	0.89	0.85 ~ 0.93
835	41.5	39.4 ~ 43.6	0.90	0.86 ~ 0.95
900	41.5	39.4 ~ 43.6	0.97	0.92 ~ 1.02
1450	40.5	38.5 ~ 42.5	1.20	1.14 ~ 1.26
1640	40.3	38.3 ~ 42.3	1.29	1.23 ~ 1.35
1750	40.1	38.1 ~ 42.1	1.37	1.30 ~ 1.44
1800	40.0	38.0 ~ 42.0	1.40	1.33 ~ 1.47
1900	40.0	38.0 ~ 42.0	1.40	1.33 ~ 1.47
2000	40.0	38.0 ~ 42.0	1.40	1.33 ~ 1.47
2300	39.5	37.5 ~ 41.5	1.67	1.59 ~ 1.75
2450	39.2	37.2 ~ 41.2	1.80	1.71 ~ 1.89
2600	39.0	37.1 ~ 41.0	1.96	1.86 ~ 2.06
3500	37.9	36.0 ~ 39.8	2.91	2.76 ~ 3.06
5200	36.0	34.2 ~ 37.8	4.66	4.43 ~ 4.89
5300	35.9	34.1 ~ 37.7	4.76	4.52 ~ 5.00
5500	35.6	33.8 ~ 37.4	4.96	4.71 ~ 5.21
5600	35.5	33.7 ~ 37.3	5.07	4.82 ~ 5.32
5800	35.3	33.5 ~ 37.1	5.27	5.01 ~ 5.53
<b>For Body</b>				
750	55.5	52.7 ~ 58.3	0.96	0.91 ~ 1.01
835	55.2	52.4 ~ 58.0	0.97	0.92 ~ 1.02
900	55.0	52.3 ~ 57.8	1.05	1.00 ~ 1.10
1450	54.0	51.3 ~ 56.7	1.30	1.24 ~ 1.37
1640	53.8	51.1 ~ 56.5	1.40	1.33 ~ 1.47
1750	53.4	50.7 ~ 56.1	1.49	1.42 ~ 1.56
1800	53.3	50.6 ~ 56.0	1.52	1.44 ~ 1.60
1900	53.3	50.6 ~ 56.0	1.52	1.44 ~ 1.60
2000	53.3	50.6 ~ 56.0	1.52	1.44 ~ 1.60
2300	52.9	50.3 ~ 55.5	1.81	1.72 ~ 1.90
2450	52.7	50.1 ~ 55.3	1.95	1.85 ~ 2.05
2600	52.5	49.9 ~ 55.1	2.16	2.05 ~ 2.27
3500	51.3	48.7 ~ 53.9	3.31	3.14 ~ 3.48
5200	49.0	46.6 ~ 51.5	5.30	5.04 ~ 5.57
5300	48.9	46.5 ~ 51.3	5.42	5.15 ~ 5.69
5500	48.6	46.2 ~ 51.0	5.65	5.37 ~ 5.93
5600	48.5	46.1 ~ 50.9	5.77	5.48 ~ 6.06
5800	48.2	45.8 ~ 50.6	6.00	5.70 ~ 6.30



## FCC SAR Test Report

The following table gives the recipes for tissue simulating liquids.

**Table-3.2 Recipes of Tissue Simulating Liquid**

Tissue Type	Bactericide	DGBE	HEC	NaCl	Sucrose	Triton X-100	Water	Diethylene Glycol Mono-hexylether
H750	0.2	-	0.2	1.5	56.0	-	42.1	-
H835	0.2	-	0.2	1.5	57.0	-	41.1	-
H900	0.2	-	0.2	1.4	58.0	-	40.2	-
H1450	-	43.3	-	0.6	-	-	56.1	-
H1640	-	45.8	-	0.5	-	-	53.7	-
H1750	-	47.0	-	0.4	-	-	52.6	-
H1800	-	44.5	-	0.3	-	-	55.2	-
H1900	-	44.5	-	0.2	-	-	55.3	-
H2000	-	44.5	-	0.1	-	-	55.4	-
H2300	-	44.9	-	0.1	-	-	55.0	-
H2450	-	45.0	-	0.1	-	-	54.9	-
H2600	-	45.1	-	0.1	-	-	54.8	-
H3500	-	8.0	-	0.2	-	20.0	71.8	-
H5G	-	-	-	-	-	17.2	65.5	17.3
B750	0.2	-	0.2	0.8	48.8	-	50.0	-
B835	0.2	-	0.2	0.9	48.5	-	50.2	-
B900	0.2	-	0.2	0.9	48.2	-	50.5	-
B1450	-	34.0	-	0.3	-	-	65.7	-
B1640	-	32.5	-	0.3	-	-	67.2	-
B1750	-	31.0	-	0.2	-	-	68.8	-
B1800	-	29.5	-	0.4	-	-	70.1	-
B1900	-	29.5	-	0.3	-	-	70.2	-
B2000	-	30.0	-	0.2	-	-	69.8	-
B2300	-	31.0	-	0.1	-	-	68.9	-
B2450	-	31.4	-	0.1	-	-	68.5	-
B2600	-	31.8	-	0.1	-	-	68.1	-
B3500	-	28.8	-	0.1	-	-	71.1	-
B5G	-	-	-	-	-	10.7	78.6	10.7

### 3.3 SAR System Verification

The system check verifies that the system operates within its specifications. It is performed daily or before every SAR measurement. The system check uses normal SAR measurements in the flat section of the phantom with a matched dipole at a specified distance. The system verification setup is shown as below.

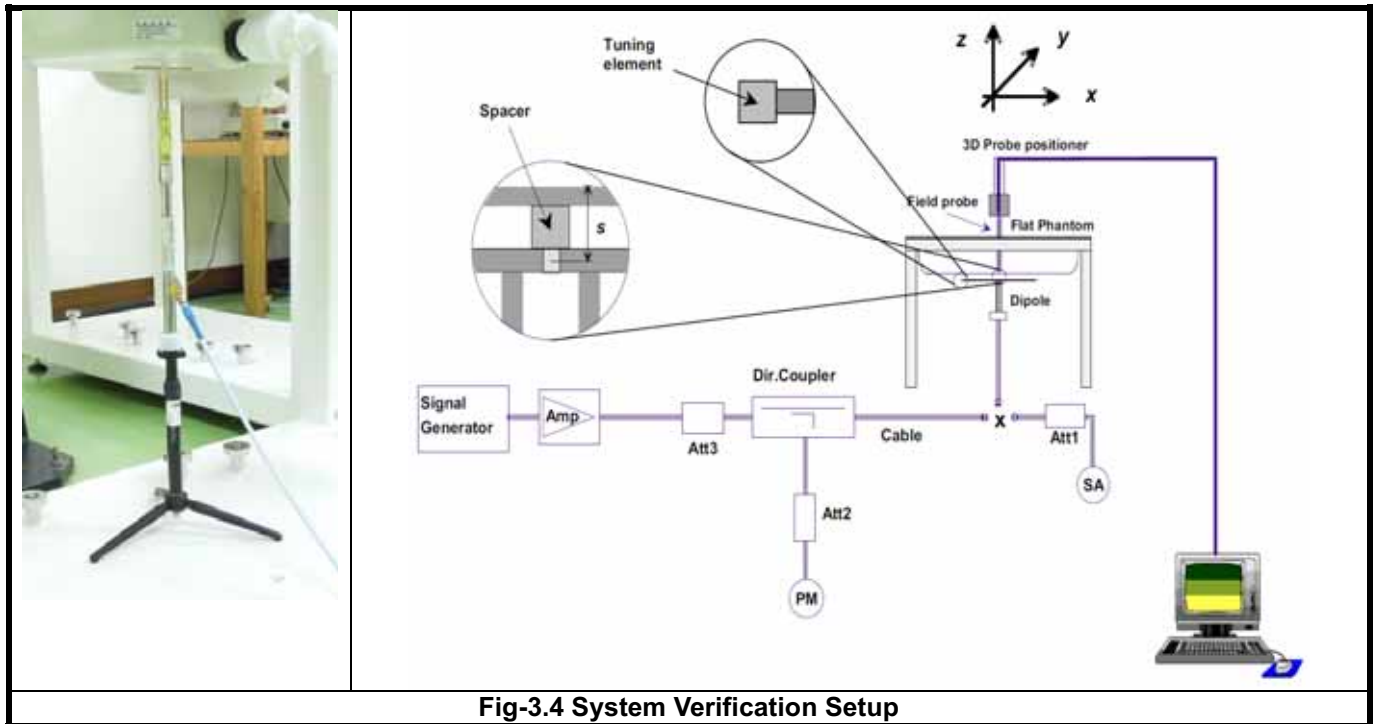

**Fig-3.4 System Verification Setup**

The validation dipole is placed beneath the flat phantom with the specific spacer in place. The distance spacer is touch the phantom surface with a light pressure at the reference marking and be oriented parallel to the long side of the phantom. The spectrum analyzer measures the forward power at the location of the system check dipole connector. The signal generator is adjusted for the desired forward power (250 mW is used for 700 MHz to 3 GHz, 100 mW is used for 3.5 GHz to 6 GHz) at the dipole connector and the power meter is read at that level. After connecting the cable to the dipole, the signal generator is readjusted for the same reading at power meter.

After system check testing, the SAR result will be normalized to 1W forward input power and compared with the reference SAR value derived from validation dipole certificate report. The deviation of system check should be within 10 %.

**3.4 SAR Measurement Procedure**

According to the SAR test standard, the recommended procedure for assessing the peak spatial-average SAR value consists of the following steps:

- (a) Power reference measurement
- (b) Area scan
- (c) Zoom scan
- (d) Power drift measurement

The SAR measurement procedures for each of test conditions are as follows:

- (a) Make EUT to transmit maximum output power
- (b) Measure conducted output power through RF cable
- (c) Place the EUT in the specific position of phantom
- (d) Perform SAR testing steps on the DASY system
- (e) Record the SAR value

**3.4.1 Area & Zoom Scan Procedure**

First Area Scan is used to locate the approximate location(s) of the local peak SAR value(s). The measurement grid within an Area Scan is defined by the grid extent, grid step size and grid offset. Next, in order to determine the EM field distribution in a three-dimensional spatial extension, Zoom Scan is required. The Zoom Scan is performed around the highest E-field value to determine the averaged SAR-distribution over 10 g. According to KDB 865664 D01, the resolution for Area and Zoom scan is specified in the table below.

Items	<= 2 GHz	2-3 GHz	3-4 GHz	4-5 GHz	5-6 GHz
Area Scan ( $\Delta x, \Delta y$ )	<= 15 mm	<= 12 mm	<= 12 mm	<= 10 mm	<= 10 mm
Zoom Scan ( $\Delta x, \Delta y$ )	<= 8 mm	<= 5 mm	<= 5 mm	<= 4 mm	<= 4 mm
Zoom Scan ( $\Delta z$ )	<= 5 mm	<= 5 mm	<= 4 mm	<= 3 mm	<= 2 mm
Zoom Scan Volume	>= 30 mm	>= 30 mm	>= 28 mm	>= 25 mm	>= 22 mm

**Note:**

When zoom scan is required and report SAR is <= 1.4 W/kg, the zoom scan resolution of  $\Delta x / \Delta y$  (2-3GHz: <= 8 mm, 3-4GHz: <= 7 mm, 4-6GHz: <= 5 mm) may be applied.

**3.4.2 Volume Scan Procedure**

The volume scan is used for assess overlapping SAR distributions for antennas transmitting in different frequency bands. It is equivalent to an oversized zoom scan used in standalone measurements. The measurement volume will be used to enclose all the simultaneous transmitting antennas. For antennas transmitting simultaneously in different frequency bands, the volume scan is measured separately in each frequency band. In order to sum correctly to compute the 1g aggregate SAR, the EUT remain in the same test position for all measurements and all volume scan use the same spatial resolution and grid spacing. When all volume scan were completed, the software, SEMCAD postprocessor can combine and subsequently superpose these measurement data to calculating the multiband SAR.



### 3.4.3 Power Drift Monitoring

All SAR testing is under the EUT install full charged battery and transmit maximum output power. In DASY measurement software, the power reference measurement and power drift measurement procedures are used for monitoring the power drift of EUT during SAR test. Both these procedures measure the field at a specified reference position before and after the SAR testing. The software will calculate the field difference in dB. If the power drift more than 5%, the SAR will be retested.

### 3.4.4 Spatial Peak SAR Evaluation

The procedure for spatial peak SAR evaluation has been implemented according to the test standard. It can be conducted for 1g and 10g, as well as for user-specific masses. The DASY software includes all numerical procedures necessary to evaluate the spatial peak SAR value.

The base for the evaluation is a "cube" measurement. The measured volume must include the 1g and 10g cubes with the highest averaged SAR values. For that purpose, the center of the measured volume is aligned to the interpolated peak SAR value of a previously performed area scan.

The entire evaluation of the spatial peak values is performed within the post-processing engine (SEMCAD). The system always gives the maximum values for the 1g and 10g cubes. The algorithm to find the cube with highest averaged SAR is divided into the following stages:

- (a) Extraction of the measured data (grid and values) from the Zoom Scan
- (b) Calculation of the SAR value at every measurement point based on all stored data (A/D values and measurement parameters)
- (c) Generation of a high-resolution mesh within the measured volume
- (d) Interpolation of all measured values from the measurement grid to the high-resolution grid
- (e) Extrapolation of the entire 3-D field distribution to the phantom surface over the distance from sensor to surface
- (f) Calculation of the averaged SAR within masses of 1g and 10g

### 3.4.5 SAR Averaged Methods

In DASY, the interpolation and extrapolation are both based on the modified Quadratic Shepard's method. The interpolation scheme combines a least-square fitted function method and a weighted average method which are the two basic types of computational interpolation and approximation.

Extrapolation routines are used to obtain SAR values between the lowest measurement points and the inner phantom surface. The extrapolation distance is determined by the surface detection distance and the probe sensor offset. The uncertainty increases with the extrapolation distance. To keep the uncertainty within 1% for the 1 g and 10 g cubes, the extrapolation distance should not be larger than 5 mm.





### 4. SAR Measurement Evaluation

#### 4.1 EUT Configuration and Setting

The EUT is a voice/data transmitter device that contains one WWAN transmitter (CDMA / LTE), and two WWAN antennas for transmit diversity. Confirming the LTE transmitter follows 3GPP release 8 standards, is category 3, FDD-LTE band 2 (BW 1.4/3/5/10/15/20 MHz), FDD-LTE band 4 (BW 1.4/3/5/10/15/20 MHz), FDD-LTE band 12 (BW 1.4/3/5/10 MHz), FDD-LTE band 25 (BW 1.4/3/5/10/15/20 MHz), FDD-LTE band 26 (BW 1.4/3/5/10/15 MHz), TDD-LTE band 41 (BW 5/10/15/20 MHz), supports QPSK / 16QAM modulations, and supports data and VoLTE transmission. Tested per 3GPP 36.521 maximum transmit procedures for both QPSK / 16QAM.

**LTE Maximum Power Reduction in accordance with 3GPP 36.101:** Power Reduction in accordance to 3GPP is active all times during LTE operation.

Modulation	Channel Bandwidth / RB Configurations						LTE MPR Setting (dB)
	BW 1.4 MHz	BW 3 MHz	BW 5 MHz	BW 10 MHz	BW 15 MHz	BW 20 MHz	
QPSK	> 5	> 4	> 8	> 12	> 16	> 18	1
16QAM	<= 5	<= 4	<= 8	<= 12	<= 16	<= 18	1
16QAM	> 5	> 4	> 8	> 12	> 16	> 18	2

**Note:** MPR is according to the standard and implemented in the circuit (mandatory).

In addition, the device is compliant with A-MPR requirements defined in 36.101 section 6.2.4 that may be required to meet 3GPP Adjacent Channel Leakage Ratio (“ACLR”) requirements. A-MPR was disabled for all FCC compliance testing.

The simultaneous transmission possibilities are listed as below.

Simultaneous TX Combination	Configuration	Head (Voice / VoIP)	Body Worn (Voice / VoIP)	Hotspot (Data)
1	CDMA2000 BC0 (Voice / Data) + WLAN (Data)	Yes	Yes	Yes
2	CDMA2000 BC1 (Voice / Data) + WLAN (Data)	Yes	Yes	Yes
3	CDMA2000 BC10 (Voice / Data) + WLAN (Data)	Yes	Yes	Yes
4	LTE 2 (Data) + WLAN (Data)	Yes	Yes	Yes
5	LTE 4 (Data) + WLAN (Data)	Yes	Yes	Yes
6	LTE 12 (Data) + WLAN (Data)	Yes	Yes	Yes
7	LTE 25 (Data) + WLAN (Data)	Yes	Yes	Yes
8	LTE 26 (Data) + WLAN (Data)	Yes	Yes	Yes
9	LTE 41 (Data) + WLAN (Data)	Yes	Yes	Yes
10	CDMA2000 BC0 (Voice / Data) + BT (Data)	No	Yes	No
11	CDMA2000 BC1 (Voice / Data) + BT (Data)	No	Yes	No
12	CDMA2000 BC10 (Voice / Data) + BT (Data)	No	Yes	No
13	LTE 2 (Data) + BT (Data)	No	Yes	No
14	LTE 4 (Data) + BT (Data)	No	Yes	No
15	LTE 12 (Data) + BT (Data)	No	Yes	No
16	LTE 25 (Data) + BT (Data)	No	Yes	No
17	LTE 26 (Data) + BT (Data)	No	Yes	No
18	LTE 41 (Data) + BT (Data)	No	Yes	No



## FCC SAR Test Report

---

### Note :

1. The WWAN transmitter can only use either CDMA or LTE at a time.
2. The WLAN and BT cannot transmit simultaneously, so there is no co-location test requirement for WLAN and BT.
3. Only WLAN 2.4G (802.11b/g/n) supports wireless hotspot capability. WLAN 5G (802.11a/n/ac) does not support wireless hotspot mode.

For CDMA, head SAR is tested under 1xRTT mode using RC3 with the EUT configured to transmit at full rate using Loopback Service Option SO55. SAR for RC1 is not required when the maximum power is less than 1/4 dB higher than RC3. SAR for multiple code channels (FCH+SCH<sub>n</sub>) is not required when the maximum power is less than 1/4 dB higher than that measured with FCH only. SAR for EVDO Rev.0 is not required when the maximum power is less than 1/4 dB higher than RC3 (1xRTT). SAR for EVDO Rev.A is not required when the maximum power is less than Rev.0 or less than 1/4 dB higher than RC3. The steps for system simulator (Agilent E5515C) setup are as below.

1. Set the System ID and Network ID
2. Set the Cell Band and connecting Channel
3. Set the power control to All Up Bits
4. Press "Originate Call" button

Hotspot SAR is tested under EVDO Rev.0 mode using Reverse Data Channel rate of 153.6 kbps in subtype 0/1 Physical Layer Configurations, and the power control set "All Up Bits". SAR for EVDO Rev.A is not required since its power is less than EVDO Rev.0. SAR for 1xRTT is not required since its power is less than 1/4 dB higher than EVDO Rev.0. The steps for system simulator (Agilent E5515C) setup are as below.

1. Set the Sector ID
2. Set the Protocol Release
3. Set the Cell Band and connecting Channel
4. Set the RTAP Rate
5. Set the power control
6. Press "Start Data Connection" button

For LTE, set the related parameters of operating band, channel bandwidth, uplink channel number, modulation type, and RB in base station simulator. When the EUT has registered and communicated to base station simulator, set the simulator to make EUT transmitting the maximum radiated power. The steps for system simulator (Anritsu MT8820C) setup are as below.

1. Press the "Std" button to select "LTE 22.20S" function
2. Choose the "Screen Select" item to "Fundamental Measurement"
3. Enter the "Common" item
4. Set the Operating Band
5. Set the Channel Bandwidth
6. Set the UL Channel & Frequency
7. Set the Modulation
8. Set the RB number and RB shift
9. Press "Start Call" button when EUT register to the system simulator
10. Set the TX-1 Max. Power to make the EUT transmit maximum output power

In addition, the TDD-LTE for this device supports Uplink-Downlink configuration 0 only. Therefore, SAR is tested with fixed periodic duty at the highest duty factor using Uplink-Downlink configuration 0 with special sub-frame configuration 5 per KDB 941225 D05 and 3GPP TS 36.211.

For WLAN SAR testing, the EUT has installed WLAN engineering testing software which can provide continuous transmitting RF signal. According to KDB 248227 D01, WLAN SAR should be tested at the lowest data rate, and testing at higher data rate is not required when the maximum average output power is less than 1/4 dB higher than those measured at the lowest data rate. Since the WLAN power at lowest data rate has highest output power, WLAN SAR for this device was performed at the lowest data rate.

**4.2 EUT Testing Position**

According to KDB 648474 D04, handsets are tested for SAR compliance in head, body-worn accessory and other use configurations described in the following subsections.

**4.2.1 Head Exposure Conditions**

Head exposure is limited to next to the ear voice mode operations. Head SAR compliance is tested according to the test positions defined in IEEE Std 1528-2003 using the SAM phantom illustrated as below.

1. Define two imaginary lines on the handset
  - (a) The vertical centerline passes through two points on the front side of the handset - the midpoint of the width  $w_t$  of the handset at the level of the acoustic output, and the midpoint of the width  $w_b$  of the bottom of the handset.
  - (b) The horizontal line is perpendicular to the vertical centerline and passes through the center of the acoustic output. The horizontal line is also tangential to the face of the handset at point A.
  - (c) The two lines intersect at point A. Note that for many handsets, point A coincides with the center of the acoustic output; however, the acoustic output may be located elsewhere on the horizontal line. Also note that the vertical centerline is not necessarily parallel to the front face of the handset, especially for clamshell handsets, handsets with flip covers, and other irregularly shaped handsets.

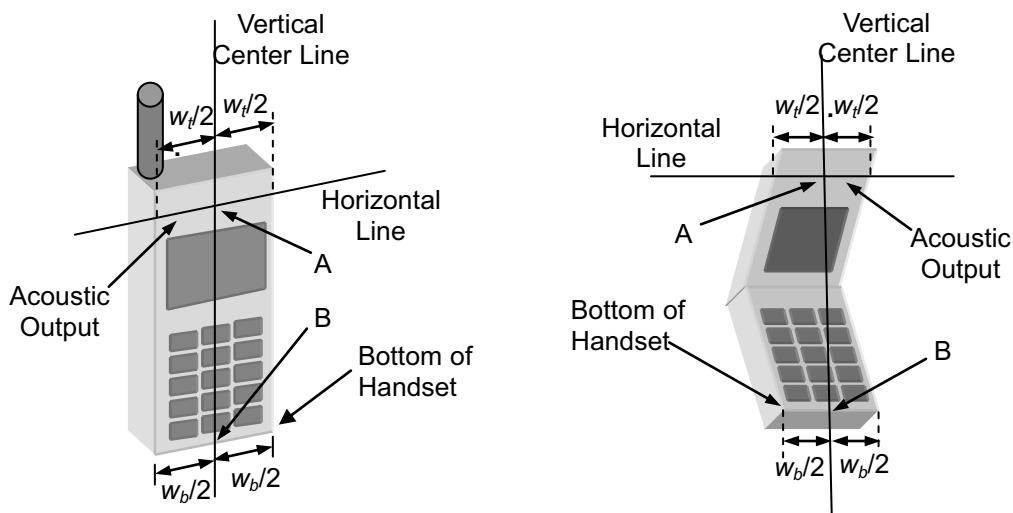

**Fig-4.1 Illustration for Handset Vertical and Horizontal Reference Lines**

## FCC SAR Test Report

### 2. Cheek Position

- (a) To position the device with the vertical center line of the body of the device and the horizontal line crossing the center piece in a plane parallel to the sagittal plane of the phantom. While maintaining the device in this plane, align the vertical center line with the reference plane containing the three ear and mouth reference point (M: Mouth, RE: Right Ear, and LE: Left Ear) and align the center of the ear piece with the line RE-LE.
- (b) To move the device towards the phantom with the ear piece aligned with the line LE-RE until the phone touched the ear. While maintaining the device in the reference plane and maintaining the phone contact with the ear, move the bottom of the phone until any point on the front side is in contact with the cheek of the phantom or until contact with the ear is lost (see Fig-4.2).



Fig-4.2 Illustration for Cheek Position

### 3. Tilted Position

- (a) To position the device in the "cheek" position described above.
- (b) While maintaining the device the reference plane described above and pivoting against the ear, moves it outward away from the mouth by an angle of 15 degrees or until contact with the ear is lost (see Fig-4.3).

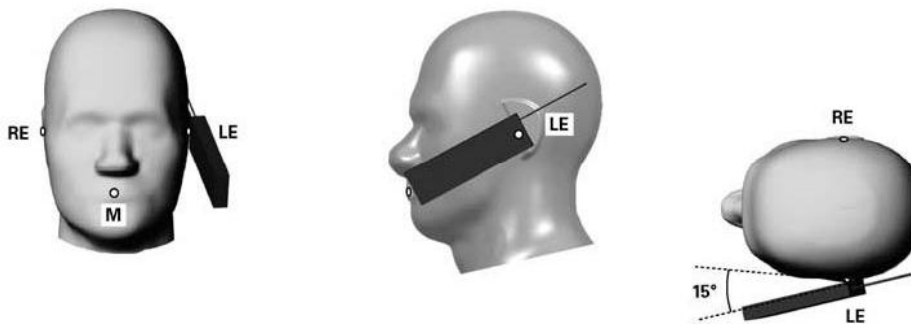

Fig-4.3 Illustration for Tilted Position

#### 4.2.2 Body-Worn Accessory Exposure Conditions

Body-worn accessory exposure is typically related to voice mode operations when handsets are carried in body-worn accessories. The body-worn accessory procedures in KDB 447498 D01 are used to test for body-worn accessory SAR compliance, without a headset connected to it. This enables the test results for such configuration to be compatible with that required for hotspot mode when the body-worn accessory test separation distance is greater than or equal to that required for hotspot mode. When the reported SAR for a body-worn accessory, measured without a headset connected to the handset, is  $> 1.2 \text{ W/kg}$ , the highest reported SAR configuration for that wireless mode and frequency band should be repeated for that body-worn accessory with a headset attached to the handset.

Body-worn accessories that do not contain metallic or conductive components may be tested according to worst-case exposure configurations, typically according to the smallest test separation distance required for the group of body-worn accessories with similar operating and exposure characteristics. All body-worn accessories containing metallic components are tested in conjunction with the host device.

Body-worn accessory SAR compliance is based on a single minimum test separation distance for all wireless and operating modes applicable to each body-worn accessory used by the host, and according to the relevant voice and/or data mode transmissions and operations. If a body-worn accessory supports voice only operations in its normal and expected use conditions, testing of data mode for body-worn compliance is not required.

A conservative minimum test separation distance for supporting off-the-shelf body-worn accessories that may be acquired by users of consumer handsets is used to test for body-worn accessory SAR compliance. This distance is determined by the handset manufacturer, according to the requirements of Supplement C 01-01. Devices that are designed to operate on the body of users using lanyards and straps, or without requiring additional body-worn accessories, will be tested using a conservative minimum test separation distance  $\leq 5 \text{ mm}$  to support compliance.

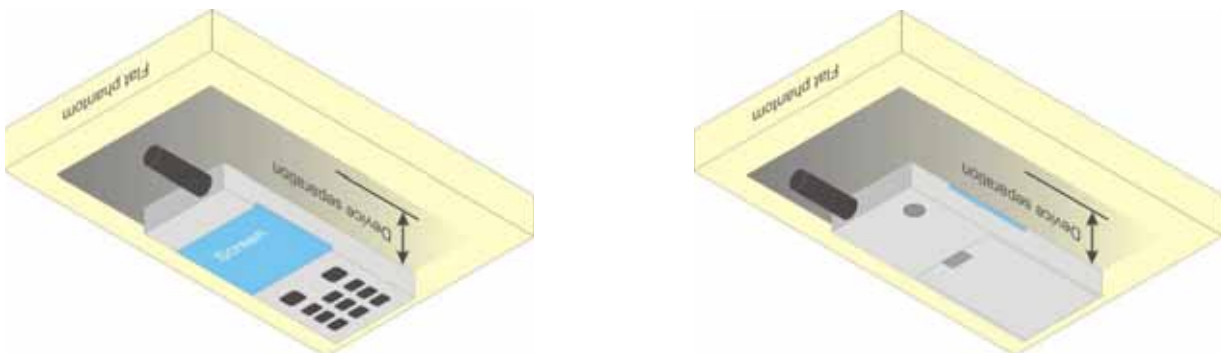
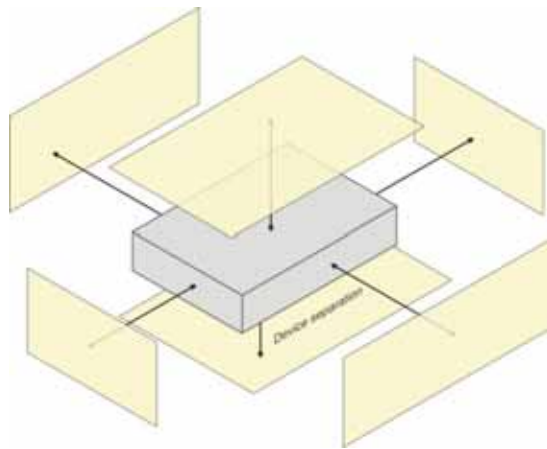

**Fig-4.4 Illustration for Body Worn Position**

# FCC SAR Test Report

## 4.2.3 Hotspot Mode Exposure conditions

For handsets that support hotspot mode operations, with wireless router capabilities and various web browsing functions, the relevant hand and body exposure conditions are tested according to the hotspot SAR procedures in KDB 941225 D06. A test separation distance of 10 mm is required between the phantom and all surfaces and edges with a transmitting antenna located within 25 mm from that surface or edge. When the form factor of a handset is smaller than 9 cm x 5 cm, a test separation distance of 5 mm (instead of 10 mm) is required for testing hotspot mode. When the separation distance required for body-worn accessory testing is larger than or equal to that tested for hotspot mode, in the same wireless mode and for the same surface of the phone, the hotspot mode SAR data may be used to support body-worn accessory SAR compliance for that particular configuration (surface).



Based on the antenna location shown on appendix D of this report, the SAR testing required for hotspot mode is listed as below.

Antenna	Front Face	Rear Face	Left Side	Right Side	Top Side	Bottom Side
WWAN Ant-0	√	√	√	√	-	√
WWAN Ant-1	√	√	√	√	√	-
WLAN / BT	√	√	-	√	√	-

## 4.2.4 SAR Test Exclusions

According to KDB 447498 D01, the SAR test exclusion condition is based on source-based time-averaged maximum conducted output power, adjusted for tune-up tolerance, and the minimum test separation distance required for the exposure conditions. The SAR exclusion threshold is determined by the following formula.

$$\frac{\text{Max. Tune up Power}_{(mW)}}{\text{Min. Test Separation Distance}_{(mm)}} \times \sqrt{f_{(GHz)}} \leq 3.0 \text{ for SAR-1g, } \leq 7.5 \text{ for SAR-10g}$$

When the minimum test separation distance is < 5 mm, a distance of 5 mm is applied to determine SAR test exclusion.

Mode	Max. Tune-up Power (dBm)	Max. Tune-up Power (mW)	Body-Worn		
			Ant. to Surface (mm)	Calculated Result	Require SAR Testing?
BT (2.48 GHz)	9.6	9	10	1.4	No

### Note:

- When separation distance <= 50 mm and the calculated result shown in above table is <= 3.0, the SAR testing exclusion is applied.



## FCC SAR Test Report

### 4.3 Tissue Verification

The measuring results for tissue simulating liquid are shown as below.

Test Date	Tissue Type	Frequency (MHz)	Liquid Temp. (°C)	Measured Conductivity ( $\sigma$ )	Measured Permittivity ( $\epsilon_r$ )	Target Conductivity ( $\sigma$ )	Target Permittivity ( $\epsilon_r$ )	Conductivity Deviation (%)	Permittivity Deviation (%)
Jan. 16, 2015	Head	750	21.3	0.892	41.077	0.89	41.9	0.22	-1.96
Jan. 16, 2015	Head	835	21.3	0.919	42.196	0.90	41.5	2.11	1.68
Jan. 16, 2015	Head	1750	21.6	1.387	41.405	1.37	40.1	1.24	3.25
Jan. 16, 2015	Head	1900	21.6	1.442	40.609	1.40	40.0	3.00	1.52
Jan. 13, 2015	Head	2450	21.7	1.809	39.923	1.80	39.2	0.50	1.84
Jan. 20, 2015	Head	2600	20.9	2.053	37.984	1.96	39.0	4.74	-2.61
Jan. 13, 2015	Head	5200	21.8	4.592	36.805	4.66	36.0	-1.46	2.24
Jan. 06, 2015	Head	5300	21.2	4.914	37.221	4.76	35.9	3.24	3.68
Jan. 13, 2015	Head	5600	21.8	5.080	36.285	5.07	35.5	0.20	2.21
Jan. 15, 2015	Head	5800	21.5	5.434	36.253	5.27	35.3	3.11	2.70
Jan. 23, 2015	Body	750	21.6	0.969	55.447	0.96	55.5	0.94	-0.10
Jan. 17, 2015	Body	835	21.5	0.961	56.074	0.97	55.2	-0.93	1.58
Jan. 22, 2015	Body	1750	21.7	1.490	52.422	1.49	53.4	0.00	-1.83
Jan. 17, 2015	Body	1900	21.3	1.549	51.826	1.52	53.3	1.91	-2.77
Jan. 23, 2015	Body	1900	21.4	1.543	53.655	1.52	53.3	1.51	0.67
Jan. 24, 2015	Body	1900	21.5	1.547	53.811	1.52	53.3	1.78	0.96
Jan. 04, 2015	Body	2450	21.2	1.993	51.223	1.95	52.7	2.21	-2.80
Jan. 17, 2015	Body	2600	21.8	2.199	52.429	2.16	52.5	1.81	-0.14
Jan. 13, 2015	Body	5200	21.7	5.355	47.739	5.30	49.0	1.04	-2.57
Jan. 13, 2015	Body	5300	21.7	5.496	47.512	5.42	48.9	1.40	-2.84
Jan. 04, 2015	Body	5600	21.1	5.753	47.615	5.77	48.5	-0.29	-1.82
Jan. 13, 2015	Body	5800	21.7	6.181	46.557	6.00	48.2	3.02	-3.41

#### Note:

The dielectric properties of the tissue simulating liquid must be measured within 24 hours before the SAR testing and within  $\pm 5\%$  of the target values. Liquid temperature during the SAR testing must be within  $\pm 2^\circ\text{C}$ .



# FCC SAR Test Report

## 4.4 System Validation

The SAR measurement system was validated according to procedures in KDB 865664 D01. The validation status in tabulated summary is as below.

Test Date	Probe S/N	Calibration Point		Measured Conductivity ( $\sigma$ )	Measured Permittivity ( $\epsilon_r$ )	Validation for CW			Validation for Modulation		
						Sensitivity Range	Probe Linearity	Probe Isotropy	Modulation Type	Duty Factor	PAR
Jan. 16, 2015	3971	Head	750	0.892	41.077	Pass	Pass	Pass	N/A	N/A	N/A
Jan. 16, 2015	3971	Head	835	0.919	42.196	Pass	Pass	Pass	N/A	N/A	N/A
Jan. 16, 2015	3971	Head	1750	1.387	41.405	Pass	Pass	Pass	N/A	N/A	N/A
Jan. 16, 2015	3971	Head	1900	1.442	40.609	Pass	Pass	Pass	N/A	N/A	N/A
Jan. 13, 2015	3650	Head	2450	1.809	39.923	Pass	Pass	Pass	OFDM	N/A	Pass
Jan. 20, 2015	3590	Head	2600	2.053	37.984	Pass	Pass	Pass	N/A	N/A	N/A
Jan. 13, 2015	3650	Head	5200	4.592	36.805	Pass	Pass	Pass	OFDM	N/A	Pass
Jan. 06, 2015	3971	Head	5300	4.914	37.221	Pass	Pass	Pass	OFDM	N/A	Pass
Jan. 13, 2015	3650	Head	5600	5.080	36.285	Pass	Pass	Pass	OFDM	N/A	Pass
Jan. 15, 2015	3971	Head	5800	5.434	36.253	Pass	Pass	Pass	OFDM	N/A	Pass
Jan. 23, 2015	3971	Body	750	0.969	55.447	Pass	Pass	Pass	N/A	N/A	N/A
Jan. 17, 2015	3971	Body	835	0.961	56.074	Pass	Pass	Pass	N/A	N/A	N/A
Jan. 22, 2015	3971	Body	1750	1.490	52.422	Pass	Pass	Pass	N/A	N/A	N/A
Jan. 17, 2015	3971	Body	1900	1.549	51.826	Pass	Pass	Pass	N/A	N/A	N/A
Jan. 23, 2015	3917	Body	1900	1.543	53.655	Pass	Pass	Pass	N/A	N/A	N/A
Jan. 24, 2015	3864	Body	1900	1.547	53.811	Pass	Pass	Pass	N/A	N/A	N/A
Jan. 04, 2015	3864	Body	2450	1.993	51.223	Pass	Pass	Pass	OFDM	N/A	Pass
Jan. 17, 2015	3971	Body	2600	2.199	52.429	Pass	Pass	Pass	N/A	N/A	N/A
Jan. 13, 2015	3650	Body	5200	5.355	47.739	Pass	Pass	Pass	OFDM	N/A	Pass
Jan. 13, 2015	3650	Body	5300	5.496	47.512	Pass	Pass	Pass	OFDM	N/A	Pass
Jan. 04, 2015	3864	Body	5600	5.753	47.615	Pass	Pass	Pass	OFDM	N/A	Pass
Jan. 13, 2015	3650	Body	5800	6.181	46.557	Pass	Pass	Pass	OFDM	N/A	Pass





## FCC SAR Test Report

### 4.5 System Verification

The measuring result for system verification is tabulated as below.

Test Date	Mode	Frequency (MHz)	1W Target SAR-1g (W/kg)	Measured SAR-1g (W/kg)	Normalized to 1W SAR-1g (W/kg)	Deviation (%)	Dipole S/N	Probe S/N	DAE S/N
Jan. 16, 2015	Head	750	8.35	2.17	8.68	3.95	1013	3971	1431
Jan. 16, 2015	Head	835	9.43	2.40	9.60	1.80	4d121	3971	1431
Jan. 16, 2015	Head	1750	37.30	9.53	38.12	2.20	1055	3971	1431
Jan. 16, 2015	Head	1900	40.10	10.9	43.60	8.73	5d018	3971	1431
Jan. 13, 2015	Head	2450	51.00	12.5	50.00	-1.96	737	3650	1277
Jan. 20, 2015	Head	2600	57.50	14.5	58.00	0.87	1020	3590	861
Jan. 13, 2015	Head	5200	79.70	7.90	79.00	-0.88	1019	3650	1277
Jan. 06, 2015	Head	5300	83.40	8.22	82.20	-1.44	1019	3971	1431
Jan. 13, 2015	Head	5600	83.80	8.04	80.40	-4.06	1019	3650	1277
Jan. 15, 2015	Head	5800	80.20	8.22	82.20	2.49	1019	3971	1431
Jan. 23, 2015	Body	750	8.71	2.26	9.04	3.79	1013	3971	1431
Jan. 17, 2015	Body	835	9.55	2.43	9.72	1.78	4d121	3971	1431
Jan. 22, 2015	Body	1750	37.70	9.71	38.84	3.02	1055	3971	1431
Jan. 17, 2015	Body	1900	39.80	9.79	39.16	-1.61	5d018	3971	1431
Jan. 23, 2015	Body	1900	39.80	9.61	38.44	-3.42	5d018	3917	1431
Jan. 24, 2015	Body	1900	39.80	10.4	41.60	4.52	5d018	3864	510
Jan. 04, 2015	Body	2450	49.50	13.0	52.00	5.05	737	3864	510
Jan. 17, 2015	Body	2600	56.50	14.2	56.80	0.53	1020	3971	1431
Jan. 13, 2015	Body	5200	74.70	7.47	74.70	0.00	1019	3650	1277
Jan. 13, 2015	Body	5300	77.10	7.68	76.80	-0.39	1019	3650	1277
Jan. 04, 2015	Body	5600	80.80	7.96	79.60	-1.49	1019	3864	510
Jan. 13, 2015	Body	5800	73.90	7.97	79.70	7.85	1019	3650	1277

#### Note:

Comparing to the reference SAR value provided by SPEAG, the validation data should be within its specification of 10 %. The result indicates the system check can meet the variation criterion and the plots can be referred to Appendix A of this report.



# FCC SAR Test Report

## 4.6 Maximum Output Power

### 4.6.1 Maximum Conducted Power

The maximum conducted average power (Unit: dBm) including tune-up tolerance is shown as below.

Mode	CDMA BC0	CDMA BC1	CDMA BC10
1xRTT / EVDO	25.0	24.5	24.5

Mode	LTE 2	LTE 4
QPSK / 16QAM	24.5	23.5

Mode	LTE 12	LTE 25
QPSK / 16QAM	22.5	24.5

Mode	LTE 26	LTE 41
QPSK / 16QAM	22.5	24.5

Mode	2.4G WLAN	5.2G WLAN	5.3G WLAN	5.6G WLAN	5.8G WLAN
802.11b	18.5	N/A	N/A	N/A	N/A
802.11g	16.5	N/A	N/A	N/A	N/A
802.11a	N/A	16.0	16.5	16.5	16.0
802.11n HT20	16.5	16.0	16.5	16.5	16.0
802.11n HT40	11.5	13.0	13.5	13.0	13.0
802.11ac VHT80	N/A	11.0	11.0	11.0	11.5

Mode	Bluetooth
All	9.6

### 4.6.2 Measured Conducted Power Result

The measuring conducted average power (Unit: dBm) is shown as below.

Band Channel	CDMA BC0			CDMA BC1		
	1013	384	777	25	600	1175
Frequency (MHz)	824.70	836.52	848.31	1851.25	1880.00	1908.75
1xRTT RC1+SO55	24.31	24.78	24.52	23.81	24.31	24.21
1xRTT RC3+SO55	24.26	<b>24.88</b>	24.46	23.89	<b>24.49</b>	24.28
1xRTT RC3+SO32 (FCH)	24.51	24.81	24.33	23.71	24.35	24.17
1xRTT RC3+SO32 (SCH)	24.45	24.72	24.36	23.76	24.30	24.12
1xEVDO Rev.0 RTAP 153.6	23.57	23.64	23.98	24.30	24.48	24.28
1xEVDO Rev.A RETAP 4096	23.51	23.60	23.82	24.32	24.42	24.32



# FCC SAR Test Report

Band	CDMA BC10		
Channel	476	580	684
Frequency (MHz)	817.9	820.5	823.1
1xRTT RC1+SO55	24.10	24.07	22.81
1xRTT RC3+SO55	<b>24.12</b>	24.08	22.75
1xRTT RC3+SO32 (FCH)	24.08	24.05	22.71
1xRTT RC3+SO32 (SCH)	24.09	24.03	22.88
1xEVDO Rev.0 RTAP 153.6	23.70	23.63	22.58
1xEVDO Rev.A RETAP 4096	23.61	23.42	23.51

LTE Band / BW	RB Size	RB Offset	QPSK			3GPP MPR (dB)	16QAM			3GPP MPR (dB)
			Low CH 18607	Mid CH 18900	High CH 19193		Low CH 18607	Mid CH 18900	High CH 19193	
			1850.7 MHz	1880.0 MHz	1909.3 MHz		1850.7 MHz	1880.0 MHz	1909.3 MHz	
2 / 1.4M	1	0	23.89	24.27	<b>24.30</b>	0	22.89	23.27	23.30	1
	1	2	22.83	23.21	23.24	0	21.83	22.21	22.24	1
	1	5	23.36	23.74	23.77	0	22.36	22.74	22.77	1
	3	0	22.89	23.27	23.30	0	21.89	22.27	22.30	1
	3	1	21.83	22.21	22.24	0	20.83	21.21	21.24	1
	3	3	22.36	22.74	22.77	0	21.36	21.74	21.77	1
	6	0	22.24	22.65	22.58	1	21.24	21.65	21.58	2

LTE Band / BW	RB Size	RB Offset	QPSK			3GPP MPR (dB)	16QAM			3GPP MPR (dB)
			Low CH 18615	Mid CH 18900	High CH 19185		Low CH 18615	Mid CH 18900	High CH 19185	
			1851.5 MHz	1880.0 MHz	1908.5 MHz		1851.5 MHz	1880.0 MHz	1908.5 MHz	
2 / 3M	1	0	23.90	24.28	<b>24.31</b>	0	22.90	23.28	23.31	1
	1	7	22.84	23.22	23.25	0	21.84	22.22	22.25	1
	1	14	23.37	23.75	23.78	0	22.37	22.75	22.78	1
	8	0	22.90	23.28	23.31	1	21.90	22.28	22.31	2
	8	3	21.84	22.22	22.25	1	20.84	21.22	21.25	2
	8	7	22.37	22.75	22.78	1	21.37	21.75	21.78	2
	15	0	22.25	22.66	22.59	1	21.25	21.66	21.59	2

LTE Band / BW	RB Size	RB Offset	QPSK			3GPP MPR (dB)	16QAM			3GPP MPR (dB)
			Low CH 18625	Mid CH 18900	High CH 19175		Low CH 18625	Mid CH 18900	High CH 19175	
			1852.5 MHz	1880.0 MHz	1907.5 MHz		1852.5 MHz	1880.0 MHz	1907.5 MHz	
2 / 5M	1	0	23.91	24.29	<b>24.32</b>	0	22.91	23.29	23.32	1
	1	12	22.85	23.23	23.26	0	21.85	22.23	22.26	1
	1	24	23.38	23.76	23.79	0	22.38	22.76	22.79	1
	12	0	22.91	23.29	23.32	1	21.91	22.29	22.32	2
	12	6	21.85	22.23	22.26	1	20.85	21.23	21.26	2
	12	13	22.38	22.76	22.79	1	21.38	21.76	21.79	2
	25	0	22.26	22.67	22.60	1	21.26	21.67	21.60	2



# FCC SAR Test Report

LTE Band / BW	RB Size	RB Offset	QPSK			3GPP MPR (dB)	16QAM			3GPP MPR (dB)
			Low CH 18650	Mid CH 18900	High CH 19150		Low CH 18650	Mid CH 18900	High CH 19150	
			1855.0 MHz	1880.0 MHz	1905.0 MHz		1855.0 MHz	1880.0 MHz	1905.0 MHz	
2 / 10M	1	0	23.92	24.30	<b>24.33</b>	0	22.92	23.30	23.33	1
	1	24	22.86	23.24	23.27	0	21.86	22.24	22.27	1
	1	49	23.39	23.77	23.80	0	22.39	22.77	22.80	1
	25	0	22.92	23.30	23.33	1	21.92	22.30	22.33	2
	25	12	21.86	22.24	22.27	1	20.86	21.24	21.27	2
	25	25	22.39	22.77	22.80	1	21.39	21.77	21.80	2
	50	0	22.27	22.68	22.61	1	21.27	21.68	21.61	2

LTE Band / BW	RB Size	RB Offset	QPSK			3GPP MPR (dB)	16QAM			3GPP MPR (dB)
			Low CH 18675	Mid CH 18900	High CH 19125		Low CH 18675	Mid CH 18900	High CH 19125	
			1857.5 MHz	1880.0 MHz	1902.5 MHz		1857.5 MHz	1880.0 MHz	1902.5 MHz	
2 / 15M	1	0	23.94	24.32	<b>24.35</b>	0	22.94	23.32	23.35	1
	1	37	22.88	23.26	23.29	0	21.88	22.26	22.29	1
	1	74	23.41	23.79	23.82	0	22.41	22.79	22.82	1
	36	0	22.94	23.32	23.35	1	21.94	22.32	22.35	2
	36	19	21.88	22.26	22.29	1	20.88	21.26	21.29	2
	36	39	22.41	22.79	22.82	1	21.41	21.79	21.82	2
	75	0	22.29	22.70	22.63	1	21.29	21.70	21.63	2

LTE Band / BW	RB Size	RB Offset	QPSK			3GPP MPR (dB)	16QAM			3GPP MPR (dB)
			Low CH 18700	Mid CH 18900	High CH 19100		Low CH 18700	Mid CH 18900	High CH 19100	
			1860.0 MHz	1880.0 MHz	1900.0 MHz		1860.0 MHz	1880.0 MHz	1900.0 MHz	
2 / 20M	1	0	23.96	24.34	<b>24.37</b>	0	22.96	23.34	23.37	1
	1	50	22.90	23.28	23.31	0	21.90	22.28	22.31	1
	1	99	23.43	23.81	23.84	0	22.43	22.81	22.84	1
	50	0	22.96	23.34	23.37	1	21.96	22.34	22.37	2
	50	25	21.90	22.28	22.31	1	20.90	21.28	21.31	2
	50	50	22.43	22.81	22.84	1	21.43	21.81	21.84	2
	100	0	22.31	22.72	22.65	1	21.31	21.72	21.65	2

LTE Band / BW	RB Size	RB Offset	QPSK			3GPP MPR (dB)	16QAM			3GPP MPR (dB)
			Low CH 19957	Mid CH 20175	High CH 20393		Low CH 19957	Mid CH 20175	High CH 20393	
			1710.7 MHz	1732.5 MHz	1754.3 MHz		1710.7 MHz	1732.5 MHz	1754.3 MHz	
4 / 1.4M	1	0	22.87	23.07	<b>23.23</b>	0	21.87	22.07	22.23	1
	1	2	21.89	22.09	22.25	0	20.89	21.09	21.25	1
	1	5	22.48	22.68	22.84	0	21.48	21.68	21.84	1
	3	0	21.87	22.07	22.23	0	20.87	21.07	21.23	1
	3	1	20.89	21.09	21.25	0	19.89	20.09	20.25	1
	3	3	21.48	21.68	21.84	0	20.48	20.68	20.84	1
	6	0	21.05	21.38	21.64	1	20.05	20.38	20.64	2



# FCC SAR Test Report

LTE Band / BW	RB Size	RB Offset	QPSK			3GPP MPR (dB)	16QAM			3GPP MPR (dB)
			Low CH 19965	Mid CH 20175	High CH 20385		Low CH 19965	Mid CH 20175	High CH 20385	
			1711.5 MHz	1732.5 MHz	1753.5 MHz		1711.5 MHz	1732.5 MHz	1753.5 MHz	
4 / 3M	1	0	22.88	23.08	<b>23.24</b>	0	21.88	22.08	22.24	1
	1	7	21.90	22.10	22.26	0	20.90	21.10	21.26	1
	1	14	22.49	22.69	22.85	0	21.49	21.69	21.85	1
	8	0	21.88	22.08	22.24	1	20.88	21.08	21.24	2
	8	3	20.90	21.10	21.26	1	19.90	20.10	20.26	2
	8	7	21.49	21.69	21.85	1	20.49	20.69	20.85	2
	15	0	21.06	21.39	21.65	1	20.06	20.39	20.65	2

LTE Band / BW	RB Size	RB Offset	QPSK			3GPP MPR (dB)	16QAM			3GPP MPR (dB)
			Low CH 19975	Mid CH 20175	High CH 20375		Low CH 19975	Mid CH 20175	High CH 20375	
			1712.5 MHz	1732.5 MHz	1752.5 MHz		1712.5 MHz	1732.5 MHz	1752.5 MHz	
4 / 5M	1	0	22.90	23.10	<b>23.26</b>	0	21.90	22.10	22.26	1
	1	12	21.92	22.12	22.28	0	20.92	21.12	21.28	1
	1	24	22.51	22.71	22.87	0	21.51	21.71	21.87	1
	12	0	21.90	22.10	22.26	1	20.90	21.10	21.26	2
	12	6	20.92	21.12	21.28	1	19.92	20.12	20.28	2
	12	13	21.51	21.71	21.87	1	20.51	20.71	20.87	2
	25	0	21.08	21.41	21.67	1	20.08	20.41	20.67	2

LTE Band / BW	RB Size	RB Offset	QPSK			3GPP MPR (dB)	16QAM			3GPP MPR (dB)
			Low CH 20000	Mid CH 20175	High CH 20350		Low CH 20000	Mid CH 20175	High CH 20350	
			1715.0 MHz	1732.5 MHz	1750.0 MHz		1715.0 MHz	1732.5 MHz	1750.0 MHz	
4 / 10M	1	0	22.91	23.11	<b>23.27</b>	0	21.91	22.11	22.27	1
	1	24	21.93	22.13	22.29	0	20.93	21.13	21.29	1
	1	49	22.52	22.72	22.88	0	21.52	21.72	21.88	1
	25	0	21.91	22.11	22.27	1	20.91	21.11	21.27	2
	25	12	20.93	21.13	21.29	1	19.93	20.13	20.29	2
	25	25	21.52	21.72	21.88	1	20.52	20.72	20.88	2
	50	0	21.09	21.42	21.68	1	20.09	20.42	20.68	2

LTE Band / BW	RB Size	RB Offset	QPSK			3GPP MPR (dB)	16QAM			3GPP MPR (dB)
			Low CH 20025	Mid CH 20175	High CH 20325		Low CH 20025	Mid CH 20175	High CH 20325	
			1717.5 MHz	1732.5 MHz	1747.5 MHz		1717.5 MHz	1732.5 MHz	1747.5 MHz	
4 / 15M	1	0	22.93	23.13	<b>23.29</b>	0	21.93	22.13	22.29	1
	1	37	21.95	22.15	22.31	0	20.95	21.15	21.31	1
	1	74	22.54	22.74	22.90	0	21.54	21.74	21.90	1
	36	0	21.93	22.13	22.29	1	20.93	21.13	21.29	2
	36	19	20.95	21.15	21.31	1	19.95	20.15	20.31	2
	36	39	21.54	21.74	21.90	1	20.54	20.74	20.90	2
	75	0	21.11	21.44	21.70	1	20.11	20.44	20.70	2



# FCC SAR Test Report

A D T

LTE Band / BW	RB Size	RB Offset	QPSK			3GPP MPR (dB)	16QAM			3GPP MPR (dB)
			Low CH 20050	Mid CH 20175	High CH 20300		Low CH 20050	Mid CH 20175	High CH 20300	
			1720.0 MHz	1732.5 MHz	1745.0 MHz		1720.0 MHz	1732.5 MHz	1745.0 MHz	
4 / 20M	1	0	22.94	23.14	<b>23.30</b>	0	21.94	22.14	22.30	1
	1	50	21.96	22.16	22.32	0	20.96	21.16	21.32	1
	1	99	22.55	22.75	22.91	0	21.55	21.75	21.91	1
	50	0	21.94	22.14	22.30	1	20.94	21.14	21.30	2
	50	25	20.96	21.16	21.32	1	19.96	20.16	20.32	2
	50	50	21.55	21.75	21.91	1	20.55	20.75	20.91	2
	100	0	21.12	21.45	21.71	1	20.12	20.45	20.71	2

LTE Band / BW	RB Size	RB Offset	QPSK			3GPP MPR (dB)	16QAM			3GPP MPR (dB)
			Low CH 23017	Mid CH 23095	High CH 23173		Low CH 23017	Mid CH 23095	High CH 23173	
			699.7 MHz	707.5 MHz	715.3 MHz		699.7 MHz	707.5 MHz	715.3 MHz	
12 / 1.4M	1	0	21.75	21.76	21.85	0	20.75	20.76	20.85	1
	1	2	21.85	21.86	21.95	0	20.85	20.86	20.95	1
	1	5	22.10	22.11	<b>22.20</b>	0	21.10	21.11	21.20	1
	3	0	20.75	20.76	20.85	0	19.75	19.76	19.85	1
	3	1	20.85	20.86	20.95	0	19.85	19.86	19.95	1
	3	3	21.10	21.11	21.20	0	20.10	20.11	20.20	1
	6	0	21.06	21.08	21.14	1	20.06	20.08	20.14	2

LTE Band / BW	RB Size	RB Offset	QPSK			3GPP MPR (dB)	16QAM			3GPP MPR (dB)
			Low CH 23025	Mid CH 23095	High CH 23165		Low CH 23025	Mid CH 23095	High CH 23165	
			700.5 MHz	707.5 MHz	714.5 MHz		700.5 MHz	707.5 MHz	714.5 MHz	
12 / 3M	1	0	21.77	21.78	21.87	0	20.77	20.78	20.87	1
	1	7	21.87	21.88	21.97	0	20.87	20.88	20.97	1
	1	14	22.12	22.13	<b>22.22</b>	0	21.12	21.13	21.22	1
	8	0	20.77	20.78	20.87	1	19.77	19.78	19.87	2
	8	3	20.87	20.88	20.97	1	19.87	19.88	19.97	2
	8	7	21.12	21.13	21.22	1	20.12	20.13	20.22	2
	15	0	21.08	21.10	21.16	1	20.08	20.10	20.16	2

LTE Band / BW	RB Size	RB Offset	QPSK			3GPP MPR (dB)	16QAM			3GPP MPR (dB)
			Low CH 23035	Mid CH 23095	High CH 23155		Low CH 23035	Mid CH 23095	High CH 23155	
			701.5 MHz	707.5 MHz	713.5 MHz		701.5 MHz	707.5 MHz	713.5 MHz	
12 / 5M	1	0	21.78	21.79	21.88	0	20.78	20.79	20.88	1
	1	12	21.88	21.89	21.98	0	20.88	20.89	20.98	1
	1	24	22.13	22.14	<b>22.23</b>	0	21.13	21.14	21.23	1
	12	0	20.78	20.79	20.88	1	19.78	19.79	19.88	2
	12	6	20.88	20.89	20.98	1	19.88	19.89	19.98	2
	12	13	21.13	21.14	21.23	1	20.13	20.14	20.23	2
	25	0	21.09	21.11	21.17	1	20.09	20.11	20.17	2



# FCC SAR Test Report

LTE Band / BW	RB Size	RB Offset	QPSK			3GPP MPR (dB)	16QAM			3GPP MPR (dB)
			Low CH 23060	Mid CH 23095	High CH 23130		Low CH 23060	Mid CH 23095	High CH 23130	
			704.0 MHz	707.5 MHz	711.0 MHz		704.0 MHz	707.5 MHz	711.0 MHz	
12 / 10M	1	0	21.80	21.81	21.90	0	20.80	20.81	20.90	1
	1	24	21.90	21.91	22.00	0	20.90	20.91	21.00	1
	1	49	22.15	22.16	<b>22.25</b>	0	21.15	21.16	21.25	1
	25	0	20.80	20.81	20.90	1	19.80	19.81	19.90	2
	25	12	20.90	20.91	21.00	1	19.90	19.91	20.00	2
	25	25	21.15	21.16	21.25	1	20.15	20.16	20.25	2
	50	0	21.11	21.13	21.19	1	20.11	20.13	20.19	2

LTE Band / BW	RB Size	RB Offset	QPSK			3GPP MPR (dB)	16QAM			3GPP MPR (dB)
			Low CH 26047	Mid CH 26365	High CH 26683		Low CH 26047	Mid CH 26365	High CH 26683	
			1850.7 MHz	1882.5 MHz	1914.3 MHz		1850.7 MHz	1882.5 MHz	1914.3 MHz	
25 / 1.4M	1	0	23.84	24.32	<b>24.34</b>	0	22.84	23.32	23.34	1
	1	2	22.83	23.31	23.33	0	21.83	22.31	22.33	1
	1	5	23.39	23.87	23.89	0	22.39	22.87	22.89	1
	3	0	22.84	23.32	23.34	0	21.84	22.32	22.34	1
	3	1	21.83	22.31	22.33	0	20.83	21.31	21.33	1
	3	3	22.39	22.87	22.89	0	21.39	21.87	21.89	1
	6	0	22.35	22.75	22.55	1	21.35	21.75	21.55	2

LTE Band / BW	RB Size	RB Offset	QPSK			3GPP MPR (dB)	16QAM			3GPP MPR (dB)
			Low CH 26055	Mid CH 26365	High CH 26675		Low CH 26055	Mid CH 26365	High CH 26675	
			1851.5 MHz	1882.5 MHz	1913.5 MHz		1851.5 MHz	1882.5 MHz	1913.5 MHz	
25 / 3M	1	0	23.85	24.33	<b>24.35</b>	0	22.85	23.33	23.35	1
	1	7	22.84	23.32	23.34	0	21.84	22.32	22.34	1
	1	14	23.40	23.88	23.90	0	22.40	22.88	22.90	1
	8	0	22.85	23.33	23.35	1	21.85	22.33	22.35	2
	8	3	21.84	22.32	22.34	1	20.84	21.32	21.34	2
	8	7	22.40	22.88	22.90	1	21.40	21.88	21.90	2
	15	0	22.36	22.76	22.56	1	21.36	21.76	21.56	2

LTE Band / BW	RB Size	RB Offset	QPSK			3GPP MPR (dB)	16QAM			3GPP MPR (dB)
			Low CH 26065	Mid CH 26365	High CH 26665		Low CH 26065	Mid CH 26365	High CH 26665	
			1852.5 MHz	1882.5 MHz	1912.5 MHz		1852.5 MHz	1882.5 MHz	1912.5 MHz	
25 / 5M	1	0	23.86	24.34	<b>24.36</b>	0	22.86	23.34	23.36	1
	1	12	22.85	23.33	23.35	0	21.85	22.33	22.35	1
	1	24	23.41	23.89	23.91	0	22.41	22.89	22.91	1
	12	0	22.86	23.34	23.36	1	21.86	22.34	22.36	2
	12	6	21.85	22.33	22.35	1	20.85	21.33	21.35	2
	12	13	22.41	22.89	22.91	1	21.41	21.89	21.91	2
	25	0	22.37	22.77	22.57	1	21.37	21.77	21.57	2



# FCC SAR Test Report

LTE Band / BW	RB Size	RB Offset	QPSK			3GPP MPR (dB)	16QAM			3GPP MPR (dB)
			Low CH 26090	Mid CH 26365	High CH 26640		Low CH 26090	Mid CH 26365	High CH 26640	
			1855.0 MHz	1882.5 MHz	1910.0 MHz		1855.0 MHz	1882.5 MHz	1910.0 MHz	
25 / 10M	1	0	23.88	24.36	<b>24.38</b>	0	22.88	23.36	23.38	1
	1	24	22.87	23.35	23.37	0	21.87	22.35	22.37	1
	1	49	23.43	23.91	23.93	0	22.43	22.91	22.93	1
	25	0	22.88	23.36	23.38	1	21.88	22.36	22.38	2
	25	12	21.87	22.35	22.37	1	20.87	21.35	21.37	2
	25	25	22.43	22.91	22.93	1	21.43	21.91	21.93	2
	50	0	22.39	22.79	22.59	1	21.39	21.79	21.59	2

LTE Band / BW	RB Size	RB Offset	QPSK			3GPP MPR (dB)	16QAM			3GPP MPR (dB)
			Low CH 26115	Mid CH 26365	High CH 26615		Low CH 26115	Mid CH 26365	High CH 26615	
			1857.5 MHz	1882.5 MHz	1907.5 MHz		1857.5 MHz	1882.5 MHz	1907.5 MHz	
25 / 15M	1	0	23.89	24.37	<b>24.39</b>	0	22.89	23.37	23.39	1
	1	37	22.88	23.36	23.38	0	21.88	22.36	22.38	1
	1	74	23.44	23.92	23.94	0	22.44	22.92	22.94	1
	36	0	22.89	23.37	23.39	1	21.89	22.37	22.39	2
	36	19	21.88	22.36	22.38	1	20.88	21.36	21.38	2
	36	39	22.44	22.92	22.94	1	21.44	21.92	21.94	2
	75	0	22.40	22.80	22.60	1	21.40	21.80	21.60	2

LTE Band / BW	RB Size	RB Offset	QPSK			3GPP MPR (dB)	16QAM			3GPP MPR (dB)
			Low CH 26140	Mid CH 26365	High CH 26590		Low CH 26140	Mid CH 26365	High CH 26590	
			1860.0 MHz	1882.5 MHz	1905.0 MHz		1860.0 MHz	1882.5 MHz	1905.0 MHz	
25 / 20M	1	0	23.90	24.38	<b>24.40</b>	0	22.90	23.38	23.40	1
	1	50	22.89	23.37	23.39	0	21.89	22.37	22.39	1
	1	99	23.45	23.93	23.95	0	22.45	22.93	22.95	1
	50	0	22.90	23.38	23.40	1	21.90	22.38	22.40	2
	50	25	21.89	22.37	22.39	1	20.89	21.37	21.39	2
	50	50	22.45	22.93	22.95	1	21.45	21.93	21.95	2
	100	0	22.41	22.81	22.61	1	21.41	21.81	21.61	2

LTE Band / BW	RB Size	RB Offset	QPSK			3GPP MPR (dB)	16QAM			3GPP MPR (dB)
			Low CH 26697	Mid CH 26865	High CH 27033		Low CH 26697	Mid CH 26865	High CH 27033	
			814.7 MHz	831.0 MHz	848.3 MHz		814.7 MHz	831.0 MHz	848.3 MHz	
26 / 1.4M	1	0	22.09	22.20	<b>22.25</b>	0	21.09	21.20	21.25	1
	1	2	21.59	21.70	21.75	0	20.59	20.70	20.75	1
	1	5	22.05	22.16	22.21	0	21.05	21.16	21.21	1
	3	0	21.09	21.20	21.25	0	20.09	20.20	20.25	1
	3	1	20.59	20.70	20.75	0	19.59	19.70	19.75	1
	3	3	21.05	21.16	21.21	0	20.05	20.16	20.21	1
	6	0	21.00	21.07	21.15	1	20.00	20.07	20.15	2





# FCC SAR Test Report

LTE Band / BW	RB Size	RB Offset	QPSK			3GPP MPR (dB)	16QAM			3GPP MPR (dB)
			Low CH 26705	Mid CH 26865	High CH 27025		Low CH 26705	Mid CH 26865	High CH 27025	
			815.5 MHz	831.0 MHz	847.5 MHz		815.5 MHz	831.0 MHz	847.5 MHz	
26 / 3M	1	0	22.10	22.21	<b>22.26</b>	0	21.10	21.21	21.26	1
	1	7	21.60	21.71	21.76	0	20.60	20.71	20.76	1
	1	14	22.06	22.17	22.22	0	21.06	21.17	21.22	1
	8	0	21.10	21.21	21.26	1	20.10	20.21	20.26	2
	8	3	20.60	20.71	20.76	1	19.60	19.71	19.76	2
	8	7	21.06	21.17	21.22	1	20.06	20.17	20.22	2
	15	0	21.01	21.08	21.16	1	20.01	20.08	20.16	2

LTE Band / BW	RB Size	RB Offset	QPSK			3GPP MPR (dB)	16QAM			3GPP MPR (dB)
			Low CH 26715	Mid CH 26865	High CH 27015		Low CH 26715	Mid CH 26865	High CH 27015	
			816.5 MHz	831.0 MHz	846.5 MHz		816.5 MHz	831.0 MHz	846.5 MHz	
26 / 5M	1	0	22.12	22.23	<b>22.28</b>	0	21.12	21.23	21.28	1
	1	12	21.62	21.73	21.78	0	20.62	20.73	20.78	1
	1	24	22.08	22.19	22.24	0	21.08	21.19	21.24	1
	12	0	21.12	21.23	21.28	1	20.12	20.23	20.28	2
	12	6	20.62	20.73	20.78	1	19.62	19.73	19.78	2
	12	13	21.08	21.19	21.24	1	20.08	20.19	20.24	2
	25	0	21.03	21.10	21.18	1	20.03	20.10	20.18	2

LTE Band / BW	RB Size	RB Offset	QPSK			3GPP MPR (dB)	16QAM			3GPP MPR (dB)
			Low CH 26740	Mid CH 26865	High CH 26990		Low CH 26740	Mid CH 26865	High CH 26990	
			819.0 MHz	831.0 MHz	844.0 MHz		819.0 MHz	831.0 MHz	844.0 MHz	
26 / 10M	1	0	22.13	<b>22.24</b>	22.29	0	21.13	21.24	21.29	1
	1	24	21.63	21.74	21.79	0	20.63	20.74	20.79	1
	1	49	22.09	22.20	22.25	0	21.09	21.20	21.25	1
	25	0	21.13	21.24	21.29	1	20.13	20.24	20.29	2
	25	12	20.63	20.74	20.79	1	19.63	19.74	19.79	2
	25	25	21.09	21.20	21.25	1	20.09	20.20	20.25	2
	50	0	21.04	21.11	21.19	1	20.04	20.11	20.19	2

LTE Band / BW	RB Size	RB Offset	QPSK			3GPP MPR (dB)	16QAM			3GPP MPR (dB)
			Low CH 26765	Mid CH 26865	High CH 26965		Low CH 26765	Mid CH 26865	High CH 26965	
			821.5 MHz	831.0 MHz	841.5 MHz		821.5 MHz	831.0 MHz	841.5 MHz	
26 / 15M	1	0	22.14	22.25	<b>22.30</b>	0	21.14	21.25	21.30	1
	1	37	21.64	21.75	21.80	0	20.64	20.75	20.80	1
	1	74	22.10	22.21	22.26	0	21.10	21.21	21.26	1
	36	0	21.14	21.25	21.30	1	20.14	20.25	20.30	2
	36	19	20.64	20.75	20.80	1	19.64	19.75	19.80	2
	36	39	21.10	21.21	21.26	1	20.10	20.21	20.26	2
	75	0	21.05	21.12	21.20	1	20.05	20.12	20.20	2



# FCC SAR Test Report

LTE Band / BW	RB Size	RB Offset	QPSK					3GPP MPR (dB)	16QAM					3GPP MPR (dB)
			L-CH 39675	M-CH 40148	M-CH 40620	M-CH 41093	H-CH 41565		L-CH 39675	M-CH 40148	M-CH 40620	M-CH 41093	H-CH 41565	
			2498.5 MHz	2545.8 MHz	2593.0 MHz	2640.3 MHz	2687.5 MHz		2498.5 MHz	2545.8 MHz	2593.0 MHz	2640.3 MHz	2687.5 MHz	
41 / 5M	1	0	24.05	<b>24.11</b>	23.77	23.52	23.50	0	23.05	23.11	22.77	22.52	22.50	1
	1	12	23.80	23.86	23.52	23.27	23.25	0	22.80	22.86	22.52	22.27	22.25	1
	1	24	23.38	23.44	23.10	22.85	22.83	0	22.38	22.44	22.10	21.85	21.83	1
	12	0	23.05	23.11	22.77	22.52	22.50	1	22.05	22.11	21.77	21.52	21.50	2
	12	6	22.80	22.86	22.52	22.27	22.25	1	21.80	21.86	21.52	21.27	21.25	2
	12	13	22.38	22.44	22.10	21.85	21.83	1	21.38	21.44	21.10	20.85	20.83	2
	25	0	22.27	22.36	22.06	21.95	21.90	1	21.27	21.36	21.06	20.95	20.90	2

LTE Band / BW	RB Size	RB Offset	QPSK					3GPP MPR (dB)	16QAM					3GPP MPR (dB)
			L-CH 39700	M-CH 40160	M-CH 40620	M-CH 41080	H-CH 41540		L-CH 39700	M-CH 40160	M-CH 40620	M-CH 41080	H-CH 41540	
			2501.0 MHz	2547.0 MHz	2593.0 MHz	2639.0 MHz	2685.0 MHz		2501.0 MHz	2547.0 MHz	2593.0 MHz	2639.0 MHz	2685.0 MHz	
41 / 10M	1	0	24.06	<b>24.12</b>	23.78	23.53	23.51	0	23.06	23.12	22.78	22.53	22.51	1
	1	24	23.81	23.87	23.53	23.28	23.26	0	22.81	22.87	22.53	22.28	22.26	1
	1	49	23.39	23.45	23.11	22.86	22.84	0	22.39	22.45	22.11	21.86	21.84	1
	25	0	23.06	23.12	22.78	22.53	22.51	1	22.06	22.12	21.78	21.53	21.51	2
	25	12	22.81	22.87	22.53	22.28	22.26	1	21.81	21.87	21.53	21.28	21.26	2
	25	25	22.39	22.45	22.11	21.86	21.84	1	21.39	21.45	21.11	20.86	20.84	2
	50	0	22.28	22.37	22.07	21.96	21.91	1	21.28	21.37	21.07	20.96	20.91	2

LTE Band / BW	RB Size	RB Offset	QPSK					3GPP MPR (dB)	16QAM					3GPP MPR (dB)
			L-CH 39725	M-CH 40173	M-CH 40620	M-CH 41068	H-CH 41515		L-CH 39725	M-CH 40173	M-CH 40620	M-CH 41068	H-CH 41515	
			2503.5 MHz	2548.3 MHz	2593.0 MHz	2637.8 MHz	2682.5 MHz		2503.5 MHz	2548.3 MHz	2593.0 MHz	2637.8 MHz	2682.5 MHz	
41 / 15M	1	0	24.08	<b>24.14</b>	23.80	23.55	23.53	0	23.08	23.14	22.80	22.55	22.53	1
	1	37	23.83	23.89	23.55	23.30	23.28	0	22.83	22.89	22.55	22.30	22.28	1
	1	74	23.41	23.47	23.13	22.88	22.86	0	22.41	22.47	22.13	21.88	21.86	1
	36	0	23.08	23.14	22.80	22.55	22.53	1	22.08	22.14	21.80	21.55	21.53	2
	36	19	22.83	22.89	22.55	22.30	22.28	1	21.83	21.89	21.55	21.30	21.28	2
	36	39	22.41	22.47	22.13	21.88	21.86	1	21.41	21.47	21.13	20.88	20.86	2
	75	0	22.30	22.39	22.09	21.98	21.93	1	21.30	21.39	21.09	20.98	20.93	2

LTE Band / BW	RB Size	RB Offset	QPSK					3GPP MPR (dB)	16QAM					3GPP MPR (dB)
			L-CH 39750	M-CH 40185	M-CH 40620	M-CH 41055	H-CH 41490		L-CH 39750	M-CH 40185	M-CH 40620	M-CH 41055	H-CH 41490	
			2506.0 MHz	2549.5 MHz	2593.0 MHz	2636.5 MHz	2680.0 MHz		2506.0 MHz	2549.5 MHz	2593.0 MHz	2636.5 MHz	2680.0 MHz	
41 / 20M	1	0	24.09	<b>24.15</b>	23.81	23.56	23.54	0	23.09	23.15	22.81	22.56	22.54	1
	1	50	23.84	23.90	23.56	23.31	23.29	0	22.84	22.90	22.56	22.31	22.29	1
	1	99	23.42	23.48	23.14	22.89	22.87	0	22.42	22.48	22.14	21.89	21.87	1
	50	0	23.09	23.15	22.81	22.56	22.54	1	22.09	22.15	21.81	21.56	21.54	2
	50	25	22.84	22.90	22.56	22.31	22.29	1	21.84	21.90	21.56	21.31	21.29	2
	50	50	22.42	22.48	22.14	21.89	21.87	1	21.42	21.48	21.14	20.89	20.87	2
	100	0	22.31	22.40	22.10	21.99	21.94	1	21.31	21.40	21.10	20.99	20.94	2



# FCC SAR Test Report

## <WLAN 2.4G>

Mode	802.11b		
Channel / Frequency (MHz)	1 (2412)	6 (2437)	11 (2462)
Average Power	17.53	18.01	18.00
Mode	802.11g		
Channel / Frequency (MHz)	1 (2412)	6 (2437)	11 (2462)
Average Power	16.15	16.18	15.71
Mode	802.11n (HT20)		
Channel / Frequency (MHz)	1 (2412)	6 (2437)	11 (2462)
Average Power	15.94	16.14	15.64
Mode	802.11n (HT40)		
Channel / Frequency (MHz)	3 (2422)	6 (2437)	9 (2452)
Average Power	11.04	11.34	11.24

## <WLAN 5.2G>

Mode	802.11a			
Channel / Frequency (MHz)	36 (5180)	40 (5200)	44 (5220)	48 (5240)
Average Power	15.43	15.67	15.66	15.72
Mode	802.11n (HT20)			
Channel / Frequency (MHz)	36 (5180)	40 (5200)	44 (5220)	48 (5240)
Average Power	15.61	15.63	15.64	15.56
Mode	802.11n (HT40)			
Channel / Frequency (MHz)	38 (5190)		46 (5230)	
Average Power	12.70		12.56	
Mode	802.11ac (VHT80)			
Channel / Frequency (MHz)	42 (5210)			
Average Power	10.81			

## <WLAN 5.3G>

Mode	802.11a			
Channel / Frequency (MHz)	52 (5260)	56 (5280)	60 (5300)	64 (5320)
Average Power	15.95	15.73	16.01	15.63
Mode	802.11n (HT20)			
Channel / Frequency (MHz)	52 (5260)	56 (5280)	60 (5300)	64 (5320)
Average Power	15.78	15.71	16.03	15.62
Mode	802.11n (HT40)			
Channel / Frequency (MHz)	54 (5270)		62 (5310)	
Average Power	12.81		13.09	
Mode	802.11ac (VHT80)			
Channel / Frequency (MHz)	58 (5290)			
Average Power	10.73			



## FCC SAR Test Report

## &lt;WLAN 5.6G&gt;

Mode	802.11a							
Channel / Frequency (MHz)	100 (5500)	104 (5520)	108 (5540)	112 (5560)	116 (5580)	132 (5660)	136 (5680)	140 (5700)
Average Power	14.82	15.79	15.77	15.67	<b>16.28</b>	15.87	15.56	14.12
Mode	802.11n (HT20)							
Channel / Frequency (MHz)	100 (5500)	104 (5520)	108 (5540)	112 (5560)	116 (5580)	132 (5660)	136 (5680)	140 (5700)
Average Power	14.60	15.62	15.75	15.66	<b>16.09</b>	15.58	15.63	14.17
Mode	802.11n (HT40)							
Channel / Frequency (MHz)	102 (5510)				134 (5670)			
Average Power	12.89				12.83			
Mode	802.11ac (VHT80)							
Channel / Frequency (MHz)	106 (5530)				138 (5690)			
Average Power	10.82				10.51			

## &lt;WLAN 5.8G&gt;

Mode	802.11a				
Channel / Frequency (MHz)	149 (5745)	153 (5765)	157 (5785)	161 (5805)	165 (5825)
Average Power	15.78	15.77	<b>15.82</b>	<b>15.82</b>	15.56
Mode	802.11n (HT20)				
Channel / Frequency (MHz)	149 (5745)	153 (5765)	157 (5785)	161 (5805)	165 (5825)
Average Power	15.65	15.69	<b>15.87</b>	15.82	15.84
Mode	802.11n (HT40)				
Channel / Frequency (MHz)	151 (5755)		159 (5795)		
Average Power	12.73		12.91		
Mode	802.11ac (VHT80)				
Channel / Frequency (MHz)	155 (5775)				
Average Power	11.14				



# FCC SAR Test Report

A D T

## 4.7 SAR Testing Results

### 4.7.1 SAR Results for Head

Plot No.	Band	Mode	Test Position	Ch.	Tx Antenna	Max. Tune-up Power (dBm)	Measured Conducted Power (dBm)	Scaling Factor	Power Drift (dB)	Measured SAR-1g (W/kg)	Scaled SAR-1g (W/kg)
01	CDMA BC0	RC3+SO55	Right Cheek	384	0	25.0	24.88	1.03	-0.05	0.114	0.12
	CDMA BC0	RC3+SO55	Right Cheek	384	1	25.0	24.88	1.03	0.03	0.545	0.56
	CDMA BC0	RC3+SO55	Right Tilted	384	0	25.0	24.88	1.03	0.17	0.057	0.06
	CDMA BC0	RC3+SO55	Right Tilted	384	1	25.0	24.88	1.03	0.02	0.265	0.27
	CDMA BC0	RC3+SO55	Left Cheek	384	0	25.0	24.88	1.03	0.15	0.154	0.16
	CDMA BC0	RC3+SO55	Left Cheek	384	1	25.0	24.88	1.03	0.06	0.302	0.31
	CDMA BC0	RC3+SO55	Left Tilted	384	0	25.0	24.88	1.03	0.04	0.064	0.07
	CDMA BC0	RC3+SO55	Left Tilted	384	1	25.0	24.88	1.03	0.05	0.165	0.17
02	CDMA BC1	RC3+SO55	Right Cheek	600	0	24.5	24.49	1.00	0.12	0.091	0.09
	CDMA BC1	RC3+SO55	Right Cheek	600	1	24.5	24.49	1.00	0.08	0.371	0.37
	CDMA BC1	RC3+SO55	Right Tilted	600	0	24.5	24.49	1.00	0.14	0.04	0.04
	CDMA BC1	RC3+SO55	Right Tilted	600	1	24.5	24.49	1.00	0.05	0.275	0.28
	CDMA BC1	RC3+SO55	Left Cheek	600	0	24.5	24.49	1.00	0.13	0.17	0.17
	CDMA BC1	RC3+SO55	Left Cheek	600	1	24.5	24.49	1.00	0.07	0.19	0.19
	CDMA BC1	RC3+SO55	Left Tilted	600	0	24.5	24.49	1.00	0.05	0.06	0.06
	CDMA BC1	RC3+SO55	Left Tilted	600	1	24.5	24.49	1.00	0.08	0.163	0.16
03	CDMA BC10	RC3+SO55	Right Cheek	476	0	24.5	24.12	1.09	0.02	0.09	0.10
	CDMA BC10	RC3+SO55	Right Cheek	476	1	24.5	24.12	1.09	0.03	0.493	0.54
	CDMA BC10	RC3+SO55	Right Tilted	476	0	24.5	24.12	1.09	0.15	0.05	0.05
	CDMA BC10	RC3+SO55	Right Tilted	476	1	24.5	24.12	1.09	0.04	0.25	0.27
	CDMA BC10	RC3+SO55	Left Cheek	476	0	24.5	24.12	1.09	0.13	0.134	0.15
	CDMA BC10	RC3+SO55	Left Cheek	476	1	24.5	24.12	1.09	0.03	0.27	0.29
	CDMA BC10	RC3+SO55	Left Tilted	476	0	24.5	24.12	1.09	0.00	0.064	0.07
	CDMA BC10	RC3+SO55	Left Tilted	476	1	24.5	24.12	1.09	0.05	0.133	0.15

#### Note:

- SAR is performed on the highest power channel. When the reported SAR value of highest power channel is <= 0.8 W/kg, SAR testing for optional channel is not required.

Plot No.	Band	Mode	Test Position	Ch.	Tx Antenna	RB#	RB Offset	Max. Tune-up Power (dBm)	Measured Conducted Power (dBm)	Scaling Factor	Power Drift (dB)	Measured SAR-1g (W/kg)	Scaled SAR-1g (W/kg)
04	LTE 2	QPSK20M	Right Cheek	19100	0	1	0	24.5	24.37	1.03	0.08	0.081	0.08
	LTE 2	QPSK20M	Right Cheek	19100	1	1	0	24.5	24.37	1.03	0.12	0.259	0.27
	LTE 2	QPSK20M	Right Cheek	19100	0	50	0	23.5	23.37	1.03	0.03	0.052	0.05
	LTE 2	QPSK20M	Right Cheek	19100	1	50	0	23.5	23.37	1.03	0.04	0.186	0.19
	LTE 2	QPSK20M	Right Tilted	19100	0	1	0	24.5	24.37	1.03	0.05	0.031	0.03
	LTE 2	QPSK20M	Right Tilted	19100	1	1	0	24.5	24.37	1.03	0.10	0.228	0.23
	LTE 2	QPSK20M	Right Tilted	19100	0	50	0	23.5	23.37	1.03	0.04	0.02	0.02
	LTE 2	QPSK20M	Right Tilted	19100	1	50	0	23.5	23.37	1.03	0.17	0.154	0.16
	LTE 2	QPSK20M	Left Cheek	19100	0	1	0	24.5	24.37	1.03	0.01	0.141	0.15
	LTE 2	QPSK20M	Left Cheek	19100	1	1	0	24.5	24.37	1.03	0.08	0.166	0.17
	LTE 2	QPSK20M	Left Cheek	19100	0	50	0	23.5	23.37	1.03	0.03	0.091	0.09
	LTE 2	QPSK20M	Left Cheek	19100	1	50	0	23.5	23.37	1.03	0.01	0.112	0.12
	LTE 2	QPSK20M	Left Tilted	19100	0	1	0	24.5	24.37	1.03	0.08	0.044	0.05
	LTE 2	QPSK20M	Left Tilted	19100	1	1	0	24.5	24.37	1.03	0.18	0.156	0.16
	LTE 2	QPSK20M	Left Tilted	19100	0	50	0	23.5	23.37	1.03	0.16	0.028	0.03
	LTE 2	QPSK20M	Left Tilted	19100	1	50	0	23.5	23.37	1.03	0.15	0.104	0.11



# FCC SAR Test Report

Plot No.	Band	Mode	Test Position	Ch.	Tx Antenna	RB#	RB Offset	Max. Tune-up Power (dBm)	Measured Conducted Power (dBm)	Scaling Factor	Power Drift (dB)	Measured SAR-1g (W/kg)	Scaled SAR-1g (W/kg)
05	LTE 4	QPSK20M	Right Cheek	20300	0	1	0	23.5	23.30	1.05	0.05	0.068	0.07
	LTE 4	QPSK20M	Right Cheek	20300	1	1	0	23.5	23.30	1.05	0.13	0.363	0.38
	LTE 4	QPSK20M	Right Cheek	20300	0	50	0	22.5	22.30	1.05	0.07	0.061	0.06
	LTE 4	QPSK20M	Right Cheek	20300	1	50	0	22.5	22.30	1.05	0.12	0.337	0.35
	LTE 4	QPSK20M	Right Tilted	20300	0	1	0	23.5	23.30	1.05	0.08	0.037	0.04
	LTE 4	QPSK20M	Right Tilted	20300	1	1	0	23.5	23.30	1.05	0.09	0.321	0.34
	LTE 4	QPSK20M	Right Tilted	20300	0	50	0	22.5	22.30	1.05	0.09	0.033	0.03
	LTE 4	QPSK20M	Right Tilted	20300	1	50	0	22.5	22.30	1.05	0.08	0.288	0.30
	LTE 4	QPSK20M	Left Cheek	20300	0	1	0	23.5	23.30	1.05	0.06	0.101	0.11
	LTE 4	QPSK20M	Left Cheek	20300	1	1	0	23.5	23.30	1.05	0.11	0.234	0.25
	LTE 4	QPSK20M	Left Cheek	20300	0	50	0	22.5	22.30	1.05	0.01	0.089	0.09
	LTE 4	QPSK20M	Left Cheek	20300	1	50	0	22.5	22.30	1.05	0.09	0.21	0.22
	LTE 4	QPSK20M	Left Tilted	20300	0	1	0	23.5	23.30	1.05	0.15	0.051	0.05
	LTE 4	QPSK20M	Left Tilted	20300	1	1	0	23.5	23.30	1.05	0.06	0.233	0.24
	LTE 4	QPSK20M	Left Tilted	20300	0	50	0	22.5	22.30	1.05	0.00	0.045	0.05
	LTE 4	QPSK20M	Left Tilted	20300	1	50	0	22.5	22.30	1.05	0.06	0.208	0.22
06	LTE 12	QPSK10M	Right Cheek	23130	0	1	49	22.5	22.25	1.06	0.05	0.021	0.02
	LTE 12	QPSK10M	Right Cheek	23130	1	1	49	22.5	22.25	1.06	0.01	0.19	0.20
	LTE 12	QPSK10M	Right Cheek	23130	0	25	25	21.5	21.25	1.06	-0.09	0.029	0.03
	LTE 12	QPSK10M	Right Cheek	23130	1	25	25	21.5	21.25	1.06	0.02	0.107	0.11
	LTE 12	QPSK10M	Right Tilted	23130	0	1	49	22.5	22.25	1.06	0.03	0.016	0.02
	LTE 12	QPSK10M	Right Tilted	23130	1	1	49	22.5	22.25	1.06	-0.15	0.07	0.07
	LTE 12	QPSK10M	Right Tilted	23130	0	25	25	21.5	21.25	1.06	0.12	0.021	0.02
	LTE 12	QPSK10M	Right Tilted	23130	1	25	25	21.5	21.25	1.06	0.13	0.067	0.07
	LTE 12	QPSK10M	Left Cheek	23130	0	1	49	22.5	22.25	1.06	0.05	0.028	0.03
	LTE 12	QPSK10M	Left Cheek	23130	1	1	49	22.5	22.25	1.06	-0.04	0.09	0.10
	LTE 12	QPSK10M	Left Cheek	23130	0	25	25	21.5	21.25	1.06	0.01	0.043	0.05
	LTE 12	QPSK10M	Left Cheek	23130	1	25	25	21.5	21.25	1.06	-0.04	0.051	0.05
	LTE 12	QPSK10M	Left Tilted	23130	0	1	49	22.5	22.25	1.06	0.05	0.015	0.02
	LTE 12	QPSK10M	Left Tilted	23130	1	1	49	22.5	22.25	1.06	-0.12	0.056	0.06
	LTE 12	QPSK10M	Left Tilted	23130	0	25	25	21.5	21.25	1.06	0.07	0.024	0.03
	LTE 12	QPSK10M	Left Tilted	23130	1	25	25	21.5	21.25	1.06	-0.04	0.035	0.04
07	LTE 25	QPSK20M	Right Cheek	26590	0	1	0	24.5	24.40	1.02	0.03	0.076	0.08
	LTE 25	QPSK20M	Right Cheek	26590	1	1	0	24.5	24.40	1.02	0.11	0.273	0.28
	LTE 25	QPSK20M	Right Cheek	26590	0	50	0	23.5	23.40	1.02	0.07	0.064	0.07
	LTE 25	QPSK20M	Right Cheek	26590	1	50	0	23.5	23.40	1.02	0.08	0.247	0.25
	LTE 25	QPSK20M	Right Tilted	26590	0	1	0	24.5	24.40	1.02	0.01	0.029	0.03
	LTE 25	QPSK20M	Right Tilted	26590	1	1	0	24.5	24.40	1.02	0.13	0.226	0.23
	LTE 25	QPSK20M	Right Tilted	26590	0	50	0	23.5	23.40	1.02	0.07	0.018	0.02
	LTE 25	QPSK20M	Right Tilted	26590	1	50	0	23.5	23.40	1.02	0.08	0.203	0.21
	LTE 25	QPSK20M	Left Cheek	26590	0	1	0	24.5	24.40	1.02	0.07	0.133	0.14
	LTE 25	QPSK20M	Left Cheek	26590	1	1	0	24.5	24.40	1.02	0.05	0.168	0.17
	LTE 25	QPSK20M	Left Cheek	26590	0	50	0	23.5	23.40	1.02	0.01	0.11	0.11
	LTE 25	QPSK20M	Left Cheek	26590	1	50	0	23.5	23.40	1.02	0.08	0.148	0.15
	LTE 25	QPSK20M	Left Tilted	26590	0	1	0	24.5	24.40	1.02	0.01	0.042	0.04
	LTE 25	QPSK20M	Left Tilted	26590	1	1	0	24.5	24.40	1.02	0.06	0.155	0.16
	LTE 25	QPSK20M	Left Tilted	26590	0	50	0	23.5	23.40	1.02	0.10	0.036	0.04
	LTE 25	QPSK20M	Left Tilted	26590	1	50	0	23.5	23.40	1.02	0.05	0.136	0.14



# FCC SAR Test Report

Plot No.	Band	Mode	Test Position	Ch.	Tx Antenna	RB#	RB Offset	Max. Tune-up Power (dBm)	Measured Conducted Power (dBm)	Scaling Factor	Power Drift (dB)	Measured SAR-1g (W/kg)	Scaled SAR-1g (W/kg)
08	LTE 26	QPSK15M	Right Cheek	26965	0	1	0	22.5	22.30	1.05	0.02	0.101	0.11
	LTE 26	QPSK15M	Right Cheek	26965	1	1	0	22.5	22.30	1.05	0.04	0.536	0.56
	LTE 26	QPSK15M	Right Cheek	26965	0	36	0	21.5	21.30	1.05	0.00	0.088	0.09
	LTE 26	QPSK15M	Right Cheek	26965	1	36	0	21.5	21.30	1.05	-0.04	0.365	0.38
	LTE 26	QPSK15M	Right Tilted	26965	0	1	0	22.5	22.30	1.05	0.05	0.052	0.05
	LTE 26	QPSK15M	Right Tilted	26965	1	1	0	22.5	22.30	1.05	-0.02	0.25	0.26
	LTE 26	QPSK15M	Right Tilted	26965	0	36	0	21.5	21.30	1.05	0.11	0.043	0.05
	LTE 26	QPSK15M	Right Tilted	26965	1	36	0	21.5	21.30	1.05	0.06	0.181	0.19
	LTE 26	QPSK15M	Left Cheek	26965	0	1	0	22.5	22.30	1.05	0.02	0.143	0.15
	LTE 26	QPSK15M	Left Cheek	26965	1	1	0	22.5	22.30	1.05	0.00	0.279	0.29
	LTE 26	QPSK15M	Left Cheek	26965	0	36	0	21.5	21.30	1.05	-0.01	0.125	0.13
	LTE 26	QPSK15M	Left Cheek	26965	1	36	0	21.5	21.30	1.05	0.01	0.202	0.21
	LTE 26	QPSK15M	Left Tilted	26965	0	1	0	22.5	22.30	1.05	0.09	0.056	0.06
	LTE 26	QPSK15M	Left Tilted	26965	1	1	0	22.5	22.30	1.05	-0.07	0.15	0.16
	LTE 26	QPSK15M	Left Tilted	26965	0	36	0	21.5	21.30	1.05	0.07	0.047	0.05
	LTE 26	QPSK15M	Left Tilted	26965	1	36	0	21.5	21.30	1.05	-0.05	0.112	0.12
09	LTE 41	QPSK20M	Right Cheek	40185	0	1	0	24.5	24.15	1.08	0.09	0.083	0.09
	LTE 41	QPSK20M	Right Cheek	40185	1	1	0	24.5	24.15	1.08	0.09	0.188	0.20
	LTE 41	QPSK20M	Right Cheek	40185	0	50	0	23.5	23.15	1.08	0.02	0.056	0.06
	LTE 41	QPSK20M	Right Cheek	40185	1	50	0	23.5	23.15	1.08	0.14	0.235	0.25
	LTE 41	QPSK20M	Right Tilted	40185	0	1	0	24.5	24.15	1.08	0.19	0.059	0.06
	LTE 41	QPSK20M	Right Tilted	40185	1	1	0	24.5	24.15	1.08	0.11	0.127	0.14
	LTE 41	QPSK20M	Right Tilted	40185	0	50	0	23.5	23.15	1.08	0.02	0.042	0.05
	LTE 41	QPSK20M	Right Tilted	40185	1	50	0	23.5	23.15	1.08	-0.03	0.147	0.16
	LTE 41	QPSK20M	Left Cheek	40185	0	1	0	24.5	24.15	1.08	0.02	0.183	0.20
	LTE 41	QPSK20M	Left Cheek	40185	1	1	0	24.5	24.15	1.08	0.09	0.197	0.21
	LTE 41	QPSK20M	Left Cheek	40185	0	50	0	23.5	23.15	1.08	0.07	0.13	0.14
	LTE 41	QPSK20M	Left Cheek	40185	1	50	0	23.5	23.15	1.08	0.01	0.095	0.10
	LTE 41	QPSK20M	Left Tilted	40185	0	1	0	24.5	24.15	1.08	0.07	0.033	0.04
	LTE 41	QPSK20M	Left Tilted	40185	1	1	0	24.5	24.15	1.08	0.19	0.128	0.14
	LTE 41	QPSK20M	Left Tilted	40185	0	50	0	23.5	23.15	1.08	0.00	0.022	0.02
	LTE 41	QPSK20M	Left Tilted	40185	1	50	0	23.5	23.15	1.08	0.14	0.065	0.07

### Note:

1. According to KDB 941225, LTE SAR testing for remaining RB offset configurations and required test channels is not required when the reported SAR of highest power 1RB configuration is less than 0.8 W/kg.
2. According to KDB 941225, LTE SAR testing for remaining RB offset configurations and required test channels is not required when the reported SAR of highest power 50% RB configuration is less than 0.8 W/kg.
3. According to KDB 941225, LTE SAR testing for 100% RB is not required when the maximum power of 100% RB is less than the maximum power of 1RB and 50% RB, and the highest reported SAR for 1RB and 50% RB is less than 0.8 W/kg.
4. According to KDB 941225, LTE SAR testing for 16QAM is not required when the maximum power of 16QAM is less 1/2 dB higher than QPSK, and the highest reported SAR of QPSK is less than 1.45 W/kg.
5. According to KDB 941225, LTE SAR testing for smaller channel bandwidth is not required when the maximum power of smaller channel bandwidth is less 1/2 dB higher than largest channel bandwidth, and the highest reported SAR of largest channel bandwidth is less than 1.45 W/kg.
6. According to October 2014 TCB Workshop, head SAR for VoLTE was measured according to existing data mode configurations.



# FCC SAR Test Report

Plot No.	Band	Mode	Test Position	Ch.	Max. Tune-up Power (dBm)	Measured Conducted Power (dBm)	Scaling Factor	Power Drift (dB)	Measured SAR-1g (W/kg)	Scaled SAR-1g (W/kg)
	802.11b	-	Right Cheek	6	18.5	18.01	1.12	0.13	0.074	0.08
	802.11b	-	Right Tilted	6	18.5	18.01	1.12	0.00	0.042	0.05
10	802.11b	-	Left Cheek	6	18.5	18.01	1.12	-0.06	0.218	0.24
	802.11b	-	Left Tilted	6	18.5	18.01	1.12	0.04	0.176	0.20
	802.11a	-	Right Cheek	48	16.0	15.72	1.07	0.09	0.139	0.15
	802.11a	-	Right Tilted	48	16.0	15.72	1.07	0.15	0.09	0.10
11	802.11a	-	Left Cheek	48	16.0	15.72	1.07	-0.09	0.513	0.55
	802.11ac	VH80	Left Cheek	42	11.0	10.81	1.04	0.09	0.107	0.11
	802.11a	-	Left Tilted	48	16.0	15.72	1.07	0.04	0.241	0.26
	802.11a	-	Right Cheek	60	16.5	16.01	1.12	0.10	0.101	0.11
	802.11a	-	Right Tilted	60	16.5	16.01	1.12	0.09	0.016	0.02
12	802.11a	-	Left Cheek	60	16.5	16.01	1.12	0.06	0.521	0.58
	802.11ac	VH80	Light Cheek	58	11.0	10.73	1.06	0.04	0.161	0.17
	802.11a	-	Left Tilted	60	16.5	16.01	1.12	-0.06	0.211	0.24
	802.11a	-	Right Cheek	116	16.5	16.28	1.05	0.14	0.121	0.13
	802.11a	-	Right Tilted	116	16.5	16.28	1.05	0.13	0.158	0.17
13	802.11a	-	Left Cheek	116	16.5	16.28	1.05	-0.05	0.346	0.36
	802.11ac	VH80	Left Cheek	106	11.0	10.82	1.04	0.08	0.089	0.09
	802.11a	-	Left Tilted	116	16.5	16.28	1.05	0.10	0.165	0.17
	802.11a	-	Right Cheek	157	16.0	15.82	1.04	0.08	0.1	0.10
	802.11a	-	Right Tilted	157	16.0	15.82	1.04	0.05	0.094	0.10
14	802.11a	-	Left Cheek	157	16.0	15.82	1.04	-0.08	0.3	0.31
	802.11ac	VH80	Left Cheek	155	11.5	11.14	1.09	0.08	0.077	0.08
	802.11a	-	Left Tilted	157	16.0	15.82	1.04	-0.10	0.11	0.11

### Note:

1. According to KDB 248227, when the extrapolated maximum peak SAR for the maximum output power channel is  $\leq 1.6$  W/kg and the 1g averaged SAR is  $\leq 0.8$  W/kg, WLAN SAR testing for other channels is not required.
2. SAR testing for 802.11g/n is not required when its maximum power is less than 1/4 dB higher than 802.11b.
3. SAR testing for 802.11n is not required when its maximum power is less than 1/4 dB higher than 802.11a.
4. According to April 2013 TCB Workshop, 802.11ac SAR testing is not required when its maximum power is less than 1/4 dB higher than 802.11a. 802.11ac SAR is required for the highest 802.11a configuration in each 5 GHz band and each exposure condition.

### 4.7.2 SAR Results for Body-Worn (Separation Distance is 1.0 cm Gap)

Plot No.	Band	Mode	Test Position	Ch.	Tx Antenna	Max. Tune-up Power (dBm)	Measured Conducted Power (dBm)	Scaling Factor	Power Drift (dB)	Measured SAR-1g (W/kg)	Scaled SAR-1g (W/kg)
	CDMA BC0	RTAP 153.6	Front Face	777	0	25.0	23.98	1.26	0.07	0.168	0.21
	CDMA BC0	RTAP 153.6	Front Face	777	1	25.0	23.98	1.26	0.07	0.082	0.10
15	CDMA BC0	RTAP 153.6	Rear Face	777	0	25.0	23.98	1.26	0.03	0.279	0.35
	CDMA BC0	RTAP 153.6	Rear Face	777	1	25.0	23.98	1.26	-0.13	0.074	0.09
	CDMA BC1	RTAP 153.6	Front Face	600	0	24.5	24.48	1.00	0.18	0.115	0.12
	CDMA BC1	RTAP 153.6	Front Face	600	1	24.5	24.48	1.00	-0.01	0.069	0.07
16	CDMA BC1	RTAP 153.6	Rear Face	600	0	24.5	24.48	1.00	0.10	0.132	0.13
	CDMA BC1	RTAP 153.6	Rear Face	600	1	24.5	24.48	1.00	-0.02	0.096	0.10
	CDMA BC10	RTAP 153.6	Front Face	476	0	24.5	23.70	1.20	0.01	0.144	0.17
	CDMA BC10	RTAP 153.6	Front Face	476	1	24.5	23.70	1.20	0.04	0.084	0.10
17	CDMA BC10	RTAP 153.6	Rear Face	476	0	24.5	23.70	1.20	0.00	0.222	0.27
	CDMA BC10	RTAP 153.6	Rear Face	476	1	24.5	23.70	1.20	0.01	0.122	0.15

### Note:

1. SAR is performed on the highest power channel. When the reported SAR value of highest power channel is  $\leq 0.8$  W/kg, SAR testing for optional channel is not required.





# FCC SAR Test Report

Plot No.	Band	Mode	Test Position	Ch.	Tx Antenna	RB#	RB Offset	Max. Tune-up Power (dBm)	Measured Conducted Power (dBm)	Scaling Factor	Power Drift (dB)	Measured SAR-1g (W/kg)	Scaled SAR-1g (W/kg)
	LTE 2	QPSK20M	Front Face	19100	0	1	0	24.5	24.37	1.03	0.05	0.101	0.10
	LTE 2	QPSK20M	Front Face	19100	0	50	0	23.5	23.37	1.03	0.09	0.069	0.07
	LTE 2	QPSK20M	Front Face	19100	1	1	0	24.5	24.37	1.03	0.13	0.066	0.07
	LTE 2	QPSK20M	Front Face	19100	1	50	0	23.5	23.37	1.03	0.01	0.043	0.04
18	LTE 2	QPSK20M	Rear Face	19100	0	1	0	24.5	24.37	1.03	0.06	0.103	0.11
	LTE 2	QPSK20M	Rear Face	19100	0	50	0	23.5	23.37	1.03	0.00	0.082	0.08
	LTE 2	QPSK20M	Rear Face	19100	1	1	0	24.5	24.37	1.03	-0.03	0.097	0.10
	LTE 2	QPSK20M	Rear Face	19100	1	50	0	23.5	23.37	1.03	-0.05	0.066	0.07
	LTE 4	QPSK20M	Front Face	20300	0	1	0	23.5	23.30	1.05	0.03	0.057	0.06
	LTE 4	QPSK20M	Front Face	20300	0	50	0	22.5	22.30	1.05	0.15	0.049	0.05
	LTE 4	QPSK20M	Front Face	20300	1	1	0	23.5	23.30	1.05	0.18	0.113	0.12
	LTE 4	QPSK20M	Front Face	20300	1	50	0	22.5	22.30	1.05	0.10	0.108	0.11
	LTE 4	QPSK20M	Rear Face	20300	0	1	0	23.5	23.30	1.05	0.10	0.086	0.09
	LTE 4	QPSK20M	Rear Face	20300	0	50	0	22.5	22.30	1.05	0.09	0.062	0.06
19	LTE 4	QPSK20M	Rear Face	20300	1	1	0	23.5	23.30	1.05	0.00	0.124	0.13
	LTE 4	QPSK20M	Rear Face	20300	1	50	0	22.5	22.30	1.05	0.02	0.112	0.12
	LTE 12	QPSK10M	Front Face	23130	0	1	49	22.5	22.25	1.06	0.00	0.051	0.05
	LTE 12	QPSK10M	Front Face	23130	0	25	25	21.5	21.25	1.06	0.02	0.055	0.06
	LTE 12	QPSK10M	Front Face	23130	1	1	49	22.5	22.25	1.06	-0.04	0.022	0.02
	LTE 12	QPSK10M	Front Face	23130	1	25	25	21.5	21.25	1.06	0.10	0.019	0.02
	LTE 12	QPSK10M	Rear Face	23130	0	1	49	22.5	22.25	1.06	0.10	0.102	0.11
20	LTE 12	QPSK10M	Rear Face	23130	0	25	25	21.5	21.25	1.06	0.07	0.104	0.11
	LTE 12	QPSK10M	Rear Face	23130	1	1	49	22.5	22.25	1.06	0.06	0.038	0.04
	LTE 12	QPSK10M	Rear Face	23130	1	25	25	21.5	21.25	1.06	0.15	0.034	0.04
	LTE 25	QPSK20M	Front Face	26590	0	1	0	24.5	24.40	1.02	0.17	0.127	0.13
	LTE 25	QPSK20M	Front Face	26590	0	50	0	23.5	23.40	1.02	0.09	0.084	0.09
	LTE 25	QPSK20M	Front Face	26590	1	1	0	24.5	24.40	1.02	0.12	0.115	0.12
	LTE 25	QPSK20M	Front Face	26590	1	50	0	23.5	23.40	1.02	0.07	0.084	0.09
21	LTE 25	QPSK20M	Rear Face	26590	0	1	0	24.5	24.40	1.02	0.16	0.167	0.17
	LTE 25	QPSK20M	Rear Face	26590	0	50	0	23.5	23.40	1.02	0.06	0.1	0.10
	LTE 25	QPSK20M	Rear Face	26590	1	1	0	24.5	24.40	1.02	0.05	0.162	0.17
	LTE 25	QPSK20M	Rear Face	26590	1	50	0	23.5	23.40	1.02	0.13	0.124	0.13
	LTE 26	QPSK15M	Front Face	26965	0	1	0	22.5	22.30	1.05	0.03	0.142	0.15
	LTE 26	QPSK15M	Front Face	26965	0	36	0	21.5	21.30	1.05	0.03	0.128	0.13
	LTE 26	QPSK15M	Front Face	26965	1	1	0	22.5	22.30	1.05	0.07	0.082	0.09
	LTE 26	QPSK15M	Front Face	26965	1	36	0	21.5	21.30	1.05	0.10	0.019	0.02
22	LTE 26	QPSK15M	Rear Face	26965	0	1	0	22.5	22.30	1.05	-0.04	0.201	0.21
	LTE 26	QPSK15M	Rear Face	26965	0	36	0	21.5	21.30	1.05	-0.01	0.185	0.19
	LTE 26	QPSK15M	Rear Face	26965	1	1	0	22.5	22.30	1.05	0.05	0.108	0.11
	LTE 26	QPSK15M	Rear Face	26965	1	36	0	21.5	21.30	1.05	0.12	0.066	0.07
	LTE 41	QPSK20M	Front Face	40185	0	1	0	24.5	24.15	1.08	0.10	0.104	0.11
	LTE 41	QPSK20M	Front Face	40185	0	50	0	23.5	23.15	1.08	-0.02	0.094	0.10
	LTE 41	QPSK20M	Front Face	40185	1	1	0	24.5	24.15	1.08	0.18	0.053	0.06
	LTE 41	QPSK20M	Front Face	40185	1	50	0	23.5	23.15	1.08	0.18	0.037	0.04
23	LTE 41	QPSK20M	Rear Face	40185	0	1	0	24.5	24.15	1.08	0.04	0.121	0.13
	LTE 41	QPSK20M	Rear Face	40185	0	50	0	23.5	23.15	1.08	0.11	0.101	0.11
	LTE 41	QPSK20M	Rear Face	40185	1	1	0	24.5	24.15	1.08	0.03	0.078	0.08
	LTE 41	QPSK20M	Rear Face	40185	1	50	0	23.5	23.15	1.08	-0.05	0.061	0.07

### Note:

1. According to KDB 941225, LTE SAR testing for remaining RB offset configurations and required test channels is not required when the reported SAR of highest power 1RB configuration is less than 0.8 W/kg.
2. According to KDB 941225, LTE SAR testing for remaining RB offset configurations and required test channels is not required when the reported SAR of highest power 50% RB configuration is less than 0.8 W/kg.
3. According to KDB 941225, LTE SAR testing for 100% RB is not required when the maximum power of 100% RB is less than the maximum power of 1RB and 50% RB, and the highest reported SAR for 1RB and 50% RB is less than 0.8 W/kg.
4. According to KDB 941225, LTE SAR testing for 16QAM is not required when the maximum power of 16QAM is



# FCC SAR Test Report

A D T

less 1/2 dB higher than QPSK, and the highest reported SAR of QPSK is less than 1.45 W/kg.

- According to KDB 941225, LTE SAR testing for smaller channel bandwidth is not required when the maximum power of smaller channel bandwidth is less 1/2 dB higher than largest channel bandwidth, and the highest reported SAR of largest channel bandwidth is less than 1.45 W/kg.

Plot No.	Band	Mode	Test Position	Ch.	Max. Tune-up Power (dBm)	Measured Conducted Power (dBm)	Scaling Factor	Power Drift (dB)	Measured SAR-1g (W/kg)	Scaled SAR-1g (W/kg)
24	802.11b	-	Front Face	6	18.5	18.01	1.12	0.08	0.03	<b>0.03</b>
	802.11b	-	Rear Face	6	18.5	18.01	1.12	0.07	0.01	0.01
25	802.11a	-	Front Face	48	16.0	15.72	1.07	-0.07	0.059	<b>0.06</b>
	802.11ac	VH80	Front Face	42	11.0	10.81	1.04	0.00	0.000	0.00
	802.11a	-	Rear Face	48	16.0	15.72	1.07	0.08	0.022	0.02
26	802.11a	-	Front Face	60	16.5	16.01	1.12	-0.04	0.067	<b>0.08</b>
	802.11ac	VH80	Front Face	58	11.0	10.73	1.06	-0.10	0.00362	0.00
	802.11a	-	Rear Face	60	16.5	16.01	1.12	0.14	0.023	0.03
27	802.11a	-	Front Face	116	16.5	16.28	1.05	-0.06	0.042	<b>0.04</b>
	802.11ac	VH80	Front Face	106	11.0	10.82	1.04	0.00	0.000114	0.00
	802.11a	-	Rear Face	116	16.5	16.28	1.05	0.00	0.014	0.01
28	802.11a	-	Front Face	157	16.0	15.82	1.04	0.00	0.037	<b>0.04</b>
	802.11ac	VH80	Front Face	155	11.5	11.14	1.09	0.00	0.0000258	0.00
	802.11a	-	Rear Face	157	16.0	15.82	1.04	0.00	0.00991	0.01

## Note:

- According to KDB 248227, when the extrapolated maximum peak SAR for the maximum output power channel is  $\leq 1.6$  W/kg and the 1g averaged SAR is  $\leq 0.8$  W/kg, WLAN SAR testing for other channels is not required.
- SAR testing for 802.11g/n is not required when its maximum power is less than 1/4 dB higher than 802.11b.
- SAR testing for 802.11n is not required when its maximum power is less than 1/4 dB higher than 802.11a.
- According to April 2013 TCB Workshop, 802.11ac SAR testing is not required when its maximum power is less than 1/4 dB higher than 802.11a. 802.11ac SAR is required for the highest 802.11a configuration in each 5 GHz band and each exposure condition.

### 4.7.3 SAR Results for Hotspot (Separation Distance is 1.0 cm Gap)

Plot No.	Band	Mode	Test Position	Ch.	Tx Antenna	Max. Tune-up Power (dBm)	Measured Conducted Power (dBm)	Scaling Factor	Power Drift (dB)	Measured SAR-1g (W/kg)	Scaled SAR-1g (W/kg)
15	CDMA BC0	RTAP 153.6	Front Face	777	0	25.0	23.98	1.26	0.07	0.168	0.21
	CDMA BC0	RTAP 153.6	Front Face	777	1	25.0	23.98	1.26	0.07	0.082	0.10
	CDMA BC0	RTAP 153.6	Rear Face	777	0	25.0	23.98	1.26	0.03	0.279	<b>0.35</b>
	CDMA BC0	RTAP 153.6	Rear Face	777	1	25.0	23.98	1.26	-0.13	0.074	0.09
	CDMA BC0	RTAP 153.6	Left Side	777	0	25.0	23.98	1.26	0.10	0.18	0.23
	CDMA BC0	RTAP 153.6	Left Side	777	1	25.0	23.98	1.26	-0.16	0.086	0.11
	CDMA BC0	RTAP 153.6	Right Side	777	0	25.0	23.98	1.26	-0.16	0.068	0.09
	CDMA BC0	RTAP 153.6	Right Side	777	1	25.0	23.98	1.26	-0.11	0.07	0.09
	CDMA BC0	RTAP 153.6	Bottom Side	777	0	25.0	23.98	1.26	0.10	0.087	0.11
	CDMA BC0	RTAP 153.6	Top Side	777	1	25.0	23.98	1.26	0.12	0.014	0.02
	CDMA BC1	RTAP 153.6	Front Face	600	0	24.5	24.48	1.00	0.18	0.115	0.12
	CDMA BC1	RTAP 153.6	Front Face	600	1	24.5	24.48	1.00	-0.01	0.069	0.07
	CDMA BC1	RTAP 153.6	Rear Face	600	0	24.5	24.48	1.00	0.10	0.132	0.13
	CDMA BC1	RTAP 153.6	Rear Face	600	1	24.5	24.48	1.00	-0.02	0.096	0.10
29	CDMA BC1	RTAP 153.6	Left Side	600	0	24.5	24.48	1.00	0.06	0.108	0.11
	CDMA BC1	RTAP 153.6	Left Side	600	1	24.5	24.48	1.00	0.00	0.06	0.06
	CDMA BC1	RTAP 153.6	Right Side	600	0	24.5	24.48	1.00	0.10	0.027	0.03
	CDMA BC1	RTAP 153.6	Right Side	600	1	24.5	24.48	1.00	0.16	0.00592	0.01
	CDMA BC1	RTAP 153.6	Bottom Side	600	0	24.5	24.48	1.00	0.13	0.222	<b>0.22</b>
	CDMA BC1	RTAP 153.6	Top Side	600	1	24.5	24.48	1.00	-0.17	0.081	0.08



# FCC SAR Test Report

Plot No.	Band	Mode	Test Position	Ch.	Tx Antenna	Max. Tune-up Power (dBm)	Measured Conducted Power (dBm)	Scaling Factor	Power Drift (dB)	Measured SAR-1g (W/kg)	Scaled SAR-1g (W/kg)
	CDMA BC10	RTAP 153.6	Front Face	476	0	24.5	23.70	1.20	0.01	0.144	0.17
	CDMA BC10	RTAP 153.6	Front Face	476	1	24.5	23.70	1.20	0.04	0.084	0.10
17	CDMA BC10	RTAP 153.6	Rear Face	476	0	24.5	23.70	1.20	0.00	0.222	0.27
	CDMA BC10	RTAP 153.6	Rear Face	476	1	24.5	23.70	1.20	0.01	0.122	0.15
	CDMA BC10	RTAP 153.6	Left Side	476	0	24.5	23.70	1.20	-0.01	0.171	0.21
	CDMA BC10	RTAP 153.6	Left Side	476	1	24.5	23.70	1.20	0.15	0.092	0.11
	CDMA BC10	RTAP 153.6	Right Side	476	0	24.5	23.70	1.20	0.03	0.15	0.18
	CDMA BC10	RTAP 153.6	Right Side	476	1	24.5	23.70	1.20	0.11	0.087	0.10
	CDMA BC10	RTAP 153.6	Bottom Side	476	0	24.5	23.70	1.20	0.07	0.064	0.08
	CDMA BC10	RTAP 153.6	Top Side	476	1	24.5	23.70	1.20	0.15	0.016	0.02

### Note:

- SAR is performed on the highest power channel. When the reported SAR value of highest power channel is <= 0.8 W/kg, SAR testing for optional channel is not required.

Plot No.	Band	Mode	Test Position	Ch.	Tx Antenna	RB#	RB Offset	Max. Tune-up Power (dBm)	Measured Conducted Power (dBm)	Scaling Factor	Power Drift (dB)	Measured SAR-1g (W/kg)	Scaled SAR-1g (W/kg)
	LTE 2	QPSK20M	Front Face	19100	0	1	0	24.5	24.37	1.03	0.05	0.101	0.10
	LTE 2	QPSK20M	Front Face	19100	0	50	0	23.5	23.37	1.03	0.09	0.069	0.07
	LTE 2	QPSK20M	Front Face	19100	1	1	0	24.5	24.37	1.03	0.13	0.066	0.07
	LTE 2	QPSK20M	Front Face	19100	1	50	0	23.5	23.37	1.03	0.01	0.043	0.04
	LTE 2	QPSK20M	Rear Face	19100	0	1	0	24.5	24.37	1.03	0.06	0.103	0.11
	LTE 2	QPSK20M	Rear Face	19100	0	50	0	23.5	23.37	1.03	0.00	0.082	0.08
	LTE 2	QPSK20M	Rear Face	19100	1	1	0	24.5	24.37	1.03	-0.03	0.097	0.10
	LTE 2	QPSK20M	Rear Face	19100	1	50	0	23.5	23.37	1.03	-0.05	0.066	0.07
	LTE 2	QPSK20M	Left Side	19100	0	1	0	24.5	24.37	1.03	0.13	0.092	0.09
	LTE 2	QPSK20M	Left Side	19100	0	50	0	23.5	23.37	1.03	0.01	0.056	0.06
	LTE 2	QPSK20M	Left Side	19100	1	1	0	24.5	24.37	1.03	0.12	0.063	0.06
	LTE 2	QPSK20M	Left Side	19100	1	50	0	23.5	23.37	1.03	0.08	0.043	0.04
	LTE 2	QPSK20M	Right Side	19100	0	1	0	24.5	24.37	1.03	0.01	0.109	0.11
	LTE 2	QPSK20M	Right Side	19100	0	50	0	23.5	23.37	1.03	0.11	0.071	0.07
	LTE 2	QPSK20M	Right Side	19100	1	1	0	24.5	24.37	1.03	0.02	0.00803	0.01
	LTE 2	QPSK20M	Right Side	19100	1	50	0	23.5	23.37	1.03	0.07	0.00505	0.01
30	LTE 2	QPSK20M	Bottom Side	19100	0	1	0	24.5	24.37	1.03	-0.11	0.172	0.18
	LTE 2	QPSK20M	Bottom Side	19100	0	50	0	23.5	23.37	1.03	0.02	0.111	0.11
	LTE 2	QPSK20M	Top Side	19100	1	1	0	24.5	24.37	1.03	0.05	0.073	0.08
	LTE 2	QPSK20M	Top Side	19100	1	50	0	23.5	23.37	1.03	0.00	0.049	0.05
	LTE 4	QPSK20M	Front Face	20300	0	1	0	23.5	23.30	1.05	0.03	0.057	0.06
	LTE 4	QPSK20M	Front Face	20300	0	50	0	22.5	22.30	1.05	0.15	0.049	0.05
	LTE 4	QPSK20M	Front Face	20300	1	1	0	23.5	23.30	1.05	0.18	0.113	0.12
	LTE 4	QPSK20M	Front Face	20300	1	50	0	22.5	22.30	1.05	0.10	0.108	0.11
	LTE 4	QPSK20M	Rear Face	20300	0	1	0	23.5	23.30	1.05	0.10	0.086	0.09
	LTE 4	QPSK20M	Rear Face	20300	0	50	0	22.5	22.30	1.05	0.09	0.062	0.06
19	LTE 4	QPSK20M	Rear Face	20300	1	1	0	23.5	23.30	1.05	0.00	0.124	0.13
	LTE 4	QPSK20M	Rear Face	20300	1	50	0	22.5	22.30	1.05	0.02	0.112	0.12
	LTE 4	QPSK20M	Left Side	20300	0	1	0	23.5	23.30	1.05	0.11	0.043	0.05
	LTE 4	QPSK20M	Left Side	20300	0	50	0	22.5	22.30	1.05	0.17	0.04	0.04
	LTE 4	QPSK20M	Left Side	20300	1	1	0	23.5	23.30	1.05	0.04	0.067	0.07
	LTE 4	QPSK20M	Left Side	20300	1	50	0	22.5	22.30	1.05	0.03	0.064	0.07
	LTE 4	QPSK20M	Right Side	20300	0	1	0	23.5	23.30	1.05	0.18	0.039	0.04
	LTE 4	QPSK20M	Right Side	20300	0	50	0	22.5	22.30	1.05	0.18	0.037	0.04
	LTE 4	QPSK20M	Right Side	20300	1	1	0	23.5	23.30	1.05	0.15	0.00223	0.00
	LTE 4	QPSK20M	Right Side	20300	1	50	0	22.5	22.30	1.05	0.18	0.00233	0.00
	LTE 4	QPSK20M	Bottom Side	20300	0	1	0	23.5	23.30	1.05	0.12	0.092	0.10
	LTE 4	QPSK20M	Bottom Side	20300	0	50	0	22.5	22.30	1.05	0.13	0.09	0.09
	LTE 4	QPSK20M	Top Side	20300	1	1	0	23.5	23.30	1.05	0.09	0.123	0.13
	LTE 4	QPSK20M	Top Side	20300	1	50	0	22.5	22.30	1.05	0.05	0.12	0.13



A D T

# FCC SAR Test Report

Plot No.	Band	Mode	Test Position	Ch.	Tx Antenna	RB#	RB Offset	Max. Tune-up Power (dBm)	Measured Conducted Power (dBm)	Scaling Factor	Power Drift (dB)	Measured SAR-1g (W/kg)	Scaled SAR-1g (W/kg)
	LTE 12	QPSK10M	Front Face	23130	0	1	49	22.5	22.25	1.06	0.00	0.051	0.05
	LTE 12	QPSK10M	Front Face	23130	0	25	25	21.5	21.25	1.06	0.02	0.055	0.06
	LTE 12	QPSK10M	Front Face	23130	1	1	49	22.5	22.25	1.06	-0.04	0.022	0.02
	LTE 12	QPSK10M	Front Face	23130	1	25	25	21.5	21.25	1.06	0.10	0.019	0.02
	LTE 12	QPSK10M	Rear Face	23130	0	1	49	22.5	22.25	1.06	0.10	0.102	0.11
20	LTE 12	QPSK10M	Rear Face	23130	0	25	25	21.5	21.25	1.06	0.07	0.104	0.11
	LTE 12	QPSK10M	Rear Face	23130	1	1	49	22.5	22.25	1.06	0.06	0.038	0.04
	LTE 12	QPSK10M	Rear Face	23130	1	25	25	21.5	21.25	1.06	0.15	0.034	0.04
	LTE 12	QPSK10M	Left Side	23130	0	1	49	22.5	22.25	1.06	0.01	0.061	0.06
	LTE 12	QPSK10M	Left Side	23130	0	25	25	21.5	21.25	1.06	-0.01	0.064	0.07
	LTE 12	QPSK10M	Left Side	23130	1	1	49	22.5	22.25	1.06	0.06	0.039	0.04
	LTE 12	QPSK10M	Left Side	23130	1	25	25	21.5	21.25	1.06	0.11	0.035	0.04
	LTE 12	QPSK10M	Right Side	23130	0	1	49	22.5	22.25	1.06	0.00	0.031	0.03
	LTE 12	QPSK10M	Right Side	23130	0	25	25	21.5	21.25	1.06	0.04	0.033	0.03
	LTE 12	QPSK10M	Right Side	23130	1	1	49	22.5	22.25	1.06	0.05	0.024	0.03
	LTE 12	QPSK10M	Right Side	23130	1	25	25	21.5	21.25	1.06	0.12	0.021	0.02
	LTE 12	QPSK10M	Bottom Side	23130	0	1	49	22.5	22.25	1.06	0.07	0.026	0.03
	LTE 12	QPSK10M	Bottom Side	23130	0	25	25	21.5	21.25	1.06	0.06	0.028	0.03
	LTE 12	QPSK10M	Top Side	23130	1	1	49	22.5	22.25	1.06	0.01	0.00878	0.01
	LTE 12	QPSK10M	Top Side	23130	1	25	25	21.5	21.25	1.06	0.16	0.00787	0.01
	LTE 25	QPSK20M	Front Face	26590	0	1	0	24.5	24.40	1.02	0.17	0.127	0.13
	LTE 25	QPSK20M	Front Face	26590	0	50	0	23.5	23.40	1.02	0.09	0.084	0.09
	LTE 25	QPSK20M	Front Face	26590	1	1	0	24.5	24.40	1.02	0.12	0.115	0.12
	LTE 25	QPSK20M	Front Face	26590	1	50	0	23.5	23.40	1.02	0.07	0.084	0.09
	LTE 25	QPSK20M	Rear Face	26590	0	1	0	24.5	24.40	1.02	0.16	0.167	0.17
	LTE 25	QPSK20M	Rear Face	26590	0	50	0	23.5	23.40	1.02	0.06	0.1	0.10
	LTE 25	QPSK20M	Rear Face	26590	1	1	0	24.5	24.40	1.02	0.05	0.162	0.17
	LTE 25	QPSK20M	Rear Face	26590	1	50	0	23.5	23.40	1.02	0.13	0.124	0.13
	LTE 25	QPSK20M	Left Side	26590	0	1	0	24.5	24.40	1.02	0.11	0.122	0.12
	LTE 25	QPSK20M	Left Side	26590	0	50	0	23.5	23.40	1.02	0.12	0.08	0.08
	LTE 25	QPSK20M	Left Side	26590	1	1	0	24.5	24.40	1.02	0.09	0.119	0.12
	LTE 25	QPSK20M	Left Side	26590	1	50	0	23.5	23.40	1.02	0.12	0.082	0.08
	LTE 25	QPSK20M	Right Side	26590	0	1	0	24.5	24.40	1.02	0.16	0.017	0.02
	LTE 25	QPSK20M	Right Side	26590	0	50	0	23.5	23.40	1.02	-0.05	0.024	0.02
	LTE 25	QPSK20M	Right Side	26590	1	1	0	24.5	24.40	1.02	0.05	0.016	0.02
	LTE 25	QPSK20M	Right Side	26590	1	50	0	23.5	23.40	1.02	0.17	0.0097	0.01
31	LTE 25	QPSK20M	Bottom Side	26590	0	1	0	24.5	24.40	1.02	0.07	0.184	0.19
	LTE 25	QPSK20M	Bottom Side	26590	0	50	0	23.5	23.40	1.02	0.09	0.17	0.17
	LTE 25	QPSK20M	Top Side	26590	1	1	0	24.5	24.40	1.02	0.06	0.149	0.15
	LTE 25	QPSK20M	Top Side	26590	1	50	0	23.5	23.40	1.02	0.03	0.117	0.12
	LTE 26	QPSK15M	Front Face	26965	0	1	0	22.5	22.30	1.05	0.03	0.142	0.15
	LTE 26	QPSK15M	Front Face	26965	0	36	0	21.5	21.30	1.05	0.03	0.128	0.13
	LTE 26	QPSK15M	Front Face	26965	1	1	0	22.5	22.30	1.05	0.07	0.082	0.09
	LTE 26	QPSK15M	Front Face	26965	1	36	0	21.5	21.30	1.05	0.10	0.019	0.02
22	LTE 26	QPSK15M	Rear Face	26965	0	1	0	22.5	22.30	1.05	-0.04	0.201	0.21
	LTE 26	QPSK15M	Rear Face	26965	0	36	0	21.5	21.30	1.05	-0.01	0.185	0.19
	LTE 26	QPSK15M	Rear Face	26965	1	1	0	22.5	22.30	1.05	0.05	0.108	0.11
	LTE 26	QPSK15M	Rear Face	26965	1	36	0	21.5	21.30	1.05	0.12	0.066	0.07
	LTE 26	QPSK15M	Left Side	26965	0	1	0	22.5	22.30	1.05	0.00	0.152	0.16
	LTE 26	QPSK15M	Left Side	26965	0	36	0	21.5	21.30	1.05	-0.01	0.136	0.14
	LTE 26	QPSK15M	Left Side	26965	1	1	0	22.5	22.30	1.05	0.03	0.081	0.08
	LTE 26	QPSK15M	Left Side	26965	1	36	0	21.5	21.30	1.05	0.02	0.064	0.07
	LTE 26	QPSK15M	Right Side	26965	0	1	0	22.5	22.30	1.05	0.06	0.06	0.06
	LTE 26	QPSK15M	Right Side	26965	0	36	0	21.5	21.30	1.05	0.00	0.057	0.06
	LTE 26	QPSK15M	Right Side	26965	1	1	0	22.5	22.30	1.05	0.04	0.058	0.06
	LTE 26	QPSK15M	Right Side	26965	1	36	0	21.5	21.30	1.05	0.03	0.057	0.06
	LTE 26	QPSK15M	Bottom Side	26965	0	1	0	22.5	22.30	1.05	0.07	0.074	0.08
	LTE 26	QPSK15M	Bottom Side	26965	0	36	0	21.5	21.30	1.05	0.03	0.063	0.07
	LTE 26	QPSK15M	Top Side	26965	1	1	0	22.5	22.30	1.05	0.16	0.018	0.02
	LTE 26	QPSK15M	Top Side	26965	1	36	0	21.5	21.30	1.05	0.09	0.012	0.01



# FCC SAR Test Report

A D T

Plot No.	Band	Mode	Test Position	Ch.	Tx Antenna	RB#	RB Offset	Max. Tune-up Power (dBm)	Measured Conducted Power (dBm)	Scaling Factor	Power Drift (dB)	Measured SAR-1g (W/kg)	Scaled SAR-1g (W/kg)
	LTE 41	QPSK20M	Front Face	40185	0	1	0	24.5	24.15	1.08	0.10	0.104	0.11
	LTE 41	QPSK20M	Front Face	40185	0	50	0	23.5	23.15	1.08	-0.02	0.094	0.10
	LTE 41	QPSK20M	Front Face	40185	1	1	0	24.5	24.15	1.08	0.18	0.053	0.06
	LTE 41	QPSK20M	Front Face	40185	1	50	0	23.5	23.15	1.08	0.18	0.037	0.04
23	LTE 41	QPSK20M	Rear Face	40185	0	1	0	24.5	24.15	1.08	0.04	0.121	0.13
	LTE 41	QPSK20M	Rear Face	40185	0	50	0	23.5	23.15	1.08	0.11	0.101	0.11
	LTE 41	QPSK20M	Rear Face	40185	1	1	0	24.5	24.15	1.08	0.03	0.078	0.08
	LTE 41	QPSK20M	Rear Face	40185	1	50	0	23.5	23.15	1.08	-0.05	0.061	0.07
	LTE 41	QPSK20M	Left Side	40185	0	1	0	24.5	24.15	1.08	0.13	0.158	0.17
	LTE 41	QPSK20M	Left Side	40185	0	50	0	23.5	23.15	1.08	0.01	0.118	0.13
	LTE 41	QPSK20M	Left Side	40185	1	1	0	24.5	24.15	1.08	-0.05	0.092	0.10
	LTE 41	QPSK20M	Left Side	40185	1	50	0	23.5	23.15	1.08	0.16	0.073	0.08
	LTE 41	QPSK20M	Right Side	40185	0	1	0	24.5	24.15	1.08	0.06	0.014	0.02
	LTE 41	QPSK20M	Right Side	40185	0	50	0	23.5	23.15	1.08	0.04	0.01	0.01
	LTE 41	QPSK20M	Right Side	40185	1	1	0	24.5	24.15	1.08	0.07	0.00592	0.01
	LTE 41	QPSK20M	Right Side	40185	1	50	0	23.5	23.15	1.08	0.09	0.00383	0.00
	LTE 41	QPSK20M	Bottom Side	40185	0	1	0	24.5	24.15	1.08	0.03	0.073	0.08
	LTE 41	QPSK20M	Bottom Side	40185	0	50	0	23.5	23.15	1.08	0.01	0.053	0.06
	LTE 41	QPSK20M	Top Side	40185	1	1	0	24.5	24.15	1.08	0.02	0.038	0.04
	LTE 41	QPSK20M	Top Side	40185	1	50	0	23.5	23.15	1.08	0.03	0.028	0.03

### Note:

1. According to KDB 941225, LTE SAR testing for remaining RB offset configurations and required test channels is not required when the reported SAR of highest power 1RB configuration is less than 0.8 W/kg.
2. According to KDB 941225, LTE SAR testing for remaining RB offset configurations and required test channels is not required when the reported SAR of highest power 50% RB configuration is less than 0.8 W/kg.
3. According to KDB 941225, LTE SAR testing for 100% RB is not required when the maximum power of 100% RB is less than the maximum power of 1RB and 50% RB, and the highest reported SAR for 1RB and 50% RB is less than 0.8 W/kg.
4. According to KDB 941225, LTE SAR testing for 16QAM is not required when the maximum power of 16QAM is less 1/2 dB higher than QPSK, and the highest reported SAR of QPSK is less than 1.45 W/kg.
5. According to KDB 941225, LTE SAR testing for smaller channel bandwidth is not required when the maximum power of smaller channel bandwidth is less 1/2 dB higher than largest channel bandwidth, and the highest reported SAR of largest channel bandwidth is less than 1.45 W/kg.

Plot No.	Band	Test Position	Ch.	Max. Tune-up Power (dBm)	Measured Conducted Power (dBm)	Scaling Factor	Power Drift (dB)	Measured SAR-1g (W/kg)	Scaled SAR-1g (W/kg)
24	802.11b	Front Face	6	18.5	18.01	1.12	0.08	0.03	0.03
	802.11b	Rear Face	6	18.5	18.01	1.12	0.07	0.01	0.01
	802.11b	Right Side	6	18.5	18.01	1.12	0.00	0.016	0.02
	802.11b	Top Side	6	18.5	18.01	1.12	0.07	0.00305	0.00

### Note:

1. According to KDB 248227, when the extrapolated maximum peak SAR for the maximum output power channel is  $\leq 1.6$  W/kg and the 1g averaged SAR is  $\leq 0.8$  W/kg, WLAN SAR testing for other channels is not required.
2. SAR testing for 802.11g/n is not required when its maximum power is less than 1/4 dB higher than 802.11b.
3. WLAN 5G does not support wireless hotspot mode



#### 4.7.4 SAR Measurement Variability

According to KDB 865664 D01, SAR measurement variability was assessed for each frequency band, which is determined by the SAR probe calibration point and tissue-equivalent medium used for the device measurements. When both head and body tissue-equivalent media are required for SAR measurements in a frequency band, the variability measurement procedures should be applied to the tissue medium with the highest measured SAR, using the highest measured SAR configuration for that tissue-equivalent medium. Alternatively, if the highest measured SAR for both head and body tissue-equivalent media are  $\leq 1.45$  W/kg and the ratio of these highest SAR values, i.e., largest divided by smallest value, is  $\leq 1.10$ , the highest SAR configuration for either head or body tissue-equivalent medium may be used to perform the repeated measurement. These additional measurements are repeated after the completion of all measurements requiring the same head or body tissue-equivalent medium in a frequency band. The test device should be returned to ambient conditions (normal room temperature) with the battery fully charged before it is re-mounted on the device holder for the repeated measurement(s) to minimize any unexpected variations in the repeated results.

Since all the measured SAR are less than 0.8 W/kg, the repeated measurement is not required.

#### 4.7.5 Simultaneous Multi-band Transmission Evaluation

##### <Estimated SAR Calculation>

According to KDB 447498 D01, when standalone SAR test exclusion applies to an antenna that transmits simultaneously with other antennas, the standalone SAR was estimated according to following formula to result in substantially conservative SAR values of  $\leq 0.4$  W/kg to determine simultaneous transmission SAR test exclusion.

$$\text{Estimated SAR} = \frac{\text{Max. Tune up Power}_{(mW)}}{\text{Min. Test Separation Distance}_{(mm)}} \times \frac{\sqrt{f_{(GHz)}}}{7.5}$$

If the minimum test separation distance is  $< 5$  mm, a distance of 5 mm is used for estimated SAR calculation. When the test separation distance is  $> 50$  mm, the 0.4 W/kg is used for SAR-1g.

Mode / Band	Frequency (GHz)	Max. Tune-up Power (dBm)	Test Position	Separation Distance (mm)	Estimated SAR (W/kg)
BT (DSS)	2.48	9.6	Body-worn	10	0.19

##### Note:

1. The separation distance is determined from the outer housing of the EUT to the user.
2. When standalone SAR testing is not required, an estimated SAR can be applied to determine simultaneous transmission SAR test exclusion.



## FCC SAR Test Report

### <SAR Summation Analysis>

Simultaneous transmission SAR test exclusion is determined for each operating configuration and exposure condition according to the reported standalone SAR of each applicable simultaneous transmitting antenna. When the sum of SAR<sub>1g</sub> of all simultaneously transmitting antennas in an operating mode and exposure condition combination is within the SAR limit (SAR<sub>1g</sub> 1.6 W/kg), the simultaneous transmission SAR is not required. When the sum of SAR<sub>1g</sub> is greater than the SAR limit (SAR<sub>1g</sub> 1.6 W/kg), SAR test exclusion is determined by the SPLSR.

No.	Conditions (SAR1 + SAR2)	Exposure Condition	Test Position	Max. SAR1	Max. SAR2	SAR Summation	SPLSR Analysis
1	CDMA BC0 + WLAN (DTS)	Head	Right Cheek	0.56	0.08	0.64	Σ SAR < 1.6, Not required
			Right Tilted	0.27	0.05	0.32	Σ SAR < 1.6, Not required
			Left Cheek	0.31	0.24	0.55	Σ SAR < 1.6, Not required
			Left Tilted	0.17	0.19	0.36	Σ SAR < 1.6, Not required
		Body-Worn	Front Face	0.21	0.03	0.24	Σ SAR < 1.6, Not required
			Rear Face	0.35	0.01	0.36	Σ SAR < 1.6, Not required
		Hotspot	Front Face	0.21	0.03	0.24	Σ SAR < 1.6, Not required
			Rear Face	0.35	0.01	0.36	Σ SAR < 1.6, Not required
			Left Side	0.23	0.00	0.23	Σ SAR < 1.6, Not required
			Right Side	0.09	0.02	0.11	Σ SAR < 1.6, Not required
			Top Side	0.02	0.00	0.02	Σ SAR < 1.6, Not required
		Bottom Side	0.11	0.00	0.11	Σ SAR < 1.6, Not required	
2	CDMA BC0 + WLAN (NII)	Head	Right Cheek	0.56	0.15	0.71	Σ SAR < 1.6, Not required
			Right Tilted	0.27	0.17	0.44	Σ SAR < 1.6, Not required
			Left Cheek	0.31	0.58	0.89	Σ SAR < 1.6, Not required
			Left Tilted	0.17	0.26	0.43	Σ SAR < 1.6, Not required
		Body-Worn	Front Face	0.21	0.08	0.29	Σ SAR < 1.6, Not required
			Rear Face	0.35	0.03	0.38	Σ SAR < 1.6, Not required
3	CDMA BC0 + BT (DSS)	Body-Worn	Front Face	0.21	0.19	0.40	Σ SAR < 1.6, Not required
			Rear Face	0.35	0.19	0.54	Σ SAR < 1.6, Not required



# FCC SAR Test Report

A D T

No.	Conditions (SAR1 + SAR2)	Exposure Condition	Test Position	Max. SAR1	Max. SAR2	SAR Summation	SPLSR Analysis
4	CDMA BC1 + WLAN (DTS)	Head	Right Cheek	0.37	0.08	0.45	$\Sigma$ SAR < 1.6, Not required
			Right Tilted	0.28	0.05	0.33	$\Sigma$ SAR < 1.6, Not required
			Left Cheek	0.19	0.24	0.43	$\Sigma$ SAR < 1.6, Not required
			Left Tilted	0.16	0.19	0.35	$\Sigma$ SAR < 1.6, Not required
		Body-Worn	Front Face	0.12	0.03	0.15	$\Sigma$ SAR < 1.6, Not required
			Rear Face	0.13	0.01	0.14	$\Sigma$ SAR < 1.6, Not required
		Hotspot	Front Face	0.12	0.03	0.15	$\Sigma$ SAR < 1.6, Not required
			Rear Face	0.13	0.01	0.14	$\Sigma$ SAR < 1.6, Not required
			Left Side	0.11	0.00	0.11	$\Sigma$ SAR < 1.6, Not required
			Right Side	0.03	0.02	0.05	$\Sigma$ SAR < 1.6, Not required
			Top Side	0.08	0.00	0.08	$\Sigma$ SAR < 1.6, Not required
			Bottom Side	0.22	0.00	0.22	$\Sigma$ SAR < 1.6, Not required
5	CDMA BC1 + WLAN (NII)	Head	Right Cheek	0.37	0.15	0.52	$\Sigma$ SAR < 1.6, Not required
			Right Tilted	0.28	0.17	0.45	$\Sigma$ SAR < 1.6, Not required
			Left Cheek	0.19	0.58	0.77	$\Sigma$ SAR < 1.6, Not required
			Left Tilted	0.16	0.26	0.42	$\Sigma$ SAR < 1.6, Not required
		Body-Worn	Front Face	0.12	0.08	0.20	$\Sigma$ SAR < 1.6, Not required
			Rear Face	0.13	0.03	0.16	$\Sigma$ SAR < 1.6, Not required
6	CDMA BC1 + BT (DSS)	Body-Worn	Front Face	0.12	0.19	0.31	$\Sigma$ SAR < 1.6, Not required
			Rear Face	0.13	0.19	0.32	$\Sigma$ SAR < 1.6, Not required





# FCC SAR Test Report

No.	Conditions (SAR1 + SAR2)	Exposure Condition	Test Position	Max. SAR1	Max. SAR2	SAR Summation	SPLSR Analysis
7	CDMA BC10 + WLAN (DTS)	Head	Right Cheek	0.54	0.08	0.62	$\Sigma$ SAR < 1.6, Not required
			Right Tilted	0.27	0.05	0.32	$\Sigma$ SAR < 1.6, Not required
			Left Cheek	0.29	0.24	0.53	$\Sigma$ SAR < 1.6, Not required
			Left Tilted	0.15	0.19	0.34	$\Sigma$ SAR < 1.6, Not required
		Body-Worn	Front Face	0.17	0.03	0.20	$\Sigma$ SAR < 1.6, Not required
			Rear Face	0.27	0.01	0.28	$\Sigma$ SAR < 1.6, Not required
		Hotspot	Front Face	0.17	0.03	0.20	$\Sigma$ SAR < 1.6, Not required
			Rear Face	0.27	0.01	0.28	$\Sigma$ SAR < 1.6, Not required
			Left Side	0.21	0.00	0.21	$\Sigma$ SAR < 1.6, Not required
			Right Side	0.18	0.02	0.20	$\Sigma$ SAR < 1.6, Not required
			Top Side	0.02	0.00	0.02	$\Sigma$ SAR < 1.6, Not required
			Bottom Side	0.08	0.00	0.08	$\Sigma$ SAR < 1.6, Not required
8	CDMA BC10 + WLAN (NII)	Head	Right Cheek	0.54	0.15	0.69	$\Sigma$ SAR < 1.6, Not required
			Right Tilted	0.27	0.17	0.44	$\Sigma$ SAR < 1.6, Not required
			Left Cheek	0.29	0.58	0.87	$\Sigma$ SAR < 1.6, Not required
			Left Tilted	0.15	0.26	0.41	$\Sigma$ SAR < 1.6, Not required
		Body-Worn	Front Face	0.17	0.08	0.25	$\Sigma$ SAR < 1.6, Not required
			Rear Face	0.27	0.03	0.30	$\Sigma$ SAR < 1.6, Not required
9	CDMA BC10 + BT (DSS)	Body-Worn	Front Face	0.17	0.19	0.36	$\Sigma$ SAR < 1.6, Not required
			Rear Face	0.27	0.19	0.46	$\Sigma$ SAR < 1.6, Not required



# FCC SAR Test Report

No.	Conditions (SAR1 + SAR2)	Exposure Condition	Test Position	Max. SAR1	Max. SAR2	SAR Summation	SPLSR Analysis
10	LTE 2 + WLAN (DTS)	Head	Right Cheek	0.27	0.08	0.35	$\Sigma$ SAR < 1.6, Not required
			Right Tilted	0.23	0.05	0.28	$\Sigma$ SAR < 1.6, Not required
			Left Cheek	0.17	0.24	0.41	$\Sigma$ SAR < 1.6, Not required
			Left Tilted	0.16	0.19	0.35	$\Sigma$ SAR < 1.6, Not required
		Body-Worn	Front Face	0.10	0.03	0.13	$\Sigma$ SAR < 1.6, Not required
			Rear Face	0.11	0.01	0.12	$\Sigma$ SAR < 1.6, Not required
		Hotspot	Front Face	0.10	0.03	0.13	$\Sigma$ SAR < 1.6, Not required
			Rear Face	0.11	0.01	0.12	$\Sigma$ SAR < 1.6, Not required
			Left Side	0.09	0.00	0.09	$\Sigma$ SAR < 1.6, Not required
			Right Side	0.11	0.02	0.13	$\Sigma$ SAR < 1.6, Not required
			Top Side	0.08	0.00	0.08	$\Sigma$ SAR < 1.6, Not required
			Bottom Side	0.18	0.00	0.18	$\Sigma$ SAR < 1.6, Not required
11	LTE 2 + WLAN (NII)	Head	Right Cheek	0.27	0.15	0.42	$\Sigma$ SAR < 1.6, Not required
			Right Tilted	0.23	0.17	0.40	$\Sigma$ SAR < 1.6, Not required
			Left Cheek	0.17	0.58	0.75	$\Sigma$ SAR < 1.6, Not required
			Left Tilted	0.16	0.26	0.42	$\Sigma$ SAR < 1.6, Not required
		Body-Worn	Front Face	0.10	0.08	0.18	$\Sigma$ SAR < 1.6, Not required
			Rear Face	0.11	0.03	0.14	$\Sigma$ SAR < 1.6, Not required
12	LTE 2 + BT (DSS)	Body-Worn	Front Face	0.10	0.19	0.29	$\Sigma$ SAR < 1.6, Not required
			Rear Face	0.11	0.19	0.30	$\Sigma$ SAR < 1.6, Not required



# FCC SAR Test Report

A D T

No.	Conditions (SAR1 + SAR2)	Exposure Condition	Test Position	Max. SAR1	Max. SAR2	SAR Summation	SPLSR Analysis
13	LTE 4 + WLAN (DTS)	Head	Right Cheek	0.38	0.08	0.46	$\Sigma$ SAR < 1.6, Not required
			Right Tilted	0.34	0.05	0.39	$\Sigma$ SAR < 1.6, Not required
			Left Cheek	0.25	0.24	0.49	$\Sigma$ SAR < 1.6, Not required
			Left Tilted	0.24	0.19	0.43	$\Sigma$ SAR < 1.6, Not required
		Body-Worn	Front Face	0.12	0.03	0.15	$\Sigma$ SAR < 1.6, Not required
			Rear Face	0.13	0.01	0.14	$\Sigma$ SAR < 1.6, Not required
		Hotspot	Front Face	0.12	0.03	0.15	$\Sigma$ SAR < 1.6, Not required
			Rear Face	0.13	0.01	0.14	$\Sigma$ SAR < 1.6, Not required
			Left Side	0.07	0.00	0.07	$\Sigma$ SAR < 1.6, Not required
			Right Side	0.04	0.02	0.06	$\Sigma$ SAR < 1.6, Not required
			Top Side	0.13	0.00	0.13	$\Sigma$ SAR < 1.6, Not required
				Bottom Side	0.10	0.00	0.10
14	LTE 4 + WLAN (NII)	Head	Right Cheek	0.38	0.15	0.53	$\Sigma$ SAR < 1.6, Not required
			Right Tilted	0.34	0.17	0.51	$\Sigma$ SAR < 1.6, Not required
			Left Cheek	0.25	0.58	0.83	$\Sigma$ SAR < 1.6, Not required
			Left Tilted	0.24	0.26	0.50	$\Sigma$ SAR < 1.6, Not required
		Body-Worn	Front Face	0.12	0.08	0.20	$\Sigma$ SAR < 1.6, Not required
			Rear Face	0.13	0.03	0.16	$\Sigma$ SAR < 1.6, Not required
15	LTE 4 + BT (DSS)	Body-Worn	Front Face	0.12	0.19	0.31	$\Sigma$ SAR < 1.6, Not required
			Rear Face	0.13	0.19	0.32	$\Sigma$ SAR < 1.6, Not required



# FCC SAR Test Report

A D T

No.	Conditions (SAR1 + SAR2)	Exposure Condition	Test Position	Max. SAR1	Max. SAR2	SAR Summation	SPLSR Analysis
16	LTE 12 + WLAN (DTS)	Head	Right Cheek	0.20	0.08	0.28	$\Sigma$ SAR < 1.6, Not required
			Right Tilted	0.07	0.05	0.12	$\Sigma$ SAR < 1.6, Not required
			Left Cheek	0.10	0.24	0.34	$\Sigma$ SAR < 1.6, Not required
			Left Tilted	0.06	0.19	0.25	$\Sigma$ SAR < 1.6, Not required
		Body-Worn	Front Face	0.06	0.03	0.09	$\Sigma$ SAR < 1.6, Not required
			Rear Face	0.11	0.01	0.12	$\Sigma$ SAR < 1.6, Not required
		Hotspot	Front Face	0.06	0.03	0.09	$\Sigma$ SAR < 1.6, Not required
			Rear Face	0.11	0.01	0.12	$\Sigma$ SAR < 1.6, Not required
			Left Side	0.07	0.00	0.07	$\Sigma$ SAR < 1.6, Not required
			Right Side	0.03	0.02	0.05	$\Sigma$ SAR < 1.6, Not required
			Top Side	0.01	0.00	0.01	$\Sigma$ SAR < 1.6, Not required
			Bottom Side	0.03	0.00	0.03	$\Sigma$ SAR < 1.6, Not required
17	LTE 12 + WLAN (NII)	Head	Right Cheek	0.20	0.15	0.35	$\Sigma$ SAR < 1.6, Not required
			Right Tilted	0.07	0.17	0.24	$\Sigma$ SAR < 1.6, Not required
			Left Cheek	0.10	0.58	0.68	$\Sigma$ SAR < 1.6, Not required
			Left Tilted	0.06	0.26	0.32	$\Sigma$ SAR < 1.6, Not required
		Body-Worn	Front Face	0.06	0.08	0.14	$\Sigma$ SAR < 1.6, Not required
			Rear Face	0.11	0.03	0.14	$\Sigma$ SAR < 1.6, Not required
18	LTE 12 + BT (DSS)	Body-Worn	Front Face	0.06	0.19	0.25	$\Sigma$ SAR < 1.6, Not required
			Rear Face	0.11	0.19	0.30	$\Sigma$ SAR < 1.6, Not required



# FCC SAR Test Report

No.	Conditions (SAR1 + SAR2)	Exposure Condition	Test Position	Max. SAR1	Max. SAR2	SAR Summation	SPLSR Analysis
19	LTE 25 + WLAN (DTS)	Head	Right Cheek	0.28	0.08	0.36	$\Sigma$ SAR < 1.6, Not required
			Right Tilted	0.23	0.05	0.28	$\Sigma$ SAR < 1.6, Not required
			Left Cheek	0.17	0.24	0.41	$\Sigma$ SAR < 1.6, Not required
			Left Tilted	0.16	0.19	0.35	$\Sigma$ SAR < 1.6, Not required
		Body-Worn	Front Face	0.13	0.03	0.16	$\Sigma$ SAR < 1.6, Not required
			Rear Face	0.17	0.01	0.18	$\Sigma$ SAR < 1.6, Not required
		Hotspot	Front Face	0.13	0.03	0.16	$\Sigma$ SAR < 1.6, Not required
			Rear Face	0.17	0.01	0.18	$\Sigma$ SAR < 1.6, Not required
			Left Side	0.12	0.00	0.12	$\Sigma$ SAR < 1.6, Not required
			Right Side	0.02	0.02	0.04	$\Sigma$ SAR < 1.6, Not required
			Top Side	0.15	0.00	0.15	$\Sigma$ SAR < 1.6, Not required
			Bottom Side	0.19	0.00	0.19	$\Sigma$ SAR < 1.6, Not required
20	LTE 25 + WLAN (NII)	Head	Right Cheek	0.28	0.15	0.43	$\Sigma$ SAR < 1.6, Not required
			Right Tilted	0.23	0.17	0.40	$\Sigma$ SAR < 1.6, Not required
			Left Cheek	0.17	0.58	0.75	$\Sigma$ SAR < 1.6, Not required
			Left Tilted	0.16	0.26	0.42	$\Sigma$ SAR < 1.6, Not required
		Body-Worn	Front Face	0.13	0.08	0.21	$\Sigma$ SAR < 1.6, Not required
			Rear Face	0.17	0.03	0.20	$\Sigma$ SAR < 1.6, Not required
21	LTE 25 + BT (DSS)	Body-Worn	Front Face	0.13	0.19	0.32	$\Sigma$ SAR < 1.6, Not required
			Rear Face	0.17	0.19	0.36	$\Sigma$ SAR < 1.6, Not required



# FCC SAR Test Report

No.	Conditions (SAR1 + SAR2)	Exposure Condition	Test Position	Max. SAR1	Max. SAR2	SAR Summation	SPLSR Analysis
22	LTE 26 + WLAN (DTS)	Head	Right Cheek	0.56	0.08	0.64	$\Sigma$ SAR < 1.6, Not required
			Right Tilted	0.26	0.05	0.31	$\Sigma$ SAR < 1.6, Not required
			Left Cheek	0.29	0.24	0.53	$\Sigma$ SAR < 1.6, Not required
			Left Tilted	0.16	0.19	0.35	$\Sigma$ SAR < 1.6, Not required
		Body-Worn	Front Face	0.15	0.03	0.18	$\Sigma$ SAR < 1.6, Not required
			Rear Face	0.21	0.01	0.22	$\Sigma$ SAR < 1.6, Not required
		Hotspot	Front Face	0.15	0.03	0.18	$\Sigma$ SAR < 1.6, Not required
			Rear Face	0.21	0.01	0.22	$\Sigma$ SAR < 1.6, Not required
			Left Side	0.16	0.00	0.16	$\Sigma$ SAR < 1.6, Not required
			Right Side	0.06	0.02	0.08	$\Sigma$ SAR < 1.6, Not required
			Top Side	0.02	0.00	0.02	$\Sigma$ SAR < 1.6, Not required
				Bottom Side	0.08	0.00	0.08
23	LTE 26 + WLAN (NII)	Head	Right Cheek	0.56	0.15	0.71	$\Sigma$ SAR < 1.6, Not required
			Right Tilted	0.26	0.17	0.43	$\Sigma$ SAR < 1.6, Not required
			Left Cheek	0.29	0.58	0.87	$\Sigma$ SAR < 1.6, Not required
			Left Tilted	0.16	0.26	0.42	$\Sigma$ SAR < 1.6, Not required
		Body-Worn	Front Face	0.15	0.08	0.23	$\Sigma$ SAR < 1.6, Not required
			Rear Face	0.21	0.03	0.24	$\Sigma$ SAR < 1.6, Not required
24	LTE 26 + BT (DSS)	Body-Worn	Front Face	0.15	0.19	0.34	$\Sigma$ SAR < 1.6, Not required
			Rear Face	0.21	0.19	0.40	$\Sigma$ SAR < 1.6, Not required



# FCC SAR Test Report

No.	Conditions (SAR1 + SAR2)	Exposure Condition	Test Position	Max. SAR1	Max. SAR2	SAR Summation	SPLSR Analysis
25	LTE 41 + WLAN (DTS)	Head	Right Cheek	0.25	0.08	0.33	$\Sigma$ SAR < 1.6, Not required
			Right Tilted	0.16	0.05	0.21	$\Sigma$ SAR < 1.6, Not required
			Left Cheek	0.21	0.24	0.45	$\Sigma$ SAR < 1.6, Not required
			Left Tilted	0.14	0.19	0.33	$\Sigma$ SAR < 1.6, Not required
		Body-Worn	Front Face	0.11	0.03	0.14	$\Sigma$ SAR < 1.6, Not required
			Rear Face	0.13	0.01	0.14	$\Sigma$ SAR < 1.6, Not required
		Hotspot	Front Face	0.11	0.03	0.14	$\Sigma$ SAR < 1.6, Not required
			Rear Face	0.13	0.01	0.14	$\Sigma$ SAR < 1.6, Not required
			Left Side	0.17	0.00	0.17	$\Sigma$ SAR < 1.6, Not required
			Right Side	0.02	0.02	0.04	$\Sigma$ SAR < 1.6, Not required
			Top Side	0.04	0.00	0.04	$\Sigma$ SAR < 1.6, Not required
			Bottom Side	0.08	0.00	0.08	$\Sigma$ SAR < 1.6, Not required
26	LTE 41 + WLAN (NII)	Head	Right Cheek	0.25	0.15	0.40	$\Sigma$ SAR < 1.6, Not required
			Right Tilted	0.16	0.17	0.33	$\Sigma$ SAR < 1.6, Not required
			Left Cheek	0.21	0.58	0.79	$\Sigma$ SAR < 1.6, Not required
			Left Tilted	0.14	0.26	0.40	$\Sigma$ SAR < 1.6, Not required
		Body-Worn	Front Face	0.11	0.08	0.19	$\Sigma$ SAR < 1.6, Not required
			Rear Face	0.13	0.03	0.16	$\Sigma$ SAR < 1.6, Not required
27	LTE 41 + BT (DSS)	Body-Worn	Front Face	0.11	0.19	0.30	$\Sigma$ SAR < 1.6, Not required
			Rear Face	0.13	0.19	0.32	$\Sigma$ SAR < 1.6, Not required

Test Engineer : Enzo Chang, and Eric Wu



### 5. Calibration of Test Equipment

Equipment	Manufacturer	Model	SN	Cal. Date	Cal. Interval
System Validation Dipole	SPEAG	D750V3	1013	Aug. 28, 2014	2 Years
System Validation Dipole	SPEAG	D835V2	4d121	Aug. 28, 2014	2 Years
System Validation Dipole	SPEAG	D1750V2	1055	Aug. 28, 2014	2 Years
System Validation Dipole	SPEAG	D1900V2	5d018	Jun. 18, 2014	2 Years
System Validation Dipole	SPEAG	D2000V2	1013	Aug. 26, 2014	2 Years
System Validation Dipole	SPEAG	D2450V2	737	Aug. 21, 2014	2 Years
System Validation Dipole	SPEAG	D2600V2	1020	Aug. 21, 2014	2 Years
System Validation Dipole	SPEAG	D5GHZV2	1019	Aug. 25, 2014	2 Years
Dosimetric E-Field Probe	SPEAG	EX3DV4	3590	Mar. 04, 2014	1 Year
Dosimetric E-Field Probe	SPEAG	EX3DV4	3650	Jul. 28, 2014	1 Year
Dosimetric E-Field Probe	SPEAG	EX3DV4	3864	Jul. 25, 2014	1 Year
Dosimetric E-Field Probe	SPEAG	EX3DV4	3971	Mar. 31, 2014	1 Year
Data Acquisition Electronics	SPEAG	DAE3	510	Aug. 26, 2014	1 Year
Data Acquisition Electronics	SPEAG	DAE4	861	Apr. 23, 2014	1 Year
Data Acquisition Electronics	SPEAG	DAE4	1431	Mar. 24, 2014	1 Year
Wireless Communication Test Set	Agilent	E5515C	MY50266628	Dec. 05, 2013	2 Years
Radio Communication Analyzer	Anritsu	MT8802C	6201010285	Aug. 08, 2014	1 Year
ENA Series Network Analyzer	Agilent	E5071C	MY46214281	Jun. 13, 2014	1 Year
EXA Spectrum Analyzer	Agilent	N9010A	MY53470455	Feb. 22, 2014	1 Year
MXG Analog Signal Generator	Agilent	N5181A	MY50143868	Jun. 26, 2014	1 Year
Power Meter	Anritsu	ML2495A	1218009	Jun. 26, 2014	1 Year
Power Sensor	Anritsu	MA2411B	1207252	Jun. 26, 2014	1 Year
Thermometer	YFE	YF-160A	130504579	Aug. 21, 2014	1 Year





## 6. Measurement Uncertainty

Error Description	Uncertainty Value (±%)	Probability Distribution	Divisor	C <sub>i</sub> (1g)	Standard Uncertainty (1g)	V <sub>i</sub>
<b>Measurement System</b>						
Probe Calibration	6.0	Normal	1	1	± 6.0 %	∞
Axial Isotropy	4.7	Rectangular	√3	0.7	± 1.9 %	∞
Hemispherical Isotropy	9.6	Rectangular	√3	0.7	± 3.9 %	∞
Boundary Effects	1.0	Rectangular	√3	1	± 0.6 %	∞
Linearity	4.7	Rectangular	√3	1	± 2.7 %	∞
System Detection Limits	1.0	Rectangular	√3	1	± 0.6 %	∞
Readout Electronics	0.6	Normal	1	1	± 0.6 %	∞
Response Time	0.0	Rectangular	√3	1	± 0.0 %	∞
Integration Time	1.7	Rectangular	√3	1	± 1.0 %	∞
RF Ambient Noise	3.0	Rectangular	√3	1	± 1.7 %	∞
RF Ambient Reflections	3.0	Rectangular	√3	1	± 1.7 %	∞
Probe Positioner	0.5	Rectangular	√3	1	± 0.3 %	∞
Probe Positioning	2.9	Rectangular	√3	1	± 1.7 %	∞
Max. SAR Eval.	2.3	Rectangular	√3	1	± 1.3 %	∞
<b>Test Sample Related</b>						
Device Positioning	3.9	Normal	1	1	± 3.9 %	31
Device Holder	2.7	Normal	1	1	± 2.7 %	19
Power Drift	5.0	Rectangular	√3	1	± 2.9 %	∞
<b>Phantom and Setup</b>						
Phantom Uncertainty	4.0	Rectangular	√3	1	± 2.3 %	∞
Liquid Conductivity (Target)	5.0	Rectangular	√3	0.64	± 1.8 %	∞
Liquid Conductivity (Meas.)	5.0	Normal	1	0.64	± 3.2 %	29
Liquid Permittivity (Target)	5.0	Rectangular	√3	0.6	± 1.7 %	∞
Liquid Permittivity (Meas.)	5.0	Normal	1	0.6	± 3.0 %	29
<b>Combined Standard Uncertainty</b>					± 11.7 %	
<b>Expanded Uncertainty (K=2)</b>					<b>± 23.4 %</b>	

Uncertainty budget for frequency range 300 MHz to 3 GHz



# FCC SAR Test Report

Error Description	Uncertainty Value (±%)	Probability Distribution	Divisor	Ci (1g)	Standard Uncertainty (1g)	Vi
<b>Measurement System</b>						
Probe Calibration	6.55	Normal	1	1	± 6.55 %	∞
Axial Isotropy	4.7	Rectangular	√3	0.7	± 1.9 %	∞
Hemispherical Isotropy	9.6	Rectangular	√3	0.7	± 3.9 %	∞
Boundary Effects	2.0	Rectangular	√3	1	± 1.2 %	∞
Linearity	4.7	Rectangular	√3	1	± 2.7 %	∞
System Detection Limits	1.0	Rectangular	√3	1	± 0.6 %	∞
Readout Electronics	0.3	Normal	1	1	± 0.3 %	∞
Response Time	0.8	Rectangular	√3	1	± 0.5 %	∞
Integration Time	2.6	Rectangular	√3	1	± 1.5 %	∞
RF Ambient Noise	3.0	Rectangular	√3	1	± 1.7 %	∞
RF Ambient Reflections	3.0	Rectangular	√3	1	± 1.7 %	∞
Probe Positioner	0.8	Rectangular	√3	1	± 0.5 %	∞
Probe Positioning	9.9	Rectangular	√3	1	± 5.7 %	∞
Max. SAR Eval.	4.0	Rectangular	√3	1	± 2.3 %	∞
<b>Test Sample Related</b>						
Device Positioning	3.9	Normal	1	1	± 3.9 %	31
Device Holder	2.7	Normal	1	1	± 2.7 %	19
Power Drift	5.0	Rectangular	√3	1	± 2.9 %	∞
<b>Phantom and Setup</b>						
Phantom Uncertainty	4.0	Rectangular	√3	1	± 2.3 %	∞
Liquid Conductivity (Target)	5.0	Rectangular	√3	0.64	± 1.8 %	∞
Liquid Conductivity (Meas.)	5.0	Normal	1	0.64	± 3.2 %	30
Liquid Permittivity (Target)	5.0	Rectangular	√3	0.6	± 1.7 %	∞
Liquid Permittivity (Meas.)	5.0	Normal	1	0.6	± 3.0 %	30
<b>Combined Standard Uncertainty</b>					± 13.4 %	
<b>Expanded Uncertainty (K=2)</b>					<b>± 26.8 %</b>	

## Uncertainty budget for frequency range 3 GHz to 6 GHz



## FCC SAR Test Report

---

### 7. Information on the Testing Laboratories

We, Bureau Veritas Consumer Products Services (H.K.) Ltd., Taoyuan Branch, were founded in 1988 to provide our best service in EMC, Radio, Telecom and Safety consultation. Our laboratories are accredited and approved according to ISO/IEC 17025.

If you have any comments, please feel free to contact us at the following:

**Taiwan HwaYa EMC/RF/Safety/Telecom Lab:**

Add: No. 19, Hwa Ya 2nd Rd, Wen Hwa Vil., Kwei Shan Hsiang, Taoyuan Hsien 333, Taiwan, R.O.C.

Tel: 886-3-318-3232

Fax: 886-3-327-0892

**Taiwan LinKo EMC/RF Lab:**

Add: No. 47-2, 14th Ling, Chia Pau Vil., Linkou Dist., New Taipei City 244, Taiwan, R.O.C.

Tel: 886-2-2605-2180

Fax: 886-2-2605-1924

**Taiwan HsinChu EMC/RF Lab:**

Add: No. 81-1, Lu Liao Keng, 9<sup>th</sup> Ling, Wu Lung Vil., Chiung Lin Township, Hsinchu County 307, Taiwan, R.O.C.

Tel: 886-3-593-5343

Fax: 886-3-593-5342

**Email:** [service.adt@tw.bureauveritas.com](mailto:service.adt@tw.bureauveritas.com)

**Web Site:** [www.adt.com.tw](http://www.adt.com.tw)

The road map of all our labs can be found in our web site also.

---END---