



# FCC TEST REPORT (PART 27)

**REPORT NO.:** RF141203C08-9

**MODEL NO.:** 0PJA110

**FCC ID:** NM80PJA110

**RECEIVED:** Dec. 03, 2014

**TESTED:** Jan. 06, 2015 ~ Jan. 22, 2015

**ISSUED:** Jan. 22, 2015

**APPLICANT:** HTC Corporation

**ADDRESS:** 1F, 6-3 Baoqiang Road, Xindian District, New Taipei

**ISSUED BY:** Bureau Veritas Consumer Products Services (H.K.) Ltd., Taoyuan Branch

**LAB ADDRESS:** No. 47-2, 14th Ling, Chia Pau Vil., Lin Kou Dist., New Taipei City, Taiwan, R.O.C.

**TEST LOCATION:** No. 19, Hwa Ya 2nd Rd, Wen Hwa Tsuen, Kwei Shan Hsiang, Taoyuan Hsien 333, Taiwan, R.O.C.

This report should not be used by the client to claim product certification, approval, or endorsement by TAF or any government agencies.



This report is for your exclusive use. Any copying or replication of this report to or for any other person or entity, or use of our name or trademark, is permitted only with our prior written permission. This report sets forth our findings solely with respect to the test samples identified herein. The results set forth in this report are not indicative or representative of the quality or characteristics of the lot from which a test sample was taken or any similar or identical product unless specifically and expressly noted. Our report includes all of the tests requested by you and the results thereof based upon the information that you provided to us. You have 60 days from date of issuance of this report to notify us of any material error or omission caused by our negligence, provided, however, that such notice shall be in writing and shall specifically address the issue you wish to raise. A failure to raise such issue within the prescribed time shall constitute your unqualified acceptance of the completeness of this report, the tests conducted and the correctness of the report contents. Unless specifically mentioned, the uncertainty of measurement has been explicitly taken into account to declare the compliance or non-compliance to the specification.

## TABLE OF CONTENTS

RELEASE CONTROL RECORD.....	3
1 CERTIFICATION .....	4
2 SUMMARY OF TEST RESULTS.....	5
2.1 MEASUREMENT UNCERTAINTY .....	5
2.2 TEST SITE AND INSTRUMENTS .....	6
3 GENERAL INFORMATION .....	7
3.1 GENERAL DESCRIPTION OF EUT.....	7
3.2 CONFIGURATION OF SYSTEM UNDER TEST .....	8
3.3 DESCRIPTION OF SUPPORT UNITS.....	8
3.4 DESCRIPTION OF TEST MODES.....	9
3.5 GENERAL DESCRIPTION OF APPLIED STANDARDS .....	10
4 TEST TYPES AND RESULTS.....	11
4.1 OUTPUT POWER MEASUREMENT .....	11
4.1.1 LIMITS OF OUTPUT POWER MEASUREMENT .....	11
4.1.2 TEST PROCEDURES .....	11
4.1.3 TEST SETUP .....	12
4.1.4 TEST RESULTS .....	13
4.2 FREQUENCY STABILITY MEASUREMENT .....	15
4.2.1 LIMITS OF FREQUENCY STABILITY MEASUREMENT .....	15
4.2.2 TEST PROCEDURE .....	15
4.2.3 TEST SETUP .....	15
4.2.4 TEST RESULTS .....	16
4.3 OCCUPIED BANDWIDTH MEASUREMENT.....	17
4.3.1 LIMITS OF OCCUPIED BANDWIDTH MEASUREMENT.....	17
4.3.2 TEST SETUP .....	17
4.3.3 TEST PROCEDURES.....	17
4.3.4 TEST RESULTS .....	18
4.4 BAND EDGE MEASUREMENT .....	19
4.4.1 LIMITS OF BAND EDGE MEASUREMENT .....	19
4.4.2 TEST SETUP .....	19
4.4.3 TEST PROCEDURES.....	20
4.4.4 TEST RESULTS .....	21
4.5 CONDUCTED SPURIOUS EMISSIONS.....	24
4.5.1 LIMITS OF CONDUCTED SPURIOUS EMISSIONS MEASUREMENT.....	24
4.5.2 TEST PROCEDURE .....	24
4.5.3 TEST SETUP .....	24
4.5.4 TEST RESULTS .....	25
4.6 RADIATED EMISSION MEASUREMENT .....	27
4.6.1 LIMITS OF RADIATED EMISSION MEASUREMENT .....	27
4.6.2 TEST PROCEDURES.....	27
4.6.3 DEVIATION FROM TEST STANDARD.....	27
4.6.4 TEST SETUP .....	28
4.6.5 TEST RESULTS .....	29
5 INFORMATION ON THE TESTING LABORATORIES .....	31
6 APPENDIX A – MODIFICATIONS RECORDERS FOR ENGINEERING CHANGES TO THE EUT BY THE LAB.....	32



A D T

## RELEASE CONTROL RECORD

ISSUE NO.	REASON FOR CHANGE	DATE ISSUED
RF141203C08-9	Original release	Jan. 22, 2015



## 1 CERTIFICATION

**PRODUCT:** Smartphone  
**MODEL NO.:** 0PJA110  
**BRAND:** HTC  
**APPLICANT:** HTC Corporation  
**TESTED:** Jan. 06, 2015 ~ Jan. 22, 2015  
**TEST SAMPLE:** Production Unit  
**TEST STANDARDS:** **FCC Part 27, Subpart C**  
**FCC Part 2**

The above equipment (model: 0PJA110) has been tested by **Bureau Veritas Consumer Products Services (H.K.) Ltd., Taoyuan Branch**, and found compliance with the requirement of the above standards. The test record, data evaluation & Equipment Under Test (EUT) configurations represented herein are true and accurate accounts of the measurements of the sample's EMC characteristics under the conditions specified in this report.

**PREPARED BY** : Ivonne Wu , **DATE:** Jan. 22, 2015  
Ivonne Wu / Supervisor

**APPROVED BY** : Sam Chen , **DATE:** Jan. 22, 2015  
Sam Chen / Senior Project Engineer

## 2 SUMMARY OF TEST RESULTS

The EUT has been tested according to the following specifications:

STANDARD SECTION	TEST TYPE AND LIMIT	RESULT	REMARK
2.1046 27.50(a)(3)	Equivalent Isotropic Radiated Power	PASS	Meet the requirement of limit.
2.1055 27.54	Frequency Stability	PASS	Meet the requirement of limit.
2.1049	Occupied Bandwidth	PASS	Meet the requirement of limit.
2.1051 27.53(a)(4)	Band Edge Measurements	PASS	Meet the requirement of limit.
2.1051 27.53(a)(4)	Conducted Spurious Emissions	PASS	Meet the requirement of limit.
2.1053 27.53(a)(4)	Radiated Spurious Emissions	PASS	Meet the requirement of limit. Minimum passing margin is -6.43dB at 188.22MHz.

### 2.1 MEASUREMENT UNCERTAINTY

Where relevant, the following measurement uncertainty levels have been estimated for tests performed on the EUT as specified in CISPR 16-4-2:

MEASUREMENT	FREQUENCY	UNCERTAINTY
Conducted emissions	9kHz~30MHz	2.44 dB
Radiated emissions	30MHz ~ 200MHz	2.93 dB
	200MHz ~1000MHz	2.95 dB
	1GHz ~ 18GHz	2.26 dB
	18GHz ~ 40GHz	1.94 dB

This uncertainty represents an expanded uncertainty expressed at approximately the 95% confidence level using a coverage factor of k=2.

## 2.2 TEST SITE AND INSTRUMENTS

DESCRIPTION & MANUFACTURER	MODEL NO.	SERIAL NO.	DATE OF CALIBRATION	DUE DATE OF CALIBRATION
Test Receiver ROHDE & SCHWARZ	ESCI	100744	Apr. 15, 2014	Apr. 14, 2015
Spectrum Analyzer ROHDE & SCHWARZ	FSU43	101261	Dec. 10, 2014	Dec. 09, 2015
BILOG Antenna SCHWARZBECK	VULB9168	9168-472	Feb. 27, 2014	Feb. 26, 2015
HORN Antenna SCHWARZBECK	BBHA 9120 D	9120D-969	Feb. 19, 2014	Feb. 18, 2015
HORN Antenna SCHWARZBECK	BBHA 9170	9170-480	Aug. 27, 2014	Aug. 26, 2015
Preamplifier EMCI	EMC 012645	980115	Dec. 12, 2014	Dec. 11, 2015
Preamplifier EMCI	EMC184045B	980235	Nov. 13, 2014	Nov. 12, 2015
Preamplifier EMCI	EMC 330H	980071	Feb. 27, 2014	Feb. 26, 2015
RF signal cable HUBER+SUHNNER	SUCOFLEX 104	309219/4 2950114	Oct. 18, 2014	Oct. 17, 2015
RF signal cable HUBER+SUHNNER	SUCOFLEX 104	250130/4	Oct. 18, 2014	Oct. 17, 2015
RF signal cable Woken	RG-213	NA	Nov. 07, 2014	Nov. 06, 2015
Software BV ADT	E3 6.120103	NA	NA	NA
Antenna Tower MF	MFA-440H	NA	NA	NA
Turn Table MF	MFT-201SS	NA	NA	NA
Antenna Tower & Turn Table Controller MF	MF-7802	NA	NA	NA
Power Splitter Woken	2-18GHz 2Way SMA Fwd.:30W/Rev.:2W Isolated Power	COM412W5E3	Apr. 17, 2014	Apr. 16, 2015
JFW 20dB attenuation	50HF-020-SMA	NA	NA	NA
Communications Tester-Wireless	E5515C	MY52102544	Sep. 11, 2014	Sep. 10, 2016
Test Receiver ROHDE & SCHWARZ	ESCI	100744	Apr. 15, 2014	Apr. 14, 2015

- NOTE:**
1. The calibration interval of the above test instruments is 12 / 24 months and the calibrations are traceable to NML/ROC and NIST/USA.
  2. The test was performed in HwaYa Chamber 10.
  3. The horn antenna and HP preamplifier (model: 8449B) are used only for the measurement of emission frequency above 1GHz if tested.
  4. The FCC Site Registration No. is 690701.
  5. The IC Site Registration No. is IC 7450F-10.

### 3 GENERAL INFORMATION

#### 3.1 GENERAL DESCRIPTION OF EUT

<b>PRODUCT</b>	Smartphone	
<b>MODEL NO.</b>	0PJA110	
<b>POWER SUPPLY</b>	5Vdc (adapter or host equipment) 3.83Vdc (battery)	
<b>MODULATION TECHNOLOGY</b>	LTE Band 30	QPSK, 16QAM
<b>FREQUENCY RANGE</b>	LTE Band 30 Channel Bandwidth: 5MHz	2307.5MHz ~ 2312.5MHz
	LTE Band 30 Channel Bandwidth: 10MHz	2310MHz
<b>EMISSION DESIGNATOR</b>	LTE Band 30 Channel Bandwidth: 5MHz	4M84G7D
	LTE Band 30 Channel Bandwidth: 10MHz	8M98G7D
<b>MAX. EIRP POWER</b>	LTE Band 30 Channel Bandwidth: 5MHz	235.88mW
	LTE Band 30 Channel Bandwidth: 10MHz	240.82mW
<b>ANTENNA TYPE</b>	Fixed Internal Antenna	
<b>DATA CABLE</b>	Refer to Note as below	
<b>I/O PORTS</b>	Refer to users' manual	
<b>ACCESSORY DEVICES</b>	Refer to Note as below	

**NOTE:**

1. The EUT's accessories list refers to Ext. Pho.
2. The above EUT information is declared by manufacturer and for more detailed features description, please refer to the manufacturer's specifications or User's Manual.

### 3.2 CONFIGURATION OF SYSTEM UNDER TEST FOR RADIATION EMISSION TEST

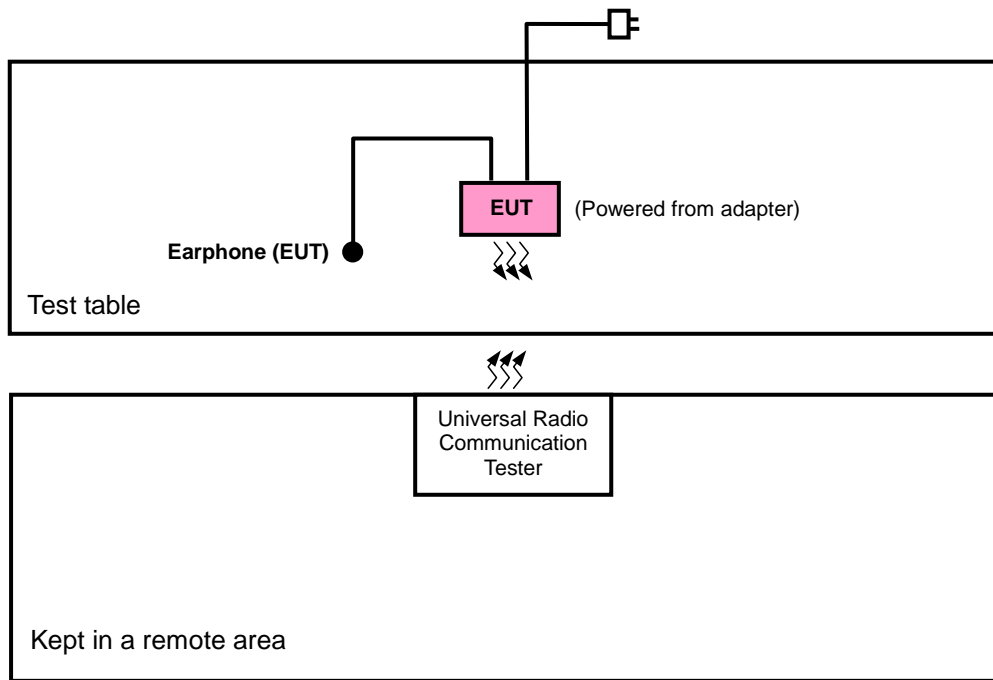

### FOR E.I.R.P. TEST

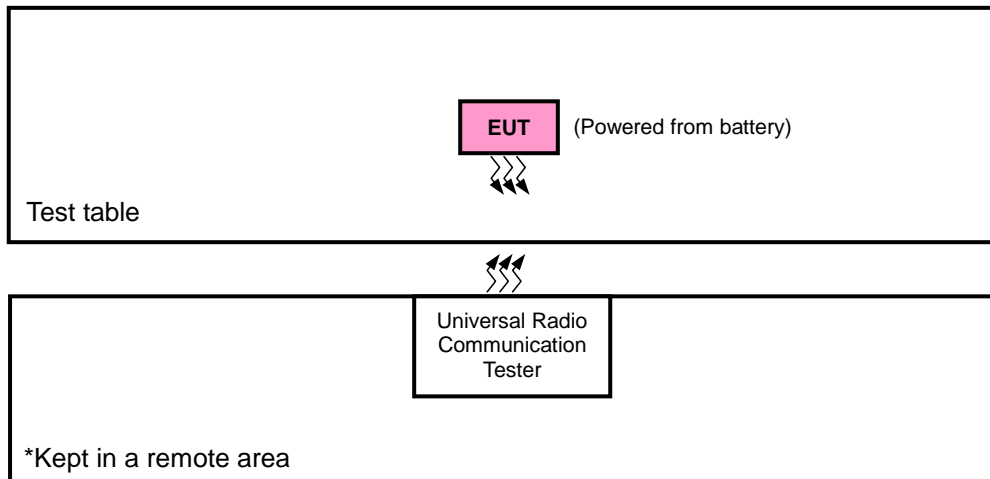

### 3.3 DESCRIPTION OF SUPPORT UNITS

The EUT has been tested as an independent unit together with other necessary accessories or support units.



### 3.4 DESCRIPTION OF TEST MODES

Pre-Scan has been conducted to determine the worst-case mode from all possible combinations between available modulations, data rates, XYZ axis and antenna ports. The worst case was found when positioned on X-plane for EIRP and Z-axis for radiated emission. Following channel(s) was (were) selected for the final test as listed below:

#### LTE BAND 30

EUT CONFIGURE MODE	TEST ITEM	AVAILABLE CHANNEL	TESTED CHANNEL	CHANNEL BANDWIDTH	MODULATION	MODE
-	EIRP	27685 to 27735	27685, 27710, 27735	5MHz	QPSK, 16QAM	1 RB / 24 RB Offset
		27710	27710	10MHz	QPSK, 16QAM	1 RB / 49 RB Offset
-	FREQUENCY STABILITY	27685 to 27735	27710	5MHz	QPSK	1 RB / 24 RB Offset
		27710	27710	10MHz	QPSK	1 RB / 49 RB Offset
-	OCCUPIED BANDWIDTH	27685 to 27735	27685, 27710, 27735	5MHz	QPSK, 16QAM	25 RB / 0 RB Offset
		27710	27710	10MHz	QPSK, 16QAM	50 RB / 0 RB Offset
-	BAND EDGE	27685 to 27735	27685, 27710, 27735	5MHz	QPSK, 16QAM	25 RB / 0 RB Offset
		27710	27710	10MHz	QPSK, 16QAM	50 RB / 0 RB Offset
-	CONDCUETED EMISSION	27685 to 27735	27710	5MHz	QPSK	1 RB / 24 RB Offset
		27710	27710	10MHz	QPSK	1 RB / 49 RB Offset
-	RADIATED EMISSION	27685 to 27735	27710	5MHz	QPSK	1 RB / 49 RB Offset

**Note:** This device was tested under all bandwidths, RB configurations and modulations. The worst case was found in QPSK modulation.

#### TEST CONDITION:

TEST ITEM	ENVIRONMENTAL CONDITIONS	INPUT POWER	TESTED BY
ERP/EIRP	26deg. C, 58%RH	3.82Vdc	Will Chen
FREQUENCY STABILITY	26deg. C, 58%RH	3.82Vdc	Howard Kao
OCCUPIED BANDWIDTH	26deg. C, 58%RH	3.82Vdc	Howard Kao
PEAK TO AVERAGE RATIO	26deg. C, 58%RH	3.82Vdc	Howard Kao
BAND EDGE	26deg. C, 58%RH	3.82Vdc	Howard Kao
CONDUCTED EMISSION	26deg. C, 58%RH	3.82Vdc	Howard Kao
RADIATED EMISSION	25deg. C, 65%RH	120Vac, 60Hz	Will Chen

### **3.5 GENERAL DESCRIPTION OF APPLIED STANDARDS**

The EUT is a RF product. According to the specifications of the manufacturer, it must comply with the requirements of the following standards:

**FCC 47 CFR Part 2**

**FCC 47 CFR Part 27**

**ANSI/TIA/EIA-603-C 2004**

**NOTE:** All test items have been performed and recorded as per the above standards.

## 4 TEST TYPES AND RESULTS

### 4.1 OUTPUT POWER MEASUREMENT

#### 4.1.1 LIMITS OF OUTPUT POWER MEASUREMENT

Mobile and portable stations. (i) For mobile and portable stations transmitting in the 2305-2315 MHz band or the 2350-2360 MHz band, the average EIRP must not exceed 50 milliwatts within any 1 megahertz of authorized bandwidth, except that for mobile and portable stations compliant with 3GPP LTE standards or another advanced mobile broadband protocol that avoids concentrating energy at the edge of the operating band the average EIRP must not exceed 250 milliwatts within any 5 megahertz of authorized bandwidth but may exceed 50 milliwatts within any 1 megahertz of authorized bandwidth. For mobile and portable stations using time division duplexing (TDD) technology, the duty cycle must not exceed 38 percent in the 2305-2315 MHz and 2350-2360 MHz bands. Mobile and portable stations using FDD technology are restricted to transmitting in the 2305-2315 MHz band. Power averaging shall not include intervals in which the transmitter is off

#### 4.1.2 TEST PROCEDURES

##### EIRP MEASUREMENT:

- a. All measurements were done at low, middle and high operational frequency range. RBW and VBW is 10MHz for LTE mode.
- b. Substitution method is used for E.I.R.P measurement. In the semi-anechoic chamber, EUT placed on the 0.8m height of Turn Table, rotated the table around 360 degrees to search the maximum radiation power and receiver antenna shall be rotated vertical and horizontal polarization and moved height from 1m to 4m to find the maximum polar radiated power. The "Read Value" is the spectrum reading the maximum power value.
- c. The substitution horn antenna is substituted for EUT at the same position and signals generator export the CW signal to the substitution antenna via a tx cable. Rotated the Turn Table and moved receiving antenna to find the maximum radiation power. Adjust output power level of S.G to get a Value of spectrum reading equal to "Read Value" of step b. Record the power level of S.G.
- d.  $EIRP = \text{Output power level of S.G} - \text{TX cable loss} + \text{Antenna gain of substitution horn}.$

##### CONDUCTED POWER MEASUREMENT:

- a. The EUT was set up for the maximum power with LTE link data modulation and link up with simulator.
- b. Set the EUT to transmit under low, middle and high channel and record the power level shown on simulator.

### 4.1.3 TEST SETUP

#### EIRP / ERP MEASUREMENT:

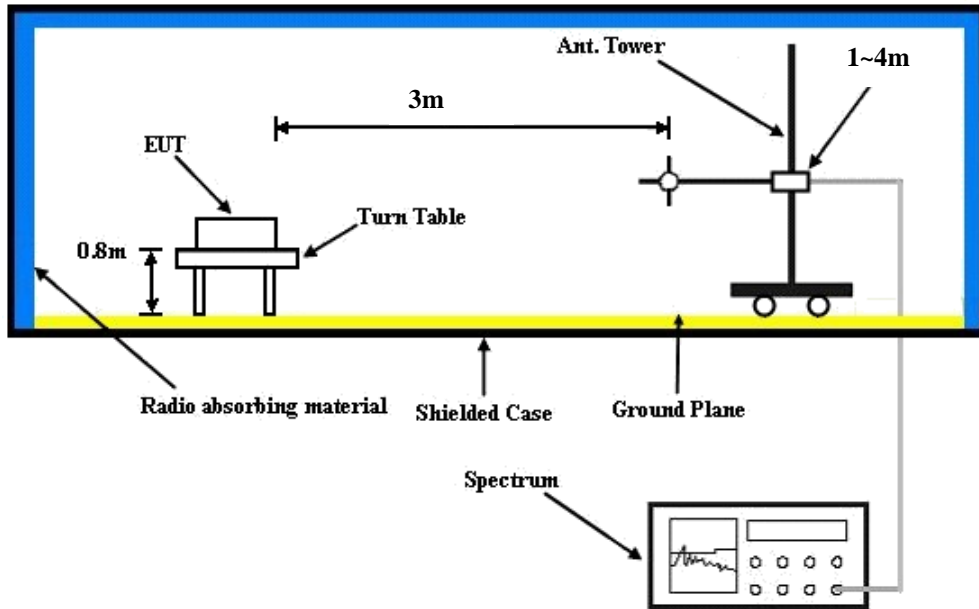

#### CONDUCTED POWER MEASUREMENT:

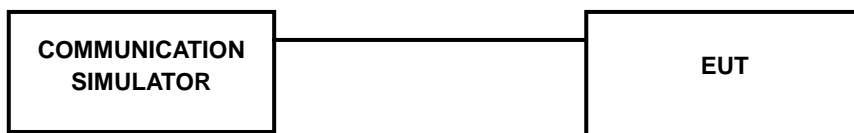



A D T

#### 4.1.4 TEST RESULTS

##### AVERAGE CONDUCTED OUTPUT POWER (dBm)

LTE Band / BW	RB Size	RB Offset	QPSK			3GPP MPR (dB)	16QAM			3GPP MPR (dB)
			Low CH 27685	Mid CH 27710	High CH 27735		Low CH 27685	Mid CH 27710	High CH 27735	
			2307.5 MHz	2310.0 MHz	2312.5 MHz		2307.5 MHz	2310.0 MHz	2312.5 MHz	
30 / 5M	1	0	23.97	24.02	24.11	0	22.97	23.02	23.11	1
	1	12	24.07	24.12	24.21	0	23.07	23.12	23.21	1
	1	24	24.08	24.13	24.22	0	23.08	23.13	23.22	1
	12	0	22.97	23.02	23.11	1	21.97	22.02	22.11	2
	12	6	23.07	23.12	23.21	1	22.07	22.12	22.21	2
	12	13	23.08	23.13	23.22	1	22.08	22.13	22.22	2
	25	0	23.02	23.10	23.20	1	22.02	22.10	22.20	2

LTE Band / BW	RB Size	RB Offset	QPSK		3GPP MPR (dB)	16QAM		3GPP MPR (dB)
			Mid CH 27710	2310.0 MHz		Mid CH 27710	2310.0 MHz	
			2310.0 MHz	2310.0 MHz				
30 / 10M	1	0	24.03	23.03	0	23.03	1	
	1	24	24.14	23.14	0	23.14	1	
	1	49	24.25	23.15	0	23.15	1	
	25	0	23.03	22.03	1	22.03	2	
	25	12	23.14	22.14	1	22.14	2	
	25	25	23.15	22.15	1	22.15	2	
	50	0	23.02	22.02	1	22.02	2	

**AVERAGE EIRP (dBm)**

LTE Band 30							
Channel Bandwidth: 5MHz / QPSK							
Plane	Channel	Frequency (MHz)	LVL (dBm)	Correction Factor(dB)	EIRP(dBm)	EIRP(mW)	Polarization (H/V)
X	27685	2307.5	-20.55	44.24	23.69	233.78	H
	27710	2310.0	-20.47	44.20	23.73	235.88	
	27735	2312.5	-21.22	44.80	23.58	228.09	
	27685	2307.5	-22.71	44.19	21.48	140.64	V
	27710	2310.0	-23.05	44.09	21.04	127.00	
	27735	2312.5	-23.89	44.50	20.61	115.05	

LTE Band 30							
Channel Bandwidth: 5MHz / 16QAM							
Plane	Channel	Frequency (MHz)	LVL (dBm)	Correction Factor(dB)	EIRP(dBm)	EIRP(mW)	Polarization (H/V)
X	27685	2307.5	-21.36	44.24	22.88	194.00	H
	27710	2310.0	-21.26	44.20	22.94	196.65	
	27735	2312.5	-21.95	44.80	22.85	192.80	
	27685	2307.5	-23.50	44.19	20.69	117.25	V
	27710	2310.0	-23.76	44.09	20.33	107.84	
	27735	2312.5	-23.65	44.50	20.85	121.59	

LTE Band 30							
Channel Bandwidth: 10MHz / QPSK							
Plane	Channel	Frequency (MHz)	LVL (dBm)	Correction Factor(dB)	EIRP(dBm)	EIRP(mW)	Polarization (H/V)
X	27710	2310.0	-20.38	44.20	23.82	240.82	H
	27710	2310.0	-22.90	44.09	21.19	131.46	V

LTE Band 30							
Channel Bandwidth: 10MHz / 16QAM							
Plane	Channel	Frequency (MHz)	LVL (dBm)	Correction Factor(dB)	EIRP(dBm)	EIRP(mW)	Polarization (H/V)
X	27710	2310.0	-21.26	44.20	22.94	196.65	H
	27710	2310.0	-23.67	44.09	20.42	110.10	V

## 4.2 FREQUENCY STABILITY MEASUREMENT

### 4.2.1 LIMITS OF FREQUENCY STABILITY MEASUREMENT

The frequency stability shall be sufficient to ensure that the fundamental emissions stay within the authorized bands of operation.

### 4.2.2 TEST PROCEDURE

- Device is placed at the oven room. The oven room could control the temperatures and humidity. Power warm up is at least 15 min and power applied should perform before recording frequency error.
- EUT is connected the external power supply to control the DC input power. The test voltage range is from minimum to maximum working voltage. Each step shall be record the frequency error rate.
- The temperature range step is 10 degrees in this test items. All temperature levels shall be hold the  $\pm 0.5^{\circ}\text{C}$  during the measurement testing. The each temperature step shall be at least 0.5 hours, consider the EUT could be test under the stability condition.

**NOTE:** The frequency error was recorded frequency error from the communication simulator.

### 4.2.3 TEST SETUP

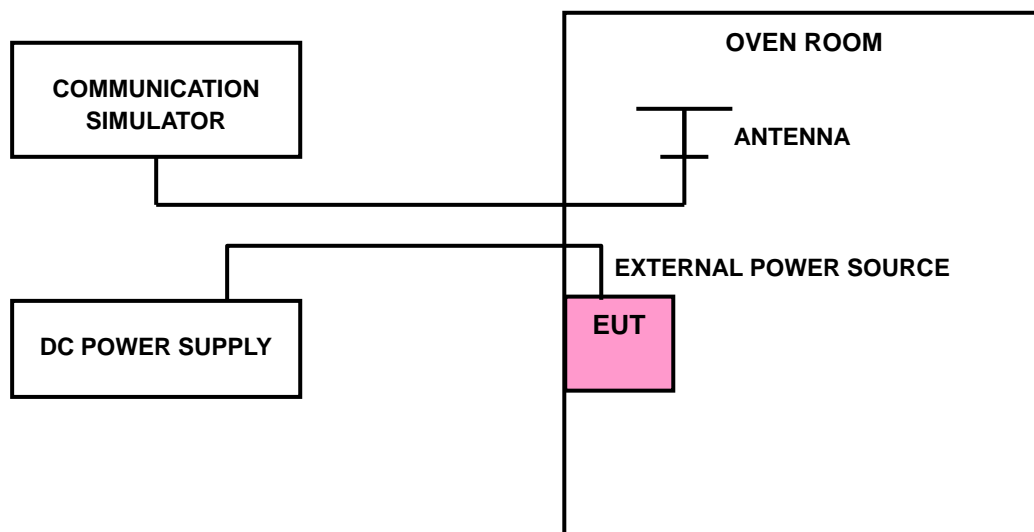

#### 4.2.4 TEST RESULTS

##### FREQUENCY ERROR vs. VOLTAGE

VOLTAGE (Volts)	FREQUENCY ERROR (ppm)		LIMIT (ppm)
	LTE BAND 30		
	5MHz	10MHz	
3.82	-0.0010	0.0016	2.5
3.6	-0.0017	-0.0026	2.5
4.40	-0.0018	-0.0014	2.5

**NOTE:** The applicant defined the normal working voltage of the battery is from 3.6Vdc to 4.40Vdc.

##### FREQUENCY ERROR vs. TEMPERATURE

TEMP. (°C)	FREQUENCY ERROR (ppm)		LIMIT (ppm)
	LTE BAND 30		
	5MHz	10MHz	
-30	-0.0017	-0.0032	2.5
-20	-0.0006	-0.0005	2.5
-10	-0.0010	-0.0009	2.5
0	-0.0018	-0.0029	2.5
10	-0.0038	-0.0013	2.5
20	-0.0008	-0.0032	2.5
30	0.0005	0.0022	2.5
40	-0.0022	0.0012	2.5
50	-0.0019	0.0017	2.5
60	0.0017	-0.0027	2.5



### 4.3 OCCUPIED BANDWIDTH MEASUREMENT

#### 4.3.1 LIMITS OF OCCUPIED BANDWIDTH MEASUREMENT

The width of a frequency band such that, below the lower and above the upper frequency limits, the mean powers emitted are each equal to a specified percentage 0.5 %of the total mean power of a given emission.

#### 4.3.2 TEST SETUP

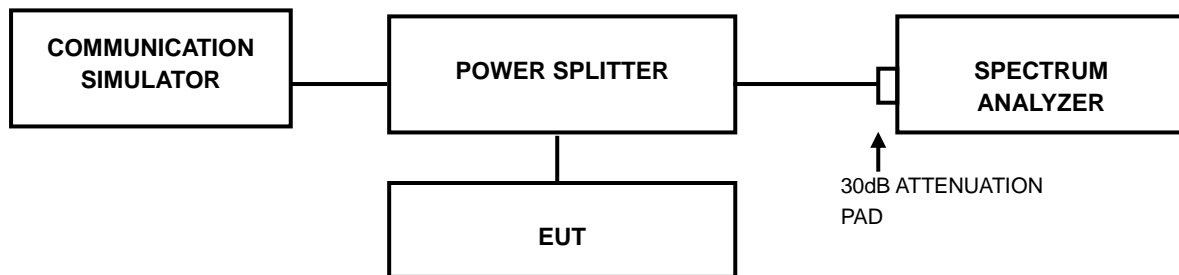

#### 4.3.3 TEST PROCEDURES

- The conducted occupied bandwidth used the power splitter via EUT RF power connector between simulation base station and spectrum analyzer.
- Use OBW measurement function of Spectrum analyzer to measure 99 % occupied bandwidth.



A D T

### 4.3.4 TEST RESULTS

LTE BAND 30							
CHANNEL BANDWIDTH: 5MHz				CHANNEL BANDWIDTH: 10MHz			
CHANNEL	FREQUENCY (MHz)	99% OCCUPIED BANDWIDTH (MHz)		CHANNEL	FREQUENCY (MHz)	99% OCCUPIED BANDWIDTH (MHz)	
		QPSK	16QAM			QPSK	16QAM
27685	2307.5	4.50	4.50	27710	2310.0	8.98	8.98
27710	2310.0	4.50	4.50				
27735	2312.5	4.50	4.50				

### SPECTRUM PLOT OF WORST VALUE

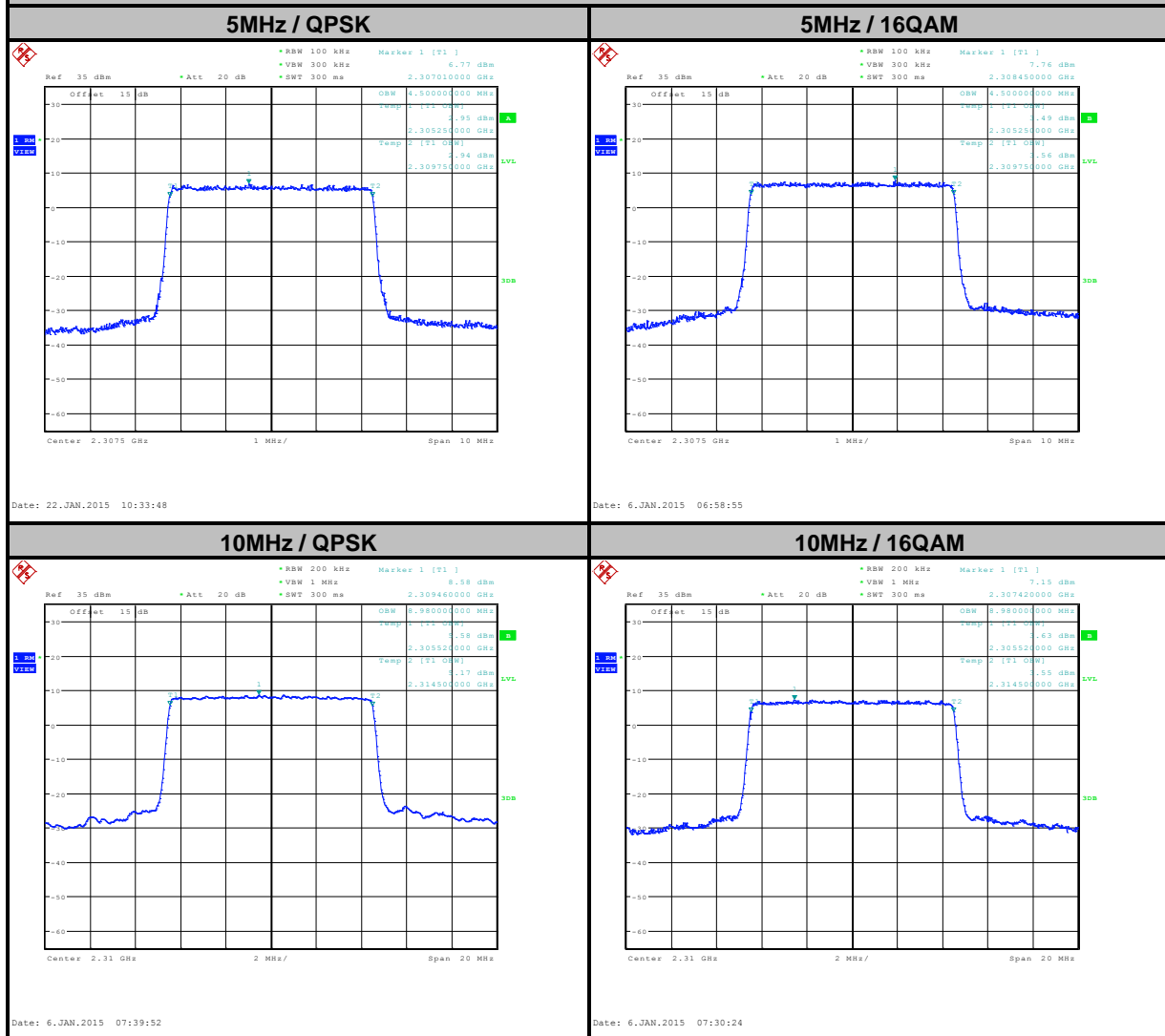

## 4.4 BAND EDGE MEASUREMENT

### 4.4.1 LIMITS OF BAND EDGE MEASUREMENT

According to FCC 27.53(a) (4) For mobile and portable stations operating in the 2305-2315 MHz and 2350-2360 MHz bands:

- (i) By a factor of not less than:  $43 + 10 \log (P)$  dB on all frequencies between 2305 and 2320 MHz and on all frequencies between 2345 and 2360 MHz that are outside the licensed band(s) of operation, not less than  $55 + 10 \log (P)$  dB on all frequencies between 2320 and 2324 MHz and on all frequencies between 2341 and 2345 MHz, not less than  $61 + 10 \log (P)$  dB on all frequencies between 2324 and 2328 MHz and on all frequencies between 2337 and 2341 MHz, and not less than  $67 + 10 \log (P)$  dB on all frequencies between 2328 and 2337 MHz;
- (ii) By a factor of not less than  $43 + 10 \log (P)$  dB on all frequencies between 2300 and 2305 MHz,  $55 + 10 \log (P)$  dB on all frequencies between 2296 and 2300 MHz,  $61 + 10 \log (P)$  dB on all frequencies between 2292 and 2296 MHz,  $67 + 10 \log (P)$  dB on all frequencies between 2288 and 2292 MHz, and  $70 + 10 \log (P)$  dB below 2288 MHz;
- (iii) By a factor of not less than  $43 + 10 \log (P)$  dB on all frequencies between 2360 and 2365 MHz, and not less than  $70 + 10 \log (P)$  dB above 2365 MHz.

### 4.4.2 TEST SETUP

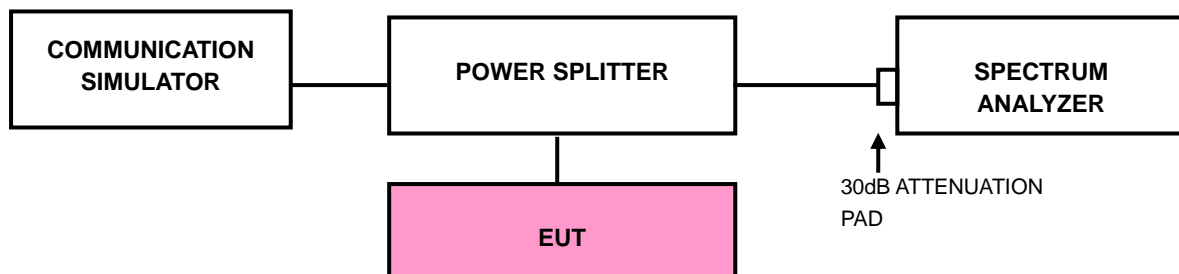

#### 4.4.3 TEST PROCEDURES

- a. The EUT was set up for the maximum peak power with LTE link data modulation. The power was measured with R&S Spectrum Analyzer. All measurements were done at 2 channels (low and high operational frequency range.).
- b. The band edge measurement used the power splitter via EUT RF power connector between simulation base station and spectrum analyzer.
- c. Measuring frequency range is from 2200MHz to 2395MHz for LTE Band 30. 10dB attenuation pad is connected with spectrum. RBW=1MHz and VBW=3MHz are used for conducted emission measurement.
- d. Record the max trace plot into the test report.



A D T

### 4.4.4 TEST RESULTS

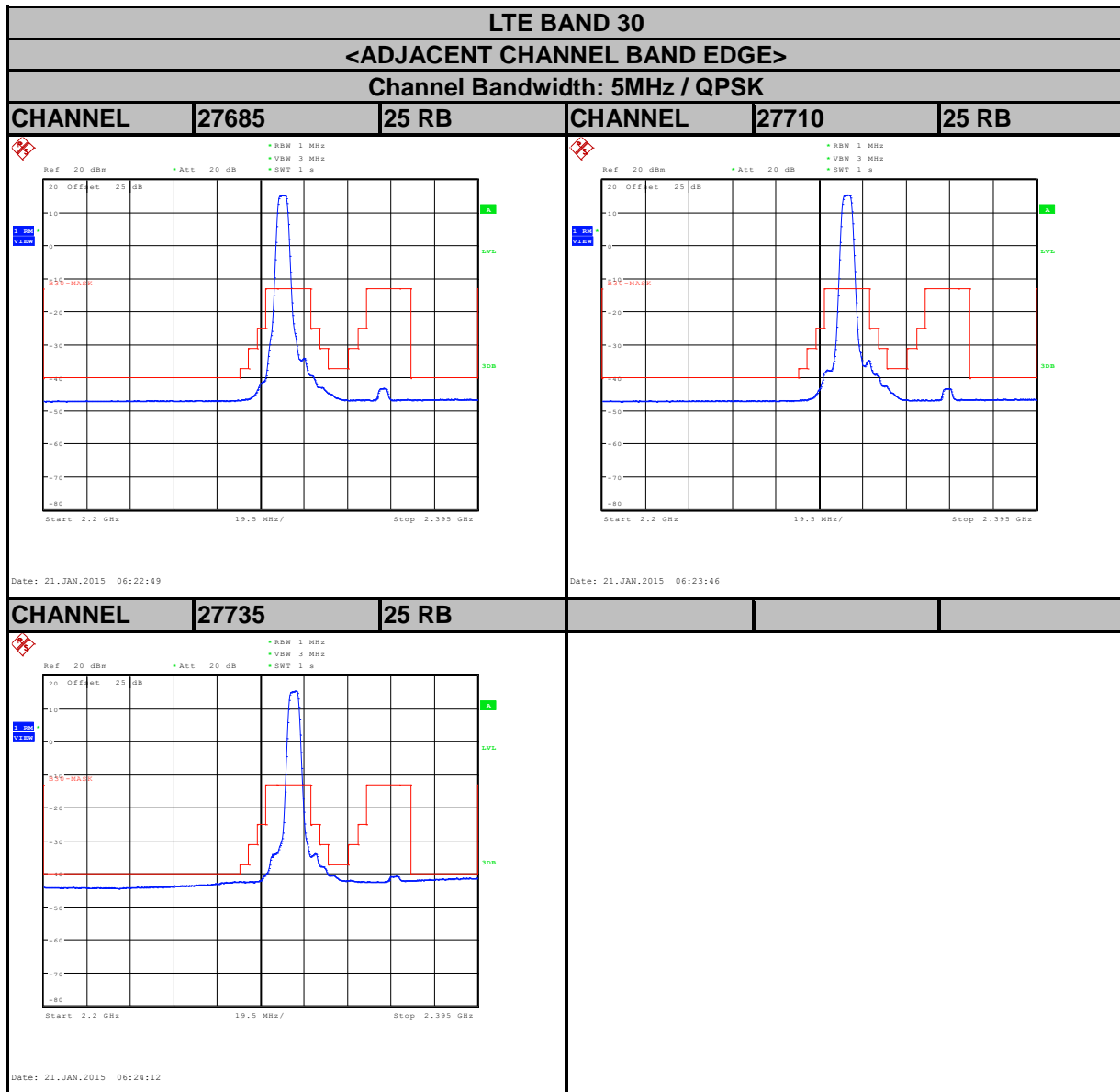



A D T

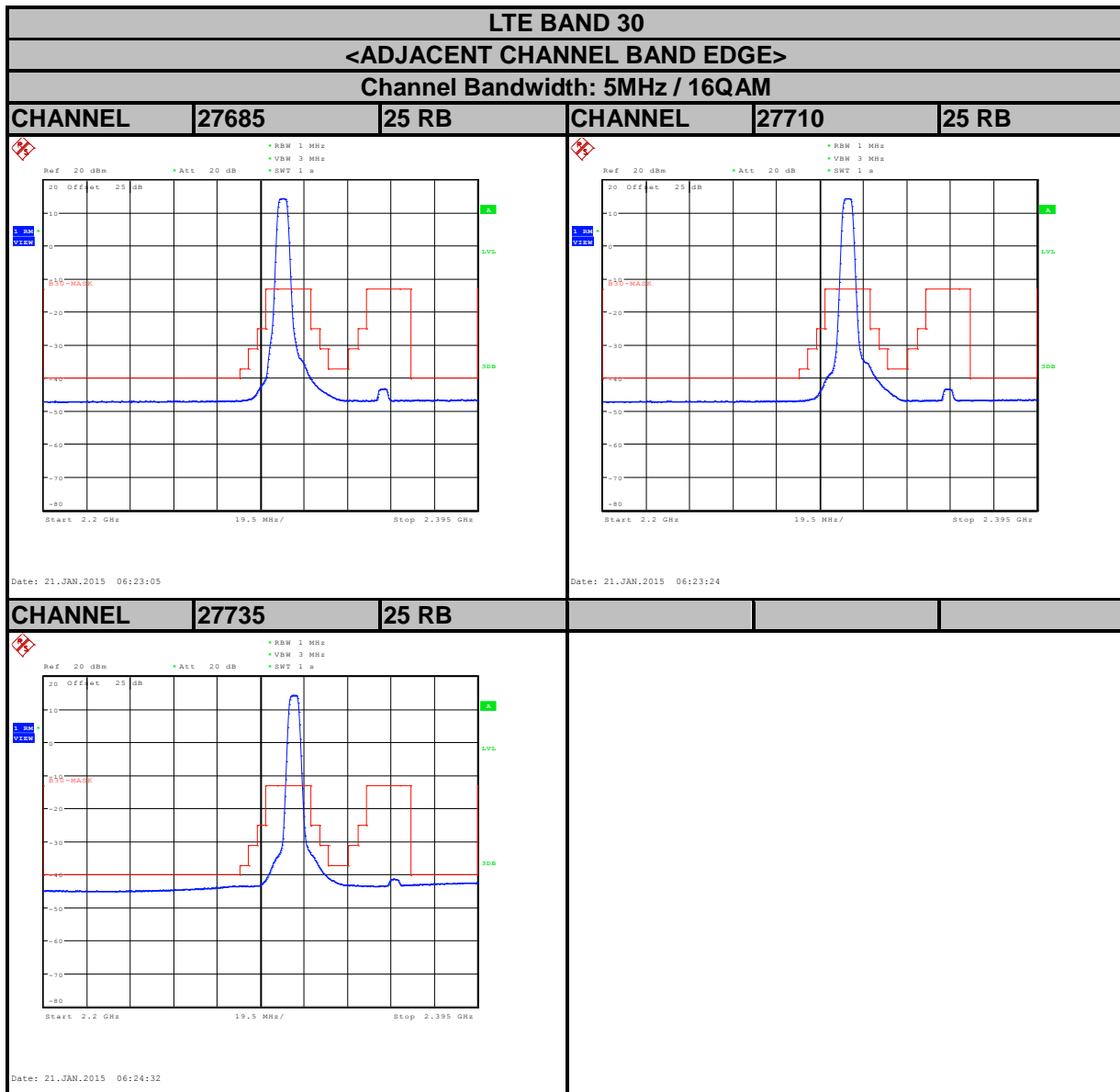



A D T

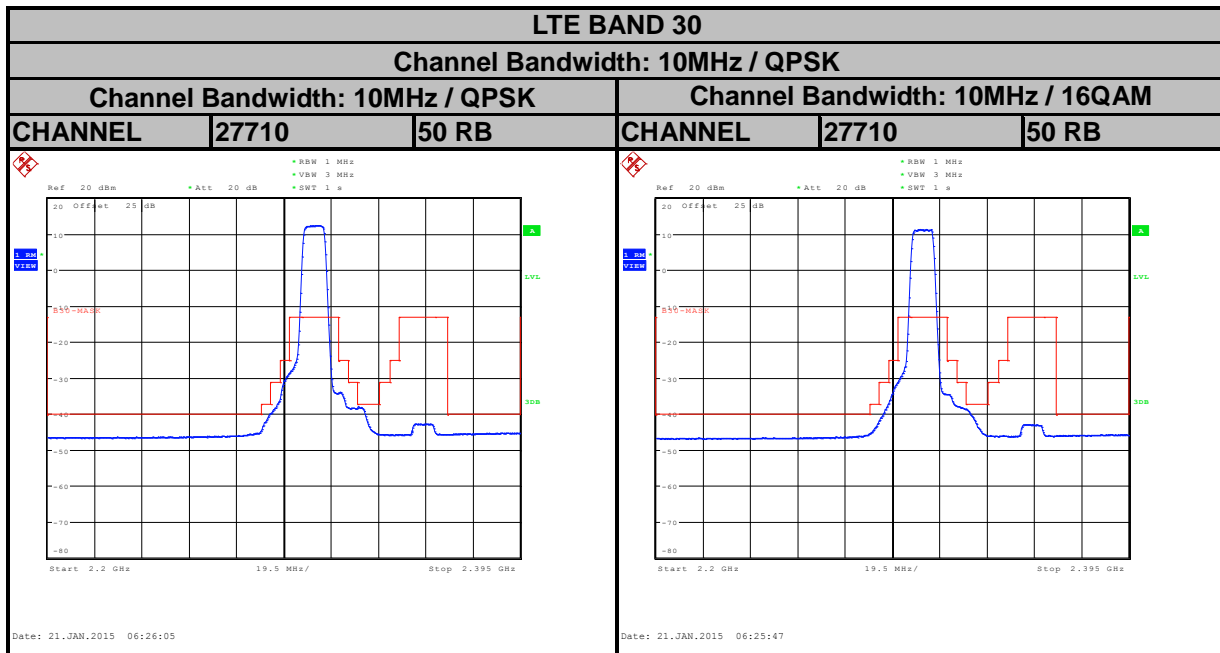

## 4.5 CONDUCTED SPURIOUS EMISSIONS

### 4.5.1 LIMITS OF CONDUCTED SPURIOUS EMISSIONS MEASUREMENT

The power of any emission outside a licensee's frequency block shall be attenuated below the transmitter power (P) by at least  $70 + 10 \log_{10}(P)$  dB. The limit of emission is equal to -40dBm.

### 4.5.2 TEST PROCEDURE

- a. The EUT makes a phone call to the communication simulator. All measurements were done at low, middle and high operational frequency range.
- b. Measuring frequency range is from 30MHz to 23.5GHz for LTE Band 30. 10dB attenuation pad is connected with spectrum. RBW=1MHz and VBW=3MHz are used for conducted emission measurement.

### 4.5.3 TEST SETUP

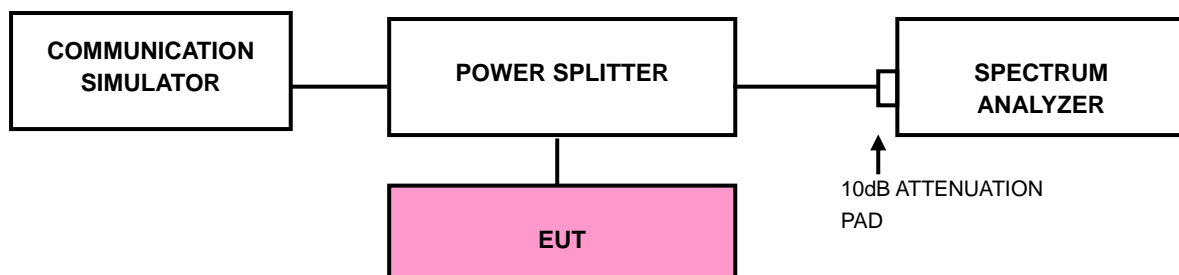



### 4.5.4 TEST RESULTS

FREQUENCY RANGE: 30MHz~23.5GHz

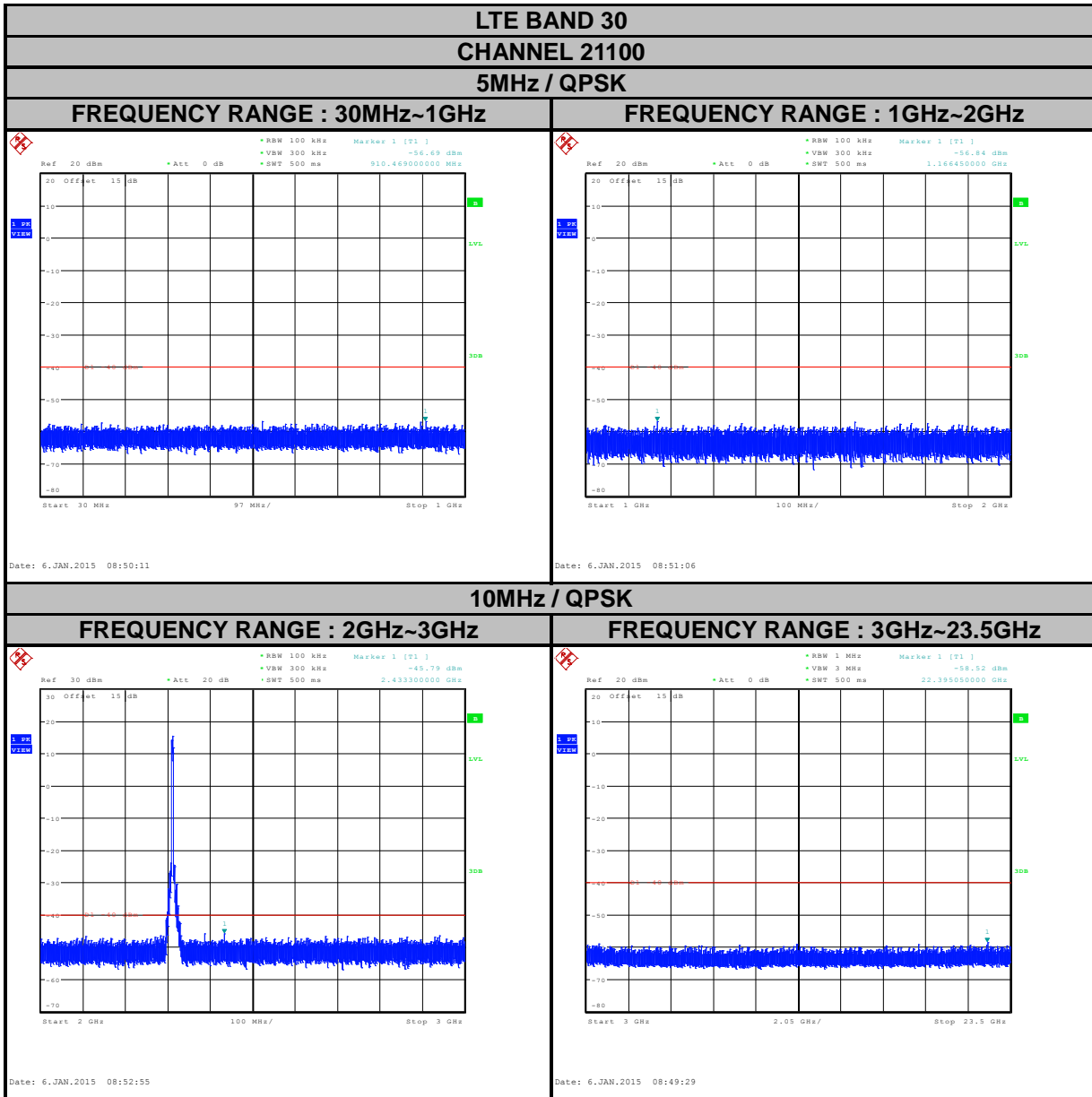



A D T

**LTE BAND 30**  
**CHANNEL 21100**  
**10MHz / QPSK**

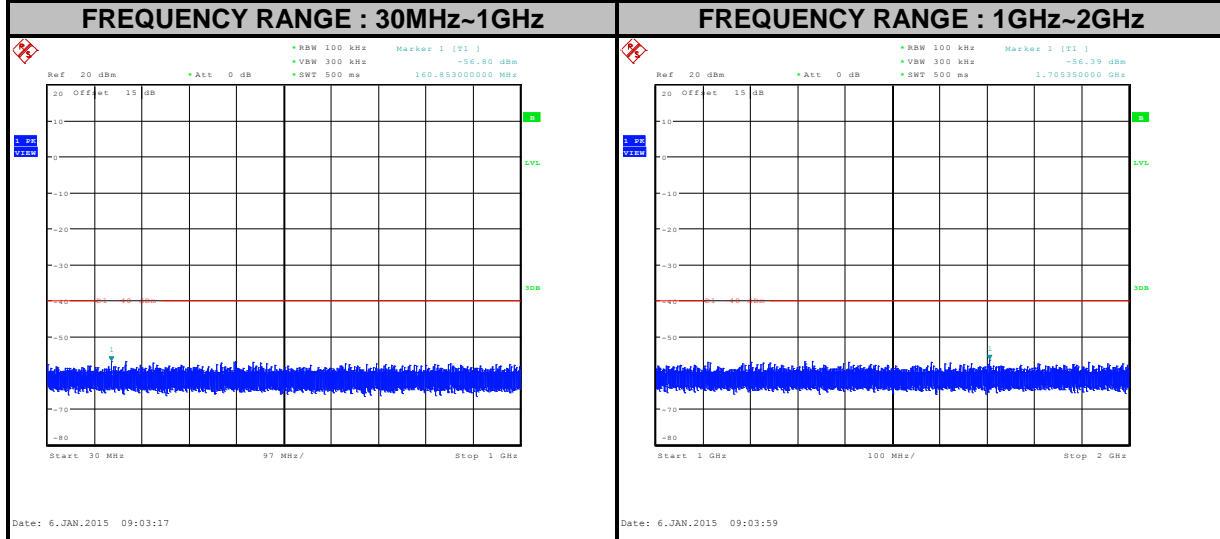

**10MHz / QPSK**

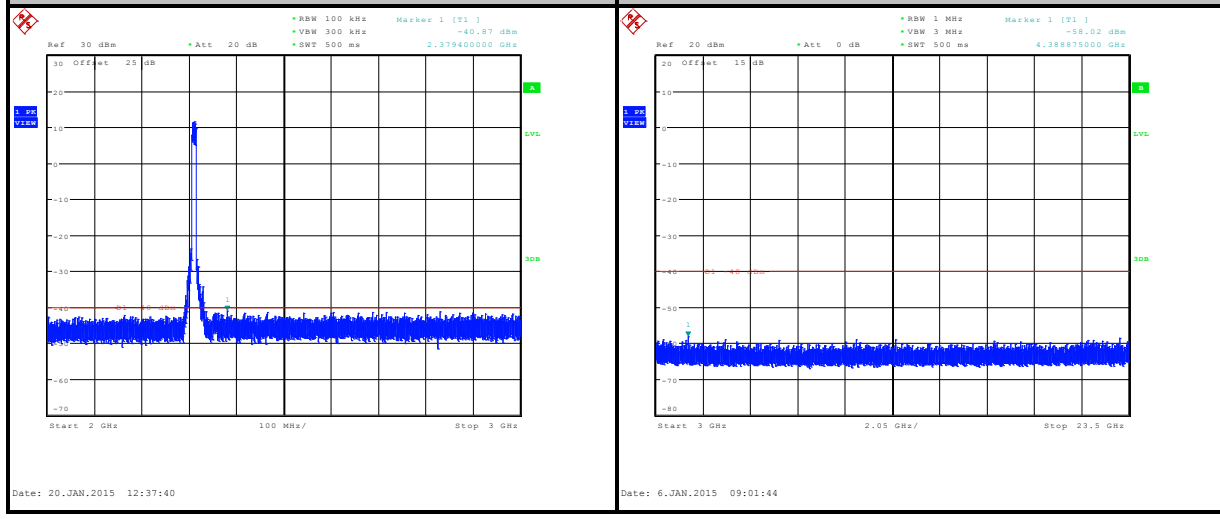

## 4.6 RADIATED EMISSION MEASUREMENT

### 4.6.1 LIMITS OF RADIATED EMISSION MEASUREMENT

The power of any emission outside a licensee's frequency block shall be attenuated below the transmitter power (P) by at least  $70 + 10 \log_{10}(P)$  dB. The limit of emission is equal to -40dBm.

### 4.6.2 TEST PROCEDURES

- a. Substitution method is used for E.I.R.P measurement. In the semi-anechoic chamber, EUT placed on the 0.8m height of Turn Table, rotated the table around 360 degrees to search the maximum radiation power and receiver antenna shall be rotated vertical and horizontal polarization and moved height from 1m to 4m to find the maximum polar radiated power. The "Read Value" is the spectrum reading the maximum power value.
- b. The substitution horn antenna is substituted for EUT at the same position and signals generator export the CW signal to the substitution antenna via a TX cable. Rotated the Turn Table and moved receiving antenna to find the maximum radiation power. Adjust output power level of S.G to get a Value of spectrum reading equal to "Read Value " of step a. Record the power level of S.G.
- c.  $EIRP = \text{Output power level of S.G} - \text{TX cable loss} + \text{Antenna gain of substitution horn}$ .
- d. E.R.P power can be calculated form E.I.R.P power by subtracting the gain of dipole,  $E.R.P \text{ power} = E.I.R.P \text{ power} - 2.15\text{dBi}$ .

**NOTE:** The resolution bandwidth of spectrum analyzer is 1 MHz and the video bandwidth is 3 MHz.

### 4.6.3 DEVIATION FROM TEST STANDARD

No deviation

#### 4.6.4 TEST SETUP

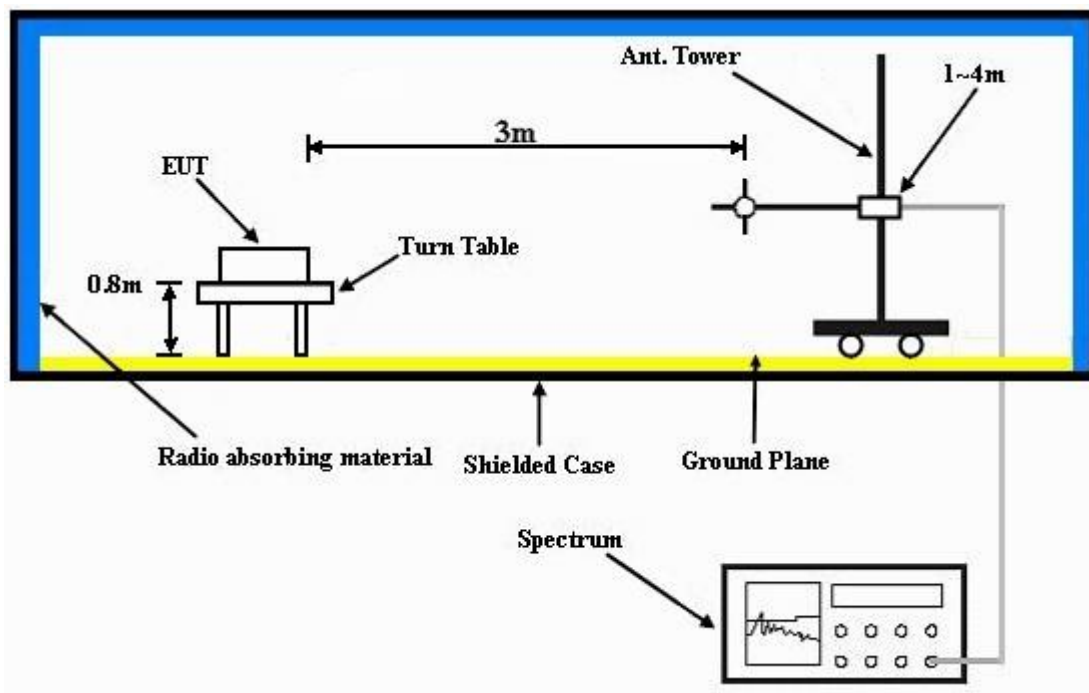

For the actual test configuration, please refer to the attached file (Test Setup Photo).

### 4.6.5 TEST RESULTS

LTE BAND 30

CHANNEL BANDWIDTH: 10MHz / QPSK



Bureau Veritas Consumer Products Services Ltd., Taoyuan Branch

A D T

Data: 13

Date: 2015-01-22

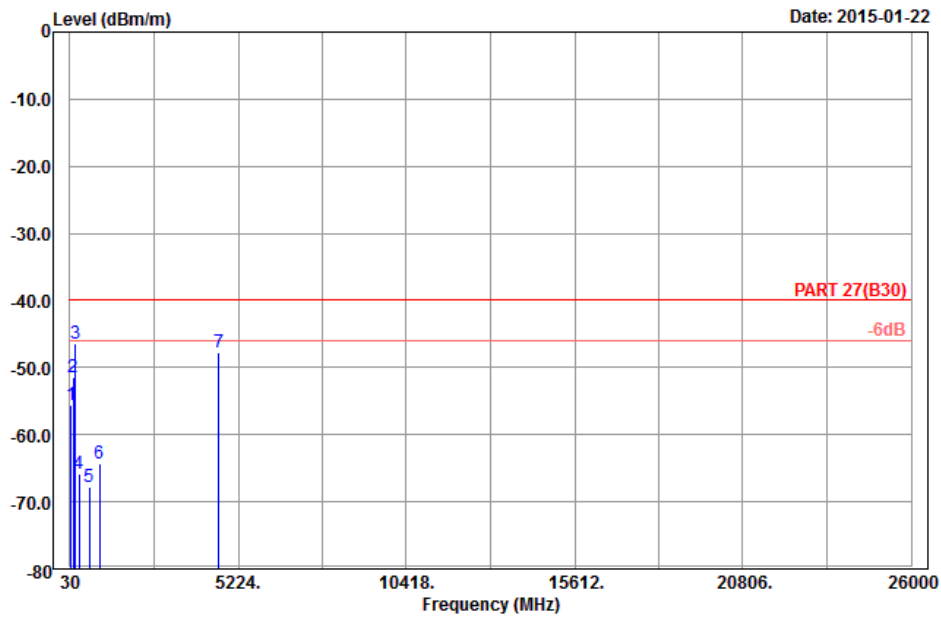

Site : 966 chamber 1  
 Condition: PART 27(B30) 3m Horizontal  
 Remark : LTE\_Band 30\_QPSK(1,49)\_10M\_CH27710  
 Tested by: Will Chen  
 Plane : Z

	Read	Limit	Over			
Freq	Level	Level	Line	Limit	Factor	Remark
MHz	dBm/m	dBm	dBm/m	dB	dB/m	
1	57.81 -55.60	-41.54	-40.00	-15.60	-14.06	Peak
2	129.90 -51.42	-43.77	-40.00	-11.42	-7.65	Peak
3 pp	188.22 -46.43	-40.73	-40.00	-6.43	-5.70	Peak
4	305.60 -65.85	-59.96	-40.00	-25.85	-5.89	Peak
5	620.60 -67.89	-68.09	-40.00	-27.89	0.20	Peak
6	941.20 -64.22	-68.93	-40.00	-24.22	4.71	Peak
7	4620.00 -47.76	-66.19	-40.00	-7.76	18.43	Peak



A D T



Bureau Veritas Consumer Products Services Ltd., Taoyuan Branch

A D T

Data: 14

Date: 2015-01-13

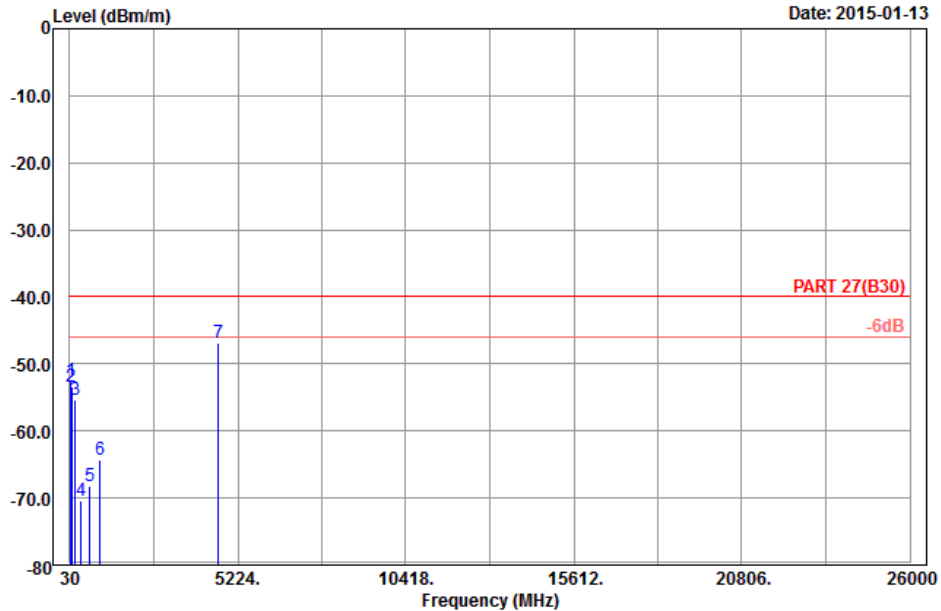

Site : 966 chamber 1  
 Condition: PART 27(B30) 3m Vertical  
 Remark : LTE\_Band 30\_QPSK(1,49)\_10M\_CH27710  
 Tested by: Will Chen  
 Plane : Z

	Freq	Level	Read Level	Limit	Over	Factor	Remark
	MHz	dBm/m	dBm	dBm/m	dB	dB/m	
1	56.46	-52.53	-38.47	-40.00	-12.53	-14.06	Peak
2	96.69	-53.49	-43.20	-40.00	-13.49	-10.29	Peak
3	188.49	-55.40	-49.70	-40.00	-15.40	-5.70	Peak
4	378.40	-70.38	-66.50	-40.00	-30.38	-3.88	Peak
5	659.80	-68.24	-68.06	-40.00	-28.24	-0.18	Peak
6	965.00	-64.34	-69.50	-40.00	-24.34	5.16	Peak
7 pp	4620.00	-46.96	-65.39	-40.00	-6.96	18.43	Peak



## 5 INFORMATION ON THE TESTING LABORATORIES

We, Bureau Veritas Consumer Products Services (H.K.) Ltd., Taoyuan Branch, were founded in 1988 to provide our best service in EMC, Radio, Telecom and Safety consultation. Our laboratories are accredited and approved according to ISO/IEC 17025.

If you have any comments, please feel free to contact us at the following:

**Linko EMC/RF Lab:**

Tel: 886-2-26052180

Fax: 886-2-26051924

**Hsin Chu EMC/RF/Telecom Lab:**

Tel: 886-3-5935343

Fax: 886-3-5935342

**Hwa Ya EMC/RF/Safety Lab:**

Tel: 886-3-3183232

Fax: 886-3-3270892

**Email:** [service.adt@tw.bureauveritas.com](mailto:service.adt@tw.bureauveritas.com)

**Web Site:** [www.adt.com.tw](http://www.adt.com.tw)

The address and road map of all our labs can be found in our web site also.



A D T

## **6 APPENDIX A – MODIFICATIONS RECORDERS FOR ENGINEERING CHANGES TO THE EUT BY THE LAB**

No modifications were made to the EUT by the lab during the test.

---END---