



FCC TEST REPORT (PART 22)

REPORT NO.: RF141203C08

MODEL NO.: 0PJA110

FCC ID: NM80PJA110

RECEIVED: Dec. 03, 2014

TESTED: Dec. 12, 2014 ~ Jan. 11, 2015

ISSUED: Jan. 22, 2015

APPLICANT: HTC Corporation

ADDRESS: 1F, 6-3 Baoqiang Road, Xindian District, New Taipei City, Taiwan 231

ISSUED BY: Bureau Veritas Consumer Products Services (H.K.) Ltd., Taoyuan Branch

LAB ADDRESS: No. 47-2, 14th Ling, Chia Pau Vil., Lin Kou Dist., New Taipei City, Taiwan (R.O.C.)

TEST LOCATION: No. 19, Hwa Ya 2nd Rd, Wen Hwa Tsuen, Kwei Shan Hsiang, Taoyuan Hsien 333, Taiwan, R.O.C.

This report should not be used by the client to claim product certification, approval, or endorsement by TAF or any government agencies.



This report is for your exclusive use. Any copying or replication of this report to or for any other person or entity, or use of our name or trademark, is permitted only with our prior written permission. This report sets forth our findings solely with respect to the test samples identified herein. The results set forth in this report are not indicative or representative of the quality or characteristics of the lot from which a test sample was taken or any similar or identical product unless specifically and expressly noted. Our report includes all of the tests requested by you and the results thereof based upon the information that you provided to us. You have 60 days from date of issuance of this report to notify us of any material error or omission caused by our negligence, provided, however, that such notice shall be in writing and shall specifically address the issue you wish to raise. A failure to raise such issue within the prescribed time shall constitute your unqualified acceptance of the completeness of this report, the tests conducted and the correctness of the report contents. Unless specific mention, the uncertainty of measurement has been explicitly taken into account to declare the compliance or non-compliance to the specification

TABLE OF CONTENTS

RELEASE CONTROL RECORD.....	3
1 CERTIFICATION	4
2 SUMMARY OF TEST RESULTS.....	5
2.1 MEASUREMENT UNCERTAINTY	5
2.2 TEST SITE AND INSTRUMENTS	6
3 GENERAL INFORMATION	7
3.1 GENERAL DESCRIPTION OF EUT	7
3.2 CONFIGURATION OF SYSTEM UNDER TEST	8
3.3 DESCRIPTION OF SUPPORT UNITS	8
3.4 TEST ITEM AND TEST CONFIGURATION	9
3.5 EUT OPERATING CONDITIONS	11
3.6 GENERAL DESCRIPTION OF APPLIED STANDARDS	11
4 TEST TYPES AND RESULTS.....	12
4.1 OUTPUT POWER MEASUREMENT	12
4.1.1 LIMITS OF OUTPUT POWER MEASUREMENT	12
4.1.2 TEST PROCEDURES	12
4.1.3 TEST SETUP	13
4.1.4 TEST RESULTS	14
4.2 FREQUENCY STABILITY MEASUREMENT	20
4.2.1 LIMITS OF FREQUENCY STABILITY MEASUREMENT	20
4.2.2 TEST PROCEDURE	20
4.2.3 TEST SETUP	20
4.2.4 TEST RESULTS	21
4.3 OCCUPIED BANDWIDTH MEASUREMENT	22
4.3.1 TEST PROCEDURES	22
4.3.2 TEST SETUP	22
4.3.3 TEST RESULTS	23
4.4 BAND EDGE MEASUREMENT	26
4.4.1 LIMITS OF BAND EDGE MEASUREMENT	26
4.4.2 TEST SETUP	26
4.4.3 TEST PROCEDURES	26
4.4.4 TEST RESULTS	27
4.5 CONDUCTED SPURIOUS EMISSIONS.....	32
4.5.1 LIMITS OF CONDUCTED SPURIOUS EMISSIONS MEASUREMENT.....	32
4.5.2 TEST PROCEDURE	32
4.5.3 TEST SETUP	32
4.5.4 TEST RESULTS	33
4.6 RADIATED EMISSION MEASUREMENT	35
4.6.1 LIMITS OF RADIATED EMISSION MEASUREMENT	35
4.6.2 TEST PROCEDURES	35
4.6.3 DEVIATION FROM TEST STANDARD	35
4.6.4 TEST SETUP	36
4.6.5 TEST RESULTS	37
5 PHOTOGRAPHS OF THE TEST CONFIGURATION	45
6 INFORMATION ON THE TESTING LABORATORIES	46
7 APPENDIX A – MODIFICATIONS RECORDERS FOR ENGINEERING CHANGES TO THE EUT BY THE LAB.....	47



A D T

RELEASE CONTROL RECORD

ISSUE NO.	REASON FOR CHANGE	DATE ISSUED
RF141203C08	Original release	Jan. 22, 2015



1 CERTIFICATION

PRODUCT: Smartphone

MODEL: OPJA110

BRAND: HTC

APPLICANT: HTC Corporation

TESTED: Dec. 12, 2014 ~ Jan. 11, 2015

TEST SAMPLE: Production Unit

STANDARDS: FCC PART 22, Subpart H

The above equipment (model: OPJA110) has been tested by **Bureau Veritas Consumer Products Services (H.K.) Ltd., Taoyuan Branch**, and found compliance with the requirement of the above standards. The test record, data evaluation & Equipment Under Test (EUT) configurations represented herein are true and accurate accounts of the measurements of the sample's EMC characteristics under the conditions specified in this report.

PREPARED BY : Ivonne Wu , **DATE** : Jan. 22, 2015
Ivonne Wu / Supervisor

APPROVED BY : Sam Chen , **DATE** : Jan. 22, 2015
Sam Chen / Senior Project Engineer

2 SUMMARY OF TEST RESULTS

The EUT has been tested according to the following specifications:

APPLIED STANDARD: FCC Part 22 & Part 2			
STANDARD SECTION	TEST TYPE	RESULT	REMARK
2.1046 22.913 (a)	Effective Radiated Power	PASS	Meet the requirement of limit.
2.1055 22.355	Frequency Stability	PASS	Meet the requirement of limit.
2.1049	Occupied Bandwidth	PASS	Meet the requirement of limit.
22.917	Band Edge Measurements	PASS	Meet the requirement of limit.
2.1051 22.917	Conducted Spurious Emissions	PASS	Meet the requirement of limit.
2.1053 22.917	Radiated Spurious Emissions	PASS	Meet the requirement of limit. Minimum passing margin is -32.25dB at 192.54MHz.

2.1 MEASUREMENT UNCERTAINTY

Where relevant, the following measurement uncertainty levels have been estimated for tests performed on the EUT as specified in CISPR 16-4-2:

MEASUREMENT	FREQUENCY	UNCERTAINTY
Conducted emissions	9kHz~30MHz	2.44 dB
Radiated emissions	30MHz ~ 200MHz	2.93 dB
	200MHz ~1000MHz	2.95 dB
	1GHz ~ 18GHz	2.26 dB
	18GHz ~ 40GHz	1.94 dB

This uncertainty represents an expanded uncertainty expressed at approximately the 95% confidence level using a coverage factor of k=2.

2.2 TEST SITE AND INSTRUMENTS

DESCRIPTION & MANUFACTURER	MODEL NO.	SERIAL NO.	DATE OF CALIBRATION	DUE DATE OF CALIBRATION
Test Receiver ROHDE & SCHWARZ	ESCI	100744	Apr. 15, 2014	Apr. 14, 2015
Spectrum Analyzer ROHDE & SCHWARZ	FSU43	101261	Dec. 10, 2014	Dec. 09, 2015
BILOG Antenna SCHWARZBECK	VULB9168	9168-472	Feb. 27, 2014	Feb. 26, 2015
HORN Antenna SCHWARZBECK	BBHA 9120 D	9120D-969	Feb. 19, 2014	Feb. 18, 2015
HORN Antenna SCHWARZBECK	BBHA 9170	9170-480	Aug. 27, 2014	Aug. 26, 2015
Preamplifier EMCI	EMC 012645	980115	Dec. 12, 2014	Dec. 11, 2015
Preamplifier EMCI	EMC 184045	980116	Jan. 13, 2014	Jan. 12, 2015
Preamplifier EMCI	EMC 330H	980071	Feb. 27, 2014	Feb. 26, 2015
RF signal cable HUBER+SUHNNER	SUCOFLEX 104	309219/4 2950114	Oct. 18, 2014	Oct. 17, 2015
RF signal cable HUBER+SUHNNER	SUCOFLEX 104	250130/4	Oct. 18, 2014	Oct. 17, 2015
RF signal cable Woken	RG-213	NA	Nov. 07, 2014	Nov. 06, 2015
Software BV ADT	E3 6.120103	NA	NA	NA
Antenna Tower MF	MFA-440H	NA	NA	NA
Turn Table MF	MFT-201SS	NA	NA	NA
Antenna Tower & Turn Table Controller MF	MF-7802	NA	NA	NA
Power Splitter Woken	2-18GHz 2Way SMA Fwd.:30W/Rev.:2W Isolated Power	COM412W5E3	Apr. 17, 2014	Apr. 16, 2015
JFW 20dB attenuation	50HF-020-SMA	NA	NA	NA
Communications Tester-Wireless	E5515C	MY52102544	Sep. 11, 2014	Sep. 10, 2016
Radio Communication Analyzer	MT8820C	6201300640	Aug. 01, 2013	Jul. 31, 2015

- NOTE:**
1. The calibration interval of the above test instruments is 12 / 24 months and the calibrations are traceable to NML/ROC and NIST/USA.
 2. The test was performed in HwaYa Chamber 10.
 3. The horn antenna and HP preamplifier (model: 8449B) are used only for the measurement of emission frequency above 1GHz if tested.
 4. The FCC Site Registration No. is 690701.
 5. The IC Site Registration No. is IC 7450F-10.

3 GENERAL INFORMATION

3.1 GENERAL DESCRIPTION OF EUT

EUT	Smartphone	
MODEL NO.	0PJA110	
POWER SUPPLY	5.0Vdc (adapter or host equipment) 3.83Vdc (battery)	
MODULATION TYPE	GSM/GPRS	GMSK
	EDGE	GMSK, 8PSK
	WCDMA	BPSK
	LTE	QPSK, 16QAM
FREQUENCY RANGE	GSM/GPRS/EDGE	824.2MHz ~ 848.8MHz
	WCDMA	826.4MHz ~ 846.6MHz
	LTE 5 (Channel Bandwidth: 1.4MHz)	824.7MHz ~ 848.3MHz
	LTE 5 (Channel Bandwidth: 3MHz)	825.5MHz ~ 847.5MHz
	LTE 5 (Channel Bandwidth: 5MHz)	826.5MHz ~ 846.5MHz
	LTE 5 (Channel Bandwidth: 10MHz)	829MHz ~ 844MHz
MAX. ERP POWER	GSM	827.56mW
	EDGE	229.19mW
	WCDMA	115.29mW
	LTE 5 (Channel Bandwidth: 1.4MHz)	79.80mW
	LTE 5 (Channel Bandwidth: 3MHz)	81.25mW
	LTE 5 (Channel Bandwidth: 5MHz)	76.59mW
	LTE 5 (Channel Bandwidth: 10MHz)	97.68mW
EMISSION DESIGNATOR	GSM	247KGXW
	EDGE	246KG7W
	WCDMA	4M15F9W
	LTE 5 (Channel Bandwidth: 1.4MHz)	1M09G7D
	LTE 5 (Channel Bandwidth: 3MHz)	2M70G7D
	LTE 5 (Channel Bandwidth: 5MHz)	4M49G7D
	LTE 5 (Channel Bandwidth: 10MHz)	8M97W7D
ANTENNA TYPE	Fixed Internal Antenna	
I/O PORTS	Refer to users' manual	
DATA CABLE	Refer to NOTE as below	
ACCESSORY DEVICES	Refer to NOTE as below	

NOTE:

1. The EUT's accessories list refers to Ext. Pho.
2. The above EUT information was declared by manufacturer and for more detailed features description, please refer to the manufacturer's specifications or User's Manual.

3.2 CONFIGURATION OF SYSTEM UNDER TEST

FOR RADIATION EMISSION TEST

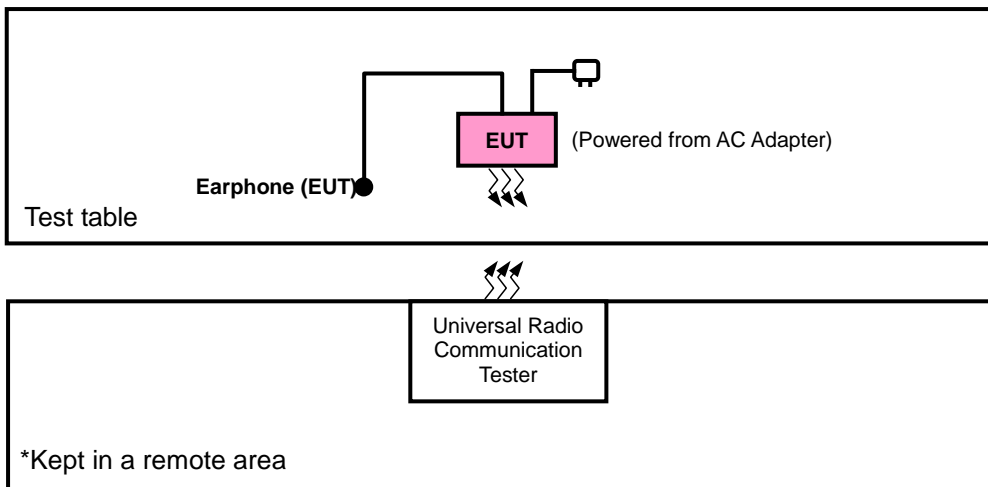

FOR E.R.P. TEST

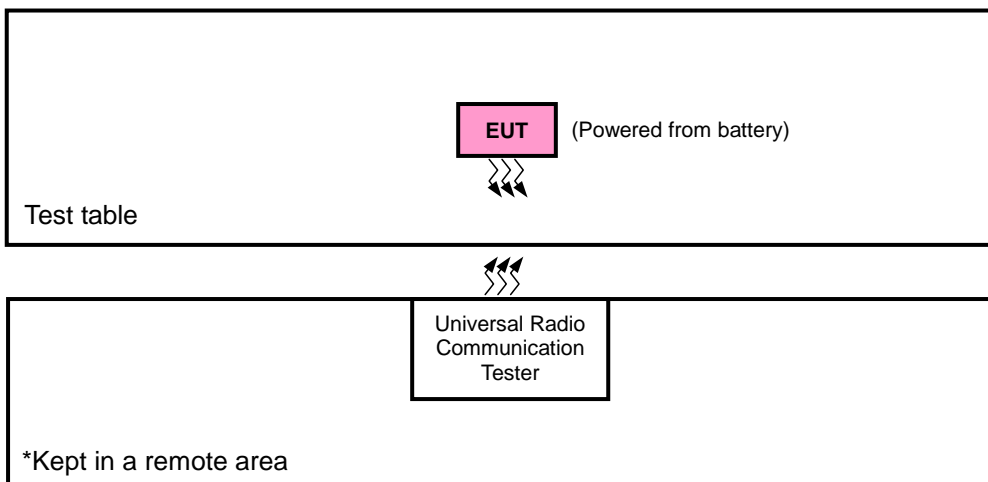

3.3 DESCRIPTION OF SUPPORT UNITS

The EUT has been tested as an independent unit together with other necessary accessories or support units.

3.4 TEST ITEM AND TEST CONFIGURATION

Pre-Scan has been conducted to determine the worst-case mode from all possible combinations between available modulations, data rates, XYZ axis and antenna ports. The worst case was found when positioned on X-plane for ERP, and Y-axis for GSM/EDGE/WCDMA and Z-axis for LTE for radiated emission for antenna 0. Following channel(s) was (were) selected for the final test as listed below:

GSM MODE

EUT CONFIGURE MODE	TEST ITEM	AVAILABLE CHANNEL	TESTED CHANNEL	MODE
-	ERP	128 to 251	128, 189, 251	GSM, EDGE
-	FREQUENCY STABILITY	128 to 251	189	GSM, EDGE
-	OCCUPIED BANDWIDTH	128 to 251	128, 189, 251	GSM, EDGE
-	BAND EDGE	128 to 251	128, 251	GSM, EDGE
-	CONDUCTED EMISSION	128 to 251	189	GSM, EDGE
-	RADIATED EMISSION	128 to 251	189	GSM, EDGE

WCDMA MODE

EUT CONFIGURE MODE	TEST ITEM	AVAILABLE CHANNEL	TESTED CHANNEL	MODE
-	ERP	4132 to 4233	4132, 4182, 4233	WCDMA
-	FREQUENCY STABILITY	4132 to 4233	4182	WCDMA
-	OCCUPIED BANDWIDTH	4132 to 4233	4132, 4182, 4233	WCDMA
-	BAND EDGE	4132 to 4233	4132, 4233	WCDMA
-	CONDUCTED EMISSION	4132 to 4233	4182	WCDMA
-	RADIATED EMISSION	4132 to 4233	4182	WCDMA



A D T

LTE BAND 5 MODE

EUT CONFIGURE MODE	TEST ITEM	AVAILABLE CHANNEL	TESTED CHANNEL	CHANNEL BANDWIDTH	MODULATION	MODE		
-	ERP	20407 to 20643	20407, 20525, 20643	1.4MHz	QPSK, 16QAM	1 RB / 5 RB Offset		
		20415 to 20635	20415, 20525, 20635	3MHz	QPSK, 16QAM	1 RB / 14 RB Offset		
		20425 to 20625	20425, 20525, 20625	5MHz	QPSK, 16QAM	1 RB / 24 RB Offset		
		20450 to 20600	20450, 20525, 20600	10MHz	QPSK, 16QAM	1 RB / 49 RB Offset		
-	FREQUENCY STABILITY	20407 to 20643	20525	1.4MHz	QPSK	1 RB / 5 RB Offset		
		20415 to 20635	20525	3MHz	QPSK	1 RB / 14 RB Offset		
		20425 to 20625	20525	5MHz	QPSK	1 RB / 24 RB Offset		
		20450 to 20600	20525	10MHz	QPSK	1 RB / 49 RB Offset		
-	OCCUPIED BANDWIDTH	20407 to 20643	20407, 20525, 20643	1.4MHz	QPSK, 16QAM	6 RB / 0 RB Offset		
		20415 to 20635	20415, 20525, 20635	3MHz	QPSK, 16QAM	15 RB / 0 RB Offset		
		20425 to 20625	20425, 20525, 20625	5MHz	QPSK, 16QAM	25 RB / 0 RB Offset		
		20450 to 20600	20450, 20525, 20600	10MHz	QPSK, 16QAM	50 RB / 0 RB Offset		
-	BAND EDGE	20407 to 20643	20407	1.4MHz	QPSK	1 RB / 0 RB Offset		
			20643	1.4MHz	QPSK	6 RB / 0 RB Offset		
		20415 to 20635	20415	3MHz	QPSK	1 RB / 0 RB Offset		
			20635	3MHz	QPSK	15 RB / 0 RB Offset		
		20425 to 20625	20425	5MHz	QPSK	1 RB / 0 RB Offset		
			20600	5MHz	QPSK	25 RB / 0 RB Offset		
		20450 to 20600	20450	10MHz	QPSK	1 RB / 24 RB Offset		
			20600	10MHz	QPSK	50 RB / 0 RB Offset		
		-	CONDUCTED EMISSION	20407 to 20643	20525	1.4MHz	QPSK	1 RB / 2 RB Offset
				20415 to 20635	20525	3MHz	QPSK	1 RB / 7 RB Offset
				20425 to 20625	20525	5MHz	QPSK	1 RB / 12 RB Offset
				20450 to 20600	20525	10MHz	QPSK	1 RB / 24 RB Offset
-	RADIATED EMISSION	20450 to 20600	20525	10MHz	QPSK	1 RB / 24 RB Offset		

Note: This device was tested under all bandwidths, RB configurations and modulations. The worst case was found in QPSK modulation.



TEST CONDITION:

TEST ITEM	ENVIRONMENTAL CONDITIONS	INPUT POWER	TESTED BY
ERP	26deg. C, 58%RH	3.82Vdc	Hwa Chiang
FREQUENCY STABILITY	26deg. C, 58%RH	3.82Vdc	Luke Chen
OCCUPIED BANDWIDTH	26deg. C, 58%RH	3.82Vdc	Luke Chen
BAND EDGE	26deg. C, 58%RH	3.82Vdc	Luke Chen
CONDUCTED EMISSION	26deg. C, 58%RH	3.82Vdc	Luke Chen
RADIATED EMISSION	25deg. C, 65%RH	120Vac, 60Hz	Hwa Chiang / Karl Lee

3.5 EUT OPERATING CONDITIONS

The EUT makes a call to the communication simulator. The communication simulator station system controlled a EUT to export maximum output power under transmission mode and specific channel frequency

3.6 GENERAL DESCRIPTION OF APPLIED STANDARDS

The EUT is a RF product. According to the specifications of the manufacturer, it must comply with the requirements of the following standards:

FCC 47 CFR Part 2

FCC 47 CFR Part 22

ANSI/TIA/EIA-603-C 2004

NOTE: All test items have been performed and recorded as per the above standards.



A D T

4 TEST TYPES AND RESULTS

4.1 OUTPUT POWER MEASUREMENT

4.1.1 LIMITS OF OUTPUT POWER MEASUREMENT

Mobile / Portable station are limited to 7 watts e.r.p.

4.1.2 TEST PROCEDURES

EIRP / ERP MEASUREMENT:

- a. All measurements were done at low, middle and high operational frequency range. RBW and VBW is 1MHz for GSM, GPRS & EDGE, 5MHz for WCDMA, and 10MHz for LTE mode.
- b. Substitution method is used for E.I.R.P measurement. In the semi-anechoic chamber, EUT placed on the 0.8m height of Turn Table, rotated the table around 360 degrees to search the maximum radiation power and receiver antenna shall be rotated vertical and horizontal polarization and moved height from 1m to 4m to find the maximum polar radiated power. The "Read Value" is the spectrum reading the maximum power value.
- c. The substitution horn antenna is substituted for EUT at the same position and signals generator export the CW signal to the substitution antenna via a tx cable. Rotated the Turn Table and moved receiving antenna to find the maximum radiation power. Adjust output power level of S.G to get a Value of spectrum reading equal to "Read Value" of step b. Record the power level of S.G
- d. $EIRP = \text{Output power level of S.G} - \text{TX cable loss} + \text{Antenna gain of substitution horn}$. E.R.P power can be calculated form E.I.R.P power by subtracting the gain of dipole, $E.R.P \text{ power} = E.I.R.P \text{ power} - 2.15\text{dBi}$.

CONDUCTED POWER MEASUREMENT:

The EUT was set up for the maximum power with GSM, GPRS, EDGE, WCDMA & LTE link data modulation and link up with simulator. Set the EUT to transmit under low, middle and high channel and record the power level shown on simulator.

4.1.3 TEST SETUP

EIRP / ERP MEASUREMENT:

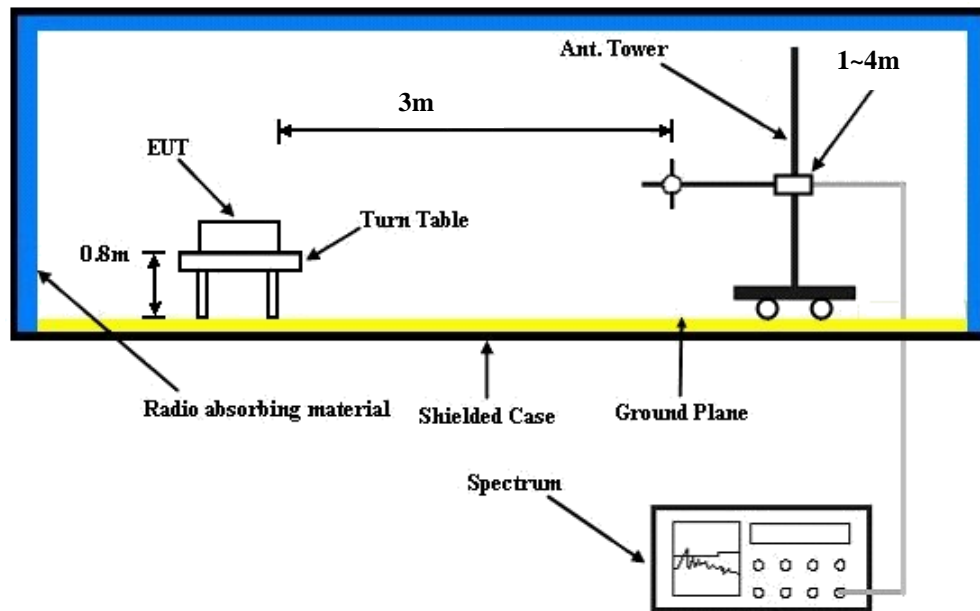

CONDUCTED POWER MEASUREMENT:

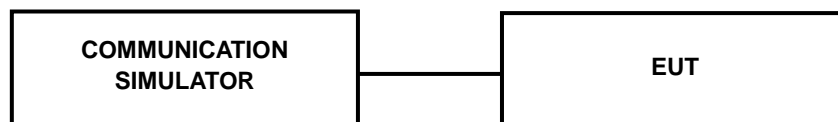



A D T

4.1.4 TEST RESULTS

CONDUCTED OUTPUT POWER (dBm)

Band	GSM850		
Channel	128	189	251
Frequency (MHz)	824.2	836.4	848.8
GSM (GMSK, 1Tx-slot)	33.85	33.76	33.75
GPRS (GMSK, 1Tx-slot)	33.84	33.75	33.74
GPRS (GMSK, 2Tx-slot)	33.79	33.70	33.69
EDGE (8PSK, 1Tx-slot)	27.55	27.58	27.63
EDGE (8PSK, 2Tx-slot)	27.42	27.45	27.50

Band	WCDMA V		
Channel	4132	4182	4233
Frequency (MHz)	826.4	836.4	846.6
RMC 12.2K	24.75	24.87	24.71
HSDPA Subtest-1	23.80	23.82	23.58
HSDPA Subtest-2	23.79	23.81	23.57
HSDPA Subtest-3	23.29	23.31	23.07
HSDPA Subtest-4	23.31	23.33	23.09
HSUPA Subtest-1	23.63	23.65	23.41
HSUPA Subtest-2	22.59	22.61	22.37
HSUPA Subtest-3	22.44	22.46	22.22
HSUPA Subtest-4	22.59	22.61	22.37
HSUPA Subtest-5	23.75	23.77	23.53



A D T

Band / BW	RB Size	RB Offset	QPSK			3GPP MPR (dB)	16QAM			3GPP MPR (dB)
			Low CH 20407	Mid CH 20525	High CH 20643		Low CH 20407	Mid CH 20525	High CH 20643	
			824.7 MHz	836.5 MHz	848.3 MHz		824.7 MHz	836.5 MHz	848.3 MHz	
5 / 1.4M	1	0	23.28	23.43	23.78	0	22.28	22.43	22.78	1
	1	2	23.56	23.71	24.06	0	22.56	22.71	23.06	1
	1	5	23.64	23.79	24.14	0	22.64	22.79	23.14	1
	3	0	22.28	22.43	22.78	0	21.28	21.43	21.78	1
	3	1	22.56	22.71	23.06	0	21.56	21.71	22.06	1
	3	3	22.64	22.79	23.14	0	21.64	21.79	22.14	1
	6	0	22.58	22.76	23.06	1	21.58	21.76	22.06	2

Band / BW	RB Size	RB Offset	QPSK			3GPP MPR (dB)	16QAM			3GPP MPR (dB)
			Low CH 20415	Mid CH 20525	High CH 20635		Low CH 20415	Mid CH 20525	High CH 20635	
			825.5 MHz	836.5 MHz	847.5 MHz		825.5 MHz	836.5 MHz	847.5 MHz	
5 / 3M	1	0	23.30	23.45	23.80	0	22.30	22.45	22.80	1
	1	7	23.58	23.73	24.08	0	22.58	22.73	23.08	1
	1	14	23.66	23.81	24.16	0	22.66	22.81	23.16	1
	8	0	22.30	22.45	22.80	1	21.30	21.45	21.80	2
	8	3	22.58	22.73	23.08	1	21.58	21.73	22.08	2
	8	7	22.66	22.81	23.16	1	21.66	21.81	22.16	2
	15	0	22.60	22.78	23.08	1	21.60	21.78	22.08	2

Band / BW	RB Size	RB Offset	QPSK			3GPP MPR (dB)	16QAM			3GPP MPR (dB)
			Low CH 20425	Mid CH 20525	High CH 20625		Low CH 20425	Mid CH 20525	High CH 20625	
			826.5 MHz	836.5 MHz	846.5 MHz		826.5 MHz	836.5 MHz	846.5 MHz	
5 / 5M	1	0	23.32	23.47	23.82	0	22.32	22.47	22.82	1
	1	12	23.60	23.75	24.10	0	22.60	22.75	23.10	1
	1	24	23.68	23.83	24.18	0	22.68	22.83	23.18	1
	12	0	22.32	22.47	22.82	1	21.32	21.47	21.82	2
	12	6	22.60	22.75	23.10	1	21.60	21.75	22.10	2
	12	13	22.68	22.83	23.18	1	21.68	21.83	22.18	2
	25	0	22.62	22.80	23.10	1	21.62	21.80	22.10	2

Band / BW	RB Size	RB Offset	QPSK			3GPP MPR (dB)	16QAM			3GPP MPR (dB)
			Low CH 20450	Mid CH 20525	High CH 20600		Low CH 20450	Mid CH 20525	High CH 20600	
			829.0 MHz	836.5 MHz	844.0 MHz		829.0 MHz	836.5 MHz	844.0 MHz	
5 / 10M	1	0	24.32	24.47	24.82	0	23.32	23.47	23.82	1
	1	24	24.60	24.75	25.10	0	23.60	23.75	24.10	1
	1	49	24.68	24.83	25.18	0	23.68	23.83	24.18	1
	25	0	23.32	23.47	23.82	1	22.32	22.47	22.82	2
	25	12	23.60	23.75	24.10	1	22.60	22.75	23.10	2
	25	25	23.68	23.83	24.18	1	22.68	22.83	23.18	2
	50	0	23.62	23.80	24.10	1	22.62	22.80	23.10	2



A D T

ERP POWER (dBm)

GSM							
Plane	Channel	Frequency (MHz)	LVL (dBm)	Correction Factor(dB)	ERP(dBm)	ERP(mW)	Polarization (H/V)
X	128	824.2	0.12	31.208	29.18	827.56	H
	189	836.4	-0.36	31.3	28.79	756.83	H
	251	848.8	0.10	31.222	29.17	826.42	H
	128	824.2	-7.72	31.504	21.63	145.68	V
	189	836.4	-7.74	31.117	21.23	132.65	V
	251	848.8	-7.82	31.922	21.95	156.75	V

EDGE							
Plane	Channel	Frequency (MHz)	LVL (dBm)	Correction Factor(dB)	ERP(dBm)	ERP(mW)	Polarization (H/V)
X	128	824.2	-5.88	31.208	23.18	207.87	H
	189	836.4	-5.76	31.3	23.39	218.27	H
	251	848.8	-5.47	31.222	23.60	229.19	H
	128	824.2	-12.69	31.504	16.66	46.39	V
	189	836.4	-12.21	31.117	16.76	47.39	V
	251	848.8	-12.95	31.922	16.82	48.11	V

WCDMA							
Plane	Channel	Frequency (MHz)	LVL (dBm)	Correction Factor(dB)	ERP(dBm)	ERP(mW)	Polarization (H/V)
X	4132	826.4	-8.44	31.208	20.62	115.29	H
	4182	836.4	-8.60	31.3	20.55	113.50	H
	4233	846.6	-8.59	31.222	20.48	111.74	H
	4132	826.4	-15.77	31.504	13.58	22.82	V
	4182	836.4	-15.07	31.117	13.90	24.53	V
	4233	846.6	-15.84	31.922	13.93	24.73	V



A D T

LTE Band 5							
Channel Bandwidth: 1.4MHz / QPSK							
Plane	Channel	Frequency (MHz)	LVL (dBm)	Correction Factor(dB)	ERP(dBm)	ERP(mW)	Polarization (H/V)
X	20407	824.7	-10.46	31.208	18.60	72.41	H
	20525	836.5	-10.13	31.3	19.02	79.80	H
	20643	848.3	-10.47	31.222	18.60	72.48	H
	20407	824.7	-18.26	31.504	11.09	12.86	V
	20525	836.5	-17.44	31.117	11.53	14.21	V
	20643	848.3	-18.45	31.922	11.32	13.56	V

LTE Band 5							
Channel Bandwidth: 1.4MHz / 16QAM							
Plane	Channel	Frequency (MHz)	LVL (dBm)	Correction Factor(dB)	ERP(dBm)	ERP(mW)	Polarization (H/V)
X	20407	824.7	-10.73	31.208	18.33	68.05	H
	20525	836.5	-10.82	31.3	18.33	68.08	H
	20643	848.3	-10.76	31.222	18.31	67.80	H
	20407	824.7	-18.70	31.504	10.65	11.63	V
	20525	836.5	-18.20	31.117	10.77	11.93	V
	20643	848.3	-18.59	31.922	11.18	13.13	V

LTE Band 5							
Channel Bandwidth: 3MHz / QPSK							
Plane	Channel	Frequency (MHz)	LVL (dBm)	Correction Factor(dB)	ERP(dBm)	ERP(mW)	Polarization (H/V)
X	20415	825.5	-9.96	31.208	19.10	81.25	H
	20525	836.5	-10.32	31.3	18.83	76.38	H
	20635	847.5	-10.12	31.222	18.95	78.56	H
	20415	825.5	-18.15	31.504	11.20	13.19	V
	20525	836.5	-17.96	31.117	11.01	12.61	V
	20635	847.5	-17.80	31.922	11.97	15.75	V



LTE Band 5							
Channel Bandwidth: 3MHz / 16QAM							
Plane	Channel	Frequency (MHz)	LVL (dBm)	Correction Factor(dB)	ERP(dBm)	ERP(mW)	Polarization (H/V)
X	20415	825.5	-10.77	31.208	18.29	67.42	H
	20525	836.5	-10.66	31.3	18.49	70.63	H
	20635	847.5	-10.88	31.222	18.19	65.95	H
	20415	825.5	-18.93	31.504	10.42	11.03	V
	20525	836.5	-18.09	31.117	10.88	12.24	V
	20635	847.5	-19.41	31.922	10.36	10.87	V

LTE Band 5							
Channel Bandwidth: 5MHz / QPSK							
Plane	Channel	Frequency (MHz)	LVL (dBm)	Correction Factor(dB)	ERP(dBm)	ERP(mW)	Polarization (H/V)
X	20425	826.5	-10.63	31.208	18.43	69.63	H
	20525	836.5	-10.55	31.3	18.60	72.44	H
	20625	846.5	-10.23	31.222	18.84	76.59	H
	20425	826.5	-18.03	31.504	11.32	13.56	V
	20525	836.5	-17.47	31.117	11.50	14.12	V
	20625	846.5	-18.10	31.922	11.67	14.70	V

LTE Band 5							
Channel Bandwidth: 5MHz / 16QAM							
Plane	Channel	Frequency (MHz)	LVL (dBm)	Correction Factor(dB)	ERP(dBm)	ERP(mW)	Polarization (H/V)
X	20425	826.5	-10.99	31.208	18.07	64.09	H
	20525	836.5	-10.87	31.3	18.28	67.30	H
	20625	846.5	-10.57	31.222	18.50	70.83	H
	20425	826.5	-18.48	31.504	10.87	12.23	V
	20525	836.5	-18.26	31.117	10.71	11.77	V
	20625	846.5	-19.06	31.922	10.71	11.78	V



A D T

LTE Band 5							
Channel Bandwidth: 10MHz / QPSK							
Plane	Channel	Frequency (MHz)	LVL (dBm)	Correction Factor(dB)	ERP(dBm)	ERP(mW)	Polarization (H/V)
X	20450	829.0	-9.16	31.208	19.90	97.68	H
	20525	836.5	-9.27	31.3	19.88	97.27	H
	20600	844.0	-9.23	31.222	19.84	96.43	H
	20450	829.0	-16.42	31.504	12.93	19.65	V
	20525	836.5	-15.97	31.117	13.00	19.94	V
	20600	844.0	-17.00	31.922	12.77	18.93	V

LTE Band 5							
Channel Bandwidth: 10MHz / 16QAM							
Plane	Channel	Frequency (MHz)	LVL (dBm)	Correction Factor(dB)	ERP(dBm)	ERP(mW)	Polarization (H/V)
X	20450	829.0	-9.70	31.208	19.36	86.26	H
	20525	836.5	-10.02	31.3	19.13	81.85	H
	20600	844.0	-9.64	31.222	19.43	87.74	H
	20450	829.0	-18.11	31.504	11.24	13.32	V
	20525	836.5	-17.51	31.117	11.46	13.99	V
	20600	844.0	-17.85	31.922	11.92	15.57	V

4.2 FREQUENCY STABILITY MEASUREMENT

4.2.1 LIMITS OF FREQUENCY STABILITY MEASUREMENT

1.5 ppm is for base and fixed station. 2.5 ppm is for mobile station.

4.2.2 TEST PROCEDURE

- a. Device is placed at the oven room. The oven room could control the temperatures and humidity. Power warm up is at least 15 min and power applied should perform before recording frequency error.
- b. EUT is connected the external power supply to control the DC input power. The test voltage range is from minimum to maximum working voltage. Each step shall be record the frequency error rate.
- c. The temperature range step is 10 degrees in this test items. All temperature levels shall be hold the $\pm 0.5^{\circ}\text{C}$ during the measurement testing. The each temperature step shall be at least 0.5 hours, consider the EUT could be test under the stability condition.

NOTE: The frequency error was recorded frequency error from the communication simulator.

4.2.3 TEST SETUP

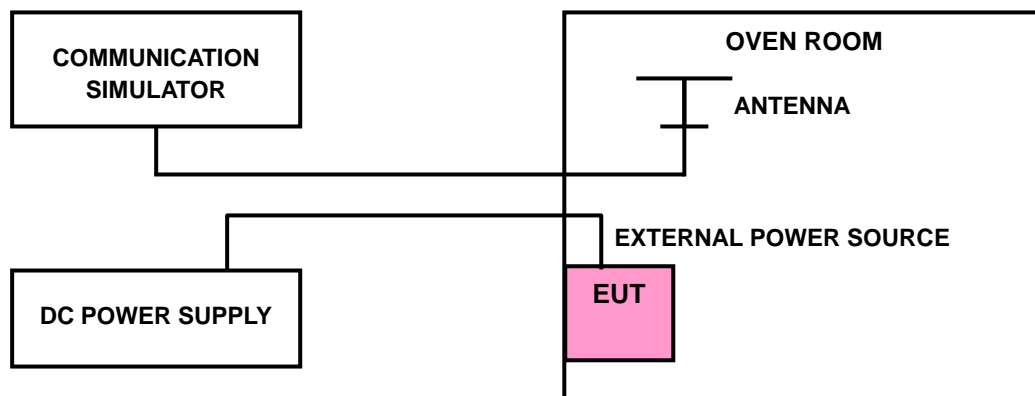

4.2.4 TEST RESULTS

FREQUENCY ERROR vs. VOLTAGE

VOLTAGE (Volts)	FREQUENCY ERROR (ppm)							LIMIT (ppm)
	GSM	EDGE	WCDMA	LTE Band 5				
				1.4MHz	3MHz	5MHz	10MHz	
3.82	0.0038	0.0005	0.0020	0.0025	-0.0041	0.0051	-0.0055	2.5
3.6	0.0022	-0.0030	0.0062	-0.0050	-0.0013	0.0067	-0.0069	2.5
4.40	0.0002	-0.0013	-0.0031	-0.0017	-0.0059	0.0032	0.0039	2.5

NOTE: The applicant defined the normal working voltage of the battery is from 3.6Vdc to 4.40Vdc.

FREQUENCY ERROR vs. TEMPERATURE

TEMP. (°C)	FREQUENCY ERROR (ppm)							LIMIT (ppm)
	GSM	EDGE	WCDMA	LTE Band 5				
				1.4MHz	3MHz	5MHz	10MHz	
-30	0.0050	0.0031	0.0039	0.0029	-0.0050	-0.0017	-0.0038	2.5
-20	0.0025	0.0014	0.0063	0.0067	-0.0025	-0.0067	-0.0065	2.5
-10	0.0041	0.0041	0.0073	0.0051	-0.0038	-0.0074	-0.0027	2.5
0	0.0065	0.0051	0.0026	-0.0014	-0.0022	0.0017	-0.0022	2.5
10	-0.0025	-0.0039	-0.0020	-0.0006	0.0068	0.0054	0.0038	2.5
20	-0.0053	-0.0014	-0.0055	-0.0033	0.0056	0.0079	0.0054	2.5
30	-0.0043	-0.0004	0.0027	-0.0018	0.0093	0.0091	0.0025	2.5
40	0.0019	0.0010	0.0055	0.0067	0.0079	0.0041	0.0047	2.5
50	0.0029	0.0051	-0.0032	0.0087	0.0027	-0.0045	0.0091	2.5
60	0.0053	0.0027	-0.0045	0.0053	0.0020	0.0075	0.0062	2.5

4.3 OCCUPIED BANDWIDTH MEASUREMENT

4.3.1 TEST PROCEDURES

The EUT makes a call to the communication simulator. All measurements were done at low, middle and high operational frequency range. The communication simulator station system controlled a EUT to export maximum output power under transmission mode and specific channel frequency. Use OBW measurement function of Spectrum analyzer to measure 99 % occupied bandwidth.

4.3.2 TEST SETUP

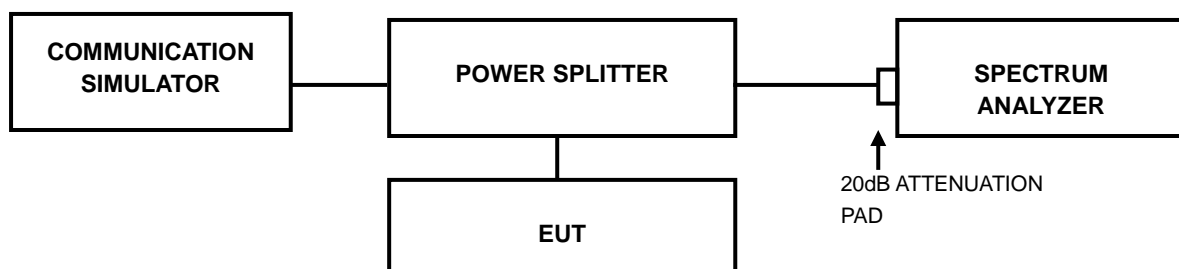



A D T

4.3.3 TEST RESULTS

CHANNEL	FREQUENCY (MHz)	99% OCCUPIED BANDWIDTH (kHz)		CHANNEL	FREQUENCY (MHz)	99% OCCUPIED BANDWIDTH (MHz)
		GSM	EDGE			
128	824.2	247.27	246.45	4132	826.4	4.1452
189	836.4	245.77	245.62	4182	836.4	4.1478
251	848.8	246.79	246.48	4233	846.6	4.1444

CHANNEL	FREQUENCY (MHz)	26dB BANDWIDTH (kHz)		CHANNEL	FREQUENCY (MHz)	26dB BANDWIDTH (MHz)
		GSM	EDGE			
128	824.2	316.70	312.40	4132	826.4	4.703
189	836.4	314.00	312.40	4182	836.4	4.708
251	848.8	315.50	322.60	4233	846.6	4.714

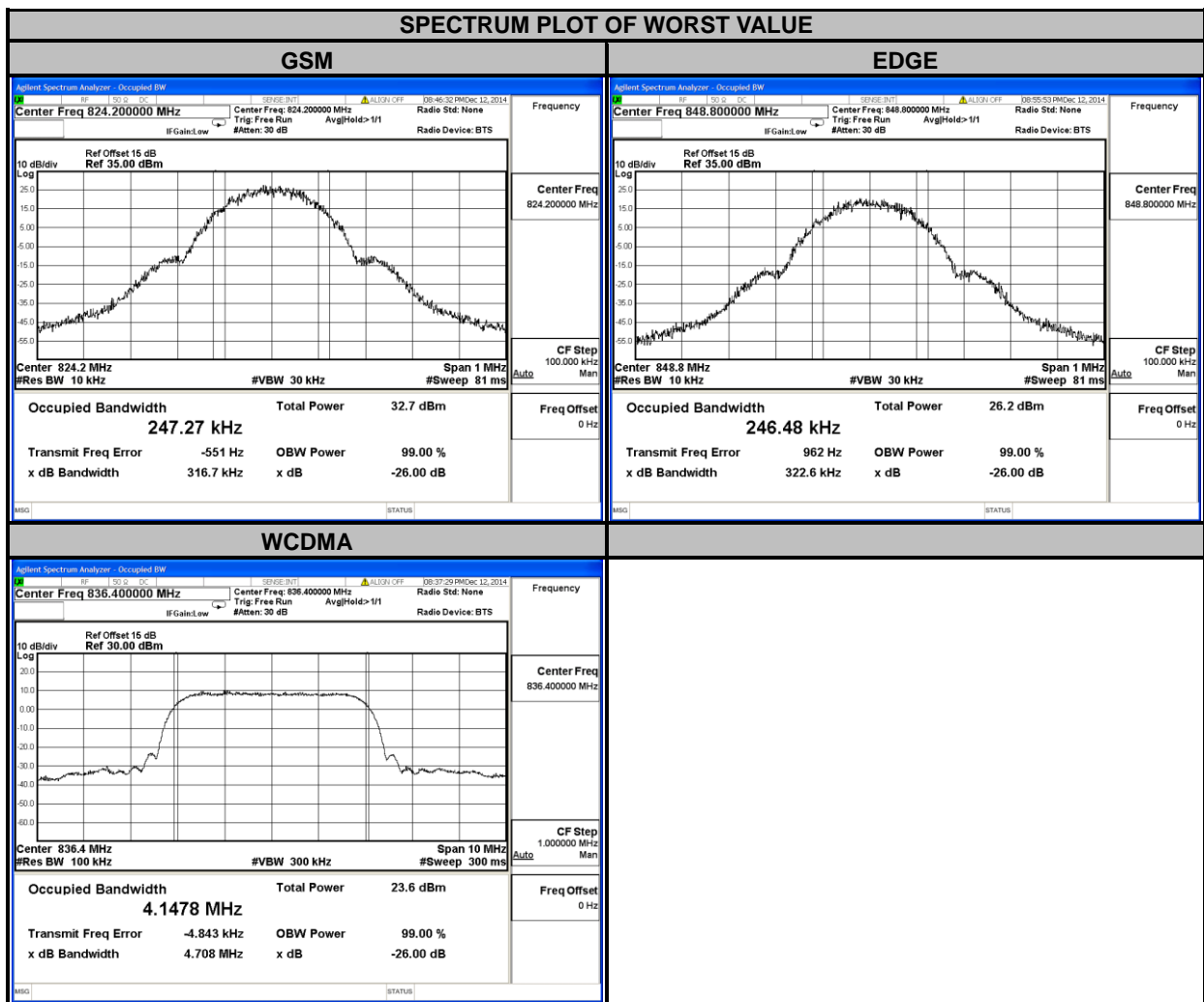



A D T

LTE BAND 5							
CHANNEL BANDWIDTH: 1.4MHz				CHANNEL BANDWIDTH: 3MHz			
CHANNEL	FREQUENCY (MHz)	99% OCCUPIED BANDWIDTH (MHz)		CHANNEL	FREQUENCY (MHz)	99% OCCUPIED BANDWIDTH (MHz)	
		QPSK	16QAM			QPSK	16QAM
20407	824.7	1.0905	1.0886	20415	825.5	2.6956	2.6943
20525	836.5	1.0888	1.0881	20525	836.5	2.6959	2.6947
20643	848.3	1.0896	1.0867	20635	847.5	2.6950	2.6954
CHANNEL	FREQUENCY (MHz)	26dB BANDWIDTH (MHz)		CHANNEL	FREQUENCY (MHz)	26dB BANDWIDTH (MHz)	
		QPSK	16QAM			QPSK	16QAM
20407	824.7	1.212	1.215	20415	825.5	2.922	2.913
20525	836.5	1.216	1.214	20525	836.5	2.913	2.921
20643	848.3	1.214	1.218	20635	847.5	2.911	2.923

SPECTRUM PLOT OF WORST VALUE

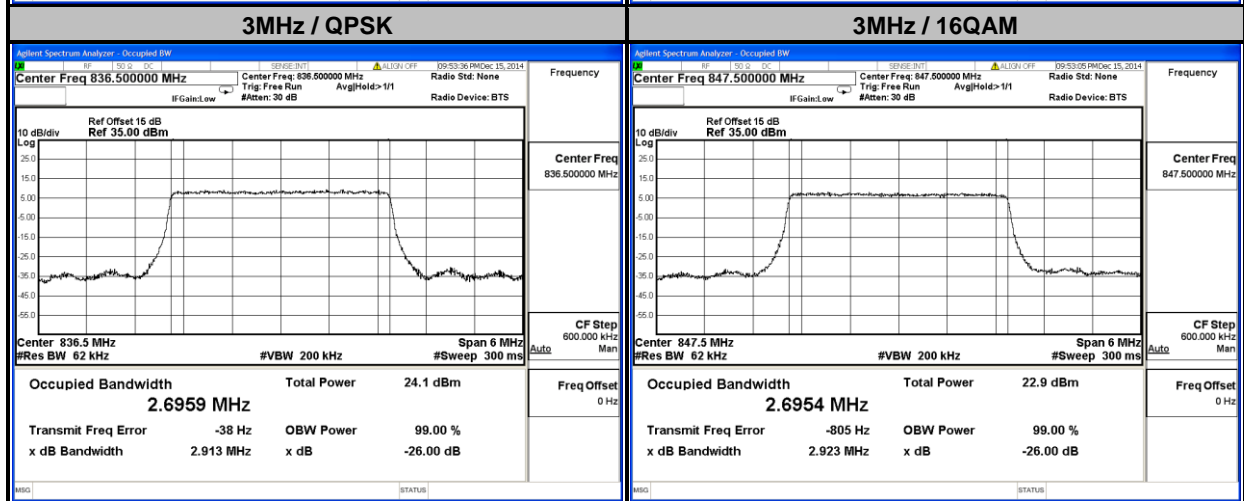
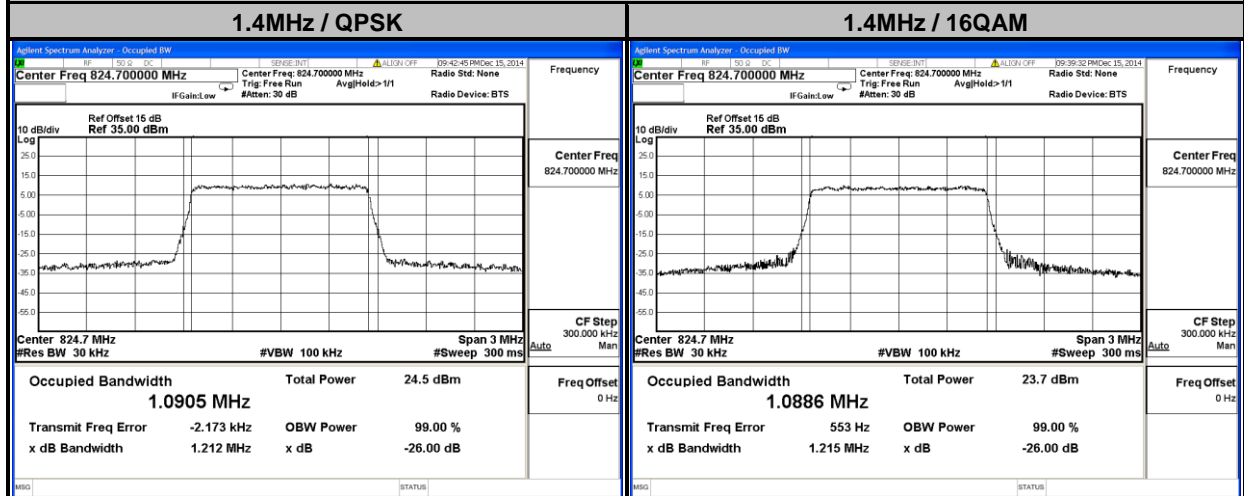



A D T

LTE BAND 5							
CHANNEL BANDWIDTH: 5MHz				CHANNEL BANDWIDTH: 10MHz			
CHANNEL	FREQUENCY (MHz)	99% OCCUPIED BANDWIDTH (MHz)		CHANNEL	FREQUENCY (MHz)	99% OCCUPIED BANDWIDTH (MHz)	
		QPSK	16QAM			QPSK	16QAM
20425	826.5	4.4910	4.4842	20450	829.0	8.9630	8.9532
20525	836.5	4.4901	4.4875	20525	836.5	8.7310	8.9724
20625	846.5	4.4911	4.4875	20600	844.0	8.9623	8.9514
CHANNEL	FREQUENCY (MHz)	26dB BANDWIDTH (MHz)		CHANNEL	FREQUENCY (MHz)	26dB BANDWIDTH (MHz)	
		QPSK	16QAM			QPSK	16QAM
20425	826.5	4.808	4.772	20450	829.0	9.503	9.512
20525	836.5	4.840	4.786	20525	836.5	9.509	9.510
20625	846.5	4.793	4.797	20600	844.0	9.517	9.513

SPECTRUM PLOT OF WORST VALUE

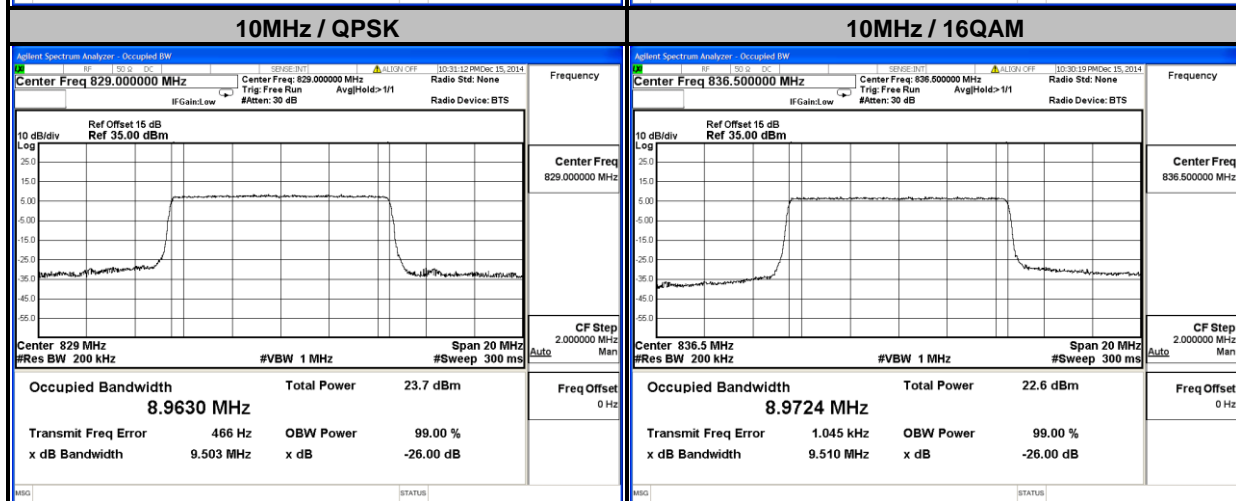
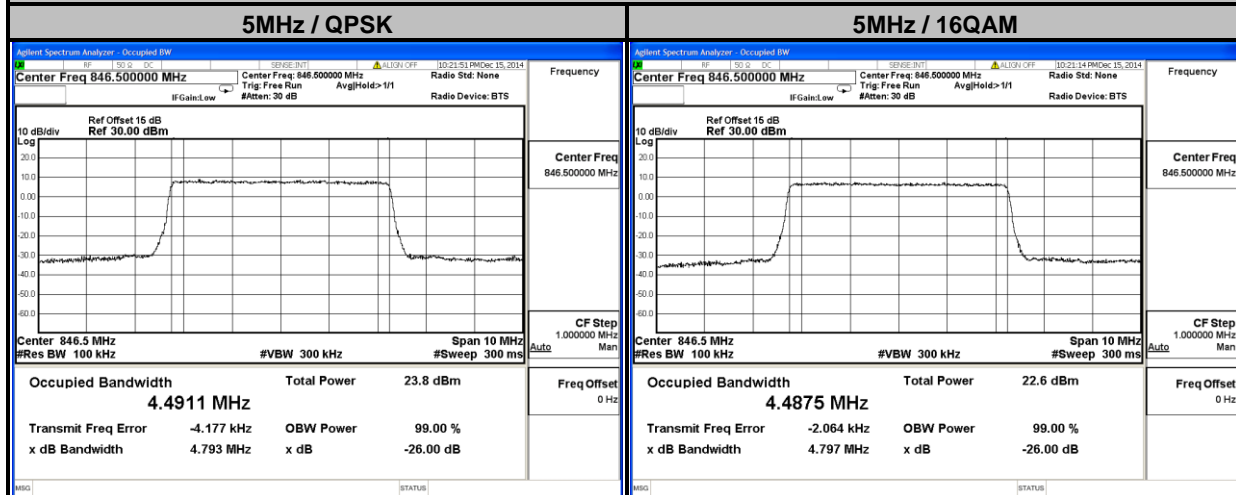

4.4 BAND EDGE MEASUREMENT

4.4.1 LIMITS OF BAND EDGE MEASUREMENT

Power of any emission outside of the authorized operating frequency ranges must be attenuated below the transmitting power (P) by a factor of at least $43 + 10 \log(P)$ dB. In the 1 MHz bands immediately outside and adjacent to the frequency block a resolution bandwidth of at least one percent of the emission bandwidth of the fundamental emission of the transmitter may be employed.

4.4.2 TEST SETUP

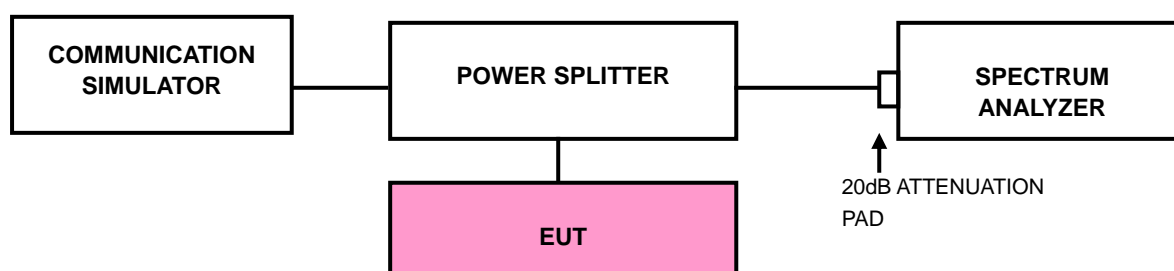

4.4.3 TEST PROCEDURES

- All measurements were done at low and high operational frequency range.
- The center frequency of spectrum is the band edge frequency and span is 1MHz. RB of the spectrum is 3.9kHz and VB of the spectrum is 12kHz (GSM/GPRS/EDGE).
- The center frequency of spectrum is the band edge frequency and span is 5MHz. RB of the spectrum is 100kHz and VB of the spectrum is 300kHz (WCDMA).
- The center frequency of spectrum is the band edge frequency and span is 1MHz. RB of the spectrum is 13kHz and VB of the spectrum is 51kHz (LTE Bandwidth 1.4MHz).
- The center frequency of spectrum is the band edge frequency and span is 1MHz. RB of the spectrum is 30kHz and VB of the spectrum is 100kHz (LTE Bandwidth 3MHz).
- The center frequency of spectrum is the band edge frequency and span is 1MHz. RB of the spectrum is 100kHz and VB of the spectrum is 300kHz (LTE Bandwidth 5MHz/10MHz).
- Record the max trace plot into the test report.



A D T

4.4.4 TEST RESULTS

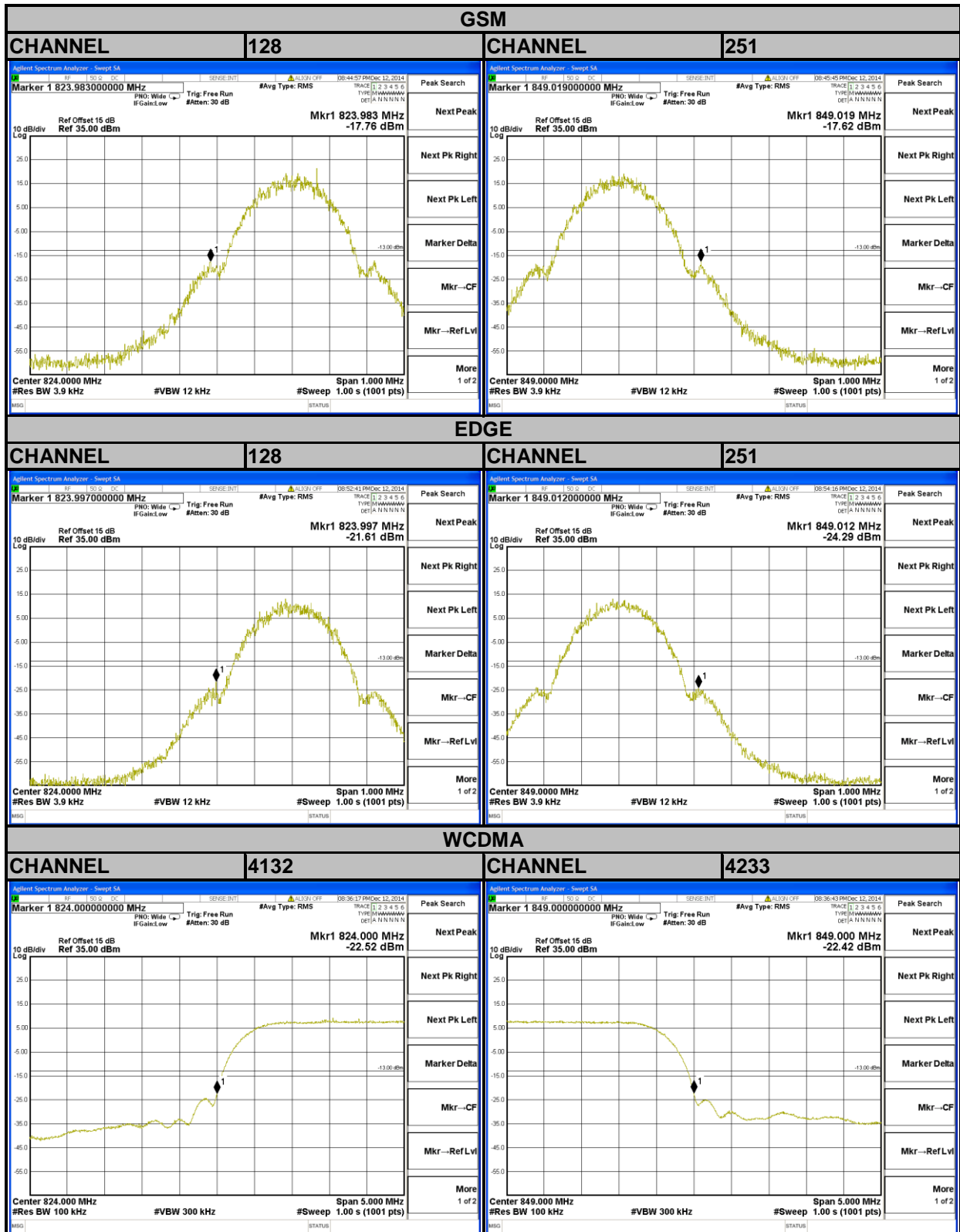



A D T

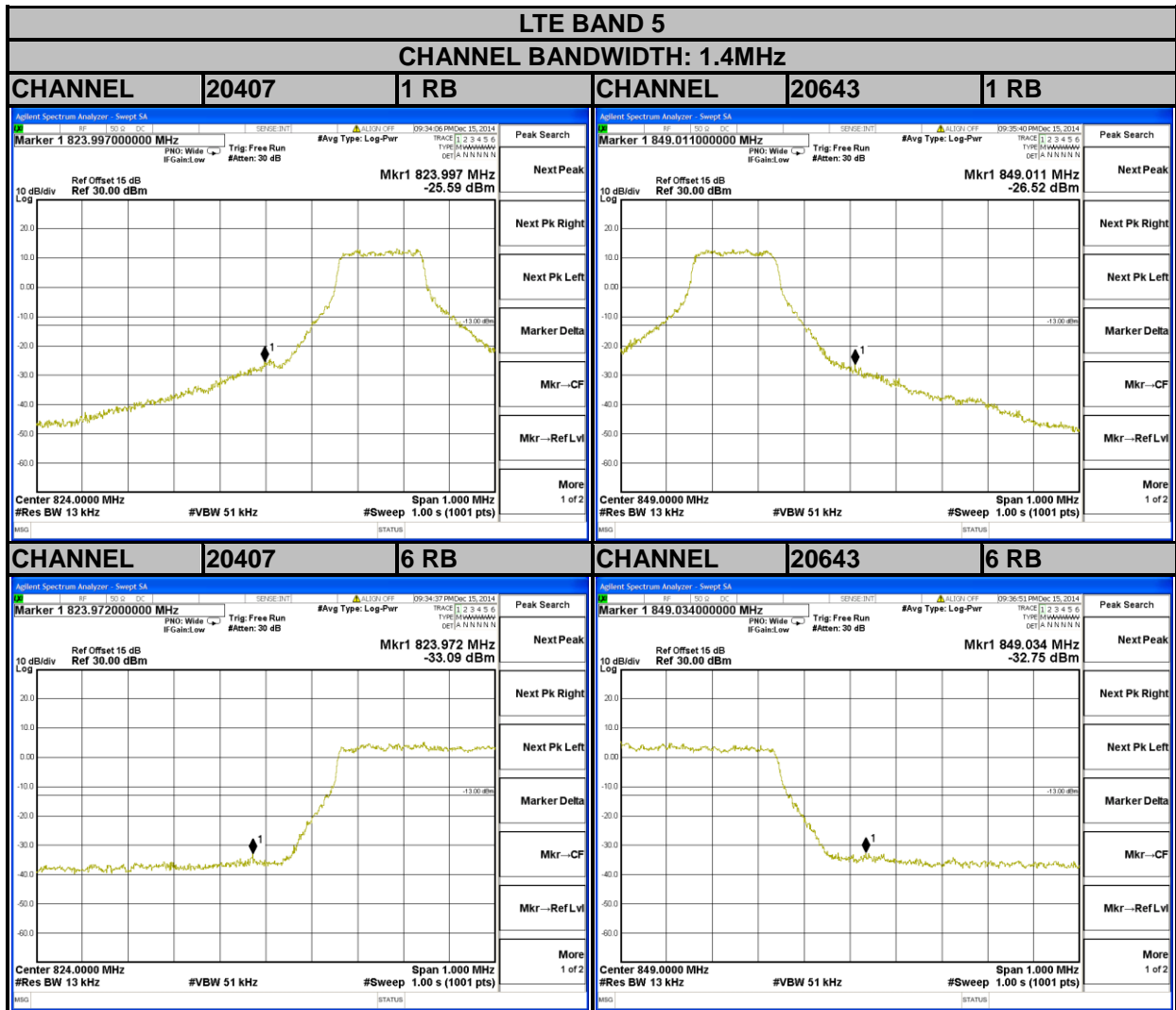



A D T

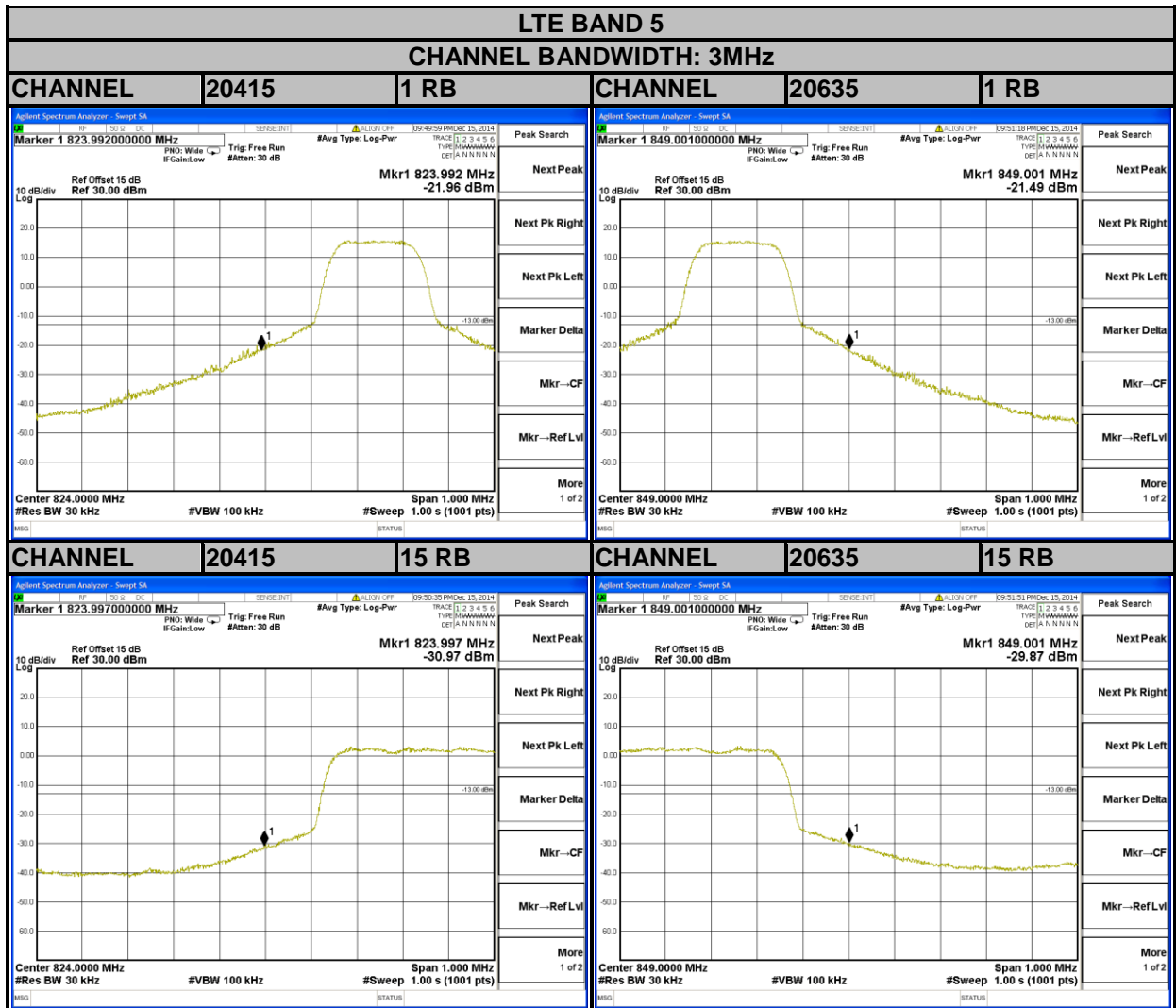



A D T

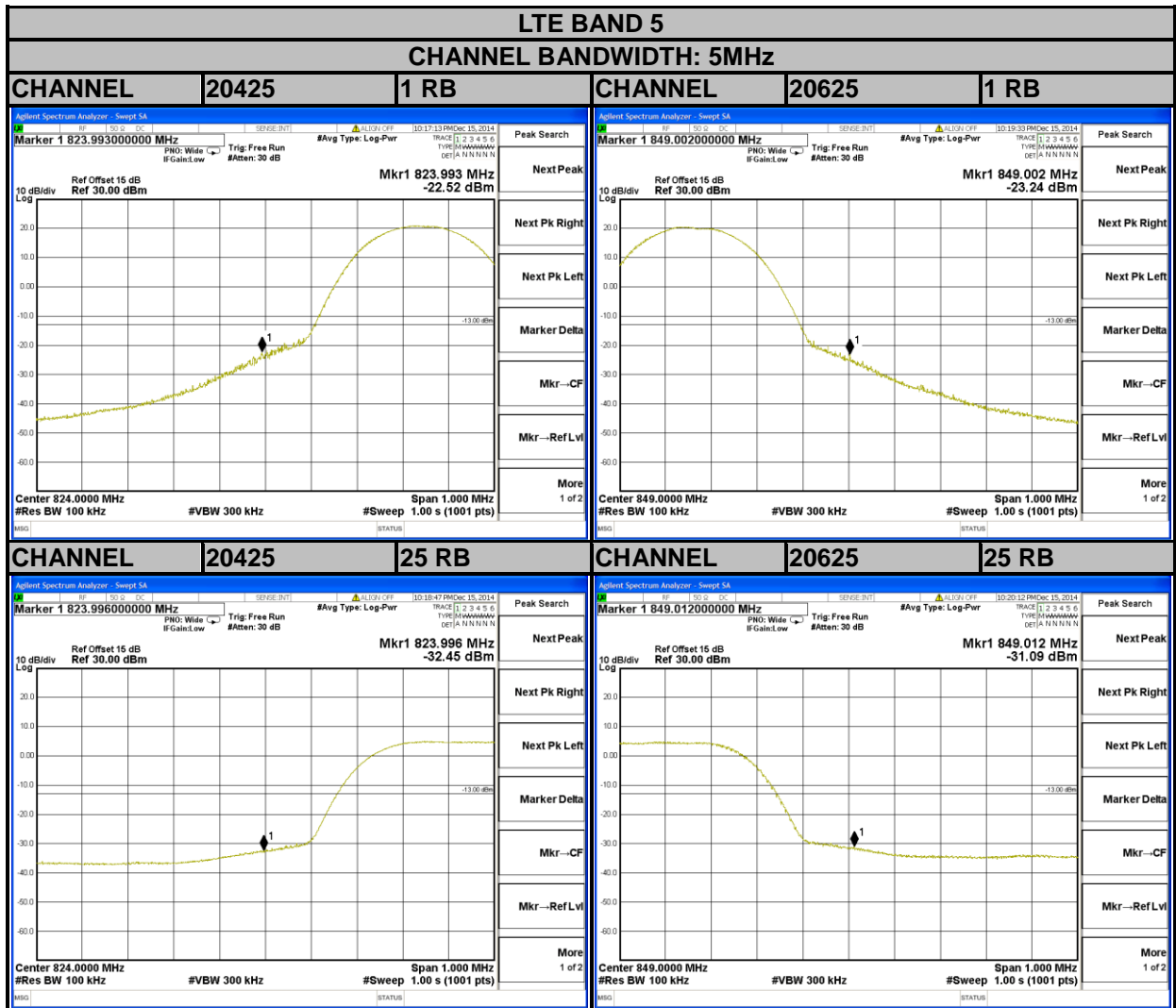



A D T

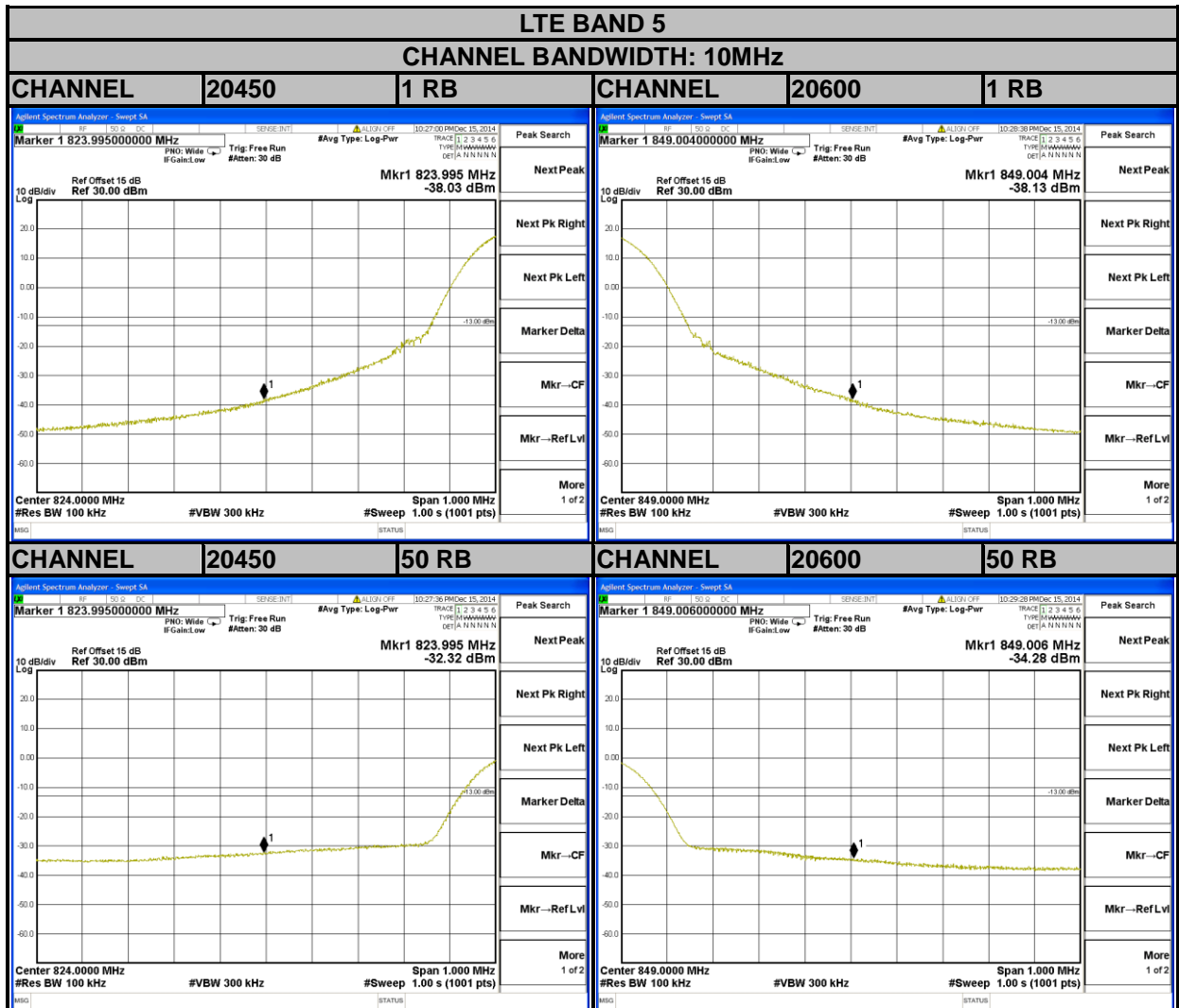

4.5 CONDUCTED SPURIOUS EMISSIONS

4.5.1 LIMITS OF CONDUCTED SPURIOUS EMISSIONS MEASUREMENT

The power of any emission outside of the authorized operating frequency ranges must be attenuated below the transmitting power (P) by a factor of at least $43 + 10 \log(P)$ dB. The emission limit is equal to -13dBm.

4.5.2 TEST PROCEDURE

- The EUT makes a phone call to the communication simulator. All measurements were done at low, middle and high operational frequency range.
- Measuring frequency range is from 30 MHz to 9GHz. 10dB attenuation pad is connected with spectrum. RBW=1MHz and VBW=3MHz is used for conducted emission measurement.

4.5.3 TEST SETUP

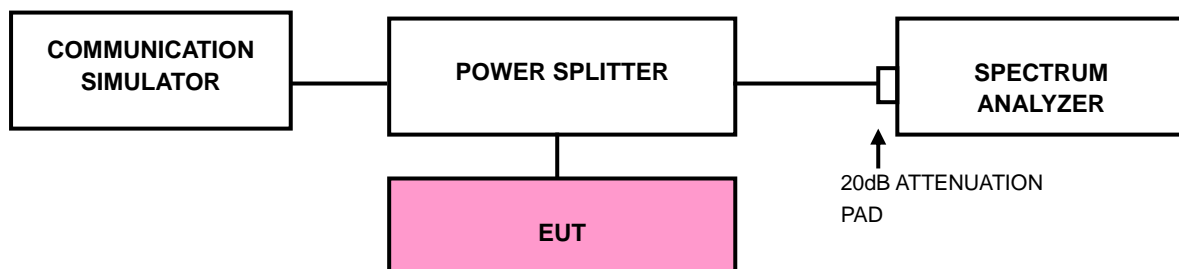

4.5.4 TEST RESULTS

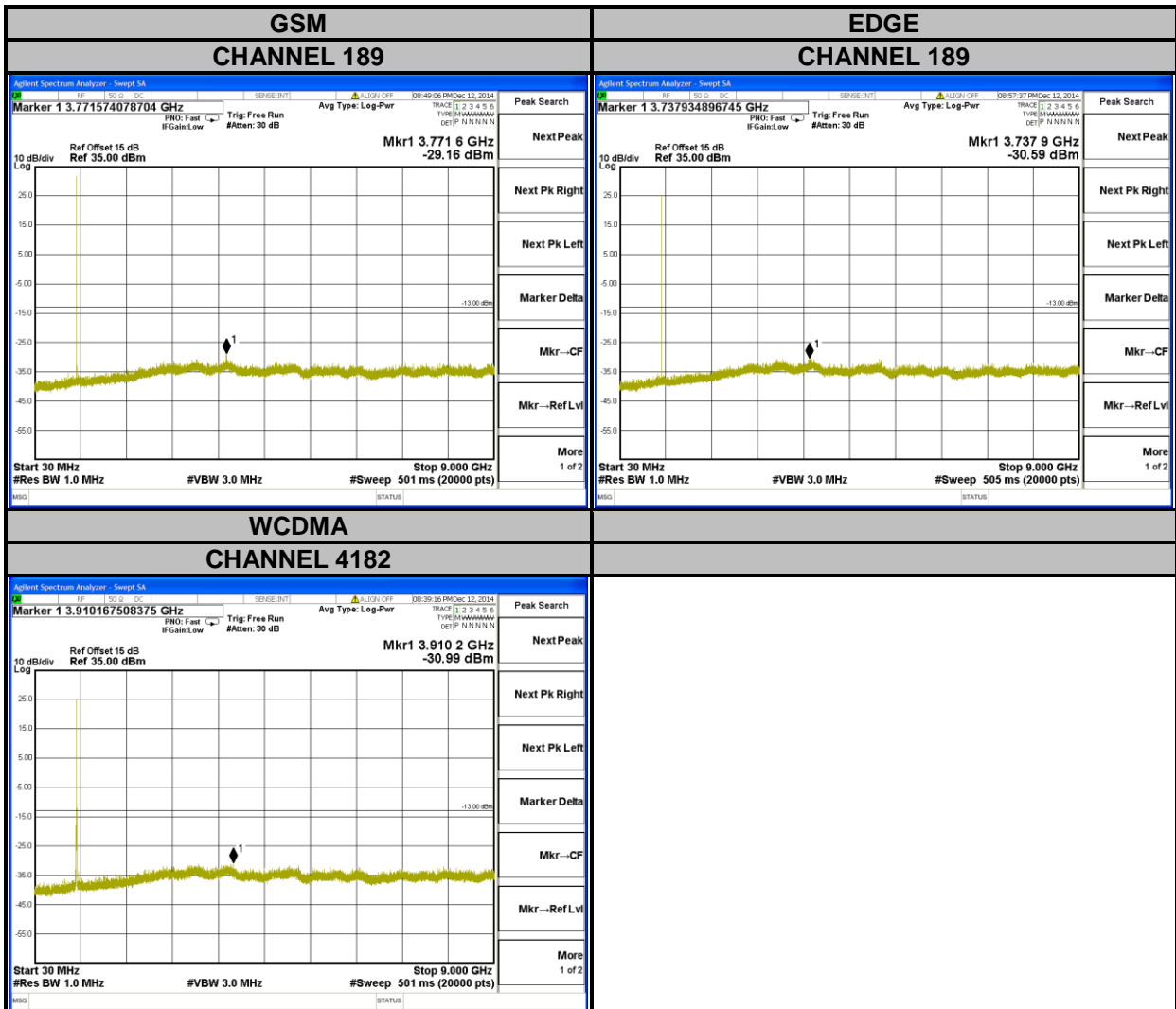



A D T

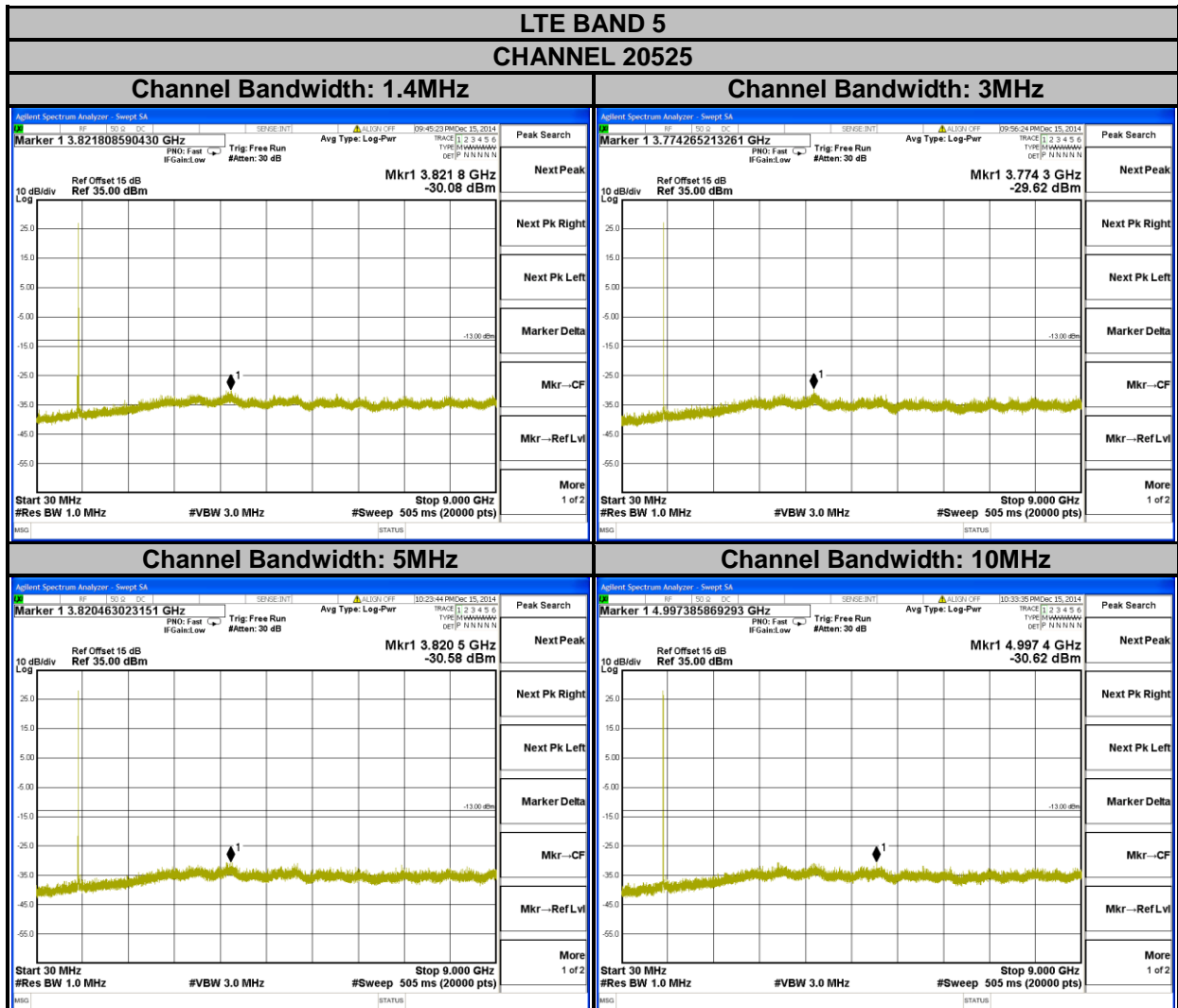

4.6 RADIATED EMISSION MEASUREMENT

4.6.1 LIMITS OF RADIATED EMISSION MEASUREMENT

The power of any emission outside of the authorized operating frequency ranges must be attenuated below the transmitting power (P) by a factor of at least $43 + 10 \log(P)$ dB. The emission limit is equal to -13dBm.

4.6.2 TEST PROCEDURES

- a. Substitution method is used for E.I.R.P measurement. In the semi-anechoic chamber, EUT placed on the 0.8m height of Turn Table, rotated the table around 360 degrees to search the maximum radiation power and receiver antenna shall be rotated vertical and horizontal polarization and moved height from 1m to 4m to find the maximum polar radiated power. The "Read Value" is the spectrum reading the maximum power value.
- b. The substitution horn antenna is substituted for EUT at the same position and signals generator export the CW signal to the substitution antenna via a TX cable. Rotated the Turn Table and moved receiving antenna to find the maximum radiation power. Adjust output power level of S.G to get a Value of spectrum reading equal to "Read Value" of step a. Record the power level of S.G
- c. $EIRP = \text{Output power level of S.G} - \text{TX cable loss} + \text{Antenna gain of substitution horn}$.
- d. E.R.P power can be calculated form E.I.R.P power by subtracting the gain of dipole, $E.R.P \text{ power} = E.I.R.P \text{ power} - 2.15\text{dBi}$.

NOTE: The resolution bandwidth and video bandwidth of test receiver/spectrum analyzer is 1MHz/3MHz.

4.6.3 DEVIATION FROM TEST STANDARD

No deviation

4.6.4 TEST SETUP

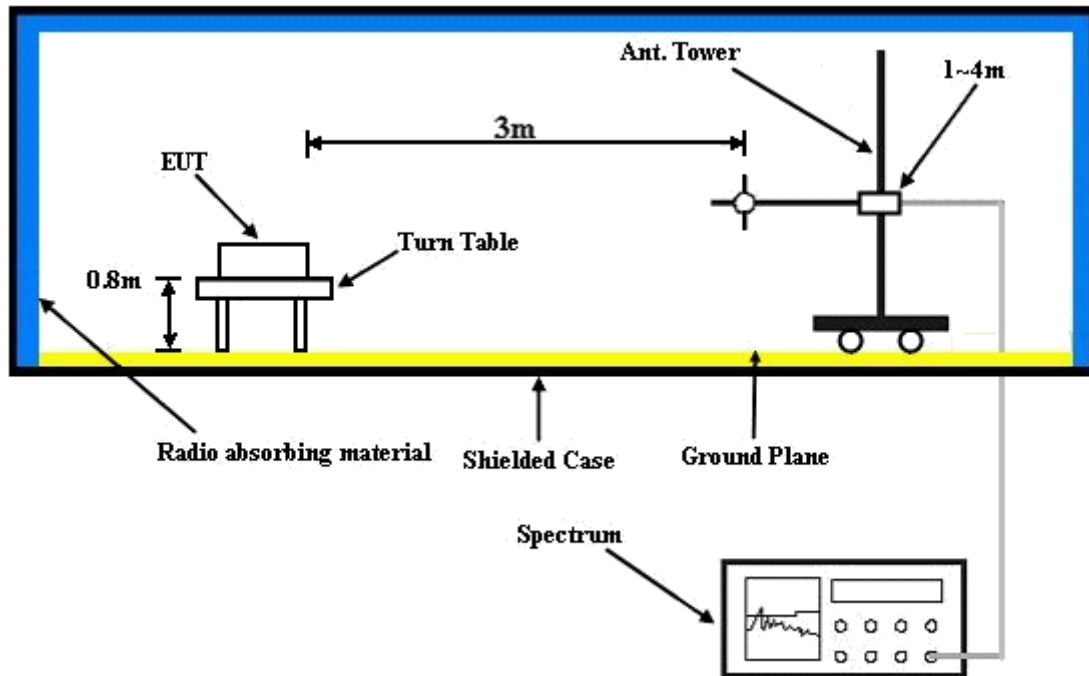

For the actual test configuration, please refer to the attached file (Test Setup Photo).

4.6.5 TEST RESULTS

GSM:



Bureau Veritas Consumer Products Services Ltd., Taoyuan Branch

A D T

Data: 9

Date: 2015-01-11

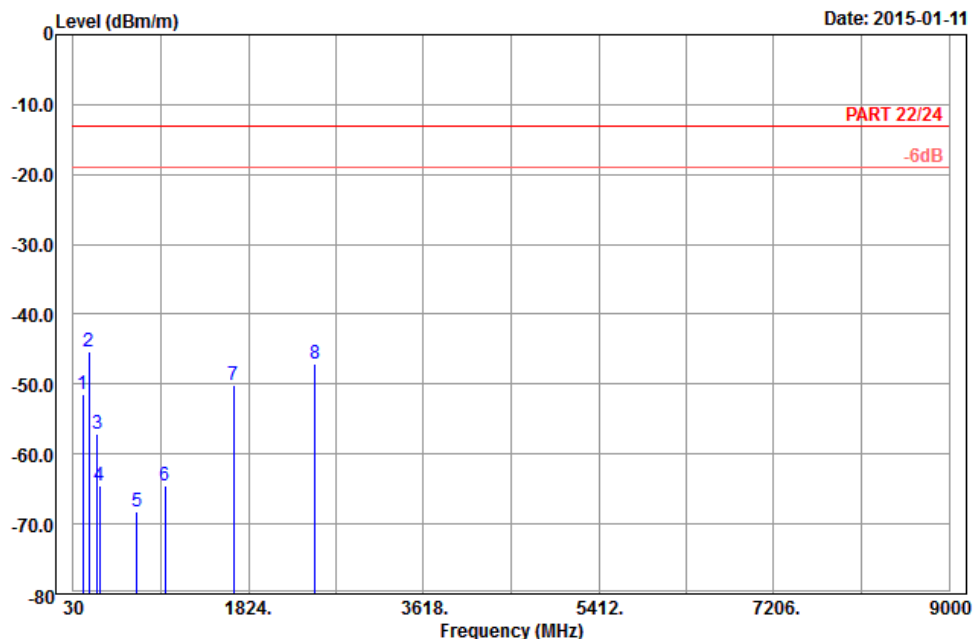

Site : 966 chamber 1
 Condition: PART 22/24 3m Horizontal
 Remark : GSM 850_Link_CH189
 Tested by: Hwa Chiang
 Plane : Y

	Freq	Level	Read Level	Limit Line	Over Limit	Factor	Remark
	MHz	dBm/m	dBm	dBm/m	dB	dB/m	
1	128.01	-51.34	-43.57	-13.00	-38.34	-7.77	Peak
2	192.54	-45.25	-39.38	-13.00	-32.25	-5.87	Peak
3	273.81	-57.07	-51.35	-13.00	-44.07	-5.72	Peak
4	302.80	-64.63	-58.70	-13.00	-51.63	-5.93	Peak
5	682.90	-68.33	-68.04	-13.00	-55.33	-0.29	Peak
6	966.40	-64.58	-69.74	-13.00	-51.58	5.16	Peak
7	1672.80	-50.13	-58.04	-13.00	-37.13	7.91	Peak
8	2509.20	-47.01	-58.29	-13.00	-34.01	11.28	Peak



Bureau Veritas Consumer Products Services Ltd., Taoyuan Branch

A D T

Data: 10

Date: 2015-01-11

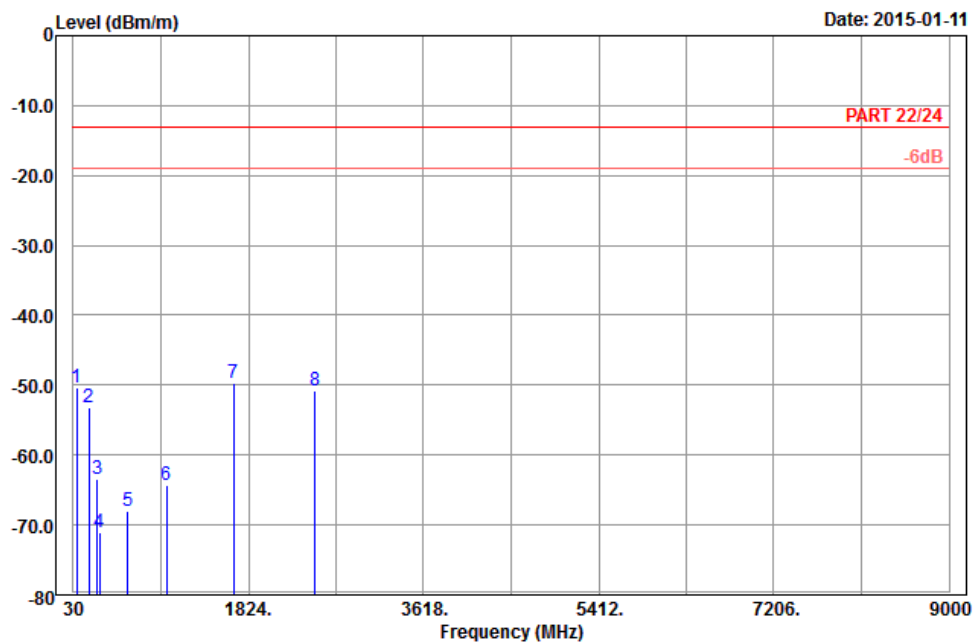

Site : 966 chamber 1
 Condition: PART 22/24 3m Vertical
 Remark : GSM 850_Link_CH189
 Tested by: Hwa Chiang
 Plane : Y

	Freq	Level	Read Level	Limit Line	Over Limit	Factor	Remark
	MHz	dBm/m	dBm	dBm/m	dB	dB/m	
1	61.59	-50.34	-36.55	-13.00	-37.34	-13.79	Peak
2	191.19	-53.27	-47.49	-13.00	-40.27	-5.78	Peak
3	274.08	-63.53	-57.80	-13.00	-50.53	-5.73	Peak
4	302.10	-71.03	-65.10	-13.00	-58.03	-5.93	Peak
5	584.90	-67.94	-67.72	-13.00	-54.94	-0.22	Peak
6	987.40	-64.32	-69.55	-13.00	-51.32	5.23	Peak
7 pp	1672.80	-49.71	-57.62	-13.00	-36.71	7.91	Peak
8	2509.20	-50.86	-62.14	-13.00	-37.86	11.28	Peak

EDGE:



Bureau Veritas Consumer Products Services Ltd., Taoyuan Branch

A D T

Data: 5

Date: 2015-01-11

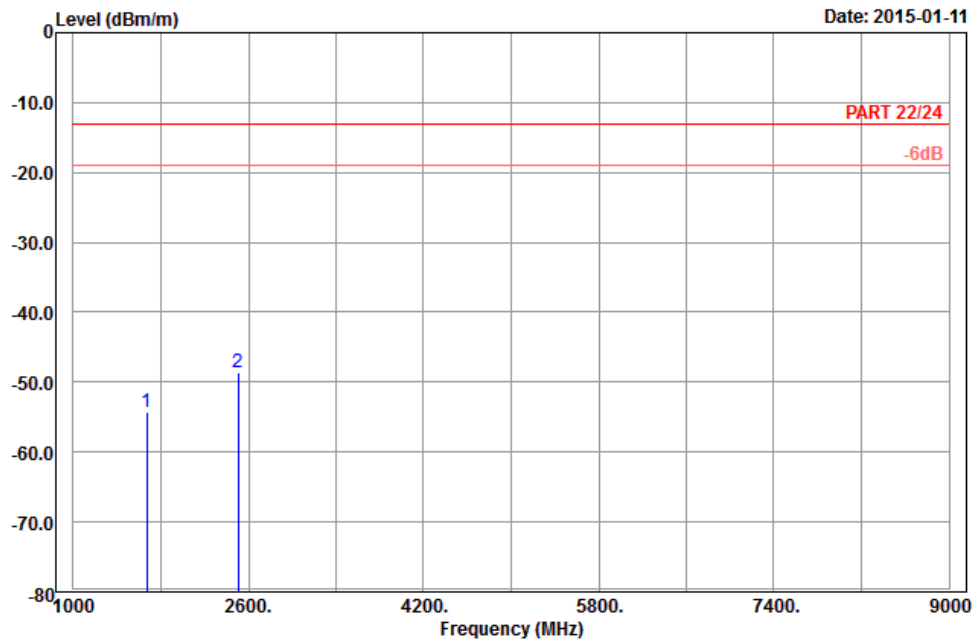

Site : 966 chamber 1
 Condition: PART 22/24 3m Horizontal
 Remark : EDGE 850_Link_CH189
 Tested by: Hwa Chiang
 Plane : Y

	Freq	Level	Read Level	Limit Line	Over Limit	Factor	Remark
	MHz	dBm/m	dBm	dBm/m	dB	dB/m	
1	1672.80	-54.20	-62.11	-13.00	-41.20	7.91	Peak
2 pp	2509.20	-48.69	-59.97	-13.00	-35.69	11.28	Peak



Bureau Veritas Consumer Products Services Ltd., Taoyuan Branch

A D T

Data: 6

Date: 2015-01-11

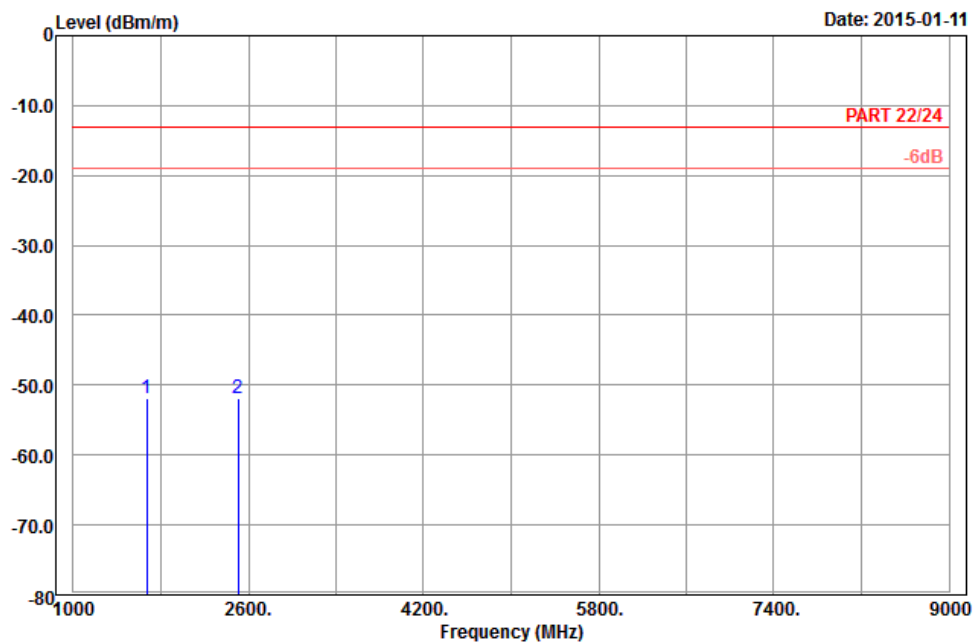

Site : 966 chamber 1
 Condition: PART 22/24 3m Vertical
 Remark : EDGE 850_Link_CH189
 Tested by: Hwa Chiang
 Plane : Y

	Freq	Level	Read Level	Limit Line	Over Limit	Factor	Remark
	MHz	dBm/m	dBm	dBm/m	dB	dB/m	
1	1672.80	-51.90	-59.81	-13.00	-38.90	7.91	Peak
2 pp	2509.20	-51.80	-63.08	-13.00	-38.80	11.28	Peak

WCDMA:



Bureau Veritas Consumer Products Services Ltd., Taoyuan Branch

A D T

Data: 5

Date: 2015-01-11

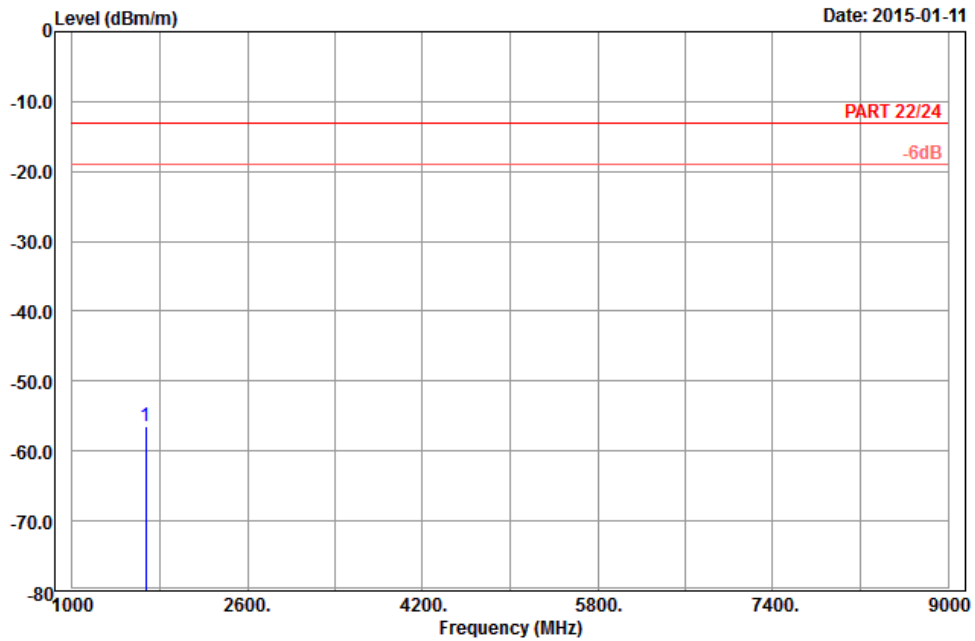

Site : 966 chamber 1
 Condition: PART 22/24 3m Horizontal
 Remark : Band V_LINK_CH4182
 Tested by: Hwa Chiang
 Plane : Y

	Read	Limit	Over		
Freq	Level	Level	Line	Limit	Factor Remark
MHz	dBm/m	dBm	dBm/m	dB	dB/m
1 pp 1672.80	-56.44	-64.35	-13.00	-43.44	7.91 Peak



A D T

Data: 6

Date: 2015-01-11

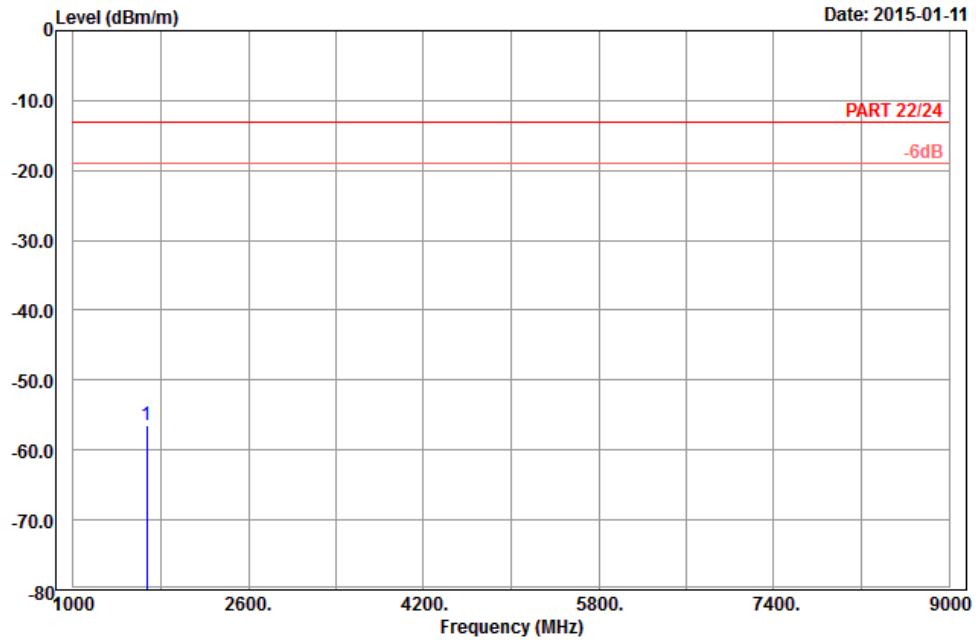

Site : 966 chamber 1
 Condition: PART 22/24 3m Vertical
 Remark : Band V_LINK_CH4182
 Tested by: Hwa Chiang
 Plane : Y

	Read	Limit	Over		
Freq	Level	Level	Line	Limit	Factor Remark
MHz	dBm/m	dBm	dBm/m	dB	dB/m
1 pp 1672.80	-56.35	-64.26	-13.00	-43.35	7.91 Peak



A D T

LTE BAND 5
CHANNEL BANDWIDTH: 10MHz / QPSK



Bureau Veritas Consumer Products Services Ltd., Taoyuan Branch

A D T

Data: 9

Date: 2015-01-10

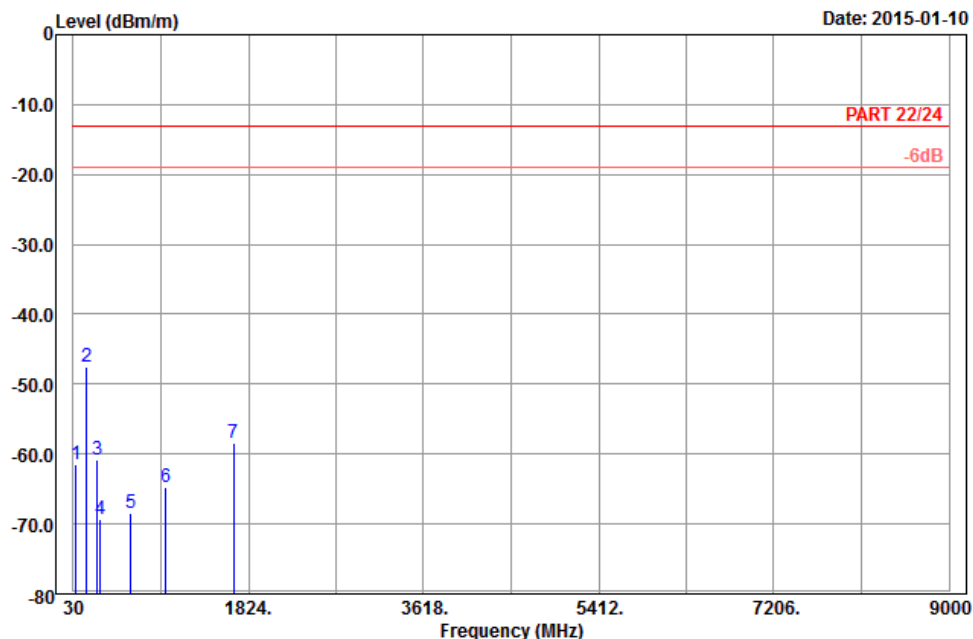

Site : 966 chamber 1
 Condition: PART 22/24 3m Horizontal
 Remark : LTE_Band 5_QPSK(1,49)_10M_CH20525
 Tested by: Karl Lee
 Plane : Z

		Read	Limit	Over		
	Freq	Level	Level	Line	Limit	Factor Remark
	MHz	dBm/m	dBm	dBm/m	dB	dB/m
1	59.43	-61.52	-47.46	-13.00	-48.52	-14.06 Peak
2	pp 163.92	-47.45	-40.17	-13.00	-34.45	-7.28 Peak
3	273.27	-60.88	-55.16	-13.00	-47.88	-5.72 Peak
4	303.50	-69.40	-63.49	-13.00	-56.40	-5.91 Peak
5	622.70	-68.53	-68.70	-13.00	-55.53	0.17 Peak
6	974.10	-64.71	-69.89	-13.00	-51.71	5.18 Peak
7	1672.80	-58.33	-66.24	-13.00	-45.33	7.91 Peak



Bureau Veritas Consumer Products Services Ltd., Taoyuan Branch

A D T

Data: 10

Date: 2015-01-10

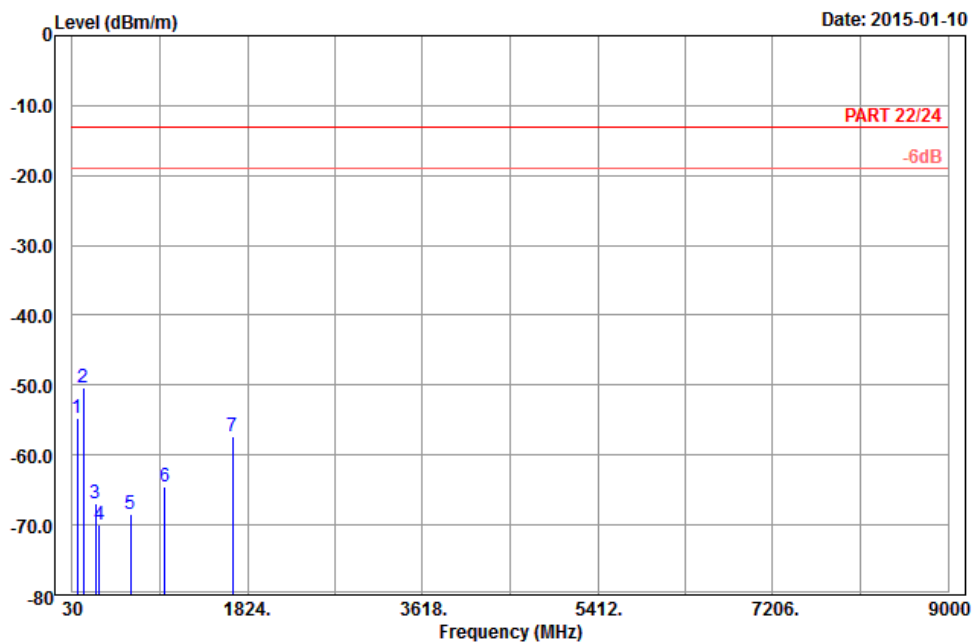

Site : 966 chamber 1
 Condition: PART 22/24 3m Vertical
 Remark : LTE_Band 5_QPSK(1,49)_10M_CH20525
 Tested by: Karl Lee
 Plane : Z

	Freq	Level	Read Level	Limit Line	Over Limit	Factor	Remark
	MHz	dBm/m	dBm	dBm/m	dB	dB/m	
1	80.76	-54.73	-42.96	-13.00	-41.73	-11.77	Peak
2	146.37	-50.45	-42.59	-13.00	-37.45	-7.86	Peak
3	268.14	-66.92	-61.24	-13.00	-53.92	-5.68	Peak
4	303.50	-69.95	-64.04	-13.00	-56.95	-5.91	Peak
5	623.40	-68.42	-68.58	-13.00	-55.42	0.16	Peak
6	974.80	-64.55	-69.74	-13.00	-51.55	5.19	Peak
7	1672.80	-57.34	-65.25	-13.00	-44.34	7.91	Peak



A D T

5 PHOTOGRAPHS OF THE TEST CONFIGURATION

Please refer to the attached file (Test Setup Photo).



6 INFORMATION ON THE TESTING LABORATORIES

We, Bureau Veritas Consumer Products Services (H.K.) Ltd., Taoyuan Branch, were founded in 1988 to provide our best service in EMC, Radio, Telecom and Safety consultation. Our laboratories are accredited and approved according to ISO/IEC 17025.

If you have any comments, please feel free to contact us at the following:

Linko EMC/RF Lab:

Tel: 886-2-26052180
Fax: 886-2-26051924

Hsin Chu EMC/RF/Telecom Lab:

Tel: 886-3-5935343
Fax: 886-3-5935342

Hwa Ya EMC/RF/Safety Lab:

Tel: 886-3-3183232
Fax: 886-3-3270892

Email: service.adt@tw.bureauveritas.com

Web Site: www.bureauveritas-adt.com

The address and road map of all our labs can be found in our web site also.



A D T

7 APPENDIX A – MODIFICATIONS RECORDERS FOR ENGINEERING CHANGES TO THE EUT BY THE LAB

No any modifications were made to the EUT by the lab during the test.

---END---