



FCC TEST REPORT (15.407)

REPORT NO.: RF141204C02-6
MODEL NO.: 0PJA100
FCC ID: NM80PJA100
RECEIVED: Dec. 04, 2014
TESTED: Dec. 12, 2014 ~ Jan. 11, 2015
ISSUED: Feb. 05, 2015

APPLICANT: HTC Corporation

ADDRESS: 1F, 6-3 Baoqiang Road, Xindian District, New Taipei City, Taiwan 231

ISSUED BY: Bureau Veritas Consumer Products Services (H.K.) Ltd., Taoyuan Branch

LAB ADDRESS: No. 47-2, 14th Ling, Chia Pau Vil., Lin Kou Dist., New Taipei City, Taiwan (R.O.C)

TEST LOCATION: No. 19, Hwa Ya 2nd Rd, Wen Hwa Tsuen, Kwei Shan Hsiang, Taoyuan Hsien 333, Taiwan, R.O.C.

This report should not be used by the client to claim product certification, approval, or endorsement by TAF or any government agencies.



This report is for your exclusive use. Any copying or replication of this report to or for any other person or entity, or use of our name or trademark, is permitted only with our prior written permission. This report sets forth our findings solely with respect to the test samples identified herein. The results set forth in this report are not indicative or representative of the quality or characteristics of the lot from which a test sample was taken or any similar or identical product unless specifically and expressly noted. Our report includes all of the tests requested by you and the results thereof based upon the information that you provided to us. You have 60 days from date of issuance of this report to notify us of any material error or omission caused by our negligence, provided, however, that such notice shall be in writing and shall specifically address the issue you wish to raise. A failure to raise such issue within the prescribed time shall constitute your unqualified acceptance of the completeness of this report, the tests conducted and the correctness of the report contents. Unless specific mention, the uncertainty of measurement has been explicitly taken into account to declare the compliance or non-compliance to the specification.



TABLE OF CONTENTS

RELEASE CONTROL RECORD	4
1. CERTIFICATION.....	5
2. SUMMARY OF TEST RESULTS	6
2.1 MEASUREMENT UNCERTAINTY.....	6
3. GENERAL INFORMATION	7
3.1 GENERAL DESCRIPTION OF EUT	7
3.2 DESCRIPTION OF TEST MODES	8
3.2.1 TEST MODE APPLICABILITY AND TESTED CHANNEL DETAIL	10
3.3 DESCRIPTION OF SUPPORT UNITS	13
3.3.1 CONFIGURATION OF SYSTEM UNDER TEST	13
3.4 DUTY CYCLE TEST SIGNAL	14
3.5 GENERAL DESCRIPTION OF APPLIED STANDARDS	18
4. TEST TYPES AND RESULTS	19
4.1 RADIATED EMISSION AND BANDEDGE MEASUREMENT	19
4.1.1 LIMITS OF RADIATED EMISSION AND BANDEDGE MEASUREMENT	19
4.1.2 LIMITS OF UNWANTED EMISSION OUT OF THE RESTRICTED BANDS	19
4.1.3 TEST INSTRUMENTS	20
4.1.4 TEST PROCEDURES	21
4.1.5 DEVIATION FROM TEST STANDARD	21
4.1.6 TEST SETUP	22
4.1.7 EUT OPERATING CONDITIONS	23
4.1.8 TEST RESULTS.....	24
4.2 CONDUCTED EMISSION MEASUREMENT	65
4.2.1 LIMITS OF CONDUCTED EMISSION MEASUREMENT	65
4.2.2 TEST INSTRUMENTS.....	65
4.2.3 TEST PROCEDURES	66
4.2.4 DEVIATION FROM TEST STANDARD	66
4.2.5 TEST SETUP	67
4.2.6 EUT OPERATING CONDITIONS	67
4.2.7 TEST RESULTS.....	68
4.3 TRANSMIT POWER MEASUREMENT	70
4.3.1 LIMITS OF TRANSMIT POWER MEASUREMENT	70
4.3.2 TEST SETUP	70
4.3.3 TEST INSTRUMENTS.....	71
4.3.4 TEST PROCEDURE	71
4.3.5 DEVIATION FROM TEST STANDARD	71
4.3.6 EUT OPERATING CONDITIONS	71
4.3.7 TEST RESULTS.....	72
4.4 PEAK POWER SPECTRAL DENSITY MEASUREMENT	77
4.4.1 LIMITS OF PEAK POWER SPECTRAL DENSITY MEASUREMENT	77
4.4.2 TEST SETUP	77
4.4.3 TEST INSTRUMENTS.....	77
4.4.4 TEST PROCEDURES	78
4.4.5 DEVIATION FROM TEST STANDARD	78
4.4.6 EUT OPERATING CONDITIONS	78
4.4.7 TEST RESULTS.....	79
4.5 FREQUENCY STABILITY	84
4.5.1 LIMITS OF FREQUENCY STABILITY MEASUREMENT	84
4.5.2 TEST SETUP	84
4.5.3 TEST INSTRUMENTS.....	84
4.5.4 TEST PROCEDURE	85
4.5.5 DEVIATION FROM TEST STANDARD	85



A D T

4.5.6	EUT OPERATING CONDITION.....	85
4.5.7	TEST RESULTS.....	86
4.6	6dB BANDWIDTH MEASUREMENT	87
4.6.1	LIMITS OF 6dB BANDWIDTH MEASUREMENT	87
4.6.2	TEST SETUP	87
4.6.3	TEST INSTRUMENTS	87
4.6.4	TEST PROCEDURE	87
4.6.5	DEVIATION FROM TEST STANDARD	87
4.6.6	EUT OPERATING CONDITIONS	87
4.6.7	TEST RESULTS.....	88
5.	PHOTOGRAPHS OF THE TEST CONFIGURATION.....	90
6.	INFORMATION ON THE TESTING LABORATORIES	91
7.	APPENDIX A - MODIFICATIONS RECORDERS FOR ENGINEERING CHANGES TO THE EUT BY THE LAB	92



A D T

RELEASE CONTROL RECORD

ISSUE NO.	REASON FOR CHANGE	DATE ISSUED
RF141204C02-6	Original release	Feb. 05, 2015



1. CERTIFICATION

PRODUCT: Smartphone
MODEL NO.: 0PJA100
BRAND: HTC
APPLICANT: HTC Corporation
TESTED: Dec. 12, 2014 ~ Jan. 11, 2015
TEST SAMPLE: Production Unit
STANDARDS: **FCC Part 15, Subpart E (Section 15.407)**
ANSI C63.10-2009

The above equipment (model: 0PJA100) has been tested by **Bureau Veritas Consumer Products Services (H.K.) Ltd., Taoyuan Branch**, and found compliance with the requirement of the above standards. The test record, data evaluation & Equipment Under Test (EUT) configurations represented herein are true and accurate accounts of the measurements of the sample's EMC characteristics under the conditions specified in this report.

PREPARED BY : Ivonne Wu , **DATE** : Feb. 05, 2015
Ivonne Wu / Supervisor

APPROVED BY : Sam Chen , **DATE** : Feb. 05, 2015
Sam Chen / Senior Project Engineer

2. SUMMARY OF TEST RESULTS

The EUT has been tested according to the following specifications:

APPLIED STANDARD: FCC PART 15, SUBPART E (SECTION 15.407)			
STANDARD SECTION	TEST TYPE	RESULT	REMARK
15.407(b)(6)	AC Power Conducted Emission	PASS	Meet the requirement of limit. Minimum passing margin is -11.46dB at 0.56418MHz.
15.407(b/1/2/3) (b)(6)	Radiated Emissions	PASS	Meet the requirement of limit. Minimum passing margin is -1.08dB at 5725MHz.
15.407(a/1/2/3)	Max Average Transmit Power	PASS	Meet the requirement of limit.
15.407(a)(6)	Peak Power Excursion	PASS	Meet the requirement of limit.
15.407(a/1/2/3)	Peak Power Spectral Density	PASS	Meet the requirement of limit.
15.407(e)	6dB bandwidth	PASS	Meet the requirement of limit. (U-NII-3 Band only)
15.407(g)	Frequency Stability	PASS	Meet the requirement of limit.
15.203	Antenna Requirement	PASS	No antenna connector is used.

2.1 MEASUREMENT UNCERTAINTY

Where relevant, the following measurement uncertainty levels have been estimated for tests performed on the EUT as specified in CISPR 16-4-2:

MEASUREMENT	FREQUENCY	UNCERTAINTY
Conducted emissions	9kHz~30MHz	2.44 dB
Radiated emissions	30MHz ~ 200MHz	2.93 dB
	200MHz ~1000MHz	2.95 dB
	1GHz ~ 18GHz	2.26 dB
	18GHz ~ 40GHz	1.94 dB

This uncertainty represents an expanded uncertainty expressed at approximately the 95% confidence level using a coverage factor of $k = 2$.



3. GENERAL INFORMATION

3.1 GENERAL DESCRIPTION OF EUT

EUT	Smartphone
MODEL NO.	0PJA100
POWER SUPPLY	5.0Vdc (adapter or host equipment) 3.83Vdc (Li-ion battery)
MODULATION TYPE	256QAM, 64QAM, 16QAM, QPSK, BPSK
MODULATION TECHNOLOGY	OFDM
TRANSFER RATE	802.11a: 54.0/ 48.0/ 36.0/ 24.0/ 18.0/ 12.0/ 9.0/ 6.0Mbps 802.11n: up to MCS7 802.11ac: up to V9
OPERATING FREQUENCY	5180 ~ 5240MHz, 5260 ~ 5320MHz, 5500 ~ 5700MHz, 5745 ~ 5825MHz
NUMBER OF CHANNEL	5180 ~ 5240MHz: 4 for 802.11a, 802.11n (20MHz) 2 for 802.11n (40MHz) 1 for 802.11ac (80MHz) 5260 ~ 5320MHz: 4 for 802.11a, 802.11n (20MHz) 2 for 802.11n (40MHz) 1 for 802.11ac (80MHz) 5500 ~ 5700MHz: 8 for 802.11a, 802.11n (20MHz) 3 for 802.11n (40MHz) 1 for 802.11ac (80MHz) 5745 ~ 5825MHz: 5 for 802.11a, 802.11n (20MHz) 2 for 802.11n (40MHz) 1 for 802.11ac (80MHz)
OUTPUT POWER	38.55mW for 5180 ~ 5240MHz 41.50mW for 5260 ~ 5320MHz 42.95mW for 5500 ~ 5700MHz 42.76mW for 5745 ~ 5825MHz
ANTENNA TYPE	PIFA antenna with -3.5dBi gain (5180 ~ 5240MHz) PIFA antenna with -3dBi gain (5260 ~ 5320MHz) PIFA antenna with -3dBi gain (5500 ~ 5700MHz) PIFA antenna with -3.5dBi gain (5745 ~ 5825MHz)
ANTENNA CONNECTOR	NA
DATA CABLE	Refer to Note as below
I/O PORTS	Refer to user's manual
ACCESSORY DEVICES	Refer to Note as below

NOTE:

1. The EUT's accessories list refers to Ext. Pho.
2. The above EUT information is declared by the manufacturer and for more detailed features description, please refer to the manufacturer's specifications or User's Manual.



3.2 DESCRIPTION OF TEST MODES

WLAN 5180 ~ 5240MHz

4 channels are provided for 802.11a, 802.11n (20MHz):

CHANNEL	FREQUENCY	CHANNEL	FREQUENCY
36	5180 MHz	44	5220 MHz
40	5200 MHz	48	5240 MHz

2 channels are provided for 802.11n (40MHz):

CHANNEL	FREQUENCY	CHANNEL	FREQUENCY
38	5190 MHz	46	5230 MHz

1 channel is provided for 802.11ac (80MHz):

CHANNEL	FREQUENCY
42	5210 MHz

FOR 5260 ~ 5320MHz

4 channels are provided for 802.11a, 802.11n (20MHz):

CHANNEL	FREQUENCY	CHANNEL	FREQUENCY
52	5260 MHz	60	5300 MHz
56	5280 MHz	64	5320 MHz

2 channels are provided for 802.11n (40MHz):

CHANNEL	FREQUENCY	CHANNEL	FREQUENCY
54	5270 MHz	62	5310 MHz

1 channel is provided for 802.11ac (80MHz):

CHANNEL	FREQUENCY
58	5290MHz



WLAN 5500 ~ 5700MHz

8 channels are provided for 802.11a, 802.11n (20MHz):

CHANNEL	FREQUENCY	CHANNEL	FREQUENCY
100	5500MHz	116	5580MHz
104	5520MHz	132	5660MHz
108	5540MHz	136	5680MHz
112	5560MHz	140	5700MHz

3 channels are provided for 802.11n (40MHz):

CHANNEL	FREQUENCY	CHANNEL	FREQUENCY
102	5510MHz	134	5670MHz
110	5550MHz		

1 channel is provided for 802.11ac (80MHz):

CHANNEL	FREQUENCY
106	5530MHz

FOR 5.0GHz (5745 ~ 5825MHz):

5 channels are provided for 802.11a, 802.11n (20MHz):

CHANNEL	FREQUENCY	CHANNEL	FREQUENCY
149	5745MHz	161	5805MHz
153	5765MHz	165	5825MHz
157	5785MHz		

2 channels are provided for 802.11n (40MHz):

CHANNEL	FREQUENCY	CHANNEL	FREQUENCY
151	5755MHz	159	5795MHz

1 channel is provided for 802.11ac (80MHz):

CHANNEL	FREQUENCY
155	5775MHz



A D T

3.2.1 TEST MODE APPLICABILITY AND TESTED CHANNEL DETAIL

EUT CONFIGURE MODE	APPLICABLE TO				DESCRIPTION
	RE≥1G	RE<1G	PLC	APCM	
-	√	√	√	√	-

Where **RE≥1G**: Radiated Emission above 1GHz **RE<1G**: Radiated Emission below 1GHz
PLC: Power Line Conducted Emission **APCM**: Antenna Port Conducted Measurement

NOTE: The EUT had been pre-tested on the positioned of each 3 axis. The worst case was found when positioned on **Y-plane** for 5180-5240MHz & 5260-5320MHz, **X-plane** for 5500-5700MHz, and **Z-plane** for 5745-5825MHz.

RADIATED EMISSION TEST (ABOVE 1GHz):

Pre-Scan has been conducted to determine the worst-case mode from all possible combinations between available modulations, data rates and antenna ports (if EUT with antenna diversity architecture).

Following channel(s) was (were) selected for the final test as listed below.

EUT CONFIGURE MODE	MODE	FREQ. BAND (MHz)	AVAILABLE CHANNEL	TESTED CHANNEL	MODULATION TECHNOLOGY	MODULATION TYPE	DATA RATE (Mbps)
-	802.11a	5180-5240	36 to 48	36, 44, 48	OFDM	BPSK	6.0
	802.11n (20MHz)		36 to 48	36, 44, 48	OFDM	BPSK	MCS0
	802.11n (40MHz)		38 to 46	38, 46	OFDM	BPSK	MCS0
	802.11ac (80MHz)		42	42	OFDM	BPSK	V0
-	802.11a	5260-5320	52 to 64	52, 60, 64	OFDM	BPSK	6.0
	802.11n (20MHz)		52 to 64	52, 60, 64	OFDM	BPSK	MCS0
	802.11n (40MHz)		54 to 62	54, 62	OFDM	BPSK	MCS0
	802.11ac (80MHz)		58	58	OFDM	BPSK	V0
-	802.11a	5500-5700	100 to 140	100, 116, 140	OFDM	BPSK	6.0
	802.11n (20MHz)		100 to 140	100, 116, 140	OFDM	BPSK	MCS0
	802.11n (40MHz)		102 to 134	102, 110, 134	OFDM	BPSK	MCS0
	802.11ac (80MHz)		106	106	OFDM	BPSK	V0
-	802.11a	5745-5825	149 to 161	149, 157, 165	OFDM	BPSK	6.0
	802.11n (20MHz)		149 to 161	149, 157, 165	OFDM	BPSK	MCS0
	802.11n (40MHz)		151 to 159	151, 159	OFDM	BPSK	MCS0
	802.11ac (80MHz)		155	155	OFDM	BPSK	V0



A D T

RADIATED EMISSION TEST (BELOW 1GHz):

Pre-Scan has been conducted to determine the worst-case mode from all possible combinations between available modulations, data rates and antenna ports (if EUT with antenna diversity architecture).

Following channel(s) was (were) selected for the final test as listed below.

EUT CONFIGURE MODE	MODE	FREQ. BAND (MHz)	AVAILABLE CHANNEL	TESTED CHANNEL	MODULATION TECHNOLOGY	MODULATION TYPE	DATA RATE (Mbps)
-	802.11n (40MHz)	5180-5240	38 to 46	38	OFDM	BPSK	MCS0
-	802.11n (40MHz)	5260-5320	54 to 62	62	OFDM	BPSK	MCS0
-	802.11n (20MHz)	5500-5700	100 to 140	140	OFDM	BPSK	MCS0
-	802.11n (20MHz)	5745-5825	149 to 161	149	OFDM	BPSK	MCS0

POWER LINE CONDUCTED EMISSION TEST:

EUT CONFIGURE MODE	MODE	FREQ. BAND (MHz)	AVAILABLE CHANNEL	TESTED CHANNEL	MODULATION TECHNOLOGY	MODULATION TYPE	DATA RATE (Mbps)
-	802.11n (20MHz)	5500-5700	100 to 140	140	OFDM	BPSK	MCS0

BANDEDGE MEASUREMENT:

Pre-Scan has been conducted to determine the worst-case mode from all possible combinations between available modulations, data rates and antenna ports (if EUT with antenna diversity architecture).

Following channel(s) was (were) selected for the final test as listed below.

EUT CONFIGURE MODE	MODE	FREQ. BAND (MHz)	AVAILABLE CHANNEL	TESTED CHANNEL	MODULATION TECHNOLOGY	MODULATION TYPE	DATA RATE (Mbps)
-	802.11a	5180-5240	36 to 48	36, 44, 48	OFDM	BPSK	6.0
	802.11n (20MHz)		36 to 48	36, 44, 48	OFDM	BPSK	MCS0
	802.11n (40MHz)		38 to 46	38, 46	OFDM	BPSK	MCS0
	802.11ac (80MHz)		42	42	OFDM	BPSK	V0
-	802.11a	5260-5320	52 to 64	52, 60, 64	OFDM	BPSK	6.0
	802.11n (20MHz)		52 to 64	52, 60, 64	OFDM	BPSK	MCS0
	802.11n (40MHz)		54 to 62	54, 62	OFDM	BPSK	MCS0
	802.11ac (80MHz)		58	58	OFDM	BPSK	V0
-	802.11a	5500-5700	100 to 140	100, 116, 140	OFDM	BPSK	6.0
	802.11n (20MHz)		100 to 140	100, 116, 140	OFDM	BPSK	MCS0
	802.11n (40MHz)		102 to 134	102, 110, 134	OFDM	BPSK	MCS0
	802.11ac (80MHz)		106	106	OFDM	BPSK	V0
-	802.11a	5745-5825	149 to 161	149, 157, 165	OFDM	BPSK	6.0
	802.11n (20MHz)		149 to 161	149, 157, 165	OFDM	BPSK	MCS0
	802.11n (40MHz)		151 to 159	151, 159	OFDM	BPSK	MCS0
	802.11ac (80MHz)		155	155	OFDM	BPSK	V0



A D T

ANTENNA PORT CONDUCTED MEASUREMENT:

- This item includes all test value of each mode, but only includes spectrum plot of worst value of each mode.
- Pre-Scan has been conducted to determine the worst-case mode from all possible combinations between available modulations, data rates and antenna ports (if EUT with antenna diversity architecture).
- Following channel(s) was (were) selected for the final test as listed below.

EUT CONFIGURE MODE	MODE	FREQ. BAND (MHz)	AVAILABLE CHANNEL	TESTED CHANNEL	MODULATION TECHNOLOGY	MODULATION TYPE	DATA RATE (Mbps)
-	802.11a	5180-5240	36 to 48	36, 44, 48	OFDM	BPSK	6.0
	802.11n (20MHz)		36 to 48	36, 44, 48	OFDM	BPSK	MCS0
	802.11n (40MHz)		38 to 46	38, 46	OFDM	BPSK	MCS0
	802.11ac (80MHz)		42	42	OFDM	BPSK	V0
-	802.11a	5260-5320	52 to 64	52, 60, 64	OFDM	BPSK	6.0
	802.11n (20MHz)		52 to 64	52, 60, 64	OFDM	BPSK	MCS0
	802.11n (40MHz)		54 to 62	54, 62	OFDM	BPSK	MCS0
	802.11ac (80MHz)		58	58	OFDM	BPSK	V0
-	802.11a	5500-5700	100 to 140	100, 116, 140	OFDM	BPSK	6.0
	802.11n (20MHz)		100 to 140	100, 116, 140	OFDM	BPSK	MCS0
	802.11n (40MHz)		102 to 134	102, 110, 134	OFDM	BPSK	MCS0
	802.11ac (80MHz)		106	106	OFDM	BPSK	V0
-	802.11a	5745-5825	149 to 161	149, 157, 165	OFDM	BPSK	6.0
	802.11n (20MHz)		149 to 161	149, 157, 165	OFDM	BPSK	MCS0
	802.11n (40MHz)		151 to 159	151, 159	OFDM	BPSK	MCS0
	802.11ac (80MHz)		155	155	OFDM	BPSK	V0

Test CONDITION:

APPLICABLE TO	ENVIRONMENTAL CONDITIONS	INPUT POWER	TESTED BY
RE≥1G	25deg. C, 65%RH	120Vac, 60Hz	Will Chen
RE<1G	25deg. C, 65%RH	120Vac, 60Hz	Will Chen
PLC	25deg. C, 65%RH	120Vac, 60Hz	Anson Lin
APCM	25deg. C, 65%RH	120Vac, 60Hz	Howard Kao

3.3 DESCRIPTION OF SUPPORT UNITS

The EUT has been tested as an independent unit together with other necessary accessories or support units.

3.3.1 CONFIGURATION OF SYSTEM UNDER TEST

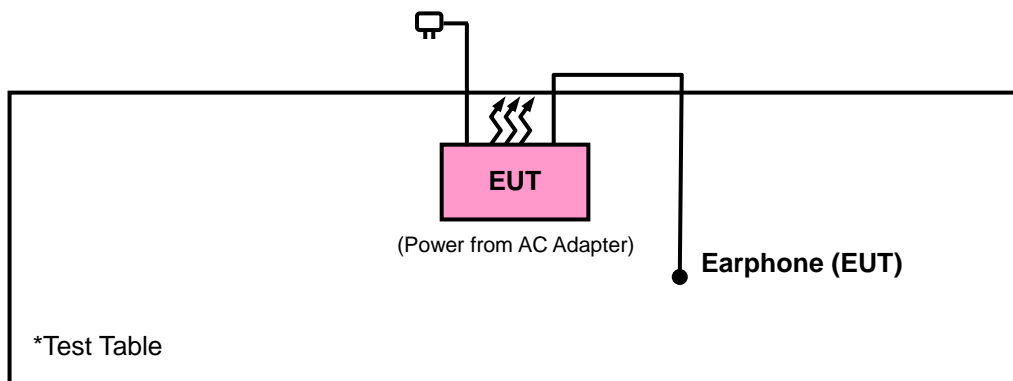

3.4 DUTY CYCLE TEST SIGNAL

MODULATION TYPE: BPSK

If duty cycle is < 98%, duty factor shall be considered.

802.11a: Duty cycle = 2.059/2.163 = 0.952, Duty factor = $10 \cdot \log(1/0.952) = 0.21$

802.11n (20MHz): Duty cycle = 1.915/2.027 = 0.945, Duty factor = $10 \cdot \log(1/0.945) = 0.25$

802.11n (40MHz): Duty cycle = 905.77/1041.99 = 0.869, Duty factor = $10 \cdot \log(1/0.869) = 0.61$

802.11ac (80MHz): Duty cycle = 432.69/552.88 = 0.783, Duty factor = $10 \cdot \log(1/0.783) = 1.06$

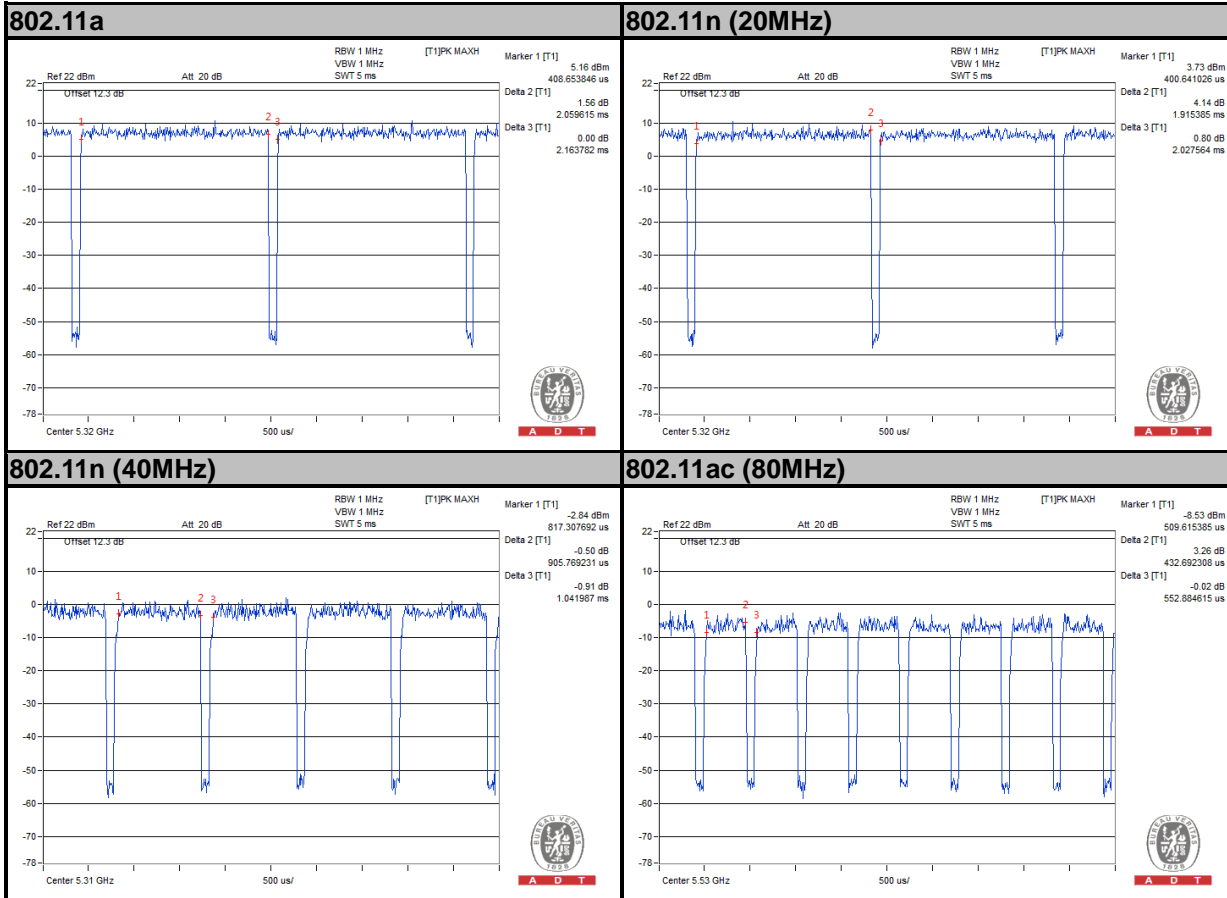



A D T

MODULATION TYPE: QPSK

If duty cycle is < 98%, duty factor shall be considered.

802.11a: Duty cycle = 1.042/1.154 = 0.903, Duty factor = $10 \cdot \log(1/0.903) = 0.44$

802.11n (20MHz): Duty cycle = 969.87/1082.05 = 0.896, Duty factor = $10 \cdot \log(1/0.896) = 0.48$

802.11n (40MHz): Duty cycle = 457.05/585.26 = 0.781, Duty factor = $10 \cdot \log(1/0.781) = 1.07$

802.11ac (80MHz): Duty cycle = 246.79/347.76 = 0.710, Duty factor = $10 \cdot \log(1/0.710) = 1.49$

802.11a

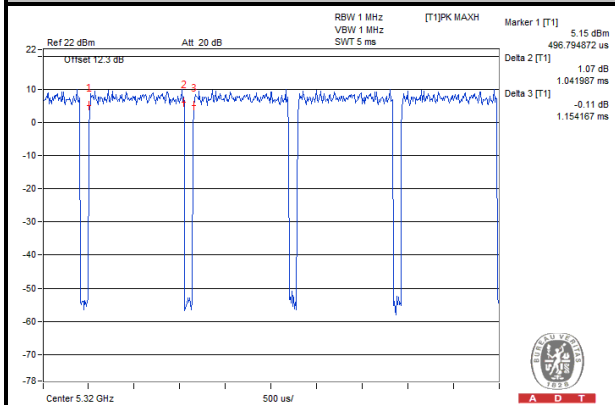

802.11n (20MHz)

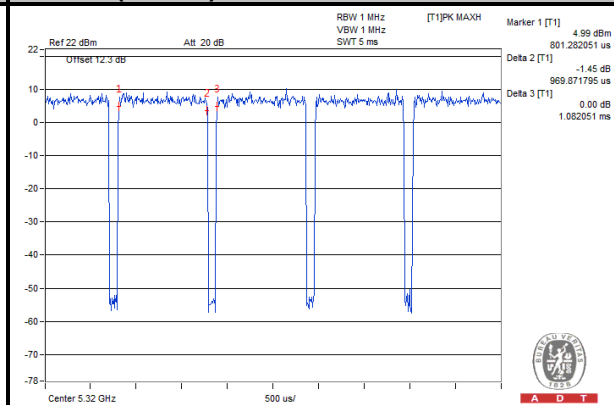

802.11n (40MHz)

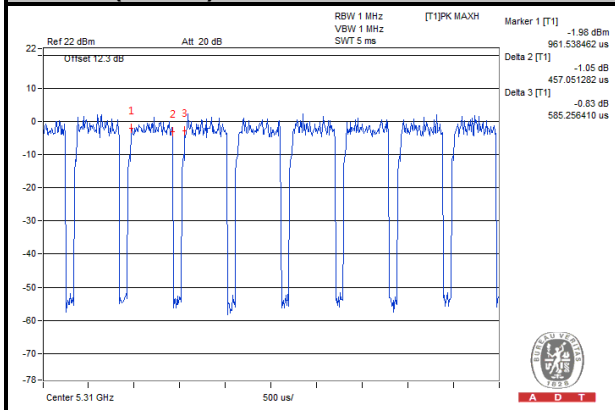

802.11ac (80MHz)

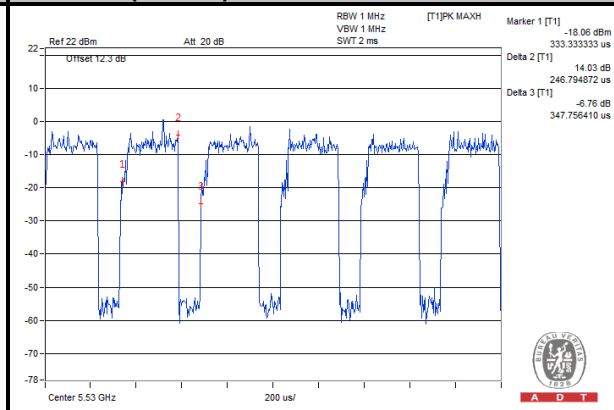



A D T

MODULATION TYPE: 16QAM

If duty cycle is < 98%, duty factor shall be considered.

802.11a: Duty cycle = 529.17/633.33 = 0.835, Duty factor = $10 * \log(1/0.835) = 0.78$

802.11n (20MHz): Duty cycle = 497.11/609.29 = 0.816, Duty factor = $10 * \log(1/0.816) = 0.88$

802.11n (40MHz): Duty cycle = 240.70/368.91 = 0.652, Duty factor = $10 * \log(1/0.652) = 1.85$

802.11ac (80MHz): Duty cycle = 141.02/248.40 = 0.568, Duty factor = $10 * \log(1/0.568) = 2.46$

802.11a

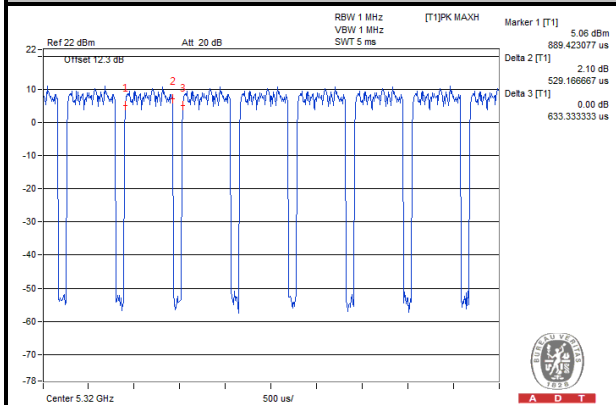

802.11n (20MHz)

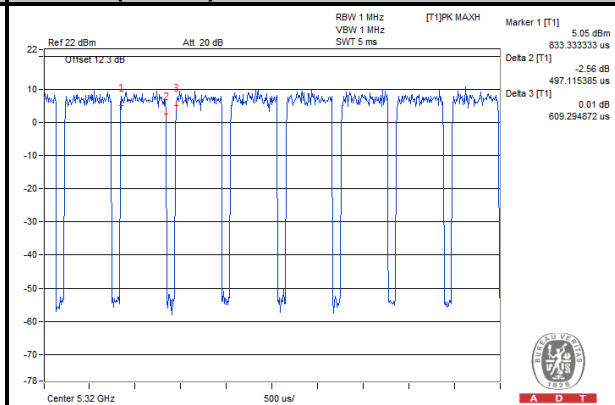

802.11n (40MHz)

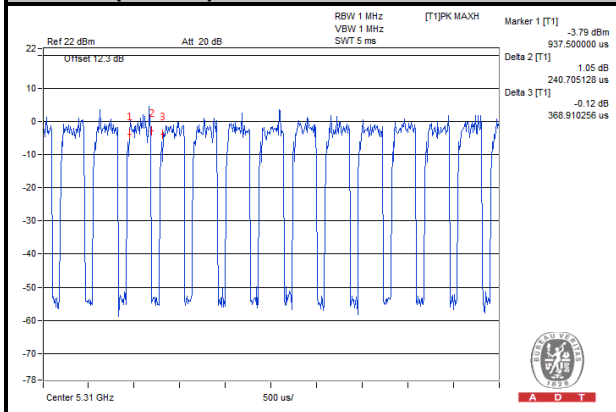

802.11ac (80MHz)

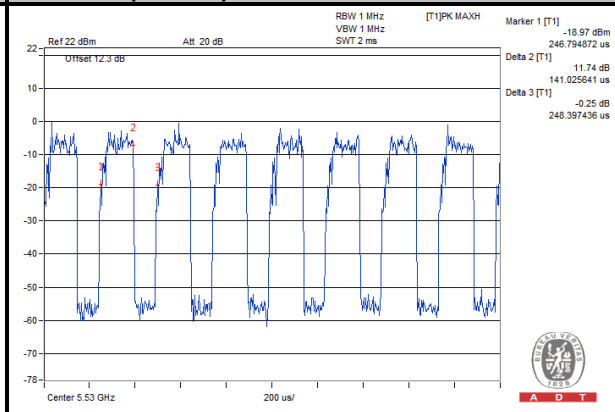



A D T

MODULATION TYPE: 64QAM

If duty cycle is < 98%, duty factor shall be considered.

802.11a: Duty cycle = 272.76/384.93 = 0.708, Duty factor = 10 * log(1/0.708) = 1.50

802.11n (20MHz): Duty cycle = 264.74/360.90 = 0.733, Duty factor = 10 * log(1/0.733) = 1.35

802.11n (40MHz): Duty cycle = 154.17/253.52 = 0.608, Duty factor = 10 * log(1/0.608) = 2.16

802.11ac (80MHz): Duty cycle = 92.94/197.11 = 0.471, Duty factor = 10 * log(1/0.471) = 3.26

802.11a

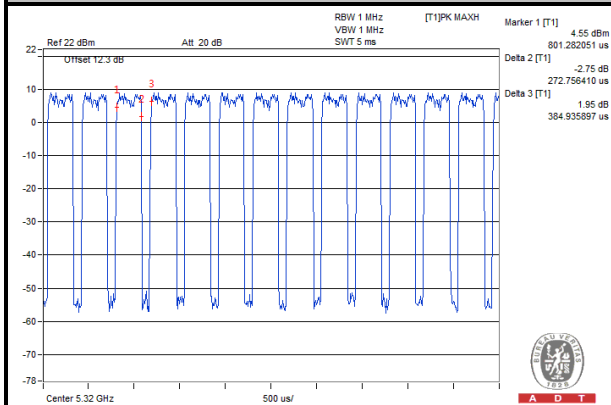

802.11n (20MHz)

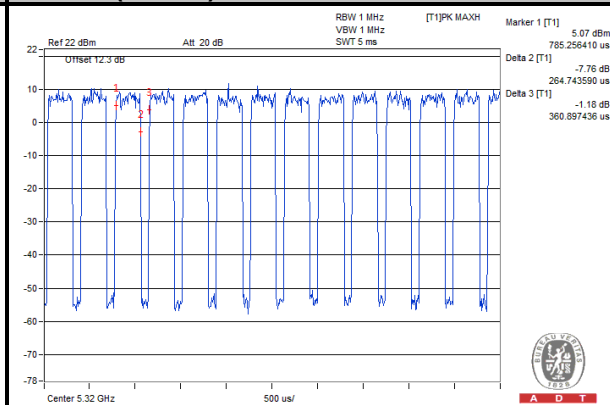

802.11n (40MHz)

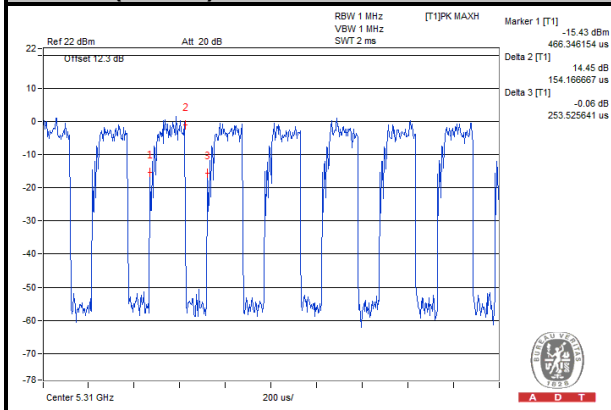

802.11ac (80MHz)

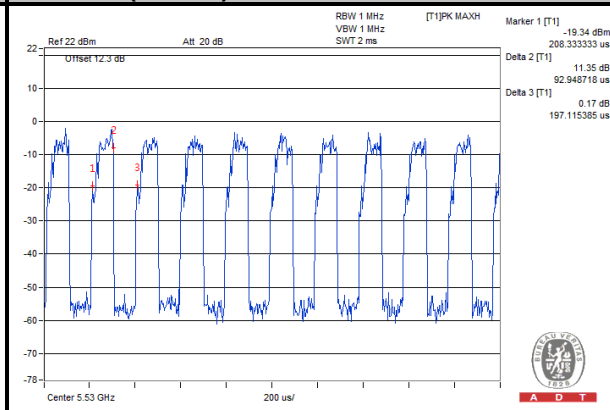



A D T

MODULATION TYPE: 256QAM

If duty cycle is < 98%, duty factor shall be considered.

802.11ac (80MHz): Duty cycle = 64.10/174.68 = 0.367, Duty factor = $10 * \log(1/0.367) = 4.35$

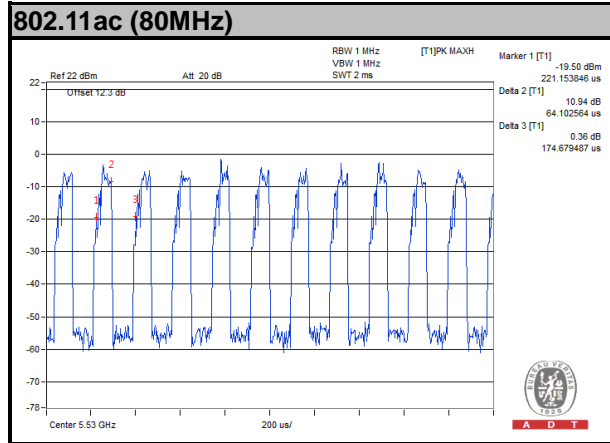

3.5 GENERAL DESCRIPTION OF APPLIED STANDARDS

The EUT is a RF Product. According to the specifications of the manufacturer, it must comply with the requirements of the following standards:

FCC Part 15, Subpart E (15.407)

789033 D02 General UNII Test Procedures New Rules v01

644545 D01 Guidance for IEEE 802 11ac v01r02

ANSI C63.10-2009

All test items have been performed and recorded as per the above standards.

NOTE: The EUT has been verified to comply with the requirements of FCC Part 15, Subpart B, Class B (DoC). The test report has been issued separately.

4. TEST TYPES AND RESULTS

4.1 RADIATED EMISSION AND BANDEDGE MEASUREMENT

4.1.1 LIMITS OF RADIATED EMISSION AND BANDEDGE MEASUREMENT

Radiated emissions which fall in the restricted bands must comply with the radiated emission limits specified as below table:

FREQUENCIES (MHz)	FIELD STRENGTH (microvolts/meter)	MEASUREMENT DISTANCE (meters)
0.009 ~ 0.490	2400/F(kHz)	300
0.490 ~ 1.705	24000/F(kHz)	30
1.705 ~ 30.0	30	30
30 ~ 88	100	3
88 ~ 216	150	3
216 ~ 960	200	3
Above 960	500	3

NOTE:

1. The lower limit shall apply at the transition frequencies.
2. Emission level (dBuV/m) = 20 log Emission level (uV/m).
3. For frequencies above 1000MHz, the field strength limits are based on average detector, however, the peak field strength of any emission shall not exceed the maximum permitted average limits, specified above by more than 20dB under any condition of modulation.

4.1.2 LIMITS OF UNWANTED EMISSION OUT OF THE RESTRICTED BANDS

APPLICABLE TO	LIMIT	
789033 D02 General UNII Test Procedures New Rules v01	FIELD STRENGTH AT 3m	
	PK: 74 (dBµV/m)	AV: 54 (dBµV/m)
APPLICABLE TO	EIRP LIMIT	EQUIVALENT FIELD STRENGTH AT 3m
15.407(b)(1)	PK: -27 (dBm/MHz)	PK: 68.2 (dBµV/m)
15.407(b)(2)		
15.407(b)(3)		
15.407(b)(4)	PK: -27 (dBm/MHz) ^{*1} PK: -17 (dBm/MHz) ^{*2}	PK: 68.2 (dBµV/m) ^{*1} PK: 78.2 (dBµV/m) ^{*2}

NOTE: ^{*1} beyond 10MHz of the band edge ^{*2} within 10 MHz of band edge

The following formula is used to convert the equipment isotropic radiated power (eirp) to field strength:

$$E = \frac{1000000\sqrt{30P}}{3} \mu\text{V/m, where P is the eirp (Watts).}$$



A D T

4.1.3 TEST INSTRUMENTS

DESCRIPTION & MANUFACTURER	MODEL NO.	SERIAL NO.	DATE OF CALIBRATION	DUE DATE OF CALIBRATION
Test Receiver ROHDE & SCHWARZ	ESCI	100744	Apr. 15, 2014	Apr. 14, 2015
Spectrum Analyzer ROHDE & SCHWARZ	FSU43	101261	Dec. 10, 2014	Dec. 09, 2015
BILOG Antenna SCHWARZBECK	VULB9168	9168-472	Feb. 27, 2014	Feb. 26, 2015
HORN Antenna SCHWARZBECK	BBHA 9120 D	9120D-969	Feb. 19, 2014	Feb. 18, 2015
HORN Antenna SCHWARZBECK	BBHA 9170	9170-480	Aug. 27, 2014	Aug. 26, 2015
Loop Antenna	HFH2-Z2	100070	Mar. 06, 2014	Mar. 05, 2016
Preamplifier EMCI	EMC 012645	980115	Dec. 12, 2014	Dec. 11, 2015
Preamplifier EMCI	EMC 184045	980116	Jan. 13, 2014	Jan. 12, 2015
Preamplifier EMCI	EMC 330H	980071	Feb. 27, 2014	Feb. 26, 2015
RF signal cable HUBER+SUHNNER	SUCOFLEX 104	309219/4 2950114	Oct. 18, 2014	Oct. 17, 2015
RF signal cable HUBER+SUHNNER	SUCOFLEX 104	250130/4	Oct. 18, 2014	Oct. 17, 2015
RF signal cable Worken	RG-213	NA	Nov. 07, 2014	Nov. 06, 2015
Software BV ADT	E3 6.120103	NA	NA	NA
Antenna Tower MF	MFA-440H	NA	NA	NA
Turn Table MF	MFT-201SS	NA	NA	NA
Antenna Tower & Turn Table Controller MF	MF-7802	NA	NA	NA
Power Meter	ML2495A	1232002	Sep. 17, 2014	Sep. 16, 2015
Power Sensor	MA2411B	1207325	Sep. 17, 2014	Sep. 16, 2015

- NOTE:**
1. The calibration interval of the above test instruments is 12 months and the calibrations are traceable to NML/ROC and NIST/USA.
 2. The calibration interval of the loop antenna is 24 months and the calibrations are traceable to NML/ROC and NIST/USA.
 3. The test was performed in HwaYa Chamber 10.
 4. The horn antenna and HP preamplifier (model: 8449B) are used only for the measurement of emission frequency above 1GHz if tested.
 5. The FCC Site Registration No. is 690701.
 6. The IC Site Registration No. is IC 7450F-10.

4.1.4 TEST PROCEDURES

- a. The EUT was placed on the top of a rotating table 0.8 meters above the ground at a 3 meters semi-anechoic chamber. The table was rotated 360 degrees to determine the position of the highest radiation.
- b. The EUT was set 3 meters away from the interference-receiving antenna, which was mounted on the top of a variable-height antenna tower.
- c. The antenna is a broadband antenna, and its height is varied from one meter to four meters above the ground to determine the maximum value of the field strength. Both horizontal and vertical polarizations of the antenna are set to make the measurement.
- d. For each suspected emission, the EUT was arranged to its worst case and then the antenna was tuned to heights from 1 meter to 4 meters and the rotatable table was turned from 0 degrees to 360 degrees to find the maximum reading.
- e. The test-receiver system was set to Peak Detect Function and Specified Bandwidth with Maximum Hold Mode.
- f. If the emission level of the EUT in peak mode was 10dB lower than the limit specified, then testing could be stopped and the peak values of the EUT would be reported. Otherwise the emissions that did not have 10dB margin would be re-tested one by one using peak, quasi-peak or average method as specified and then reported in a data sheet.

NOTE:

1. The resolution bandwidth and video bandwidth of test receiver/spectrum analyzer is 120kHz for Peak detection (PK) and Quasi-peak detection (QP) at frequency below 1GHz.
2. The resolution bandwidth of test receiver/spectrum analyzer is 1MHz and video bandwidth is 3MHz for Peak detection at frequency above 1GHz.
3. The resolution bandwidth of test receiver/spectrum analyzer is 1MHz and the video bandwidth is 1kHz (Duty cycle < 98%) or 10Hz (Duty cycle > 98%) for Average detection (AV) at frequency above 1GHz.
4. All modes of operation were investigated and the worst-case emissions are reported.

4.1.5 DEVIATION FROM TEST STANDARD

No deviation.

4.1.6 TEST SETUP

Frequency Range 30MHz ~ 1GHz

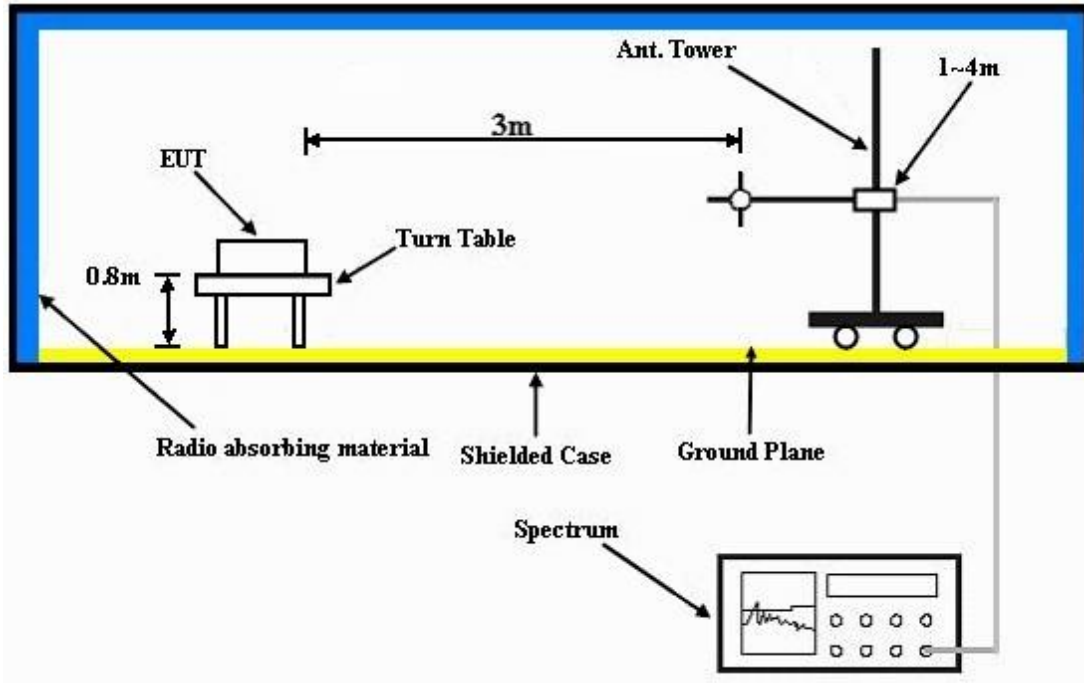

Frequency Range above 1GHz

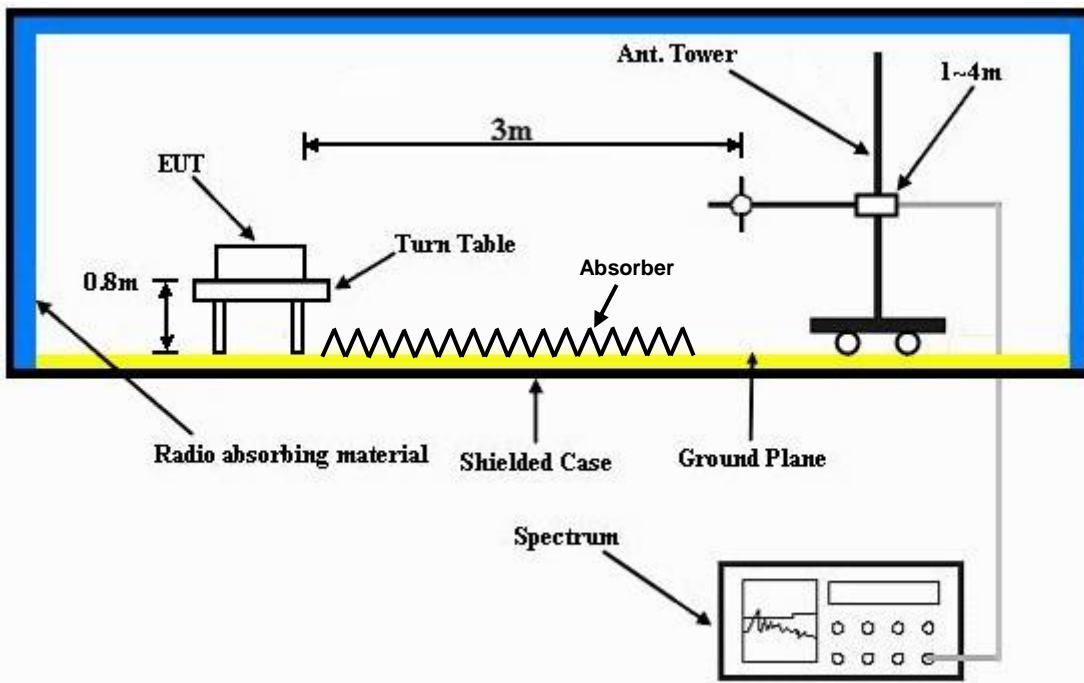

For the actual test configuration, please refer to the attached file (Test Setup Photo).



A D T

4.1.7 EUT OPERATING CONDITIONS

- a. Placed the EUT on a testing table.
- b. Use the software to control the EUT under transmission condition continuously at specific channel frequency.



A D T

4.1.8 TEST RESULTS

ABOVE 1GHz WORST-CASE DATA

802.11a

EUT TEST CONDITION		MEASUREMENT DETAIL	
CHANNEL	Channel 36	FREQUENCY RANGE	1GHz ~ 40GHz
INPUT POWER	120Vac, 60 Hz	DETECTOR FUNCTION	Peak (PK) Average (AV)
ENVIRONMENTAL CONDITIONS	25deg. C, 65%RH	TESTED BY	Will Chen

ANTENNA POLARITY & TEST DISTANCE: HORIZONTAL AT 3 M										
FREQ. (MHz)	EMISSION LEVEL (dBuV/m)	READ LEVEL (dBuV)	LIMIT (dBuV/m)	MARGIN (dB)	ANTENNA FACTOR (dB/m)	CABLE LOSS (dB)	PREAMP FACTOR (dB)	ANTENNA HEIGHT (cm)	TABLE ANGLE (Degree)	REMARK
5150	46.36	38.11	54	-7.64	34.12	8.13	34	162	301	Average
5150	57.84	49.59	74	-16.16	34.12	8.13	34	162	301	Peak
5180	96.71	88.4			34.15	8.16	34	162	301	Average
5180	104.18	95.87			34.15	8.16	34	162	301	Peak
5360	42.83	34.2	54	-11.17	34.28	8.38	34.03	162	301	Average
5360	56.7	48.07	74	-17.3	34.28	8.38	34.03	162	301	Peak
ANTENNA POLARITY & TEST DISTANCE: VERTICAL AT 3 M										
FREQ. (MHz)	EMISSION LEVEL (dBuV/m)	READ LEVEL (dBuV)	LIMIT (dBuV/m)	MARGIN (dB)	ANTENNA FACTOR (dB/m)	CABLE LOSS (dB)	PREAMP FACTOR (dB)	ANTENNA HEIGHT (cm)	TABLE ANGLE (Degree)	REMARK
5148	48.74	40.49	54	-5.26	34.12	8.13	34	144	270	Average
5148	60.74	52.49	74	-13.26	34.12	8.13	34	144	270	Peak
5180	99.22	90.91			34.15	8.16	34	144	270	Average
5180	107.38	99.07			34.15	8.16	34	144	270	Peak
5442	42.73	33.94	54	-11.27	34.35	8.48	34.04	144	270	Average
5442	56.86	48.07	74	-17.14	34.35	8.48	34.04	144	270	Peak

REMARKS:

- Emission Level = Read Level + Antenna Factor + Cable Loss - Preamp Factor
Margin value = Emission level – Limit value
- 5180MHz: Fundamental frequency.



A D T

EUT TEST CONDITION		MEASUREMENT DETAIL	
CHANNEL	Channel 44	FREQUENCY RANGE	1GHz ~ 40GHz
INPUT POWER	120Vac, 60 Hz	DETECTOR FUNCTION	Peak (PK) Average (AV)
ENVIRONMENTAL CONDITIONS	25deg. C, 65%RH	TESTED BY	Will Chen

ANTENNA POLARITY & TEST DISTANCE: HORIZONTAL AT 3 M										
FREQ. (MHz)	EMISSION LEVEL (dBuV/m)	READ LEVEL (dBuV)	LIMIT (dBuV/m)	MARGIN (dB)	ANTENNA FACTOR (dB/m)	CABLE LOSS (dB)	PREAMP FACTOR (dB)	ANTENNA HEIGHT (cm)	TABLE ANGLE (Degree)	REMARK
5072	42.9	34.78	54	-11.1	34.07	8.03	33.98	162	286	Average
5072	58.01	49.89	74	-15.99	34.07	8.03	33.98	162	286	Peak
5220	96.93	88.54			34.17	8.22	34	162	286	Average
5220	104.05	95.66			34.17	8.22	34	162	286	Peak
5436	42.9	34.11	54	-11.1	34.35	8.48	34.04	162	286	Average
5436	59.59	50.8	74	-14.41	34.35	8.48	34.04	162	286	Peak
ANTENNA POLARITY & TEST DISTANCE: VERTICAL AT 3 M										
FREQ. (MHz)	EMISSION LEVEL (dBuV/m)	READ LEVEL (dBuV)	LIMIT (dBuV/m)	MARGIN (dB)	ANTENNA FACTOR (dB/m)	CABLE LOSS (dB)	PREAMP FACTOR (dB)	ANTENNA HEIGHT (cm)	TABLE ANGLE (Degree)	REMARK
5050	43.59	35.53	54	-10.41	34.04	8	33.98	144	270	Average
5050	58.76	50.7	74	-15.24	34.04	8	33.98	144	270	Peak
5220	99.84	91.45			34.17	8.22	34	144	270	Average
5220	107.35	98.96			34.17	8.22	34	144	270	Peak
5460	42.77	33.95	54	-11.23	34.36	8.51	34.05	144	270	Average
5460	59.15	50.33	74	-14.85	34.36	8.51	34.05	144	270	Peak

REMARKS:

- Emission Level = Read Level + Antenna Factor + Cable Loss - Preamp Factor
Margin value = Emission level – Limit value
- 5220MHz: Fundamental frequency.



A D T

EUT TEST CONDITION		MEASUREMENT DETAIL	
CHANNEL	Channel 48	FREQUENCY RANGE	1GHz ~ 40GHz
INPUT POWER	120Vac, 60 Hz	DETECTOR FUNCTION	Peak (PK) Average (AV)
ENVIRONMENTAL CONDITIONS	25deg. C, 65%RH	TESTED BY	Will Chen

ANTENNA POLARITY & TEST DISTANCE: HORIZONTAL AT 3 M										
FREQ. (MHz)	EMISSION LEVEL (dBuV/m)	READ LEVEL (dBuV)	LIMIT (dBuV/m)	MARGIN (dB)	ANTENNA FACTOR (dB/m)	CABLE LOSS (dB)	PREAMP FACTOR (dB)	ANTENNA HEIGHT (cm)	TABLE ANGLE (Degree)	REMARK
5070	42.69	34.59	54	-11.31	34.05	8.03	33.98	162	301	Average
5070	58.36	50.26	74	-15.64	34.05	8.03	33.98	162	301	Peak
5240	96.75	88.31			34.19	8.26	34.01	162	301	Average
5240	103.97	95.53			34.19	8.26	34.01	162	301	Peak
5350	42.85	34.22	54	-11.15	34.28	8.38	34.03	162	301	Average
5350	59.77	51.14	74	-14.23	34.28	8.38	34.03	162	301	Peak
ANTENNA POLARITY & TEST DISTANCE: VERTICAL AT 3 M										
FREQ. (MHz)	EMISSION LEVEL (dBuV/m)	READ LEVEL (dBuV)	LIMIT (dBuV/m)	MARGIN (dB)	ANTENNA FACTOR (dB/m)	CABLE LOSS (dB)	PREAMP FACTOR (dB)	ANTENNA HEIGHT (cm)	TABLE ANGLE (Degree)	REMARK
5086	42.58	34.42	54	-11.42	34.07	8.07	33.98	141	270	Average
5086	58.86	50.7	74	-15.14	34.07	8.07	33.98	141	270	Peak
5240	99.84	91.4			34.19	8.26	34.01	141	270	Average
5240	107.63	99.19			34.19	8.26	34.01	141	270	Peak
5454	43.21	34.39	54	-10.79	34.36	8.51	34.05	141	270	Average
5454	59.89	51.07	74	-14.11	34.36	8.51	34.05	141	270	Peak

REMARKS:

- Emission Level = Read Level + Antenna Factor + Cable Loss - Preamp Factor
Margin value = Emission level – Limit value
- 5240MHz: Fundamental frequency.



A D T

EUT TEST CONDITION		MEASUREMENT DETAIL	
CHANNEL	Channel 52	FREQUENCY RANGE	1GHz ~ 40GHz
INPUT POWER	120Vac, 60 Hz	DETECTOR FUNCTION	Peak (PK) Average (AV)
ENVIRONMENTAL CONDITIONS	25deg. C, 65%RH	TESTED BY	Will Chen

ANTENNA POLARITY & TEST DISTANCE: HORIZONTAL AT 3 M										
FREQ. (MHz)	EMISSION LEVEL (dBuV/m)	READ LEVEL (dBuV)	LIMIT (dBuV/m)	MARGIN (dB)	ANTENNA FACTOR (dB/m)	CABLE LOSS (dB)	PREAMP FACTOR (dB)	ANTENNA HEIGHT (cm)	TABLE ANGLE (Degree)	REMARK
5054	42.51	34.45	54	-11.49	34.04	8	33.98	152	291	Average
5054	58.36	50.3	74	-15.64	34.04	8	33.98	152	291	Peak
5260	97.47	89.01			34.21	8.26	34.01	152	291	Average
5260	105.48	97.02			34.21	8.26	34.01	152	291	Peak
5446	43.09	34.26	54	-10.91	34.36	8.51	34.04	152	291	Average
5446	58.86	50.03	74	-15.14	34.36	8.51	34.04	152	291	Peak
ANTENNA POLARITY & TEST DISTANCE: VERTICAL AT 3 M										
FREQ. (MHz)	EMISSION LEVEL (dBuV/m)	READ LEVEL (dBuV)	LIMIT (dBuV/m)	MARGIN (dB)	ANTENNA FACTOR (dB/m)	CABLE LOSS (dB)	PREAMP FACTOR (dB)	ANTENNA HEIGHT (cm)	TABLE ANGLE (Degree)	REMARK
5092	42.6	34.43	54	-11.4	34.08	8.07	33.98	140	270	Average
5092	58.57	50.4	74	-15.43	34.08	8.07	33.98	140	270	Peak
5260	100.79	92.33			34.21	8.26	34.01	140	270	Average
5260	108.36	99.9			34.21	8.26	34.01	140	270	Peak
5438	43.33	34.54	54	-10.67	34.35	8.48	34.04	140	270	Average
5438	58.56	49.77	74	-15.44	34.35	8.48	34.04	140	270	Peak

REMARKS:

- Emission Level = Read Level + Antenna Factor + Cable Loss - Preamp Factor
Margin value = Emission level – Limit value
- 5260MHz: Fundamental frequency.



A D T

EUT TEST CONDITION		MEASUREMENT DETAIL	
CHANNEL	Channel 60	FREQUENCY RANGE	1GHz ~ 40GHz
INPUT POWER	120Vac, 60 Hz	DETECTOR FUNCTION	Peak (PK) Average (AV)
ENVIRONMENTAL CONDITIONS	25deg. C, 65%RH	TESTED BY	Will Chen

ANTENNA POLARITY & TEST DISTANCE: HORIZONTAL AT 3 M										
FREQ. (MHz)	EMISSION LEVEL (dBuV/m)	READ LEVEL (dBuV)	LIMIT (dBuV/m)	MARGIN (dB)	ANTENNA FACTOR (dB/m)	CABLE LOSS (dB)	PREAMP FACTOR (dB)	ANTENNA HEIGHT (cm)	TABLE ANGLE (Degree)	REMARK
5094	42.68	34.52	54	-11.32	34.08	8.07	33.99	152	291	Average
5094	59.17	51.01	74	-14.83	34.08	8.07	33.99	152	291	Peak
5300	98.19	89.65			34.24	8.32	34.02	152	291	Average
5300	105.64	97.1			34.24	8.32	34.02	152	291	Peak
5442	44.62	35.83	54	-9.38	34.35	8.48	34.04	152	291	Average
5442	59.14	50.35	74	-14.86	34.35	8.48	34.04	152	291	Peak
ANTENNA POLARITY & TEST DISTANCE: VERTICAL AT 3 M										
FREQ. (MHz)	EMISSION LEVEL (dBuV/m)	READ LEVEL (dBuV)	LIMIT (dBuV/m)	MARGIN (dB)	ANTENNA FACTOR (dB/m)	CABLE LOSS (dB)	PREAMP FACTOR (dB)	ANTENNA HEIGHT (cm)	TABLE ANGLE (Degree)	REMARK
5114	42.51	34.31	54	-11.49	34.09	8.1	33.99	140	270	Average
5114	58.88	50.68	74	-15.12	34.09	8.1	33.99	140	270	Peak
5300	101.03	92.49			34.24	8.32	34.02	140	270	Average
5300	108.88	100.34			34.24	8.32	34.02	140	270	Peak
5368	45.66	36.99	54	-8.34	34.29	8.41	34.03	140	270	Average
5368	59.72	51.05	74	-14.28	34.29	8.41	34.03	140	270	Peak

REMARKS:

- Emission Level = Read Level + Antenna Factor + Cable Loss - Preamp Factor
Margin value = Emission level – Limit value
- 5300MHz: Fundamental frequency.



A D T

EUT TEST CONDITION		MEASUREMENT DETAIL	
CHANNEL	Channel 64	FREQUENCY RANGE	1GHz ~ 40GHz
INPUT POWER	120Vac, 60 Hz	DETECTOR FUNCTION	Peak (PK) Average (AV)
ENVIRONMENTAL CONDITIONS	25deg. C, 65%RH	TESTED BY	Will Chen

ANTENNA POLARITY & TEST DISTANCE: HORIZONTAL AT 3 M

FREQ. (MHz)	EMISSION LEVEL (dBuV/m)	READ LEVEL (dBuV)	LIMIT (dBuV/m)	MARGIN (dB)	ANTENNA FACTOR (dB/m)	CABLE LOSS (dB)	PREAMP FACTOR (dB)	ANTENNA HEIGHT (cm)	TABLE ANGLE (Degree)	REMARK
5014	42.32	34.31	54	-11.68	34.01	7.97	33.97	152	291	Average
5014	59.45	51.44	74	-14.55	34.01	7.97	33.97	152	291	Peak
5320	98.22	89.64			34.25	8.35	34.02	152	291	Average
5320	105.63	97.05			34.25	8.35	34.02	152	291	Peak
5352	47.66	39.03	54	-6.34	34.28	8.38	34.03	152	291	Average
5352	60.58	51.95	74	-13.42	34.28	8.38	34.03	152	291	Peak

ANTENNA POLARITY & TEST DISTANCE: VERTICAL AT 3 M

FREQ. (MHz)	EMISSION LEVEL (dBuV/m)	READ LEVEL (dBuV)	LIMIT (dBuV/m)	MARGIN (dB)	ANTENNA FACTOR (dB/m)	CABLE LOSS (dB)	PREAMP FACTOR (dB)	ANTENNA HEIGHT (cm)	TABLE ANGLE (Degree)	REMARK
5112	42.47	34.27	54	-11.53	34.09	8.1	33.99	140	270	Average
5112	59.21	51.01	74	-14.79	34.09	8.1	33.99	140	270	Peak
5320	100.65	92.07			34.25	8.35	34.02	140	270	Average
5320	108.83	100.25			34.25	8.35	34.02	140	270	Peak
5350	49.3	40.67	54	-4.7	34.28	8.38	34.03	140	270	Average
5350	63.1	54.47	74	-10.9	34.28	8.38	34.03	140	270	Peak

REMARKS:

- Emission Level = Read Level + Antenna Factor + Cable Loss - Preamp Factor
Margin value = Emission level – Limit value
- 5320MHz: Fundamental frequency.



A D T

EUT TEST CONDITION		MEASUREMENT DETAIL	
CHANNEL	Channel 100	FREQUENCY RANGE	1GHz ~ 40GHz
INPUT POWER	120Vac, 60 Hz	DETECTOR FUNCTION	Peak (PK) Average (AV)
ENVIRONMENTAL CONDITIONS	25deg. C, 65%RH	TESTED BY	Will Chen

ANTENNA POLARITY & TEST DISTANCE: HORIZONTAL AT 3 M										
FREQ. (MHz)	EMISSION LEVEL (dBuV/m)	READ LEVEL (dBuV)	LIMIT (dBuV/m)	MARGIN (dB)	ANTENNA FACTOR (dB/m)	CABLE LOSS (dB)	PREAMP FACTOR (dB)	ANTENNA HEIGHT (cm)	TABLE ANGLE (Degree)	REMARK
5460	47.41	38.59	54	-6.59	34.36	8.51	34.05	132	34	Average
5460	62.61	53.79	74	-11.39	34.36	8.51	34.05	132	34	Peak
*5470	64.68	55.85	68.2	-3.52	34.37	8.51	34.05	132	34	Peak
5500	99.55	90.63			34.4	8.57	34.05	132	34	Average
5500	106.84	97.92			34.4	8.57	34.05	132	34	Peak
*5725	56.39	47.23	68.2	-11.81	34.62	8.65	34.11	132	34	Peak
ANTENNA POLARITY & TEST DISTANCE: VERTICAL AT 3 M										
FREQ. (MHz)	EMISSION LEVEL (dBuV/m)	READ LEVEL (dBuV)	LIMIT (dBuV/m)	MARGIN (dB)	ANTENNA FACTOR (dB/m)	CABLE LOSS (dB)	PREAMP FACTOR (dB)	ANTENNA HEIGHT (cm)	TABLE ANGLE (Degree)	REMARK
5460	45.41	36.59	54	-8.59	34.36	8.51	34.05	106	360	Average
5460	58.86	50.04	74	-15.14	34.36	8.51	34.05	106	360	Peak
*5470	57.76	48.93	68.2	-10.44	34.37	8.51	34.05	106	360	Peak
5500	94.47	85.55			34.4	8.57	34.05	106	360	Average
5500	102.77	93.85			34.4	8.57	34.05	106	360	Peak
*5725	55.79	46.63	68.2	-12.41	34.62	8.65	34.11	106	360	Peak

REMARKS:

- Emission Level = Read Level + Antenna Factor + Cable Loss - Preamp Factor
Margin value = Emission level – Limit value
- 5500MHz: Fundamental frequency.
- *: Out of restricted band



A D T

EUT TEST CONDITION		MEASUREMENT DETAIL	
CHANNEL	Channel 116	FREQUENCY RANGE	1GHz ~ 40GHz
INPUT POWER	120Vac, 60 Hz	DETECTOR FUNCTION	Peak (PK) Average (AV)
ENVIRONMENTAL CONDITIONS	25deg. C, 65%RH	TESTED BY	Will Chen

ANTENNA POLARITY & TEST DISTANCE: HORIZONTAL AT 3 M										
FREQ. (MHz)	EMISSION LEVEL (dBuV/m)	READ LEVEL (dBuV)	LIMIT (dBuV/m)	MARGIN (dB)	ANTENNA FACTOR (dB/m)	CABLE LOSS (dB)	PREAMP FACTOR (dB)	ANTENNA HEIGHT (cm)	TABLE ANGLE (Degree)	REMARK
5392	44.13	35.45	54	-9.87	34.31	8.41	34.04	129	30	Average
5392	56.16	47.48	74	-17.84	34.31	8.41	34.04	129	30	Peak
*5470	55.31	46.48	68.2	-12.89	34.37	8.51	34.05	129	30	Peak
5580	100.91	91.92			34.47	8.6	34.08	129	30	Average
5580	108.74	99.75			34.47	8.6	34.08	129	30	Peak
*5725	56.2	47.04	68.2	-12	34.62	8.65	34.11	129	30	Peak
ANTENNA POLARITY & TEST DISTANCE: VERTICAL AT 3 M										
FREQ. (MHz)	EMISSION LEVEL (dBuV/m)	READ LEVEL (dBuV)	LIMIT (dBuV/m)	MARGIN (dB)	ANTENNA FACTOR (dB/m)	CABLE LOSS (dB)	PREAMP FACTOR (dB)	ANTENNA HEIGHT (cm)	TABLE ANGLE (Degree)	REMARK
5382	42.76	34.08	54	-11.24	34.31	8.41	34.04	104	360	Average
5382	57.82	49.14	74	-16.18	34.31	8.41	34.04	104	360	Peak
*5470	55.68	46.85	68.2	-12.52	34.37	8.51	34.05	104	360	Peak
5580	96.18	87.19			34.47	8.6	34.08	104	360	Average
5580	104.47	95.48			34.47	8.6	34.08	104	360	Peak
*5725	57.12	47.96	68.2	-11.08	34.62	8.65	34.11	104	360	Peak

REMARKS:

- Emission Level = Read Level + Antenna Factor + Cable Loss - Preamp Factor
Margin value = Emission level – Limit value
- 5580MHz: Fundamental frequency.
- *: Out of restricted band



A D T

EUT TEST CONDITION		MEASUREMENT DETAIL	
CHANNEL	Channel 140	FREQUENCY RANGE	1GHz ~ 40GHz
INPUT POWER	120Vac, 60 Hz	DETECTOR FUNCTION	Peak (PK) Average (AV)
ENVIRONMENTAL CONDITIONS	25deg. C, 65%RH	TESTED BY	Will Chen

ANTENNA POLARITY & TEST DISTANCE: HORIZONTAL AT 3 M										
FREQ. (MHz)	EMISSION LEVEL (dBuV/m)	READ LEVEL (dBuV)	LIMIT (dBuV/m)	MARGIN (dB)	ANTENNA FACTOR (dB/m)	CABLE LOSS (dB)	PREAMP FACTOR (dB)	ANTENNA HEIGHT (cm)	TABLE ANGLE (Degree)	REMARK
5356	42.64	34.01	54	-11.36	34.28	8.38	34.03	139	31	Average
5356	56.95	48.32	74	-17.05	34.28	8.38	34.03	139	31	Peak
*5470	56.56	47.73	68.2	-11.64	34.37	8.51	34.05	139	31	Peak
5700	98.41	89.28			34.59	8.64	34.1	139	31	Average
5700	106.1	96.97			34.59	8.64	34.1	139	31	Peak
*5725	64.3	55.14	68.2	-3.9	34.62	8.65	34.11	139	31	Peak
ANTENNA POLARITY & TEST DISTANCE: VERTICAL AT 3 M										
FREQ. (MHz)	EMISSION LEVEL (dBuV/m)	READ LEVEL (dBuV)	LIMIT (dBuV/m)	MARGIN (dB)	ANTENNA FACTOR (dB/m)	CABLE LOSS (dB)	PREAMP FACTOR (dB)	ANTENNA HEIGHT (cm)	TABLE ANGLE (Degree)	REMARK
5436	42.67	33.88	54	-11.33	34.35	8.48	34.04	115	357	Average
5436	57	48.21	74	-17	34.35	8.48	34.04	115	357	Peak
*5470	56.01	47.18	68.2	-12.19	34.37	8.51	34.05	115	357	Peak
5700	95.09	85.96			34.59	8.64	34.1	115	357	Average
5700	102.71	93.58			34.59	8.64	34.1	115	357	Peak
*5725	61.15	51.99	68.2	-7.05	34.62	8.65	34.11	115	357	Peak

REMARKS:

- Emission Level = Read Level + Antenna Factor + Cable Loss - Preamp Factor
Margin value = Emission level – Limit value
- 5700MHz: Fundamental frequency.
- *: Out of restricted band



A D T

EUT TEST CONDITION		MEASUREMENT DETAIL	
CHANNEL	Channel 149	FREQUENCY RANGE	1GHz ~ 40GHz
INPUT POWER	120Vac, 60 Hz	DETECTOR FUNCTION	Peak (PK) Average (AV)
ENVIRONMENTAL CONDITIONS	25deg. C, 65%RH	TESTED BY	Will Chen

ANTENNA POLARITY & TEST DISTANCE: HORIZONTAL AT 3 M										
FREQ. (MHz)	EMISSION LEVEL (dBuV/m)	READ LEVEL (dBuV)	LIMIT (dBuV/m)	MARGIN (dB)	ANTENNA FACTOR (dB/m)	CABLE LOSS (dB)	PREAMP FACTOR (dB)	ANTENNA HEIGHT (cm)	TABLE ANGLE (Degree)	REMARK
*5622	57.99	48.94	68.2	-10.21	34.52	8.61	34.08	100	352	Peak
*5724	62.73	53.57	78.2	-15.47	34.62	8.65	34.11	100	352	Peak
5745	94.55	85.36			34.64	8.66	34.11	100	352	Average
5745	102.48	93.29			34.64	8.66	34.11	100	352	Peak
*5856	57.4	48.08	78.2	-20.8	34.76	8.7	34.14	100	352	Peak
*5864	56.79	47.46	68.2	-11.41	34.76	8.71	34.14	100	352	Peak
ANTENNA POLARITY & TEST DISTANCE: VERTICAL AT 3 M										
FREQ. (MHz)	EMISSION LEVEL (dBuV/m)	READ LEVEL (dBuV)	LIMIT (dBuV/m)	MARGIN (dB)	ANTENNA FACTOR (dB/m)	CABLE LOSS (dB)	PREAMP FACTOR (dB)	ANTENNA HEIGHT (cm)	TABLE ANGLE (Degree)	REMARK
*5710	63.15	54	68.2	-5.05	34.61	8.65	34.11	100	96	Peak
*5724	70.93	61.77	78.2	-7.27	34.62	8.65	34.11	100	96	Peak
5745	99.14	89.95			34.64	8.66	34.11	100	96	Average
5745	107.72	98.53			34.64	8.66	34.11	100	96	Peak
*5854	58.52	49.2	78.2	-19.68	34.76	8.7	34.14	100	96	Peak
*5866	58.86	49.53	68.2	-9.34	34.76	8.71	34.14	100	96	Peak

REMARKS:

- Emission Level = Read Level + Antenna Factor + Cable Loss - Preamp Factor
Margin value = Emission level – Limit value
- 5745MHz: Fundamental frequency.
- *: Out of restricted band



A D T

EUT TEST CONDITION		MEASUREMENT DETAIL	
CHANNEL	Channel 157	FREQUENCY RANGE	1GHz ~ 40GHz
INPUT POWER	120Vac, 60 Hz	DETECTOR FUNCTION	Peak (PK) Average (AV)
ENVIRONMENTAL CONDITIONS	25deg. C, 65%RH	TESTED BY	Will Chen

ANTENNA POLARITY & TEST DISTANCE: HORIZONTAL AT 3 M

FREQ. (MHz)	EMISSION LEVEL (dBuV/m)	READ LEVEL (dBuV)	LIMIT (dBuV/m)	MARGIN (dB)	ANTENNA FACTOR (dB/m)	CABLE LOSS (dB)	PREAMP FACTOR (dB)	ANTENNA HEIGHT (cm)	TABLE ANGLE (Degree)	REMARK
*5618	58.27	49.22	68.2	-9.93	34.52	8.61	34.08	100	317	Peak
*5718	57.37	48.21	78.2	-20.83	34.62	8.65	34.11	100	317	Peak
5785	94.11	84.88			34.68	8.68	34.13	100	317	Average
5785	102.29	93.06			34.68	8.68	34.13	100	317	Peak
*5854	57.15	47.83	78.2	-21.05	34.76	8.7	34.14	100	317	Peak
*5866	56.67	47.34	68.2	-11.53	34.76	8.71	34.14	100	317	Peak

ANTENNA POLARITY & TEST DISTANCE: VERTICAL AT 3 M

FREQ. (MHz)	EMISSION LEVEL (dBuV/m)	READ LEVEL (dBuV)	LIMIT (dBuV/m)	MARGIN (dB)	ANTENNA FACTOR (dB/m)	CABLE LOSS (dB)	PREAMP FACTOR (dB)	ANTENNA HEIGHT (cm)	TABLE ANGLE (Degree)	REMARK
*5682	58.8	49.69	68.2	-9.4	34.57	8.64	34.1	100	97	Peak
*5724	58.65	49.49	78.2	-19.55	34.62	8.65	34.11	100	97	Peak
5785	99.97	90.74			34.68	8.68	34.13	100	97	Average
5785	107.71	98.48			34.68	8.68	34.13	100	97	Peak
*5852	57.58	48.28	78.2	-20.62	34.74	8.7	34.14	100	97	Peak
*5868	56.9	47.57	68.2	-11.3	34.76	8.71	34.14	100	97	Peak

REMARKS:

- Emission Level = Read Level + Antenna Factor + Cable Loss - Preamp Factor
Margin value = Emission level – Limit value
- 5785MHz: Fundamental frequency.
- *: Out of restricted band



A D T

EUT TEST CONDITION		MEASUREMENT DETAIL	
CHANNEL	Channel 165	FREQUENCY RANGE	1GHz ~ 40GHz
INPUT POWER	120Vac, 60 Hz	DETECTOR FUNCTION	Peak (PK) Average (AV)
ENVIRONMENTAL CONDITIONS	25deg. C, 65%RH	TESTED BY	Will Chen

ANTENNA POLARITY & TEST DISTANCE: HORIZONTAL AT 3 M

FREQ. (MHz)	EMISSION LEVEL (dBuV/m)	READ LEVEL (dBuV)	LIMIT (dBuV/m)	MARGIN (dB)	ANTENNA FACTOR (dB/m)	CABLE LOSS (dB)	PREAMP FACTOR (dB)	ANTENNA HEIGHT (cm)	TABLE ANGLE (Degree)	REMARK
*5682	58.37	49.26	68.2	-9.83	34.57	8.64	34.1	100	12	Peak
*5722	56.51	47.35	78.2	-21.69	34.62	8.65	34.11	100	12	Peak
5825	94.67	85.38			34.73	8.69	34.13	100	12	Average
5825	102.06	92.77			34.73	8.69	34.13	100	12	Peak
*5852	58.86	49.56	78.2	-19.34	34.74	8.7	34.14	100	12	Peak
*5864	57.15	47.82	68.2	-11.05	34.76	8.71	34.14	100	12	Peak

ANTENNA POLARITY & TEST DISTANCE: VERTICAL AT 3 M

FREQ. (MHz)	EMISSION LEVEL (dBuV/m)	READ LEVEL (dBuV)	LIMIT (dBuV/m)	MARGIN (dB)	ANTENNA FACTOR (dB/m)	CABLE LOSS (dB)	PREAMP FACTOR (dB)	ANTENNA HEIGHT (cm)	TABLE ANGLE (Degree)	REMARK
*5688	58.33	49.2	68.2	-9.87	34.59	8.64	34.1	100	96	Peak
*5718	56.9	47.74	78.2	-21.3	34.62	8.65	34.11	100	96	Peak
5825	99.9	90.61			34.73	8.69	34.13	100	96	Average
5825	107.74	98.45			34.73	8.69	34.13	100	96	Peak
*5852	64.87	55.57	78.2	-13.33	34.74	8.7	34.14	100	96	Peak
*5862	60.27	50.94	68.2	-7.93	34.76	8.71	34.14	100	96	Peak

REMARKS:

- Emission Level = Read Level + Antenna Factor + Cable Loss - Preamp Factor
Margin value = Emission level – Limit value
- 5825MHz: Fundamental frequency.
- *: Out of restricted band



A D T

802.11n (20MHz)

EUT TEST CONDITION		MEASUREMENT DETAIL	
CHANNEL	Channel 36	FREQUENCY RANGE	1GHz ~ 40GHz
INPUT POWER	120Vac, 60 Hz	DETECTOR FUNCTION	Peak (PK) Average (AV)
ENVIRONMENTAL CONDITIONS	25deg. C, 65%RH	TESTED BY	Will Chen

ANTENNA POLARITY & TEST DISTANCE: HORIZONTAL AT 3 M										
FREQ. (MHz)	EMISSION LEVEL (dBuV/m)	READ LEVEL (dBuV)	LIMIT (dBuV/m)	MARGIN (dB)	ANTENNA FACTOR (dB/m)	CABLE LOSS (dB)	PREAMP FACTOR (dB)	ANTENNA HEIGHT (cm)	TABLE ANGLE (Degree)	REMARK
5124	46.2	37.98	54	-7.8	34.11	8.1	33.99	162	301	Average
5124	59.81	51.59	74	-14.19	34.11	8.1	33.99	162	301	Peak
5180	96.43	88.12			34.15	8.16	34	162	301	Average
5180	104.66	96.35			34.15	8.16	34	162	301	Peak
5438	43.13	34.34	54	-10.87	34.35	8.48	34.04	162	301	Average
5438	58.9	50.11	74	-15.1	34.35	8.48	34.04	162	301	Peak
ANTENNA POLARITY & TEST DISTANCE: VERTICAL AT 3 M										
FREQ. (MHz)	EMISSION LEVEL (dBuV/m)	READ LEVEL (dBuV)	LIMIT (dBuV/m)	MARGIN (dB)	ANTENNA FACTOR (dB/m)	CABLE LOSS (dB)	PREAMP FACTOR (dB)	ANTENNA HEIGHT (cm)	TABLE ANGLE (Degree)	REMARK
5150	48.65	40.4	54	-5.35	34.12	8.13	34	144	270	Average
5150	60.71	52.46	74	-13.29	34.12	8.13	34	144	270	Peak
5180	99.62	91.31			34.15	8.16	34	144	270	Average
5180	107.66	99.35			34.15	8.16	34	144	270	Peak
5370	42.64	33.97	54	-11.36	34.29	8.41	34.03	144	270	Average
5370	59.7	51.03	74	-14.3	34.29	8.41	34.03	144	270	Peak

REMARKS:

- Emission Level = Read Level + Antenna Factor + Cable Loss - Preamp Factor
Margin value = Emission level – Limit value
- 5180MHz: Fundamental frequency.



A D T

EUT TEST CONDITION		MEASUREMENT DETAIL	
CHANNEL	Channel 44	FREQUENCY RANGE	1GHz ~ 40GHz
INPUT POWER	120Vac, 60 Hz	DETECTOR FUNCTION	Peak (PK) Average (AV)
ENVIRONMENTAL CONDITIONS	25deg. C, 65%RH	TESTED BY	Will Chen

ANTENNA POLARITY & TEST DISTANCE: HORIZONTAL AT 3 M										
FREQ. (MHz)	EMISSION LEVEL (dBuV/m)	READ LEVEL (dBuV)	LIMIT (dBuV/m)	MARGIN (dB)	ANTENNA FACTOR (dB/m)	CABLE LOSS (dB)	PREAMP FACTOR (dB)	ANTENNA HEIGHT (cm)	TABLE ANGLE (Degree)	REMARK
5070	42.84	34.74	54	-11.16	34.05	8.03	33.98	162	286	Average
5070	58.59	50.49	74	-15.41	34.05	8.03	33.98	162	286	Peak
5220	96.5	88.11			34.17	8.22	34	162	286	Average
5220	104.15	95.76			34.17	8.22	34	162	286	Peak
5454	43.17	34.35	54	-10.83	34.36	8.51	34.05	162	286	Average
5454	59.24	50.42	74	-14.76	34.36	8.51	34.05	162	286	Peak
ANTENNA POLARITY & TEST DISTANCE: VERTICAL AT 3 M										
FREQ. (MHz)	EMISSION LEVEL (dBuV/m)	READ LEVEL (dBuV)	LIMIT (dBuV/m)	MARGIN (dB)	ANTENNA FACTOR (dB/m)	CABLE LOSS (dB)	PREAMP FACTOR (dB)	ANTENNA HEIGHT (cm)	TABLE ANGLE (Degree)	REMARK
5046	43.34	35.28	54	-10.66	34.04	8	33.98	144	270	Average
5046	58.96	50.9	74	-15.04	34.04	8	33.98	144	270	Peak
5220	99.53	91.14			34.17	8.22	34	144	270	Average
5220	107.43	99.04			34.17	8.22	34	144	270	Peak
5394	42.84	34.13	54	-11.16	34.31	8.44	34.04	144	270	Average
5394	59.31	50.6	74	-14.69	34.31	8.44	34.04	144	270	Peak

REMARKS:

- Emission Level = Read Level + Antenna Factor + Cable Loss - Preamp Factor
Margin value = Emission level – Limit value
- 5220MHz: Fundamental frequency.



A D T

EUT TEST CONDITION		MEASUREMENT DETAIL	
CHANNEL	Channel 48	FREQUENCY RANGE	1GHz ~ 40GHz
INPUT POWER	120Vac, 60 Hz	DETECTOR FUNCTION	Peak (PK) Average (AV)
ENVIRONMENTAL CONDITIONS	25deg. C, 65%RH	TESTED BY	Will Chen

ANTENNA POLARITY & TEST DISTANCE: HORIZONTAL AT 3 M										
FREQ. (MHz)	EMISSION LEVEL (dBuV/m)	READ LEVEL (dBuV)	LIMIT (dBuV/m)	MARGIN (dB)	ANTENNA FACTOR (dB/m)	CABLE LOSS (dB)	PREAMP FACTOR (dB)	ANTENNA HEIGHT (cm)	TABLE ANGLE (Degree)	REMARK
5128	42.58	34.36	54	-11.42	34.11	8.1	33.99	162	301	Average
5128	58.79	50.57	74	-15.21	34.11	8.1	33.99	162	301	Peak
5240	96.56	88.12			34.19	8.26	34.01	162	301	Average
5240	104.15	95.71			34.19	8.26	34.01	162	301	Peak
5432	42.92	34.13	54	-11.08	34.35	8.48	34.04	162	301	Average
5432	59.06	50.27	74	-14.94	34.35	8.48	34.04	162	301	Peak
ANTENNA POLARITY & TEST DISTANCE: VERTICAL AT 3 M										
FREQ. (MHz)	EMISSION LEVEL (dBuV/m)	READ LEVEL (dBuV)	LIMIT (dBuV/m)	MARGIN (dB)	ANTENNA FACTOR (dB/m)	CABLE LOSS (dB)	PREAMP FACTOR (dB)	ANTENNA HEIGHT (cm)	TABLE ANGLE (Degree)	REMARK
5138	42.68	34.43	54	-11.32	34.11	8.13	33.99	141	270	Average
5138	58.86	50.61	74	-15.14	34.11	8.13	33.99	141	270	Peak
5240	99.94	91.5			34.19	8.26	34.01	141	270	Average
5240	107.58	99.14			34.19	8.26	34.01	141	270	Peak
5358	42.89	34.26	54	-11.11	34.28	8.38	34.03	141	270	Average
5358	59.46	50.83	74	-14.54	34.28	8.38	34.03	141	270	Peak

REMARKS:

- Emission Level = Read Level + Antenna Factor + Cable Loss - Preamp Factor
Margin value = Emission level – Limit value
- 5240MHz: Fundamental frequency.



A D T

EUT TEST CONDITION		MEASUREMENT DETAIL	
CHANNEL	Channel 52	FREQUENCY RANGE	1GHz ~ 40GHz
INPUT POWER	120Vac, 60 Hz	DETECTOR FUNCTION	Peak (PK) Average (AV)
ENVIRONMENTAL CONDITIONS	25deg. C, 65%RH	TESTED BY	Will Chen

ANTENNA POLARITY & TEST DISTANCE: HORIZONTAL AT 3 M										
FREQ. (MHz)	EMISSION LEVEL (dBuV/m)	READ LEVEL (dBuV)	LIMIT (dBuV/m)	MARGIN (dB)	ANTENNA FACTOR (dB/m)	CABLE LOSS (dB)	PREAMP FACTOR (dB)	ANTENNA HEIGHT (cm)	TABLE ANGLE (Degree)	REMARK
5036	42.38	34.32	54	-11.62	34.03	8	33.97	152	291	Average
5036	58.07	50.01	74	-15.93	34.03	8	33.97	152	291	Peak
5260	96.94	88.48			34.21	8.26	34.01	152	291	Average
5260	105.09	96.63			34.21	8.26	34.01	152	291	Peak
5450	43.07	34.25	54	-10.93	34.36	8.51	34.05	152	291	Average
5450	58.82	50	74	-15.18	34.36	8.51	34.05	152	291	Peak
ANTENNA POLARITY & TEST DISTANCE: VERTICAL AT 3 M										
FREQ. (MHz)	EMISSION LEVEL (dBuV/m)	READ LEVEL (dBuV)	LIMIT (dBuV/m)	MARGIN (dB)	ANTENNA FACTOR (dB/m)	CABLE LOSS (dB)	PREAMP FACTOR (dB)	ANTENNA HEIGHT (cm)	TABLE ANGLE (Degree)	REMARK
5114	42.84	34.64	54	-11.16	34.09	8.1	33.99	140	270	Average
5114	58.64	50.44	74	-15.36	34.09	8.1	33.99	140	270	Peak
5260	100.17	91.71			34.21	8.26	34.01	140	270	Average
5260	108.01	99.55			34.21	8.26	34.01	140	270	Peak
5388	43.12	34.44	54	-10.88	34.31	8.41	34.04	140	270	Average
5388	59.22	50.54	74	-14.78	34.31	8.41	34.04	140	270	Peak

REMARKS:

- Emission Level = Read Level + Antenna Factor + Cable Loss - Preamp Factor
Margin value = Emission level – Limit value
- 5260MHz: Fundamental frequency.



A D T

EUT TEST CONDITION		MEASUREMENT DETAIL	
CHANNEL	Channel 60	FREQUENCY RANGE	1GHz ~ 40GHz
INPUT POWER	120Vac, 60 Hz	DETECTOR FUNCTION	Peak (PK) Average (AV)
ENVIRONMENTAL CONDITIONS	25deg. C, 65%RH	TESTED BY	Will Chen

ANTENNA POLARITY & TEST DISTANCE: HORIZONTAL AT 3 M										
FREQ. (MHz)	EMISSION LEVEL (dBuV/m)	READ LEVEL (dBuV)	LIMIT (dBuV/m)	MARGIN (dB)	ANTENNA FACTOR (dB/m)	CABLE LOSS (dB)	PREAMP FACTOR (dB)	ANTENNA HEIGHT (cm)	TABLE ANGLE (Degree)	REMARK
5120	42.62	34.42	54	-11.38	34.09	8.1	33.99	152	291	Average
5120	58.24	50.04	74	-15.76	34.09	8.1	33.99	152	291	Peak
5300	97.56	89.02			34.24	8.32	34.02	152	291	Average
5300	105.8	97.26			34.24	8.32	34.02	152	291	Peak
5402	45.26	36.54	54	-8.74	34.32	8.44	34.04	152	291	Average
5402	59.02	50.3	74	-14.98	34.32	8.44	34.04	152	291	Peak
ANTENNA POLARITY & TEST DISTANCE: VERTICAL AT 3 M										
FREQ. (MHz)	EMISSION LEVEL (dBuV/m)	READ LEVEL (dBuV)	LIMIT (dBuV/m)	MARGIN (dB)	ANTENNA FACTOR (dB/m)	CABLE LOSS (dB)	PREAMP FACTOR (dB)	ANTENNA HEIGHT (cm)	TABLE ANGLE (Degree)	REMARK
5018	42.32	34.31	54	-11.68	34.01	7.97	33.97	140	270	Average
5018	58.54	50.53	74	-15.46	34.01	7.97	33.97	140	270	Peak
5300	100.01	91.47			34.24	8.32	34.02	140	270	Average
5300	108.33	99.79			34.24	8.32	34.02	140	270	Peak
5350	46.38	37.75	54	-7.62	34.28	8.38	34.03	140	270	Average
5350	60.24	51.61	74	-13.76	34.28	8.38	34.03	140	270	Peak

REMARKS:

- Emission Level = Read Level + Antenna Factor + Cable Loss - Preamp Factor
Margin value = Emission level – Limit value
- 5300MHz: Fundamental frequency.



A D T

EUT TEST CONDITION		MEASUREMENT DETAIL	
CHANNEL	Channel 64	FREQUENCY RANGE	1GHz ~ 40GHz
INPUT POWER	120Vac, 60 Hz	DETECTOR FUNCTION	Peak (PK) Average (AV)
ENVIRONMENTAL CONDITIONS	25deg. C, 65%RH	TESTED BY	Will Chen

ANTENNA POLARITY & TEST DISTANCE: HORIZONTAL AT 3 M										
FREQ. (MHz)	EMISSION LEVEL (dBuV/m)	READ LEVEL (dBuV)	LIMIT (dBuV/m)	MARGIN (dB)	ANTENNA FACTOR (dB/m)	CABLE LOSS (dB)	PREAMP FACTOR (dB)	ANTENNA HEIGHT (cm)	TABLE ANGLE (Degree)	REMARK
5036	42.53	34.47	54	-11.47	34.03	8	33.97	152	291	Average
5036	58.66	50.6	74	-15.34	34.03	8	33.97	152	291	Peak
5320	97.2	88.62			34.25	8.35	34.02	152	291	Average
5320	105.37	96.79			34.25	8.35	34.02	152	291	Peak
5350	48.66	40.03	54	-5.34	34.28	8.38	34.03	152	291	Average
5350	61.13	52.5	74	-12.87	34.28	8.38	34.03	152	291	Peak
ANTENNA POLARITY & TEST DISTANCE: VERTICAL AT 3 M										
FREQ. (MHz)	EMISSION LEVEL (dBuV/m)	READ LEVEL (dBuV)	LIMIT (dBuV/m)	MARGIN (dB)	ANTENNA FACTOR (dB/m)	CABLE LOSS (dB)	PREAMP FACTOR (dB)	ANTENNA HEIGHT (cm)	TABLE ANGLE (Degree)	REMARK
5060	42.39	34.29	54	-11.61	34.05	8.03	33.98	140	270	Average
5060	60.26	52.16	74	-13.74	34.05	8.03	33.98	140	270	Peak
5320	100.5	91.92			34.25	8.35	34.02	140	270	Average
5320	108.61	100.03			34.25	8.35	34.02	140	270	Peak
5350	50.21	41.58	54	-3.79	34.28	8.38	34.03	140	270	Average
5350	62.57	53.94	74	-11.43	34.28	8.38	34.03	140	270	Peak

REMARKS:

- Emission Level = Read Level + Antenna Factor + Cable Loss - Preamp Factor
Margin value = Emission level – Limit value
- 5320MHz: Fundamental frequency.



A D T

EUT TEST CONDITION		MEASUREMENT DETAIL	
CHANNEL	Channel 100	FREQUENCY RANGE	1GHz ~ 40GHz
INPUT POWER	120Vac, 60 Hz	DETECTOR FUNCTION	Peak (PK) Average (AV)
ENVIRONMENTAL CONDITIONS	25deg. C, 65%RH	TESTED BY	Will Chen

ANTENNA POLARITY & TEST DISTANCE: HORIZONTAL AT 3 M										
FREQ. (MHz)	EMISSION LEVEL (dBuV/m)	READ LEVEL (dBuV)	LIMIT (dBuV/m)	MARGIN (dB)	ANTENNA FACTOR (dB/m)	CABLE LOSS (dB)	PREAMP FACTOR (dB)	ANTENNA HEIGHT (cm)	TABLE ANGLE (Degree)	REMARK
5460	49.9	41.08	54	-4.1	34.36	8.51	34.05	133	34	Average
5460	60.31	51.49	74	-13.69	34.36	8.51	34.05	133	34	Peak
*5470	65.96	57.13	68.2	-2.24	34.37	8.51	34.05	133	34	Peak
5500	98.64	89.72			34.4	8.57	34.05	133	34	Average
5500	106.79	97.87			34.4	8.57	34.05	133	34	Peak
*5725	56.06	46.9	68.2	-12.14	34.62	8.65	34.11	133	34	Peak
ANTENNA POLARITY & TEST DISTANCE: VERTICAL AT 3 M										
FREQ. (MHz)	EMISSION LEVEL (dBuV/m)	READ LEVEL (dBuV)	LIMIT (dBuV/m)	MARGIN (dB)	ANTENNA FACTOR (dB/m)	CABLE LOSS (dB)	PREAMP FACTOR (dB)	ANTENNA HEIGHT (cm)	TABLE ANGLE (Degree)	REMARK
5454	43.65	34.83	54	-10.35	34.36	8.51	34.05	109	22	Average
5454	56.52	47.7	74	-17.48	34.36	8.51	34.05	109	22	Peak
*5470	60.56	51.73	68.2	-7.64	34.37	8.51	34.05	109	22	Peak
5500	94.83	85.91			34.4	8.57	34.05	109	22	Average
5500	102.68	93.76			34.4	8.57	34.05	109	22	Peak
*5725	56.59	47.43	68.2	-11.61	34.62	8.65	34.11	109	22	Peak

REMARKS:

- Emission Level = Read Level + Antenna Factor + Cable Loss - Preamp Factor
Margin value = Emission level – Limit value
- 5500MHz: Fundamental frequency.
- *: Out of restricted band



A D T

EUT TEST CONDITION		MEASUREMENT DETAIL	
CHANNEL	Channel 116	FREQUENCY RANGE	1GHz ~ 40GHz
INPUT POWER	120Vac, 60 Hz	DETECTOR FUNCTION	Peak (PK) Average (AV)
ENVIRONMENTAL CONDITIONS	25deg. C, 65%RH	TESTED BY	Will Chen

ANTENNA POLARITY & TEST DISTANCE: HORIZONTAL AT 3 M										
FREQ. (MHz)	EMISSION LEVEL (dBuV/m)	READ LEVEL (dBuV)	LIMIT (dBuV/m)	MARGIN (dB)	ANTENNA FACTOR (dB/m)	CABLE LOSS (dB)	PREAMP FACTOR (dB)	ANTENNA HEIGHT (cm)	TABLE ANGLE (Degree)	REMARK
5450	43.07	34.25	54	-10.93	34.36	8.51	34.05	130	34	Average
5450	56.42	47.6	74	-17.58	34.36	8.51	34.05	130	34	Peak
*5470	54.81	45.98	68.2	-13.39	34.37	8.51	34.05	130	34	Peak
5580	100.62	91.63			34.47	8.6	34.08	130	34	Average
5580	108.43	99.44			34.47	8.6	34.08	130	34	Peak
*5725	54.82	45.66	68.2	-13.38	34.62	8.65	34.11	130	34	Peak
ANTENNA POLARITY & TEST DISTANCE: VERTICAL AT 3 M										
FREQ. (MHz)	EMISSION LEVEL (dBuV/m)	READ LEVEL (dBuV)	LIMIT (dBuV/m)	MARGIN (dB)	ANTENNA FACTOR (dB/m)	CABLE LOSS (dB)	PREAMP FACTOR (dB)	ANTENNA HEIGHT (cm)	TABLE ANGLE (Degree)	REMARK
5452	42.83	34.01	54	-11.17	34.36	8.51	34.05	105	355	Average
5452	56.94	48.12	74	-17.06	34.36	8.51	34.05	105	355	Peak
*5470	54.74	45.91	68.2	-13.46	34.37	8.51	34.05	105	355	Peak
5580	96.03	87.04			34.47	8.6	34.08	105	355	Average
5580	104.4	95.41			34.47	8.6	34.08	105	355	Peak
*5725	55.72	46.56	68.2	-12.48	34.62	8.65	34.11	105	355	Peak

REMARKS:

- Emission Level = Read Level + Antenna Factor + Cable Loss - Preamp Factor
Margin value = Emission level – Limit value
- 5580MHz: Fundamental frequency.
- *: Out of restricted band



A D T

EUT TEST CONDITION		MEASUREMENT DETAIL	
CHANNEL	Channel 140	FREQUENCY RANGE	1GHz ~ 40GHz
INPUT POWER	120Vac, 60 Hz	DETECTOR FUNCTION	Peak (PK) Average (AV)
ENVIRONMENTAL CONDITIONS	25deg. C, 65%RH	TESTED BY	Will Chen

ANTENNA POLARITY & TEST DISTANCE: HORIZONTAL AT 3 M										
FREQ. (MHz)	EMISSION LEVEL (dBuV/m)	READ LEVEL (dBuV)	LIMIT (dBuV/m)	MARGIN (dB)	ANTENNA FACTOR (dB/m)	CABLE LOSS (dB)	PREAMP FACTOR (dB)	ANTENNA HEIGHT (cm)	TABLE ANGLE (Degree)	REMARK
5440	42.78	33.99	54	-11.22	34.35	8.48	34.04	127	33	Average
5440	56.41	47.62	74	-17.59	34.35	8.48	34.04	127	33	Peak
*5470	55.06	46.23	68.2	-13.14	34.37	8.51	34.05	127	33	Peak
5700	98.65	89.52			34.59	8.64	34.1	127	33	Average
5700	106.19	97.06			34.59	8.64	34.1	127	33	Peak
*5725	67.12	57.96	68.2	-1.08	34.62	8.65	34.11	127	33	Peak
ANTENNA POLARITY & TEST DISTANCE: VERTICAL AT 3 M										
FREQ. (MHz)	EMISSION LEVEL (dBuV/m)	READ LEVEL (dBuV)	LIMIT (dBuV/m)	MARGIN (dB)	ANTENNA FACTOR (dB/m)	CABLE LOSS (dB)	PREAMP FACTOR (dB)	ANTENNA HEIGHT (cm)	TABLE ANGLE (Degree)	REMARK
5422	42.66	33.89	54	-11.34	34.33	8.48	34.04	102	352	Average
5422	56.81	48.04	74	-17.19	34.33	8.48	34.04	102	352	Peak
*5470	55.86	47.03	68.2	-12.34	34.37	8.51	34.05	102	352	Peak
5700	94.37	85.24			34.59	8.64	34.1	102	352	Average
5700	102.64	93.51			34.59	8.64	34.1	102	352	Peak
*5725	58.92	49.76	68.2	-9.28	34.62	8.65	34.11	102	352	Peak

REMARKS:

- Emission Level = Read Level + Antenna Factor + Cable Loss - Preamp Factor
Margin value = Emission level – Limit value
- 5700MHz: Fundamental frequency.
- *: Out of restricted band



A D T

EUT TEST CONDITION		MEASUREMENT DETAIL	
CHANNEL	Channel 149	FREQUENCY RANGE	1GHz ~ 40GHz
INPUT POWER	120Vac, 60 Hz	DETECTOR FUNCTION	Peak (PK) Average (AV)
ENVIRONMENTAL CONDITIONS	25deg. C, 65%RH	TESTED BY	Will Chen

ANTENNA POLARITY & TEST DISTANCE: HORIZONTAL AT 3 M										
FREQ. (MHz)	EMISSION LEVEL (dBuV/m)	READ LEVEL (dBuV)	LIMIT (dBuV/m)	MARGIN (dB)	ANTENNA FACTOR (dB/m)	CABLE LOSS (dB)	PREAMP FACTOR (dB)	ANTENNA HEIGHT (cm)	TABLE ANGLE (Degree)	REMARK
*5712	59.24	50.09	68.2	-8.96	34.61	8.65	34.11	100	352	Peak
*5724	62.99	53.83	78.2	-15.21	34.62	8.65	34.11	100	352	Peak
5745	94.16	84.97			34.64	8.66	34.11	100	352	Average
5745	101.92	92.73			34.64	8.66	34.11	100	352	Peak
*5856	57.17	47.85	78.2	-21.03	34.76	8.7	34.14	100	352	Peak
*5870	56.84	47.51	68.2	-11.36	34.76	8.71	34.14	100	352	Peak
ANTENNA POLARITY & TEST DISTANCE: VERTICAL AT 3 M										
FREQ. (MHz)	EMISSION LEVEL (dBuV/m)	READ LEVEL (dBuV)	LIMIT (dBuV/m)	MARGIN (dB)	ANTENNA FACTOR (dB/m)	CABLE LOSS (dB)	PREAMP FACTOR (dB)	ANTENNA HEIGHT (cm)	TABLE ANGLE (Degree)	REMARK
*5712	64.34	55.19	68.2	-3.86	34.61	8.65	34.11	100	96	Peak
*5724	73.68	64.52	78.2	-4.52	34.62	8.65	34.11	100	96	Peak
5745	99.62	90.43			34.64	8.66	34.11	100	96	Average
5745	107.34	98.15			34.64	8.66	34.11	100	96	Peak
*5852	58.21	48.91	78.2	-19.99	34.74	8.7	34.14	100	96	Peak
*5866	57.37	48.04	68.2	-10.83	34.76	8.71	34.14	100	96	Peak

REMARKS:

- Emission Level = Read Level + Antenna Factor + Cable Loss - Preamp Factor
Margin value = Emission level – Limit value
- 5745MHz: Fundamental frequency.
- *: Out of restricted band



A D T

EUT TEST CONDITION		MEASUREMENT DETAIL	
CHANNEL	Channel 157	FREQUENCY RANGE	1GHz ~ 40GHz
INPUT POWER	120Vac, 60 Hz	DETECTOR FUNCTION	Peak (PK) Average (AV)
ENVIRONMENTAL CONDITIONS	25deg. C, 65%RH	TESTED BY	Will Chen

ANTENNA POLARITY & TEST DISTANCE: HORIZONTAL AT 3 M

FREQ. (MHz)	EMISSION LEVEL (dBuV/m)	READ LEVEL (dBuV)	LIMIT (dBuV/m)	MARGIN (dB)	ANTENNA FACTOR (dB/m)	CABLE LOSS (dB)	PREAMP FACTOR (dB)	ANTENNA HEIGHT (cm)	TABLE ANGLE (Degree)	REMARK
*5674	58.14	49.04	68.2	-10.06	34.57	8.63	34.1	100	10	Peak
*5724	57.15	47.99	78.2	-21.05	34.62	8.65	34.11	100	10	Peak
5785	94.32	85.09			34.68	8.68	34.13	100	10	Average
5785	102.21	92.98			34.68	8.68	34.13	100	10	Peak
*5858	57.22	47.9	78.2	-20.98	34.76	8.7	34.14	100	10	Peak
*5862	57.09	47.76	68.2	-11.11	34.76	8.71	34.14	100	10	Peak

ANTENNA POLARITY & TEST DISTANCE: VERTICAL AT 3 M

FREQ. (MHz)	EMISSION LEVEL (dBuV/m)	READ LEVEL (dBuV)	LIMIT (dBuV/m)	MARGIN (dB)	ANTENNA FACTOR (dB/m)	CABLE LOSS (dB)	PREAMP FACTOR (dB)	ANTENNA HEIGHT (cm)	TABLE ANGLE (Degree)	REMARK
*5496	58.55	49.67	68.2	-9.65	34.39	8.54	34.05	100	96	Peak
*5724	58.4	49.24	78.2	-19.8	34.62	8.65	34.11	100	96	Peak
5785	99.82	90.59			34.68	8.68	34.13	100	96	Average
5785	107.07	97.84			34.68	8.68	34.13	100	96	Peak
*5854	57.73	48.41	78.2	-20.47	34.76	8.7	34.14	100	96	Peak
*5862	56.41	47.08	68.2	-11.79	34.76	8.71	34.14	100	96	Peak

REMARKS:

- Emission Level = Read Level + Antenna Factor + Cable Loss - Preamp Factor
Margin value = Emission level – Limit value
- 5785MHz: Fundamental frequency.
- *: Out of restricted band



A D T

EUT TEST CONDITION		MEASUREMENT DETAIL	
CHANNEL	Channel 165	FREQUENCY RANGE	1GHz ~ 40GHz
INPUT POWER	120Vac, 60 Hz	DETECTOR FUNCTION	Peak (PK) Average (AV)
ENVIRONMENTAL CONDITIONS	25deg. C, 65%RH	TESTED BY	Will Chen

ANTENNA POLARITY & TEST DISTANCE: HORIZONTAL AT 3 M

FREQ. (MHz)	EMISSION LEVEL (dBuV/m)	READ LEVEL (dBuV)	LIMIT (dBuV/m)	MARGIN (dB)	ANTENNA FACTOR (dB/m)	CABLE LOSS (dB)	PREAMP FACTOR (dB)	ANTENNA HEIGHT (cm)	TABLE ANGLE (Degree)	REMARK
*5584	58.3	49.29	68.2	-9.9	34.49	8.6	34.08	100	12	Peak
*5722	56.86	47.7	78.2	-21.34	34.62	8.65	34.11	100	12	Peak
5825	94.96	85.67	54	40.96	34.73	8.69	34.13	100	12	Average
5825	102.4	93.11	74	28.4	34.73	8.69	34.13	100	12	Peak
*5858	60.19	50.87	78.2	-18.01	34.76	8.7	34.14	100	12	Peak
*5862	57.61	48.28	68.2	-10.59	34.76	8.71	34.14	100	12	Peak

ANTENNA POLARITY & TEST DISTANCE: VERTICAL AT 3 M

FREQ. (MHz)	EMISSION LEVEL (dBuV/m)	READ LEVEL (dBuV)	LIMIT (dBuV/m)	MARGIN (dB)	ANTENNA FACTOR (dB/m)	CABLE LOSS (dB)	PREAMP FACTOR (dB)	ANTENNA HEIGHT (cm)	TABLE ANGLE (Degree)	REMARK
*5708	57.53	48.38	68.2	-10.67	34.61	8.65	34.11	100	96	Peak
*5718	58	48.84	78.2	-20.2	34.62	8.65	34.11	100	96	Peak
5825	99	89.71	54	45	34.73	8.69	34.13	100	96	Average
5825	107.49	98.2	74	33.49	34.73	8.69	34.13	100	96	Peak
*5852	68.66	59.36	78.2	-9.54	34.74	8.7	34.14	100	96	Peak
*5862	62.3	52.97	68.2	-5.9	34.76	8.71	34.14	100	96	Peak

REMARKS:

- Emission Level = Read Level + Antenna Factor + Cable Loss - Preamp Factor
Margin value = Emission level – Limit value
- 5825MHz: Fundamental frequency.
- *: Out of restricted band



A D T

802.11n (40MHz)

EUT TEST CONDITION		MEASUREMENT DETAIL	
CHANNEL	Channel 38	FREQUENCY RANGE	1GHz ~ 40GHz
INPUT POWER	120Vac, 60 Hz	DETECTOR FUNCTION	Peak (PK) Average (AV)
ENVIRONMENTAL CONDITIONS	25deg. C, 65%RH	TESTED BY	Will Chen

ANTENNA POLARITY & TEST DISTANCE: HORIZONTAL AT 3 M										
FREQ. (MHz)	EMISSION LEVEL (dBuV/m)	READ LEVEL (dBuV)	LIMIT (dBuV/m)	MARGIN (dB)	ANTENNA FACTOR (dB/m)	CABLE LOSS (dB)	PREAMP FACTOR (dB)	ANTENNA HEIGHT (cm)	TABLE ANGLE (Degree)	REMARK
5140	47.55	39.29	54	-6.45	34.12	8.13	33.99	162	301	Average
5140	60.21	51.95	74	-13.79	34.12	8.13	33.99	162	301	Peak
5190	93.64	85.3			34.15	8.19	34	162	301	Average
5190	101.06	92.72			34.15	8.19	34	162	301	Peak
5440	43.14	34.35	54	-10.86	34.35	8.48	34.04	162	301	Average
5440	59	50.21	74	-15	34.35	8.48	34.04	162	301	Peak
ANTENNA POLARITY & TEST DISTANCE: VERTICAL AT 3 M										
FREQ. (MHz)	EMISSION LEVEL (dBuV/m)	READ LEVEL (dBuV)	LIMIT (dBuV/m)	MARGIN (dB)	ANTENNA FACTOR (dB/m)	CABLE LOSS (dB)	PREAMP FACTOR (dB)	ANTENNA HEIGHT (cm)	TABLE ANGLE (Degree)	REMARK
5150	49.97	41.72	54	-4.03	34.12	8.13	34	144	270	Average
5150	61.83	53.58	74	-12.17	34.12	8.13	34	144	270	Peak
5190	97.05	88.71			34.15	8.19	34	144	270	Average
5190	104.94	96.6			34.15	8.19	34	144	270	Peak
5410	43.21	34.49	54	-10.79	34.32	8.44	34.04	144	270	Average
5410	58.92	50.2	74	-15.08	34.32	8.44	34.04	144	270	Peak

REMARKS:

- Emission Level = Read Level + Antenna Factor + Cable Loss - Preamp Factor
Margin value = Emission level – Limit value
- 5190MHz: Fundamental frequency.



A D T

EUT TEST CONDITION		MEASUREMENT DETAIL	
CHANNEL	Channel 46	FREQUENCY RANGE	1GHz ~ 40GHz
INPUT POWER	120Vac, 60 Hz	DETECTOR FUNCTION	Peak (PK) Average (AV)
ENVIRONMENTAL CONDITIONS	25deg. C, 65%RH	TESTED BY	Will Chen

ANTENNA POLARITY & TEST DISTANCE: HORIZONTAL AT 3 M										
FREQ. (MHz)	EMISSION LEVEL (dBuV/m)	READ LEVEL (dBuV)	LIMIT (dBuV/m)	MARGIN (dB)	ANTENNA FACTOR (dB/m)	CABLE LOSS (dB)	PREAMP FACTOR (dB)	ANTENNA HEIGHT (cm)	TABLE ANGLE (Degree)	REMARK
5072	43.05	34.93	54	-10.95	34.07	8.03	33.98	162	301	Average
5072	58.81	50.69	74	-15.19	34.07	8.03	33.98	162	301	Peak
5230	93.41	85.01			34.19	8.22	34.01	162	301	Average
5230	101.01	92.61			34.19	8.22	34.01	162	301	Peak
5384	42.92	34.24	54	-11.08	34.31	8.41	34.04	162	301	Average
5384	58.71	50.03	74	-15.29	34.31	8.41	34.04	162	301	Peak
ANTENNA POLARITY & TEST DISTANCE: VERTICAL AT 3 M										
FREQ. (MHz)	EMISSION LEVEL (dBuV/m)	READ LEVEL (dBuV)	LIMIT (dBuV/m)	MARGIN (dB)	ANTENNA FACTOR (dB/m)	CABLE LOSS (dB)	PREAMP FACTOR (dB)	ANTENNA HEIGHT (cm)	TABLE ANGLE (Degree)	REMARK
5148	43.42	35.17	54	-10.58	34.12	8.13	34	143	270	Average
5148	58.62	50.37	74	-15.38	34.12	8.13	34	143	270	Peak
5230	97.03	88.63			34.19	8.22	34.01	143	270	Average
5230	104.99	96.59			34.19	8.22	34.01	143	270	Peak
5442	43.12	34.33	54	-10.88	34.35	8.48	34.04	143	270	Average
5442	59.4	50.61	74	-14.6	34.35	8.48	34.04	143	270	Peak

REMARKS:

- Emission Level = Read Level + Antenna Factor + Cable Loss - Preamp Factor
Margin value = Emission level – Limit value
- 5230MHz: Fundamental frequency.



A D T

EUT TEST CONDITION		MEASUREMENT DETAIL	
CHANNEL	Channel 54	FREQUENCY RANGE	1GHz ~ 40GHz
INPUT POWER	120Vac, 60 Hz	DETECTOR FUNCTION	Peak (PK) Average (AV)
ENVIRONMENTAL CONDITIONS	25deg. C, 65%RH	TESTED BY	Will Chen

ANTENNA POLARITY & TEST DISTANCE: HORIZONTAL AT 3 M										
FREQ. (MHz)	EMISSION LEVEL (dBuV/m)	READ LEVEL (dBuV)	LIMIT (dBuV/m)	MARGIN (dB)	ANTENNA FACTOR (dB/m)	CABLE LOSS (dB)	PREAMP FACTOR (dB)	ANTENNA HEIGHT (cm)	TABLE ANGLE (Degree)	REMARK
5064	42.99	34.89	54	-11.01	34.05	8.03	33.98	152	291	Average
5064	60.14	52.04	74	-13.86	34.05	8.03	33.98	152	291	Peak
5270	94.02	85.53			34.21	8.29	34.01	152	291	Average
5270	102.29	93.8			34.21	8.29	34.01	152	291	Peak
5354	43.41	34.78	54	-10.59	34.28	8.38	34.03	152	291	Average
5354	58.68	50.05	74	-15.32	34.28	8.38	34.03	152	291	Peak
ANTENNA POLARITY & TEST DISTANCE: VERTICAL AT 3 M										
FREQ. (MHz)	EMISSION LEVEL (dBuV/m)	READ LEVEL (dBuV)	LIMIT (dBuV/m)	MARGIN (dB)	ANTENNA FACTOR (dB/m)	CABLE LOSS (dB)	PREAMP FACTOR (dB)	ANTENNA HEIGHT (cm)	TABLE ANGLE (Degree)	REMARK
5146	42.95	34.7	54	-11.05	34.12	8.13	34	140	270	Average
5146	58.62	50.37	74	-15.38	34.12	8.13	34	140	270	Peak
5270	96.44	87.95			34.21	8.29	34.01	140	270	Average
5270	104.91	96.42			34.21	8.29	34.01	140	270	Peak
5364	43.85	35.21	54	-10.15	34.29	8.38	34.03	140	270	Average
5364	59.26	50.62	74	-14.74	34.29	8.38	34.03	140	270	Peak

REMARKS:

- Emission Level = Read Level + Antenna Factor + Cable Loss - Preamp Factor
Margin value = Emission level – Limit value
- 5270MHz: Fundamental frequency.



A D T

EUT TEST CONDITION		MEASUREMENT DETAIL	
CHANNEL	Channel 62	FREQUENCY RANGE	1GHz ~ 40GHz
INPUT POWER	120Vac, 60 Hz	DETECTOR FUNCTION	Peak (PK) Average (AV)
ENVIRONMENTAL CONDITIONS	25deg. C, 65%RH	TESTED BY	Will Chen

ANTENNA POLARITY & TEST DISTANCE: HORIZONTAL AT 3 M										
FREQ. (MHz)	EMISSION LEVEL (dBuV/m)	READ LEVEL (dBuV)	LIMIT (dBuV/m)	MARGIN (dB)	ANTENNA FACTOR (dB/m)	CABLE LOSS (dB)	PREAMP FACTOR (dB)	ANTENNA HEIGHT (cm)	TABLE ANGLE (Degree)	REMARK
5014	42.75	34.74	54	-11.25	34.01	7.97	33.97	152	291	Average
5014	59.11	51.1	74	-14.89	34.01	7.97	33.97	152	291	Peak
5310	94.01	85.46			34.25	8.32	34.02	152	291	Average
5310	102.14	93.59			34.25	8.32	34.02	152	291	Peak
5352	48.66	40.03	54	-5.34	34.28	8.38	34.03	152	291	Average
5352	60.21	51.58	74	-13.79	34.28	8.38	34.03	152	291	Peak
ANTENNA POLARITY & TEST DISTANCE: VERTICAL AT 3 M										
FREQ. (MHz)	EMISSION LEVEL (dBuV/m)	READ LEVEL (dBuV)	LIMIT (dBuV/m)	MARGIN (dB)	ANTENNA FACTOR (dB/m)	CABLE LOSS (dB)	PREAMP FACTOR (dB)	ANTENNA HEIGHT (cm)	TABLE ANGLE (Degree)	REMARK
5060	42.79	34.69	54	-11.21	34.05	8.03	33.98	140	270	Average
5060	58.28	50.18	74	-15.72	34.05	8.03	33.98	140	270	Peak
5310	97.4	88.85			34.25	8.32	34.02	140	270	Average
5310	105.67	97.12			34.25	8.32	34.02	140	270	Peak
5352	50.46	41.83	54	-3.54	34.28	8.38	34.03	140	270	Average
5352	62.27	53.64	74	-11.73	34.28	8.38	34.03	140	270	Peak

REMARKS:

- Emission Level = Read Level + Antenna Factor + Cable Loss - Preamp Factor
Margin value = Emission level – Limit value
- 5310MHz: Fundamental frequency.



A D T

EUT TEST CONDITION		MEASUREMENT DETAIL	
CHANNEL	Channel 102	FREQUENCY RANGE	1GHz ~ 40GHz
INPUT POWER	120Vac, 60 Hz	DETECTOR FUNCTION	Peak (PK) Average (AV)
ENVIRONMENTAL CONDITIONS	25deg. C, 65%RH	TESTED BY	Will Chen

ANTENNA POLARITY & TEST DISTANCE: HORIZONTAL AT 3 M										
FREQ. (MHz)	EMISSION LEVEL (dBuV/m)	READ LEVEL (dBuV)	LIMIT (dBuV/m)	MARGIN (dB)	ANTENNA FACTOR (dB/m)	CABLE LOSS (dB)	PREAMP FACTOR (dB)	ANTENNA HEIGHT (cm)	TABLE ANGLE (Degree)	REMARK
5456	48.37	39.55	54	-5.63	34.36	8.51	34.05	133	33	Average
5456	60.14	51.32	74	-13.86	34.36	8.51	34.05	133	33	Peak
*5470	65.26	56.43	68.2	-2.94	34.37	8.51	34.05	133	33	Peak
5510	96.97	88.06			34.4	8.57	34.06	133	33	Average
5510	104.9	95.99			34.4	8.57	34.06	133	33	Peak
*5725	56.86	47.7	68.2	-11.34	34.62	8.65	34.11	133	33	Peak
ANTENNA POLARITY & TEST DISTANCE: VERTICAL AT 3 M										
FREQ. (MHz)	EMISSION LEVEL (dBuV/m)	READ LEVEL (dBuV)	LIMIT (dBuV/m)	MARGIN (dB)	ANTENNA FACTOR (dB/m)	CABLE LOSS (dB)	PREAMP FACTOR (dB)	ANTENNA HEIGHT (cm)	TABLE ANGLE (Degree)	REMARK
5454	45.71	36.89	54	-8.29	34.36	8.51	34.05	171	340	Average
5454	59.02	50.2	74	-14.98	34.36	8.51	34.05	171	340	Peak
*5470	60.15	51.32	68.2	-8.05	34.37	8.51	34.05	171	340	Peak
5510	92.64	83.73			34.4	8.57	34.06	171	340	Average
5510	101.09	92.18			34.4	8.57	34.06	171	340	Peak
*5725	56.32	47.16	68.2	-11.88	34.62	8.65	34.11	171	340	Peak

REMARKS:

- Emission Level = Read Level + Antenna Factor + Cable Loss - Preamp Factor
Margin value = Emission level – Limit value
- 5510MHz: Fundamental frequency.
- *: Out of restricted band



A D T

EUT TEST CONDITION		MEASUREMENT DETAIL	
CHANNEL	Channel 110	FREQUENCY RANGE	1GHz ~ 40GHz
INPUT POWER	120Vac, 60 Hz	DETECTOR FUNCTION	Peak (PK) Average (AV)
ENVIRONMENTAL CONDITIONS	25deg. C, 65%RH	TESTED BY	Will Chen

ANTENNA POLARITY & TEST DISTANCE: HORIZONTAL AT 3 M										
FREQ. (MHz)	EMISSION LEVEL (dBuV/m)	READ LEVEL (dBuV)	LIMIT (dBuV/m)	MARGIN (dB)	ANTENNA FACTOR (dB/m)	CABLE LOSS (dB)	PREAMP FACTOR (dB)	ANTENNA HEIGHT (cm)	TABLE ANGLE (Degree)	REMARK
5440	43.45	34.66	54	-10.55	34.35	8.48	34.04	130	34	Average
5440	58.28	49.49	74	-15.72	34.35	8.48	34.04	130	34	Peak
*5470	56.6	47.77	68.2	-11.6	34.37	8.51	34.05	130	34	Peak
5550	96.87	87.9			34.45	8.59	34.07	130	34	Average
5550	105.25	96.28			34.45	8.59	34.07	130	34	Peak
*5725	57.44	48.28	68.2	-10.76	34.62	8.65	34.11	130	34	Peak
ANTENNA POLARITY & TEST DISTANCE: VERTICAL AT 3 M										
FREQ. (MHz)	EMISSION LEVEL (dBuV/m)	READ LEVEL (dBuV)	LIMIT (dBuV/m)	MARGIN (dB)	ANTENNA FACTOR (dB/m)	CABLE LOSS (dB)	PREAMP FACTOR (dB)	ANTENNA HEIGHT (cm)	TABLE ANGLE (Degree)	REMARK
5450	43.29	34.47	54	-10.71	34.36	8.51	34.05	105	355	Average
5450	57.71	48.89	74	-16.29	34.36	8.51	34.05	105	355	Peak
*5470	57.15	48.32	68.2	-11.05	34.37	8.51	34.05	105	355	Peak
5550	93.56	84.59			34.45	8.59	34.07	105	355	Average
5550	101.09	92.12			34.45	8.59	34.07	105	355	Peak
*5725	57.41	48.25	68.2	-10.79	34.62	8.65	34.11	105	355	Peak

REMARKS:

- Emission Level = Read Level + Antenna Factor + Cable Loss - Preamp Factor
Margin value = Emission level – Limit value
- 5550MHz: Fundamental frequency.
- *: Out of restricted band



A D T

EUT TEST CONDITION		MEASUREMENT DETAIL	
CHANNEL	Channel 134	FREQUENCY RANGE	1GHz ~ 40GHz
INPUT POWER	120Vac, 60 Hz	DETECTOR FUNCTION	Peak (PK) Average (AV)
ENVIRONMENTAL CONDITIONS	25deg. C, 65%RH	TESTED BY	Will Chen

ANTENNA POLARITY & TEST DISTANCE: HORIZONTAL AT 3 M										
FREQ. (MHz)	EMISSION LEVEL (dBuV/m)	READ LEVEL (dBuV)	LIMIT (dBuV/m)	MARGIN (dB)	ANTENNA FACTOR (dB/m)	CABLE LOSS (dB)	PREAMP FACTOR (dB)	ANTENNA HEIGHT (cm)	TABLE ANGLE (Degree)	REMARK
5458	43.31	34.49	54	-10.69	34.36	8.51	34.05	127	34	Average
5458	57.72	48.9	74	-16.28	34.36	8.51	34.05	127	34	Peak
*5470	56.71	47.88	68.2	-11.49	34.37	8.51	34.05	127	34	Peak
5670	97.23	88.13			34.57	8.63	34.1	127	34	Average
5670	105.62	96.52			34.57	8.63	34.1	127	34	Peak
*5725	60	50.84	68.2	-8.2	34.62	8.65	34.11	127	34	Peak

ANTENNA POLARITY & TEST DISTANCE: VERTICAL AT 3 M										
FREQ. (MHz)	EMISSION LEVEL (dBuV/m)	READ LEVEL (dBuV)	LIMIT (dBuV/m)	MARGIN (dB)	ANTENNA FACTOR (dB/m)	CABLE LOSS (dB)	PREAMP FACTOR (dB)	ANTENNA HEIGHT (cm)	TABLE ANGLE (Degree)	REMARK
5454	43.25	34.43	54	-10.75	34.36	8.51	34.05	103	353	Average
5454	56.83	48.01	74	-17.17	34.36	8.51	34.05	103	353	Peak
*5470	55.69	46.86	68.2	-12.51	34.37	8.51	34.05	103	353	Peak
5670	93.29	84.19			34.57	8.63	34.1	103	353	Average
5670	101.43	92.33			34.57	8.63	34.1	103	353	Peak
*5725	57.29	48.13	68.2	-10.91	34.62	8.65	34.11	103	353	Peak

REMARKS:

- Emission Level = Read Level + Antenna Factor + Cable Loss - Preamp Factor
Margin value = Emission level – Limit value
- 5670MHz: Fundamental frequency.
- *: Out of restricted band



A D T

EUT TEST CONDITION		MEASUREMENT DETAIL	
CHANNEL	Channel 151	FREQUENCY RANGE	1GHz ~ 40GHz
INPUT POWER	120Vac, 60 Hz	DETECTOR FUNCTION	Peak (PK) Average (AV)
ENVIRONMENTAL CONDITIONS	25deg. C, 65%RH	TESTED BY	Will Chen

ANTENNA POLARITY & TEST DISTANCE: HORIZONTAL AT 3 M

FREQ. (MHz)	EMISSION LEVEL (dBuV/m)	READ LEVEL (dBuV)	LIMIT (dBuV/m)	MARGIN (dB)	ANTENNA FACTOR (dB/m)	CABLE LOSS (dB)	PREAMP FACTOR (dB)	ANTENNA HEIGHT (cm)	TABLE ANGLE (Degree)	REMARK
*5712	58.69	49.54	68.2	-9.51	34.61	8.65	34.11	100	351	Peak
*5724	62.3	53.14	78.2	-15.9	34.62	8.65	34.11	100	351	Peak
5755	91.84	82.63			34.66	8.66	34.11	100	351	Average
5755	99.21	90			34.66	8.66	34.11	100	351	Peak
*5860	56.47	47.15	78.2	-21.73	34.76	8.7	34.14	100	351	Peak
*5868	56.68	47.35	68.2	-11.52	34.76	8.71	34.14	100	351	Peak

ANTENNA POLARITY & TEST DISTANCE: VERTICAL AT 3 M

FREQ. (MHz)	EMISSION LEVEL (dBuV/m)	READ LEVEL (dBuV)	LIMIT (dBuV/m)	MARGIN (dB)	ANTENNA FACTOR (dB/m)	CABLE LOSS (dB)	PREAMP FACTOR (dB)	ANTENNA HEIGHT (cm)	TABLE ANGLE (Degree)	REMARK
*5708	64.15	55	68.2	-4.05	34.61	8.65	34.11	100	97	Peak
*5716	68.83	59.68	78.2	-9.37	34.61	8.65	34.11	100	97	Peak
5755	96.59	87.38			34.66	8.66	34.11	100	97	Average
5755	104.89	95.68			34.66	8.66	34.11	100	97	Peak
*5856	56.54	47.22	78.2	-21.66	34.76	8.7	34.14	100	97	Peak
*5870	56.47	47.14	68.2	-11.73	34.76	8.71	34.14	100	97	Peak

REMARKS:

- Emission Level = Read Level + Antenna Factor + Cable Loss - Preamp Factor
Margin value = Emission level – Limit value
- 5755MHz: Fundamental frequency.
- *: Out of restricted band



A D T

EUT TEST CONDITION		MEASUREMENT DETAIL	
CHANNEL	Channel 159	FREQUENCY RANGE	1GHz ~ 40GHz
INPUT POWER	120Vac, 60 Hz	DETECTOR FUNCTION	Peak (PK) Average (AV)
ENVIRONMENTAL CONDITIONS	25deg. C, 65%RH	TESTED BY	Will Chen

ANTENNA POLARITY & TEST DISTANCE: HORIZONTAL AT 3 M

FREQ. (MHz)	EMISSION LEVEL (dBuV/m)	READ LEVEL (dBuV)	LIMIT (dBuV/m)	MARGIN (dB)	ANTENNA FACTOR (dB/m)	CABLE LOSS (dB)	PREAMP FACTOR (dB)	ANTENNA HEIGHT (cm)	TABLE ANGLE (Degree)	REMARK
*5616	57.33	48.28	68.2	-10.87	34.52	8.61	34.08	100	351	Peak
*5718	56.57	47.41	78.2	-21.63	34.62	8.65	34.11	100	351	Peak
5795	91.9	82.66			34.69	8.68	34.13	100	351	Average
5795	99.47	90.23			34.69	8.68	34.13	100	351	Peak
*5858	56.8	47.48	78.2	-21.4	34.76	8.7	34.14	100	351	Peak
*5862	56.67	47.34	68.2	-11.53	34.76	8.71	34.14	100	351	Peak

ANTENNA POLARITY & TEST DISTANCE: VERTICAL AT 3 M

FREQ. (MHz)	EMISSION LEVEL (dBuV/m)	READ LEVEL (dBuV)	LIMIT (dBuV/m)	MARGIN (dB)	ANTENNA FACTOR (dB/m)	CABLE LOSS (dB)	PREAMP FACTOR (dB)	ANTENNA HEIGHT (cm)	TABLE ANGLE (Degree)	REMARK
*5594	57.96	48.95	68.2	-10.24	34.49	8.6	34.08	100	96	Peak
*5720	57.93	48.77	78.2	-20.27	34.62	8.65	34.11	100	96	Peak
5795	96.9	87.66			34.69	8.68	34.13	100	96	Average
5795	104.91	95.67			34.69	8.68	34.13	100	96	Peak
*5860	57.63	48.31	78.2	-20.57	34.76	8.7	34.14	100	96	Peak
*5870	58.2	48.87	68.2	-10	34.76	8.71	34.14	100	96	Peak

REMARKS:

- Emission Level = Read Level + Antenna Factor + Cable Loss - Preamp Factor
Margin value = Emission level – Limit value
- 5795MHz: Fundamental frequency.
- *: Out of restricted band



A D T

802.11ac (80MHz)

EUT TEST CONDITION		MEASUREMENT DETAIL	
CHANNEL	Channel 42	FREQUENCY RANGE	1GHz ~ 40GHz
INPUT POWER	120Vac, 60 Hz	DETECTOR FUNCTION	Peak (PK) Average (AV)
ENVIRONMENTAL CONDITIONS	25deg. C, 65%RH	TESTED BY	Will Chen

ANTENNA POLARITY & TEST DISTANCE: HORIZONTAL AT 3 M										
FREQ. (MHz)	EMISSION LEVEL (dBuV/m)	READ LEVEL (dBuV)	LIMIT (dBuV/m)	MARGIN (dB)	ANTENNA FACTOR (dB/m)	CABLE LOSS (dB)	PREAMP FACTOR (dB)	ANTENNA HEIGHT (cm)	TABLE ANGLE (Degree)	REMARK
5136	47.56	39.31	54	-6.44	34.11	8.13	33.99	162	301	Average
5136	60.35	52.1	74	-13.65	34.11	8.13	33.99	162	301	Peak
5210	92.87	84.51			34.17	8.19	34	162	301	Average
5210	100.5	92.14			34.17	8.19	34	162	301	Peak
5450	43.67	34.85	54	-10.33	34.36	8.51	34.05	162	301	Average
5450	58.82	50	74	-15.18	34.36	8.51	34.05	162	301	Peak
ANTENNA POLARITY & TEST DISTANCE: VERTICAL AT 3 M										
FREQ. (MHz)	EMISSION LEVEL (dBuV/m)	READ LEVEL (dBuV)	LIMIT (dBuV/m)	MARGIN (dB)	ANTENNA FACTOR (dB/m)	CABLE LOSS (dB)	PREAMP FACTOR (dB)	ANTENNA HEIGHT (cm)	TABLE ANGLE (Degree)	REMARK
5142	49.9	41.64	54	-4.1	34.12	8.13	33.99	144	270	Average
5142	62.09	53.83	74	-11.91	34.12	8.13	33.99	144	270	Peak
5210	95.77	87.41			34.17	8.19	34	144	270	Average
5210	103.68	95.32			34.17	8.19	34	144	270	Peak
5370	43.31	34.64	54	-10.69	34.29	8.41	34.03	144	270	Average
5370	58.98	50.31	74	-15.02	34.29	8.41	34.03	144	270	Peak

REMARKS:

- Emission Level = Read Level + Antenna Factor + Cable Loss - Preamp Factor
Margin value = Emission level – Limit value
- 5210MHz: Fundamental frequency.



A D T

EUT TEST CONDITION		MEASUREMENT DETAIL	
CHANNEL	Channel 58	FREQUENCY RANGE	1GHz ~ 40GHz
INPUT POWER	120Vac, 60 Hz	DETECTOR FUNCTION	Peak (PK) Average (AV)
ENVIRONMENTAL CONDITIONS	25deg. C, 65%RH	TESTED BY	Will Chen

ANTENNA POLARITY & TEST DISTANCE: HORIZONTAL AT 3 M

FREQ. (MHz)	EMISSION LEVEL (dBuV/m)	READ LEVEL (dBuV)	LIMIT (dBuV/m)	MARGIN (dB)	ANTENNA FACTOR (dB/m)	CABLE LOSS (dB)	PREAMP FACTOR (dB)	ANTENNA HEIGHT (cm)	TABLE ANGLE (Degree)	REMARK
5114	43.3	35.1	54	-10.7	34.09	8.1	33.99	157	295	Average
5114	58.55	50.35	74	-15.45	34.09	8.1	33.99	157	295	Peak
5290	91.64	83.11			34.23	8.32	34.02	157	295	Average
5290	99.8	91.27			34.23	8.32	34.02	157	295	Peak
5350	46.23	37.6	54	-7.77	34.28	8.38	34.03	157	295	Average
5350	60.63	52	74	-13.37	34.28	8.38	34.03	157	295	Peak

ANTENNA POLARITY & TEST DISTANCE: VERTICAL AT 3 M

FREQ. (MHz)	EMISSION LEVEL (dBuV/m)	READ LEVEL (dBuV)	LIMIT (dBuV/m)	MARGIN (dB)	ANTENNA FACTOR (dB/m)	CABLE LOSS (dB)	PREAMP FACTOR (dB)	ANTENNA HEIGHT (cm)	TABLE ANGLE (Degree)	REMARK
5146	43.31	35.06	54	-10.69	34.12	8.13	34	140	271	Average
5146	58.86	50.61	74	-15.14	34.12	8.13	34	140	271	Peak
5290	94.93	86.4			34.23	8.32	34.02	140	271	Average
5290	102.86	94.33			34.23	8.32	34.02	140	271	Peak
5354	48.84	40.21	54	-5.16	34.28	8.38	34.03	140	271	Average
5354	61.18	52.55	74	-12.82	34.28	8.38	34.03	140	271	Peak

REMARKS:

- Emission Level = Read Level + Antenna Factor + Cable Loss - Preamp Factor
Margin value = Emission level – Limit value
- 5290MHz: Fundamental frequency.



A D T

EUT TEST CONDITION		MEASUREMENT DETAIL	
CHANNEL	Channel 106	FREQUENCY RANGE	1GHz ~ 40GHz
INPUT POWER	120Vac, 60 Hz	DETECTOR FUNCTION	Peak (PK) Average (AV)
ENVIRONMENTAL CONDITIONS	25deg. C, 65%RH	TESTED BY	Will Chen

ANTENNA POLARITY & TEST DISTANCE: HORIZONTAL AT 3 M										
FREQ. (MHz)	EMISSION LEVEL (dBuV/m)	READ LEVEL (dBuV)	LIMIT (dBuV/m)	MARGIN (dB)	ANTENNA FACTOR (dB/m)	CABLE LOSS (dB)	PREAMP FACTOR (dB)	ANTENNA HEIGHT (cm)	TABLE ANGLE (Degree)	REMARK
5446	46.94	38.11	54	-7.06	34.36	8.51	34.04	130	34	Average
5446	59.1	50.27	74	-14.9	34.36	8.51	34.04	130	34	Peak
*5470	58.73	49.9	68.2	-9.47	34.37	8.51	34.05	130	34	Peak
5530	94.67	85.74			34.42	8.58	34.07	130	34	Average
5530	103.24	94.31			34.42	8.58	34.07	130	34	Peak
*5725	57.27	48.11	68.2	-10.93	34.62	8.65	34.11	130	34	Peak
ANTENNA POLARITY & TEST DISTANCE: VERTICAL AT 3 M										
FREQ. (MHz)	EMISSION LEVEL (dBuV/m)	READ LEVEL (dBuV)	LIMIT (dBuV/m)	MARGIN (dB)	ANTENNA FACTOR (dB/m)	CABLE LOSS (dB)	PREAMP FACTOR (dB)	ANTENNA HEIGHT (cm)	TABLE ANGLE (Degree)	REMARK
5456	45.63	36.81	54	-8.37	34.36	8.51	34.05	105	352	Average
5456	58.7	49.88	74	-15.3	34.36	8.51	34.05	105	352	Peak
*5470	57.54	48.71	68.2	-10.66	34.37	8.51	34.05	105	352	Peak
5530	91.66	82.73			34.42	8.58	34.07	105	352	Average
5530	99.36	90.43			34.42	8.58	34.07	105	352	Peak
*5725	57.27	48.11	68.2	-10.93	34.62	8.65	34.11	105	352	Peak

REMARKS:

- Emission Level = Read Level + Antenna Factor + Cable Loss - Preamp Factor
Margin value = Emission level – Limit value
- 5530MHz: Fundamental frequency.
- *: Out of restricted band



A D T

EUT TEST CONDITION		MEASUREMENT DETAIL	
CHANNEL	Channel 155	FREQUENCY RANGE	1GHz ~ 40GHz
INPUT POWER	120Vac, 60 Hz	DETECTOR FUNCTION	Peak (PK) Average (AV)
ENVIRONMENTAL CONDITIONS	25deg. C, 65%RH	TESTED BY	Will Chen

ANTENNA POLARITY & TEST DISTANCE: HORIZONTAL AT 3 M

FREQ. (MHz)	EMISSION LEVEL (dBuV/m)	READ LEVEL (dBuV)	LIMIT (dBuV/m)	MARGIN (dB)	ANTENNA FACTOR (dB/m)	CABLE LOSS (dB)	PREAMP FACTOR (dB)	ANTENNA HEIGHT (cm)	TABLE ANGLE (Degree)	REMARK
*5548	57.7	48.74	68.2	-10.5	34.45	8.58	34.07	100	352	Peak
*5716	57.16	48.01	78.2	-21.04	34.61	8.65	34.11	100	352	Peak
5775	89.91	80.68			34.68	8.67	34.12	100	352	Average
5775	97.79	88.56			34.68	8.67	34.12	100	352	Peak
*5854	57.89	48.57	78.2	-20.31	34.76	8.7	34.14	100	352	Peak
*5870	57.91	48.58	68.2	-10.29	34.76	8.71	34.14	100	352	Peak

ANTENNA POLARITY & TEST DISTANCE: VERTICAL AT 3 M

FREQ. (MHz)	EMISSION LEVEL (dBuV/m)	READ LEVEL (dBuV)	LIMIT (dBuV/m)	MARGIN (dB)	ANTENNA FACTOR (dB/m)	CABLE LOSS (dB)	PREAMP FACTOR (dB)	ANTENNA HEIGHT (cm)	TABLE ANGLE (Degree)	REMARK
*5696	60.28	51.15	68.2	-7.92	34.59	8.64	34.1	100	96	Peak
*5724	60.67	51.51	78.2	-17.53	34.62	8.65	34.11	100	96	Peak
5775	94.87	85.64			34.68	8.67	34.12	100	96	Average
5775	102.72	93.49			34.68	8.67	34.12	100	96	Peak
*5860	58.43	49.11	78.2	-19.77	34.76	8.7	34.14	100	96	Peak
*5864	58.74	49.41	68.2	-9.46	34.76	8.71	34.14	100	96	Peak

REMARKS:

- Emission Level = Read Level + Antenna Factor + Cable Loss - Preamp Factor
Margin value = Emission level – Limit value
- 5775MHz: Fundamental frequency.
- *: Out of restricted band



A D T

BELOW 1GHz WORST-CASE DATA:

802.11n (40MHz)

EUT TEST CONDITION		MEASUREMENT DETAIL	
CHANNEL	Channel 38	FREQUENCY RANGE	30MHz ~ 1GHz
INPUT POWER	120Vac, 60 Hz	DETECTOR FUNCTION	Peak (PK)
ENVIRONMENTAL CONDITIONS	25deg. C, 65%RH	TESTED BY	Will Chen

ANTENNA POLARITY & TEST DISTANCE: HORIZONTAL AT 3 M

FREQ. (MHz)	EMISSION LEVEL (dBuV/m)	READ LEVEL (dBuV)	LIMIT (dBuV/m)	MARGIN (dB)	ANTENNA FACTOR (dB/m)	CABLE LOSS (dB)	PREAMP FACTOR (dB)	ANTENNA HEIGHT (cm)	TABLE ANGLE (Degree)	REMARK
55.92	20.79	44.94	40	-19.21	7.18	0.9	32.23	107	207	Peak
170.67	32.25	52.93	43.5	-11.25	10.04	1.52	32.24	100	103	Peak
286.23	24.79	41.09	46	-21.21	13.8	2.03	32.13	138	149	Peak
307	20.38	36.07	46	-25.62	14.33	2.11	32.13	194	289	Peak
680.8	24.81	30.56	46	-21.19	23.31	3.05	32.11	168	8	Peak
999.3	29.2	29.68	54	-24.8	26.1	3.72	30.3	181	18	Peak

ANTENNA POLARITY & TEST DISTANCE: VERTICAL AT 3 M

FREQ. (MHz)	EMISSION LEVEL (dBuV/m)	READ LEVEL (dBuV)	LIMIT (dBuV/m)	MARGIN (dB)	ANTENNA FACTOR (dB/m)	CABLE LOSS (dB)	PREAMP FACTOR (dB)	ANTENNA HEIGHT (cm)	TABLE ANGLE (Degree)	REMARK
48.36	29.68	52.69	40	-10.32	8.31	0.9	32.22	148	83	Peak
95.88	26.6	47.98	43.5	-16.9	9.38	1.28	32.04	128	241	Peak
188.49	23.66	43.9	43.5	-19.84	10.4	1.61	32.25	190	144	Peak
405.7	18.4	30.29	46	-27.6	17.99	2.34	32.22	179	91	Peak
680.8	24.42	30.17	46	-21.58	23.31	3.05	32.11	123	345	Peak
930	28.71	30.15	46	-17.29	26.2	3.62	31.26	193	310	Peak

REMARKS: Emission Level = Read Level + Antenna Factor + Cable Loss - Preamp Factor

Margin value = Emission level – Limit value



A D T

802.11n (40MHz)

EUT TEST CONDITION		MEASUREMENT DETAIL	
CHANNEL	Channel 62	FREQUENCY RANGE	30MHz ~ 1GHz
INPUT POWER	120Vac, 60 Hz	DETECTOR FUNCTION	Peak (PK)
ENVIRONMENTAL CONDITIONS	25deg. C, 65%RH	TESTED BY	Will Chen

ANTENNA POLARITY & TEST DISTANCE: HORIZONTAL AT 3 M										
FREQ. (MHz)	EMISSION LEVEL (dBuV/m)	READ LEVEL (dBuV)	LIMIT (dBuV/m)	MARGIN (dB)	ANTENNA FACTOR (dB/m)	CABLE LOSS (dB)	PREAMP FACTOR (dB)	ANTENNA HEIGHT (cm)	TABLE ANGLE (Degree)	REMARK
56.19	20.29	44.47	40	-19.71	7.15	0.9	32.23	156	194	Peak
99.12	28.03	49.34	43.5	-15.47	9.62	1.28	32.21	199	121	Peak
170.13	32.29	53.01	43.5	-11.21	10	1.52	32.24	113	173	Peak
311.9	21.05	36.47	46	-24.95	14.59	2.11	32.12	145	211	Peak
685.7	25.83	31.61	46	-20.17	23.27	3.05	32.1	168	57	Peak
933.5	28.62	30.04	46	-17.38	26.2	3.62	31.24	128	209	Peak
ANTENNA POLARITY & TEST DISTANCE: VERTICAL AT 3 M										
FREQ. (MHz)	EMISSION LEVEL (dBuV/m)	READ LEVEL (dBuV)	LIMIT (dBuV/m)	MARGIN (dB)	ANTENNA FACTOR (dB/m)	CABLE LOSS (dB)	PREAMP FACTOR (dB)	ANTENNA HEIGHT (cm)	TABLE ANGLE (Degree)	REMARK
31.89	30.33	45.52	40	-9.67	16.33	0.74	32.26	130	329	Peak
95.88	25.84	47.22	43.5	-17.66	9.38	1.28	32.04	188	204	Peak
189.57	23.82	44.06	43.5	-19.68	10.4	1.61	32.25	155	233	Peak
457.5	19.39	30.77	46	-26.61	18.27	2.49	32.14	175	346	Peak
696.2	25.48	31.32	46	-20.52	23.14	3.11	32.09	111	11	Peak
988.1	29.21	29.99	54	-24.79	25.98	3.72	30.48	118	112	Peak

REMARKS: Emission Level = Read Level + Antenna Factor + Cable Loss - Preamp Factor

Margin value = Emission level – Limit value



A D T

802.11n (20MHz)

EUT TEST CONDITION		MEASUREMENT DETAIL	
CHANNEL	Channel 140	FREQUENCY RANGE	30MHz ~ 1GHz
INPUT POWER	120Vac, 60 Hz	DETECTOR FUNCTION	Peak (PK)
ENVIRONMENTAL CONDITIONS	25deg. C, 65%RH	TESTED BY	Will Chen

ANTENNA POLARITY & TEST DISTANCE: HORIZONTAL AT 3 M										
FREQ. (MHz)	EMISSION LEVEL (dBuV/m)	READ LEVEL (dBuV)	LIMIT (dBuV/m)	MARGIN (dB)	ANTENNA FACTOR (dB/m)	CABLE LOSS (dB)	PREAMP FACTOR (dB)	ANTENNA HEIGHT (cm)	TABLE ANGLE (Degree)	REMARK
56.19	20.04	44.22	40	-19.96	7.15	0.9	32.23	120	344	Peak
99.93	28.21	49.53	43.5	-15.29	9.66	1.28	32.26	143	149	Peak
171.75	32.13	52.78	43.5	-11.37	10.07	1.52	32.24	107	152	Peak
311.9	20.64	36.06	46	-25.36	14.59	2.11	32.12	119	311	Peak
722.8	25.09	30.68	46	-20.91	23.36	3.16	32.11	171	357	Peak
880.3	29.71	32.98	46	-16.29	24.84	3.49	31.6	124	84	Peak
ANTENNA POLARITY & TEST DISTANCE: VERTICAL AT 3 M										
FREQ. (MHz)	EMISSION LEVEL (dBuV/m)	READ LEVEL (dBuV)	LIMIT (dBuV/m)	MARGIN (dB)	ANTENNA FACTOR (dB/m)	CABLE LOSS (dB)	PREAMP FACTOR (dB)	ANTENNA HEIGHT (cm)	TABLE ANGLE (Degree)	REMARK
48.36	29.74	52.75	40	-10.26	8.31	0.9	32.22	136	248	Peak
96.15	26.14	47.52	43.5	-17.36	9.38	1.28	32.04	104	105	Peak
187.68	23.98	44.22	43.5	-19.52	10.4	1.61	32.25	199	9	Peak
412.7	18.55	30.46	46	-27.45	17.88	2.41	32.2	185	48	Peak
687.8	24.53	30.35	46	-21.47	23.23	3.05	32.1	177	77	Peak
880.3	34.74	38.01	46	-11.26	24.84	3.49	31.6	133	29	Peak

REMARKS: Emission Level = Read Level + Antenna Factor + Cable Loss - Preamp Factor

Margin value = Emission level – Limit value



A D T

802.11n (20MHz)

EUT TEST CONDITION		MEASUREMENT DETAIL	
CHANNEL	Channel 149	FREQUENCY RANGE	30MHz ~ 1GHz
INPUT POWER	120Vac, 60 Hz	DETECTOR FUNCTION	Peak (PK)
ENVIRONMENTAL CONDITIONS	25deg. C, 65%RH	TESTED BY	Will Chen

ANTENNA POLARITY & TEST DISTANCE: HORIZONTAL AT 3 M										
FREQ. (MHz)	EMISSION LEVEL (dBuV/m)	READ LEVEL (dBuV)	LIMIT (dBuV/m)	MARGIN (dB)	ANTENNA FACTOR (dB/m)	CABLE LOSS (dB)	PREAMP FACTOR (dB)	ANTENNA HEIGHT (cm)	TABLE ANGLE (Degree)	REMARK
55.92	21.12	45.27	40	-18.88	7.18	0.9	32.23	155	192	Peak
99.66	28.92	50.24	43.5	-14.58	9.66	1.28	32.26	166	96	Peak
168.51	32.69	53.26	43.5	-10.81	10.15	1.52	32.24	168	151	Peak
311.9	20.89	36.31	46	-25.11	14.59	2.11	32.12	174	263	Peak
666.1	25.81	31.98	46	-20.19	22.97	2.99	32.13	161	258	Peak
943.3	28.5	29.84	46	-17.5	26.2	3.62	31.16	194	330	Peak
ANTENNA POLARITY & TEST DISTANCE: VERTICAL AT 3 M										
FREQ. (MHz)	EMISSION LEVEL (dBuV/m)	READ LEVEL (dBuV)	LIMIT (dBuV/m)	MARGIN (dB)	ANTENNA FACTOR (dB/m)	CABLE LOSS (dB)	PREAMP FACTOR (dB)	ANTENNA HEIGHT (cm)	TABLE ANGLE (Degree)	REMARK
30	29.48	43.21	40	-10.52	17.8	0.74	32.27	165	255	Peak
96.15	25.89	47.27	43.5	-17.61	9.38	1.28	32.04	150	64	Peak
181.74	23.82	44.05	43.5	-19.68	10.4	1.61	32.24	170	85	Peak
442.8	18.82	30.57	46	-27.18	17.92	2.49	32.16	156	308	Peak
736.1	25.32	30.96	46	-20.68	23.33	3.16	32.13	161	73	Peak
997.2	28.47	29.04	54	-25.53	26.04	3.72	30.33	129	141	Peak

REMARKS: Emission Level = Read Level + Antenna Factor + Cable Loss - Preamp Factor

Margin value = Emission level – Limit value

4.2 CONDUCTED EMISSION MEASUREMENT

4.2.1 LIMITS OF CONDUCTED EMISSION MEASUREMENT

FREQUENCY OF EMISSION (MHz)	CONDUCTED LIMIT (dB μ V)	
	Quasi-peak	Average
0.15 ~ 0.5	66 to 56	56 to 46
0.5 ~ 5	56	46
5 ~ 30	60	50

NOTE:

1. The lower limit shall apply at the transition frequencies.
2. The limit decreases in line with the logarithm of the frequency in the range of 0.15 to 0.50MHz.
3. All emanations from a class A/B digital device or system, including any network of conductors and apparatus connected thereto, shall not exceed the level of field strengths specified above.

4.2.2 TEST INSTRUMENTS

DESCRIPTION & MANUFACTURER	MODEL NO.	SERIAL NO.	DATE OF CALIBRATION	DUE DATE OF CALIBRATION
Test Receiver ROHDE & SCHWARZ	ESCI	100612	Sep. 30, 2014	Sep. 29, 2015
RF signal cable Woken	5D-FB	Cable-HYC01-01	Dec. 26, 2014	Dec. 25, 2015
LISN ROHDE & SCHWARZ (EUT)	ESH3-Z5	835239/001	Feb. 13, 2014	Feb. 12, 2015
LISN ROHDE & SCHWARZ (Peripheral)	ESH3-Z5	100311	Jul. 21, 2014	Jul. 20, 2015
Software ADT	BV ADT_Cond_ V7.3.7.3	NA	NA	NA

- NOTE:**
1. The calibration interval of the above test instruments is 12 months and the calibrations are traceable to NML/ROC and NIST/USA.
 2. The test was performed in HwaYa Shielded Room 1.
 3. The VCCI Site Registration No. is C-2040.

4.2.3 TEST PROCEDURES

- a. The EUT was placed 0.4 meters from the conducting wall of the shielded room with EUT being connected to the power mains through a line impedance stabilization network (LISN). Other support units were connected to the power mains through another LISN. The two LISNs provide 50 ohm/ 50uH of coupling impedance for the measuring instrument.
- b. Both lines of the power mains connected to the EUT were checked for maximum conducted interference.
- c. The frequency range from 150kHz to 30MHz was searched. Emission levels under (Limit - 20dB) was not recorded.

NOTE: All modes of operation were investigated and the worst-case emissions are reported.

4.2.4 DEVIATION FROM TEST STANDARD

No deviation.

4.2.5 TEST SETUP

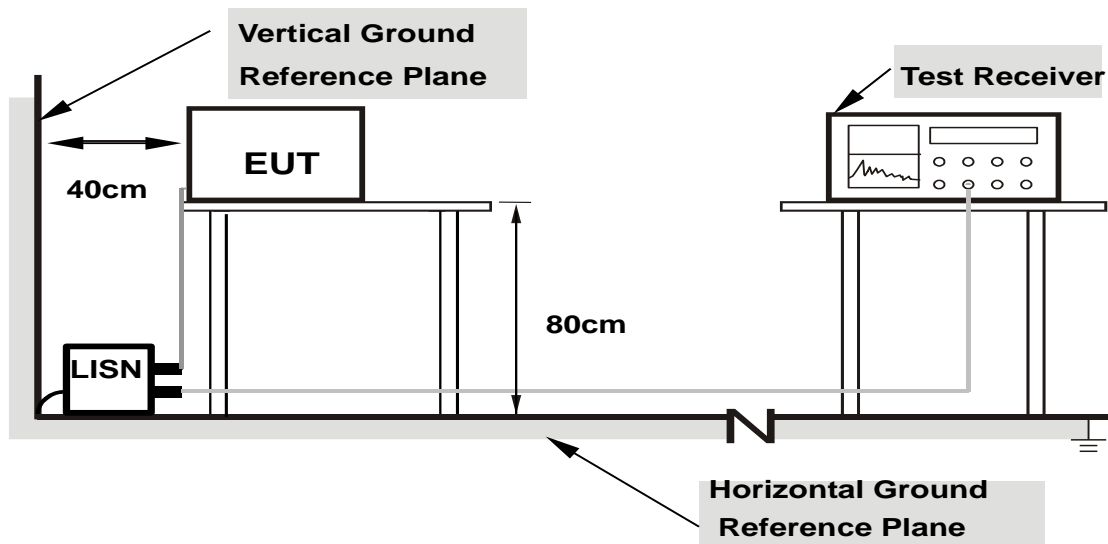

- Note:**
1. Support units were connected to second LISN.
 2. Both of LISNs (AMN) are 80 cm from EUT and at least 80 from other units and other metal planes

For the actual test configuration, please refer to the attached file (Test Setup Photo).

4.2.6 EUT OPERATING CONDITIONS

Same as section 4.1.6.

4.2.7 TEST RESULTS

CONDUCTED WORST-CASE DATA :

Frequency Range	150kHz ~ 30MHz	Detector Function & Resolution Bandwidth	Quasi-Peak (QP) / Average (AV), 9kHz
Input Power	120Vac, 60Hz	Environmental Conditions	25°C, 65%RH
Tested by	Anson Lin	Test Date	2015/1/10

Phase Of Power : Line (L)										
No	Frequency (MHz)	Correction Factor (dB)	Reading Value (dBuV)		Emission Level (dBuV)		Limit (dBuV)		Margin (dB)	
			Q.P.	AV.	Q.P.	AV.	Q.P.	AV.	Q.P.	AV.
1	0.37700	0.08	41.49	33.57	41.57	33.65	58.35	48.35	-16.78	-14.70
2	0.56418	0.09	44.45	33.79	44.54	33.88	56.00	46.00	-11.46	-12.12
3	0.86229	0.10	42.63	31.61	42.73	31.71	56.00	46.00	-13.27	-14.29
4	1.07667	0.11	41.40	31.59	41.51	31.70	56.00	46.00	-14.49	-14.30
5	1.53149	0.13	41.09	32.00	41.22	32.13	56.00	46.00	-14.78	-13.87
6	3.71592	0.22	40.66	31.84	40.88	32.06	56.00	46.00	-15.12	-13.94

Remarks:

1. Q.P. and AV. are abbreviations of quasi-peak and average individually.
2. The emission levels of other frequencies were very low against the limit.
3. Margin value = Emission level – Limit value
4. Correction factor = Insertion loss + Cable loss
5. Emission Level = Correction Factor + Reading Value

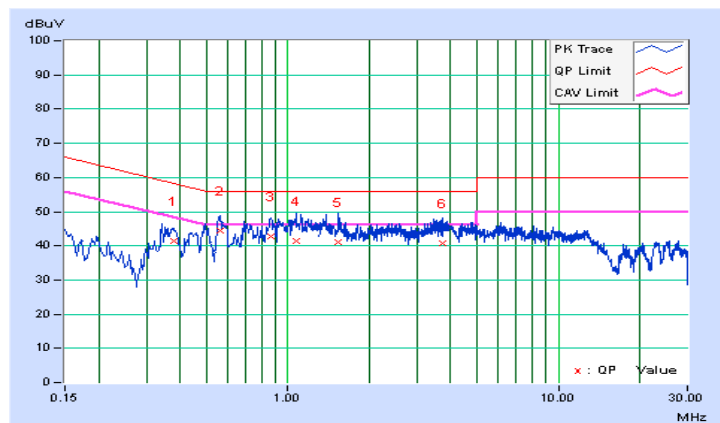



A D T

Frequency Range	150kHz ~ 30MHz	Detector Function & Resolution Bandwidth	Quasi-Peak (QP) / Average (AV), 9kHz
Input Power	120Vac, 60Hz	Environmental Conditions	25°C, 65%RH
Tested by	Anson Lin	Test Date	2015/1/10

Phase Of Power : Neutral (N)										
No	Frequency (MHz)	Correction Factor (dB)	Reading Value (dBuV)		Emission Level (dBuV)		Limit (dBuV)		Margin (dB)	
			Q.P.	AV.	Q.P.	AV.	Q.P.	AV.	Q.P.	AV.
1	0.36505	0.07	34.73	26.79	34.80	26.86	58.61	48.61	-23.82	-21.76
2	0.45097	0.07	42.27	31.96	42.34	32.03	56.86	46.86	-14.52	-14.83
3	0.58792	0.08	41.68	30.48	41.76	30.56	56.00	46.00	-14.24	-15.44
4	0.95546	0.09	41.24	32.21	41.33	32.30	56.00	46.00	-14.67	-13.70
5	2.37088	0.15	37.12	28.53	37.27	28.68	56.00	46.00	-18.73	-17.32
6	3.53606	0.19	36.71	28.53	36.90	28.72	56.00	46.00	-19.10	-17.28

Remarks:

1. Q.P. and AV. are abbreviations of quasi-peak and average individually.
2. The emission levels of other frequencies were very low against the limit.
3. Margin value = Emission level – Limit value
4. Correction factor = Insertion loss + Cable loss
5. Emission Level = Correction Factor + Reading Value

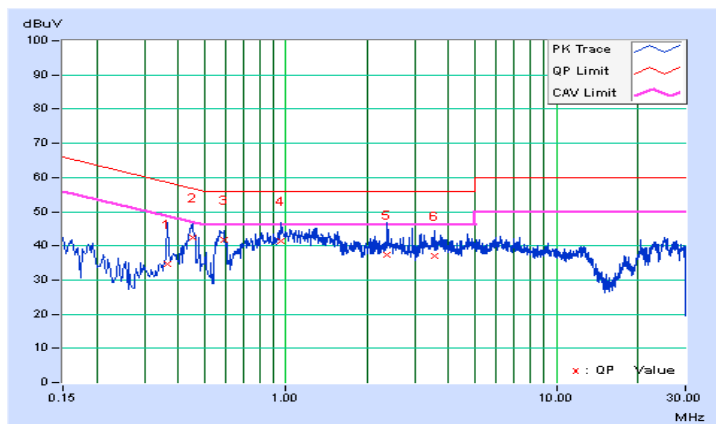

4.3 TRANSMIT POWER MEASUREMENT

4.3.1 LIMITS OF TRANSMIT POWER MEASUREMENT

OPERATION BAND	EUT CATEGORY		LIMIT
U-NII-1		Outdoor Access Point	1 Watt (30 dBm) (Max. e.i.r.p \leq 125mW(21 dBm) at any elevation angle above 30 degrees as measured from the horizon)
		Fixed point-to-point Access Point	1 Watt (30 dBm)
		Indoor Access Point	1 Watt (30 dBm)
	√	Mobile and Portable client device	250mW (24 dBm)
U-NII-2A	√	---	250mW (24 dBm) or 11 dBm+10 log B*
U-NII-2C	√	---	250mW (24 dBm) or 11 dBm+10 log B*
U-NII-3	√	---	1 Watt (30 dBm)

NOTE: Where B is the 26dB emission bandwidth in MHz.

4.3.2 TEST SETUP

FOR POWER OUTPUT MEASUREMENT

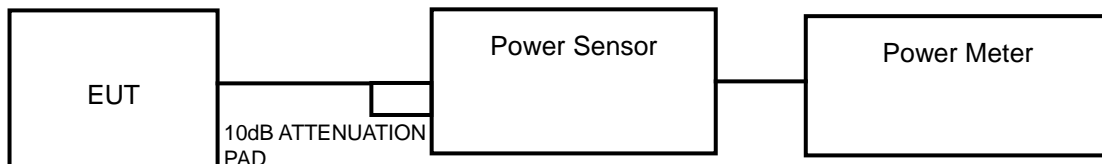

OR

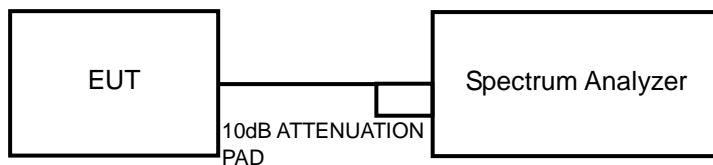

FOR 26dB BANDWIDTH

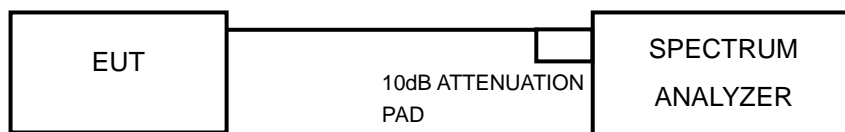

4.3.3 TEST INSTRUMENTS

Refer to section 4.1.3 to get information of above instrument.

4.3.4 TEST PROCEDURE

FOR AVERAGE POWER MEASUREMENT

<802.11a, 802.11n (20MHz), 802.11n (40MHz)>

Method PM is used to perform output power measurement, trigger and gating function of wide band power meter is enabled to measure max output power of TX on burst. Duty factor is not added to measured value.

<802.11ac (80MHz)>

Method SA-1 is used to perform output power measurement, trigger and gating function of spectrum analyzer is enabled to measure max output power of TX on burst. Duty factor is not added to measured value.

FOR 26dB BANDWIDTH

- 1) Set RBW = approximately 1% of the emission bandwidth.
- 2) Set the VBW > RBW.
- 3) Detector = Peak.
- 4) Trace mode = max hold.
- 5) Measure the maximum width of the emission that is 26 dB down from the peak of the emission.
Compare this with the RBW setting of the analyzer. Readjust RBW and repeat measurement as needed until the RBW/EBW ratio is approximately 1%.

4.3.5 DEVIATION FROM TEST STANDARD

No deviation.

4.3.6 EUT OPERATING CONDITIONS

The software provided by client to enable the EUT under transmission condition continuously at specific channel frequencies individually.



A D T

4.3.7 TEST RESULTS

POWER OUTPUT

802.11a

CHANNEL	CHANNEL FREQUENCY (MHz)	MAX. CONDUCTED POWER (mW)	MAX. CONDUCTED POWER (dBm)	POWER LIMIT (dBm)	PASS/FAIL
36	5180	38.55	15.86	24	PASS
44	5220	38.19	15.82	24	PASS
48	5240	37.50	15.74	24	PASS
52	5260	40.27	16.05	23.79	PASS
60	5300	40.55	16.08	24	PASS
64	5320	37.50	15.74	24	PASS
100	5500	31.12	14.93	24	PASS
116	5580	42.95	16.33	23.78	PASS
140	5700	29.72	14.73	24	PASS
149	5745	41.50	16.18	30	PASS
157	5785	42.76	16.31	30	PASS
165	5825	38.11	15.81	30	PASS

NOTE:

For U-NII-2A, U-NII-2C Band:

1. $11\text{dBm} + 10\log(19.03) = 23.79\text{ dBm} < 24\text{dBm}$.
2. $11\text{dBm} + 10\log(21.85) = 24.39\text{ dBm} > 24\text{dBm}$.
3. $11\text{dBm} + 10\log(21.85) = 24.39\text{ dBm} > 24\text{dBm}$.
4. $11\text{dBm} + 10\log(21.92) = 24.41\text{ dBm} > 24\text{dBm}$.
5. $11\text{dBm} + 10\log(18.95) = 23.78\text{ dBm} < 24\text{dBm}$.
6. $11\text{dBm} + 10\log(21.82) = 24.39\text{ dBm} > 24\text{dBm}$.



A D T

802.11n (20MHz)

CHANNEL	CHANNEL FREQUENCY (MHz)	MAX. CONDUCTED POWER (mW)	MAX. CONDUCTED POWER (dBm)	POWER LIMIT (dBm)	PASS/FAIL
36	5180	38.11	15.81	24	PASS
44	5220	36.64	15.64	24	PASS
48	5240	35.97	15.56	24	PASS
52	5260	40.18	16.04	23.86	PASS
60	5300	41.50	16.18	24	PASS
64	5320	37.58	15.75	24	PASS
100	5500	30.76	14.88	24	PASS
116	5580	42.17	16.25	23.88	PASS
140	5700	30.97	14.91	24	PASS
149	5745	39.26	15.94	30	PASS
157	5785	41.78	16.21	30	PASS
165	5825	41.40	16.17	30	PASS

NOTE:

For U-NII-2A, U-NII-2C Band:

1. $11\text{dBm} + 10\log(19.34) = 23.86\text{ dBm} < 24\text{dBm}$.
2. $11\text{dBm} + 10\log(22.11) = 24.45\text{ dBm} > 24\text{dBm}$.
3. $11\text{dBm} + 10\log(22.20) = 24.46\text{ dBm} > 24\text{dBm}$.
4. $11\text{dBm} + 10\log(22.16) = 24.46\text{ dBm} > 24\text{dBm}$.
5. $11\text{dBm} + 10\log(19.42) = 23.88\text{ dBm} < 24\text{dBm}$.
6. $11\text{dBm} + 10\log(22.19) = 24.46\text{ dBm} > 24\text{dBm}$.



A D T

802.11n (40MHz)

CHANNEL	CHANNEL FREQUENCY (MHz)	MAX. CONDUCTED POWER (mW)	MAX. CONDUCTED POWER (dBm)	POWER LIMIT (dBm)	PASS/FAIL
38	5190	18.92	12.77	24	PASS
46	5230	18.49	12.67	24	PASS
54	5270	19.41	12.88	24	PASS
62	5310	20.94	13.21	24	PASS
102	5510	20.04	13.02	24	PASS
110	5550	20.18	13.05	24	PASS
134	5670	20.14	13.04	24	PASS
151	5755	20.23	13.06	30	PASS
159	5795	20.84	13.19	30	PASS

NOTE:

For U-NII-2A, U-NII-2C Band:

1. $11\text{dBm} + 10\log(41.51) = 27.18\text{ dBm} > 24\text{dBm}$.
2. $11\text{dBm} + 10\log(41.60) = 27.19\text{ dBm} > 24\text{dBm}$.
3. $11\text{dBm} + 10\log(41.64) = 27.20\text{ dBm} > 24\text{dBm}$.
4. $11\text{dBm} + 10\log(41.83) = 27.21\text{ dBm} > 24\text{dBm}$.
5. $11\text{dBm} + 10\log(41.71) = 27.20\text{ dBm} > 24\text{dBm}$.

802.11ac (80MHz)

CHANNEL	CHANNEL FREQUENCY (MHz)	MAX. CONDUCTED POWER (mW)	MAX. CONDUCTED POWER (dBm)	POWER LIMIT (dBm)	PASS/FAIL
42	5210	13.58	11.33	24	PASS
58	5290	12.05	10.81	24	PASS
106	5530	13.21	11.21	24	PASS
155	5775	13.49	11.3	30	PASS

NOTE:

For U-NII-2A, U-NII-2C Band:

1. $11\text{dBm} + 10\log(83.08) = 30.19\text{ dBm} > 24\text{dBm}$.
2. $11\text{dBm} + 10\log(82.94) = 30.19\text{ dBm} > 24\text{dBm}$.



A D T

26dB BANDWIDTH

802.11a

CHANNEL	CHANNEL FREQUENCY (MHz)	26dBc BANDWIDTH (MHz)	PASS / FAIL
52	5260	19.03	PASS
60	5300	21.85	PASS
64	5320	21.85	PASS
100	5500	21.92	PASS
116	5580	18.95	PASS
140	5700	21.82	PASS

802.11n (20MHz)

CHANNEL	CHANNEL FREQUENCY (MHz)	26dBc BANDWIDTH (MHz)	PASS / FAIL
52	5260	19.34	PASS
60	5300	22.11	PASS
64	5320	22.20	PASS
100	5500	22.16	PASS
116	5580	19.42	PASS
140	5700	22.19	PASS

802.11n (40MHz)

CHANNEL	CHANNEL FREQUENCY (MHz)	26dBc BANDWIDTH (MHz)	PASS / FAIL
54	5270	41.51	PASS
62	5310	41.60	PASS
102	5510	41.64	PASS
110	5550	41.83	PASS
134	5670	41.71	PASS

802.11ac (80MHz)

CHANNEL	CHANNEL FREQUENCY (MHz)	26dBc BANDWIDTH (MHz)	PASS / FAIL
58	5290	83.08	PASS
106	5530	82.94	PASS



A D T

SPECTRUM PLOT OF WORST VALUE

802.11a

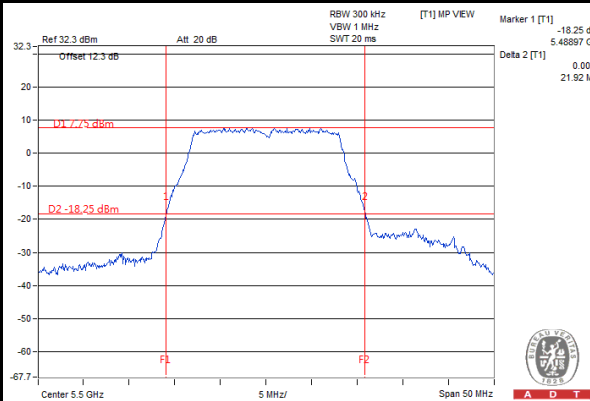

802.11n (20MHz)

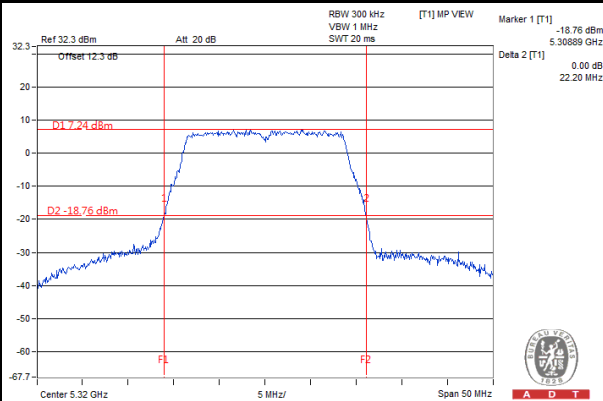

802.11n (40MHz)

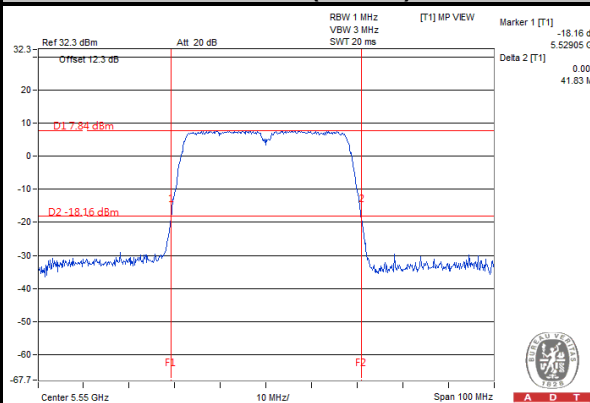

802.11ac (80MHz)

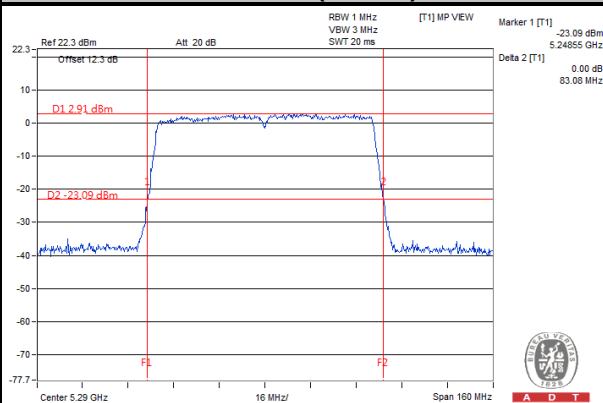

4.4 PEAK POWER SPECTRAL DENSITY MEASUREMENT

4.4.1 LIMITS OF PEAK POWER SPECTRAL DENSITY MEASUREMENT

Operation Band	EUT Category		LIMIT
U-NII-1		Outdoor Access Point	17dBm/ MHz
		Fixed point-to-point Access Point	
		Indoor Access Point	
	√	Mobile and Portable client device	11dBm/ MHz
U-NII-2A	√	---	11dBm/ MHz
U-NII-2C	√	---	11dBm/ MHz
U-NII-3	√	---	30dBm/ 500kHz

4.4.2 TEST SETUP

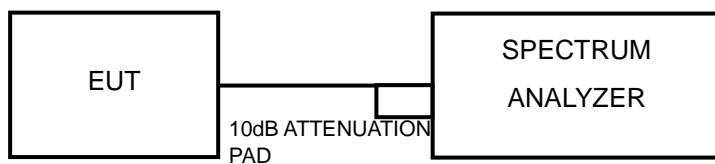

4.4.3 TEST INSTRUMENTS

Refer to section 4.1.3 to get information of above instrument.



A D T

4.4.4 TEST PROCEDURES

For U-NII-1, U-NII-2A, U-NII-2C band:

Using method SA-2 alternative

- 1) Set span to encompass the entire emission bandwidth (EBW) of the signal.
- 2) Set RBW = 30 kHz, Set VBW \geq 1 MHz, Detector = RMS
- 3) Set Channel power measure = 1MHz
- 4) Sweep time = 4 second.
- 5) Perform a single sweep.
- 6) Record the max value and add 10 log (1/duty cycle)

For U-NII-3 band:

- 1) Set span to encompass the entire emission bandwidth (EBW) of the signal.
- 2) Set RBW = 500 kHz, Set VBW \geq 3 RBW, Detector = RMS
- 3) Sweep time = auto, trigger set to "free run".
- 4) Trace average at least 100 traces in power averaging mode.
- 5) Record the max value and add 10 log (1/duty cycle)

4.4.5 DEVIATION FROM TEST STANDARD

No deviation.

4.4.6 EUT OPERATING CONDITIONS

Same as Item 4.3.6.



4.4.7 TEST RESULTS

For U-NII-1, U-NII-2A, U-NII-2C Band

802.11a

CHANNEL	FREQUENCY (MHz)	PSD W/O DUTY FACTOR (dBm)	DUTY FACTOR	PSD WITH DUTY FACTOR (dBm)	MAXIMUM LIMIT (dBm)	PASS/FAIL
36	5180	3.33	0.21	3.54	11	PASS
44	5220	3.22	0.21	3.43	11	PASS
48	5240	3.36	0.21	3.57	11	PASS
52	5260	3.90	0.21	4.11	11	PASS
60	5300	4.02	0.21	4.23	11	PASS
64	5320	3.87	0.21	4.08	11	PASS
100	5500	3.73	0.21	3.94	11	PASS
116	5580	4.71	0.21	4.92	11	PASS
140	5700	2.33	0.21	2.54	11	PASS

NOTE: Refer to section 3.3 for duty cycle spectrum plot.

802.11n (20MHz)

CHANNEL	FREQUENCY (MHz)	PSD W/O DUTY FACTOR (dBm)	DUTY FACTOR	PSD WITH DUTY FACTOR (dBm)	MAXIMUM LIMIT (dBm)	PASS/FAIL
36	5180	2.88	0.25	3.13	11	PASS
44	5220	2.79	0.25	3.04	11	PASS
48	5240	3.12	0.25	3.37	11	PASS
52	5260	3.52	0.25	3.77	11	PASS
60	5300	3.99	0.25	4.24	11	PASS
64	5320	3.60	0.25	3.85	11	PASS
100	5500	3.28	0.25	3.53	11	PASS
116	5580	4.28	0.25	4.53	11	PASS
140	5700	2.12	0.25	2.37	11	PASS

NOTE: Refer to section 3.3 for duty cycle spectrum plot.



A D T

802.11n (40MHz)

CHANNEL	FREQUENCY (MHz)	PSD W/O DUTY FACTOR (dBm)	DUTY FACTOR	PSD WITH DUTY FACTOR (dBm)	MAXIMUM LIMIT (dBm)	PASS/FAIL
38	5190	-3.30	0.61	-2.69	11	PASS
46	5230	-3.13	0.61	-2.52	11	PASS
54	5270	-2.41	0.61	-1.80	11	PASS
62	5310	-2.08	0.61	-1.47	11	PASS
102	5510	-1.67	0.61	-1.06	11	PASS
110	5550	-1.74	0.61	-1.13	11	PASS
134	5670	-2.57	0.61	-1.96	11	PASS

NOTE: Refer to section 3.3 for duty cycle spectrum plot.

802.11ac (80MHz)

CHANNEL	FREQUENCY (MHz)	PSD W/O DUTY FACTOR (dBm)	DUTY FACTOR	PSD WITH DUTY FACTOR (dBm)	MAXIMUM LIMIT (dBm)	PASS/FAIL
42	5210	-9.22	1.06	-8.16	11	PASS
58	5290	-9.03	1.06	-7.97	11	PASS
106	5530	-8.77	1.06	-7.71	11	PASS

NOTE: Refer to section 3.3 for duty cycle spectrum plot.



A D T

SPECTRUM PLOT OF WORST VALUE

802.11a

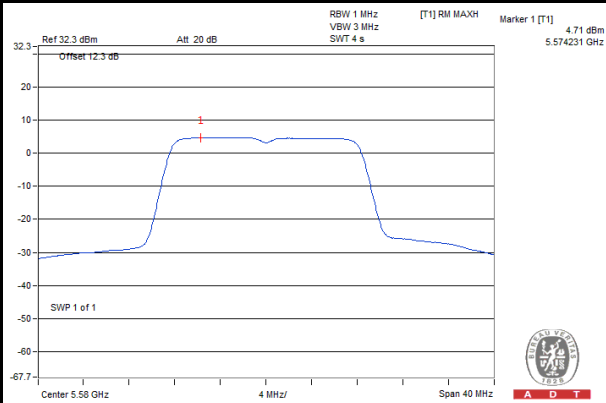

802.11n (20MHz)

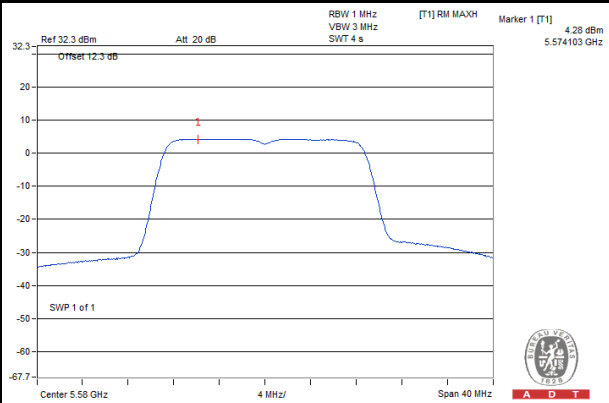

802.11n (40MHz)

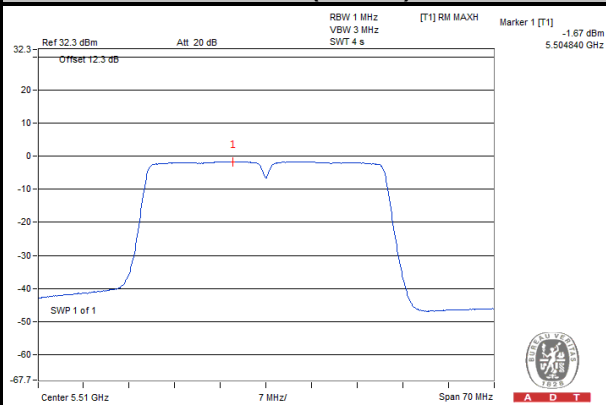

802.11ac (80MHz)

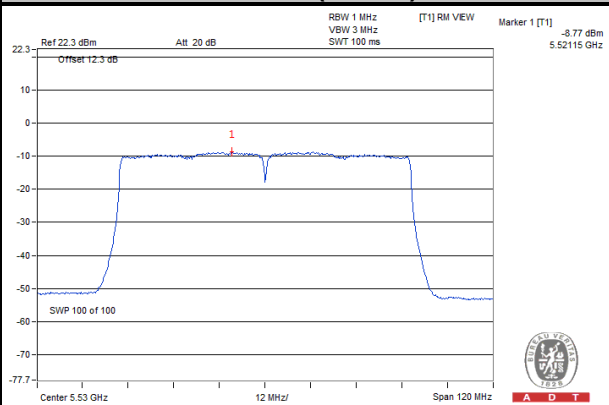



A D T

For U-NII-3 Band

802.11a

CHANNEL	FREQUENCY (MHz)	PSD W/O DUTY FACTOR (dBm)	DUTY FACTOR	PSD WITH DUTY FACTOR (dBm)	LIMIT (dBm/500kHz)	PASS/FAIL
149	5745	0.34	0.21	0.55	30	PASS
157	5785	0.42	0.21	0.63	30	PASS
165	5825	1.21	0.21	1.42	30	PASS

802.11n (20MHz)

CHANNEL	FREQUENCY (MHz)	PSD W/O DUTY FACTOR (dBm)	DUTY FACTOR	PSD WITH DUTY FACTOR (dBm)	LIMIT (dBm/500kHz)	PASS/FAIL
149	5745	0.06	0.25	0.31	30	PASS
157	5785	0.00	0.25	0.25	30	PASS
165	5825	0.78	0.25	1.03	30	PASS

802.11n (40MHz)

CHANNEL	FREQUENCY (MHz)	PSD W/O DUTY FACTOR (dBm)	DUTY FACTOR	PSD WITH DUTY FACTOR (dBm)	LIMIT (dBm/500kHz)	PASS/FAIL
151	5755	-6.05	0.61	-5.44	30	PASS
159	5795	-6.74	0.61	-6.13	30	PASS

802.11ac (80MHz)

CHANNEL	FREQUENCY (MHz)	PSD W/O DUTY FACTOR (dBm)	DUTY FACTOR	PSD WITH DUTY FACTOR (dBm)	LIMIT (dBm/500kHz)	PASS/FAIL
155	5775	-8.94	1.06	-7.88	30	PASS



A D T

SPECTRUM PLOT OF WORST VALUE

802.11a

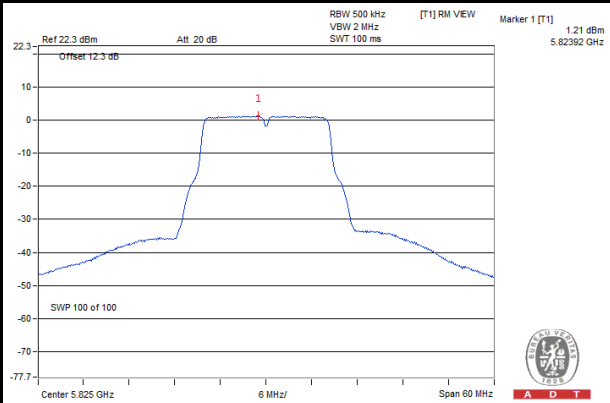

802.11n (20MHz)

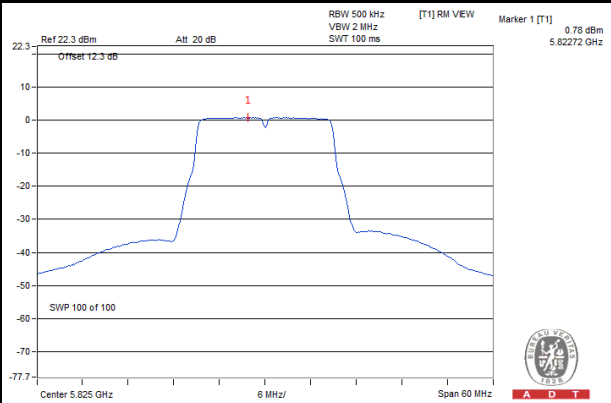

802.11n (40MHz)

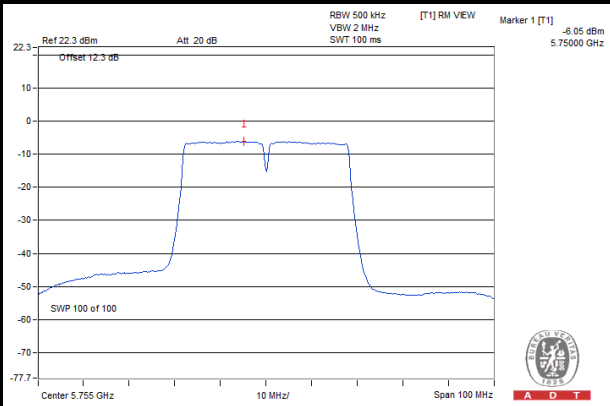

802.11ac (80MHz)

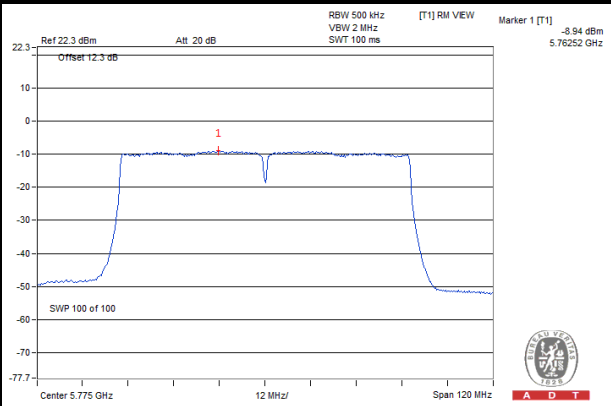

4.5 FREQUENCY STABILITY

4.5.1 LIMITS OF FREQUENCY STABILITY MEASUREMENT

The frequency of the carrier signal shall be maintained within band of operation.

4.5.2 TEST SETUP

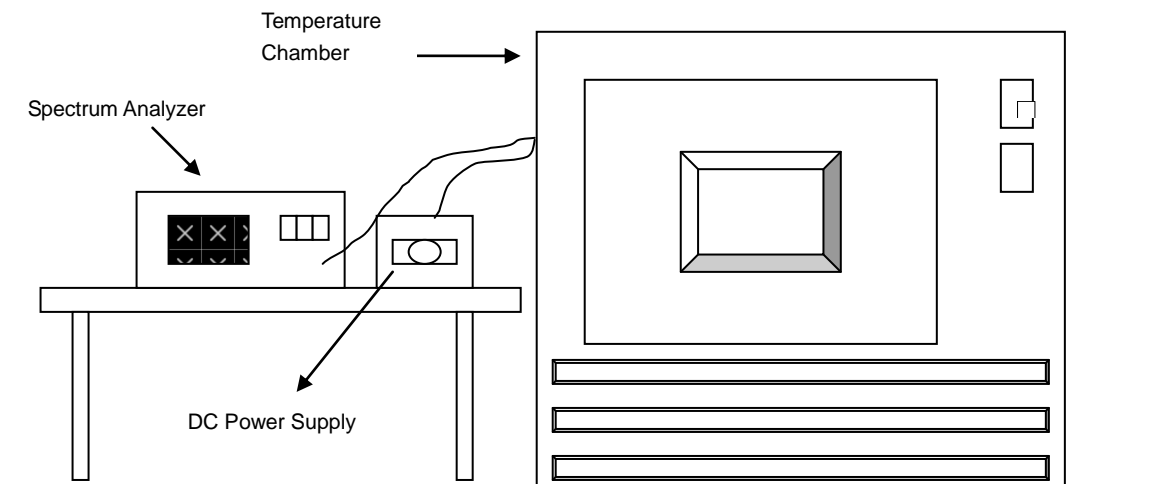

4.5.3 TEST INSTRUMENTS

Refer to section 4.1.3 to get information of above instrument.

4.5.4 TEST PROCEDURE

- a. To ensure emission at the band edge is maintained within the authorized band, those values shall be measured by radiation emissions at upper and lower frequency points, and finally compensated by frequency deviation as procedures below.
- b. The EUT was operated at the maximum output power, and connected to the spectrum analyzer, which is set to maximum hold function and peak detector. The peak value of the power envelope was measured and noted. The upper and lower frequency points were respectively measured relatively 10dB lower than the measured peak value.
- c. The frequency deviation was calculated by adding the upper frequency point and the lower frequency point divided by two. Those detailed values of frequency deviation are provided in table below.

4.5.5 DEVIATION FROM TEST STANDARD

No deviation.

4.5.6 EUT OPERATING CONDITION

Set the EUT transmit at un-modulation mode to test frequency stability.



A D T

4.5.7 TEST RESULTS

FREQUENCY STABILITY VERSUS TEMP.									
OPERATING FREQUENCY: 5320MHz									
TEMP. (°C)	POWER SUPPLY (Vdc)	0 MINUTE		2 MINUTE		5 MINUTE		10 MINUTE	
		Measured Frequency (MHz)	Frequency Drift (ppm)	Measured Frequency (MHz)	Frequency Drift (ppm)	Measured Frequency (MHz)	Frequency Drift (ppm)	Measured Frequency (MHz)	Frequency Drift (ppm)
60	3.82	5320.036228	6.810	5320.035807	6.731	5320.036057	6.778	5320.036193	6.803
50	3.82	5320.037036	6.962	5320.036927	6.941	5320.036747	6.907	5320.037358	7.022
40	3.82	5320.036914	6.939	5320.036456	6.853	5320.036969	6.949	5320.036974	6.950
30	3.82	5320.037952	7.134	5320.037981	7.139	5320.038219	7.184	5320.037694	7.085
20	3.82	5320.039099	7.349	5320.038940	7.320	5320.039257	7.379	5320.039417	7.409
10	3.82	5320.040296	7.574	5320.040497	7.612	5320.040298	7.575	5320.040724	7.655
0	3.82	5320.038706	7.276	5320.038905	7.313	5320.039142	7.358	5320.039574	7.439
-10	3.82	5320.037779	7.101	5320.037695	7.086	5320.037877	7.120	5320.037816	7.108
-20	3.82	5320.037220	6.996	5320.037225	6.997	5320.036636	6.886	5320.037019	6.958
-30	3.82	5320.036255	6.815	5320.035794	6.728	5320.036227	6.810	5320.035956	6.759

FREQUENCY STABILITY VERSUS VOLTAGE									
OPERATING FREQUENCY: 5320MHz									
TEMP. (°C)	POWER SUPPLY (Vdc)	0 MINUTE		2 MINUTE		5 MINUTE		10 MINUTE	
		Measured Frequency (MHz)	Frequency Drift (ppm)	Measured Frequency (MHz)	Frequency Drift (ppm)	Measured Frequency (MHz)	Frequency Drift (ppm)	Measured Frequency (MHz)	Frequency Drift (ppm)
20	3.6	5320.038525	7.242	5320.038745	7.283	5320.038942	7.320	5320.038659	7.267
	3.82	5320.039099	7.349	5320.038940	7.320	5320.039257	7.379	5320.039417	7.409
	4.40	5320.040648	7.641	5320.040081	7.534	5320.040728	7.656	5320.040386	7.591

4.6 6dB BANDWIDTH MEASUREMENT

4.6.1 LIMITS OF 6dB BANDWIDTH MEASUREMENT

The minimum of 6dB Bandwidth Measurement is 0.5MHz.

4.6.2 TEST SETUP

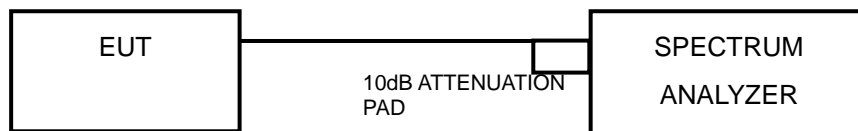

4.6.3 TEST INSTRUMENTS

Refer to section 4.1.3 to get information of above instrument.

4.6.4 TEST PROCEDURE

- Set resolution bandwidth (RBW) = 100kHz
- Set the video bandwidth (VBW) $\geq 3 \times$ RBW, Detector = Peak.
- Trace mode = max hold.
- Sweep = auto couple.
- Measure the maximum width of the emission that is constrained by the frequencies associated with the two amplitude points (upper and lower) that are attenuated by 6 dB relative to the maximum level measured in the fundamental emission.

4.6.5 DEVIATION FROM TEST STANDARD

No deviation.

4.6.6 EUT OPERATING CONDITIONS

The software provided by client to enable the EUT under transmission condition continuously at lowest, middle and highest channel frequencies individually.



A D T

4.6.7 TEST RESULTS

802.11a

CHANNEL	FREQUENCY (MHz)	6dB BANDWIDTH (MHz)	MINIMUM LIMIT (MHz)	PASS / FAIL
149	5745	16.39	0.5	PASS
157	5785	16.41	0.5	PASS
165	5825	16.39	0.5	PASS

802.11n (20MHz)

CHANNEL	FREQUENCY (MHz)	6dB BANDWIDTH (MHz)	MINIMUM LIMIT (MHz)	PASS / FAIL
149	5745	17.63	0.5	PASS
157	5785	17.63	0.5	PASS
165	5825	17.63	0.5	PASS

802.11n (40MHz)

CHANNEL	FREQUENCY (MHz)	6dB BANDWIDTH (MHz)	MINIMUM LIMIT (MHz)	PASS / FAIL
151	5755	36.40	0.5	PASS
159	5795	36.54	0.5	PASS

802.11ac (80MHz)

CHANNEL	FREQUENCY (MHz)	6dB BANDWIDTH (MHz)	MINIMUM LIMIT (MHz)	PASS / FAIL
155	5775	76.34	0.5	PASS



A D T

SPECTRUM PLOT OF WORST VALUE

802.11a

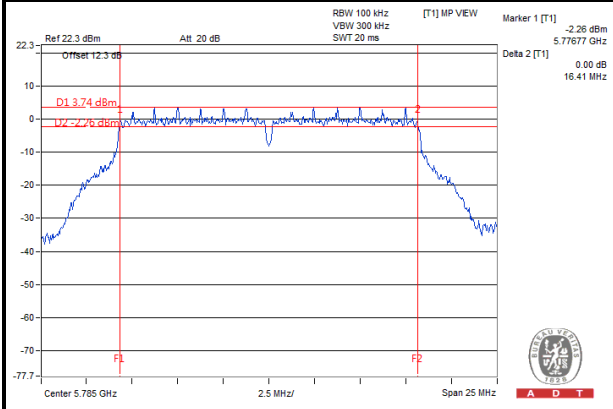

802.11n (20MHz)

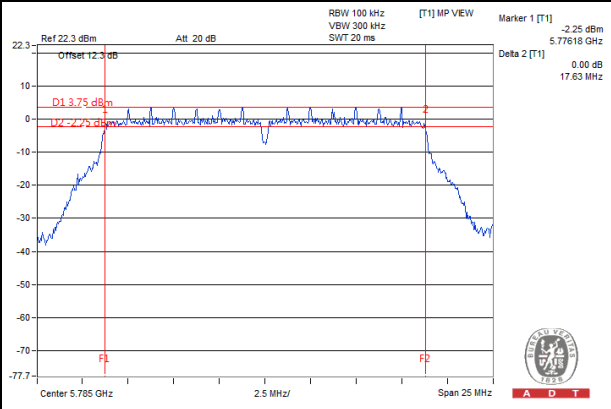

802.11n (40MHz)

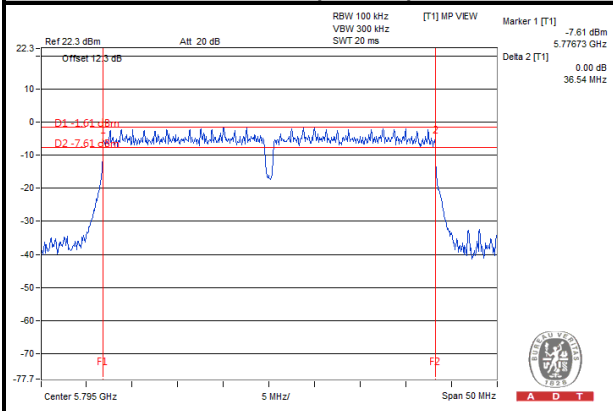

802.11ac (80MHz)

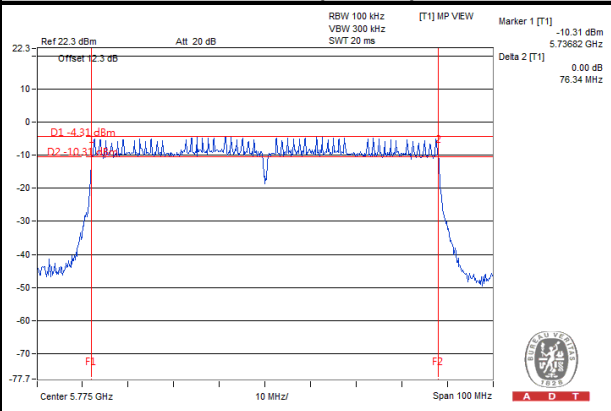



A D T

5. PHOTOGRAPHS OF THE TEST CONFIGURATION

Please refer to the attached file (Test Setup Photo).



6. INFORMATION ON THE TESTING LABORATORIES

We, Bureau Veritas Consumer Products Services (H.K.) Ltd., Taoyuan Branch, were founded in 1988 to provide our best service in EMC, Radio, Telecom and Safety consultation. Our laboratories are accredited and approved according to ISO/IEC 17025.

If you have any comments, please feel free to contact us at the following:

Linko EMC/RF Lab:

Tel: 886-2-26052180

Fax: 886-2-26051924

Hsin Chu EMC/RF/Telecom Lab:

Tel: 886-3-5935343

Fax: 886-3-5935342

Hwa Ya EMC/RF/Safety Lab:

Tel: 886-3-3183232

Fax: 886-3-3270892

Email: service.adt@tw.bureauveritas.com

Web Site: www.bureauveritas-adt.com

The address and road map of all our labs can be found in our web site also.



A D T

7. APPENDIX A - MODIFICATIONS RECORDERS FOR ENGINEERING CHANGES TO THE EUT BY THE LAB

No any modifications are made to the EUT by the lab during the test.

---END---