



FCC RF Test Report

APPLICANT : HTC Corporation
EQUIPMENT : Smartphone
MODEL NAME : 0PFH100
FCC ID : NM80PFH100
STANDARD : FCC Part 15 Subpart E §15.407
CLASSIFICATION : (NII) Unlicensed National Information Infrastructure

The product was received on Jul. 29, 2014 and testing was completed on Sep. 02, 2014. We, SPORTON INTERNATIONAL INC., would like to declare that the tested sample has been evaluated in accordance with the test procedures and has been in compliance with the applicable technical standards.

The test results in this report apply exclusively to the tested model / sample. Without written approval of SPORTON INTERNATIONAL INC., the test report shall not be reproduced except in full.

Reviewed by: Joseph Lin / Supervisor

Approved by: Jones Tsai / Manager



SPORTON INTERNATIONAL INC.

No. 52, Hwa Ya 1st Rd., Hwa Ya Technology Park, Kwei-Shan Hsiang, Tao Yuan Hsien, Taiwan, R.O.C.

SPORTON INTERNATIONAL INC.

TEL : 886-3-327-3456

FAX : 886-3-328-4978

FCC ID : NM80PFH100

Page Number : 1 of 42

Report Issued Date : Oct. 07, 2014

Report Version : Rev. 01

Report Template No.: BU5-FR15EWL Version 1.0



TABLE OF CONTENTS

REVISION HISTORY.....3

SUMMARY OF TEST RESULT4

1 GENERAL DESCRIPTION.....5

 1.1 Applicant.....5

 1.2 Manufacturer.....5

 1.3 Feature of Equipment Under Test.....5

 1.4 Product Specification of Equipment Under Test.....6

 1.5 Modification of EUT.....6

 1.6 Testing Location.....7

 1.7 Applicable Standards.....7

2 TEST CONFIGURATION OF EQUIPMENT UNDER TEST.....8

 2.1 Carrier Frequency Channel.....9

 2.2 Pre-Scanned RF Power.....10

 2.3 Test Mode.....11

 2.4 Connection Diagram of Test System.....13

 2.5 Support Unit used in test configuration and system.....14

 2.6 EUT Operation Test Setup.....14

 2.7 Measurement Results Explanation Example.....14

3 TEST RESULT.....15

 3.1 26dB & 99% Occupied Bandwidth Measurement.....15

 3.2 Maximum Conducted Output Power Measurement.....21

 3.3 Power Spectral Density Measurement.....24

 3.4 Unwanted Radiated Emission Measurement.....28

 3.5 AC Conducted Emission Measurement.....33

 3.6 Frequency Stability Measurement.....37

 3.7 Automatically Discontinue Transmission.....39

 3.8 Antenna Requirements.....40

4 LIST OF MEASURING EQUIPMENT.....41

5 UNCERTAINTY OF EVALUATION.....42

APPENDIX A. RADIATED SPURIOUS EMISSION



REVISION HISTORY

REPORT NO.	VERSION	DESCRIPTION	ISSUED DATE
FR472933E	Rev. 01	Initial issue of report	Oct. 07, 2014



SUMMARY OF TEST RESULT

Report Section	FCC Rule	IC Rule	Description	Limit	Result	Remark
3.1	2.1049 15.403(i)	RSS-210 A9.2	26dB & 99% Bandwidth	-	Pass	-
3.2	15.407(a)	RSS-210 A9.2	Maximum Conducted Output Power	≤ 24dBm (depend on band)	Pass	-
3.3	15.407(a)	RSS-210 A9.2	Power Spectral Density	≤ 11 dBm (depend on band)	Pass	-
3.4	15.407(b)	RSS-210 A9.3	Unwanted Emissions	≤ -17, -27 dBm (depend on band)&15.209(a)	Pass	Under limit 3.26 dB at 5729.32 MHz
3.5	15.207	RSS-Gen 7.2.4	AC Conducted Emission	15.207(a)	Pass	Under limit 8.30 dB at 0.158 MHz
3.6	15.407(g)	-	Frequency Stability	Within Operation Band	Pass	-
3.7	15.407(c)	RSS-210 A9.4	Automatically Discontinue Transmission	Discontinue Transmission	Pass	-
3.8	15.203 & 15.407(a)	RSS-210 A9.2	Antenna Requirement	N/A	Pass	-



1 General Description

1.1 Applicant

HTC Corporation

No.23, Xinghua Rd., Taoyuan City, Taoyuan County 330, Taiwan.

1.2 Manufacturer

HTC Corporation

No.23, Xinghua Rd., Taoyuan City, Taoyuan County 330, Taiwan.

1.3 Feature of Equipment Under Test

Product Feature & Specification	
Equipment	Smartphone
Model Name	OPFH100
Sample 1	EUT with Main Camera 1, Speaker(top) 1, Speaker(bottom) 1, Microphone 1, RAM 1, and RF PA 1
Sample 2	EUT with Main Camera 1, Speaker(top) 2, Speaker(bottom) 2, Microphone 2, RAM 2, and RF PA 1
Sample 3	EUT with Main Camera 2, Speaker(top) 2, Speaker(bottom) 2, Microphone 2, RAM 2, and RF PA 2
FCC ID	NM80PFH100
EUT supports Radios application	GSM/EGPRS/WCDMA/HSPA/LTE/NFC 802.11b/g/n (HT20) 802.11a/n (HT20/HT40) Bluetooth v4.0 EDR/LE
EUT Stage	Identical Prototype

Remark: The above EUT's information was declared by manufacturer. Please refer to the specifications or user's manual for more detailed description.



1.4 Product Specification of Equipment Under Test

Product Specification subjective to this standard	
Tx/Rx Frequency Range	5180 MHz ~ 5240 MHz 5260 MHz ~ 5320 MHz 5500 MHz ~ 5580 MHz 5660 MHz ~ 5700 MHz
Maximum Output Power to Antenna	<5180 MHz ~ 5240 MHz> 802.11a : 13.18 dBm / 0.0208 W 802.11n HT20 : 13.34 dBm / 0.0216 W 802.11n HT40 : 13.16 dBm / 0.0207 W <5260 MHz ~ 5320 MHz> 802.11a : 12.83 dBm / 0.0192 W 802.11n HT20 : 12.98 dBm / 0.0199 W 802.11n HT40 : 12.85 dBm / 0.0193 W <5500 MHz ~ 5580 MHz and 5660 MHz ~ 5700 MHz > 802.11a : 13.08 dBm / 0.0203 W 802.11n HT20 : 13.06 dBm / 0.0202 W 802.11n HT40 : 13.33 dBm / 0.0215 W
99% Occupied Bandwidth	802.11a : 18.20 MHz 802.11n HT20 : 19.10 MHz 802.11n HT40 : 36.60 MHz
Antenna Type	PIFA Antenna with gain -2.00 dBi
Type of Modulation	OFDM (BPSK / QPSK / 16QAM / 64QAM)

1.5 Modification of EUT

No modifications are made to the EUT during all test items.



1.6 Testing Location

Sporton Lab is accredited to ISO 17025 by Taiwan Accreditation Foundation (TAF code : 1190) and the FCC designation No. TW1022 under the FCC 2.948(e) by Mutual Recognition Agreement (MRA) in FCC Test.

Test Site	SPORTON INTERNATIONAL INC.		
Test Site Location	No. 52, Hwa Ya 1 st Rd., Hwa Ya Technology Park, Kwei-Shan Hsiang, Tao Yuan Hsien, Taiwan, R.O.C. TEL: +886-3-327-3456 FAX: +886-3-328-4978		
Test Site No.	Sporton Site No.		
	TH02-HY	CO05-HY	03CH05-HY

1.7 Applicable Standards

According to the specifications of the manufacturer, the EUT must comply with the requirements of the following standards:

- ♦ FCC Part 15 Subpart E
- ♦ FCC KDB 789033 D02 General UNII Test Procedures New Rules v01
- ♦ ANSI C63.4-2003

Remark:

1. All test items were verified and recorded according to the standards and without any deviation during the test.
2. This EUT has also been tested and complied with the requirements of FCC Part 15, Subpart B, recorded in a separate test report.



2 Test Configuration of Equipment Under Test

The EUT has been associated with peripherals and configuration operated in a manner tended to maximize its emission characteristics in a typical application. Frequency range investigated: conducted emission (150 kHz to 30 MHz) and radiated emission (9 kHz to the 10th harmonic of the highest fundamental frequency or to 40 GHz, whichever is lower). For radiated measurement, pre-scanned in three orthogonal panels, X, Y, Z. The worst cases (X plane) were recorded in this report.

The final configuration from all the combinations and the worst-case data rates were investigated by measuring the maximum power across all the data rates and modulation modes under section 2.2.

Based on the worst configuration found above, the RF power setting is set individually to meet FCC compliance limit for the final conducted and radiated tests shown in section 2.3.



2.1 Carrier Frequency Channel

Frequency Band	Channel	Freq. (MHz)	Channel	Freq. (MHz)
5150-5250 MHz Band 1 (U-NII-1)	36	5180	44	5220
	38	5190	46	5230
	40	5200	48	5240

Frequency Band	Channel	Freq. (MHz)	Channel	Freq. (MHz)
5250-5350 MHz Band 2 (U-NII-2A)	52	5260	60	5300
	54	5270	62	5310
	56	5280	64	5320

Frequency Band	Channel	Freq. (MHz)	Channel	Freq. (MHz)
5470-5600 MHz and 5650-5725 MHz Band 3 (U-NII-2C)	100	5500	116	5580
	102	5510	132	5660
	104	5520	134	5670
	108	5540	136	5680
	110	5550	140	5700
	112	5560		

Note: The above Frequency and Channel in boldface were 802.11n HT40.



2.2 Pre-Scanned RF Power

Preliminary tests were performed in different data rate and data rate associated with the highest power were chosen for full test in the following tables. Final Output Power equals to Measured Output Power adds the duty factor.

Channel	Frequency	5GHz 802.11a Average Power (dBm)							
		Data Rate							
		6 Mbps	9 Mbps	12 Mbps	18 Mbps	24 Mbps	36 Mbps	48 Mbps	54 Mbps
CH 36	5180 MHz	13.18	13.17	13.13	13.05	13.12	13.11	13.10	13.10
CH 52	5260 MHz	12.83	12.79	12.69	12.76	12.74	12.66	12.66	12.81
CH 100	5500 MHz	13.08	13.07	13.02	12.93	12.94	13.06	12.85	12.90

Channel	Frequency	5GHz 802.11n HT20 Average Power (dBm)							
		Data Rate							
		MCS0	MCS1	MCS2	MCS3	MCS4	MCS5	MCS6	MCS7
CH 36	5180 MHz	13.34	13.31	13.30	13.22	13.22	13.31	13.13	13.26
CH 52	5260 MHz	12.98	12.83	12.73	12.65	12.82	12.82	12.71	12.74
CH 100	5500 MHz	13.06	13.05	12.99	12.95	13.00	12.96	12.93	13.03

Channel	Frequency	5GHz 802.11n HT40 Average Power (dBm)							
		Data Rate							
		MCS0	MCS1	MCS2	MCS3	MCS4	MCS5	MCS6	MCS7
CH 38	5190MHz	13.16	13.11	13.14	13.12	13.15	13.15	13.11	13.10
CH 54	5270MHz	12.85	12.80	12.73	12.58	12.77	12.57	12.61	12.83
CH 102	5510MHz	13.33	13.06	13.30	13.06	13.26	13.28	13.28	13.29



2.3 Test Mode

Final results of test modes, data rates and test channels are shown as following table.

Test Cases				
	Test Items	Mode	Data rate	Test Channel
Conducted TCs	26dB and 99% BW Power Spectral Density	802.11a	6 Mbps	L/M/H
		802.11n HT20	MCS0	L/M/H
		802.11n HT40	MCS0	L/M/H
	Output Power	802.11a	6 Mbps	L/M/H
		802.11n HT20	MCS0	L/M/H
		802.11n HT40	MCS0	L/M/H
	Frequency Stability	802.11a	6 Mbps	L/M/H
Radiated TCs	Radiated Band Edge	802.11a	6 Mbps	L/M/H
		802.11n HT20	MCS0	L/M/H
		802.11n HT40	MCS0	L/M/H
	Radiated Spurious Emission	802.11a	6 Mbps	L/M/H
		802.11n HT20	MCS0	L/M/H
		802.11n HT40	MCS0	L/M/H
AC Conducted Emission	Mode 1 : WCDMA Band II Idle + Bluetooth Link + WLAN (5GHz) Link + GPS Rx + Earphone 1 + USB Cable 2(Data Link with Notebook)			
Remark: All test items were performed with Sample 1				



Ch. #		Band I : 5150-5250 MHz	Band II : 5250-5350 MHz	Band III : 5470-5600 MHz and 5650-5725MHz
		802.11a	802.11a	802.11a
L	Low	36	52	100
M	Middle	44	60	116
H	High	48	64	140

Ch. #		Band I : 5150-5250 MHz	Band II : 5250-5350 MHz	Band III : 5470-5600 MHz and 5650-5725MHz
		802.11n HT20	802.11n HT20	802.11n HT20
L	Low	36	52	100
M	Middle	44	60	116
H	High	48	64	140

Ch. #		Band I : 5150-5250 MHz	Band II : 5250-5350 MHz	Band III : 5470-5600 MHz and 5650-5725MHz
		802.11n HT40	802.11n HT40	802.11n HT40
L	Low	38	54	102
M	Middle	-	-	110
H	High	46	62	134

2.4 Connection Diagram of Test System

<WLAN Tx Mode>



<AC Conducted Emission Mode>

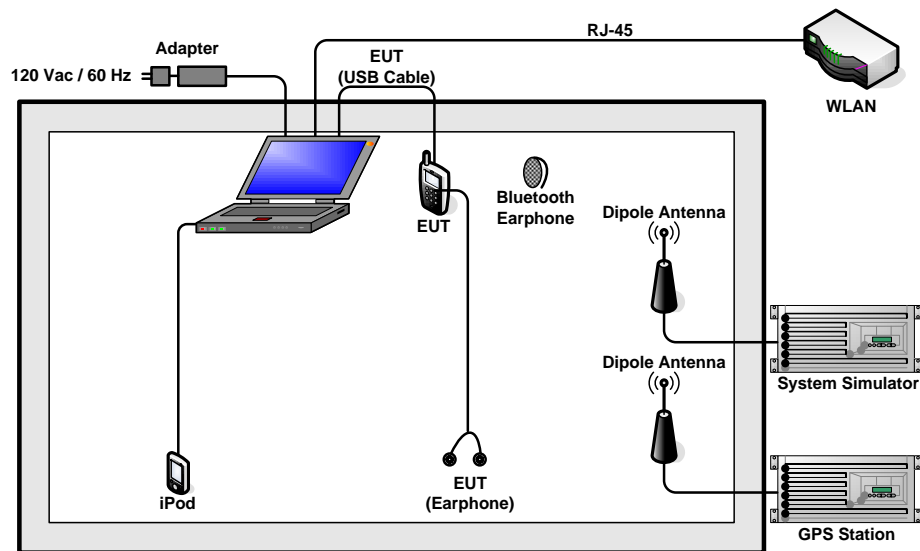



2.5 Support Unit used in test configuration and system

Item	Equipment	Trade Name	Model Name	FCC ID	Data Cable	Power Cord
1.	System Simulator	R&S	CMU 200	N/A	N/A	Unshielded, 1.8 m
2.	GPS Station	Pendulum	GSG-54	N/A	N/A	Unshielded, 1.8 m
3.	WLAN AP	D-Link	DIR-628	KA2DIR628A2	N/A	Unshielded, 1.8 m
4.	Bluetooth Earphone	Sony Ericsson	MW600	PY7DDA-2029	N/A	N/A
5.	Notebook	DELL	Latitude E6320	FCC DoC/ Contains FCC ID: QDS-BRCM1054	N/A	AC I/P: Unshielded, 1.2 m DC O/P: Shielded, 1.8 m
6.	iPod	Apple	A1285	FCC DoC	Shielded, 1.0 m	N/A
7.	SD Card	SanDisk	Micro SD HC	FCC DoC	N/A	N/A

2.6 EUT Operation Test Setup

For WLAN function, programmed RF utility, "TestTool" installed in the notebook make the EUT provide functions like channel selection and power level for continuous transmitting and receiving signals.

2.7 Measurement Results Explanation Example

For all conducted test items:

The offset level is set in the spectrum analyzer to compensate the RF cable loss and attenuator factor between EUT conducted output port and spectrum analyzer. With the offset compensation, the spectrum analyzer reading level is exactly the EUT RF output level.

Example :

The spectrum analyzer offset is derived from RF cable loss and attenuator factor.

$$\text{Offset} = \text{RF cable loss} + \text{attenuator factor}.$$

Following shows an offset computation example with cable loss 4.2 dB and 10dB attenuator.

$$\begin{aligned} \text{Offset}(dB) &= \text{RF cable loss}(dB) + \text{attenuator factor}(dB). \\ &= 4.2 + 10 = 14.2 \text{ (dB)} \end{aligned}$$

3 Test Result

3.1 26dB & 99% Occupied Bandwidth Measurement

3.1.1 Description of 26dB & 99% Occupied Bandwidth

This section is for reporting purpose only.

There is no restriction limits for bandwidth.

3.1.2 Measuring Instruments

The measuring equipment is listed in the section 4 of this test report.

3.1.3 Test Procedures

1. The testing follows FCC KDB 789033 D02 General UNII Test Procedures New Rules v01.
Section C) Emission bandwidth
2. Set RBW = approximately 1% of the emission bandwidth.
3. Set the VBW > RBW.
4. Detector = Peak.
5. Trace mode = max hold
6. Measure the maximum width of the emission that is 26 dB down from the peak of the emission.
Compare this with the RBW setting of the analyzer. Readjust RBW and repeat measurement as needed until the RBW/EBW ratio is approximately 1%.
7. For 99% Bandwidth Measurement, the spectrum analyzer's resolution bandwidth (RBW) is set 1MHz and set the Video bandwidth (VBW) $\geq 3 * RBW$.
8. Measure and record the results in the test report.

3.1.4 Test Setup

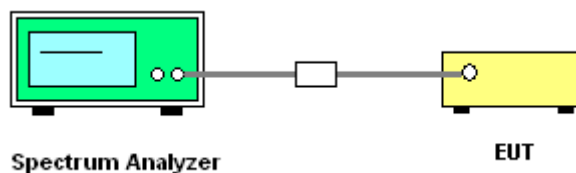



3.1.5 Test Result of 26dB & 99% Occupied Bandwidth Plots

Test Band :	5GHz band 1	Temperature :	21~26°C
Test Engineer :	Bill Kuo	Relative Humidity :	45~54%

Mod.	Data Rate	N _{TX}	Channel	Freq. (MHz)	99% Bandwidth (MHz)	IC 99% Bandwidth EIRP Limit (dBm)
11a	6Mbps	1	36	5180	18.20	22.60
11a	6Mbps	1	44	5220	18.10	22.58
11a	6Mbps	1	48	5240	18.10	22.58
HT20	MCS0	1	36	5180	18.90	22.76
HT20	MCS0	1	44	5220	18.95	22.78
HT20	MCS0	1	48	5240	19.10	22.81
HT40	MCS0	1	38	5190	36.50	23.01
HT40	MCS0	1	46	5230	36.50	23.01

Test Band :	5GHz band 2	Temperature :	21~26°C
Test Engineer :	Bill Kuo	Relative Humidity :	45~54%

Mod.	Data Rate	N _{TX}	Channel	Freq. (MHz)	99% Bandwidth (MHz)	26dB Bandwidth (MHz)	IC 99% Bandwidth EIRP Limit (dBm)	FCC 26dB Bandwidth Power Limit (dBm)
11a	6Mbps	1	52	5260	17.90	23.70	29.53	23.98
11a	6Mbps	1	60	5300	18.05	23.85	29.56	23.98
11a	6Mbps	1	64	5320	18.00	23.80	29.55	23.98
HT20	MCS0	1	52	5260	18.85	23.95	29.75	23.98
HT20	MCS0	1	60	5300	18.70	23.90	29.72	23.98
HT20	MCS0	1	64	5320	19.00	24.15	29.79	23.98
HT40	MCS0	1	54	5270	36.50	45.09	30.00	23.98
HT40	MCS0	1	62	5310	36.60	45.54	30.00	23.98



Test Band :	5GHz band 3	Temperature :	21~26°C
Test Engineer :	Bill Kuo	Relative Humidity :	45~54%

Mod.	Data Rate	N _{TX}	Channel	Freq. (MHz)	99% Bandwidth (MHz)	26dB Bandwidth (MHz)	IC 99% Bandwidth EIRP Limit (dBm)	FCC 26dB Bandwidth Power Limit (dBm)
11a	6Mbps	1	100	5500	18.15	23.50	29.59	23.98
11a	6Mbps	1	116	5580	18.05	23.65	29.56	23.98
11a	6Mbps	1	140	5700	18.15	23.85	29.59	23.98
HT20	MCS0	1	100	5500	18.80	23.70	29.74	23.98
HT20	MCS0	1	116	5580	18.90	24.00	29.76	23.98
HT20	MCS0	1	140	5700	18.90	23.90	29.76	23.98
HT40	MCS0	1	102	5510	36.50	45.09	30.00	23.98
HT40	MCS0	1	110	5550	36.40	45.18	30.00	23.98
HT40	MCS0	1	134	5670	36.40	44.91	30.00	23.98

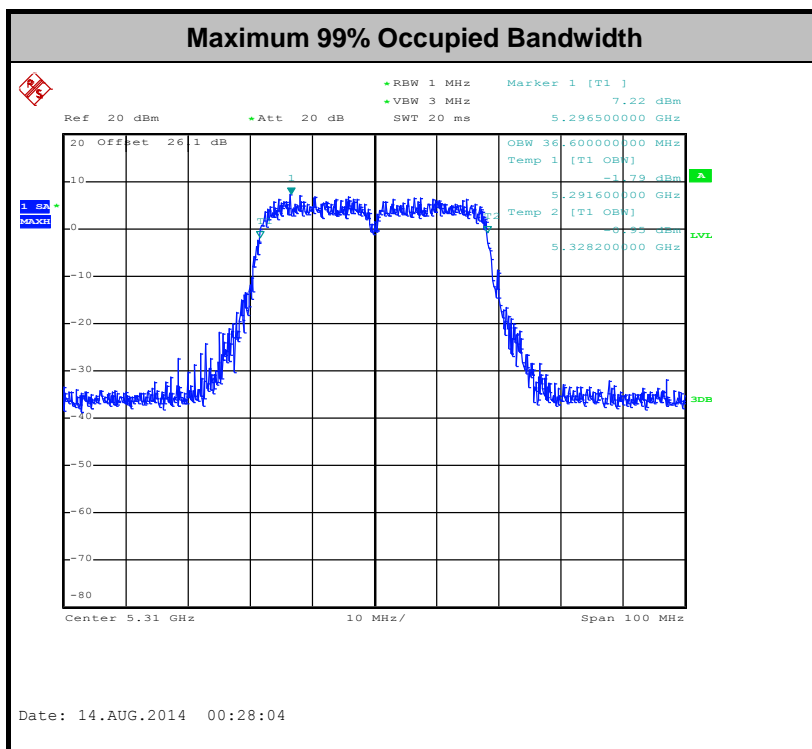
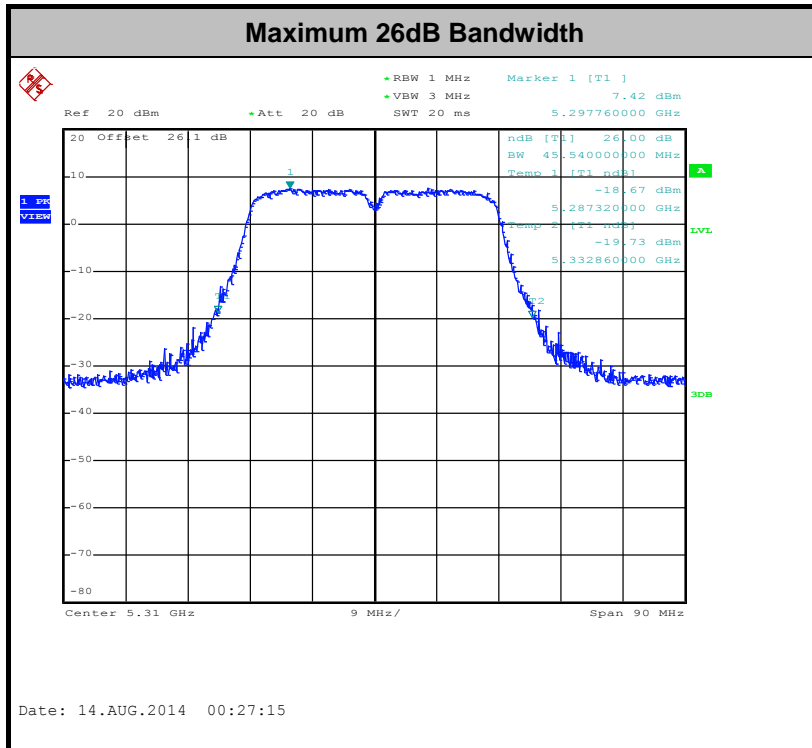



3.1.6 Test Result of 20dB Occupied Bandwidth

Mod.	Data Rate	N _{TX}	Channel	Freq. (MHz)	20dB Bandwidth (MHz)	20dB Bandwidth Upper Frequency (FH) (MHz)	Upper Limit Line (MHz)	Pass/Fail
11a	6Mbps	1	48	5240	19.90	5249.95	5250	Pass
HT20	MCS0	1	48	5240	20.05	5249.95		Pass
HT40	MCS0	1	46	5230	40.77	5249.89		Pass



20dB Occupied Bandwidth

802.11a CH48 5240MHz

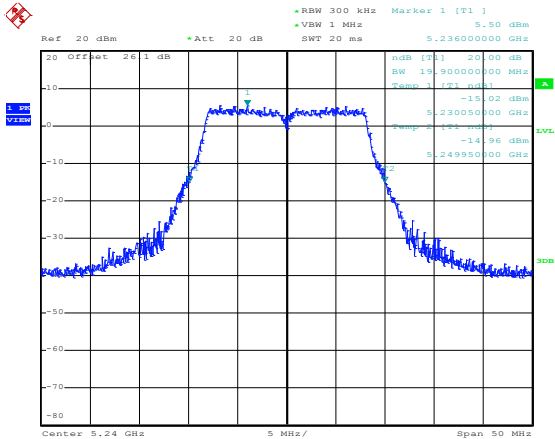

Date: 13.AUG.2014 23:46:50

802.11n HT20 CH48 5240MHz

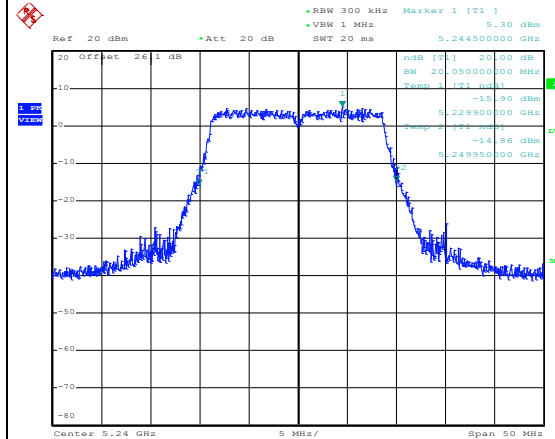

Date: 14.AUG.2014 00:11:50

802.11n HT40 CH46 5230MHz

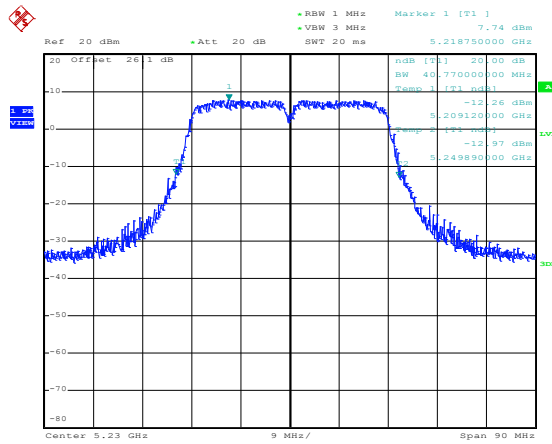

Date: 14.AUG.2014 00:25:31

3.2 Maximum Conducted Output Power Measurement

3.2.1 Limit of Maximum Conducted Output Power

<FCC 14-30 CFR 15.407>

For mobile and portable client devices in the 5.15–5.25 GHz band, the maximum conducted output power over the frequency band of operation shall not exceed 250 mW.

For the 5.25–5.35 GHz and 5.47–5.725 GHz bands, the maximum conducted output power over the frequency bands of operation shall not exceed the lesser of 250 mW or $11 \text{ dBm} + 10 \log B$, where B is the 26 dB emission bandwidth in megahertz.

If transmitting antennas of directional gain greater than 6 dBi are used, the peak output power shall be reduced by the amount in dB that the directional gain of the antenna exceeds 6 dBi.

Note that U-NII-2 band, devices with a maximum e.i.r.p. greater than 500 mW shall implement TPC in order to have the capability to operate at least 6 dB below the maximum permitted e.i.r.p. of 1 W.

3.2.2 Measuring Instruments

The measuring equipment is listed in the section 4 of this test report.

3.2.3 Test Procedures

The testing follows Method PM of FCC KDB 789033 D02 General UNII Test Procedures New Rules v01.

Method PM (Measurement using an RF average power meter):

1. Measurement is performed using a wideband RF power meter.
2. The EUT is configured to transmit continuously with a consistent duty cycle at its maximum power control level.
3. Measure the average power of the transmitter, and the average power is corrected with duty factor, $10 \log(1/x)$, where x is the duty cycle.

3.2.4 Test Setup

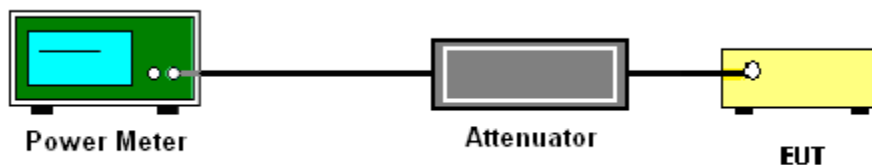



3.2.5 Test Result of Maximum Conducted Output Power

Test Band :	5GHz band 1	Temperature :	21~26°C
Test Engineer :	Bill Kuo	Relative Humidity :	45~54%

Mod.	Data Rate	N _{TX}	Channel	Freq. (MHz)	Duty Factor (dB)	Average Conducted Power (dBm)	FCC Conducted Power Limit (dBm)	DG (dBi)	Pass/Fail
11a	6Mbps	1	36	5180	0.60	13.18	24.00	-2.00	Pass
11a	6Mbps	1	44	5220	0.60	12.99	24.00	-2.00	Pass
11a	6Mbps	1	48	5240	0.60	12.92	24.00	-2.00	Pass
HT20	MCS0	1	36	5180	0.63	13.34	24.00	-2.00	Pass
HT20	MCS0	1	44	5220	0.63	13.14	24.00	-2.00	Pass
HT20	MCS0	1	48	5240	0.63	13.01	24.00	-2.00	Pass
HT40	MCS0	1	38	5190	1.21	13.16	24.00	-2.00	Pass
HT40	MCS0	1	46	5230	1.21	13.02	24.00	-2.00	Pass

Note: Final Output Power equals to Measured Output Power adds the duty factor.

Test Band :	5GHz band 2	Temperature :	21~26°C
Test Engineer :	Bill Kuo	Relative Humidity :	45~54%

Mod.	Data Rate	N _{TX}	Channel	Freq. (MHz)	Duty Factor (dB)	Average Conducted Power (dBm)	FCC Conducted Power Limit (dBm)	DG (dBi)	Pass/Fail
11a	6Mbps	1	52	5260	0.60	12.83	23.98	-2.00	Pass
11a	6Mbps	1	60	5300	0.60	12.80	23.98	-2.00	Pass
11a	6Mbps	1	64	5320	0.60	12.71	23.98	-2.00	Pass
HT20	MCS0	1	52	5260	0.63	12.98	23.98	-2.00	Pass
HT20	MCS0	1	60	5300	0.63	12.82	23.98	-2.00	Pass
HT20	MCS0	1	64	5320	0.63	12.73	23.98	-2.00	Pass
HT40	MCS0	1	54	5270	1.21	12.85	23.98	-2.00	Pass
HT40	MCS0	1	62	5310	1.21	12.72	23.98	-2.00	Pass

Note: Final Output Power equals to Measured Output Power adds the duty factor.



Test Band :	5GHz band 3	Temperature :	21~26°C
Test Engineer :	Bill Kuo	Relative Humidity :	45~54%

Mod.	Data Rate	N _{TX}	Channel	Freq. (MHz)	Duty Factor (dB)	Average Conducted Power (dBm)	FCC Conducted Power Limit (dBm)	DG (dBi)	Pass/Fail
11a	6Mbps	1	100	5500	0.60	13.08	23.98	-2.00	Pass
11a	6Mbps	1	116	5580	0.60	12.90	23.98	-2.00	Pass
11a	6Mbps	1	140	5700	0.60	12.85	23.98	-2.00	Pass
HT20	MCS0	1	100	5500	0.63	13.06	23.98	-2.00	Pass
HT20	MCS0	1	116	5580	0.63	13.04	23.98	-2.00	Pass
HT20	MCS0	1	140	5700	0.63	12.88	23.98	-2.00	Pass
HT40	MCS0	1	102	5510	1.21	13.33	23.98	-2.00	Pass
HT40	MCS0	1	110	5550	1.21	13.12	23.98	-2.00	Pass
HT40	MCS0	1	134	5670	1.21	12.88	23.98	-2.00	Pass

Note: Final Output Power equals to Measured Output Power adds the duty factor.



3.3 Power Spectral Density Measurement

3.3.1 Limit of Power Spectral Density

For the band 5150-5250 MHz, the peak power spectral density shall not exceed 4 dBm in any 1-MHz band.

For the bands 5250-5350 MHz and 5470-5600 and 5650-5725 MHz, the peak power spectral density shall not exceed 11 dBm in any 1-MHz band.

If transmitting antenna directional gain is greater than 6 dBi, both the maximum conducted output power and the peak power spectral density shall be reduced by the amount in dB that the directional gain of the antenna exceeds 6 dBi.

3.3.2 Measuring Instruments

The measuring equipment is listed in the section 4 of this test report.

3.3.3 Test Procedures

The testing follows FCC KDB 789033 D02 General UNII Test Procedures New Rules v01.
Section F) Maximum power spectral density.

Method SA-2

(trace averaging across on and off times of the EUT transmissions, followed by duty cycle correction).

1. The testing follows Method SA-2 of FCC KDB 789033 D02 General UNII Test Procedures New Rules v01.
 - Measure the duty cycle.
 - Set span to encompass the entire emission bandwidth (EBW) of the signal.
 - Set RBW = 1 MHz.
 - Set VBW \geq 3 MHz.
 - Number of points in sweep \geq 2 Span / RBW.
 - Sweep time = auto.
 - Detector = RMS
 - Trace average at least 100 traces in power averaging mode.
 - Add $10 \log(1/x)$, where x is the duty cycle, to the measured power in order to compute the average power during the actual transmission times. For example, add $10 \log(1/0.25) = 6$ dB if the duty cycle is 25 percent.
2. The RF output of EUT was connected to the spectrum analyzer by a low loss cable.
3. Each plot has already offset with cable loss, and attenuator loss. Measure the PPSD and record it.

3.3.4 Test Setup

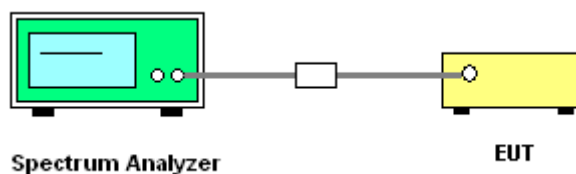



3.3.5 Test Result of Power Spectral Density

Test Band :	5GHz band 1	Temperature :	21~26°C
Test Engineer :	Bill Kuo	Relative Humidity :	45~54%

Mod.	Data Rate	N _{TX}	CH	Freq. (MHz)	Duty Factor (dB)	Average Power Density (dBm/MHz)	Average PSD Limit (dBm)	DG (dBi)	Pass/Fail
11a	6Mbps	1	36	5180	0.60	2.42	11.00	-2.00	Pass
11a	6Mbps	1	44	5220	0.60	2.61	11.00	-2.00	Pass
11a	6Mbps	1	48	5240	0.60	2.34	11.00	-2.00	Pass
HT20	MCS0	1	36	5180	0.63	2.23	11.00	-2.00	Pass
HT20	MCS0	1	44	5220	0.63	2.40	11.00	-2.00	Pass
HT20	MCS0	1	48	5240	0.63	2.17	11.00	-2.00	Pass
HT40	MCS0	1	38	5190	1.21	-0.43	11.00	-2.00	Pass
HT40	MCS0	1	46	5230	1.21	-0.63	11.00	-2.00	Pass

Test Band :	5GHz band 2	Temperature :	21~26°C
Test Engineer :	Bill Kuo	Relative Humidity :	45~54%

Mod.	Data Rate	N _{TX}	CH	Freq. (MHz)	Duty Factor (dB)	Average Power Density (dBm/MHz)	Average PSD Limit (dBm)	DG (dBi)	Pass/Fail
11a	6Mbps	1	52	5260	0.60	1.96	11.00	-2.00	Pass
11a	6Mbps	1	60	5300	0.60	1.93	11.00	-2.00	Pass
11a	6Mbps	1	64	5320	0.60	1.87	11.00	-2.00	Pass
HT20	MCS0	1	52	5260	0.63	1.88	11.00	-2.00	Pass
HT20	MCS0	1	60	5300	0.63	1.91	11.00	-2.00	Pass
HT20	MCS0	1	64	5320	0.63	1.65	11.00	-2.00	Pass
HT40	MCS0	1	54	5270	1.21	-0.97	11.00	-2.00	Pass
HT40	MCS0	1	62	5310	1.21	-0.71	11.00	-2.00	Pass



Test Band :	5GHz band 3	Temperature :	21~26°C
Test Engineer :	Bill Kuo	Relative Humidity :	45~54%

Mod.	Data Rate	N _{TX}	CH	Freq. (MHz)	Duty Factor (dB)	Average Power Density (dBm/MHz)	Average PSD Limit (dBm)	DG (dBi)	Pass/Fail
11a	6Mbps	1	100	5500	0.60	2.69	11.00	-2.00	Pass
11a	6Mbps	1	116	5580	0.60	2.54	11.00	-2.00	Pass
11a	6Mbps	1	140	5700	0.60	2.43	11.00	-2.00	Pass
HT20	MCS0	1	100	5500	0.63	2.65	11.00	-2.00	Pass
HT20	MCS0	1	116	5580	0.63	2.30	11.00	-2.00	Pass
HT20	MCS0	1	140	5700	0.63	2.35	11.00	-2.00	Pass
HT40	MCS0	1	102	5510	1.21	-0.23	11.00	-2.00	Pass
HT40	MCS0	1	110	5550	1.21	-0.09	11.00	-2.00	Pass
HT40	MCS0	1	134	5670	1.21	-0.57	11.00	-2.00	Pass

Note : For NII-3 PSD measured value dBm/MHz is no worse than the limit line dBm/500kHz

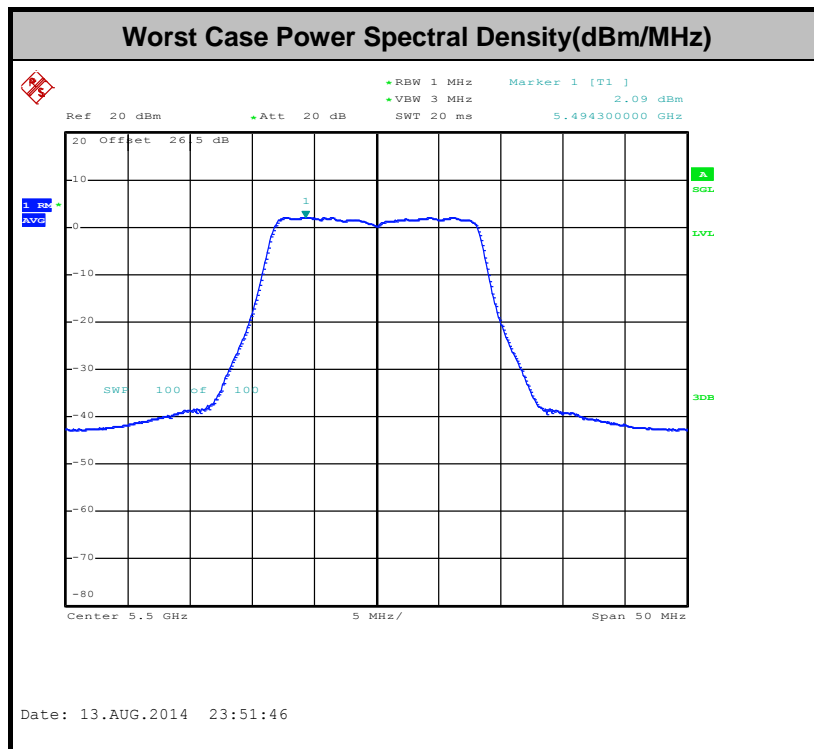

Note: Average Power Density (dB) = Measured value+ Duty Factor



3.4 Unwanted Radiated Emission Measurement

This section as specified in FCC Part 15.407(b) is to measure unwanted emissions through radiated measurement for band edge spurious emissions and out of band emissions measurement. The unwanted emissions shall comply with 15.407(b)(1) to (6), and restricted bands per FCC Part15.205.

3.4.1 Limit of Unwanted Emissions

(1) For transmitters operating in the 5150-5250 MHz band: all emissions outside of the 5150-5350 MHz band shall not exceed an EIRP of -27dBm/MHz.

For transmitters operating in the 5250-5350 MHz band: all emissions outside of the 5150-5350 MHz band shall not exceed an EIRP of -27 dBm/MHz. Devices operating in the 5250-5350 MHz band that generate emissions in the 5150-5250 MHz band must meet all applicable technical requirements for operation in the 5150-5250 MHz band (including indoor use) or alternatively meet an out-of-band emission EIRP limit of -27 dBm/MHz in the 5150-5250 MHz band.

For transmitters operating in the 5470-5600 MHz and 5650-5725MHz band: all emissions outside of the 5470-5600 MHz and 5650-5725MHz band shall not exceed an EIRP of -27 dBm/MHz.

(2) Unwanted spurious emissions fallen in restricted bands per FCC Part15.205 shall comply with the general field strength limits set forth in § 15.209 as below table,

Frequency (MHz)	Field Strength (microvolts/meter)	Measurement Distance (meters)
0.009 – 0.490	2400/F(kHz)	300
0.490 – 1.705	24000/F(kHz)	30
1.705 – 30.0	30	30
30 – 88	100	3
88 – 216	150	3
216 - 960	200	3
Above 960	500	3

Note: The following formula is used to convert the EIRP to field strength.



$$E = \frac{1000000\sqrt{30P}}{3} \text{ } \mu\text{V/m, where P is the eirp (Watts)}$$

EIRP (dBm)	Field Strength at 3m (dBμV/m)
-17	78.3
- 27	68.3

(3) KDB789033 v01 G)2)c) As specified in 15.407(b), emissions above 1000 MHz that are outside of the restricted bands are subject to a peak emission limit of -27 dBm/MHz (or -17 dBm/MHz as specified in 15.407(b)(4)). However, an out-of-band emission that complies with both the average and peak limits of 15.209 is not required to satisfy the -27 dBm/MHz or -17 dBm/MHz peak emission limit.

3.4.2 Measuring Instruments

The measuring equipment is listed in the section 4 of this test report.



3.4.3 Test Procedures

1. The testing follows FCC KDB 789033 D02 General UNII Test Procedures New Rules v01. Section G) Unwanted emissions measurement.

(1) Procedure for Unwanted Emissions Measurements Below 1000MHz

- RBW = 120 kHz
- VBW = 300 kHz
- Detector = Peak
- Trace mode = max hold

(2) Procedure for Peak Unwanted Emissions Measurements Above 1000 MHz

- RBW = 1 MHz
- VBW ≥ 3 MHz
- Detector = Peak
- Sweep time = auto
- Trace mode = max hold

(3) Procedures for Average Unwanted Emissions Measurements Above 1000MHz

- RBW = 1 MHz
- VBW = 10 Hz, when duty cycle is no less than 98 percent.
- $VBW \geq 1/T$, when duty cycle is less than 98 percent where T is the minimum transmission duration over which the transmitter is on and is transmitting at its maximum power control level for the tested mode of operation.

Band	Duty Cycle(%)	T(μs)	1/T(kHz)	VBW Setting
802.11a	87.18	1360	0.74	1kHz
802.11n HT20	86.47	1278	0.78	1kHz
802.11n HT40	75.71	636	1.57	3kHz

- The EUT was placed on a rotatable table top 0.8 meter above ground.
- The EUT was set 3 meters from the interference receiving antenna which was mounted on the top of a variable height antenna tower.
- The antenna is a broadband antenna and its height is adjusted between one meter and four meters above ground to find the maximum value of the field strength for both horizontal polarization and vertical polarization of the antenna.
- For each suspected emission, the EUT was arranged to its worst case and then adjust the antenna tower (from 1 m to 4 m) and turntable (from 0 degree to 360 degrees) to find the maximum reading.

6. For testing below 1GHz, if the emission level of the EUT in peak mode was 3 dB lower than the limit specified, then peak values of EUT will be reported, otherwise, the emissions will be repeated one by one using the CISPR quasi-peak method and reported.
7. For testing above 1GHz, the emission level of the EUT in peak mode was 20dB lower than average limit (that means the emission level in average mode also complies with the limit in average mode), then peak values of EUT will be reported, otherwise, the emissions will be measured in average mode again and reported.

3.4.4 Test Setup

For radiated emissions below 30MHz

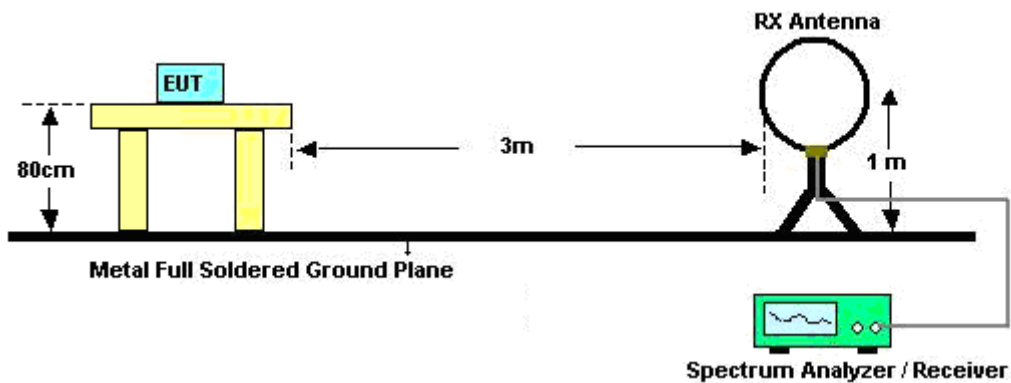

For radiated emissions from 30MHz to 1GHz

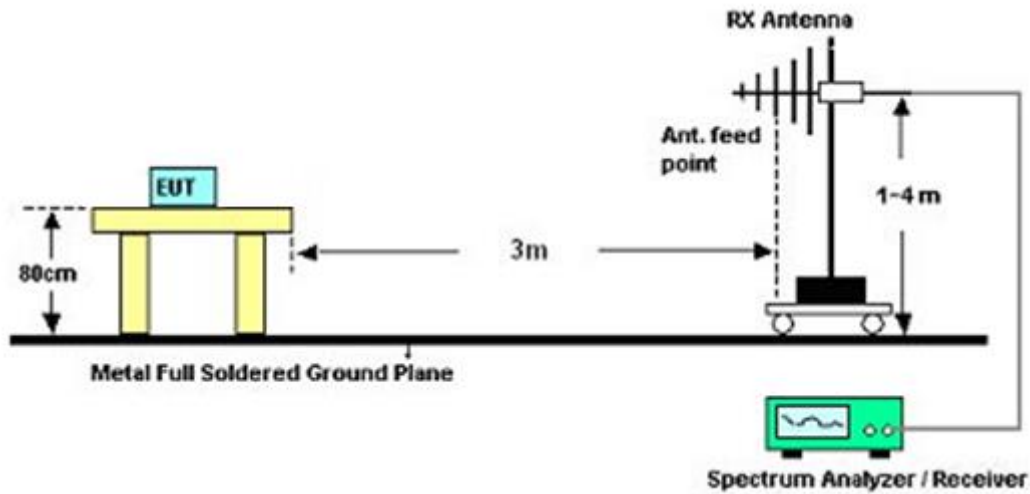

For radiated emissions above 1GHz

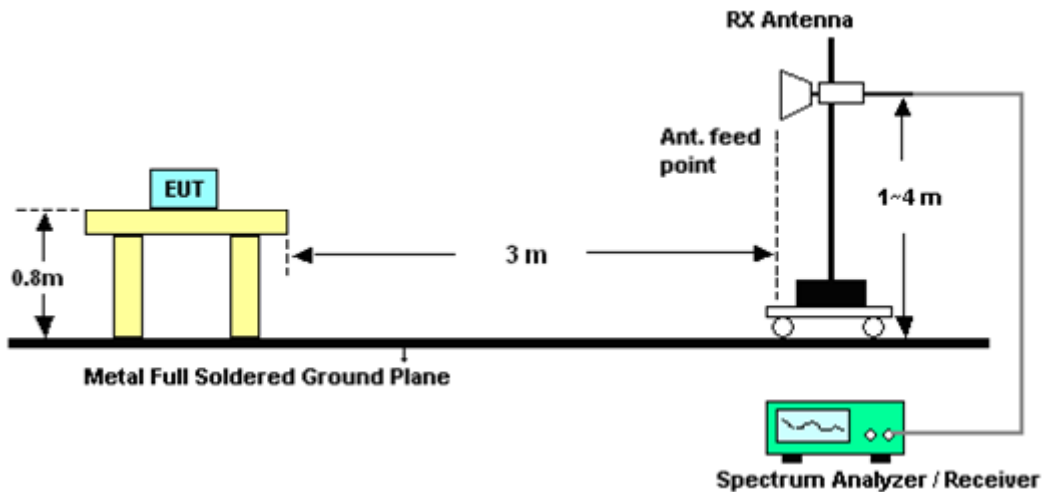

3.4.5 Test Results of Radiated Emissions (9 kHz ~ 30 MHz)

The low frequency, which started from 9 kHz to 30MHz, was pre-scanned and the result which was 20dB lower than the limit line per 15.31(o) was not reported.

3.4.6 Test Result

Please refer to Appendix A.



3.5 AC Conducted Emission Measurement

3.5.1 Limit of AC Conducted Emission

For equipment that is designed to be connected to the public utility (AC) power line, the radio frequency voltage that is conducted back onto the AC power line on any frequency or frequencies within the band 150 kHz to 30 MHz shall not exceed the limits in the following table.

Frequency of emission (MHz)	Conducted limit (dB μ V)	
	Quasi-peak	Average
0.15-0.5	66 to 56*	56 to 46*
0.5-5	56	46
5-30	60	50

*Decreases with the logarithm of the frequency.

3.5.2 Measuring Instruments

The measuring equipment is listed in the section 4 of this test report.

3.5.3 Test Procedures

1. The EUT was placed 0.4 meter from the conducting wall of the shielding room was kept at least 80 centimeters from any other grounded conducting surface.
2. Connect EUT to the power mains through a line impedance stabilization network (LISN).
3. All the support units are connecting to the other LISN.
4. The LISN provides 50 ohm coupling impedance for the measuring instrument.
5. The FCC states that a 50 ohm, 50 microhenry LISN should be used.
6. Both sides of AC line were checked for maximum conducted interference.
7. The frequency range from 150 kHz to 30 MHz was searched.
8. Set the test-receiver system to Peak Detect Function and specified bandwidth with Maximum Hold Mode.

3.5.4 Test Setup

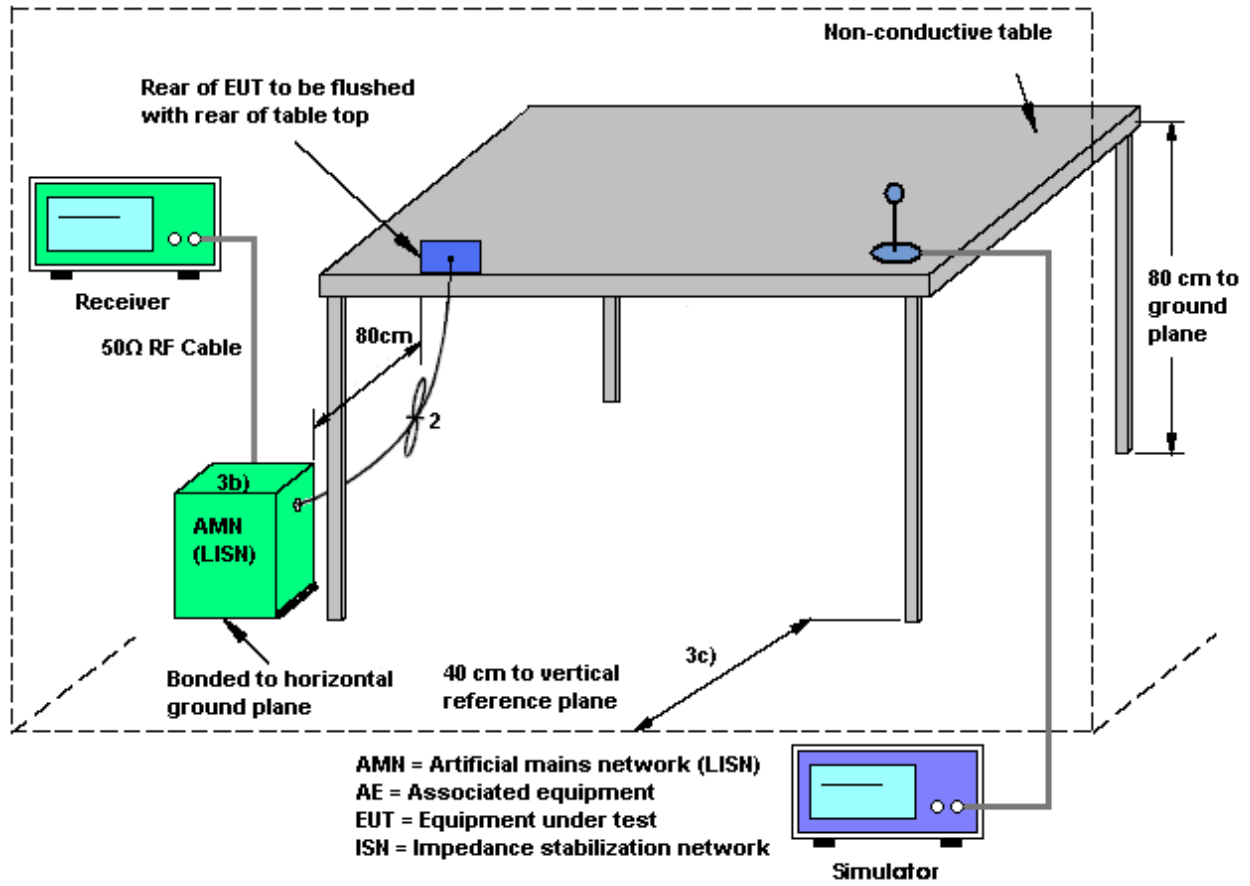



3.5.5 Test Result of AC Conducted Emission

Test Mode :	Mode 1	Temperature :	20~22°C
Test Engineer :	Kai-Chun Chu	Relative Humidity :	46~48%
Test Voltage :	120Vac / 60Hz	Phase :	Line
Function Type :	WCDMA Band II Idle + Bluetooth Link + WLAN (5GHz) Link + GPS Rx + Earphone 1 + USB Cable 2(Data Link with Notebook)		

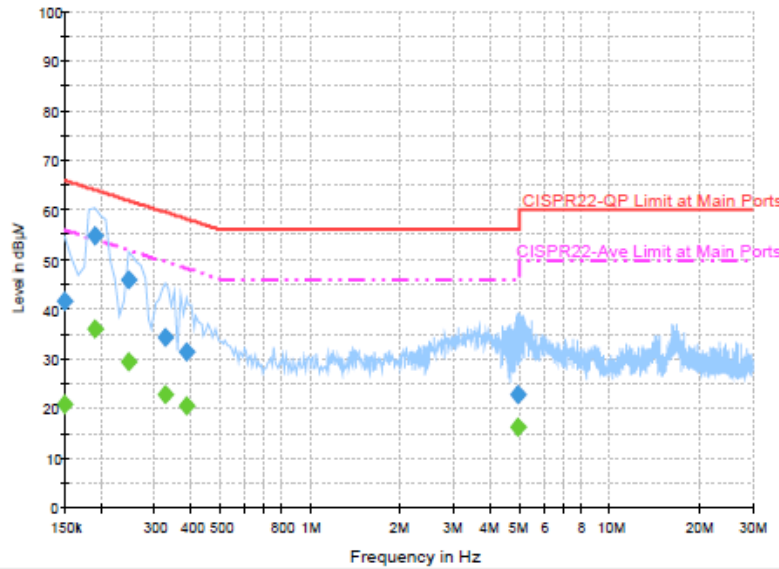

Final Result : QuasiPeak

Frequency (MHz)	QuasiPeak (dBµV)	Filter	Line	Corr. (dB)	Margin (dB)	Limit (dBµV)
0.150000	41.7	Off	L1	19.3	24.3	66.0
0.190000	54.8	Off	L1	19.3	9.2	64.0
0.246000	45.7	Off	L1	19.4	16.2	61.9
0.326000	34.2	Off	L1	19.4	25.4	59.6
0.382000	31.4	Off	L1	19.4	26.8	58.2
4.918000	22.9	Off	L1	19.6	33.1	56.0

Final Result : Average

Frequency (MHz)	Average (dBµV)	Filter	Line	Corr. (dB)	Margin (dB)	Limit (dBµV)
0.150000	20.7	Off	L1	19.3	35.3	56.0
0.190000	35.8	Off	L1	19.3	18.2	54.0
0.246000	29.3	Off	L1	19.4	22.6	51.9
0.326000	22.7	Off	L1	19.4	26.9	49.6
0.382000	20.3	Off	L1	19.4	27.9	48.2
4.918000	16.2	Off	L1	19.6	29.8	46.0



Test Mode :	Mode 1	Temperature :	20~22°C
Test Engineer :	Kai-Chun Chu	Relative Humidity :	46~48%
Test Voltage :	120Vac / 60Hz	Phase :	Neutral
Function Type :	WCDMA Band II Idle + Bluetooth Link + WLAN (5GHz) Link + GPS Rx + Earphone 1 + USB Cable 2(Data Link with Notebook)		

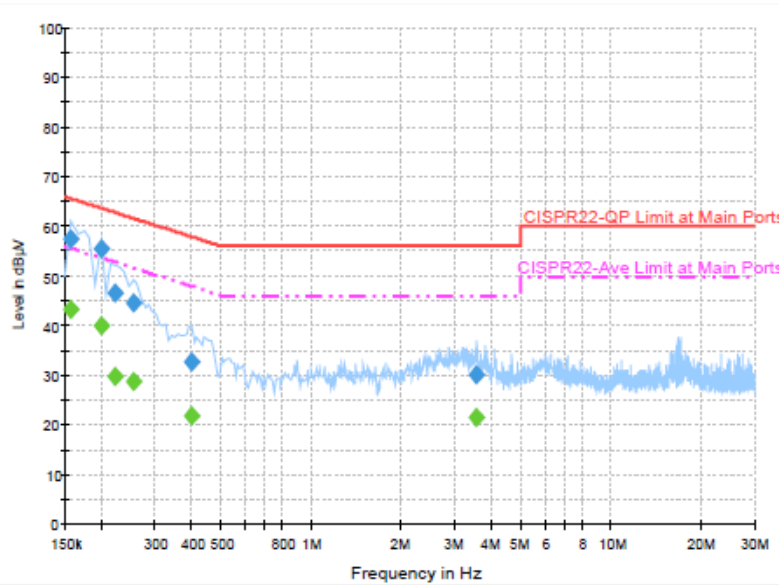

Final Result : QuasiPeak

Frequency (MHz)	QuasiPeak (dBµV)	Filter	Line	Corr. (dB)	Margin (dB)	Limit (dBµV)
0.158000	57.3	Off	N	19.4	8.3	65.6
0.198000	55.3	Off	N	19.3	8.4	63.7
0.222000	46.6	Off	N	19.3	16.1	62.7
0.254000	44.5	Off	N	19.4	17.1	61.6
0.398000	32.5	Off	N	19.4	25.4	57.9
3.550000	30.1	Off	N	19.6	25.9	56.0

Final Result : Average

Frequency (MHz)	Average (dBµV)	Filter	Line	Corr. (dB)	Margin (dB)	Limit (dBµV)
0.158000	43.2	Off	N	19.4	12.4	55.6
0.198000	39.9	Off	N	19.3	13.8	53.7
0.222000	29.6	Off	N	19.3	23.1	52.7
0.254000	28.7	Off	N	19.4	22.9	51.6
0.398000	21.8	Off	N	19.4	26.1	47.9
3.550000	21.4	Off	N	19.6	24.6	46.0

3.6 Frequency Stability Measurement

3.6.1 Limit of Frequency Stability

Manufacturers of U-NII devices are responsible for ensuring frequency stability such that an emission is maintained within the band of operation under all conditions of normal operation as specified in the user's manual.

3.6.2 Measuring Instruments

The measuring equipment is listed in the section 4 of this test report.

3.6.3 Test Procedures

1. To ensure emission at the band edge is maintained within the authorized band, those values shall be measured by radiation emissions at upper and lower frequency points, and finally compensated by frequency deviation as procedures below.
2. The EUT was operated at the maximum output power, and connected to the spectrum analyzer, which is set to maximum hold function and peak detector. The peak value of the power envelope was measured and noted. The upper and lower frequency points were respectively measured relatively 10dB lower than the measured peak value.
3. The frequency deviation was calculated by adding the upper frequency point and the lower frequency point divided by two. Those detailed values of frequency deviation are provided in table below.

3.6.4 Test Setup

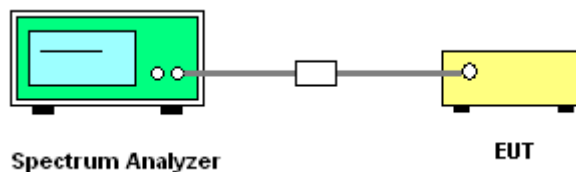



3.6.5 Test Result of Frequency Stability

Test Band :	5GHz band 1,2,3	Test Engineer :	Bill Kuo
-------------	-----------------	-----------------	----------

Mod.	Data Rate	NTX	Channel	Freq. (MHz)	Center Frequency (MHz)	Frequency Deviation (MHz)	Frequency Stability (ppm)	Temperature (°C)	Voltage (V)
11a	6Mbps	1	36	5180	5179.950	-0.050	-9.65	20	3.6
11a	6Mbps	1	36	5180	5179.950	-0.050	-9.65	20	4.4
11a	6Mbps	1	36	5180	5180.000	0.000	0.00	20	3.8
11a	6Mbps	1	36	5180	5180.000	0.000	0.00	-30	3.8
11a	6Mbps	1	36	5180	5180.000	0.000	0.00	50	3.8

Mod.	Data Rate	NTX	Channel	Freq. (MHz)	Center Frequency (MHz)	Frequency Deviation (MHz)	Frequency Stability (ppm)	Temperature (°C)	Voltage (V)
11a	6Mbps	1	64	5320	5320.000	0.000	0.00	20	3.6
11a	6Mbps	1	64	5320	5319.950	-0.050	-9.40	20	4.4
11a	6Mbps	1	64	5320	5319.950	-0.050	-9.40	20	3.8
11a	6Mbps	1	64	5320	5319.950	-0.050	-9.40	-30	3.8
11a	6Mbps	1	64	5320	5319.950	-0.050	-9.40	50	3.8

Mod.	Data Rate	NTX	Channel	Freq. (MHz)	Center Frequency (MHz)	Frequency Deviation (MHz)	Frequency Stability (ppm)	Temperature (°C)	Voltage (V)
11a	6Mbps	1	100	5500	5499.950	-0.050	-9.09	20	3.6
11a	6Mbps	1	100	5500	5499.925	-0.075	-13.64	20	4.4
11a	6Mbps	1	100	5500	5500.000	0.000	0.00	20	3.8
11a	6Mbps	1	100	5500	5500.000	0.000	0.00	-30	3.8
11a	6Mbps	1	100	5500	5499.950	-0.050	-9.09	50	3.8

Note: Center Frequency = (Low Frequency + High Frequency) / 2.



3.7 Automatically Discontinue Transmission

3.7.1 Limit of Automatically Discontinue Transmission

The device shall automatically discontinue transmission in case of either absence of information to transmit or operational failure. These provisions are not intended to preclude the transmission of control or signaling information or the use of repetitive codes used by certain digital technologies to complete frame or burst intervals. Applicants shall include in their application for equipment authorization to describe how this requirement is met.

3.7.2 Measuring Instruments

The measuring equipment is listed in the section 4 of this test report.

3.7.3 Test Result of Automatically Discontinue Transmission

While the EUT is not transmitting any information, the EUT can automatically discontinue transmission and become standby mode for power saving. The EUT can detect the controlling signal of ACK message transmitting from remote device and verify whether it shall resend or discontinue transmission.



3.8 Antenna Requirements

3.8.1 Standard Applicable

According to FCC 47 CFR Section 15.407(a)(1)(2) ,if transmitting antenna directional gain is greater than 6 dBi, both the peak transmit power and the peak power spectral density shall be reduced by the amount in dB that the directional gain of the antenna exceeds 6 dBi.

3.8.2 Antenna Anti-Replacement Construction

An embedded-in antenna design is used.

3.8.3 Antenna Gain

The antenna gain is less than 6 dBi. Therefore, it is not necessary to reduce maximum peak output power limit.



4 List of Measuring Equipment

Instrument	Manufacturer	Model No.	Serial No.	Characteristics	Calibration Date	Test Date	Due Date	Remark
Spectrum Analyzer	Rohde & Schwarz	FSP40	100055	9kHz~40GHz	Jun. 09, 2014	Aug. 06, 2014~ Sep. 02, 2014	Jun. 08, 2015	Conducted (TH02-HY)
Power Meter	Anritsu	ML2495A	1036004	300MHz~40GHz	Aug. 17, 2013	Aug. 06, 2014~ Aug. 08, 2014	Aug. 16, 2014	Conducted (TH02-HY)
Power Meter	Anritsu	ML2495A	1036004	300MHz~40GHz	Aug. 09, 2014	Aug. 09, 2014~ Sep. 02, 2014	Aug. 08, 2015	Conducted (TH02-HY)
Power Sensor	Anritsu	MA2411B	1027253	300MHz~40GHz	Aug. 017, 2013	Aug. 06, 2014~ Aug. 10, 2014	Aug. 16, 2014	Conducted (TH02-HY)
Power Sensor	Anritsu	MA2411B	1027253	300MHz~40GHz	Aug. 11, 2014	Aug. 11, 2014~ Sep. 02, 2014	Aug. 10, 2015	Conducted (TH02-HY)
EMI Test Receiver	Rohde & Schwarz	ESCS 30	100356	9kHz ~ 2.75GHz	Nov. 15, 2013	Aug. 06, 2014	Nov. 14, 2014	Conduction (CO05-HY)
LISN (for auxiliary equipment)	Rohde & Schwarz	ENV216	100081	9kHz ~ 30MHz	Dec. 12, 2013	Aug. 06, 2014	Dec. 11, 2014	Conduction (CO05-HY)
LISN	Rohde & Schwarz	ENV216	100080	9kHz ~ 30MHz	Dec. 04, 2013	Aug. 06, 2014	Dec. 03, 2014	Conduction (CO05-HY)
AC Power Source	ChainTek	APC-1000W	N/A	N/A	N/A	Aug. 06, 2014	N/A	Conduction (CO05-HY)
Spectrum Analyzer	Rohde & Schwarz	FSP40	100055	9kHz~40GHz	Jun. 09, 2014	Aug. 23, 2014~ Aug. 24, 2014	Jun. 08, 2015	Radiation (03CH05-HY)
Bilog Antenna	Schaffner	CBL6111C	2725	30MHz~1GHz	Oct. 10, 2013	Aug. 23, 2014~ Aug. 24, 2014	Oct. 09, 2014	Radiation (03CH05-HY)
Double Ridged Guide Horn Antenna	SCHWARZBECK	BBHA 9120 D	9120D-1241	1GHz~18GHz	Apr. 16, 2014	Aug. 23, 2014~ Aug. 24, 2014	Apr. 15, 2015	Radiation (03CH05-HY)
SHF-EHF Horn Antenna	SCHWARZBECK	BBHA 9170	BBHA9170251	18GHz~40GHz	Oct. 03, 2013	Aug. 23, 2014~ Aug. 24, 2014	Oct. 02, 2014	Radiation (03CH05-HY)
Loop Antenna	Rohde & Schwarz	HFH2-Z2	100315	9 kHz~30 MHz	Jul. 28, 2014	Aug. 23, 2014~ Aug. 24, 2014	Jul. 27, 2016	Radiation (03CH05-HY)
Preamplifier	MITEQ	AMF-7D-0010 1800-30-10P	1590074	100kHz~18GHz	Jul. 07, 2014	Aug. 23, 2014~ Aug. 24, 2014	Jul. 06, 2015	Radiation (03CH05-HY)
Preamplifier	EMCI	EMC011830	980148	DC~18GHz	Jun. 23, 2014	Aug. 23, 2014~ Aug. 24, 2014	Jun. 22, 2015	Radiation (03CH05-HY)
Preamplifier	COM-POWER	PA-103	161075	9kHz~30MHz	Apr. 15, 2014	Aug. 23, 2014~ Aug. 24, 2014	Apr. 14, 2015	Radiation (03CH05-HY)
Preamplifier	Miteq	TTA0204	1872107	18GHz~40GHz	May 23, 2014	Aug. 23, 2014~ Aug. 24, 2014	May 22, 2015	Radiation (03CH05-HY)
Turn Table	HD	HD100	420/611	0 - 360 degree	N/A	Aug. 23, 2014~ Aug. 24, 2014	N/A	Radiation (03CH05-HY)
Antenna Mast	HD	HD100	240/666	1 m - 4 m	N/A	Aug. 23, 2014~ Aug. 24, 2014	N/A	Radiation (03CH05-HY)



5 Uncertainty of Evaluation

Uncertainty of Conducted Emission Measurement (150kHz ~ 30MHz)

Measuring Uncertainty for a Level of Confidence of 95% ($U = 2Uc(y)$)	2.26
---	------

Uncertainty of Radiated Emission Measurement (30 MHz ~ 1000 MHz)

Measuring Uncertainty for a Level of Confidence of 95% ($U = 2Uc(y)$)	5.10
---	------

