



FCC RF Test Report

APPLICANT : HTC Corporation
EQUIPMENT : Smartphone
BRAND NAME : hTC
MODEL NAME : OPFH100
FCC ID : NM80PFH100
STANDARD : FCC 47 CFR Part 2, 22(H), 24(E), 27
CLASSIFICATION : PCS Licensed Transmitter Held to Ear (PCE)

The product was received on Jul. 29, 2014 and testing was completed on Oct. 02, 2014. We, SPORTON INTERNATIONAL INC., would like to declare that the tested sample has been evaluated in accordance with the test procedures given in ANSI / TIA / EIA-603-C-2004 and has been in compliance with the applicable technical standards.

The test results in this report apply exclusively to the tested model / sample. Without written approval of SPORTON INTERNATIONAL INC., the test report shall not be reproduced except in full.

Reviewed by: Joseph Lin / Supervisor

Approved by: Jones Tsai / Manager



SPORTON INTERNATIONAL INC.

No. 52, Hwa Ya 1st Rd., Hwa Ya Technology Park, Kwei-Shan Hsiang, Tao Yuan Hsien, Taiwan, R.O.C.

SPORTON INTERNATIONAL INC.
TEL : 886-3-327-3456
FAX : 886-3-328-4978
FCC ID : NM80PFH100

Page Number : 1 of 157
Report Issued Date : Oct. 08, 2014
Report Version : Rev. 01
Report Template No.: BU5-FG22/24 Version 1.1



TABLE OF CONTENTS

REVISION HISTORY..... 3

SUMMARY OF TEST RESULT 4

1 GENERAL DESCRIPTION 5

 1.1 Applicant..... 5

 1.2 Manufacturer 5

 1.3 Product Feature of Equipment Under Test 5

 1.4 Product Specification subjective to this standard 6

 1.5 Modification of EUT 6

 1.6 Maximum ERP/EIRP Power, Frequency Tolerance, and Emission Designator 7

 1.7 Testing Location 8

 1.8 Applicable Standards 8

2 TEST CONFIGURATION OF EQUIPMENT UNDER TEST 9

 2.1 Test Mode..... 9

 2.2 Connection Diagram of Test System 11

 2.3 Support Unit used in test configuration 11

 2.4 Measurement Results Explanation Example 11

3 TEST RESULT..... 12

 3.1 Conducted Output Power Measurement..... 12

 3.2 Peak-to-Average Ratio 15

 3.3 Effective Radiated Power and Effective Isotropic Radiated Power Measurement 31

 3.4 99% Occupied Bandwidth and 26dB Bandwidth Measurement..... 37

 3.5 Band Edge Measurement..... 61

 3.6 Conducted Spurious Emission Measurement 70

 3.7 Field Strength of Spurious Radiation Measurement 125

 3.8 Frequency Stability Measurement..... 151

4 LIST OF MEASURING EQUIPMENT 156

5 UNCERTAINTY OF EVALUATION 157



REVISION HISTORY

| REPORT NO. | VERSION | DESCRIPTION | ISSUED DATE |
|------------|---------|-------------------------|---------------|
| FG472933A | Rev. 01 | Initial issue of report | Oct. 08, 2014 |
| | | | |
| | | | |
| | | | |
| | | | |
| | | | |
| | | | |
| | | | |
| | | | |
| | | | |
| | | | |
| | | | |
| | | | |
| | | | |
| | | | |
| | | | |
| | | | |
| | | | |
| | | | |
| | | | |



SUMMARY OF TEST RESULT

| Report Section | FCC Rule | IC Rule | Description | Limit | Result | Remark |
|----------------|--|---|---|------------------------|--------|---|
| 3.1 | §2.1046 | RSS-132 (5.4) RSS-133 (6.4) RSS-139 (6.4) | Conducted Output Power | Reporting Only | PASS | - |
| 3.2 | §24.232(d) | RSS-132 (5.4) RSS-133 (6.4) RSS-139 (6.4) | Peak-to-Average Ratio | < 13 dB | PASS | - |
| 3.3 | §22.913(a)(2) | RSS-132(5.4) SRSP-503(5.1.3) | Effective Radiated Power | < 7 Watts | PASS | - |
| | §24.232(c) | RSS-133 (6.4) SRSP-510(5.1.2) | Equivalent Isotropic Radiated Power | < 2 Watts | PASS | - |
| | §27.50(d)(4) | RSS-139 (6.4) SRSP-513(5.1.2) | Equivalent Isotropic Radiated Power | < 1 Watts | PASS | - |
| 3.4 | §2.1049 §22.917(b) §24.238(b) §27.53(g) | RSS-GEN(4.6.1) RSS-133(6.5) RSS-139 (6.5) | Occupied Bandwidth | Reporting Only | PASS | - |
| 3.5 | §2.1051 §22.917(a) §24.238(a) §27.53(h) | RSS-GEN(4.9) RSS-132 (5.5) RSS-133 (6.5) RSS-139 (6.5) | Band Edge Measurement | < 43+10log10(P[Watts]) | PASS | - |
| 3.6 | §2.1051 §22.917(a) §24.238(a) §27.53(h) | RSS-GEN(4.9) RSS-132 (5.5) RSS-133 (6.5) RSS-139 (6.5) | Conducted Emission | < 43+10log10(P[Watts]) | PASS | - |
| 3.7 | §2.1053 §22.917(a) §24.238(a) §27.53(h) | RSS-GEN(4.9) RSS-132 (5.5) RSS-133 (6.5) RSS-139 (6.5) | Field Strength of Spurious Radiation | < 43+10log10(P[Watts]) | PASS | Under limit 16.26 dB at 13366.000 MHz |
| 3.8 | §2.1055 §22.355 §24.235 §27.54 | RSS-GEN(4.7) RSS-132 (5.3) RSS-133 (6.3) RSS-139 (6.3) | Frequency Stability for Temperature & Voltage | < 2.5 ppm | PASS | - |



1 General Description

1.1 Applicant

HTC Corporation

No. 23, Xinghua Rd., Taoyuan City, Taoyuan County 330, Taiwan.

1.2 Manufacturer

HTC Corporation

No. 23, Xinghua Rd., Taoyuan City, Taoyuan County 330, Taiwan.

1.3 Product Feature of Equipment Under Test

| Product Feature | |
|---------------------------------|--|
| Equipment | Smartphone |
| Brand Name | hTC |
| Model Name | 0PFH100 |
| FCC ID | NM80PFH100 |
| Sample 1 | EUT with Main Camera 1, Speaker(top) 1, Speaker(bottom) 1, Microphone 1, RAM 1, and RF PA 1 |
| Sample 2 | EUT with Main Camera 1, Speaker(top) 2, Speaker(bottom) 2, Microphone 2, RAM 2, and RF PA 1 |
| Sample 3 | EUT with Main Camera 2, Speaker(top) 2, Speaker(bottom) 2, Microphone 2, RAM 2, and RF PA 2 |
| EUT supports Radios application | GSM/EGPRS/WCDMA/HSPA/LTE/NFC WLAN 11b/g/n HT20 WLAN 11a HT20/HT40 Bluetooth v4.0 EDR/LE |
| EUT Stage | Identical Prototype |

Remark: The above EUT's information was declared by manufacturer. Please refer to the specifications or user's manual for more detailed description.



1.4 Product Specification subjective to this standard

| Product Specification subjective to this standard | |
|---|---|
| Tx Frequency | GSM850: 824.2 MHz ~ 848.8 MHz GSM1900: 1850.2 MHz ~ 1909.8MHz WCDMA Band V: 826.4 MHz ~ 846.6 MHz WCDMA Band IV : 1712.4 MHz ~ 1752.6 MHz WCDMA Band II: 1852.4 MHz ~ 1907.6 MHz |
| Rx Frequency | GSM850: 869.2 MHz ~ 893.8 MHz GSM1900: 1930.2 MHz ~ 1989.8 MHz WCDMA Band V: 871.4 MHz ~ 891.6 MHz WCDMA Band IV : 2112.4 MHz ~ 2152.6 MHz WCDMA Band II: 1932.4 MHz ~ 1987.6 MHz |
| Maximum Output Power to Antenna | GSM850 : 32.92 dBm GSM1900 : 29.94 dBm WCDMA Band V : 23.25 dBm WCDMA Band IV : 23.29 dBm WCDMA Band II : 23.13 dBm |
| 99% Occupied Bandwidth | GSM850: 2.50MHz GSM1900: 2.48MHz WCDMA Band V: 4.18MHz WCDMA Band IV: 4.18MHz WCDMA Band II: 4.18MHz |
| Antenna Type | Fixed Internal Antenna |
| Type of Modulation | GSM: GMSK GPRS: GMSK EDGE: GMSK / 8PSK WCDMA: QPSK (Uplink) HSDPA: QPSK (Uplink) HSUPA: QPSK (Uplink) |

1.5 Modification of EUT

No modifications are made to the EUT during all test items.



1.6 Maximum ERP/EIRP Power, Frequency Tolerance, and Emission Designator

| FCC Rule | System | Type of Modulation | Maximum ERP/EIRP (W) | Frequency Tolerance (ppm) | Emission Designator |
|----------|----------------------------|--------------------|----------------------|---------------------------|---------------------|
| Part 22 | GSM850 GPRS class 8 | GMSK | 0.63 | 0.007 ppm | 250KGXW |
| Part 22 | GSM850 EDGE class 8 | 8PSK | 0.37 | 0.005 ppm | 246KG7W |
| Part 22 | WCDMA Band V RMC 12.2Kbps | QPSK | 0.05 | 0.018 ppm | 4M18F9W |
| Part 24 | GSM1900 GPRS class 8 | GMSK | 0.88 | 0.003 ppm | 244KGXW |
| Part 24 | GSM1900 EDGE class 8 | 8PSK | 0.71 | 0.002 ppm | 248KG7W |
| Part 24 | WCDMA Band II RMC 12.2Kbps | QPSK | 0.15 | 0.003 ppm | 4M18F9W |
| Part 27 | WCDMA Band IV RMC 12.2Kbps | QPSK | 0.23 | 0.004 ppm | 4M18F9W |



1.7 Testing Location

Sporton Lab is accredited to ISO 17025 by Taiwan Accreditation Foundation (TAF code : 1190) and the FCC designation No. TW1022 under the FCC 2.948(e) by Mutual Recognition Agreement (MRA) in FCC Test.

| | | |
|---------------------------|---|-----------|
| Test Site | SPORTON INTERNATIONAL INC. | |
| Test Site Location | No. 52, Hwa Ya 1 st Rd., Hwa Ya Technology Park, Kwei-Shan Hsiang, Tao Yuan Hsien, Taiwan, R.O.C. TEL: +886-3-327-3456 FAX: +886-3-328-4978 | |
| Test Site No. | Sporton Site No. | |
| | TH02-HY | 03CH07-HY |

1.8 Applicable Standards

According to the specifications of the manufacturer, the EUT must comply with the requirements of the following standards:

- ♦ 47 CFR Part 2, 22(H), 24(E), 27(L)
- ♦ ANSI / TIA / EIA-603-C-2004
- ♦ FCC KDB 971168 D01 Power Meas. License Digital Systems v02r01
- ♦ FCC KDB 412172 D01 Determining ERP and ERIP v01

Remark:

1. All test items were verified and recorded according to the standards and without any deviation during the test.
2. This EUT has also been tested and complied with the requirements of FCC Part 15, Subpart B, recorded in a separate test report.



2 Test Configuration of Equipment Under Test

2.1 Test Mode

Antenna port conducted and radiated test items were performed according to KDB 971168 D01 Power Meas. License Digital Systems v02r01 with maximum output power.

Radiated measurements were performed with rotating EUT in different three orthogonal test planes to find the maximum emission.

Radiated emissions were investigated as following frequency range:

1. 30 MHz to 9000 MHz for GSM850 and WCDMA Band V.
2. 30 MHz to 19000 MHz for GSM1900 and WCDMA Band II.

All modes and data rates and positions were investigated.

Test modes are chosen to be reported as the worst case configuration below:

| Test Modes | | |
|---------------|--|--|
| Band | Radiated TCs | Conducted TCs |
| GSM 850 | <ul style="list-style-type: none"> ■ GPRS class 8 Link for Sample 1 ■ EDGE class 8 Link for Sample 1 ■ GPRS class 8 Link for Sample 3 | <ul style="list-style-type: none"> ■ GPRS class 8 Link ■ EDGE class 8 Link |
| GSM 1900 | <ul style="list-style-type: none"> ■ GPRS class 8 Link for Sample 1 ■ EDGE class 8 Link for Sample 1 | <ul style="list-style-type: none"> ■ GPRS class 8 Link ■ EDGE class 8 Link |
| WCDMA Band V | <ul style="list-style-type: none"> ■ RMC 12.2Kbps Link for Sample 1 | <ul style="list-style-type: none"> ■ RMC 12.2Kbps Link |
| WCDMA Band II | <ul style="list-style-type: none"> ■ RMC 12.2Kbps Link for Sample 1 | <ul style="list-style-type: none"> ■ RMC 12.2Kbps Link |
| WCDMA Band IV | <ul style="list-style-type: none"> ■ RMC 12.2Kbps Link for Sample 1 | <ul style="list-style-type: none"> ■ RMC 12.2Kbps Link |

Note: The maximum power levels are chosen to test as the worst case configuration as follows:

- GSM or GPRS multi-slot class 8 mode for GMSK modulation,
- EDGE multi-slot class 8 mode for 8PSK modulation,
- RMC 12.2Kbps mode for WCDMA band V,
- RMC 12.2Kbps mode for WCDMA band II,
- RMC 12.2Kbps mode for WCDMA band IV, only these modes were used for all tests.



Conducted Power Measurement Results:

| Conducted Power (*Unit: dBm) | | | | | | |
|------------------------------|--------|-------|-------|---------|--------|--------|
| Band | GSM850 | | | GSM1900 | | |
| Channel | 128 | 189 | 251 | 512 | 661 | 810 |
| Frequency | 824.2 | 836.4 | 848.8 | 1850.2 | 1880.0 | 1909.8 |
| GSM | 32.78 | 32.70 | 32.89 | 29.78 | 29.91 | 29.80 |
| GPRS class 8 | 32.81 | 32.72 | 32.92 | 29.81 | 29.94 | 29.82 |
| GPRS class 10 | 31.27 | 31.18 | 31.44 | 28.88 | 28.89 | 28.98 |
| GPRS class 11 | 29.19 | 29.17 | 29.24 | 26.94 | 26.84 | 26.90 |
| GPRS class 12 | 28.76 | 28.74 | 28.71 | 25.89 | 25.92 | 25.93 |
| EGPRS class 8 | 27.32 | 27.38 | 27.34 | 26.49 | 26.44 | 26.43 |
| EGPRS class 10 | 26.31 | 26.24 | 26.29 | 25.48 | 25.43 | 25.45 |
| EGPRS class 11 | 26.14 | 26.18 | 26.20 | 24.42 | 24.35 | 24.35 |
| EGPRS class 12 | 25.23 | 25.30 | 25.27 | 23.61 | 23.56 | 23.47 |

| Conducted Power (*Unit: dBm) | | | | | | | | | |
|------------------------------|--------------|-------|-------|---------------|-------|--------|---------------|--------|--------|
| Band | WCDMA Band V | | | WCDMA Band II | | | WCDMA Band IV | | |
| Channel | 4132 | 4182 | 4233 | 9262 | 9400 | 9538 | 1312 | 1413 | 1513 |
| Frequency | 826.4 | 836.4 | 846.6 | 1852.4 | 1880 | 1907.6 | 1712.4 | 1732.6 | 1752.6 |
| RMC 12.2K | 23.25 | 23.12 | 23.24 | 23.00 | 23.09 | 23.13 | 23.22 | 23.17 | 23.29 |
| HSDPA Subtest-1 | 22.27 | 22.20 | 22.30 | 22.07 | 22.19 | 22.21 | 22.23 | 22.31 | 22.42 |
| HSDPA Subtest-2 | 22.29 | 22.19 | 22.27 | 22.04 | 22.13 | 22.19 | 22.25 | 22.35 | 22.42 |
| HSDPA Subtest-3 | 21.77 | 21.57 | 21.82 | 21.58 | 21.63 | 21.64 | 21.75 | 21.72 | 21.84 |
| HSDPA Subtest-4 | 21.81 | 21.57 | 21.76 | 21.53 | 21.62 | 21.63 | 21.72 | 21.76 | 21.87 |
| HSUPA Subtest-1 | 21.57 | 21.64 | 21.56 | 21.47 | 21.51 | 21.86 | 21.62 | 21.79 | 21.26 |
| HSUPA Subtest-2 | 21.05 | 21.04 | 20.78 | 20.38 | 20.51 | 20.78 | 21.03 | 21.11 | 21.20 |
| HSUPA Subtest-3 | 20.61 | 20.58 | 20.66 | 21.09 | 21.18 | 21.43 | 21.04 | 21.20 | 21.23 |
| HSUPA Subtest-4 | 21.48 | 21.55 | 21.47 | 21.37 | 21.42 | 21.53 | 21.26 | 21.32 | 21.37 |
| HSUPA Subtest-5 | 22.25 | 22.14 | 22.24 | 21.28 | 21.32 | 21.50 | 21.47 | 21.50 | 21.53 |

2.2 Connection Diagram of Test System

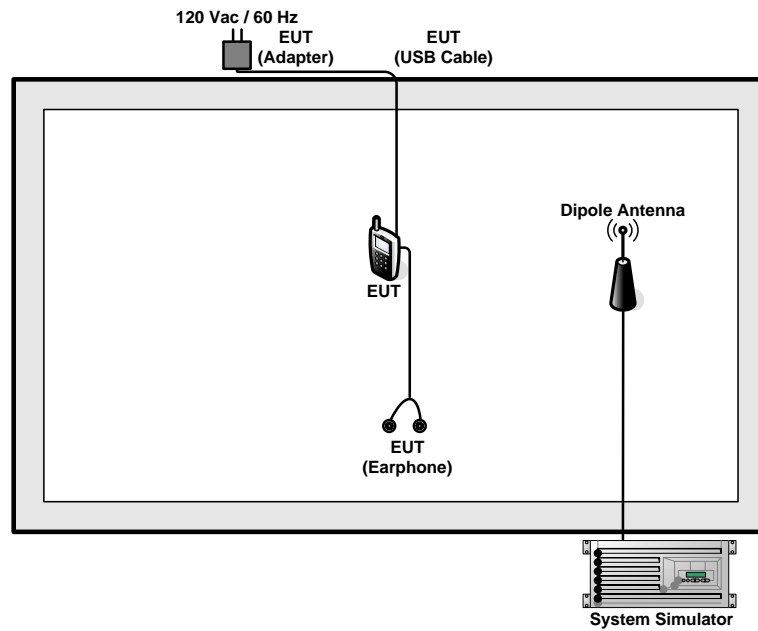

2.3 Support Unit used in test configuration

| Item | Equipment | Trade Name | Model No. | FCC ID | Data Cable | Power Cord |
|------|------------------|------------|-----------|--------|------------|-------------------|
| 1. | System Simulator | R&S | CMU 200 | N/A | N/A | Unshielded, 1.8 m |

2.4 Measurement Results Explanation Example

For all conducted test items:

The offset level is set in the spectrum analyzer to compensate the RF cable loss and attenuator factor between RF conducted output port and spectrum analyzer. With the offset compensation, the spectrum analyzer reading level will be exactly the RF output level.

The spectrum analyzer offset is derived from RF cable loss and attenuator factor.

Offset = RF cable loss + attenuator factor.

The following shows an offset computation example with RF cable loss 4.2 dB and a 10dB attenuator.

Example :

$$\begin{aligned} \text{Offset(dB)} &= \text{RF cable loss(dB)} + \text{attenuator factor(dB)}. \\ &= 4.2 + 10 = 14.2 \text{ (dB)} \end{aligned}$$

3 Test Result

3.1 Conducted Output Power Measurement

3.1.1 Description of the Conducted Output Power Measurement

A system simulator was used to establish communication with the EUT. Its parameters were set to enforce EUT transmitting at the maximum power. The measured power in the radio frequency on the transmitter output terminals shall be reported.

3.1.2 Measuring Instruments

The measuring equipment is listed in the section 4 of this test report.

3.1.3 Test Procedures

1. The transmitter output port was connected to the system simulator.
2. Set EUT at maximum power through system simulator.
3. Select lowest, middle, and highest channels for each band and different modulation.
4. Measure the maximum burst average power for GSM and maximum average power for other modulation signal.

3.1.4 Test Setup

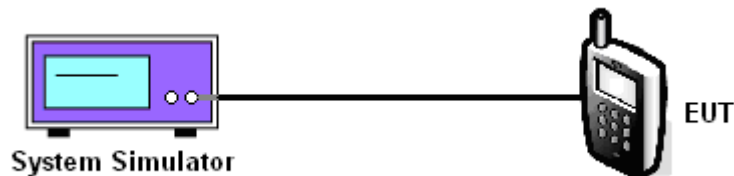



3.1.5 Test Result of Conducted Output Power

| Cellular Band | | | | | | | | | |
|-------------------------|-----------------------|--------------|---------------|-----------------------|--------------|---------------|-----------------------------|---------------|----------------|
| Modes | GSM850 (GPRS class 8) | | | GSM850 (EDGE class 8) | | | WCDMA Band V (RMC 12.2Kbps) | | |
| Channel | 128 (Low) | 189 (Mid) | 251 (High) | 128 (Low) | 189 (Mid) | 251 (High) | 4132 (Low) | 4182 (Mid) | 4233 (High) |
| Frequency (MHz) | 824.2 | 836.4 | 848.8 | 824.2 | 836.4 | 848.8 | 826.4 | 836.4 | 846.6 |
| Conducted Power (dBm) | 32.81 | 32.72 | 32.92 | 27.32 | 27.38 | 27.34 | 23.25 | 23.12 | 23.24 |
| Conducted Power (Watts) | 1.91 | 1.87 | 1.96 | 0.54 | 0.55 | 0.54 | 0.21 | 0.21 | 0.21 |

| PCS Band | | | | | | | | | |
|-------------------------|------------------------|--------------|---------------|------------------------|--------------|---------------|------------------------------|---------------|----------------|
| Modes | GSM1900 (GPRS class 8) | | | GSM1900 (EDGE class 8) | | | WCDMA Band II (RMC 12.2Kbps) | | |
| Channel | 512 (Low) | 661 (Mid) | 810 (High) | 512 (Low) | 661 (Mid) | 810 (High) | 9262 (Low) | 9400 (Mid) | 9538 (High) |
| Frequency (MHz) | 1850.2 | 1880 | 1909.8 | 1850.2 | 1880 | 1909.8 | 1852.4 | 1880 | 1907.6 |
| Conducted Power (dBm) | 29.81 | 29.94 | 29.82 | 26.49 | 26.44 | 26.43 | 23.00 | 23.09 | 23.13 |
| Conducted Power (Watts) | 0.96 | 0.99 | 0.96 | 0.45 | 0.44 | 0.44 | 0.20 | 0.20 | 0.21 |



| AWS Band | | | |
|-------------------------|------------------------------|------------|-------------|
| Modes | WCDMA Band IV (RMC 12.2Kbps) | | |
| Channel | 1312(Low) | 1413 (Mid) | 1513 (High) |
| Frequency (MHz) | 1712.4 | 1732.6 | 1752.6 |
| Conducted Power (dBm) | 23.22 | 23.17 | 23.29 |
| Conducted Power (Watts) | 0.21 | 0.21 | 0.21 |

Note: maximum burst average power for GSM, and maximum average power for WCDMA.

3.2 Peak-to-Average Ratio

3.2.1 Description of the PAR Measurement

The peak-to-average ratio (PAR) of the transmission may not exceed 13 dB.

3.2.2 Measuring Instruments

The measuring equipment is listed in the section 4 of this test report.

3.2.3 Test Procedures

1. The EUT was connected to spectrum analyzer and system simulator via a power divider.
2. Set EUT to transmit at maximum output power.
3. When the duty cycle is less than 98%, then signal gating will be implemented on the spectrum analyzer by triggering from the system simulator.
4. Set the CCDF (Complementary Cumulative Distribution Function) option of the spectrum analyzer.

Record the maximum PAPR level associated with a probability of 0.1%.

3.2.4 Test Setup

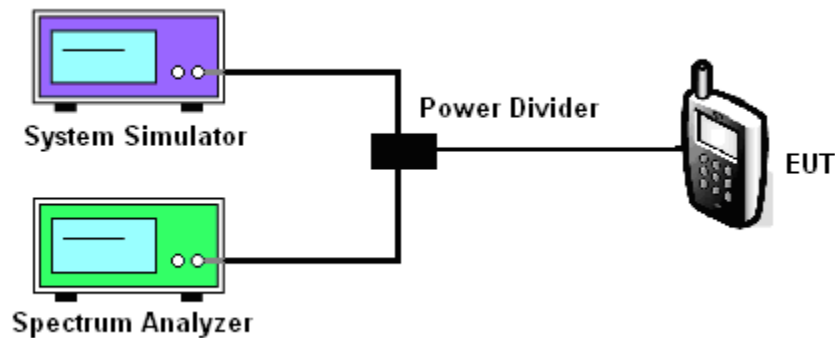



3.2.5 Test Result of Peak-to-Average Ratio

| Cellular Band | | | | | | | | | |
|----------------------------|-----------------------|--------------|---------------|-----------------------|--------------|---------------|-----------------------------|---------------|----------------|
| Modes | GSM850 (GPRS class 8) | | | GSM850 (EDGE class 8) | | | WCDMA Band V (RMC 12.2Kbps) | | |
| Channel | 128 (Low) | 189 (Mid) | 251 (High) | 128 (Low) | 189 (Mid) | 251 (High) | 4132 (Low) | 4182 (Mid) | 4233 (High) |
| Frequency (MHz) | 824.2 | 836.4 | 848.8 | 824.2 | 836.4 | 848.8 | 826.4 | 836.4 | 846.6 |
| Peak-to-Average Ratio (dB) | 0.28 | 0.32 | 0.28 | 3.36 | 3.12 | 3.24 | 3.00 | 2.92 | 3.12 |

| PCS Band | | | | | | | | | |
|----------------------------|------------------------|--------------|---------------|------------------------|--------------|---------------|------------------------------|---------------|----------------|
| Modes | GSM1900 (GPRS class 8) | | | GSM1900 (EDGE class 8) | | | WCDMA Band II (RMC 12.2Kbps) | | |
| Channel | 512 (Low) | 661 (Mid) | 810 (High) | 512 (Low) | 661 (Mid) | 810 (High) | 9262 (Low) | 9400 (Mid) | 9538 (High) |
| Frequency (MHz) | 1850.2 | 1880 | 1909.8 | 1850.2 | 1880 | 1909.8 | 1852.4 | 1880 | 1907.6 |
| Peak-to-Average Ratio (dB) | 0.32 | 0.28 | 0.28 | 3.72 | 3.60 | 3.60 | 2.60 | 3.00 | 2.88 |

| AWS Band | | | |
|----------------------------|------------------------------|------------|-------------|
| Modes | WCDMA Band IV (RMC 12.2Kbps) | | |
| Channel | 1312(Low) | 1413 (Mid) | 1513 (High) |
| Frequency (MHz) | 1712.4 | 1732.6 | 1752.6 |
| Peak-to-Average Ratio (dB) | 2.76 | 3.04 | 2.80 |



3.2.6 Test Result (Plots) of Peak-to-Average Ratio

| | | | |
|---------------|---------|--------------------|--------------------------|
| Band : | GSM 850 | Test Mode : | GPRS class 8 Link (GMSK) |
|---------------|---------|--------------------|--------------------------|

Peak-to-Average Ratio on Channel 128 (824.2 MHz)

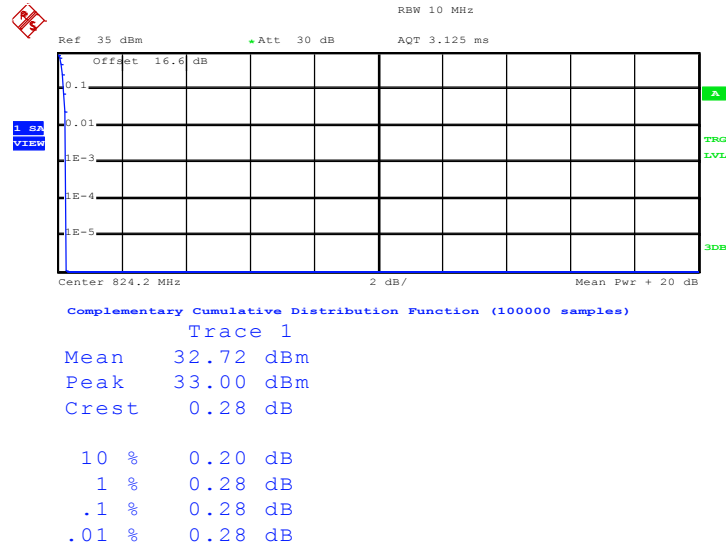

Date: 13.AUG.2014 09:34:24

Peak-to-Average Ratio on Channel 189 (836.4 MHz)

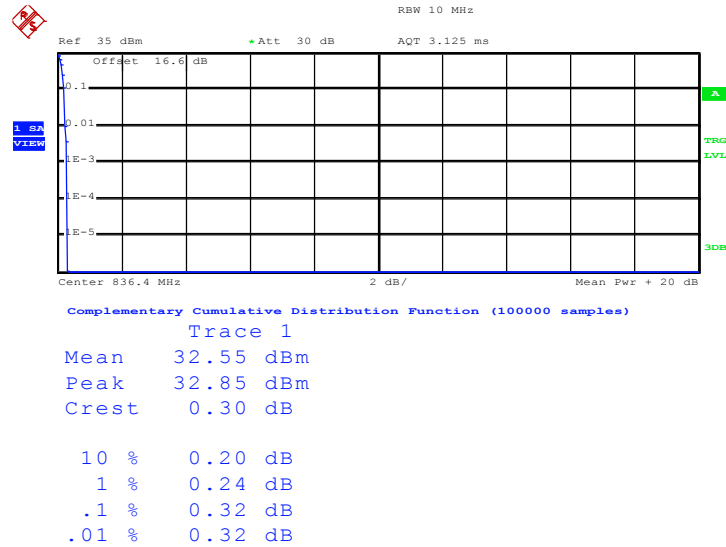

Date: 13.AUG.2014 09:35:06



Peak-to-Average Ratio on Channel 251 (848.8 MHz)

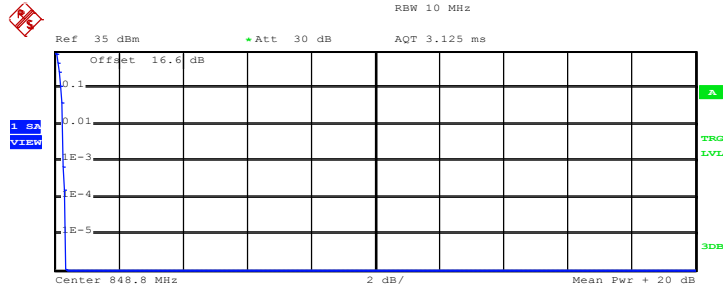

Complementary Cumulative Distribution Function (100000 samples)

Trace 1

| | |
|-------|-----------|
| Mean | 32.95 dBm |
| Peak | 33.28 dBm |
| Crest | 0.33 dB |
| 10 % | 0.20 dB |
| 1 % | 0.28 dB |
| .1 % | 0.28 dB |
| .01 % | 0.32 dB |

Date: 13.AUG.2014 09:35:29



| | | | |
|---------------|---------|--------------------|--------------------------|
| Band : | GSM 850 | Test Mode : | EDGE class 8 Link (8PSK) |
|---------------|---------|--------------------|--------------------------|

Peak-to-Average Ratio on Channel 128 (824.2 MHz)

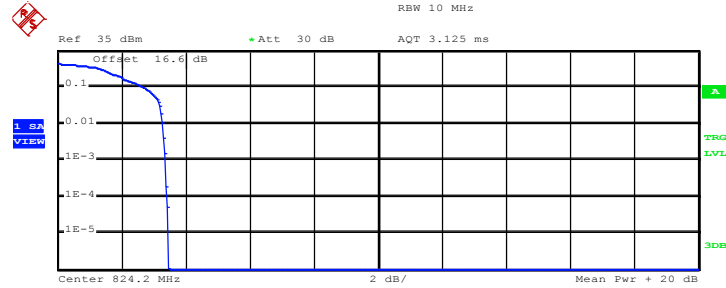

Complementary Cumulative Distribution Function (100000 samples)

Trace 1
Mean 27.43 dBm
Peak 30.88 dBm
Crest 3.45 dB

| | |
|-------|---------|
| 10 % | 2.72 dB |
| 1 % | 3.28 dB |
| .1 % | 3.36 dB |
| .01 % | 3.44 dB |

Date: 13.AUG.2014 10:12:27

Peak-to-Average Ratio on Channel 189 (836.4 MHz)

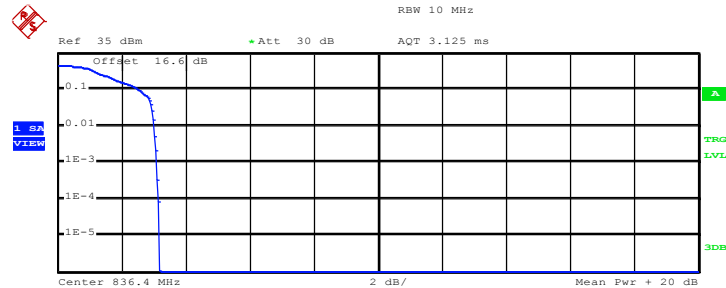

Complementary Cumulative Distribution Function (100000 samples)

Trace 1
Mean 27.36 dBm
Peak 30.53 dBm
Crest 3.17 dB

| | |
|-------|---------|
| 10 % | 2.56 dB |
| 1 % | 3.04 dB |
| .1 % | 3.12 dB |
| .01 % | 3.16 dB |

Date: 13.AUG.2014 10:12:55



Peak-to-Average Ratio on Channel 251 (848.8 MHz)

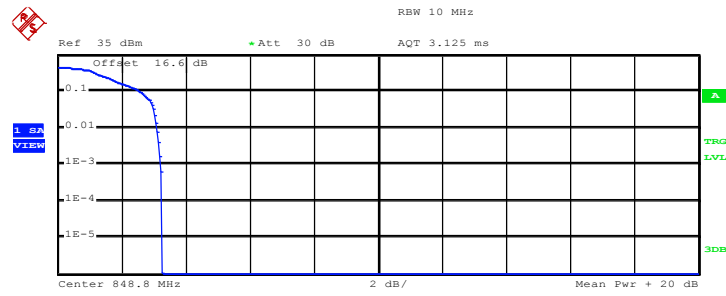

Complementary Cumulative Distribution Function (100000 samples)

Trace 1

Mean 27.25 dBm
 Peak 30.53 dBm
 Crest 3.27 dB

10 % 2.60 dB
 1 % 3.12 dB
 .1 % 3.24 dB
 .01 % 3.28 dB

Date: 13.AUG.2014 10:13:40



| | | | |
|---------------|----------|--------------------|--------------------------|
| Band : | GSM 1900 | Test Mode : | GPRS class 8 Link (GMSK) |
|---------------|----------|--------------------|--------------------------|

Peak-to-Average Ratio on Channel 512 (1850.2 MHz)

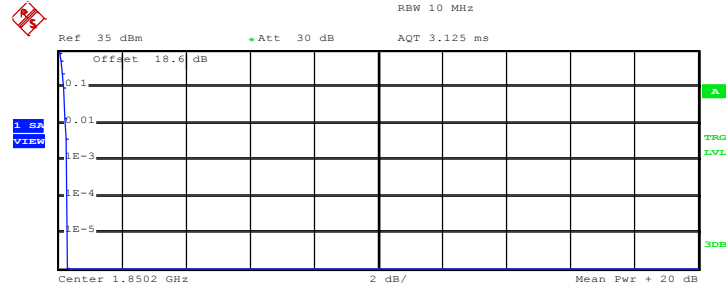

Complementary Cumulative Distribution Function (100000 samples)

Trace 1

| | |
|-------|-----------|
| Mean | 30.44 dBm |
| Peak | 30.74 dBm |
| Crest | 0.29 dB |
| 10 % | 0.20 dB |
| 1 % | 0.24 dB |
| .1 % | 0.32 dB |
| .01 % | 0.32 dB |

Date: 13.AUG.2014 10:34:39

Peak-to-Average Ratio on Channel 661 (1880.0 MHz)

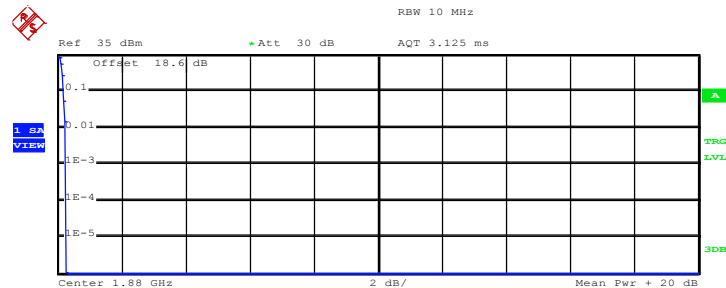

Complementary Cumulative Distribution Function (100000 samples)

Trace 1

| | |
|-------|-----------|
| Mean | 30.62 dBm |
| Peak | 30.88 dBm |
| Crest | 0.25 dB |
| 10 % | 0.20 dB |
| 1 % | 0.24 dB |
| .1 % | 0.28 dB |
| .01 % | 0.28 dB |

Date: 13.AUG.2014 10:35:12



Peak-to-Average Ratio on Channel 810 (1909.8 MHz)

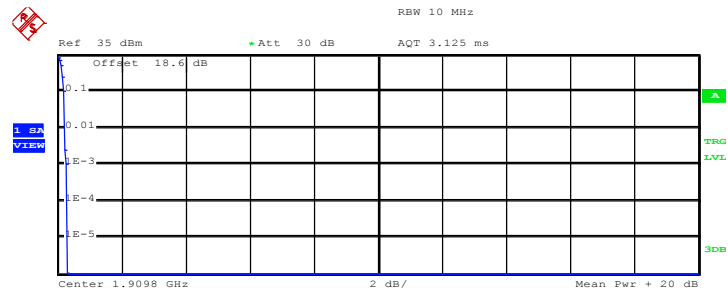

Complementary Cumulative Distribution Function (100000 samples)

Trace 1

| | |
|-------|-----------|
| Mean | 30.22 dBm |
| Peak | 30.53 dBm |
| Crest | 0.31 dB |
| 10 % | 0.20 dB |
| 1 % | 0.24 dB |
| .1 % | 0.28 dB |
| .01 % | 0.32 dB |

Date: 13.AUG.2014 10:35:42



| | | | |
|---------------|----------|--------------------|--------------------------|
| Band : | GSM 1900 | Test Mode : | EDGE class 8 Link (8PSK) |
|---------------|----------|--------------------|--------------------------|

Peak-to-Average Ratio on Channel 512 (1850.2 MHz)

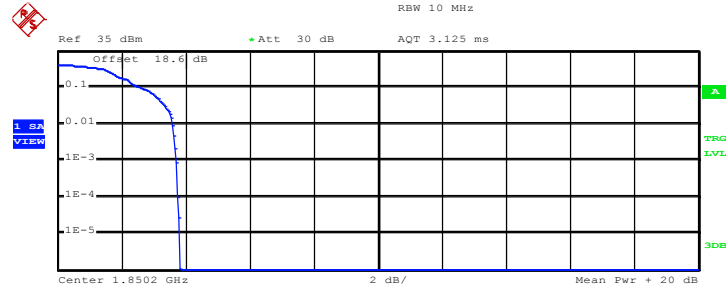

Complementary Cumulative Distribution Function (100000 samples)
 Trace 1
 Mean 26.91 dBm
 Peak 30.74 dBm
 Crest 3.83 dB

| | |
|-------|---------|
| 10 % | 2.68 dB |
| 1 % | 3.60 dB |
| .1 % | 3.72 dB |
| .01 % | 3.76 dB |

Date: 13.AUG.2014 11:08:36

Peak-to-Average Ratio on Channel 661 (1880.0 MHz)

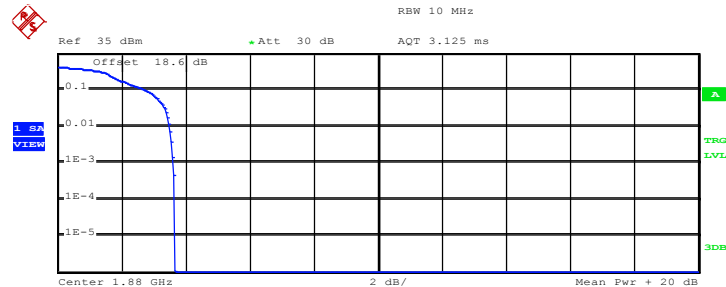

Complementary Cumulative Distribution Function (100000 samples)
 Trace 1
 Mean 27.35 dBm
 Peak 31.02 dBm
 Crest 3.67 dB

| | |
|-------|---------|
| 10 % | 2.80 dB |
| 1 % | 3.52 dB |
| .1 % | 3.60 dB |
| .01 % | 3.68 dB |

Date: 13.AUG.2014 11:09:31



Peak-to-Average Ratio on Channel 810 (1909.8 MHz)

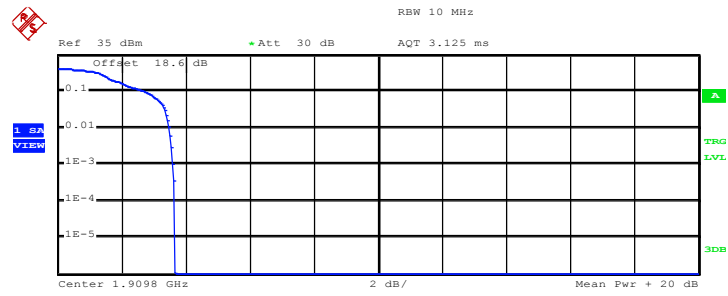

Complementary Cumulative Distribution Function (100000 samples)

Trace 1

Mean 26.71 dBm
 Peak 30.39 dBm
 Crest 3.67 dB

10 % 2.76 dB
 1 % 3.48 dB
 .1 % 3.60 dB
 .01 % 3.68 dB

Date: 13.AUG.2014 11:10:21



| | | | |
|---------------|--------------|--------------------|--------------------------|
| Band : | WCDMA Band V | Test Mode : | RMC 12.2Kbps Link (QPSK) |
|---------------|--------------|--------------------|--------------------------|

Peak-to-Average Ratio on Channel 4132 (826.4 MHz)

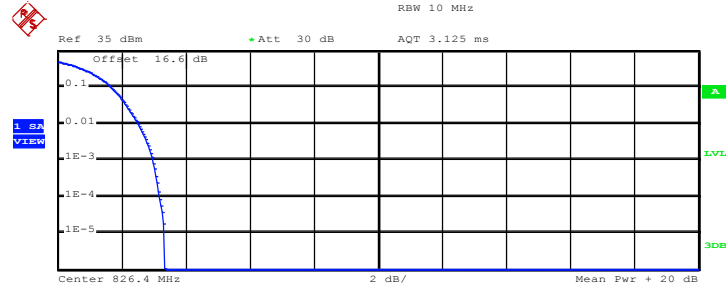

Complementary Cumulative Distribution Function (100000 samples)

Trace 1

| | |
|-------|-----------|
| Mean | 23.44 dBm |
| Peak | 26.79 dBm |
| Crest | 3.35 dB |
| 10 % | 1.68 dB |
| 1 % | 2.52 dB |
| .1 % | 3.00 dB |
| .01 % | 3.20 dB |

Date: 13.AUG.2014 14:01:41

Peak-to-Average Ratio on Channel 4182 (836.4 MHz)

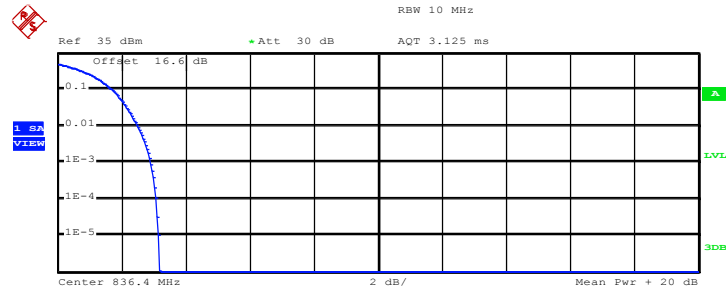

Complementary Cumulative Distribution Function (100000 samples)

Trace 1

| | |
|-------|-----------|
| Mean | 23.40 dBm |
| Peak | 26.58 dBm |
| Crest | 3.17 dB |
| 10 % | 1.72 dB |
| 1 % | 2.52 dB |
| .1 % | 2.92 dB |
| .01 % | 3.08 dB |

Date: 13.AUG.2014 14:02:10



Peak-to-Average Ratio on Channel 4233 (846.6 MHz)

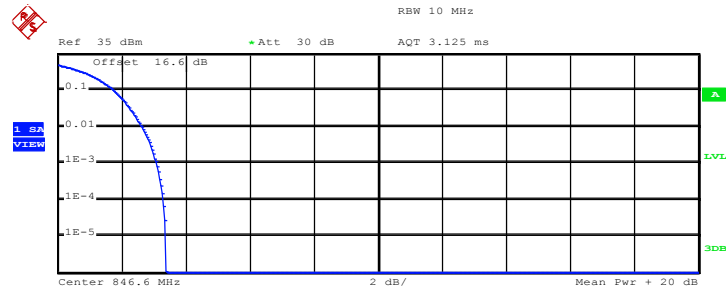

Complementary Cumulative Distribution Function (100000 samples)

Trace 1

Mean 23.61 dBm
 Peak 27.00 dBm
 Crest 3.39 dB

10 % 1.76 dB
 1 % 2.64 dB
 .1 % 3.12 dB
 .01 % 3.32 dB

Date: 13.AUG.2014 14:03:02



| | | | |
|---------------|---------------|--------------------|--------------------------|
| Band : | WCDMA Band IV | Test Mode : | RMC 12.2Kbps Link (QPSK) |
|---------------|---------------|--------------------|--------------------------|

Peak-to-Average Ratio on Channel 1312 (1712.4 MHz)

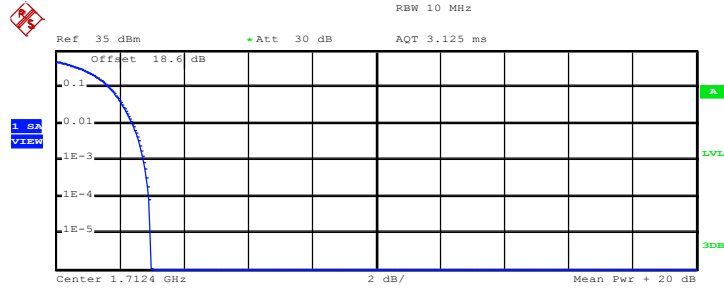

Complementary Cumulative Distribution Function (100000 samples)
 Trace 1
 Mean 23.69 dBm
 Peak 26.65 dBm
 Crest 2.96 dB

| | |
|-------|---------|
| 10 % | 1.68 dB |
| 1 % | 2.40 dB |
| .1 % | 2.76 dB |
| .01 % | 2.92 dB |

Date: 13.AUG.2014 13:37:31

Peak-to-Average Ratio on Channel 1413 (1732.6 MHz)

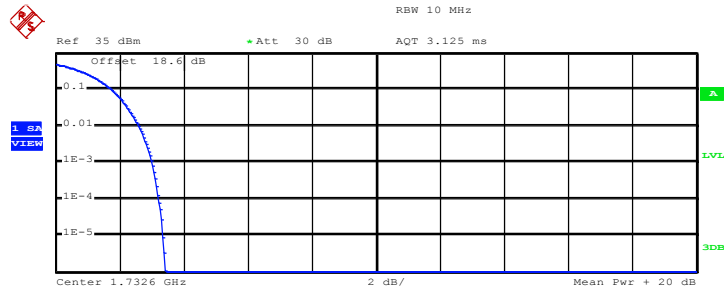

Complementary Cumulative Distribution Function (100000 samples)
 Trace 1
 Mean 23.51 dBm
 Peak 26.93 dBm
 Crest 3.42 dB

| | |
|-------|---------|
| 10 % | 1.76 dB |
| 1 % | 2.60 dB |
| .1 % | 3.04 dB |
| .01 % | 3.24 dB |

Date: 13.AUG.2014 13:38:16



Peak-to-Average Ratio on Channel 1513 (1752.6 MHz)

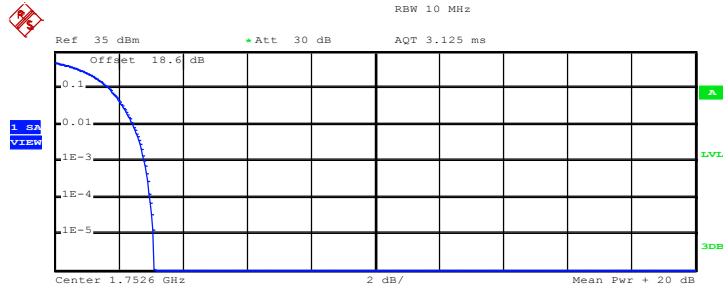

Complementary Cumulative Distribution Function (100000 samples)

Trace 1

Mean 23.76 dBm
 Peak 26.86 dBm
 Crest 3.10 dB

10 % 1.72 dB
 1 % 2.44 dB
 .1 % 2.80 dB
 .01 % 3.00 dB

Date: 13.AUG.2014 13:38:49



| | | | |
|---------------|---------------|--------------------|--------------------------|
| Band : | WCDMA Band II | Test Mode : | RMC 12.2Kbps Link (QPSK) |
|---------------|---------------|--------------------|--------------------------|

Peak-to-Average Ratio on Channel 9262 (1852.4 MHz)

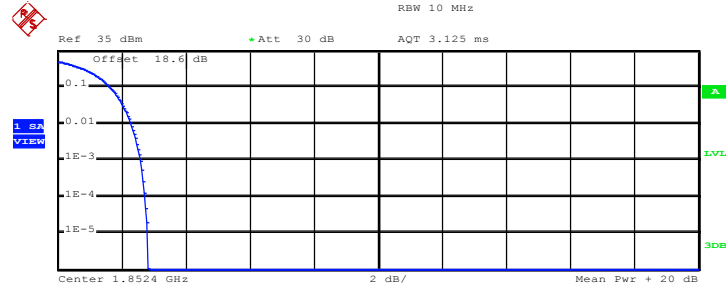

Complementary Cumulative Distribution Function (100000 samples)
Trace 1

| | |
|-------|-----------|
| Mean | 24.17 dBm |
| Peak | 27.00 dBm |
| Crest | 2.82 dB |
| 10 % | 1.64 dB |
| 1 % | 2.32 dB |
| .1 % | 2.60 dB |
| .01 % | 2.72 dB |

Date: 13.AUG.2014 11:38:57

Peak-to-Average Ratio on Channel 9400 (1880.0 MHz)

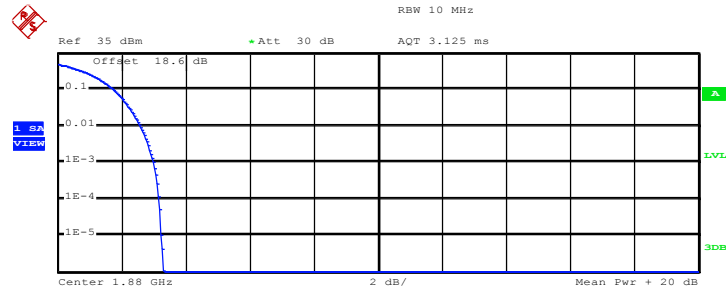

Complementary Cumulative Distribution Function (100000 samples)
Trace 1

| | |
|-------|-----------|
| Mean | 24.12 dBm |
| Peak | 27.42 dBm |
| Crest | 3.30 dB |
| 10 % | 1.76 dB |
| 1 % | 2.60 dB |
| .1 % | 3.00 dB |
| .01 % | 3.16 dB |

Date: 13.AUG.2014 11:39:55



Peak-to-Average Ratio on Channel 9538 (1907.6 MHz)

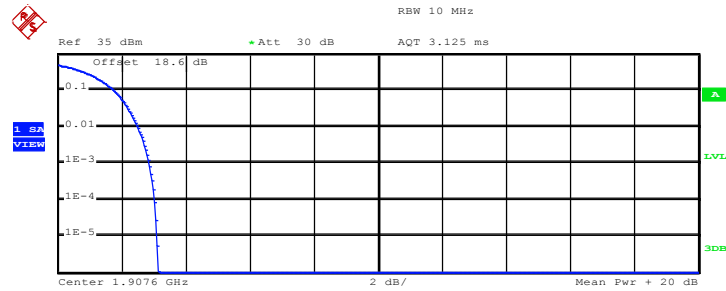

Complementary Cumulative Distribution Function (100000 samples)

Trace 1

Mean 23.59 dBm
 Peak 26.72 dBm
 Crest 3.12 dB

10 % 1.76 dB
 1 % 2.52 dB
 .1 % 2.88 dB
 .01 % 3.04 dB

Date: 13.AUG.2014 11:40:38



3.3 Effective Radiated Power and Effective Isotropic Radiated Power Measurement

3.3.1 Description of the ERP/EIRP Measurement

The substitution method, in ANSI / TIA / EIA-603-C-2004, was used for ERP/EIRP measurement, and the spectrum analyzer configuration follows KDB 971168 D01 Power Meas. License Digital Systems v02r01. The ERP of mobile transmitters must not exceed 7 Watts (Cellular Band) and the EIRP of mobile transmitters are limited to 2 Watts (PCS Band) and 1 Watts (AWS Band).

3.3.2 Measuring Instruments

The measuring equipment is listed in the section 4 of this test report.

3.3.3 Test Procedures

1. The testing follows FCC KDB 971168 v02r01 Section 5.2.1. (for CDMA/WCDMA), Section 5.2.2.2 (for GSM/GPRS/EDGE) and ANSI / TIA-603-C-2004 Section 2.2.17.
2. The EUT was placed on a turntable 1.5 meters high in a fully anechoic chamber.
3. The EUT was placed 3 meters from the receiving antenna, which was mounted on the antenna tower.
4. GSM operating modes: Set RBW= 1MHz, VBW= 3MHz, RMS detector over burst;
UMTS operating modes: Set RBW= 100 kHz, VBW= 300 kHz, RMS detector over frame, and use channel power option with bandwidth=5MHz, per KDB 971168 D01.
5. The table was rotated 360 degrees to determine the position of the highest radiated power.
6. The height of the receiving antenna is adjusted to look for the maximum ERP/EIRP.
7. Taking the record of maximum ERP/EIRP.
8. A dipole antenna was substituted in place of the EUT and was driven by a signal generator.
9. The conducted power at the terminal of the dipole antenna is measured.
10. Repeat step 3 to step 5 to get the maximum ERP/EIRP of the substitution antenna.
11. $ERP/EIRP = P_s + E_t - E_s + G_s = P_s + R_t - R_s + G_s$

P_s (dBm) : Input power to substitution antenna.

G_s (dBi or dBd) : Substitution antenna Gain.

$E_t = R_t + AF$

$E_s = R_s + AF$

AF (dB/m) : Receive antenna factor

R_t : The highest received signal in spectrum analyzer for EUT.

R_s : The highest received signal in spectrum analyzer for substitution antenna.

3.3.4 Test Setup

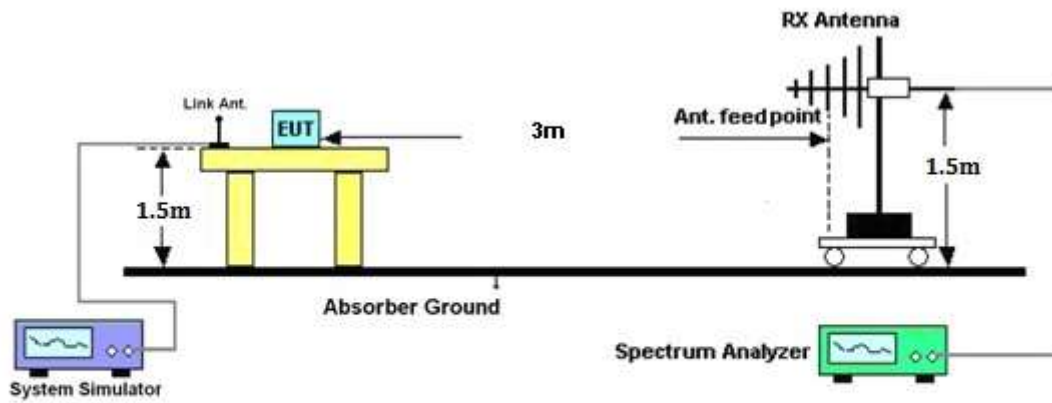



3.3.5 Test Result of ERP

| GSM850 (GPRS class 8) Radiated Power ERP | | | | | | |
|--|----------|----------|----------|----------|-----------|---------|
| Horizontal Polarization | | | | | | |
| Frequency (MHz) | Rt (dBm) | Rs (dBm) | Ps (dBm) | Gs (dBd) | ERP (dBm) | ERP (W) |
| 824.20 | -28.42 | -48.12 | 0.00 | -1.08 | 18.62 | 0.07 |
| 836.40 | -28.82 | -48.28 | 0.00 | -0.93 | 18.53 | 0.07 |
| 848.80 | -29.55 | -48.35 | 0.00 | -0.76 | 18.04 | 0.06 |
| Vertical Polarization | | | | | | |
| Frequency (MHz) | Rt (dBm) | Rs (dBm) | Ps (dBm) | Gs (dBd) | ERP (dBm) | ERP (W) |
| 824.20 | -18.87 | -47.97 | 0.00 | -1.08 | 28.02 | 0.63 |
| 836.40 | -19.67 | -48.01 | 0.00 | -0.93 | 27.41 | 0.55 |
| 848.80 | -19.59 | -48.05 | 0.00 | -0.76 | 27.70 | 0.59 |

| GSM850 (EDGE class 8) Radiated Power ERP | | | | | | |
|--|----------|----------|----------|----------|-----------|---------|
| Horizontal Polarization | | | | | | |
| Frequency (MHz) | Rt (dBm) | Rs (dBm) | Ps (dBm) | Gs (dBd) | ERP (dBm) | ERP (W) |
| 824.20 | -30.67 | -48.12 | 0.00 | -1.08 | 16.37 | 0.04 |
| 836.40 | -30.90 | -48.28 | 0.00 | -0.93 | 16.45 | 0.04 |
| 848.80 | -31.71 | -48.35 | 0.00 | -0.76 | 15.88 | 0.04 |
| Vertical Polarization | | | | | | |
| Frequency (MHz) | Rt (dBm) | Rs (dBm) | Ps (dBm) | Gs (dBd) | ERP (dBm) | ERP (W) |
| 824.20 | -21.20 | -47.97 | 0.00 | -1.08 | 25.69 | 0.37 |
| 836.40 | -22.00 | -48.01 | 0.00 | -0.93 | 25.08 | 0.32 |
| 848.80 | -22.09 | -48.05 | 0.00 | -0.76 | 25.20 | 0.33 |



| WCDMA Band V (RMC 12.2Kbps) Radiated Power ERP | | | | | | |
|--|----------|----------|----------|----------|-----------|---------|
| Horizontal Polarization | | | | | | |
| Frequency (MHz) | Rt (dBm) | Rs (dBm) | Ps (dBm) | Gs (dBd) | ERP (dBm) | ERP (W) |
| 826.40 | -39.05 | -48.12 | 0.00 | -1.08 | 7.99 | 0.01 |
| 836.40 | -39.18 | -48.28 | 0.00 | -0.93 | 8.17 | 0.01 |
| 846.60 | -39.84 | -48.35 | 0.00 | -0.76 | 7.75 | 0.01 |
| Vertical Polarization | | | | | | |
| Frequency (MHz) | Rt (dBm) | Rs (dBm) | Ps (dBm) | Gs (dBd) | ERP (dBm) | ERP (W) |
| 826.40 | -29.84 | -47.97 | 0.00 | -1.08 | 17.05 | 0.05 |
| 836.40 | -29.94 | -48.01 | 0.00 | -0.93 | 17.14 | 0.05 |
| 846.60 | -30.12 | -48.05 | 0.00 | -0.76 | 17.17 | 0.05 |



3.3.6 Test Result of EIRP

| GSM1900 (GPRS class 8) Radiated Power EIRP | | | | | | |
|--|----------|----------|----------|----------|------------|----------|
| Horizontal Polarization | | | | | | |
| Frequency (MHz) | Rt (dBm) | Rs (dBm) | Ps (dBm) | Gs (dBi) | EIRP (dBm) | EIRP (W) |
| 1850.20 | -25.46 | -51.88 | 0.00 | 1.96 | 28.38 | 0.69 |
| 1880.00 | -26.15 | -52.99 | 0.00 | 2.00 | 28.84 | 0.77 |
| 1909.80 | -28.83 | -54.28 | 0.00 | 1.98 | 27.43 | 0.55 |
| Vertical Polarization | | | | | | |
| Frequency (MHz) | Rt (dBm) | Rs (dBm) | Ps (dBm) | Gs (dBi) | EIRP (dBm) | EIRP (W) |
| 1850.20 | -25.11 | -52.13 | 0.00 | 1.96 | 28.98 | 0.79 |
| 1880.00 | -25.71 | -53.17 | 0.00 | 2.00 | 29.46 | 0.88 |
| 1909.80 | -27.32 | -54.13 | 0.00 | 1.98 | 28.79 | 0.76 |

| GSM1900 (EDGE class 8) Radiated Power EIRP | | | | | | |
|--|----------|----------|----------|----------|------------|----------|
| Horizontal Polarization | | | | | | |
| Frequency (MHz) | Rt (dBm) | Rs (dBm) | Ps (dBm) | Gs (dBi) | EIRP (dBm) | EIRP (W) |
| 1850.20 | -25.98 | -51.88 | 0.00 | 1.96 | 27.86 | 0.61 |
| 1880.00 | -27.07 | -52.99 | 0.00 | 2.00 | 27.92 | 0.62 |
| 1909.80 | -29.28 | -54.28 | 0.00 | 1.98 | 26.98 | 0.50 |
| Vertical Polarization | | | | | | |
| Frequency (MHz) | Rt (dBm) | Rs (dBm) | Ps (dBm) | Gs (dBi) | EIRP (dBm) | EIRP (W) |
| 1850.20 | -25.69 | -52.13 | 0.00 | 1.96 | 28.40 | 0.69 |
| 1880.00 | -26.66 | -53.17 | 0.00 | 2.00 | 28.51 | 0.71 |
| 1909.80 | -27.75 | -54.13 | 0.00 | 1.98 | 28.36 | 0.69 |



| WCDMA Band IV (RMC 12.2Kbps) Radiated Power EIRP | | | | | | |
|--|----------|----------|----------|----------|------------|----------|
| Horizontal Polarization | | | | | | |
| Frequency (MHz) | Rt (dBm) | Rs (dBm) | Ps (dBm) | Gs (dBi) | EIRP (dBm) | EIRP (W) |
| 1712.4 | -30.92 | -51.88 | 0.00 | 1.96 | 22.92 | 0.20 |
| 1732.6 | -32.52 | -52.99 | 0.00 | 2.00 | 22.47 | 0.18 |
| 1752.6 | -33.88 | -54.28 | 0.00 | 1.98 | 22.38 | 0.17 |
| Vertical Polarization | | | | | | |
| Frequency (MHz) | Rt (dBm) | Rs (dBm) | Ps (dBm) | Gs (dBi) | EIRP (dBm) | EIRP (W) |
| 1712.4 | -30.53 | -52.13 | 0.00 | 1.96 | 23.56 | 0.23 |
| 1732.6 | -32.31 | -53.17 | 0.00 | 2.00 | 22.86 | 0.19 |
| 1752.6 | -33.05 | -54.13 | 0.00 | 1.98 | 23.06 | 0.20 |

| WCDMA Band II (RMC 12.2Kbps) Radiated Power EIRP | | | | | | |
|--|----------|----------|----------|----------|------------|----------|
| Horizontal Polarization | | | | | | |
| Frequency (MHz) | Rt (dBm) | Rs (dBm) | Ps (dBm) | Gs (dBi) | EIRP (dBm) | EIRP (W) |
| 1852.40 | -32.65 | -51.88 | 0.00 | 1.96 | 21.19 | 0.13 |
| 1880.00 | -34.02 | -52.99 | 0.00 | 2.00 | 20.97 | 0.13 |
| 1907.60 | -36.31 | -54.28 | 0.00 | 1.98 | 19.95 | 0.10 |
| Vertical Polarization | | | | | | |
| Frequency (MHz) | Rt (dBm) | Rs (dBm) | Ps (dBm) | Gs (dBi) | EIRP (dBm) | EIRP (W) |
| 1852.40 | -32.31 | -52.13 | 0.00 | 1.96 | 21.78 | 0.15 |
| 1880.00 | -33.72 | -53.17 | 0.00 | 2.00 | 21.45 | 0.14 |
| 1907.60 | -35.25 | -54.13 | 0.00 | 1.98 | 20.86 | 0.12 |

3.4 99% Occupied Bandwidth and 26dB Bandwidth Measurement

3.4.1 Description of 99% Occupied Bandwidth and 26dB Bandwidth Measurement

The 99% occupied bandwidth is the width of a frequency band such that, below the lower and above the upper frequency limits, the mean powers emitted are each equal to a specified percentage 0.5% of the total mean transmitted power.

The emission bandwidth is defined as the width of the signal between two points, located at the 2 sides of the carrier frequency, outside of which all emissions are attenuated at least 26 dB below the transmitter power.

3.4.2 Measuring Instruments

The measuring equipment is listed in the section 4 of this test report.

3.4.3 Test Procedures

1. The testing follows FCC KDB 971168 v02r01 Section 4.2.
2. The EUT was connected to the spectrum analyzer and system simulator via a power divider.
3. The RF output of the EUT was connected to the spectrum analyzer by RF cable and attenuator. The path loss was compensated to the results for each measurement.
4. The 99% occupied bandwidth were measured, set RBW= 1% of span, VBW= 3*RBW, sample detector, trace maximum hold.
5. The 26dB bandwidth were measured, set RBW= 1% of EBW, VBW= 3*RBW, peak detector, trace maximum hold.

3.4.4 Test Setup

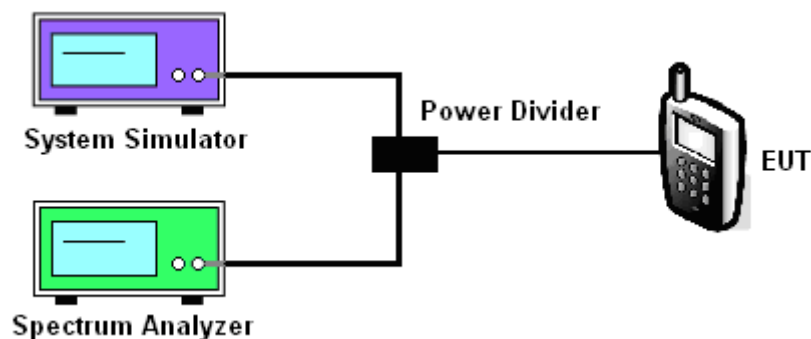



3.4.5 Test Result of Occupied Bandwidth and 26dB Bandwidth

| Cellular Band | | | | | | |
|-----------------|-----------------------|--------------|---------------|-----------------------|--------------|---------------|
| Modes | GSM850 (GPRS class 8) | | | GSM850 (EDGE class 8) | | |
| Channel | 128 (Low) | 189 (Mid) | 251 (High) | 128 (Low) | 189 (Mid) | 251 (High) |
| Frequency (MHz) | 824.2 | 836.4 | 848.8 | 824.2 | 836.4 | 848.8 |
| 99% OBW (kHz) | 246.00 | 250.00 | 244.00 | 244.00 | 246.00 | 244.00 |
| 26dB BW (kHz) | 310.00 | 316.00 | 302.00 | 310.00 | 306.00 | 302.00 |

| PCS Band | | | | | | |
|-----------------|------------------------|--------------|---------------|------------------------|--------------|---------------|
| Modes | GSM1900 (GPRS class 8) | | | GSM1900 (EDGE class 8) | | |
| Channel | 512 (Low) | 661 (Mid) | 810 (High) | 512 (Low) | 661 (Mid) | 810 (High) |
| Frequency (MHz) | 1850.2 | 1880 | 1909.8 | 1850.2 | 1880 | 1909.8 |
| 99% OBW (kHz) | 244.00 | 244.00 | 244.00 | 248.00 | 248.00 | 244.00 |
| 26dB BW (kHz) | 304.00 | 314.00 | 312.00 | 312.00 | 304.00 | 304.00 |

| Cellular Band | | | |
|-----------------|-----------------------------|------------|-------------|
| Modes | WCDMA Band V (RMC 12.2Kbps) | | |
| Channel | 4132 (Low) | 4182 (Mid) | 4233 (High) |
| Frequency (MHz) | 826.4 | 836.4 | 846.6 |
| 99% OBW (MHz) | 4.16 | 4.18 | 4.18 |
| 26dB BW (MHz) | 4.66 | 4.66 | 4.66 |

| AWS Band | | | |
|-----------------|------------------------------|------------|-------------|
| Modes | WCDMA Band IV (RMC 12.2Kbps) | | |
| Channel | 1312(Low) | 1413 (Mid) | 1513 (High) |
| Frequency (MHz) | 1712.4 | 1732.6 | 1752.6 |
| 99% OBW (MHz) | 4.16 | 4.16 | 4.18 |
| 26dB BW (MHz) | 4.68 | 4.68 | 4.68 |



| PCS Band | | | |
|-----------------|------------------------------|------------|-------------|
| Modes | WCDMA Band II (RMC 12.2Kbps) | | |
| Channel | 9262 (Low) | 9400 (Mid) | 9538 (High) |
| Frequency (MHz) | 1852.4 | 1880 | 1907.6 |
| 99% OBW (MHz) | 4.18 | 4.16 | 4.16 |
| 26dB BW (MHz) | 4.68 | 4.68 | 4.68 |



3.4.6 Test Result (Plots) of Occupied Bandwidth and 26dB Bandwidth

| | | | |
|--------|---------|-------------|--------------------------|
| Band : | GSM 850 | Test Mode : | GPRS class 8 Link (GMSK) |
|--------|---------|-------------|--------------------------|

99% Occupied Bandwidth Plot on Channel 128 (824.2 MHz)

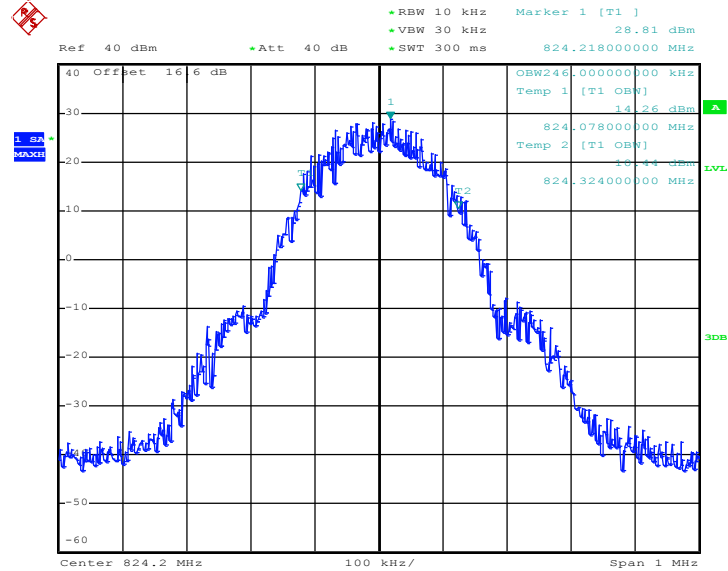

Date: 13.AUG.2014 09:39:44

26dB Bandwidth Plot on Channel 128 (824.2 MHz)

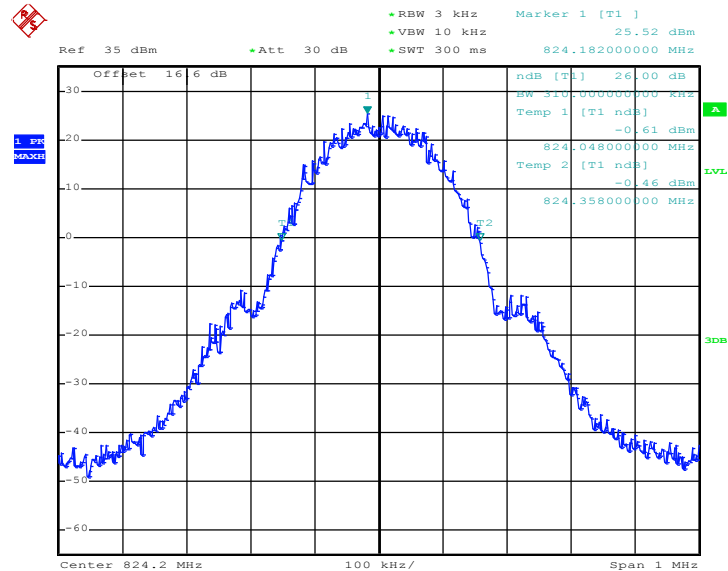

Date: 13.AUG.2014 09:37:31



99% Occupied Bandwidth Plot on Channel 189 (836.4 MHz)

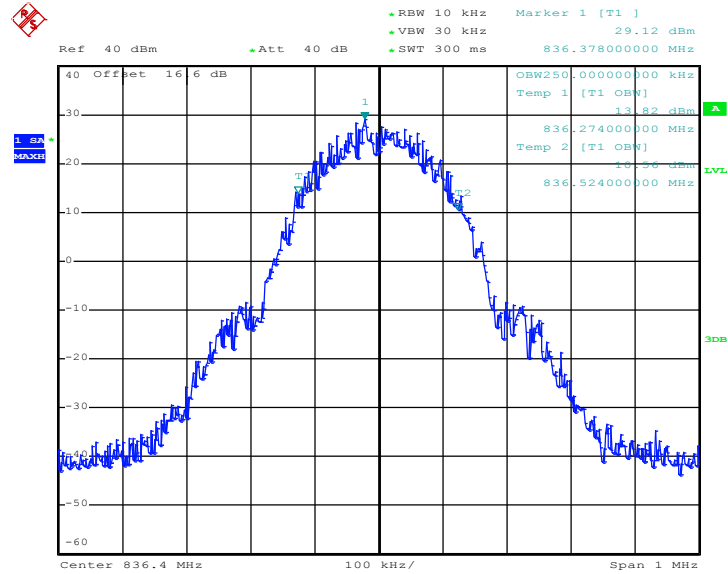

Date: 13.AUG.2014 09:40:18

26dB Bandwidth Plot on Channel 189 (836.4 MHz)

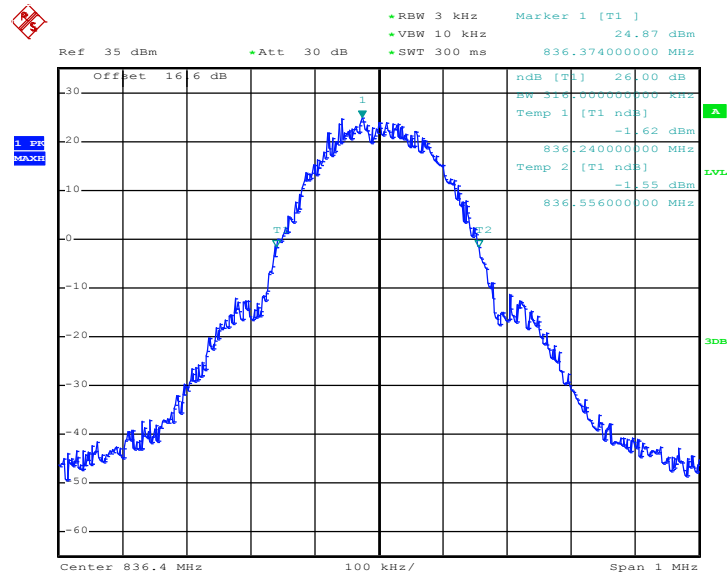

Date: 13.AUG.2014 09:38:12



99% Occupied Bandwidth Plot on Channel 251 (848.8 MHz)

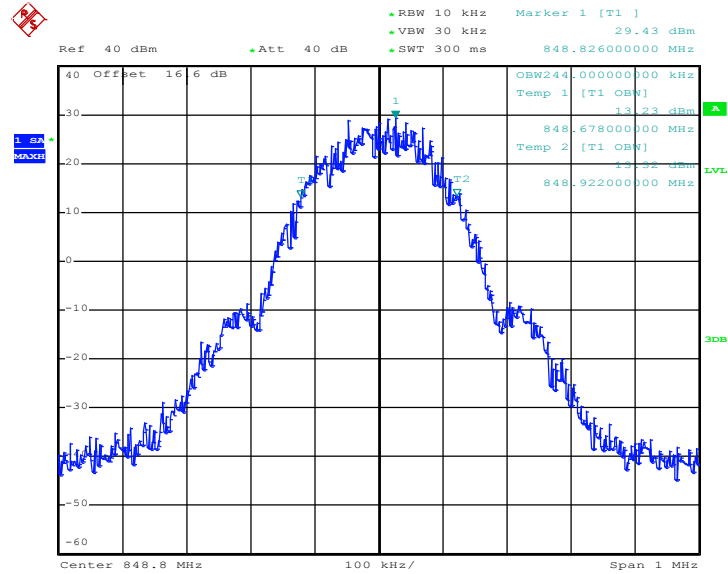

Date: 13.AUG.2014 09:40:52

26dB Bandwidth Plot on Channel 251 (848.8 MHz)

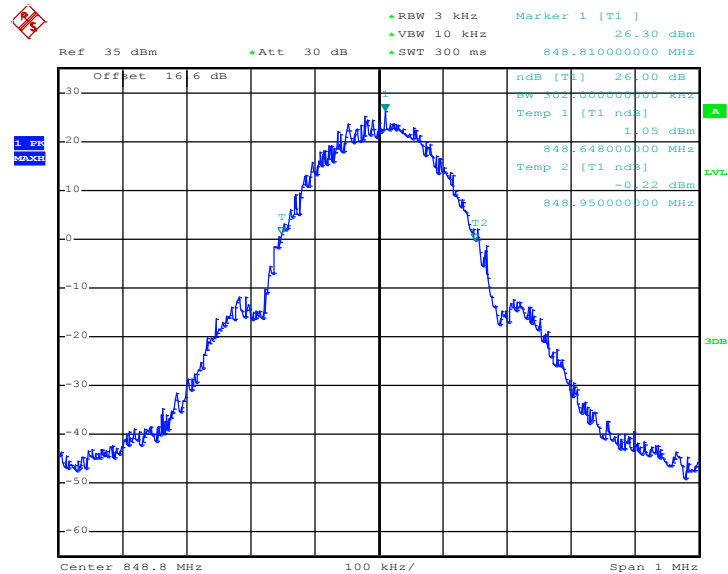

Date: 13.AUG.2014 09:38:45



| | | | |
|---------------|---------|--------------------|--------------------------|
| Band : | GSM 850 | Test Mode : | EDGE class 8 Link (8PSK) |
|---------------|---------|--------------------|--------------------------|

99% Occupied Bandwidth Plot on Channel 128 (824.2 MHz)

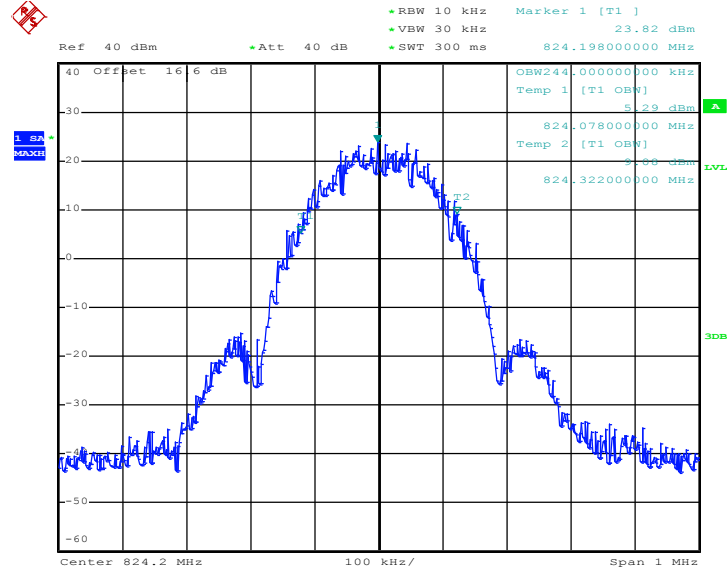

Date: 13.AUG.2014 10:18:26

26dB Bandwidth Plot on Channel 128 (824.2 MHz)

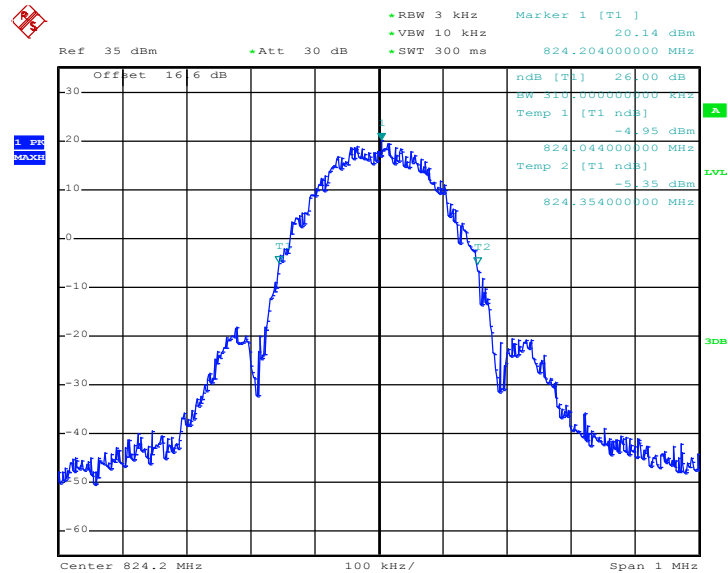

Date: 13.AUG.2014 10:16:04



99% Occupied Bandwidth Plot on Channel 189 (836.4 MHz)

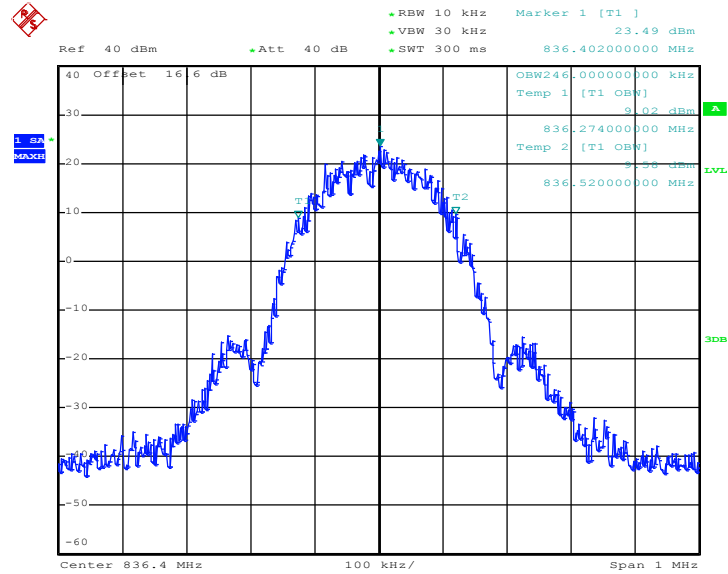

Date: 13.AUG.2014 10:19:00

26dB Bandwidth Plot on Channel 189 (836.4 MHz)

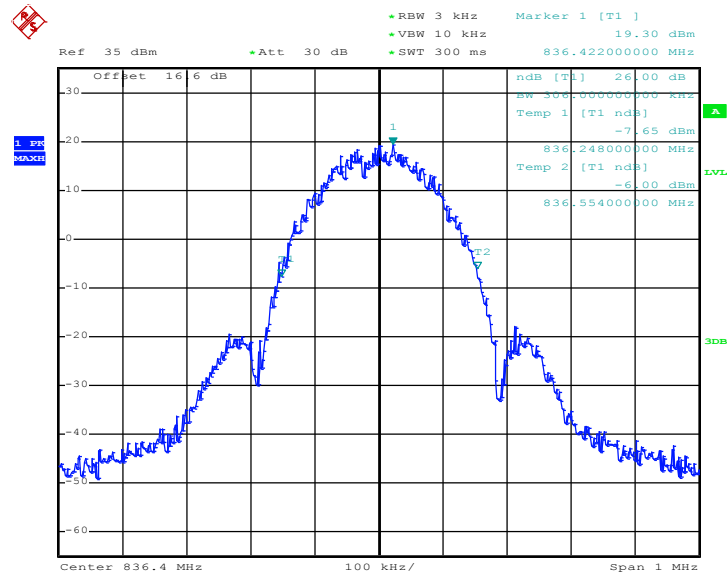

Date: 13.AUG.2014 10:16:39



99% Occupied Bandwidth Plot on Channel 251 (848.8 MHz)

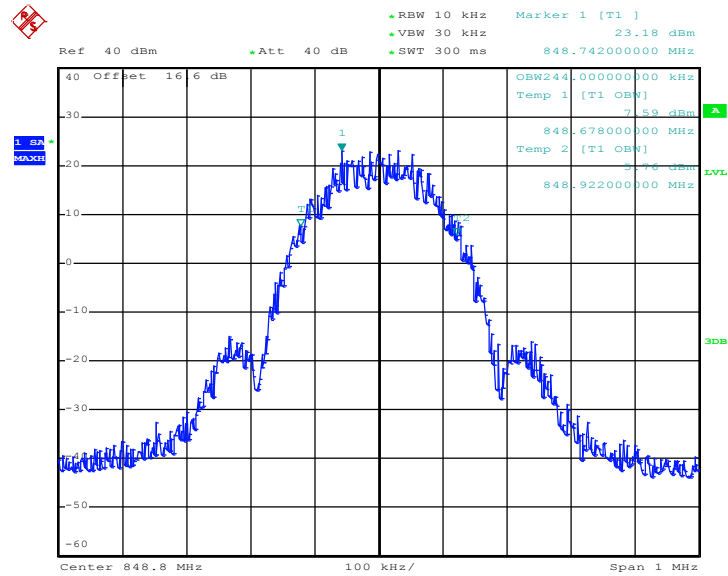

Date: 13.AUG.2014 10:19:34

26dB Bandwidth Plot on Channel 251 (848.8 MHz)

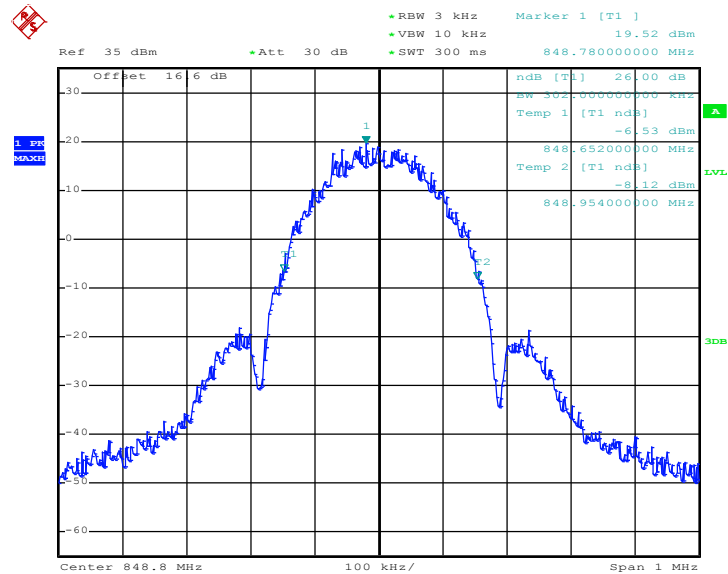

Date: 13.AUG.2014 10:17:16



| | | | |
|---------------|----------|--------------------|--------------------------|
| Band : | GSM 1900 | Test Mode : | GPRS class 8 Link (GMSK) |
|---------------|----------|--------------------|--------------------------|

99% Occupied Bandwidth Plot on Channel 512 (1850.2 MHz)

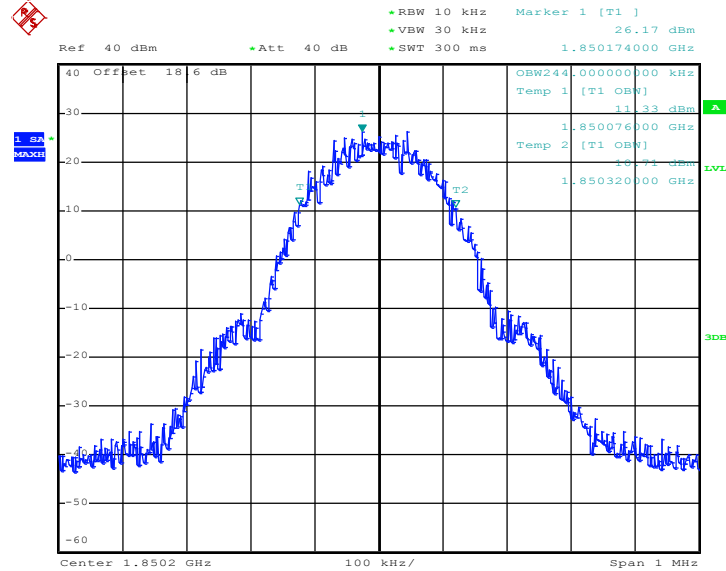

Date: 13.AUG.2014 10:49:30

26dB Bandwidth Plot on Channel 512 (1850.2 MHz)

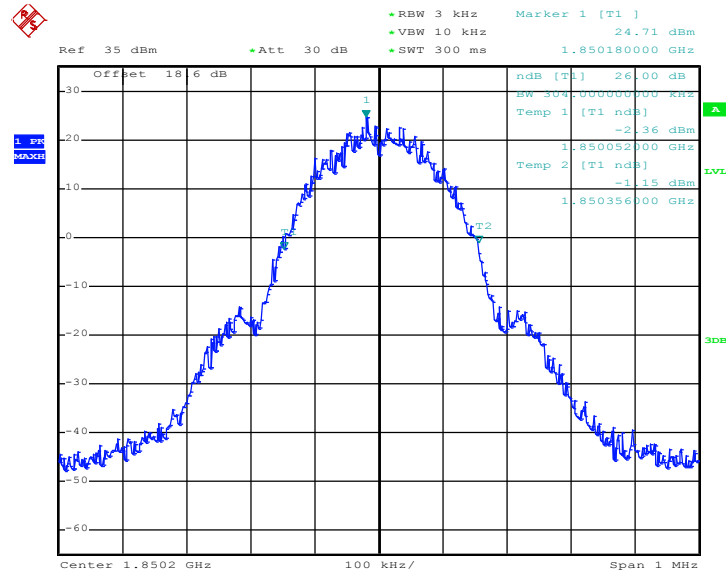

Date: 13.AUG.2014 10:47:21



99% Occupied Bandwidth Plot on Channel 661 (1880.0 MHz)

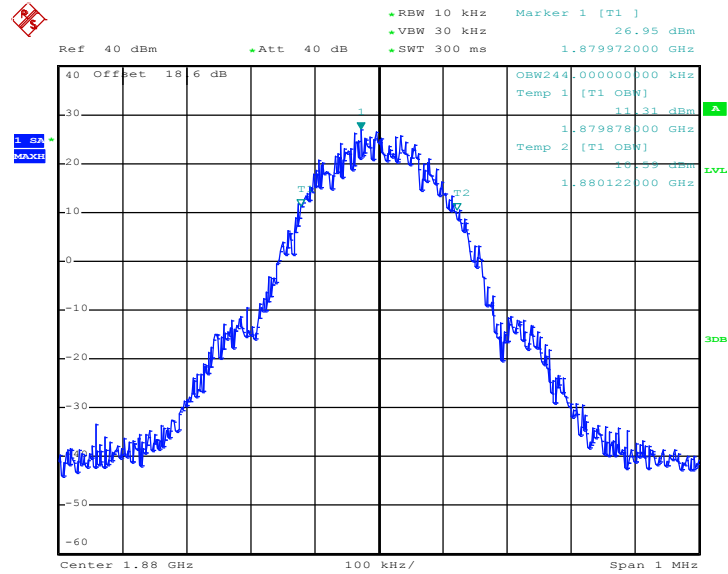

Date: 13.AUG.2014 10:50:04

26dB Bandwidth Plot on Channel 661 (1880.0 MHz)

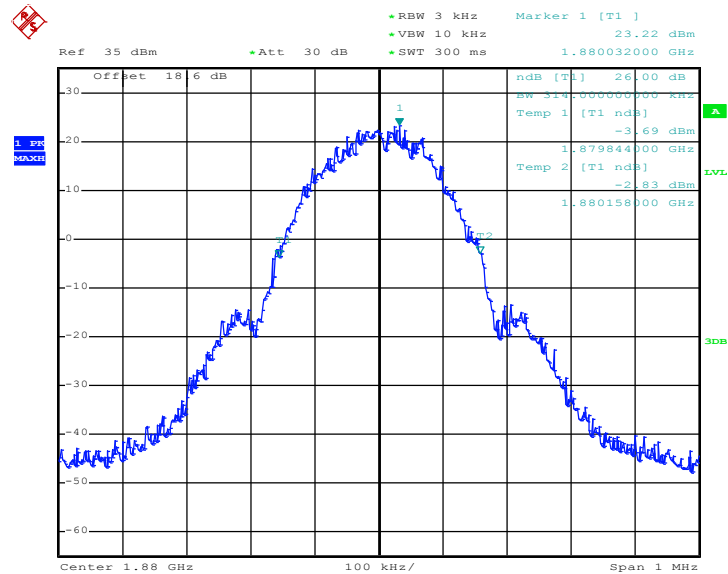

Date: 13.AUG.2014 10:47:55



99% Occupied Bandwidth Plot on Channel 810 (1909.8 MHz)

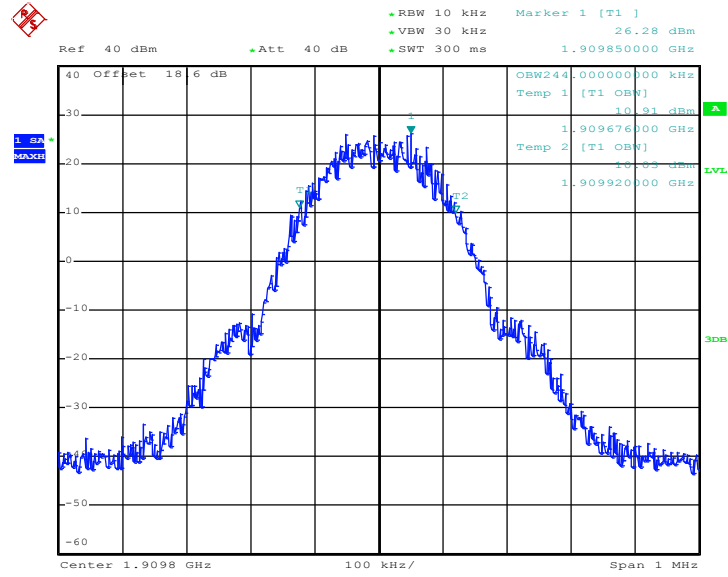

Date: 13.AUG.2014 10:50:39

26dB Bandwidth Plot on Channel 810 (1909.8 MHz)

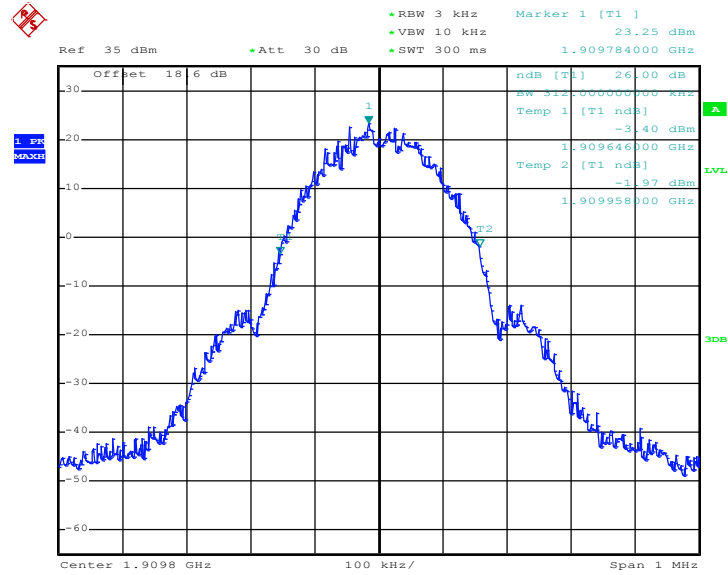

Date: 13.AUG.2014 10:48:29



| | | | |
|---------------|----------|--------------------|--------------------------|
| Band : | GSM 1900 | Test Mode : | EDGE class 8 Link (8PSK) |
|---------------|----------|--------------------|--------------------------|

99% Occupied Bandwidth Plot on Channel 512 (1850.2 MHz)

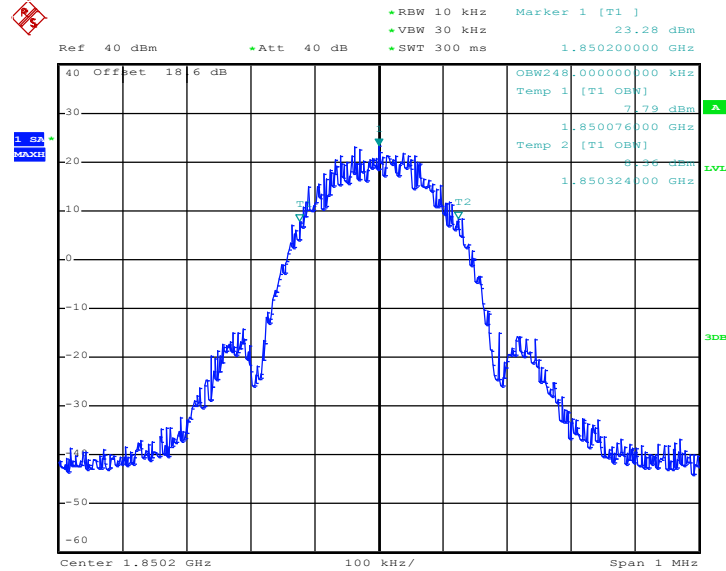

Date: 13.AUG.2014 11:24:38

26dB Bandwidth Plot on Channel 512 (1850.2 MHz)

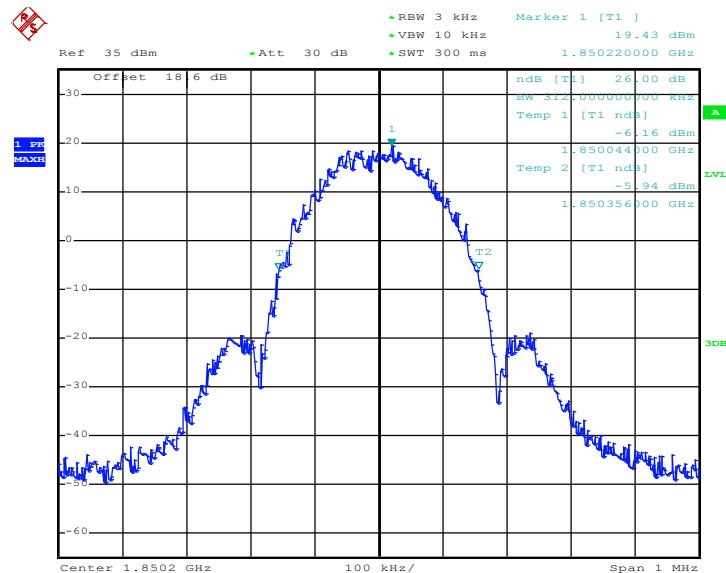

Date: 13.AUG.2014 11:19:52



99% Occupied Bandwidth Plot on Channel 661 (1880.0 MHz)

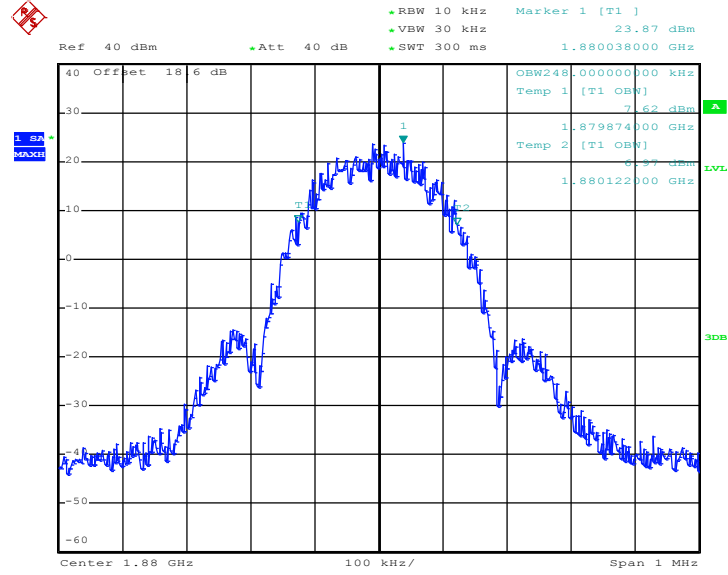

Date: 13.AUG.2014 11:25:21

26dB Bandwidth Plot on Channel 661 (1880.0 MHz)

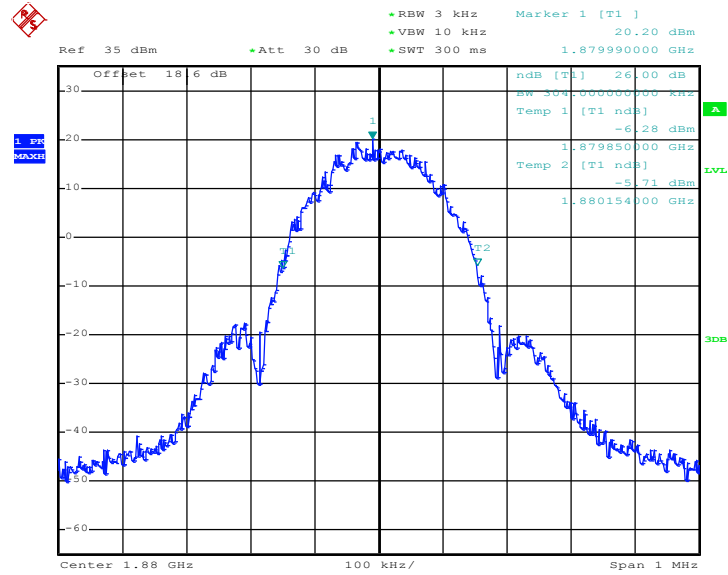

Date: 13.AUG.2014 11:20:29



99% Occupied Bandwidth Plot on Channel 810 (1909.8 MHz)

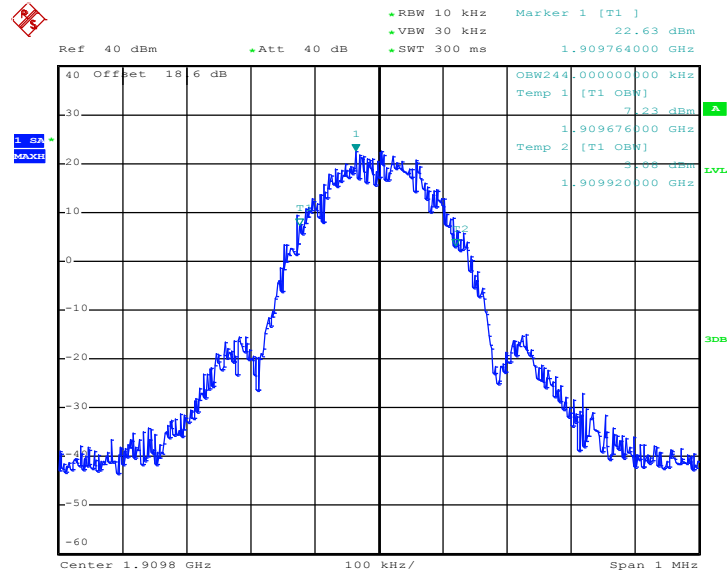

Date: 13.AUG.2014 11:25:59

26dB Bandwidth Plot on Channel 810 (1909.8 MHz)

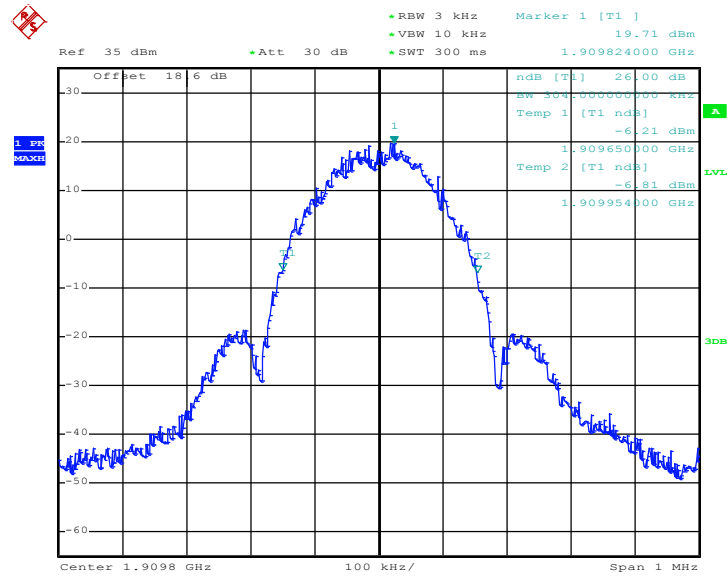

Date: 13.AUG.2014 11:21:07



| | | | |
|--------|--------------|-------------|--------------------------|
| Band : | WCDMA Band V | Test Mode : | RMC 12.2Kbps Link (QPSK) |
|--------|--------------|-------------|--------------------------|

99% Occupied Bandwidth Plot on Channel 4132 (826.4 MHz)

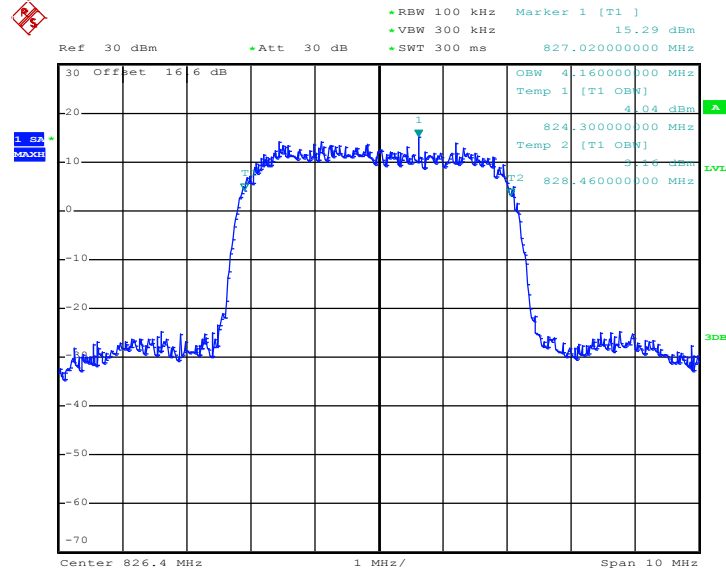

Date: 13.AUG.2014 14:16:10

26dB Bandwidth Plot on Channel 4132 (826.4 MHz)

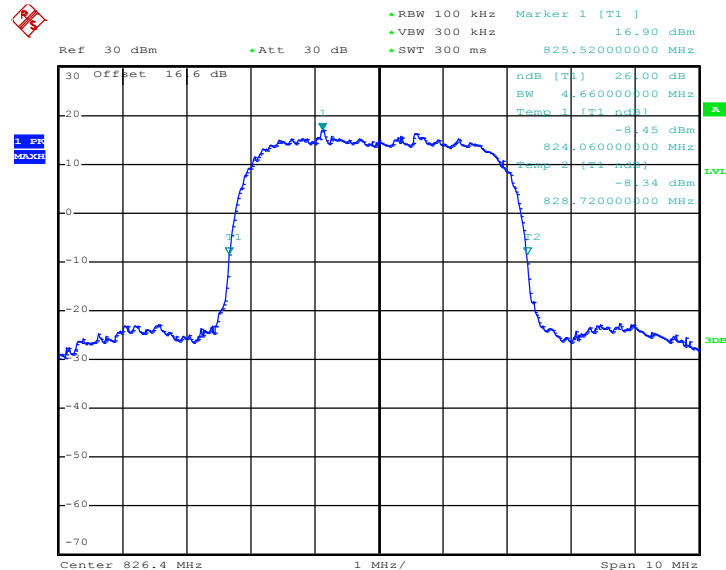

Date: 13.AUG.2014 14:13:03



99% Occupied Bandwidth Plot on Channel 4182 (836.4 MHz)

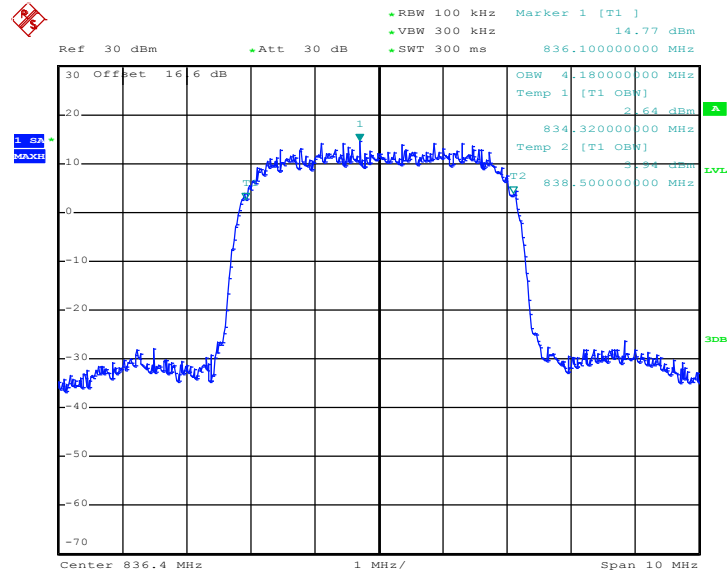

Date: 13.AUG.2014 14:16:38

26dB Bandwidth Plot on Channel 4182 (836.4 MHz)

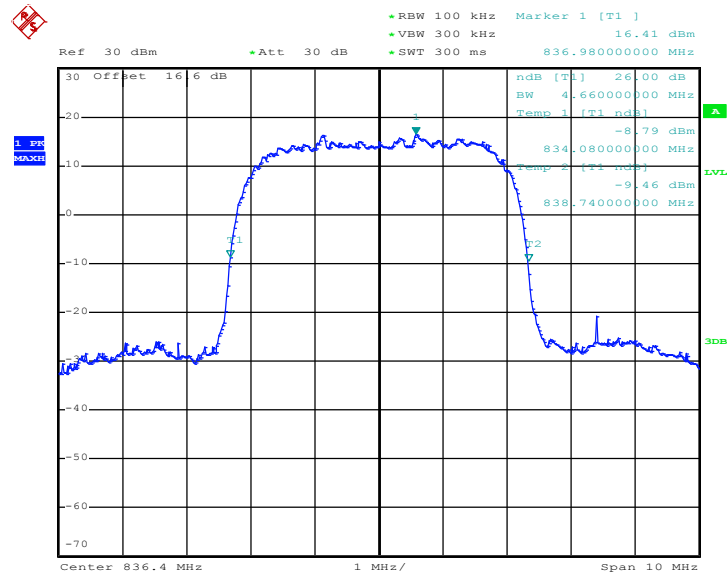

Date: 13.AUG.2014 14:13:31



99% Occupied Bandwidth Plot on Channel 4233 (846.6 MHz)

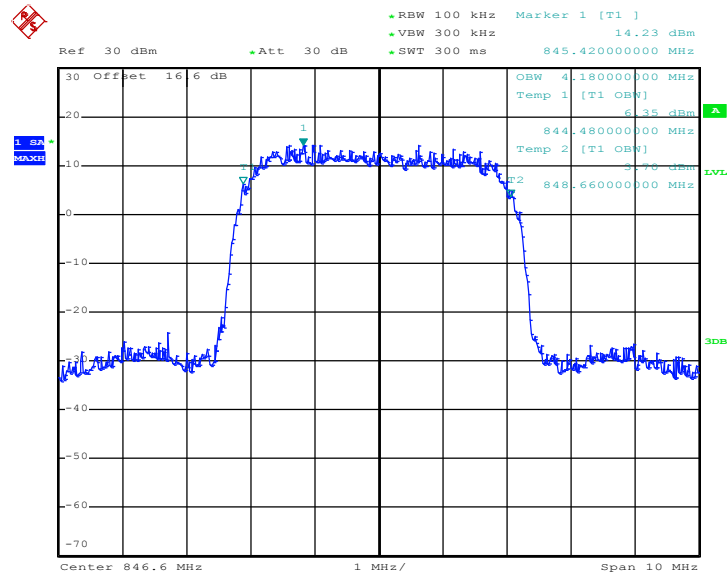

Date: 13.AUG.2014 14:17:07

26dB Bandwidth Plot on Channel 4233 (846.6 MHz)

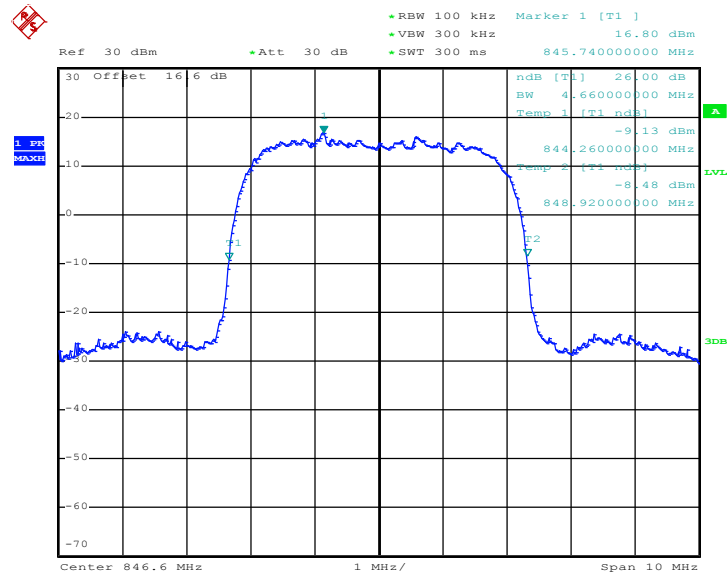

Date: 13.AUG.2014 14:14:00



| | | | |
|---------------|---------------|--------------------|--------------------------|
| Band : | WCDMA Band IV | Test Mode : | RMC 12.2Kbps Link (QPSK) |
|---------------|---------------|--------------------|--------------------------|

99% Occupied Bandwidth Plot on Channel 1312 (1712.4 MHz)

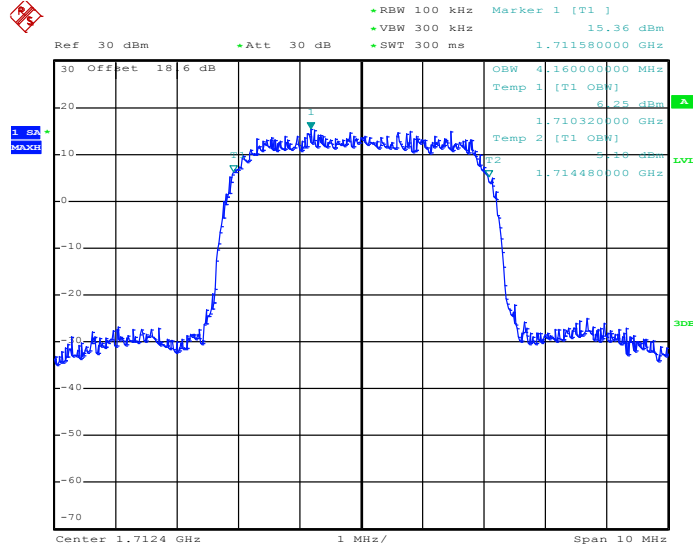

Date: 13.AUG.2014 13:44:46

26dB Bandwidth Plot on Channel 1312 (1712.4 MHz)

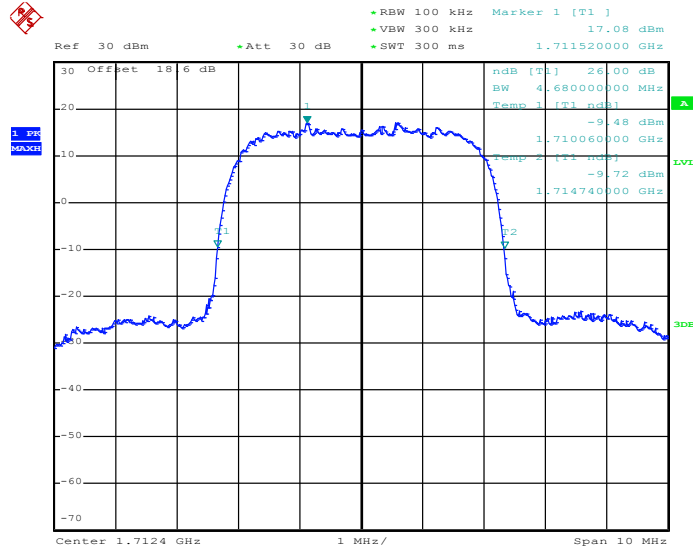

Date: 13.AUG.2014 13:42:09



99% Occupied Bandwidth Plot on Channel 1413 (1732.6 MHz)

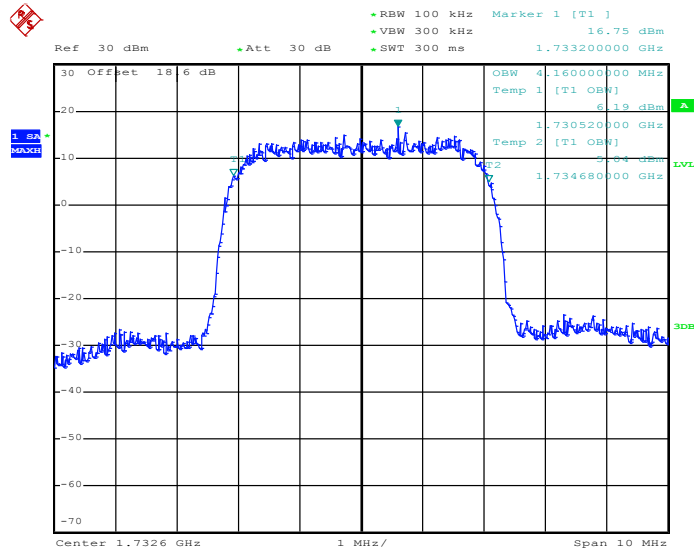

Date: 13.AUG.2014 13:45:15

26dB Bandwidth Plot on Channel 1413 (1732.6 MHz)

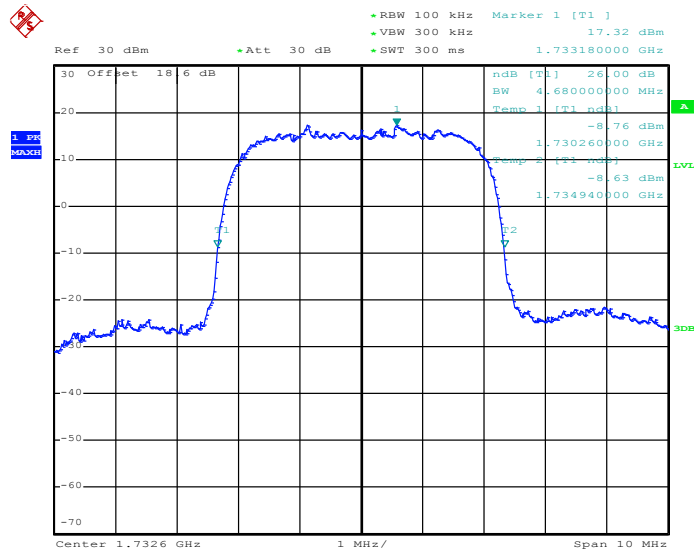

Date: 13.AUG.2014 13:42:38



99% Occupied Bandwidth Plot on Channel 1513 (1752.6 MHz)

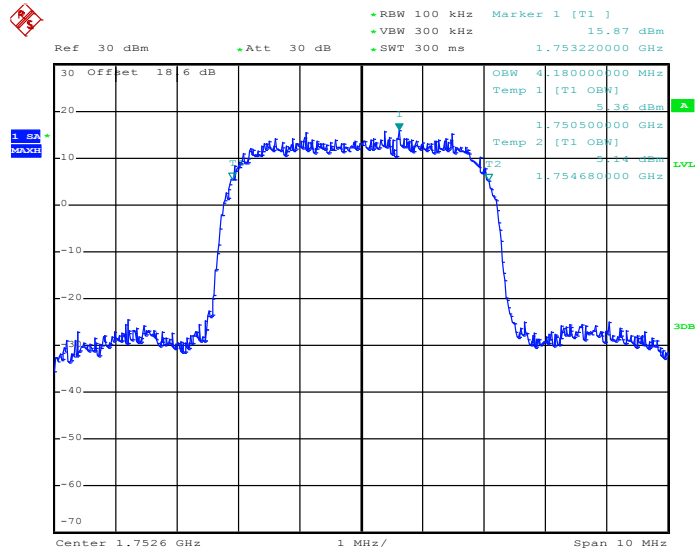

Date: 13.AUG.2014 13:45:43

26dB Bandwidth Plot on Channel 1513 (1752.6 MHz)

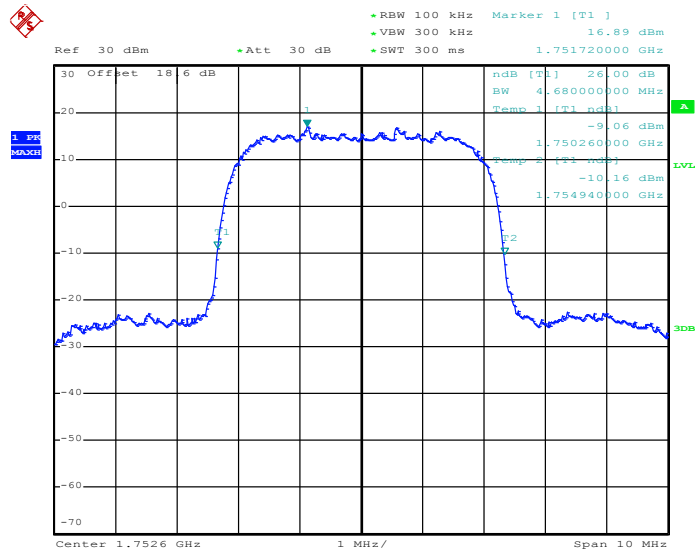

Date: 13.AUG.2014 13:43:06



| | | | |
|--------|---------------|-------------|--------------------------|
| Band : | WCDMA Band II | Test Mode : | RMC 12.2Kbps Link (QPSK) |
|--------|---------------|-------------|--------------------------|

99% Occupied Bandwidth Plot on Channel 9262 (1852.4 MHz)

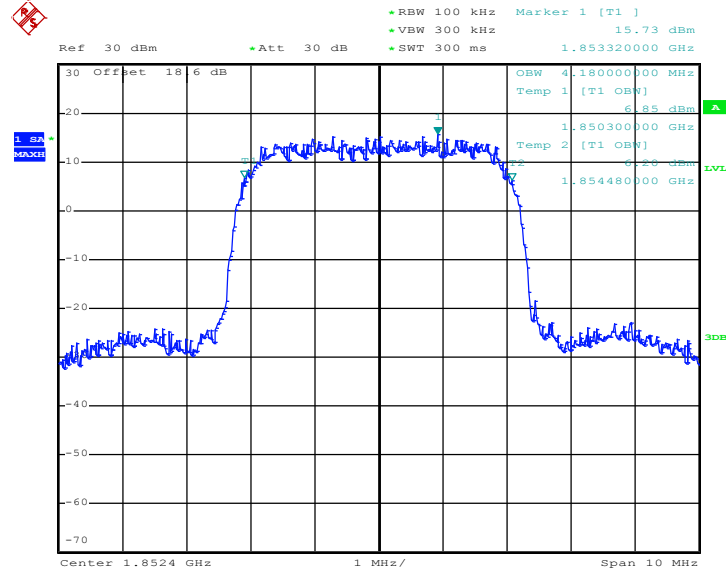

Date: 13.AUG.2014 11:58:58

26dB Bandwidth Plot on Channel 9262 (1852.4 MHz)

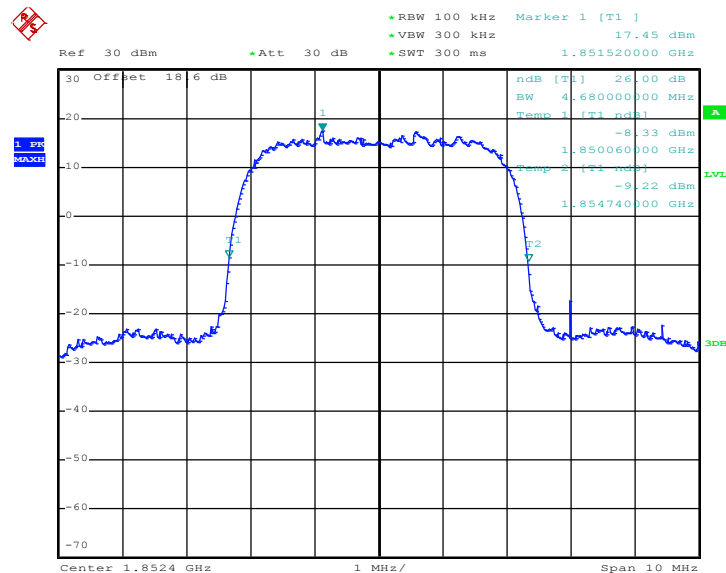

Date: 13.AUG.2014 11:54:16



99% Occupied Bandwidth Plot on Channel 9400 (1880.0 MHz)

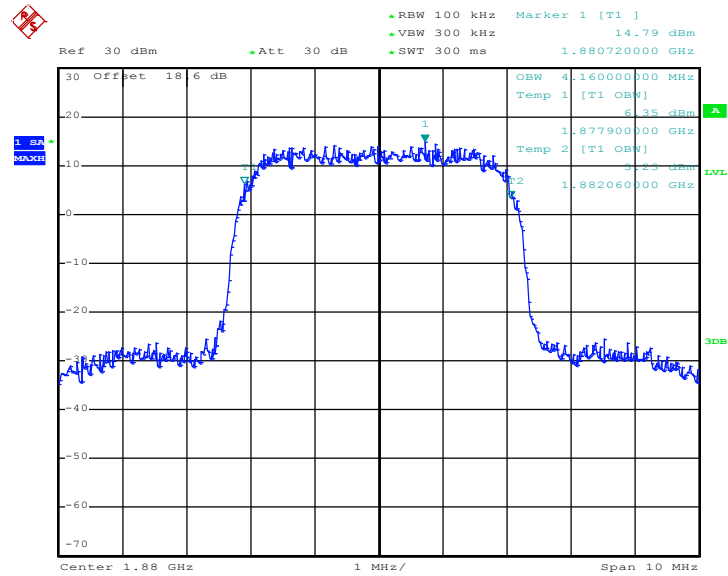

Date: 13.AUG.2014 11:59:26

26dB Bandwidth Plot on Channel 9400 (1880.0 MHz)

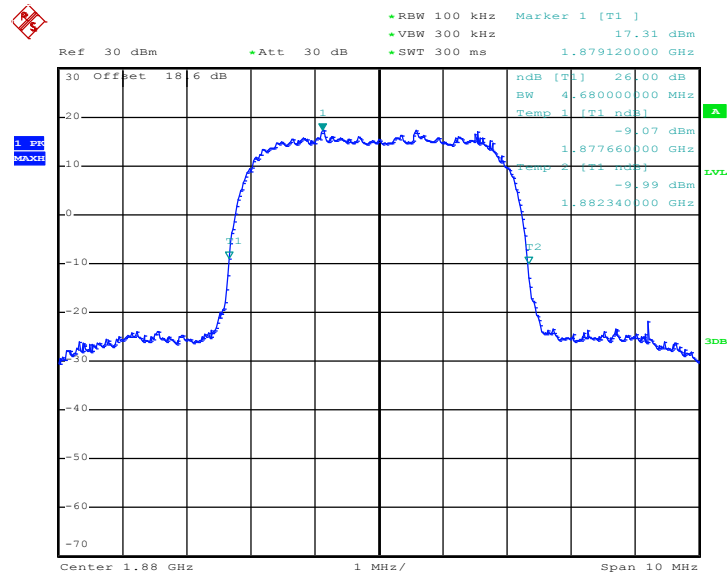

Date: 13.AUG.2014 11:54:44



99% Occupied Bandwidth Plot on Channel 9538 (1907.6 MHz)

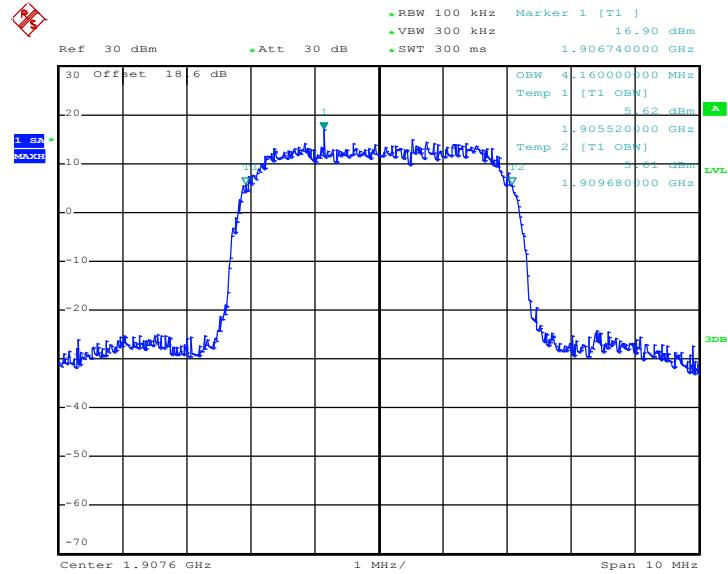

Date: 13.AUG.2014 11:59:55

26dB Bandwidth Plot on Channel 9538 (1907.6 MHz)

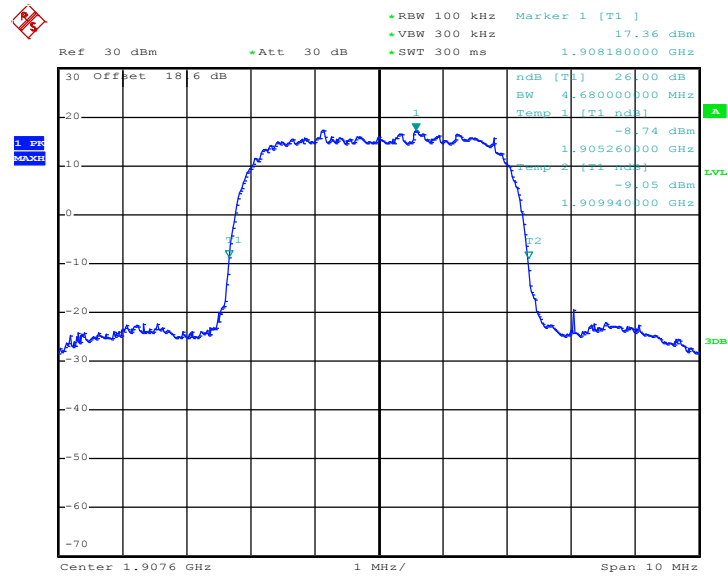

Date: 13.AUG.2014 11:55:13



3.5 Band Edge Measurement

3.5.1 Description of Band Edge Measurement

The power of any emission outside of the authorized operating frequency ranges must be lower than the transmitter power (P) by a factor of at least $43 + 10 \log (P)$ dB.

3.5.2 Measuring Instruments

The measuring equipment is listed in the section 4 of this test report.

3.5.3 Test Procedures

1. The testing follows FCC KDB 971168 v02r01 Section 6.0.
2. The EUT was connected to the spectrum analyzer and system simulator via a power divider.
3. The RF output of EUT was connected to the spectrum analyzer by an RF cable and attenuator. The path loss was compensated to the results for each measurement.
4. The band edges of low and high channels for the highest RF powers were measured.
5. The RF fundamental frequency should be excluded against the limit line in the operating frequency band.
6. The limit line is derived from $43 + 10\log(P)$ dB below the transmitter power P(Watts)
= $P(W) - [43 + 10\log(P)]$ (dB)
= $[30 + 10\log(P)]$ (dBm) - $[43 + 10\log(P)]$ (dB)
= -13dBm.

3.5.4 Test Setup

<Conducted Band Edge >

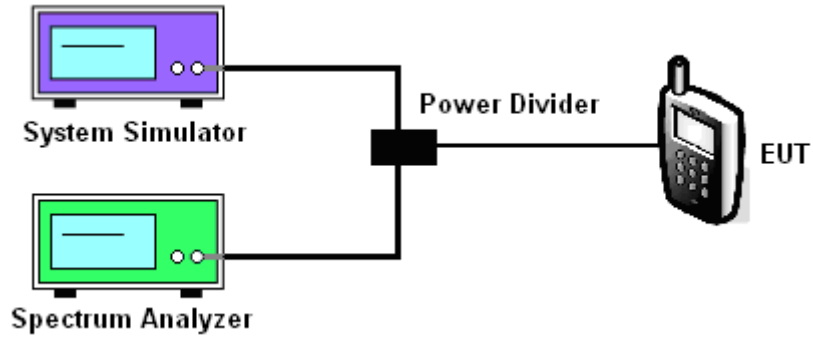

<Radiated Band Edge>

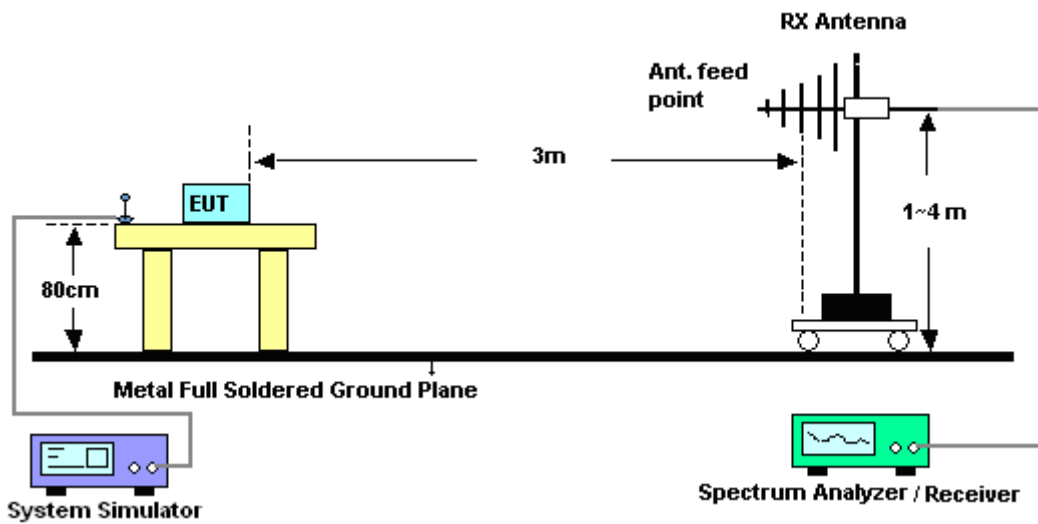



3.5.5 Test Result (Plots) of Conducted Band Edge

| | | | |
|--------|--------|-------------|--------------------------|
| Band : | GSM850 | Test Mode : | GPRS class 8 Link (GMSK) |
|--------|--------|-------------|--------------------------|

Lower Band Edge Plot on Channel 128 (824.2 MHz)

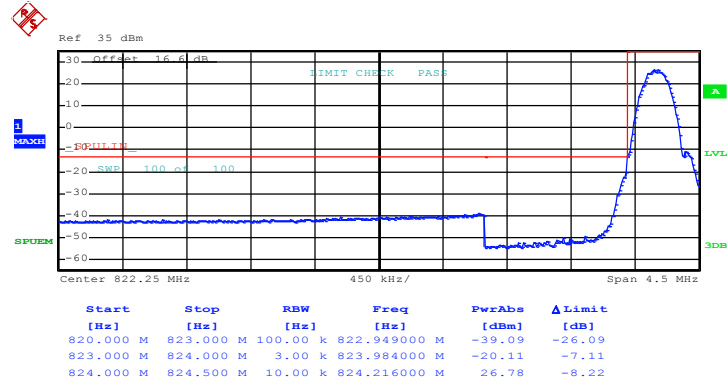

Date: 13.AUG.2014 09:32:10

Higher Band Edge Plot on Channel 251 (848.8 MHz)

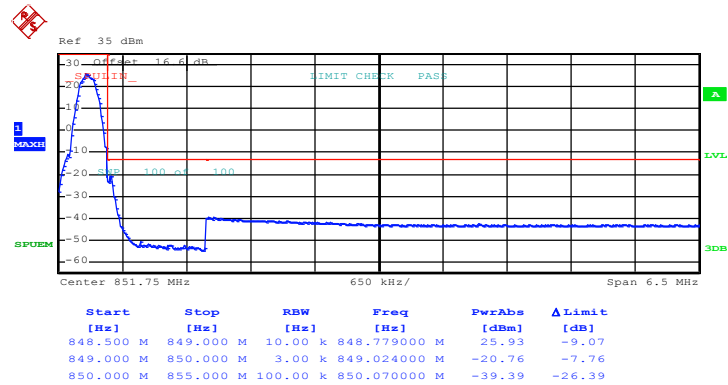

Date: 13.AUG.2014 09:27:07



| | | | |
|--------|--------|-------------|--------------------------|
| Band : | GSM850 | Test Mode : | EDGE class 8 Link (8PSK) |
|--------|--------|-------------|--------------------------|

Lower Band Edge Plot on Channel 128 (824.2 MHz)

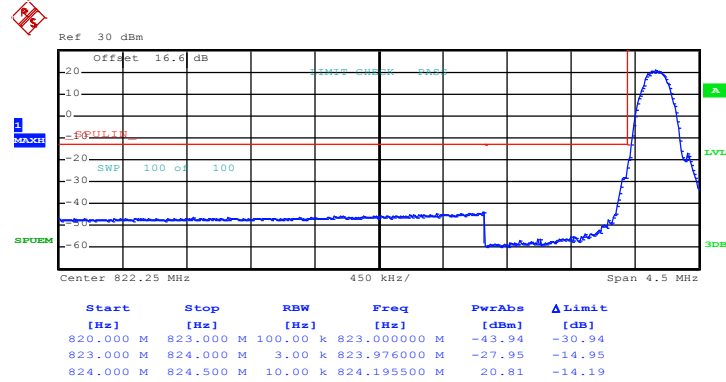

Date: 13.AUG.2014 10:09:56

Higher Band Edge Plot on Channel 251 (848.8 MHz)

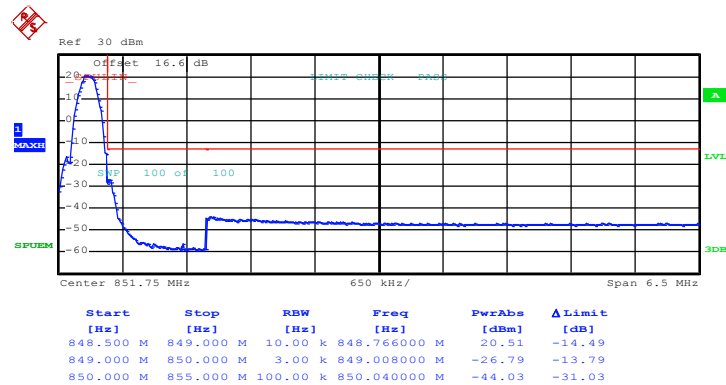

Date: 13.AUG.2014 10:06:28



| | | | |
|--------|---------|-------------|--------------------------|
| Band : | GSM1900 | Test Mode : | GPRS class 8 Link (GMSK) |
|--------|---------|-------------|--------------------------|

Lower Band Edge Plot on Channel 512 (1850.2 MHz)

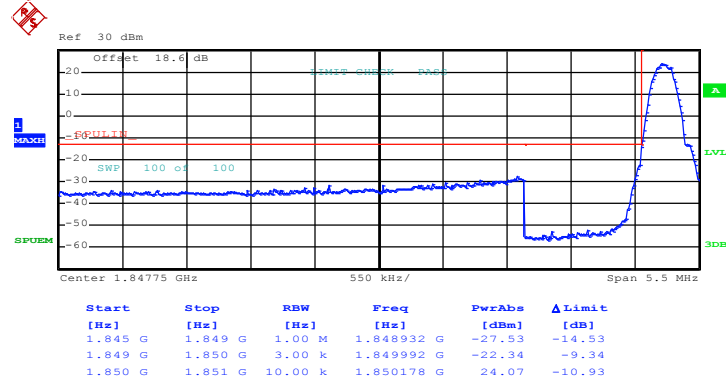

Date: 13.AUG.2014 10:43:13

Higher Band Edge Plot on Channel 810 (1909.8 MHz)

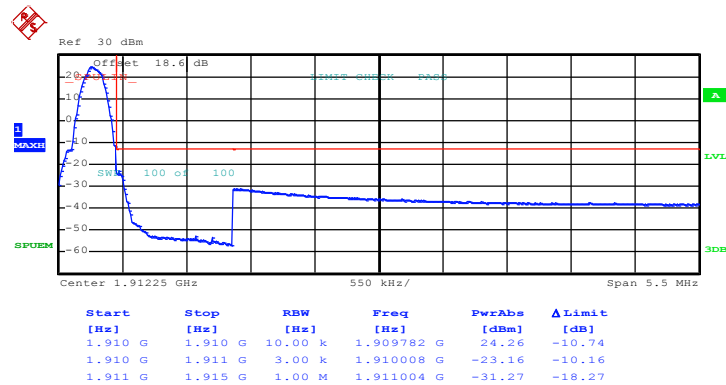

Date: 13.AUG.2014 10:40:32



| | | | |
|--------|---------|-------------|--------------------------|
| Band : | GSM1900 | Test Mode : | EDGE class 8 Link (8PSK) |
|--------|---------|-------------|--------------------------|

Lower Band Edge Plot on Channel 512 (1850.2 MHz)

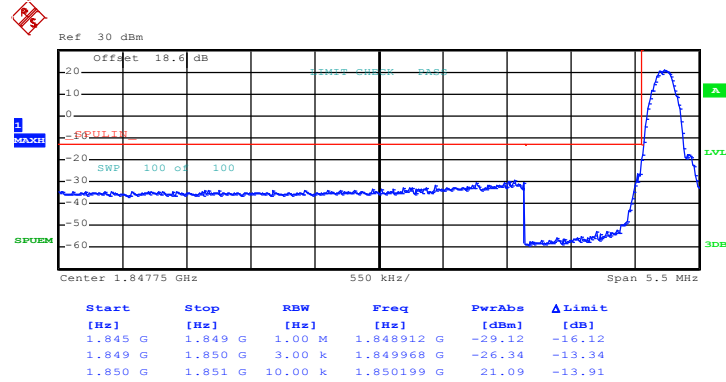

Date: 13.AUG.2014 11:16:03

Higher Band Edge Plot on Channel 810 (1909.8 MHz)

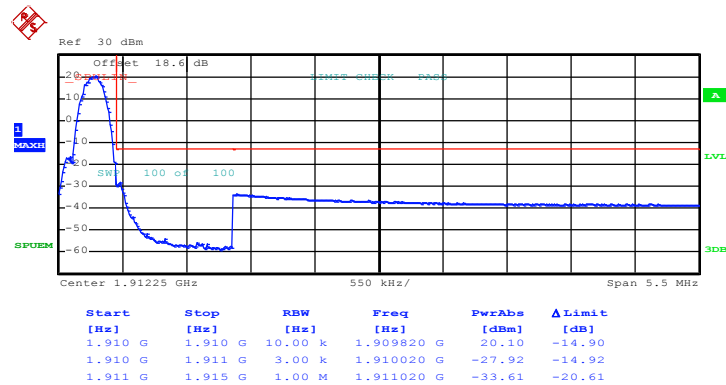

Date: 13.AUG.2014 11:13:45



| | | | |
|--------|--------------|-------------|--------------------------|
| Band : | WCDMA Band V | Test Mode : | RMC 12.2Kbps Link (QPSK) |
|--------|--------------|-------------|--------------------------|

Lower Band Edge Plot on Channel 4132 (826.4 MHz)

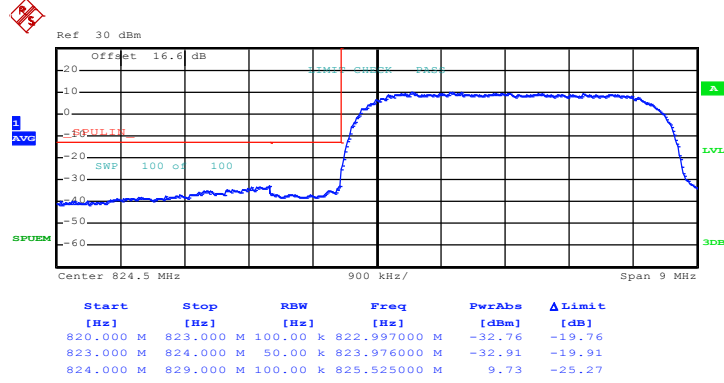

Date: 13.AUG.2014 14:10:24

Higher Band Edge Plot on Channel 4233 (846.6 MHz)

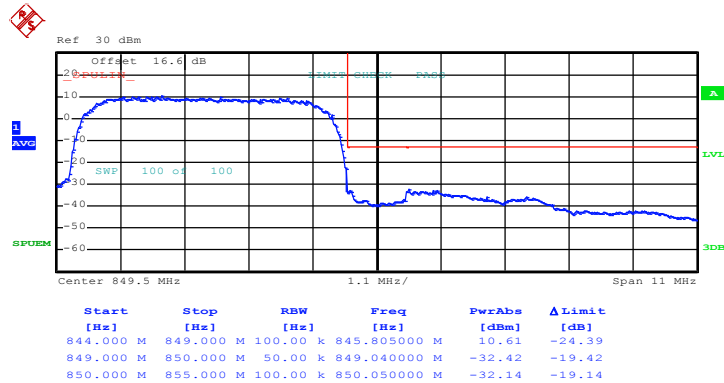

Date: 13.AUG.2014 14:07:30



| | | | |
|---------------|---------------|--------------------|--------------------------|
| Band : | WCDMA Band IV | Test Mode : | RMC 12.2Kbps Link (QPSK) |
|---------------|---------------|--------------------|--------------------------|

Lower Band Edge Plot on Channel 1312 (1712.4 MHz)

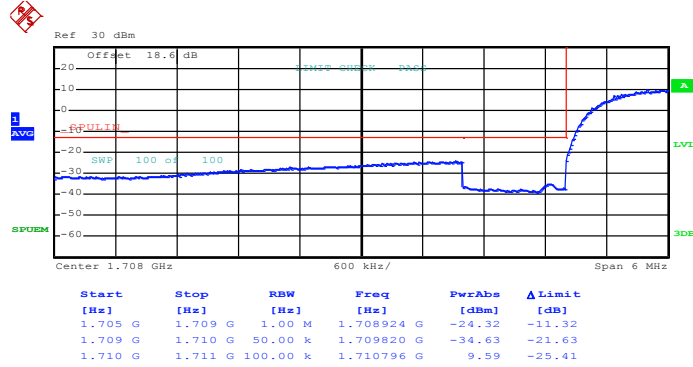

Date: 13.AUG.2014 13:34:36

Higher Band Edge Plot on Channel 1513 (1752.6 MHz)

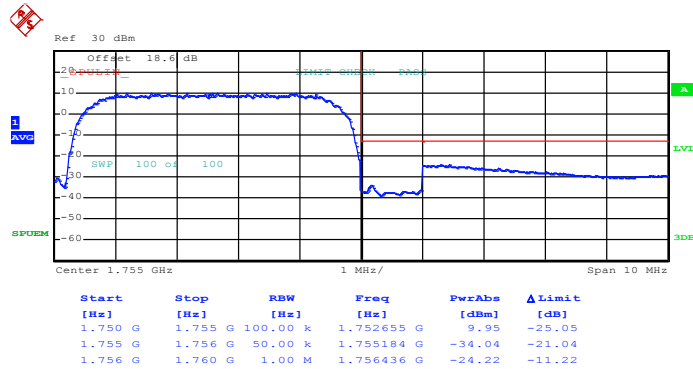

Date: 13.AUG.2014 13:13:41



| | | | |
|--------|---------------|-------------|--------------------------|
| Band : | WCDMA Band II | Test Mode : | RMC 12.2Kbps Link (QPSK) |
|--------|---------------|-------------|--------------------------|

Lower Band Edge Plot on Channel 9262 (1852.4 MHz)

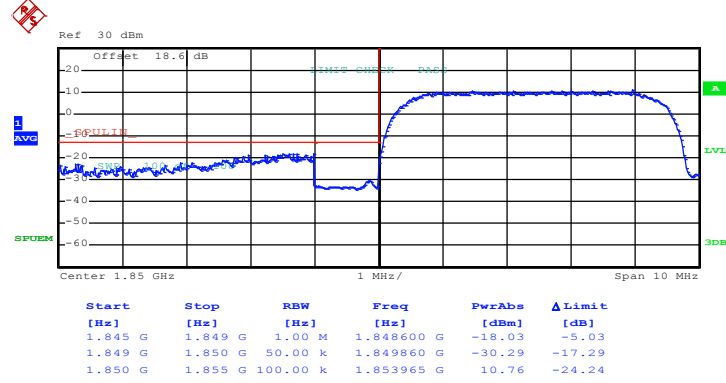

Date: 13.AUG.2014 11:46:50

Higher Band Edge Plot on Channel 9538 (1907.6 MHz)

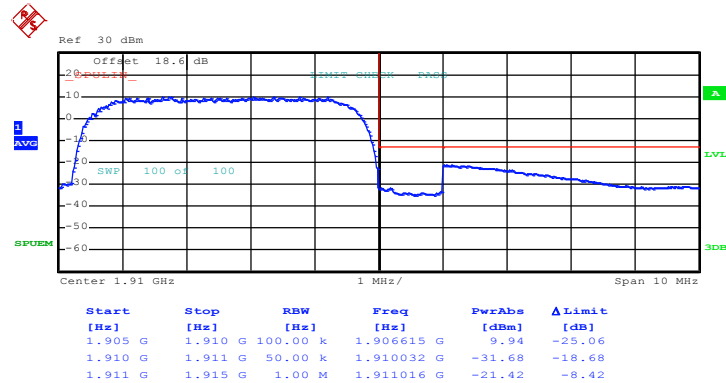

Date: 13.AUG.2014 11:43:29

3.6 Conducted Spurious Emission Measurement

3.6.1 Description of Conducted Spurious Emission Measurement

The power of any emission outside of the authorized operating frequency ranges must be lower than the transmitter power (P) by a factor of at least $43 + 10 \log (P)$ dB.

It is measured by means of a calibrated spectrum analyzer and scanned from 30 MHz up to a frequency including its 10th harmonic.

3.6.2 Measuring Instruments

The measuring equipment is listed in the section 4 of this test report.

3.6.3 Test Procedures

1. The testing follows FCC KDB 971168 v02r01 Section 6.0.
2. The EUT was connected to the spectrum analyzer and system simulator via a power divider.
3. The RF output of EUT was connected to the spectrum analyzer by an RF cable and attenuator. The path loss was compensated to the results for each measurement.
4. The middle channel for the highest RF power within the transmitting frequency was measured.
5. The conducted spurious emission for the whole frequency range was taken.
6. The RF fundamental frequency should be excluded against the limit line in the operating frequency band.
7. The limit line is derived from $43 + 10\log(P)$ dB below the transmitter power P(Watts)
 $= P(W) - [43 + 10\log(P)]$ (dB)
 $= [30 + 10\log(P)]$ (dBm) - $[43 + 10\log(P)]$ (dB)
 $= -13\text{dBm}$.

3.6.4 Test Setup

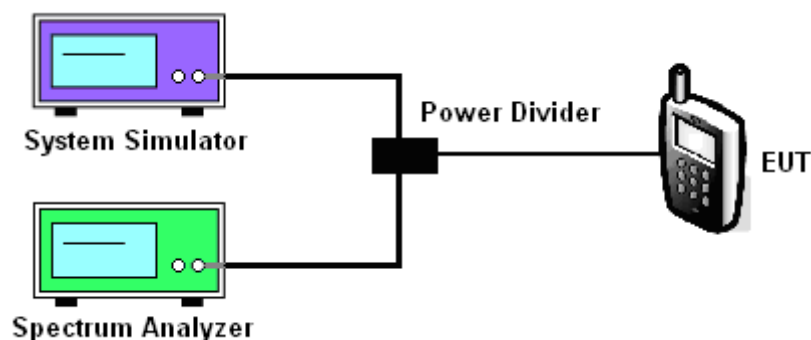



3.6.5 Test Result (Plots) of Conducted Spurious Emission

| | | | |
|-------------|--------------------------|-------------|-----------|
| Band : | GSM850 | Channel : | CH128 |
| Test Mode : | GPRS class 8 Link (GMSK) | Frequency : | 824.2 MHz |

Conducted Spurious Emission Plot between 30MHz ~ 1GHz

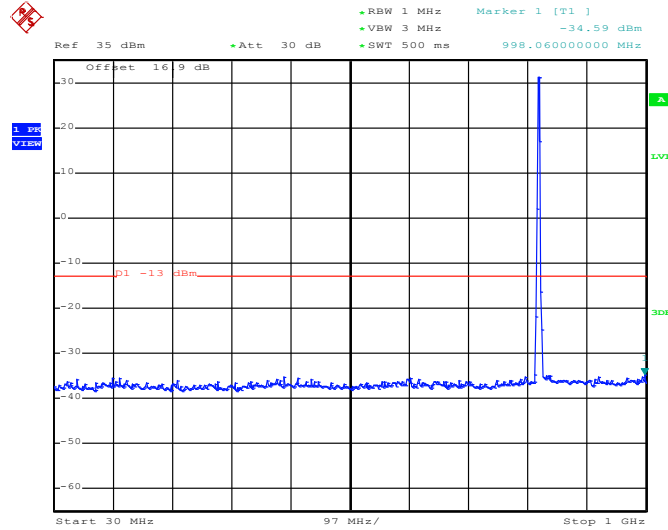

Date: 13.AUG.2014 09:42:03

Conducted Spurious Emission Plot between 1GHz ~ 3GHz

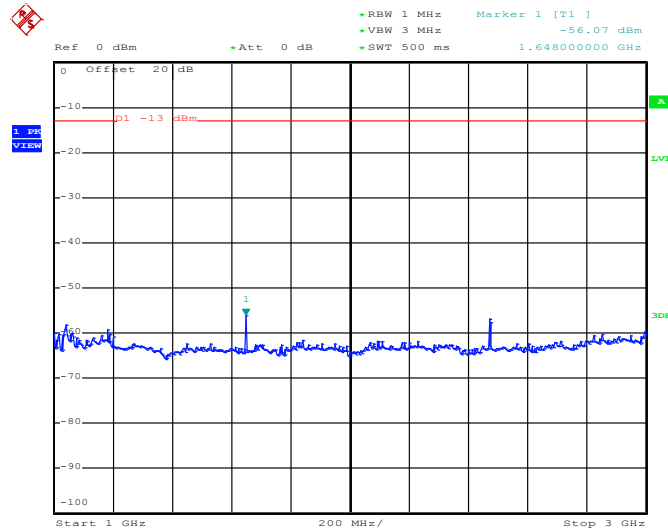

Date: 13.AUG.2014 09:42:15



Conducted Spurious Emission Plot between 3GHz ~ 7GHz

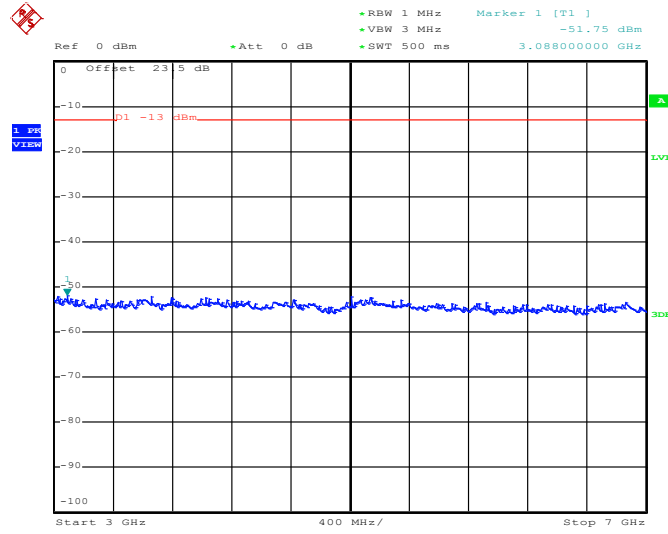

Date: 13.AUG.2014 09:42:23

Conducted Spurious Emission Plot between 7GHz ~ 9GHz

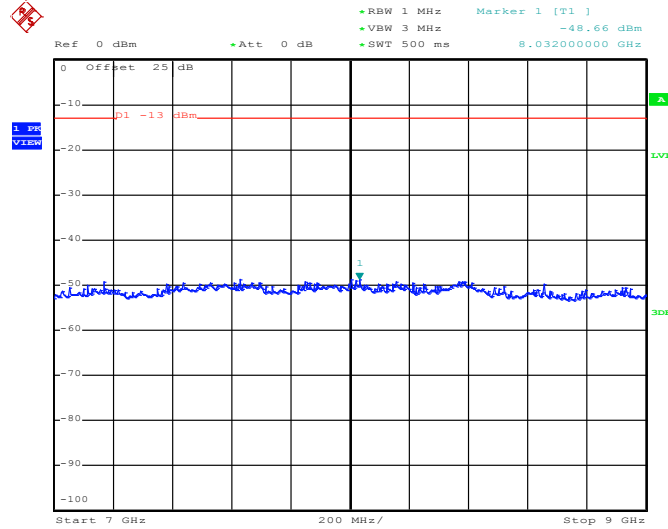

Date: 13.AUG.2014 09:42:32



| | | | |
|-------------|--------------------------|-------------|-----------|
| Band : | GSM850 | Channel : | CH189 |
| Test Mode : | GPRS class 8 Link (GMSK) | Frequency : | 836.4 MHz |

Conducted Spurious Emission Plot between 30MHz ~ 1GHz

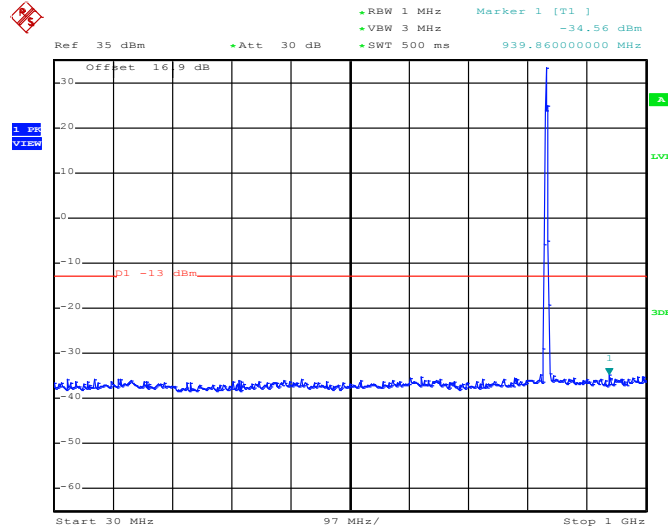

Date: 13.AUG.2014 09:43:22

Conducted Spurious Emission Plot between 1GHz ~ 3GHz

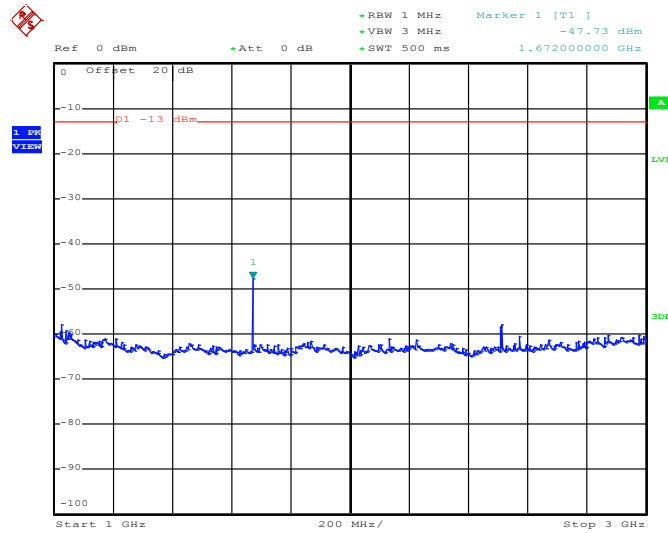

Date: 13.AUG.2014 09:43:33



Conducted Spurious Emission Plot between 3GHz ~ 7GHz

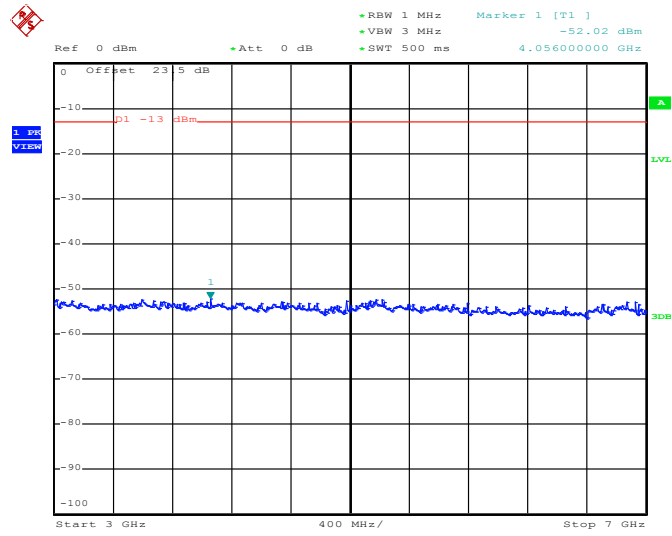

Date: 13.AUG.2014 09:43:41

Conducted Spurious Emission Plot between 7GHz ~ 9GHz

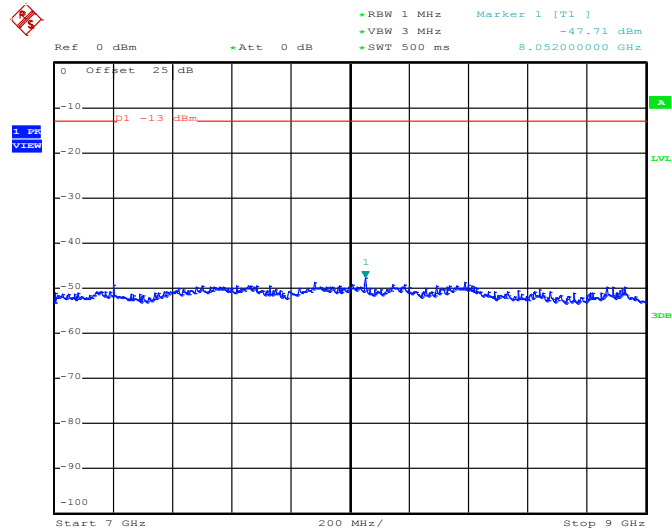

Date: 13.AUG.2014 09:43:50



| | | | |
|-------------|--------------------------|-------------|-----------|
| Band : | GSM850 | Channel : | CH251 |
| Test Mode : | GPRS class 8 Link (GMSK) | Frequency : | 848.8 MHz |

Conducted Spurious Emission Plot between 30MHz ~ 1GHz

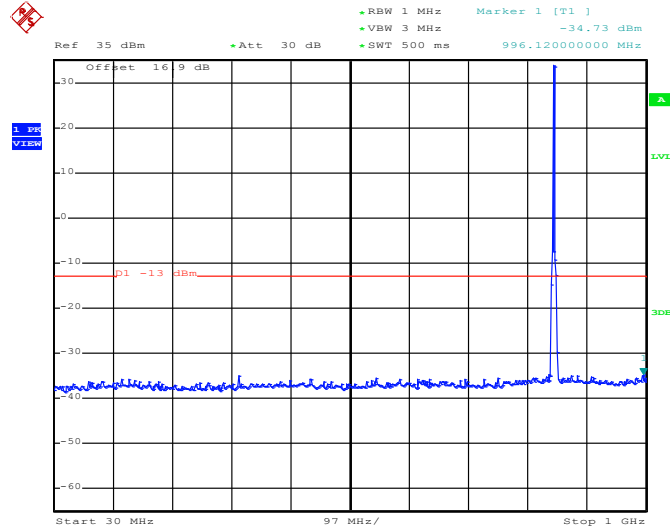

Date: 13.AUG.2014 09:46:08

Conducted Spurious Emission Plot between 1GHz ~ 3GHz

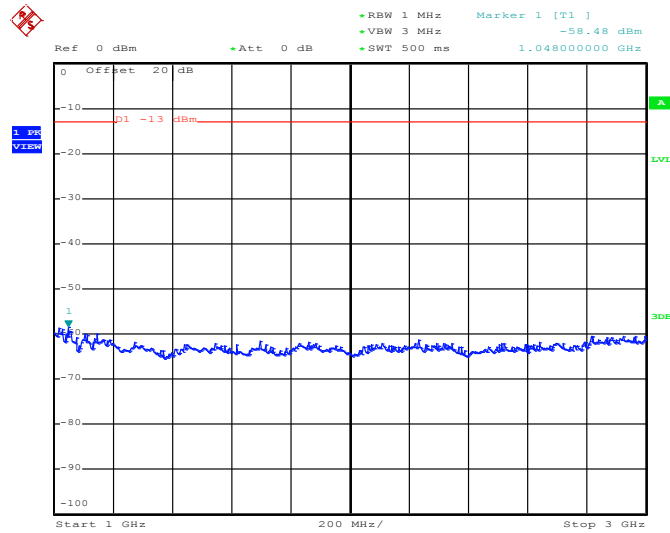

Date: 13.AUG.2014 09:44:53



Conducted Spurious Emission Plot between 3GHz ~ 7GHz

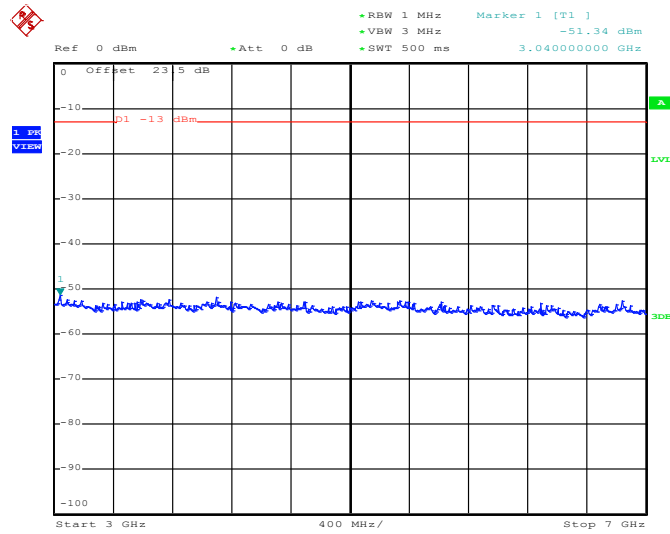

Date: 13.AUG.2014 09:45:02

Conducted Spurious Emission Plot between 7GHz ~ 9GHz

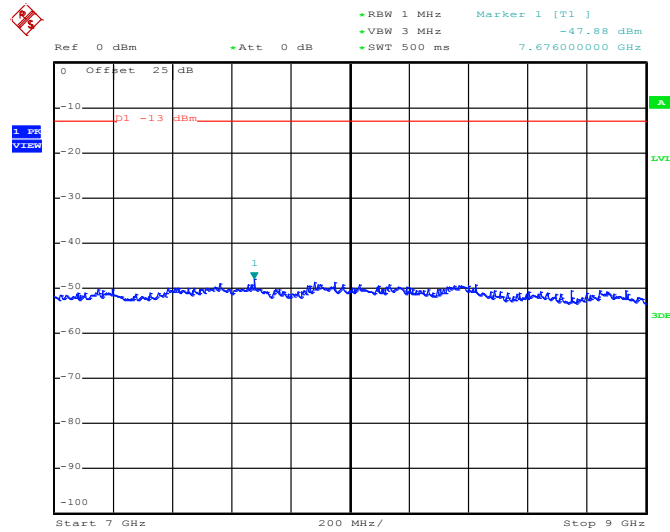

Date: 13.AUG.2014 09:45:10



| | | | |
|--------------------|--------------------------|--------------------|-----------|
| Band : | GSM850 | Channel : | CH128 |
| Test Mode : | EDGE class 8 Link (8PSK) | Frequency : | 824.2 MHz |

Conducted Spurious Emission Plot between 30MHz ~ 1GHz

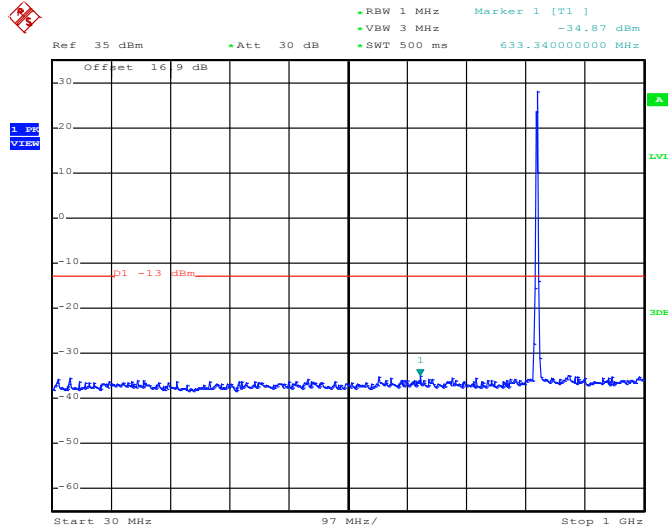

Date: 13.AUG.2014 10:21:01

Conducted Spurious Emission Plot between 1GHz ~ 3GHz

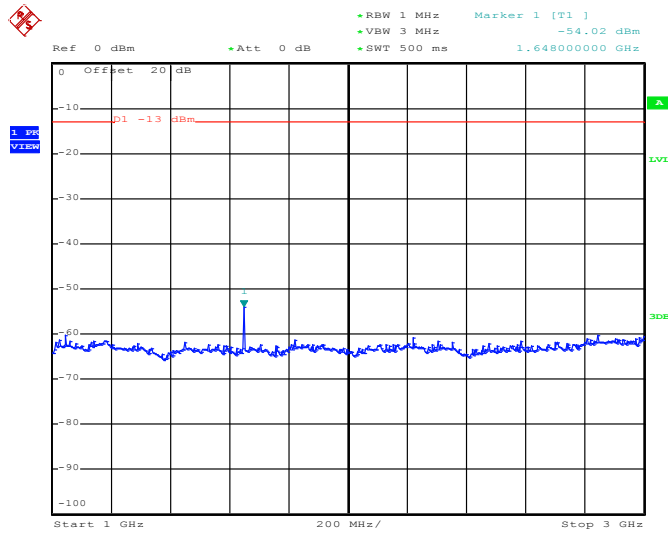

Date: 13.AUG.2014 10:21:11



Conducted Spurious Emission Plot between 3GHz ~ 7GHz

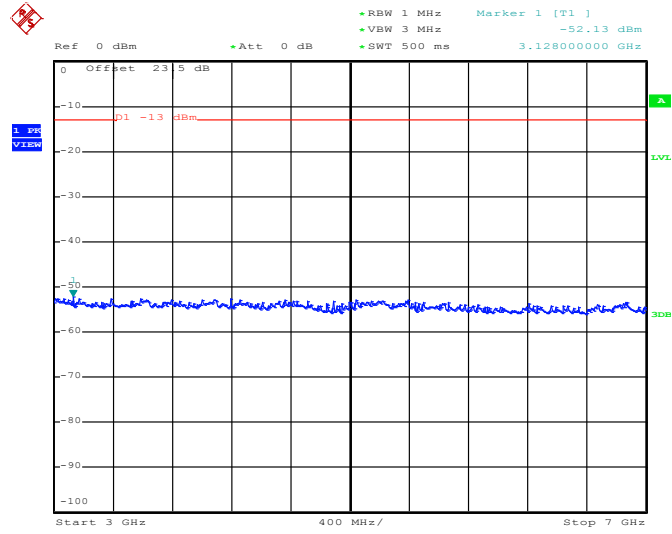

Date: 13.AUG.2014 10:21:20

Conducted Spurious Emission Plot between 7GHz ~ 9GHz

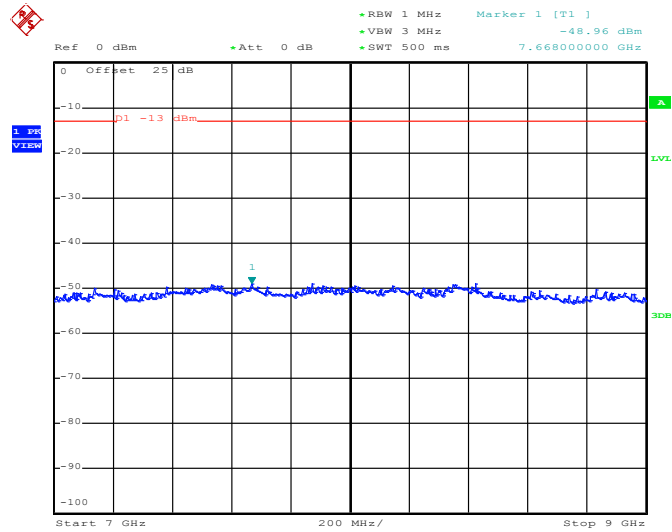

Date: 13.AUG.2014 10:21:28



| | | | |
|-------------|--------------------------|-------------|-----------|
| Band : | GSM850 | Channel : | CH189 |
| Test Mode : | EDGE class 8 Link (8PSK) | Frequency : | 836.4 MHz |

Conducted Spurious Emission Plot between 30MHz ~ 1GHz

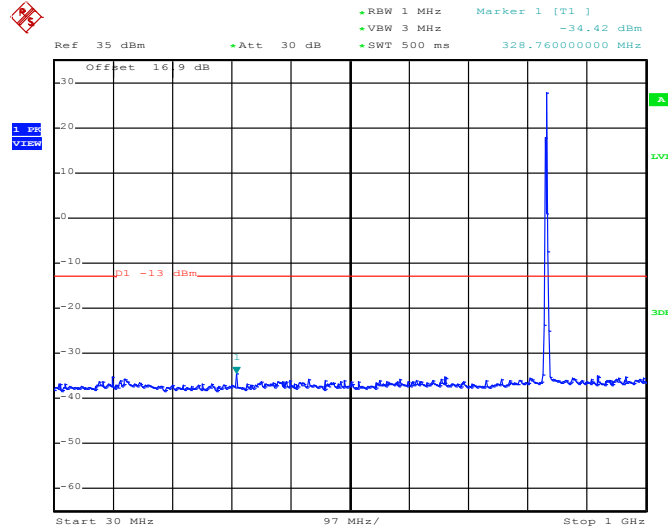

Date: 13.AUG.2014 10:23:37

Conducted Spurious Emission Plot between 1GHz ~ 3GHz

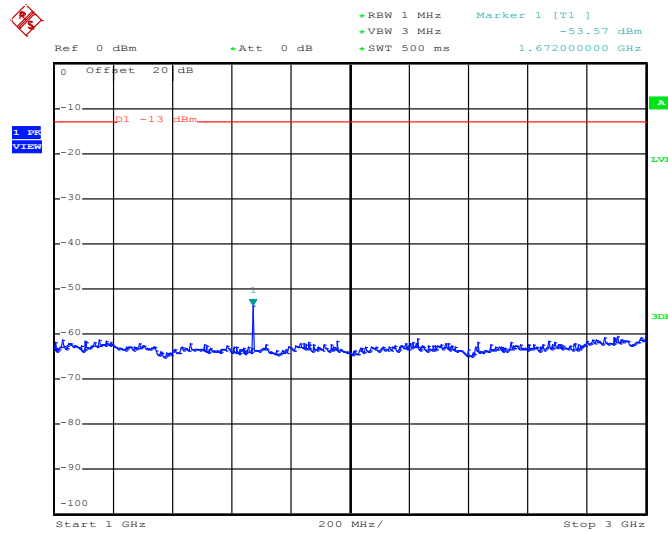

Date: 13.AUG.2014 10:23:47



Conducted Spurious Emission Plot between 3GHz ~ 7GHz

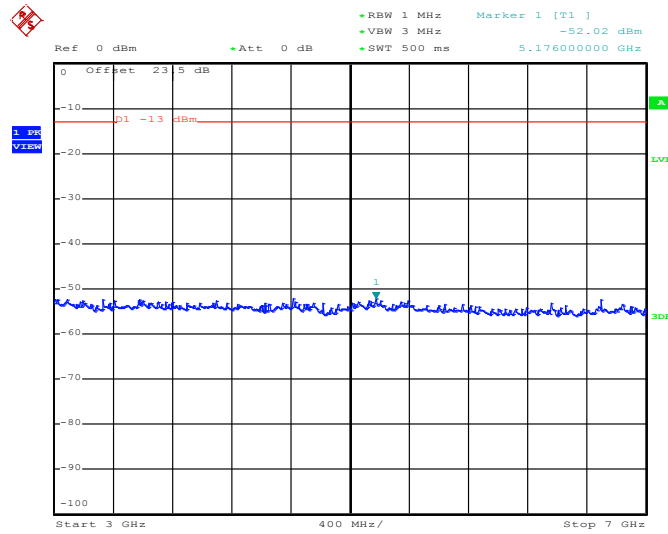

Date: 13.AUG.2014 10:23:56

Conducted Spurious Emission Plot between 7GHz ~ 9GHz

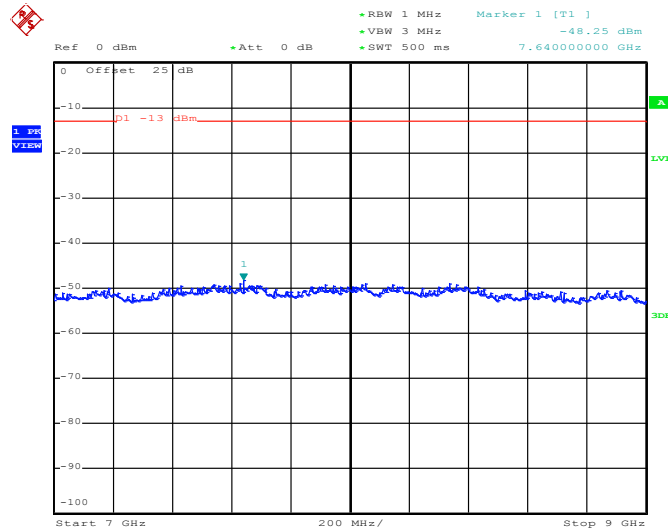

Date: 13.AUG.2014 10:24:04



| | | | |
|--------------------|--------------------------|--------------------|-----------|
| Band : | GSM850 | Channel : | CH251 |
| Test Mode : | EDGE class 8 Link (8PSK) | Frequency : | 848.8 MHz |

Conducted Spurious Emission Plot between 30MHz ~ 1GHz

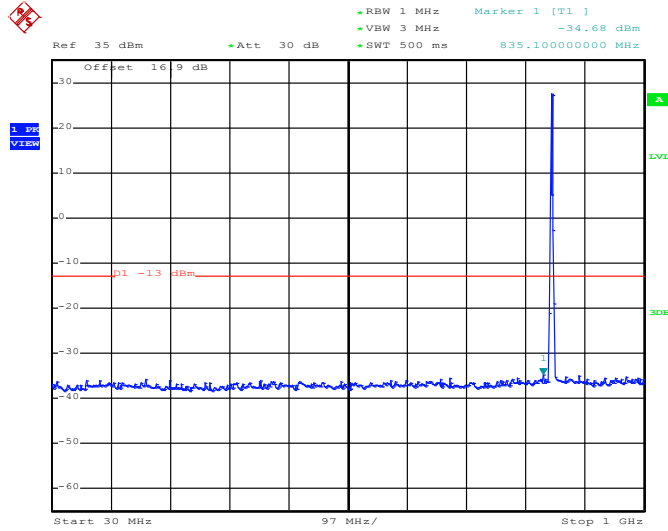

Date: 13.AUG.2014 10:25:55

Conducted Spurious Emission Plot between 1GHz ~ 3GHz

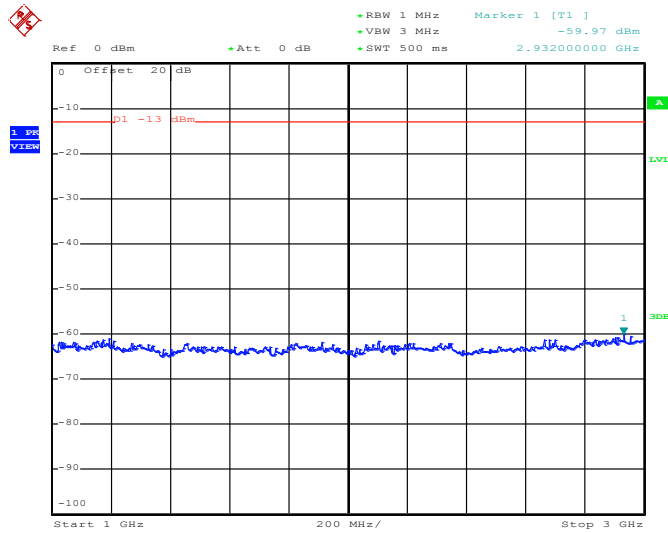

Date: 13.AUG.2014 10:26:06



Conducted Spurious Emission Plot between 3GHz ~ 7GHz

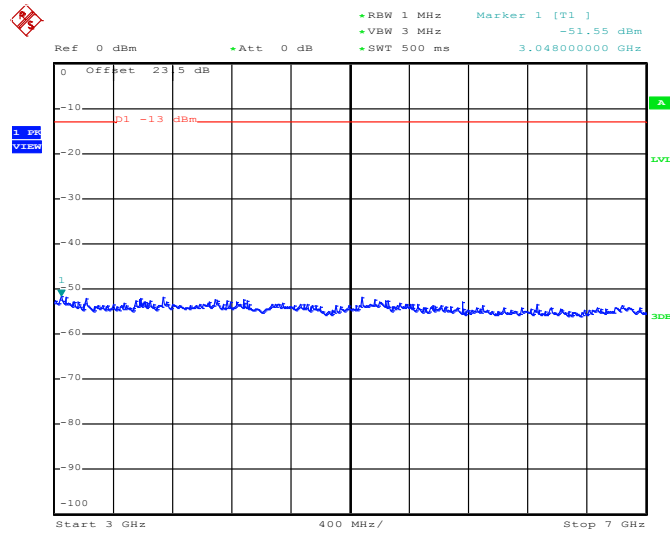

Date: 13.AUG.2014 10:26:15

Conducted Spurious Emission Plot between 7GHz ~ 9GHz

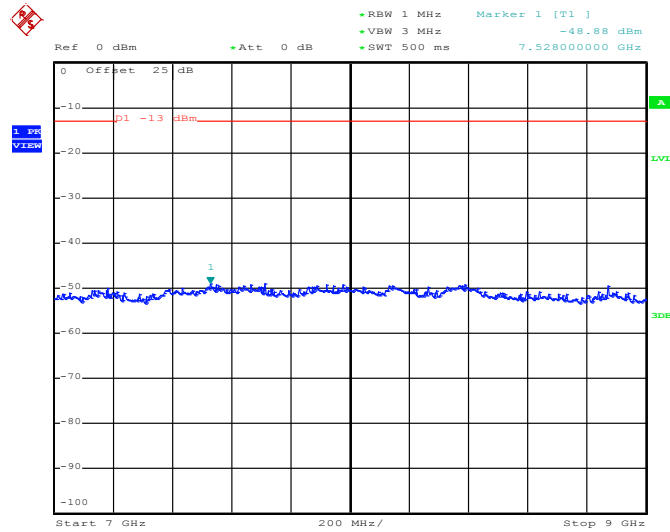

Date: 13.AUG.2014 10:26:23



| | | | |
|--------------------|--------------------------|--------------------|------------|
| Band : | GSM1900 | Channel : | CH512 |
| Test Mode : | GPRS class 8 Link (GMSK) | Frequency : | 1850.2 MHz |

Conducted Spurious Emission Plot between 30MHz ~ 1GHz

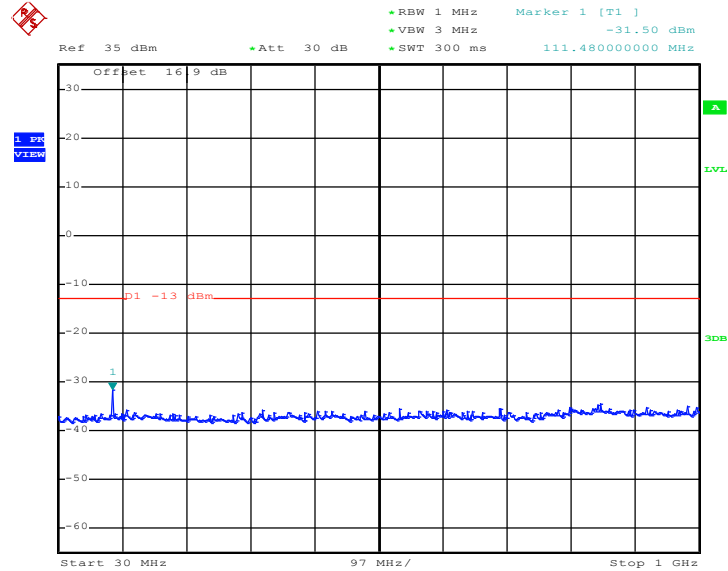

Date: 13.AUG.2014 10:51:37

Conducted Spurious Emission Plot between 1GHz ~ 3GHz

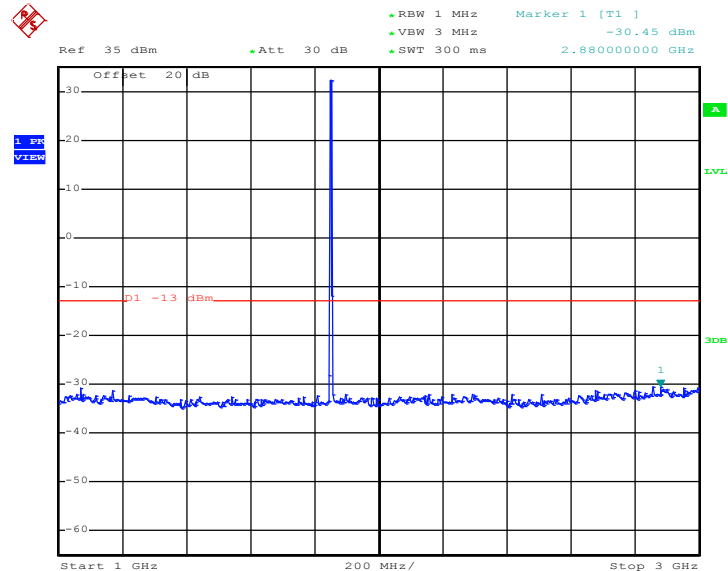

Date: 13.AUG.2014 10:51:46



Conducted Spurious Emission Plot between 3GHz ~ 7GHz

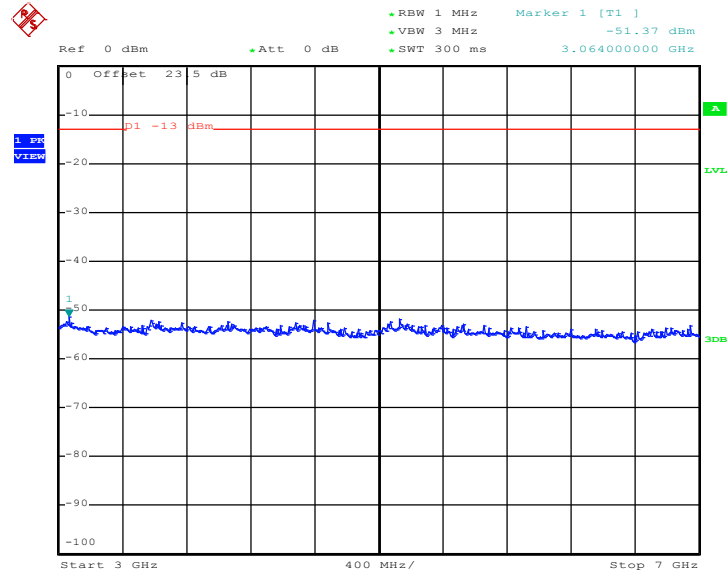

Date: 13.AUG.2014 10:51:56

Conducted Spurious Emission Plot between 7GHz ~ 13.6GHz

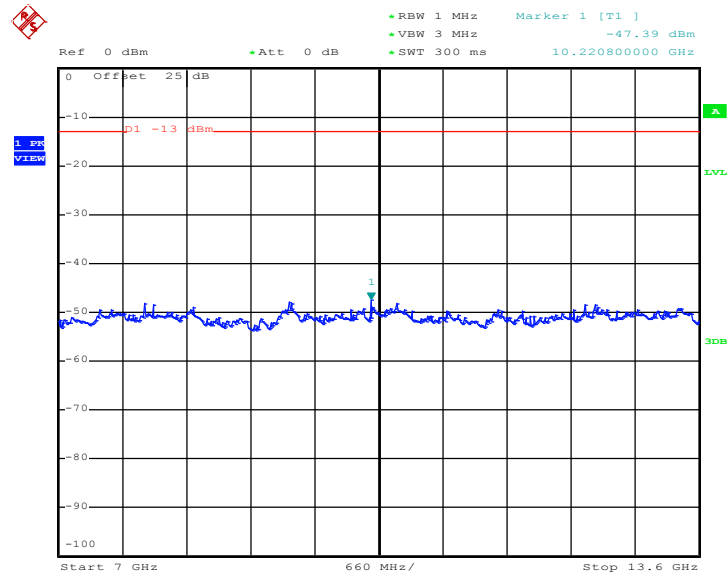

Date: 13.AUG.2014 10:52:05



Conducted Spurious Emission Plot between 13.6GHz ~ 19.1GHz

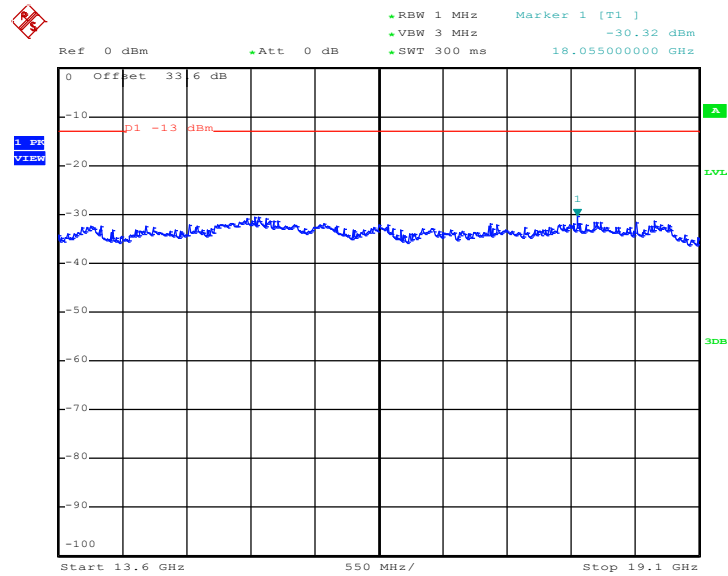

Date: 13.AUG.2014 10:52:13



| | | | |
|--------------------|--------------------------|--------------------|------------|
| Band : | GSM1900 | Channel : | CH661 |
| Test Mode : | GPRS class 8 Link (GMSK) | Frequency : | 1880.0 MHz |

Conducted Spurious Emission Plot between 30MHz ~ 1GHz

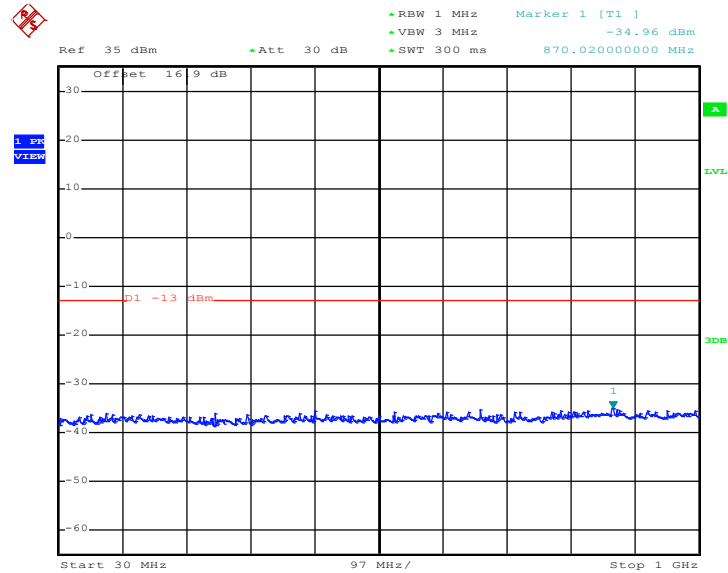

Date: 13.AUG.2014 10:53:18

Conducted Spurious Emission Plot between 1GHz ~ 3GHz

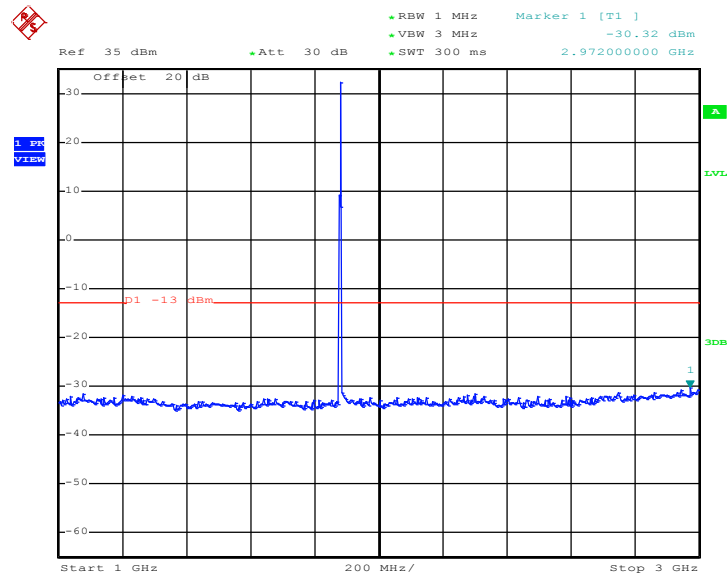

Date: 13.AUG.2014 10:53:26



Conducted Spurious Emission Plot between 3GHz ~ 7GHz

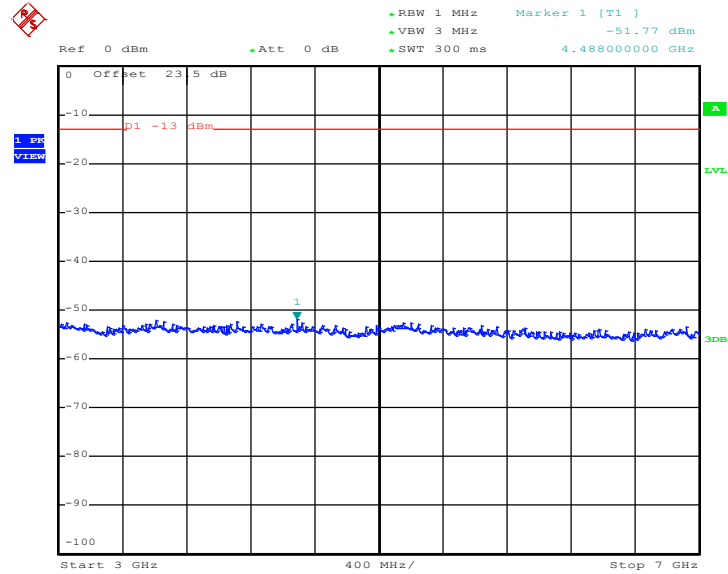

Date: 13.AUG.2014 10:53:37

Conducted Spurious Emission Plot between 7GHz ~ 13.6GHz

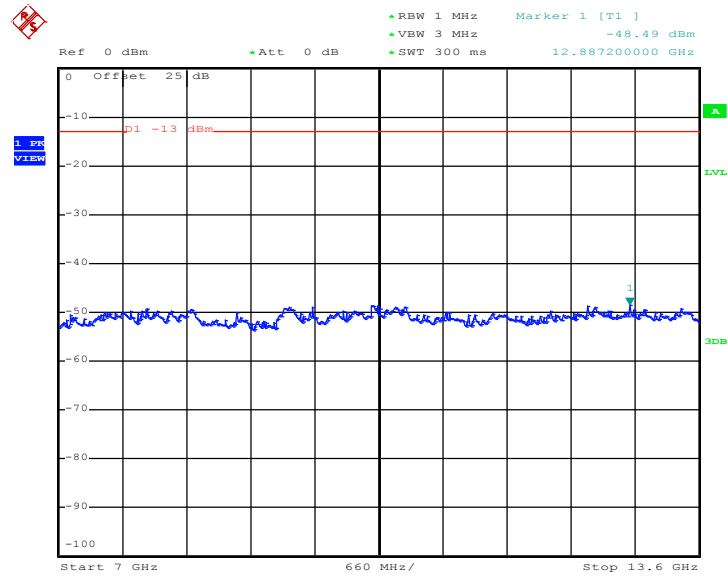

Date: 13.AUG.2014 10:53:45



Conducted Spurious Emission Plot between 13.6GHz ~ 19.1GHz

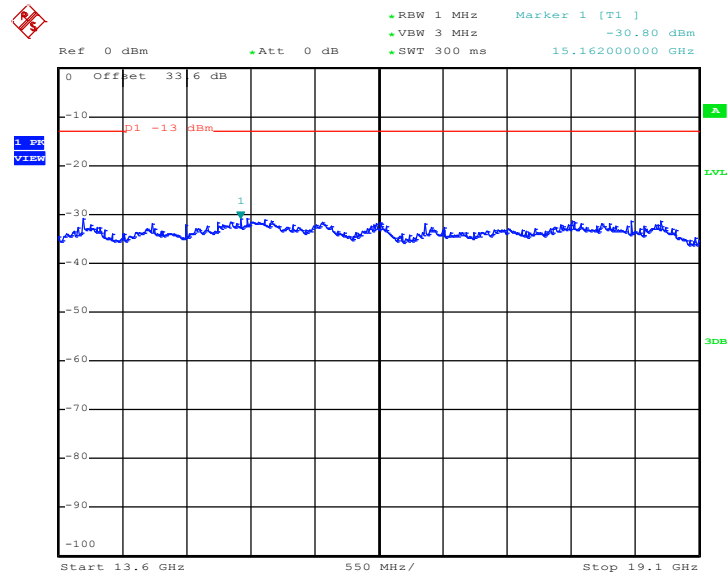

Date: 13.AUG.2014 10:53:54



| | | | |
|--------------------|--------------------------|--------------------|------------|
| Band : | GSM1900 | Channel : | CH810 |
| Test Mode : | GPRS class 8 Link (GMSK) | Frequency : | 1909.8 MHz |

Conducted Spurious Emission Plot between 30MHz ~ 1GHz

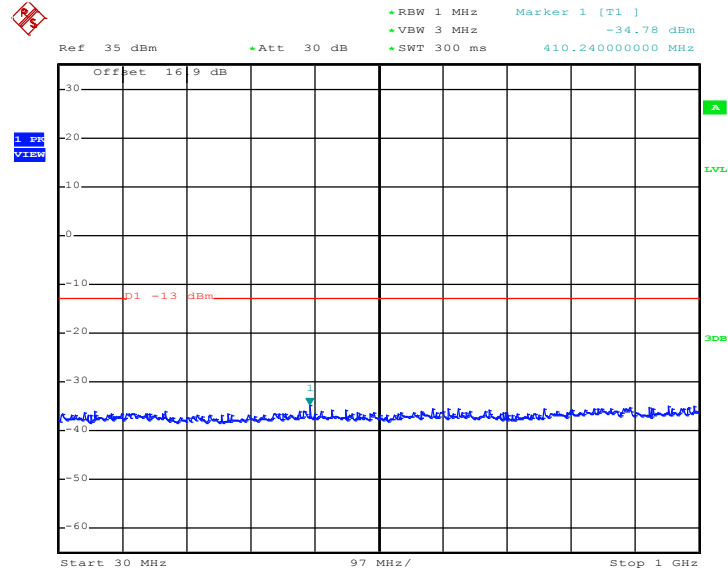

Date: 13.AUG.2014 10:56:33

Conducted Spurious Emission Plot between 1GHz ~ 3GHz

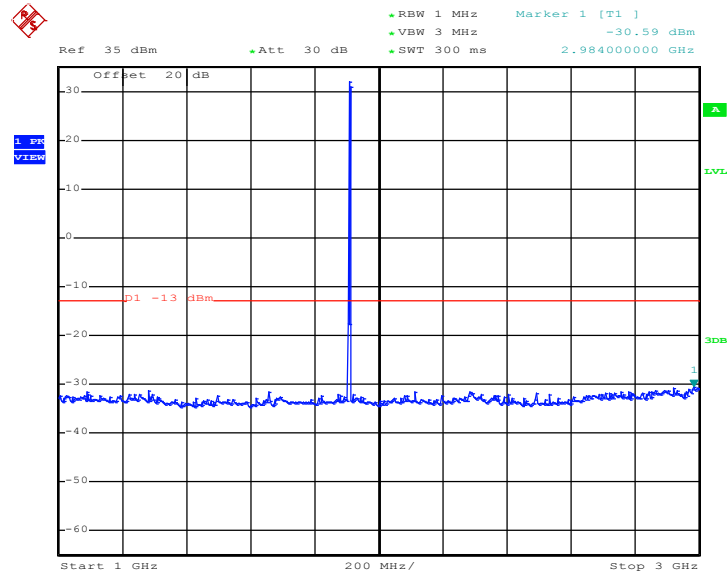

Date: 13.AUG.2014 10:56:42



Conducted Spurious Emission Plot between 3GHz ~ 7GHz

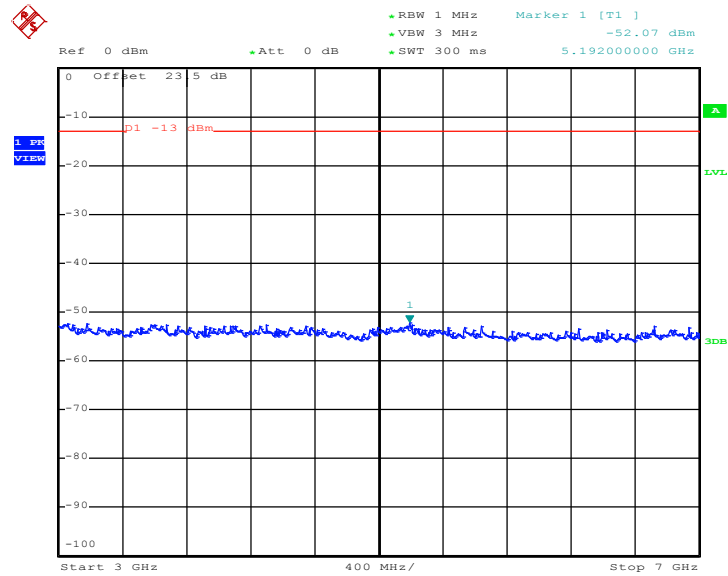

Date: 13.AUG.2014 10:56:52

Conducted Spurious Emission Plot between 7GHz ~ 13.6GHz

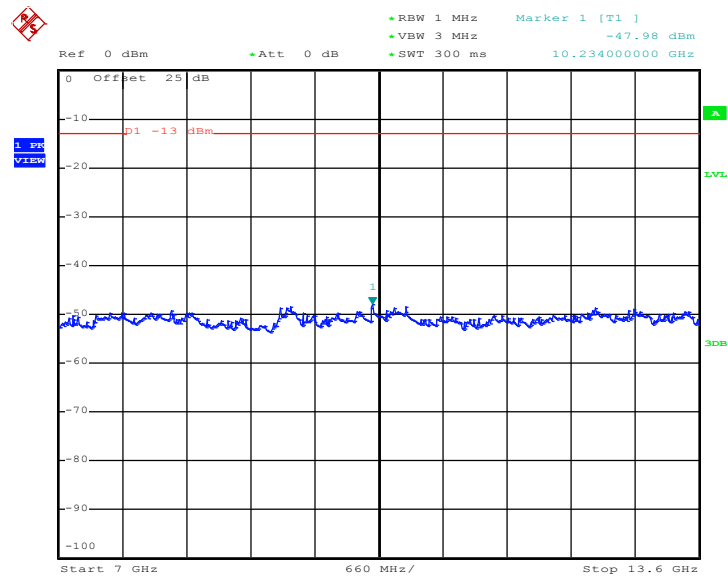

Date: 13.AUG.2014 10:57:01



Conducted Spurious Emission Plot between 13.6GHz ~ 19.1GHz

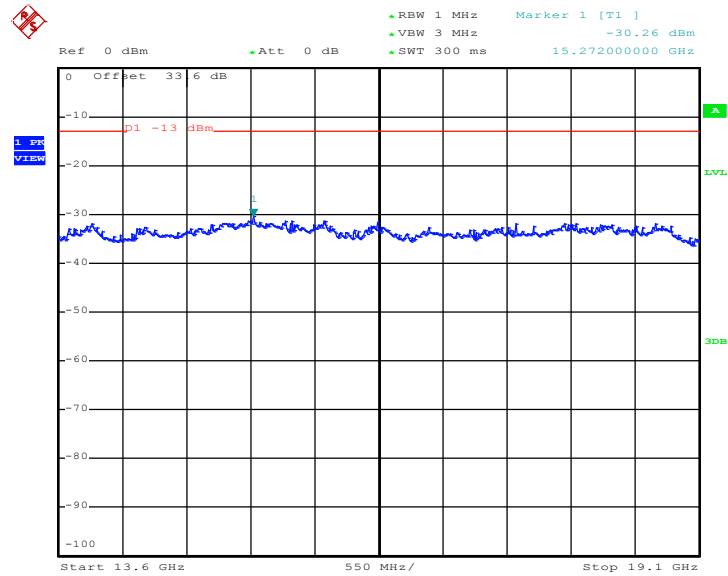

Date: 13.AUG.2014 10:57:09



| | | | |
|--------------------|--------------------------|--------------------|------------|
| Band : | GSM1900 | Channel : | CH512 |
| Test Mode : | EDGE class 8 Link (8PSK) | Frequency : | 1850.2 MHz |

Conducted Spurious Emission Plot between 30MHz ~ 1GHz

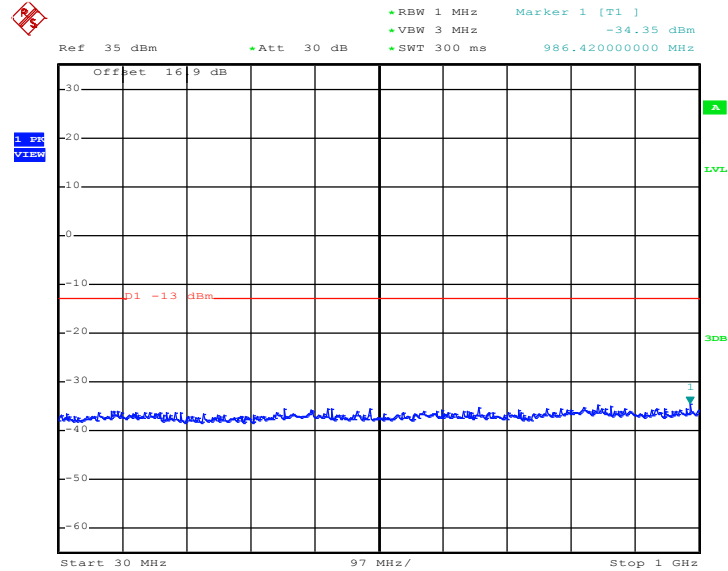

Date: 13.AUG.2014 11:27:58

Conducted Spurious Emission Plot between 1GHz ~ 3GHz

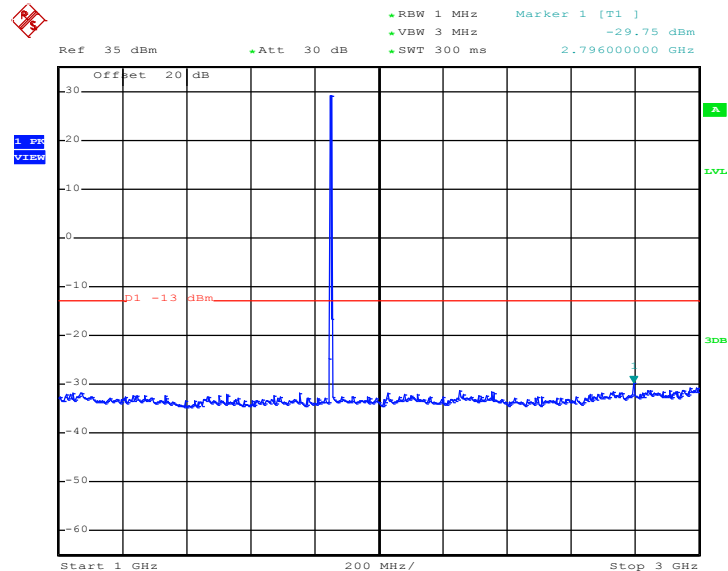

Date: 13.AUG.2014 11:28:07



Conducted Spurious Emission Plot between 3GHz ~ 7GHz

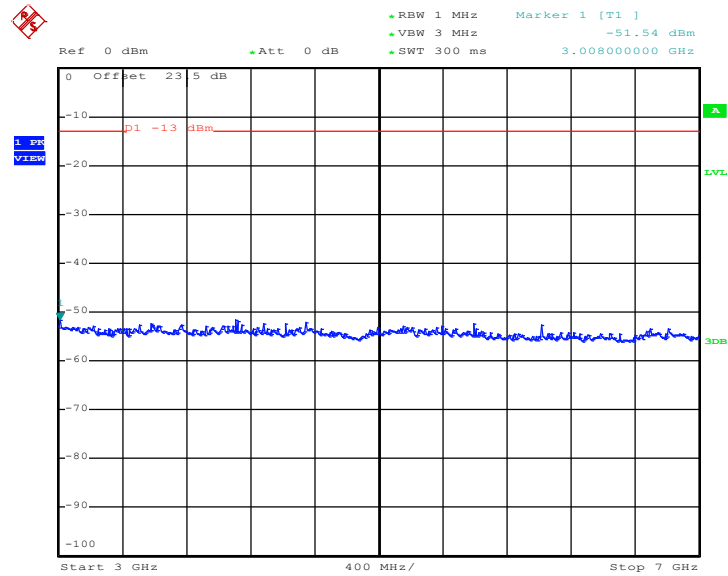

Date: 13.AUG.2014 11:28:17

Conducted Spurious Emission Plot between 7GHz ~ 13.6GHz

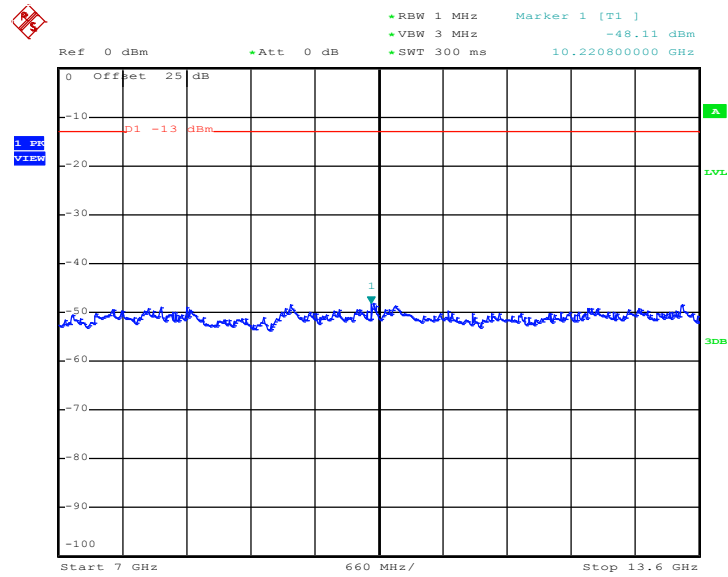

Date: 13.AUG.2014 11:28:26



Conducted Spurious Emission Plot between 13.6GHz ~ 19.1GHz

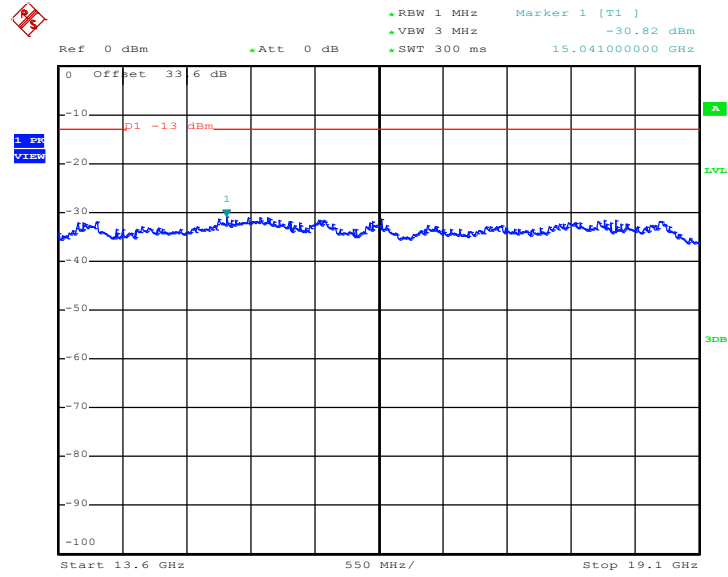

Date: 13.AUG.2014 11:28:34



| | | | |
|--------------------|--------------------------|--------------------|------------|
| Band : | GSM1900 | Channel : | CH661 |
| Test Mode : | EDGE class 8 Link (8PSK) | Frequency : | 1880.0 MHz |

Conducted Spurious Emission Plot between 30MHz ~ 1GHz

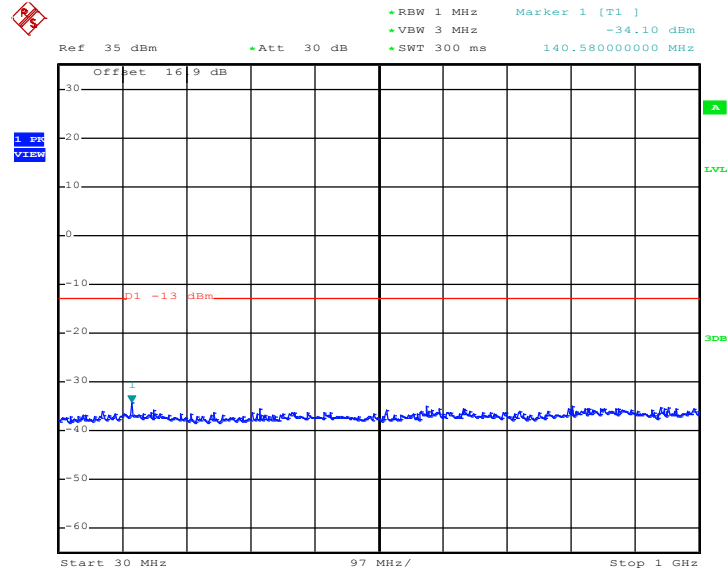

Date: 13.AUG.2014 11:29:47

Conducted Spurious Emission Plot between 1GHz ~ 3GHz

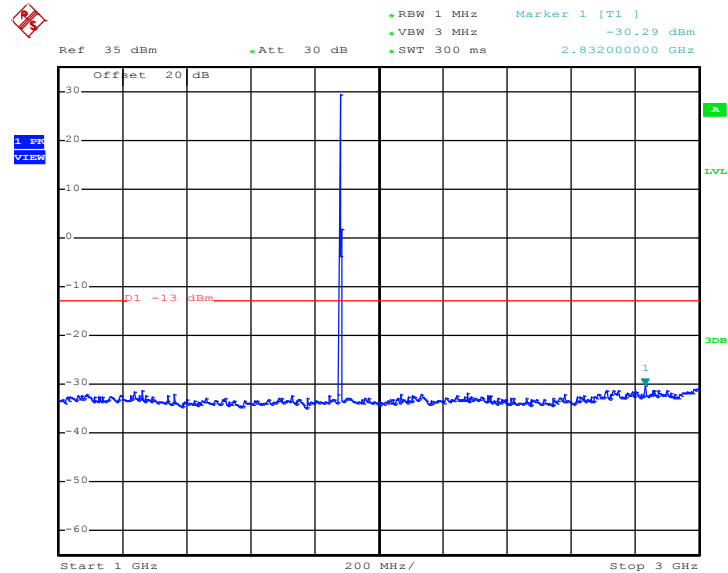

Date: 13.AUG.2014 11:29:56



Conducted Spurious Emission Plot between 3GHz ~ 7GHz

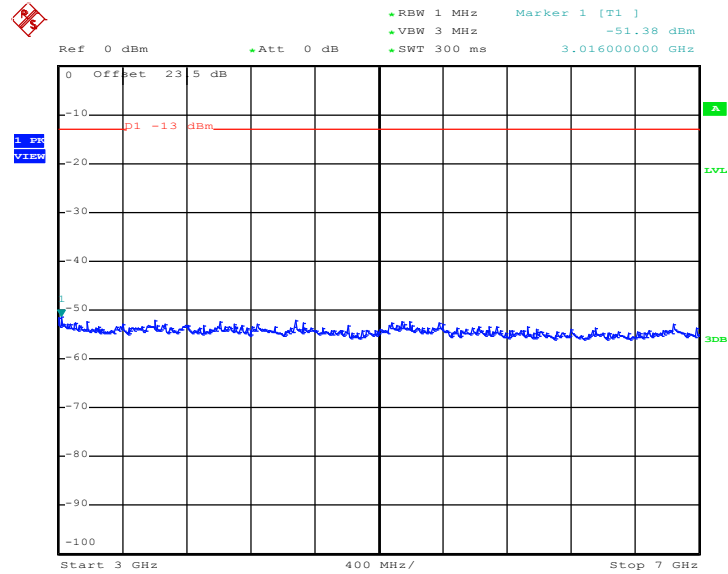

Date: 13.AUG.2014 11:30:06

Conducted Spurious Emission Plot between 7GHz ~ 13.6GHz

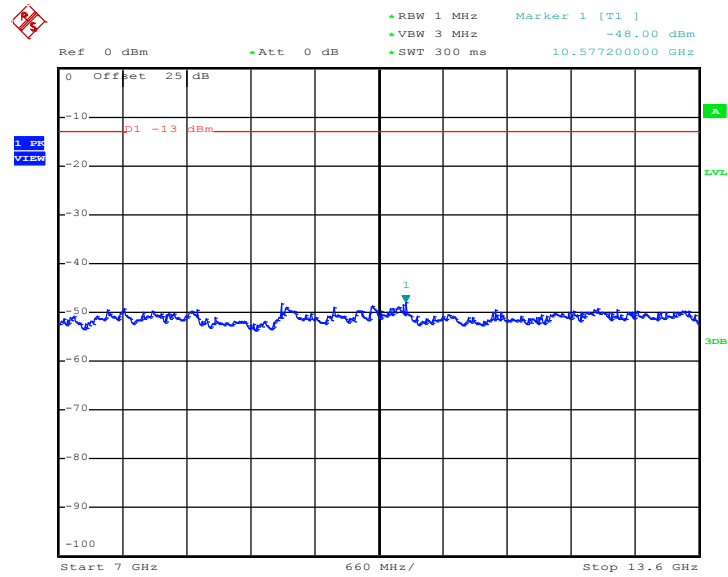

Date: 13.AUG.2014 11:30:15



Conducted Spurious Emission Plot between 13.6GHz ~ 19.1GHz

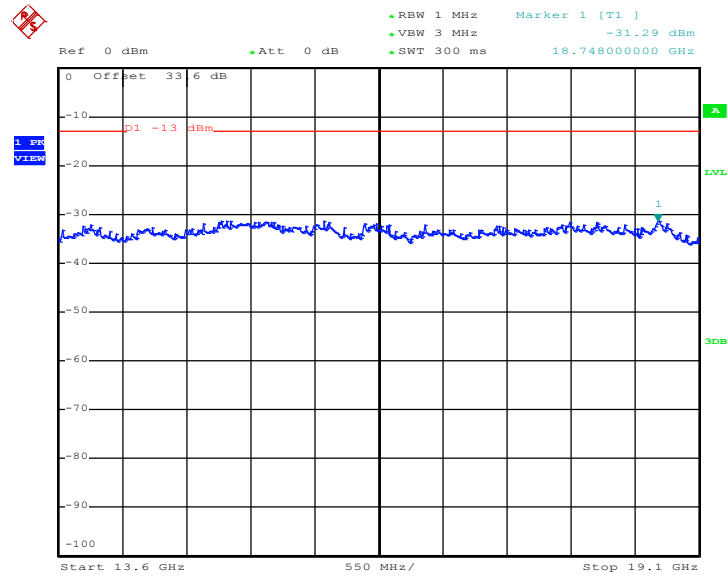

Date: 13.AUG.2014 11:30:23



| | | | |
|--------------------|--------------------------|--------------------|------------|
| Band : | GSM1900 | Channel : | CH810 |
| Test Mode : | EDGE class 8 Link (8PSK) | Frequency : | 1909.8 MHz |

Conducted Spurious Emission Plot between 30MHz ~ 1GHz

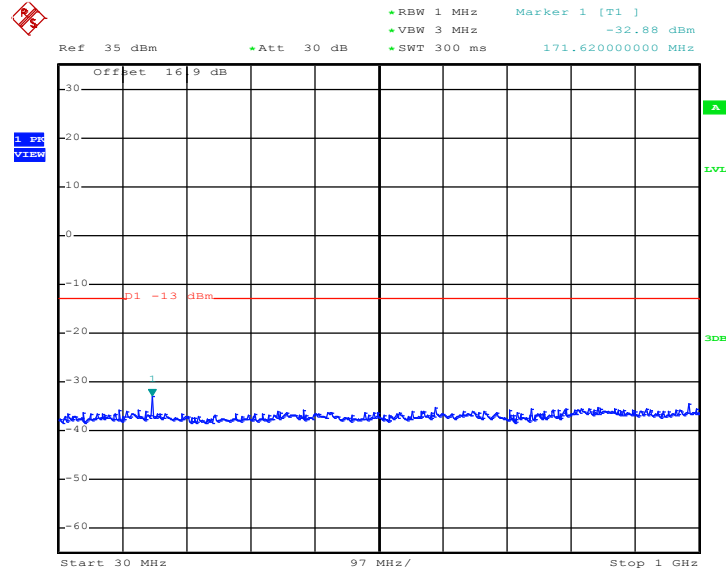

Date: 13.AUG.2014 11:31:12

Conducted Spurious Emission Plot between 1GHz ~ 3GHz

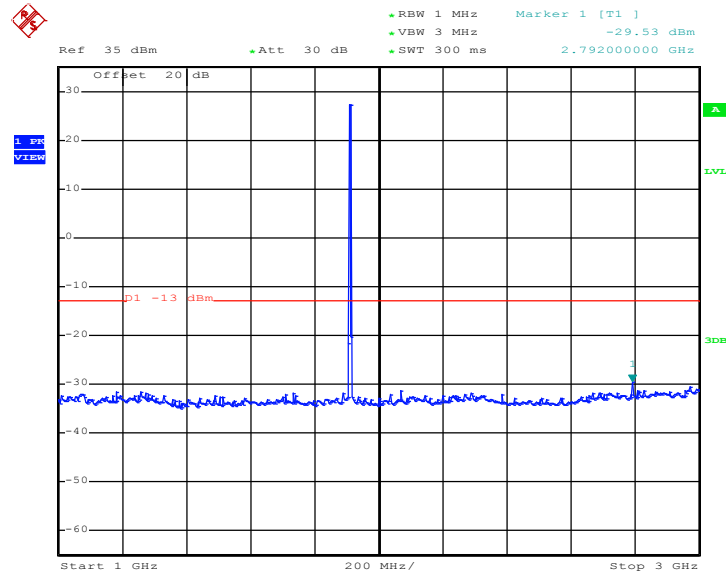

Date: 13.AUG.2014 11:31:20



Conducted Spurious Emission Plot between 3GHz ~ 7GHz

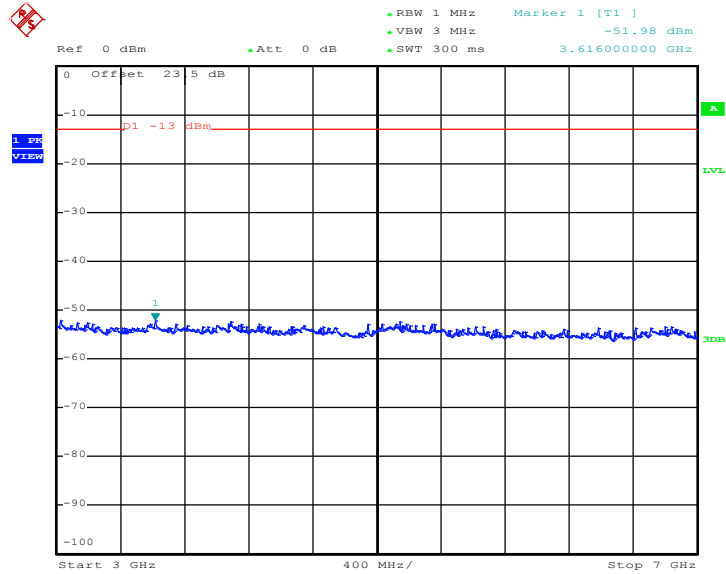

Date: 13.AUG.2014 11:31:31

Conducted Spurious Emission Plot between 7GHz ~ 13.6GHz

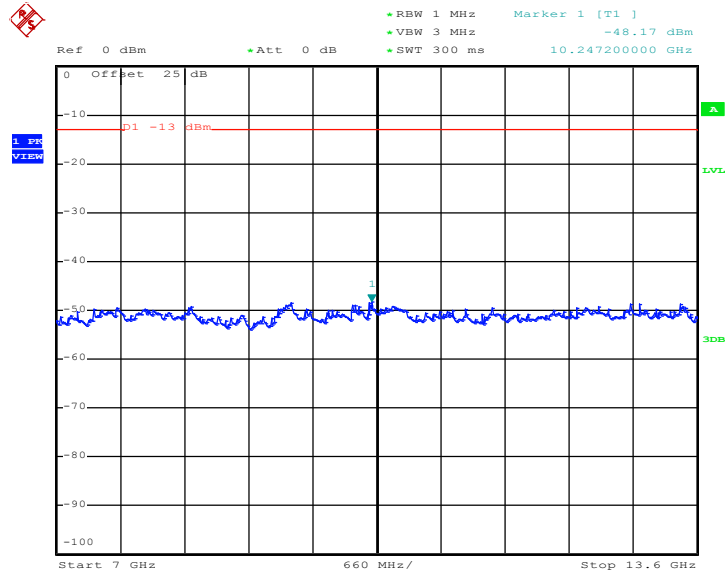

Date: 13.AUG.2014 11:31:39



Conducted Spurious Emission Plot between 13.6GHz ~ 19.1GHz

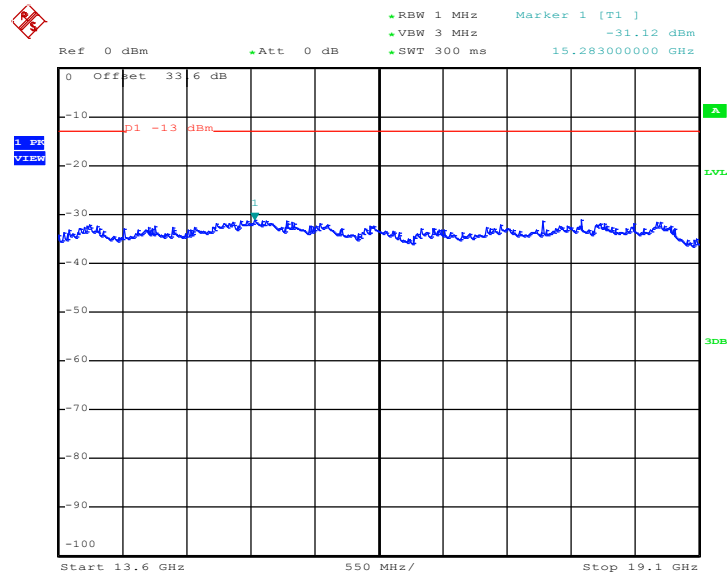

Date: 13.AUG.2014 11:31:48



| | | | |
|-------------|--------------------------|-------------|-----------|
| Band : | WCDMA Band V | Channel : | CH4132 |
| Test Mode : | RMC 12.2Kbps Link (QPSK) | Frequency : | 826.4 MHz |

Conducted Spurious Emission Plot between 30MHz ~ 1GHz

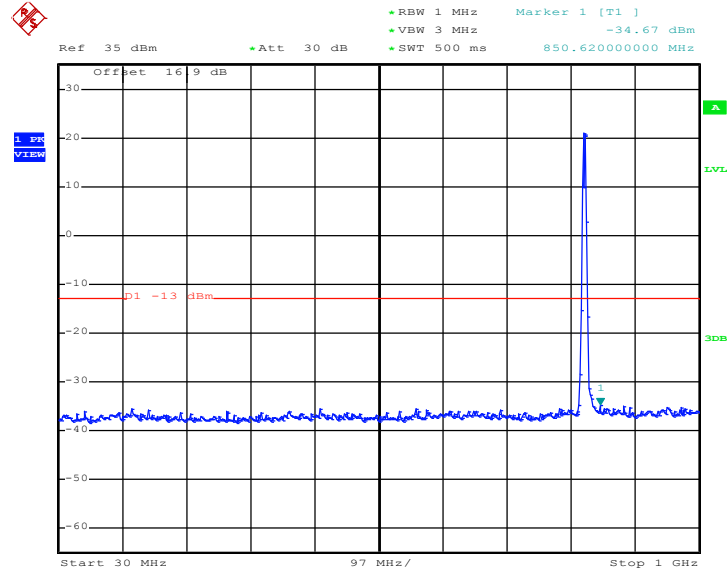

Date: 13.AUG.2014 14:33:09

Conducted Spurious Emission Plot between 1GHz ~ 3GHz

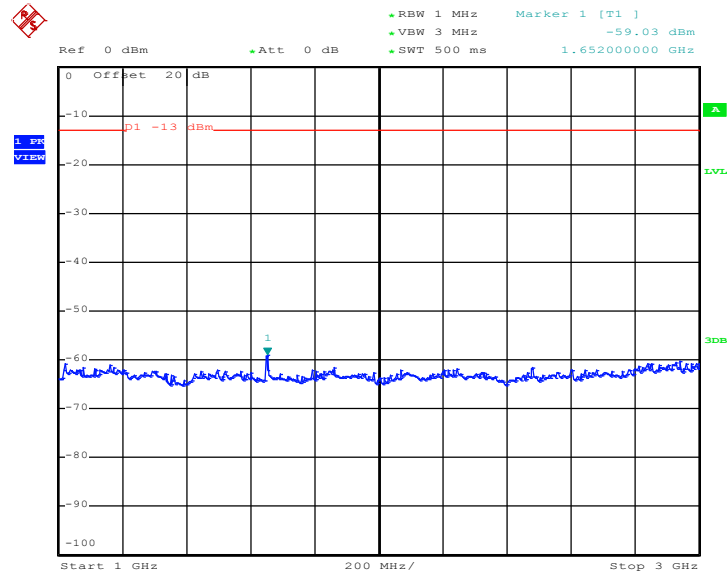

Date: 13.AUG.2014 14:33:20



Conducted Spurious Emission Plot between 3GHz ~ 7GHz

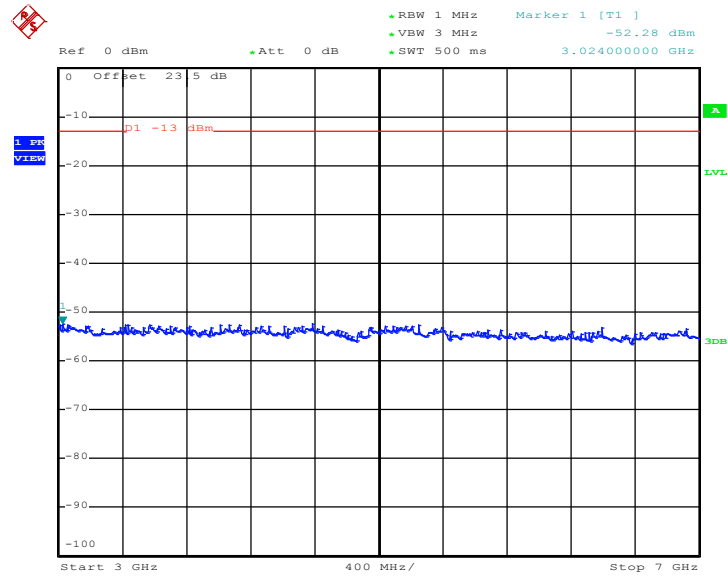

Date: 13.AUG.2014 14:33:29

Conducted Spurious Emission Plot between 7GHz ~ 9GHz

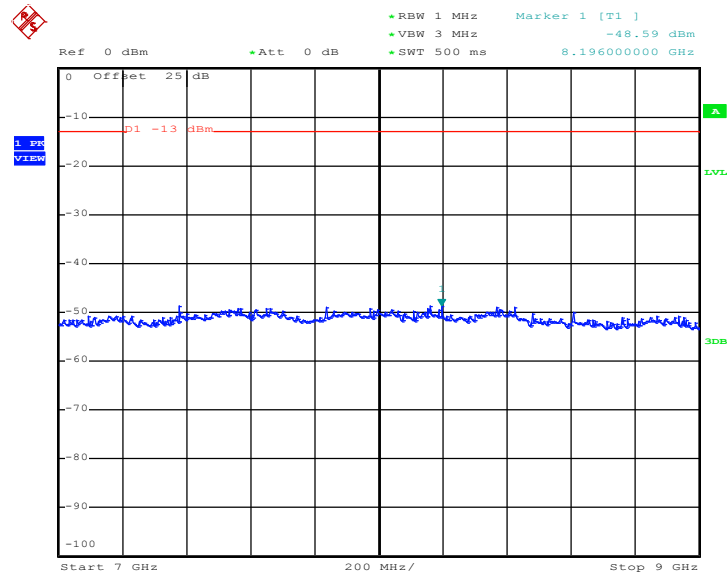

Date: 13.AUG.2014 14:33:37



| | | | |
|--------------------|--------------------------|--------------------|-----------|
| Band : | WCDMA Band V | Channel : | CH4182 |
| Test Mode : | RMC 12.2Kbps Link (QPSK) | Frequency : | 836.4 MHz |

Conducted Spurious Emission Plot between 30MHz ~ 1GHz

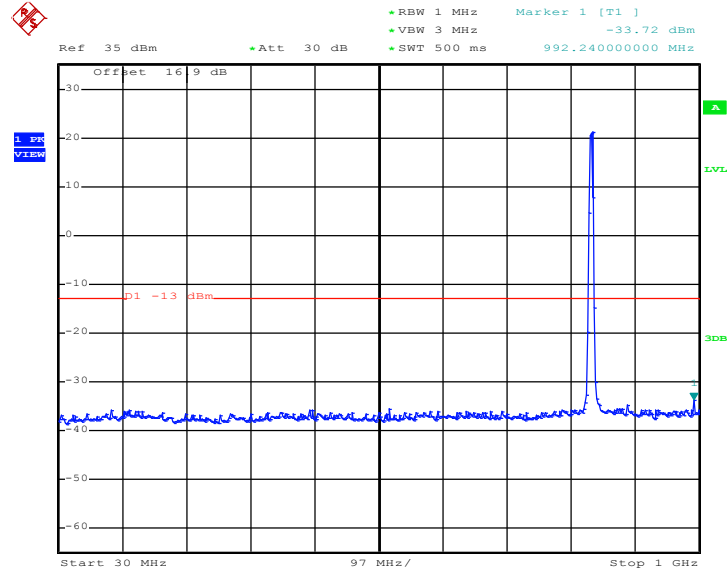

Date: 13.AUG.2014 14:19:47

Conducted Spurious Emission Plot between 1GHz ~ 3GHz

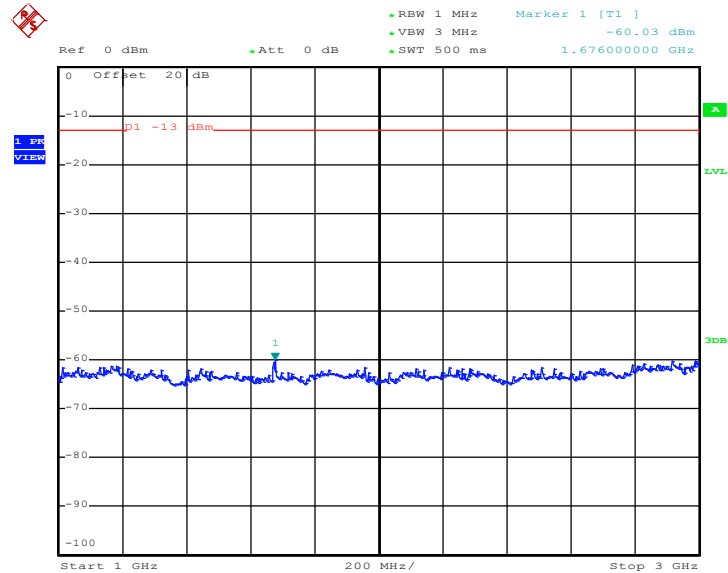

Date: 13.AUG.2014 14:20:12



Conducted Spurious Emission Plot between 3GHz ~ 7GHz

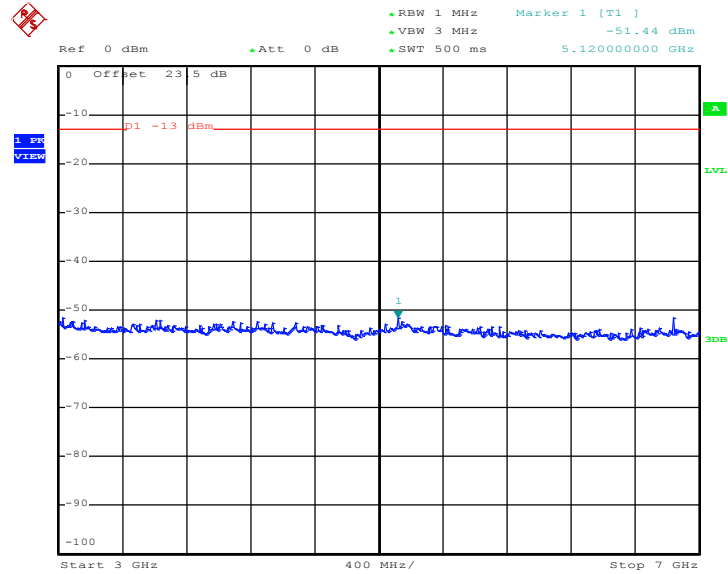

Date: 13.AUG.2014 14:20:21

Conducted Spurious Emission Plot between 7GHz ~ 9GHz

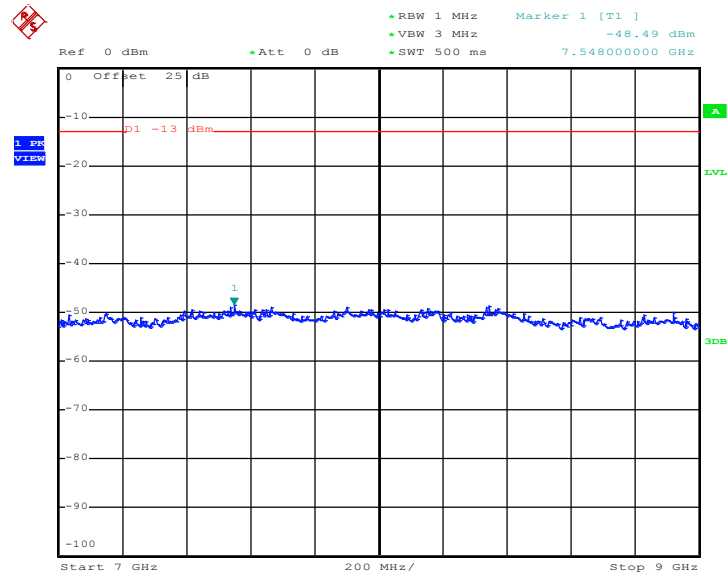

Date: 13.AUG.2014 14:20:29



| | | | |
|--------------------|--------------------------|--------------------|-----------|
| Band : | WCDMA Band V | Channel : | CH4233 |
| Test Mode : | RMC 12.2Kbps Link (QPSK) | Frequency : | 846.6 MHz |

Conducted Spurious Emission Plot between 30MHz ~ 1GHz

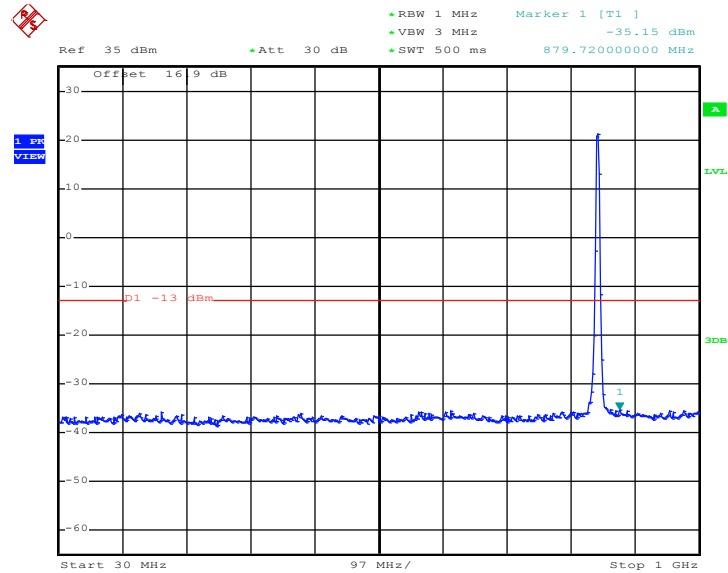

Date: 13.AUG.2014 14:35:25

Conducted Spurious Emission Plot between 1GHz ~ 3GHz

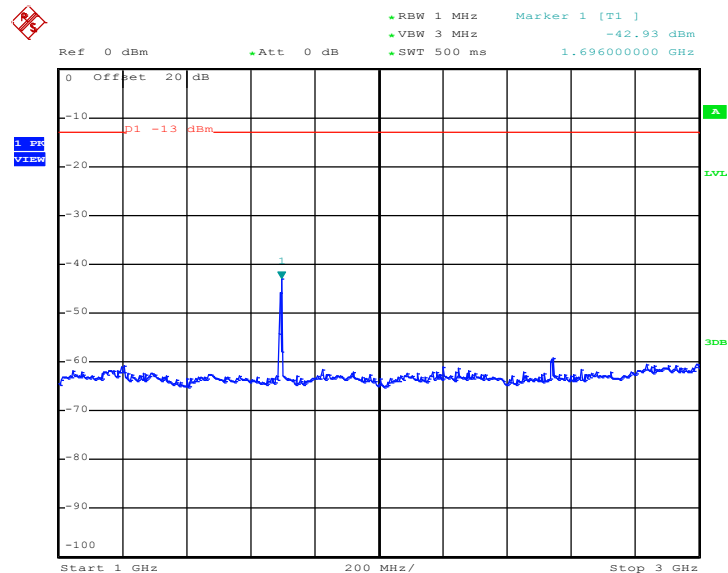

Date: 13.AUG.2014 14:35:35



Conducted Spurious Emission Plot between 3GHz ~ 7GHz

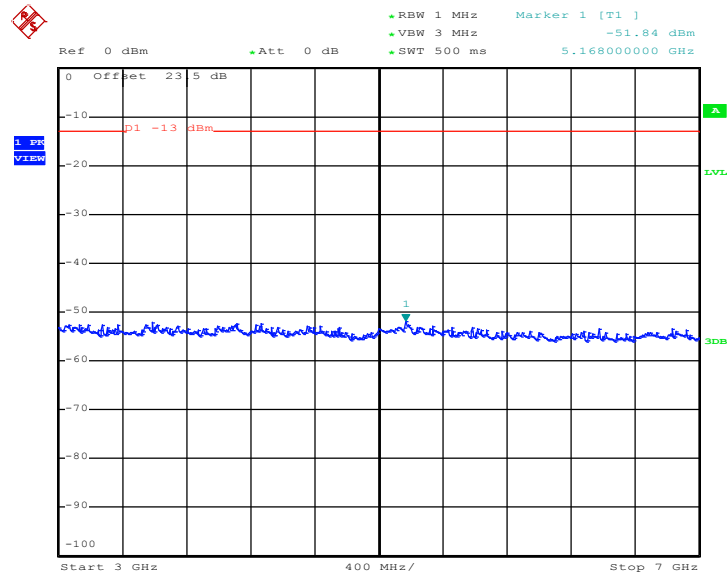

Date: 13.AUG.2014 14:35:43

Conducted Spurious Emission Plot between 7GHz ~ 9GHz

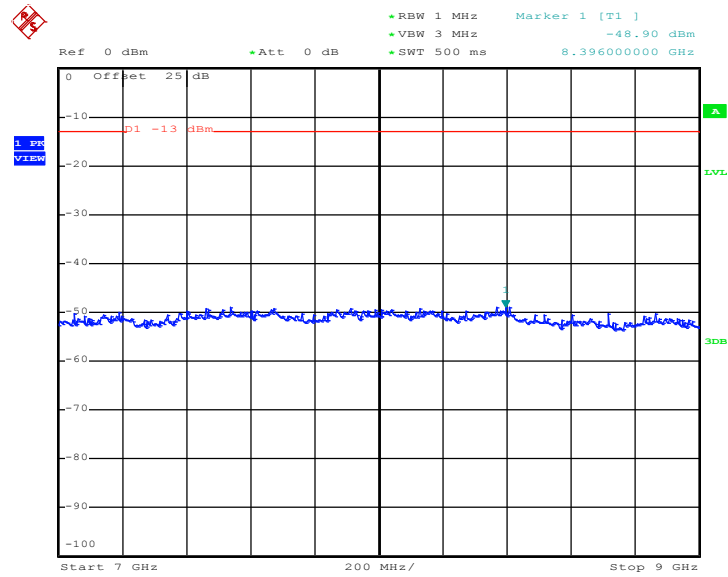

Date: 13.AUG.2014 14:35:52



| | | | |
|-------------|--------------------------|-------------|------------|
| Band : | WCDMA Band IV | Channel : | CH1312 |
| Test Mode : | RMC 12.2Kbps Link (QPSK) | Frequency : | 1712.4 MHz |

Conducted Spurious Emission Plot between 30MHz ~ 1GHz

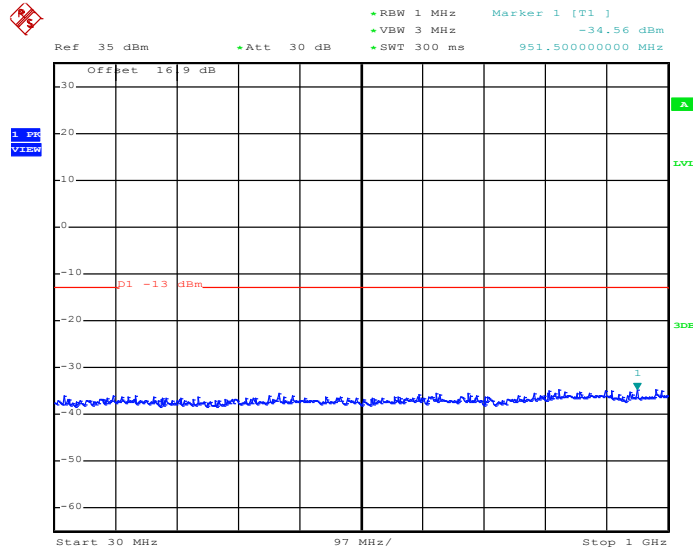

Date: 13.AUG.2014 13:53:50

Conducted Spurious Emission Plot between 1GHz ~ 3GHz

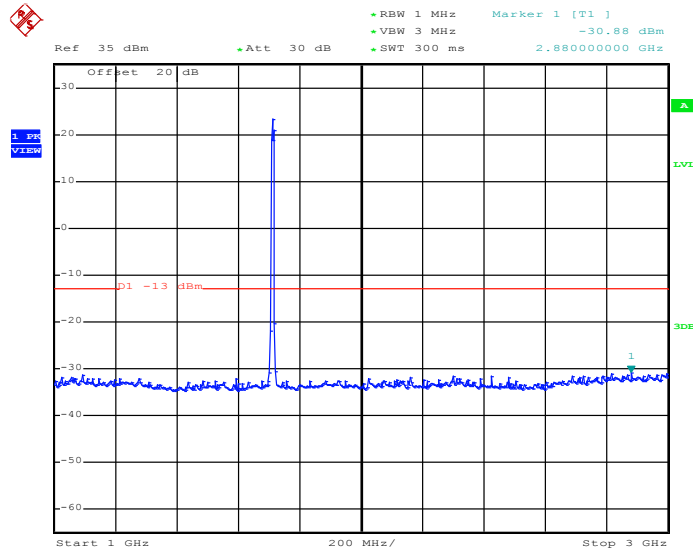

Date: 13.AUG.2014 13:53:58



Conducted Spurious Emission Plot between 3GHz ~ 7GHz

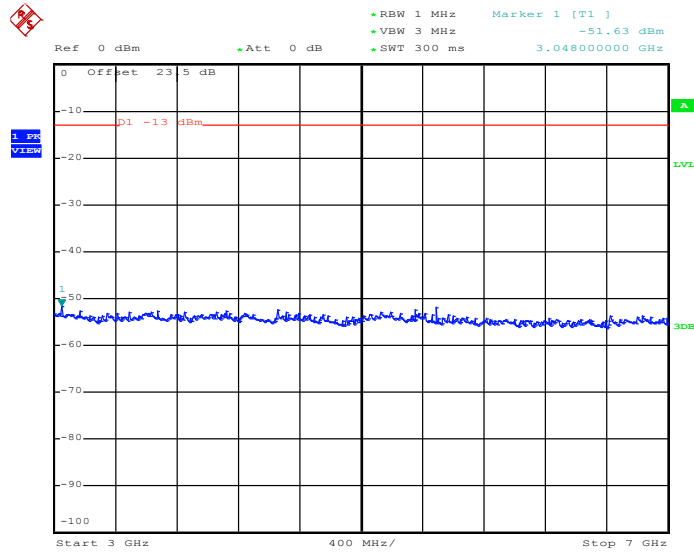

Date: 13.AUG.2014 13:54:10

Conducted Spurious Emission Plot between 7GHz ~ 13.6GHz

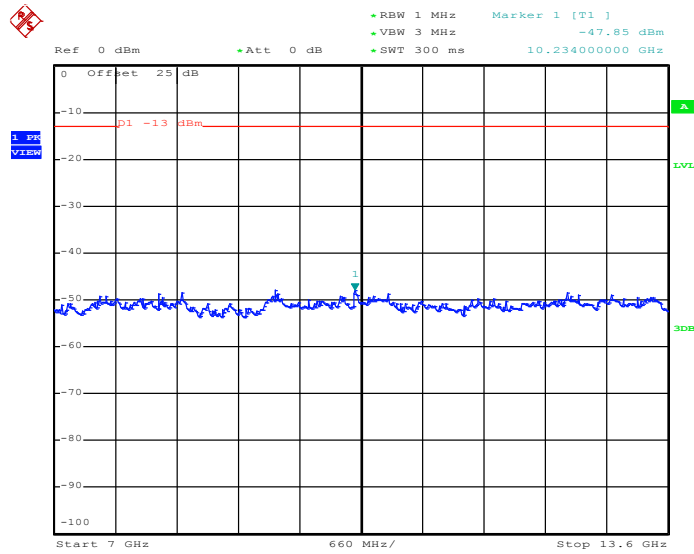

Date: 13.AUG.2014 13:54:19



Conducted Spurious Emission Plot between 13.6GHz ~ 18GHz

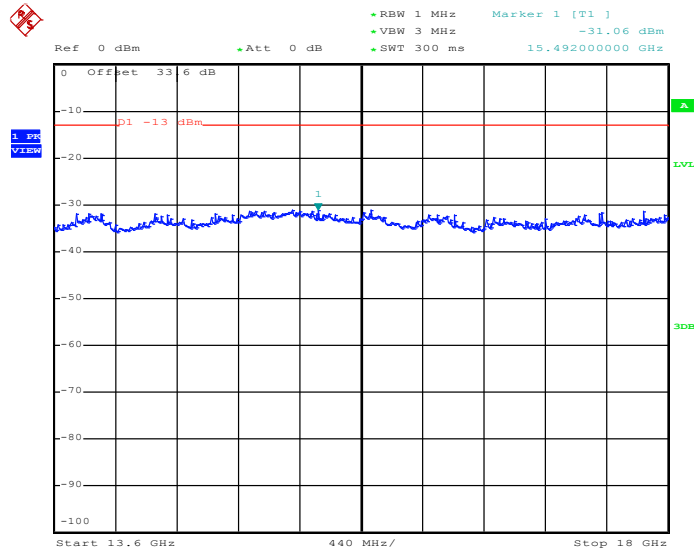

Date: 13.AUG.2014 13:54:27



| | | | |
|-------------|--------------------------|-------------|------------|
| Band : | WCDMA Band IV | Channel : | CH1413 |
| Test Mode : | RMC 12.2Kbps Link (QPSK) | Frequency : | 1732.6 MHz |

Conducted Spurious Emission Plot between 30MHz ~ 1GHz

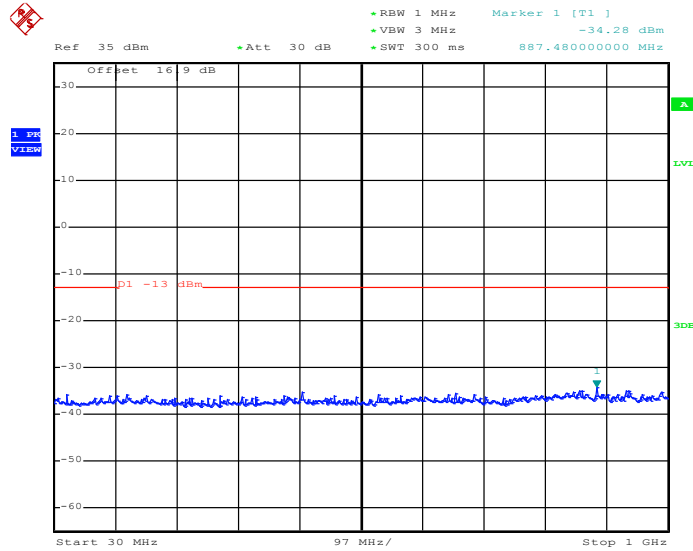

Date: 13.AUG.2014 13:52:33

Conducted Spurious Emission Plot between 1GHz ~ 3GHz

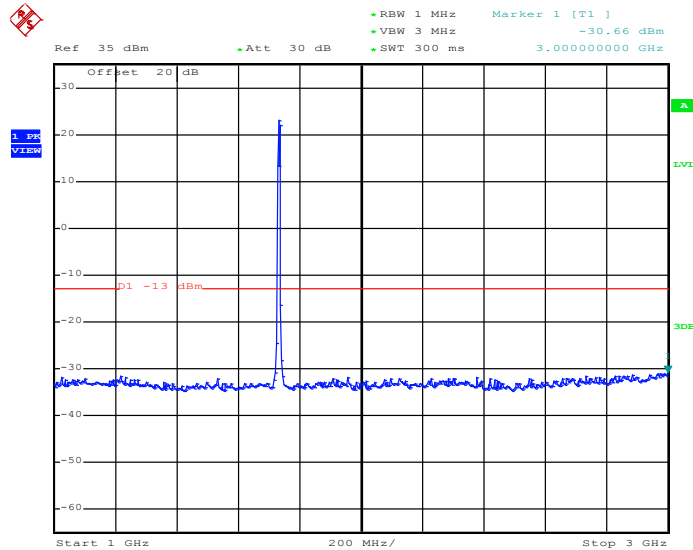

Date: 13.AUG.2014 13:52:41



Conducted Spurious Emission Plot between 3GHz ~ 7GHz

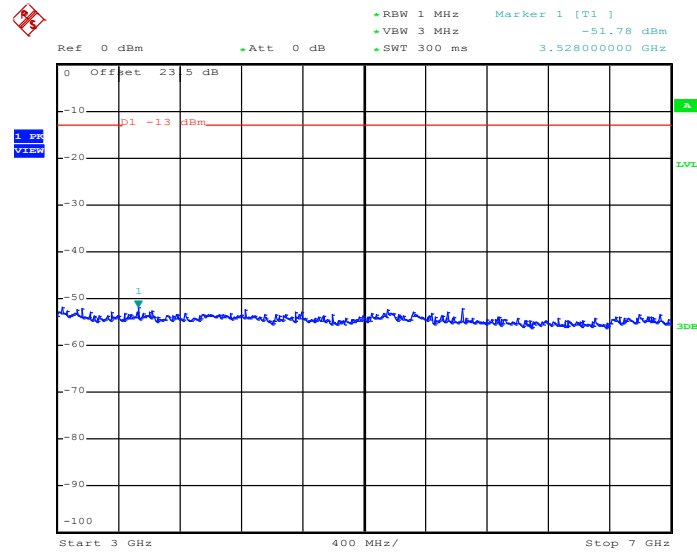

Date: 13.AUG.2014 13:52:54

Conducted Spurious Emission Plot between 7GHz ~ 13.6GHz

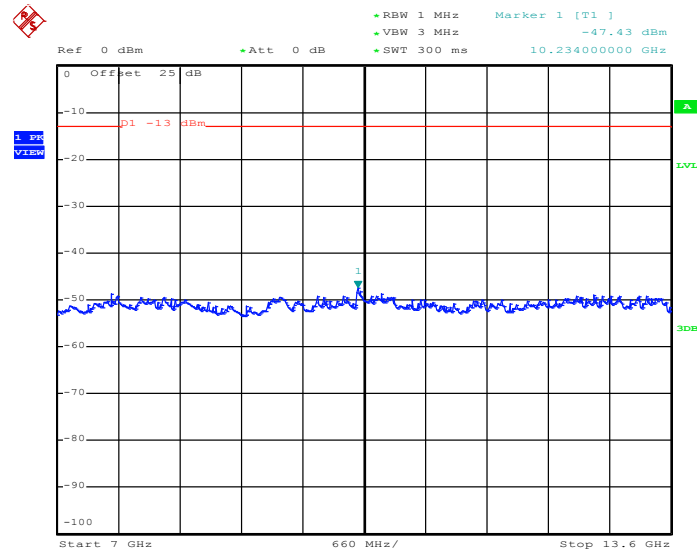

Date: 13.AUG.2014 13:53:02



Conducted Spurious Emission Plot between 13.6GHz ~ 18GHz

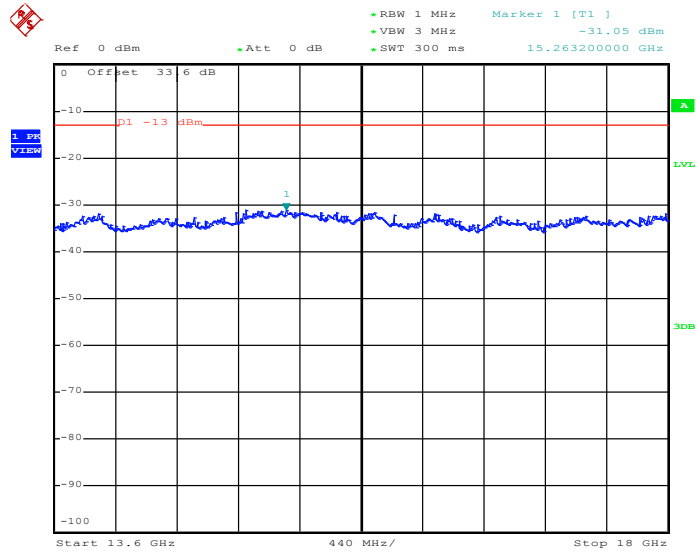

Date: 13.AUG.2014 13:53:11



| | | | |
|-------------|--------------------------|-------------|------------|
| Band : | WCDMA Band IV | Channel : | CH1513 |
| Test Mode : | RMC 12.2Kbps Link (QPSK) | Frequency : | 1752.6 MHz |

Conducted Spurious Emission Plot between 30MHz ~ 1GHz

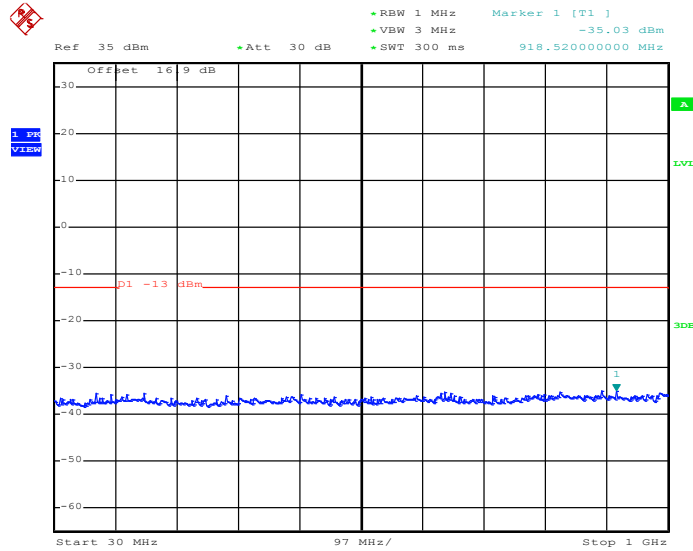

Date: 13.AUG.2014 13:56:00

Conducted Spurious Emission Plot between 1GHz ~ 3GHz

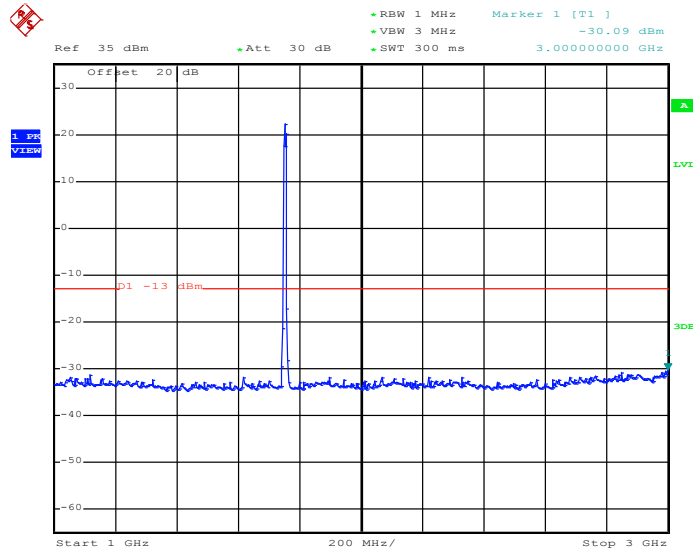

Date: 13.AUG.2014 13:56:08



Conducted Spurious Emission Plot between 3GHz ~ 7GHz

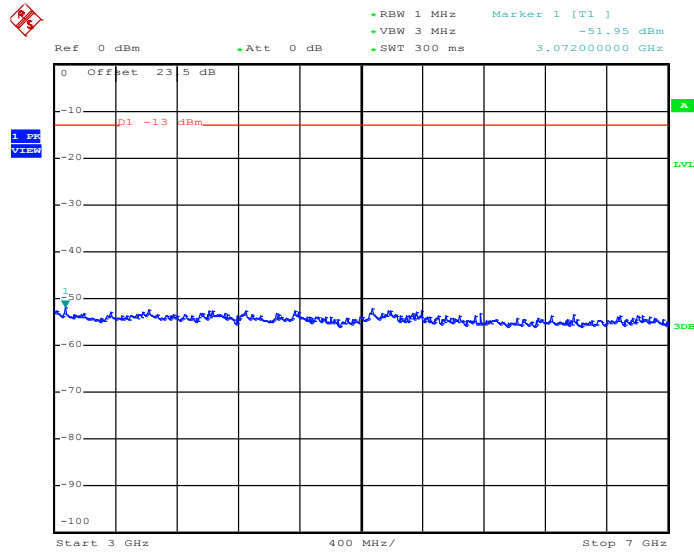

Date: 13.AUG.2014 13:56:19

Conducted Spurious Emission Plot between 7GHz ~ 13.6GHz

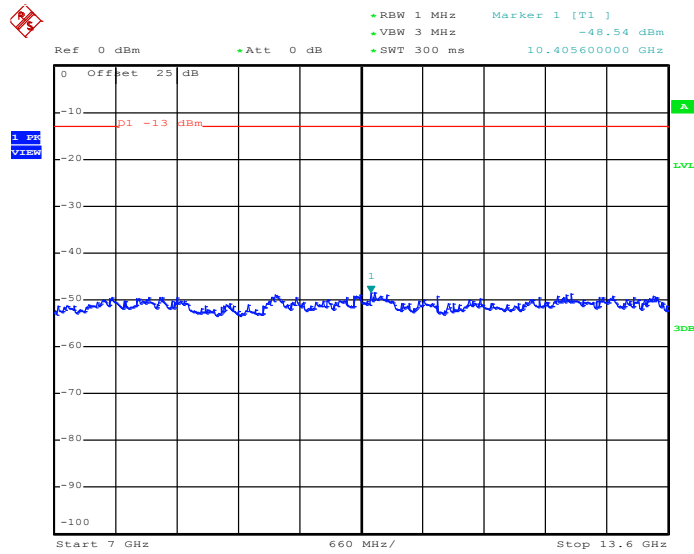

Date: 13.AUG.2014 13:56:28



Conducted Spurious Emission Plot between 13.6GHz ~ 18GHz

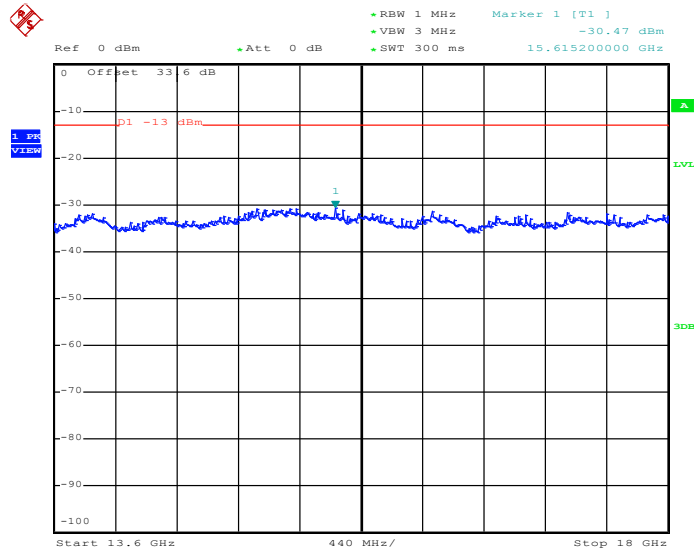

Date: 13.AUG.2014 13:56:36



| | | | |
|--------------------|--------------------------|--------------------|------------|
| Band : | WCDMA Band II | Channel : | CH9262 |
| Test Mode : | RMC 12.2Kbps Link (QPSK) | Frequency : | 1852.4 MHz |

Conducted Spurious Emission Plot between 30MHz ~ 1GHz

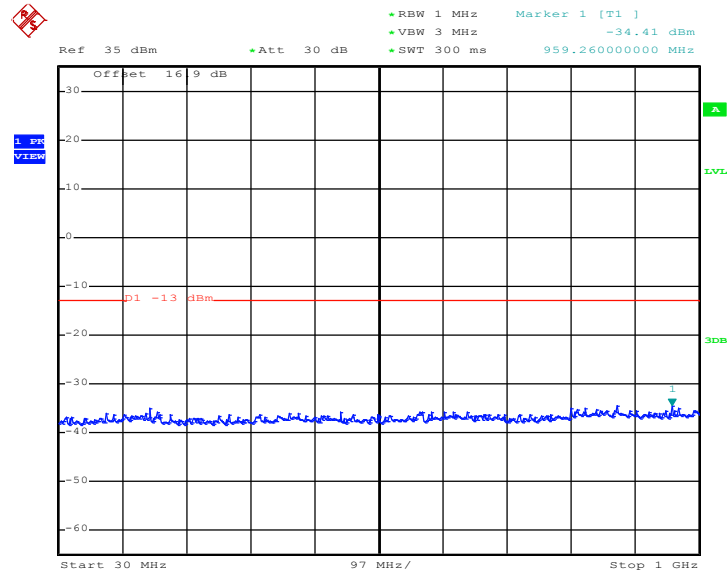

Date: 13.AUG.2014 12:54:35

Conducted Spurious Emission Plot between 1GHz ~ 3GHz

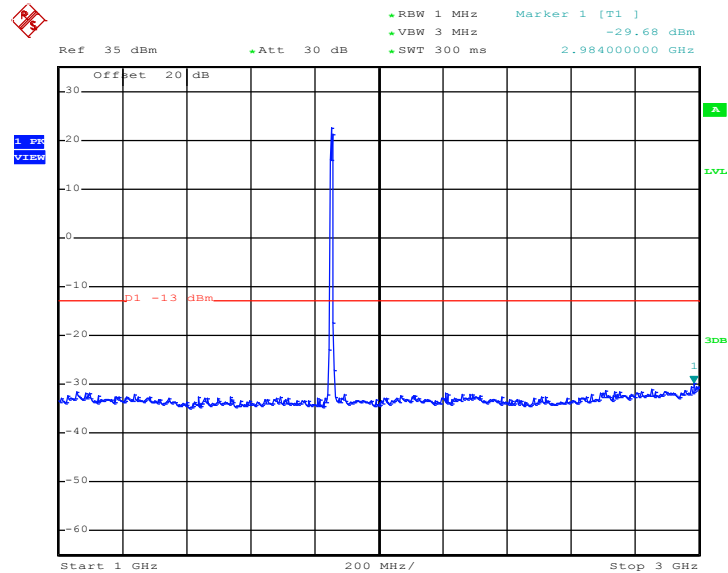

Date: 13.AUG.2014 12:54:44



Conducted Spurious Emission Plot between 3GHz ~ 7GHz

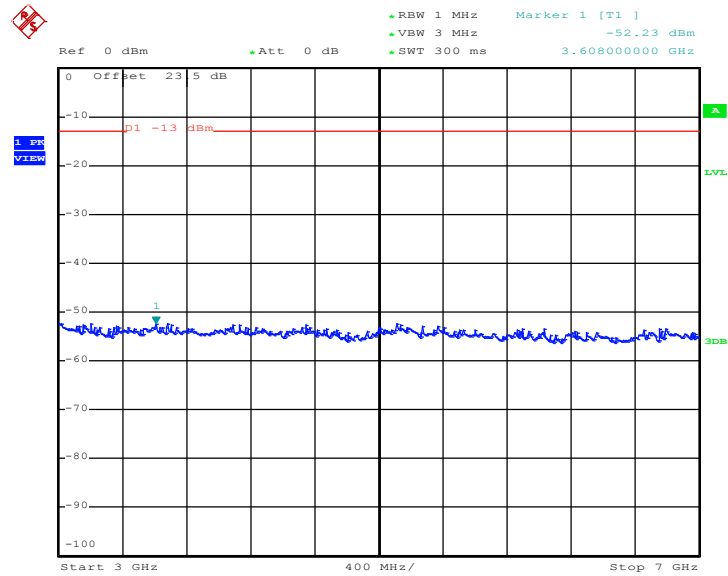

Date: 13.AUG.2014 12:54:55

Conducted Spurious Emission Plot between 7GHz ~ 13.6GHz

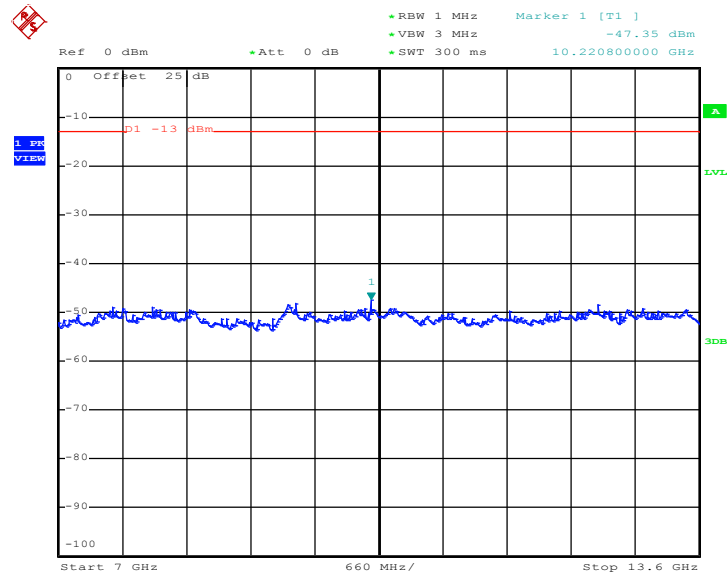

Date: 13.AUG.2014 12:55:03



Conducted Spurious Emission Plot between 13.6GHz ~ 19.1GHz

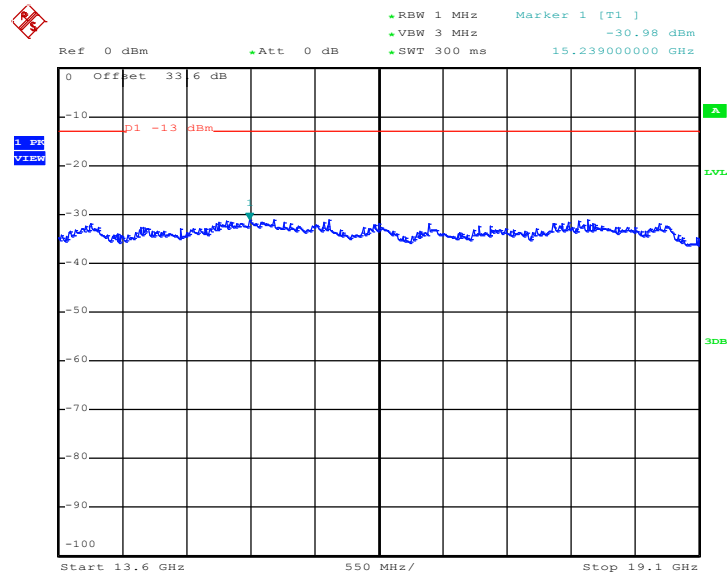

Date: 13.AUG.2014 12:55:12



| | | | |
|--------------------|--------------------------|--------------------|------------|
| Band : | WCDMA Band II | Channel : | CH9400 |
| Test Mode : | RMC 12.2Kbps Link (QPSK) | Frequency : | 1880.0 MHz |

Conducted Spurious Emission Plot between 30MHz ~ 1GHz

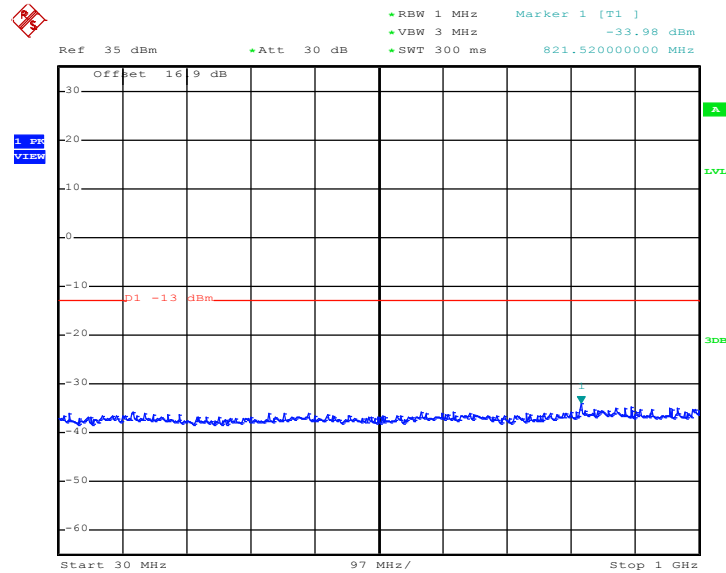

Date: 13.AUG.2014 12:53:01

Conducted Spurious Emission Plot between 1GHz ~ 3GHz

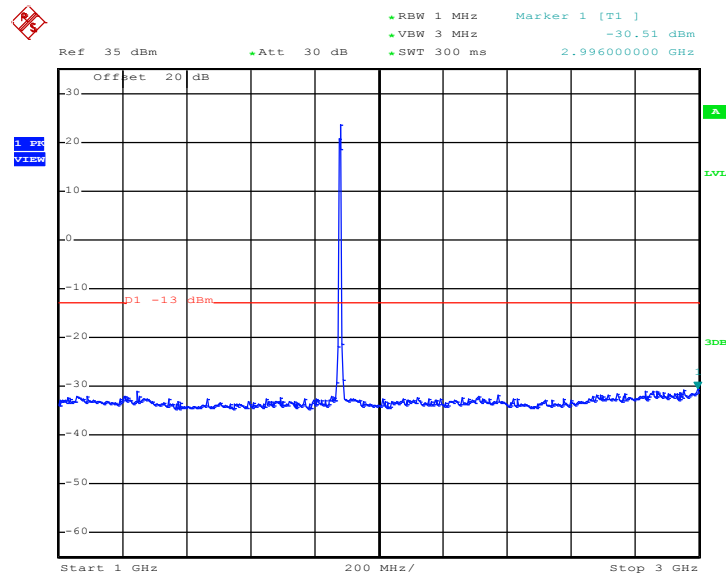

Date: 13.AUG.2014 12:53:10



Conducted Spurious Emission Plot between 3GHz ~ 7GHz

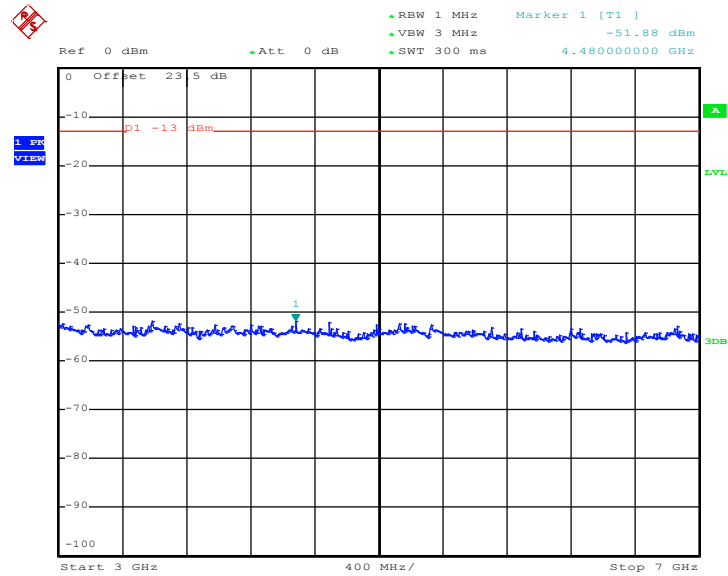

Date: 13.AUG.2014 12:53:21

Conducted Spurious Emission Plot between 7GHz ~ 13.6GHz

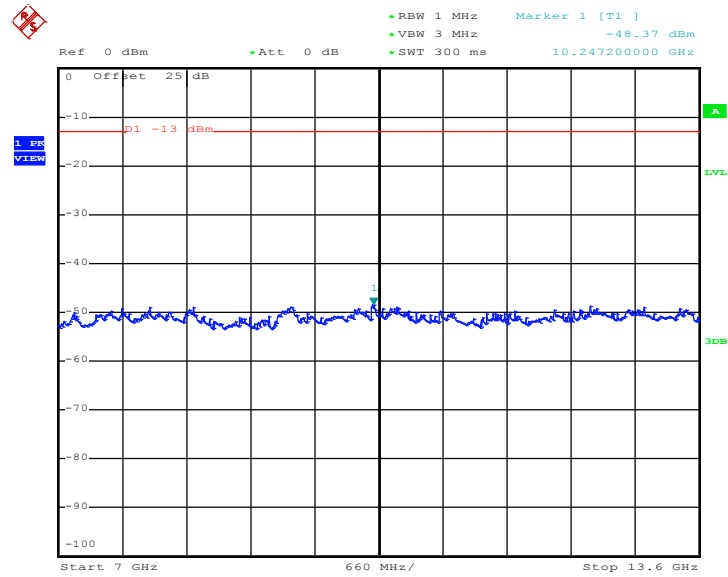

Date: 13.AUG.2014 12:53:29



Conducted Spurious Emission Plot between 13.6GHz ~ 19.1GHz

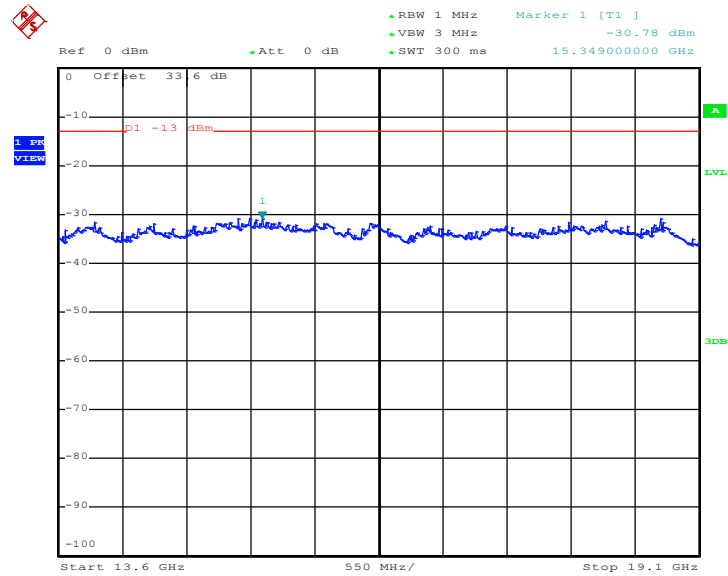

Date: 13.AUG.2014 12:53:37



| | | | |
|--------------------|--------------------------|--------------------|------------|
| Band : | WCDMA Band II | Channel : | CH9538 |
| Test Mode : | RMC 12.2Kbps Link (QPSK) | Frequency : | 1907.6 MHz |

Conducted Spurious Emission Plot between 30MHz ~ 1GHz

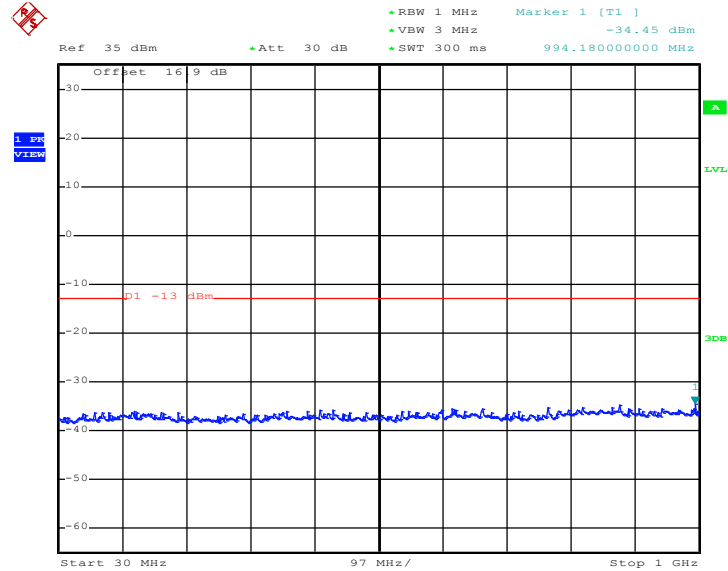

Date: 13.AUG.2014 12:56:11

Conducted Spurious Emission Plot between 1GHz ~ 3GHz

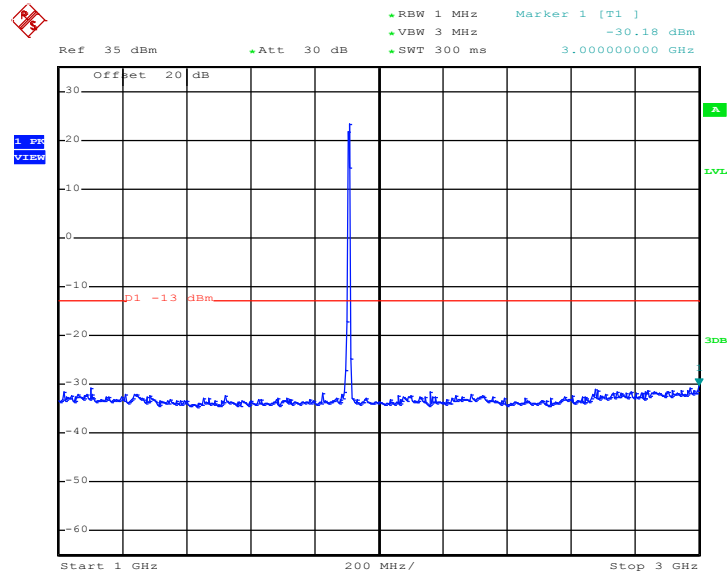

Date: 13.AUG.2014 12:56:20



Conducted Spurious Emission Plot between 3GHz ~ 7GHz

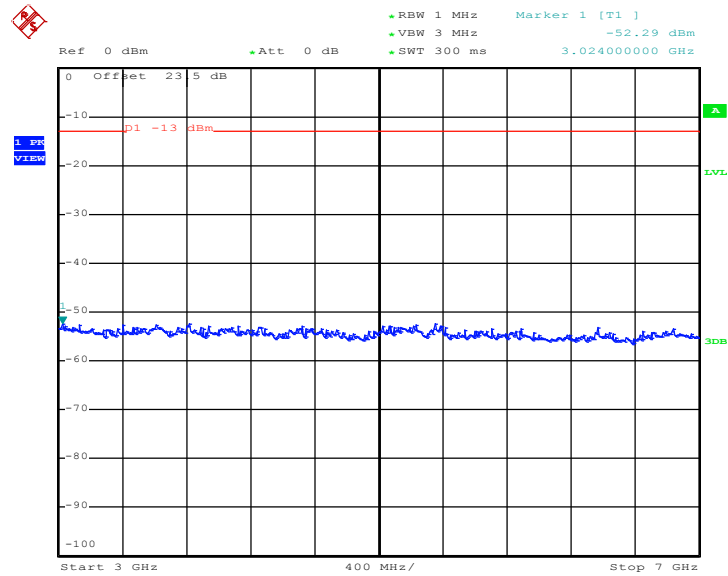

Date: 13.AUG.2014 12:56:30

Conducted Spurious Emission Plot between 7GHz ~ 13.6GHz

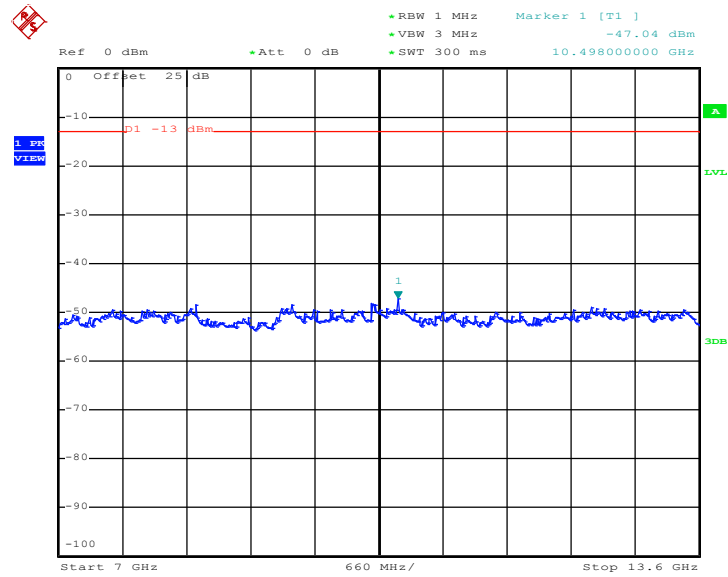

Date: 13.AUG.2014 12:56:38



Conducted Spurious Emission Plot between 13.6GHz ~ 19.1GHz

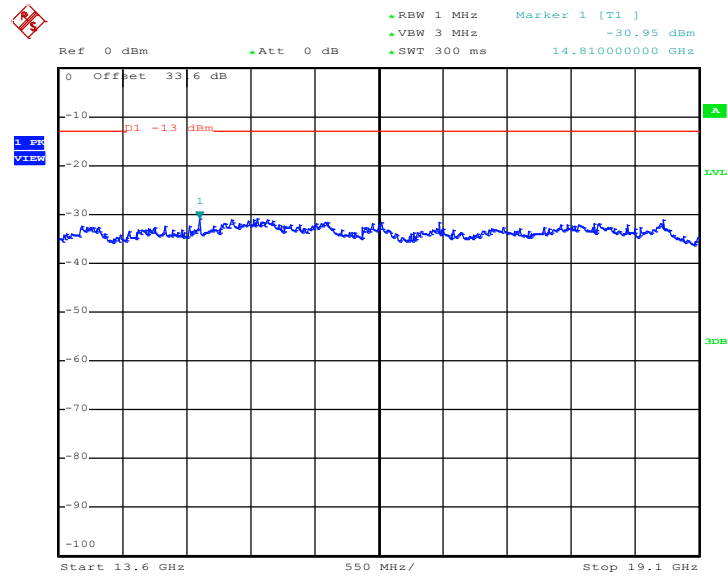

Date: 13.AUG.2014 12:56:47



3.7 Field Strength of Spurious Radiation Measurement

3.7.1 Description of Field Strength of Spurious Radiated Measurement

The power of any emission outside of the authorized operating frequency ranges must be attenuated below the transmitter power (P) by a factor of at least $43 + 10 \log (P)$ dB. The spectrum is scanned from 30 MHz up to a frequency including its 10th harmonic.

3.7.2 Measuring Instruments

The measuring equipment is listed in the section 4 of this test report.

3.7.3 Test Procedures

1. The testing follows FCC KDB 971168 v02r01 Section 5.8 and ANSI / TIA-603-C-2004 Section 2.2.12.
2. The EUT was placed on a rotatable wooden table 0.8 meters above the ground.
3. The EUT was set 3 meters from the receiving antenna, which was mounted on the antenna tower.
4. The table was rotated 360 degrees to determine the position of the highest spurious emission.
5. The height of the receiving antenna is varied between one meter and four meters to search for the maximum spurious emission for both horizontal and vertical polarizations.
6. Make the measurement with the spectrum analyzer's RBW = 1MHz, VBW = 3MHz, taking record of maximum spurious emission.
7. A horn antenna was substituted in place of the EUT and was driven by a signal generator.
8. Tune the output power of signal generator to the same emission level with EUT maximum spurious emission.
9. Taking the record of output power at antenna port.
10. Repeat step 7 to step 8 for another polarization.
11. $EIRP \text{ (dBm)} = S.G. \text{ Power} - Tx \text{ Cable Loss} + Tx \text{ Antenna Gain}$
12. $ERP \text{ (dBm)} = EIRP - 2.15$
13. The RF fundamental frequency should be excluded against the limit line in the operating frequency band.
14. The limit line is derived from $43 + 10\log(P)$ dB below the transmitter power P(Watts)
 $= P(W) - [43 + 10\log(P)] \text{ (dB)}$
 $= [30 + 10\log(P)] \text{ (dBm)} - [43 + 10\log(P)] \text{ (dB)}$
 $= -13\text{dBm}.$

3.7.4 Test Setup

For radiated emissions from 30MHz to 1GHz

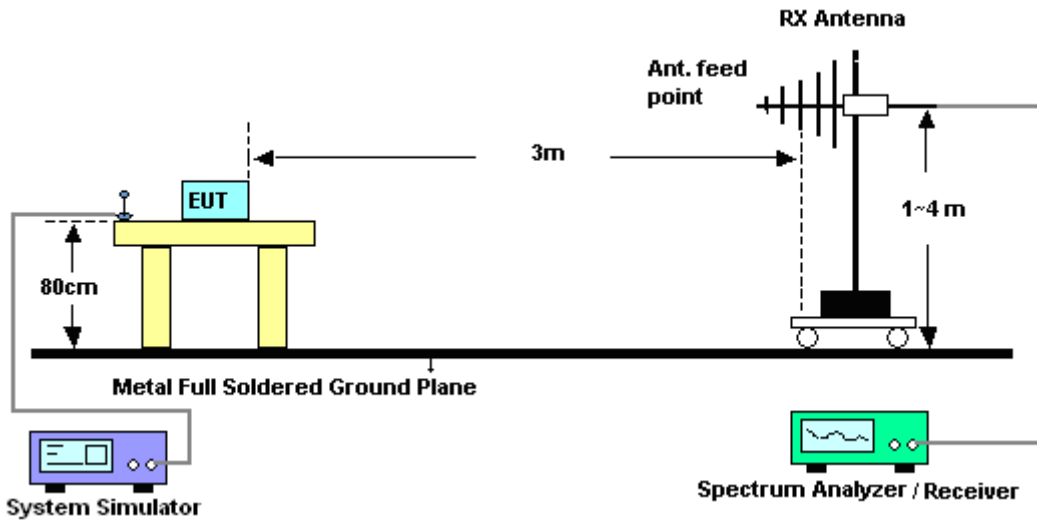

For radiated emissions above 1GHz

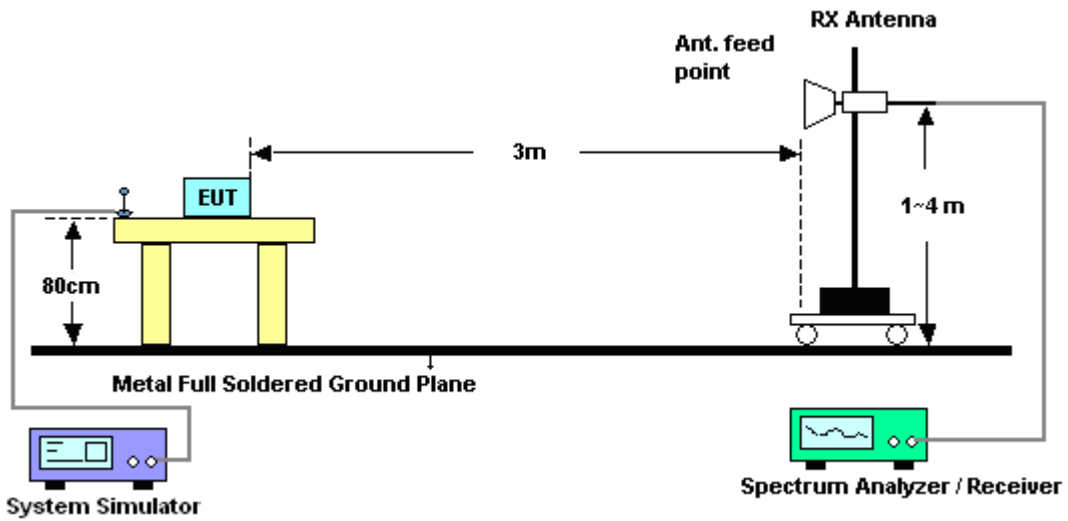



3.7.5 Test Result of Field Strength of Spurious Radiated

<For Sample 1>

<Low Channel>

| Band : | GSM850 | | | | | Temperature : | 21~24°C | | |
|------------------------|--|------------------|-------------------------|---------------------------|--------------------------|----------------------------|-------------------------------|-------------------------|--------|
| Test Mode : | GPRS class 8 Link (GMSK) | | | | | Relative Humidity : | 44~48% | | |
| Test Engineer : | Kai Wang | | | | | Polarization : | Horizontal | | |
| Remark : | Spurious emissions within 30-1000MHz were found more than 20dB below limit line. | | | | | | | | |
| Frequency (MHz) | ERP (dBm) | Limit (dBm) | Over Limit (dB) | SPA Reading (dBm) | S.G. Power (dBm) | TX Cable loss (dB) | TX Antenna Gain (dBi) | Polarization (H/V) | Result |
| 1648 | -53.01 | -13 | -40.01 | -59.42 | -54.86 | 1.53 | 5.53 | H | Pass |
| 2472 | -33.95 | -13 | -20.95 | -44.81 | -35.89 | 2.06 | 6.15 | H | Pass |
| 3296 | -54.45 | -13 | -41.45 | -66.12 | -57.75 | 2.48 | 7.93 | H | Pass |
| 8248 | -43.40 | -13 | -30.40 | -65.52 | -50.39 | 3.66 | 12.80 | H | Pass |

| Band : | GSM850 | | | | | Temperature : | 21~24°C | | |
|------------------------|--|------------------|-------------------------|---------------------------|--------------------------|----------------------------|-------------------------------|-------------------------|--------|
| Test Mode : | GPRS class 8 Link (GMSK) | | | | | Relative Humidity : | 44~48% | | |
| Test Engineer : | Kai Wang | | | | | Polarization : | Vertical | | |
| Remark : | Spurious emissions within 30-1000MHz were found more than 20dB below limit line. | | | | | | | | |
| Frequency (MHz) | ERP (dBm) | Limit (dBm) | Over Limit (dB) | SPA Reading (dBm) | S.G. Power (dBm) | TX Cable loss (dB) | TX Antenna Gain (dBi) | Polarization (H/V) | Result |
| 1648 | -52.90 | -13 | -39.90 | -61.53 | -54.75 | 1.53 | 5.53 | V | Pass |
| 2472 | -34.98 | -13 | -21.98 | -46.28 | -36.92 | 2.06 | 6.15 | V | Pass |
| 3296 | -53.90 | -13 | -40.90 | -67.17 | -57.20 | 2.48 | 7.93 | V | Pass |
| 8248 | -44.44 | -13 | -31.44 | -66.39 | -51.43 | 3.66 | 12.80 | V | Pass |



<Middle Channel>

| Band : | GSM850 | | Temperature : | 21~24°C | | | | | |
|------------------------|--|------------------|----------------------------|---------------------------|--------------------------|----------------------------|-------------------------------|-------------------------|--------|
| Test Mode : | GPRS class 8 Link (GMSK) | | Relative Humidity : | 44~48% | | | | | |
| Test Engineer : | Kai Wang | | Polarization : | Horizontal | | | | | |
| Remark : | Spurious emissions within 30-1000MHz were found more than 20dB below limit line. | | | | | | | | |
| Frequency (MHz) | ERP (dBm) | Limit (dBm) | Over Limit (dB) | SPA Reading (dBm) | S.G. Power (dBm) | TX Cable loss (dB) | TX Antenna Gain (dBi) | Polarization (H/V) | Result |
| 1672 | -56.89 | -13 | -43.89 | -63.45 | -58.61 | 1.62 | 5.49 | H | Pass |
| 2512 | -34.10 | -13 | -21.10 | -45.05 | -36.07 | 2.1 | 6.22 | H | Pass |
| 3344 | -53.90 | -13 | -40.90 | -65.66 | -56.79 | 3.03 | 8.07 | H | Pass |
| 8360 | -40.28 | -13 | -27.28 | -62.84 | -47.12 | 3.95 | 12.94 | H | Pass |

| Band : | GSM850 | | Temperature : | 21~24°C | | | | | |
|------------------------|--|------------------|----------------------------|---------------------------|--------------------------|----------------------------|-------------------------------|-------------------------|--------|
| Test Mode : | GPRS class 8 Link (GMSK) | | Relative Humidity : | 44~48% | | | | | |
| Test Engineer : | Kai Wang | | Polarization : | Vertical | | | | | |
| Remark : | Spurious emissions within 30-1000MHz were found more than 20dB below limit line. | | | | | | | | |
| Frequency (MHz) | ERP (dBm) | Limit (dBm) | Over Limit (dB) | SPA Reading (dBm) | S.G. Power (dBm) | TX Cable loss (dB) | TX Antenna Gain (dBi) | Polarization (H/V) | Result |
| 1672 | -53.01 | -13 | -40.01 | -61.84 | -54.73 | 1.62 | 5.49 | V | Pass |
| 2512 | -37.00 | -13 | -24.00 | -48.41 | -38.97 | 2.1 | 6.22 | V | Pass |
| 3344 | -53.51 | -13 | -40.51 | -66.76 | -56.4 | 3.03 | 8.07 | V | Pass |
| 8360 | -42.30 | -13 | -29.30 | -64.64 | -49.14 | 3.95 | 12.94 | V | Pass |



<High Channel>

| Band : | GSM850 | Temperature : | 21~24°C | | | | | | |
|------------------------|--|----------------------------|-------------------------|---------------------------|--------------------------|----------------------------|-------------------------------|-------------------------|--------|
| Test Mode : | GPRS class 8 Link (GMSK) | Relative Humidity : | 44~48% | | | | | | |
| Test Engineer : | Kai Wang | Polarization : | Horizontal | | | | | | |
| Remark : | Spurious emissions within 30-1000MHz were found more than 20dB below limit line. | | | | | | | | |
| Frequency (MHz) | ERP (dBm) | Limit (dBm) | Over Limit (dB) | SPA Reading (dBm) | S.G. Power (dBm) | TX Cable loss (dB) | TX Antenna Gain (dBi) | Polarization (H/V) | Result |
| 1696 | -55.44 | -13 | -42.44 | -62.11 | -57.17 | 1.57 | 5.45 | H | Pass |
| 2544 | -34.88 | -13 | -21.88 | -45.84 | -36.99 | 2.02 | 6.28 | H | Pass |
| 3392 | -53.92 | -13 | -40.92 | -65.77 | -57.67 | 2.3 | 8.20 | H | Pass |
| 8488 | -39.04 | -13 | -26.04 | -62.08 | -46.12 | 3.85 | 13.08 | H | Pass |

| Band : | GSM850 | Temperature : | 21~24°C | | | | | | |
|------------------------|--|----------------------------|-------------------------|---------------------------|--------------------------|----------------------------|-------------------------------|-------------------------|--------|
| Test Mode : | GPRS class 8 Link (GMSK) | Relative Humidity : | 44~48% | | | | | | |
| Test Engineer : | Kai Wang | Polarization : | Vertical | | | | | | |
| Remark : | Spurious emissions within 30-1000MHz were found more than 20dB below limit line. | | | | | | | | |
| Frequency (MHz) | ERP (dBm) | Limit (dBm) | Over Limit (dB) | SPA Reading (dBm) | S.G. Power (dBm) | TX Cable loss (dB) | TX Antenna Gain (dBi) | Polarization (H/V) | Result |
| 1696 | -55.65 | -13 | -42.65 | -64.57 | -57.38 | 1.57 | 5.45 | V | Pass |
| 2544 | -35.38 | -13 | -22.38 | -46.93 | -37.49 | 2.02 | 6.28 | V | Pass |
| 3392 | -52.91 | -13 | -39.91 | -66.15 | -56.66 | 2.3 | 8.20 | V | Pass |
| 8488 | -41.20 | -13 | -28.20 | -63.92 | -48.28 | 3.85 | 13.08 | V | Pass |



<Low Channel>

| Band : | GSM850 | | Temperature : | 21~24°C | | | | | |
|------------------------|--|------------------|----------------------------|---------------------------|--------------------------|----------------------------|-------------------------------|-------------------------|--------|
| Test Mode : | EDGE class 8 Link (8PSK) | | Relative Humidity : | 44~48% | | | | | |
| Test Engineer : | Kai Wang | | Polarization : | Horizontal | | | | | |
| Remark : | Spurious emissions within 30-1000MHz were found more than 20dB below limit line. | | | | | | | | |
| Frequency (MHz) | ERP (dBm) | Limit (dBm) | Over Limit (dB) | SPA Reading (dBm) | S.G. Power (dBm) | TX Cable loss (dB) | TX Antenna Gain (dBi) | Polarization (H/V) | Result |
| 1648 | -59.18 | -13 | -46.18 | -65.59 | -61.03 | 1.53 | 5.53 | H | Pass |
| 2472 | -38.52 | -13 | -25.52 | -49.38 | -40.46 | 2.06 | 6.15 | H | Pass |
| 3296 | -56.54 | -13 | -43.54 | -68.21 | -59.84 | 2.48 | 7.93 | H | Pass |

| Band : | GSM850 | | Temperature : | 21~24°C | | | | | |
|------------------------|--|------------------|----------------------------|---------------------------|--------------------------|----------------------------|-------------------------------|-------------------------|--------|
| Test Mode : | EDGE class 8 Link (8PSK) | | Relative Humidity : | 44~48% | | | | | |
| Test Engineer : | Kai Wang | | Polarization : | Vertical | | | | | |
| Remark : | Spurious emissions within 30-1000MHz were found more than 20dB below limit line. | | | | | | | | |
| Frequency (MHz) | ERP (dBm) | Limit (dBm) | Over Limit (dB) | SPA Reading (dBm) | S.G. Power (dBm) | TX Cable loss (dB) | TX Antenna Gain (dBi) | Polarization (H/V) | Result |
| 1648 | -55.82 | -13 | -42.82 | -64.46 | -57.67 | 1.53 | 5.53 | V | Pass |
| 2472 | -39.94 | -13 | -26.94 | -51.24 | -41.88 | 2.06 | 6.15 | V | Pass |
| 3296 | -55.02 | -13 | -42.02 | -68.31 | -58.32 | 2.48 | 7.93 | V | Pass |



<Middle Channel>

| Band : | GSM850 | Temperature : | 21~24°C | | | | | | |
|------------------------|--|----------------------------|-------------------------|---------------------------|--------------------------|----------------------------|-------------------------------|-------------------------|--------|
| Test Mode : | EDGE class 8 Link (8PSK) | Relative Humidity : | 44~48% | | | | | | |
| Test Engineer : | Kai Wang | Polarization : | Horizontal | | | | | | |
| Remark : | Spurious emissions within 30-1000MHz were found more than 20dB below limit line. | | | | | | | | |
| Frequency (MHz) | ERP (dBm) | Limit (dBm) | Over Limit (dB) | SPA Reading (dBm) | S.G. Power (dBm) | TX Cable loss (dB) | TX Antenna Gain (dBi) | Polarization (H/V) | Result |
| 1672 | -57.60 | -13 | -44.60 | -64.18 | -59.32 | 1.62 | 5.49 | H | Pass |
| 2512 | -41.84 | -13 | -28.84 | -52.79 | -43.81 | 2.1 | 6.22 | H | Pass |
| 3344 | -55.50 | -13 | -42.50 | -67.26 | -58.39 | 3.03 | 8.07 | H | Pass |

| Band : | GSM850 | Temperature : | 21~24°C | | | | | | |
|------------------------|--|----------------------------|-------------------------|---------------------------|--------------------------|----------------------------|-------------------------------|-------------------------|--------|
| Test Mode : | EDGE class 8 Link (8PSK) | Relative Humidity : | 44~48% | | | | | | |
| Test Engineer : | Kai Wang | Polarization : | Vertical | | | | | | |
| Remark : | Spurious emissions within 30-1000MHz were found more than 20dB below limit line. | | | | | | | | |
| Frequency (MHz) | ERP (dBm) | Limit (dBm) | Over Limit (dB) | SPA Reading (dBm) | S.G. Power (dBm) | TX Cable loss (dB) | TX Antenna Gain (dBi) | Polarization (H/V) | Result |
| 1672 | -56.43 | -13 | -43.43 | -65.25 | -58.15 | 1.62 | 5.49 | V | Pass |
| 2512 | -43.38 | -13 | -30.38 | -54.79 | -45.35 | 2.1 | 6.22 | V | Pass |
| 3344 | -53.15 | -13 | -40.15 | -66.4 | -56.04 | 3.03 | 8.07 | V | Pass |



<High Channel>

| Band : | GSM850 | Temperature : | 21~24°C | | | | | | |
|------------------------|--|----------------------------|-------------------------|---------------------------|--------------------------|----------------------------|-------------------------------|-------------------------|--------|
| Test Mode : | EDGE class 8 Link (8PSK) | Relative Humidity : | 44~48% | | | | | | |
| Test Engineer : | Kai Wang | Polarization : | Horizontal | | | | | | |
| Remark : | Spurious emissions within 30-1000MHz were found more than 20dB below limit line. | | | | | | | | |
| Frequency (MHz) | ERP (dBm) | Limit (dBm) | Over Limit (dB) | SPA Reading (dBm) | S.G. Power (dBm) | TX Cable loss (dB) | TX Antenna Gain (dBi) | Polarization (H/V) | Result |
| 1696 | -59.33 | -13 | -46.33 | -66 | -61.06 | 1.57 | 5.45 | H | Pass |
| 2544 | -40.90 | -13 | -27.90 | -51.87 | -43.01 | 2.02 | 6.28 | H | Pass |
| 3392 | -54.72 | -13 | -41.72 | -66.57 | -58.47 | 2.3 | 8.20 | H | Pass |

| Band : | GSM850 | Temperature : | 21~24°C | | | | | | |
|------------------------|--|----------------------------|-------------------------|---------------------------|--------------------------|----------------------------|-------------------------------|-------------------------|--------|
| Test Mode : | EDGE class 8 Link (8PSK) | Relative Humidity : | 44~48% | | | | | | |
| Test Engineer : | Kai Wang | Polarization : | Vertical | | | | | | |
| Remark : | Spurious emissions within 30-1000MHz were found more than 20dB below limit line. | | | | | | | | |
| Frequency (MHz) | ERP (dBm) | Limit (dBm) | Over Limit (dB) | SPA Reading (dBm) | S.G. Power (dBm) | TX Cable loss (dB) | TX Antenna Gain (dBi) | Polarization (H/V) | Result |
| 1696 | -57.10 | -13 | -44.10 | -66.04 | -58.83 | 1.57 | 5.45 | V | Pass |
| 2544 | -42.60 | -13 | -29.60 | -54.14 | -44.71 | 2.02 | 6.28 | V | Pass |
| 3392 | -54.80 | -13 | -41.80 | -68.04 | -58.55 | 2.3 | 8.20 | V | Pass |



<Low Channel>

| Band : | GSM1900 | | Temperature : | 21~24°C | | | | | |
|------------------------|--|------------------|----------------------------|---------------------------|--------------------------|----------------------------|-------------------------------|-------------------------|--------|
| Test Mode : | GPRS class 8 Link (GMSK) | | Relative Humidity : | 44~48% | | | | | |
| Test Engineer : | Kai Wang | | Polarization : | Horizontal | | | | | |
| Remark : | Spurious emissions within 30-1000MHz were found more than 20dB below limit line. | | | | | | | | |
| Frequency (MHz) | EIRP (dBm) | Limit (dBm) | Over Limit (dB) | SPA Reading (dBm) | S.G. Power (dBm) | TX Cable loss (dB) | TX Antenna Gain (dBi) | Polarization (H/V) | Result |
| 3700 | -47.01 | -13 | -34.01 | -60.8 | -53.16 | 2.59 | 8.74 | H | Pass |
| 5548 | -35.16 | -13 | -22.16 | -53.26 | -42.82 | 3.04 | 10.70 | H | Pass |
| 7403 | -37.66 | -13 | -24.66 | -62.7 | -46.40 | 3.28 | 12.02 | H | Pass |
| 9251 | -41.77 | -13 | -28.77 | -65.68 | -51.07 | 3.9 | 13.20 | H | Pass |
| 12961 | -36.90 | -13 | -23.90 | -67.77 | -45.56 | 4.89 | 13.55 | H | Pass |

| Band : | GSM1900 | | Temperature : | 21~24°C | | | | | |
|------------------------|--|------------------|----------------------------|---------------------------|--------------------------|----------------------------|-------------------------------|-------------------------|--------|
| Test Mode : | GPRS class 8 Link (GMSK) | | Relative Humidity : | 44~48% | | | | | |
| Test Engineer : | Kai Wang | | Polarization : | Vertical | | | | | |
| Remark : | Spurious emissions within 30-1000MHz were found more than 20dB below limit line. | | | | | | | | |
| Frequency (MHz) | EIRP (dBm) | Limit (dBm) | Over Limit (dB) | SPA Reading (dBm) | S.G. Power (dBm) | TX Cable loss (dB) | TX Antenna Gain (dBi) | Polarization (H/V) | Result |
| 3700 | -48.57 | -13 | -35.57 | -62.38 | -54.72 | 2.59 | 8.74 | V | Pass |
| 5548 | -42.85 | -13 | -29.85 | -60.78 | -50.51 | 3.04 | 10.70 | V | Pass |
| 7403 | -41.90 | -13 | -28.90 | -66.57 | -50.64 | 3.28 | 12.02 | V | Pass |
| 9251 | -42.18 | -13 | -29.18 | -65.92 | -51.48 | 3.9 | 13.20 | V | Pass |
| 12961 | -39.65 | -13 | -26.65 | -68.54 | -48.31 | 4.89 | 13.55 | V | Pass |



<Middle Channel>

| Band : | GSM1900 | | Temperature : | 21~24°C | | | | | |
|------------------------|--|------------------|----------------------------|---------------------------|--------------------------|----------------------------|-------------------------------|-------------------------|--------|
| Test Mode : | GPRS class 8 Link (GMSK) | | Relative Humidity : | 44~48% | | | | | |
| Test Engineer : | Kai Wang | | Polarization : | Horizontal | | | | | |
| Remark : | Spurious emissions within 30-1000MHz were found more than 20dB below limit line. | | | | | | | | |
| Frequency (MHz) | ERP (dBm) | Limit (dBm) | Over Limit (dB) | SPA Reading (dBm) | S.G. Power (dBm) | TX Cable loss (dB) | TX Antenna Gain (dBi) | Polarization (H/V) | Result |
| 3756 | -47.16 | -13 | -34.16 | -60.19 | -53.46 | 2.51 | 8.81 | H | Pass |
| 5639 | -33.71 | -13 | -20.71 | -52.13 | -41.42 | 2.99 | 10.70 | H | Pass |
| 7522 | -36.95 | -13 | -23.95 | -61.9 | -45.48 | 3.59 | 12.12 | H | Pass |
| 9398 | -42.24 | -13 | -29.24 | -66.38 | -51.34 | 4.1 | 13.20 | H | Pass |
| 13159 | -36.60 | -13 | -23.60 | -67.7 | -46.12 | 4.27 | 13.79 | H | Pass |

| Band : | GSM1900 | | Temperature : | 21~24°C | | | | | |
|------------------------|--|------------------|----------------------------|---------------------------|--------------------------|----------------------------|-------------------------------|-------------------------|--------|
| Test Mode : | GPRS class 8 Link (GMSK) | | Relative Humidity : | 44~48% | | | | | |
| Test Engineer : | Kai Wang | | Polarization : | Vertical | | | | | |
| Remark : | Spurious emissions within 30-1000MHz were found more than 20dB below limit line. | | | | | | | | |
| Frequency (MHz) | ERP (dBm) | Limit (dBm) | Over Limit (dB) | SPA Reading (dBm) | S.G. Power (dBm) | TX Cable loss (dB) | TX Antenna Gain (dBi) | Polarization (H/V) | Result |
| 3756 | -49.61 | -13 | -36.61 | -63.57 | -55.91 | 2.51 | 8.81 | V | Pass |
| 5639 | -41.4 | -13 | -28.40 | -59.63 | -49.11 | 2.99 | 10.70 | V | Pass |
| 7522 | -40.62 | -13 | -27.62 | -65.33 | -49.15 | 3.59 | 12.12 | V | Pass |
| 9398 | -42.75 | -13 | -29.75 | -66.76 | -51.85 | 4.1 | 13.20 | V | Pass |
| 13159 | -37.81 | -13 | -24.81 | -66.92 | -47.33 | 4.27 | 13.79 | V | Pass |



<High Channel>

| Band : | GSM1900 | | Temperature : | 21~24°C | | | | | |
|------------------------|--|------------------|----------------------------|---------------------------|--------------------------|----------------------------|-------------------------------|-------------------------|--------|
| Test Mode : | GPRS class 8 Link (GMSK) | | Relative Humidity : | 44~48% | | | | | |
| Test Engineer : | Kai Wang | | Polarization : | Horizontal | | | | | |
| Remark : | Spurious emissions within 30-1000MHz were found more than 20dB below limit line. | | | | | | | | |
| Frequency (MHz) | ERP (dBm) | Limit (dBm) | Over Limit (dB) | SPA Reading (dBm) | S.G. Power (dBm) | TX Cable loss (dB) | TX Antenna Gain (dBi) | Polarization (H/V) | Result |
| 3819 | -45.21 | -13 | -32.21 | -58.51 | -51.62 | 2.47 | 8.88 | H | Pass |
| 5730 | -32.34 | -13 | -19.34 | -51.1 | -40.04 | 3 | 10.70 | H | Pass |
| 7641 | -39.65 | -13 | -26.65 | -63.65 | -48.43 | 3.43 | 12.21 | H | Pass |
| 9552 | -39.12 | -13 | -26.12 | -63.64 | -48.33 | 3.99 | 13.20 | H | Pass |
| 13366 | -29.26 | -13 | -16.26 | -60.6 | -38.61 | 4.68 | 14.03 | H | Pass |

| Band : | GSM1900 | | Temperature : | 21~24°C | | | | | |
|------------------------|--|------------------|----------------------------|---------------------------|--------------------------|----------------------------|-------------------------------|-------------------------|--------|
| Test Mode : | GPRS class 8 Link (GMSK) | | Relative Humidity : | 44~48% | | | | | |
| Test Engineer : | Kai Wang | | Polarization : | Vertical | | | | | |
| Remark : | Spurious emissions within 30-1000MHz were found more than 20dB below limit line. | | | | | | | | |
| Frequency (MHz) | ERP (dBm) | Limit (dBm) | Over Limit (dB) | SPA Reading (dBm) | S.G. Power (dBm) | TX Cable loss (dB) | TX Antenna Gain (dBi) | Polarization (H/V) | Result |
| 3819 | -47.65 | -13 | -34.65 | -61.82 | -54.06 | 2.47 | 8.88 | V | Pass |
| 5730 | -42.50 | -13 | -29.50 | -61.02 | -50.20 | 3 | 10.70 | V | Pass |
| 7641 | -42.46 | -13 | -29.46 | -66.28 | -51.24 | 3.43 | 12.21 | V | Pass |
| 9552 | -40.65 | -13 | -27.65 | -64.9 | -49.86 | 3.99 | 13.20 | V | Pass |
| 13366 | -31.51 | -13 | -18.51 | -60.88 | -40.86 | 4.68 | 14.03 | V | Pass |



<Low Channel>

| Band : | GSM1900 | | Temperature : | 21~24°C | | | | | |
|------------------------|--|------------------|----------------------------|---------------------------|--------------------------|----------------------------|-------------------------------|-------------------------|--------|
| Test Mode : | EDGE class 8 Link (8PSK) | | Relative Humidity : | 44~48% | | | | | |
| Test Engineer : | Kai Wang | | Polarization : | Horizontal | | | | | |
| Remark : | Spurious emissions within 30-1000MHz were found more than 20dB below limit line. | | | | | | | | |
| Frequency (MHz) | EIRP (dBm) | Limit (dBm) | Over Limit (dB) | SPA Reading (dBm) | S.G. Power (dBm) | TX Cable loss (dB) | TX Antenna Gain (dBi) | Polarization (H/V) | Result |
| 3700 | -49.60 | -13 | -36.60 | -62.41 | -55.75 | 2.59 | 8.74 | H | Pass |
| 5548 | -38.38 | -13 | -25.38 | -56.48 | -46.04 | 3.04 | 10.70 | H | Pass |
| 7403 | -40.16 | -13 | -27.16 | -65.18 | -48.90 | 3.28 | 12.02 | H | Pass |
| 9251 | -40.01 | -13 | -27.01 | -63.98 | -49.31 | 3.9 | 13.20 | H | Pass |
| 12961 | -35.38 | -13 | -22.38 | -66.26 | -44.04 | 4.89 | 13.55 | H | Pass |

| Band : | GSM1900 | | Temperature : | 21~24°C | | | | | |
|------------------------|--|------------------|----------------------------|---------------------------|--------------------------|----------------------------|-------------------------------|-------------------------|--------|
| Test Mode : | EDGE class 8 Link (8PSK) | | Relative Humidity : | 44~48% | | | | | |
| Test Engineer : | Kai Wang | | Polarization : | Vertical | | | | | |
| Remark : | Spurious emissions within 30-1000MHz were found more than 20dB below limit line. | | | | | | | | |
| Frequency (MHz) | EIRP (dBm) | Limit (dBm) | Over Limit (dB) | SPA Reading (dBm) | S.G. Power (dBm) | TX Cable loss (dB) | TX Antenna Gain (dBi) | Polarization (H/V) | Result |
| 3700 | -50.27 | -13 | -37.27 | -64.08 | -56.42 | 2.59 | 8.74 | V | Pass |
| 5548 | -43.52 | -13 | -30.52 | -61.45 | -51.18 | 3.04 | 10.70 | V | Pass |
| 7403 | -41.50 | -13 | -28.50 | -66.16 | -50.24 | 3.28 | 12.02 | V | Pass |
| 9251 | -40.98 | -13 | -27.98 | -64.73 | -50.28 | 3.9 | 13.20 | V | Pass |
| 12961 | -35.66 | -13 | -22.66 | -64.55 | -44.32 | 4.89 | 13.55 | V | Pass |



<Middle Channel>

| Band : | GSM1900 | | Temperature : | 21~24°C | | | | | |
|------------------------|--|------------------|----------------------------|---------------------------|--------------------------|----------------------------|-------------------------------|-------------------------|--------|
| Test Mode : | EDGE class 8 Link (8PSK) | | Relative Humidity : | 44~48% | | | | | |
| Test Engineer : | Kai Wang | | Polarization : | Horizontal | | | | | |
| Remark : | Spurious emissions within 30-1000MHz were found more than 20dB below limit line. | | | | | | | | |
| Frequency (MHz) | ERP (dBm) | Limit (dBm) | Over Limit (dB) | SPA Reading (dBm) | S.G. Power (dBm) | TX Cable loss (dB) | TX Antenna Gain (dBi) | Polarization (H/V) | Result |
| 3756 | -50.96 | -13 | -37.96 | -63.98 | -57.26 | 2.51 | 8.81 | H | Pass |
| 5639 | -39.22 | -13 | -26.22 | -57.64 | -46.93 | 2.99 | 10.70 | H | Pass |
| 7522 | -40.70 | -13 | -27.70 | -65.63 | -49.23 | 3.59 | 12.12 | H | Pass |
| 9398 | -40.88 | -13 | -27.88 | -65.01 | -49.98 | 4.1 | 13.20 | H | Pass |
| 13159 | -35.42 | -13 | -22.42 | -66.52 | -44.94 | 4.27 | 13.79 | H | Pass |

| Band : | GSM1900 | | Temperature : | 21~24°C | | | | | |
|------------------------|--|------------------|----------------------------|---------------------------|--------------------------|----------------------------|-------------------------------|-------------------------|--------|
| Test Mode : | EDGE class 8 Link (8PSK) | | Relative Humidity : | 44~48% | | | | | |
| Test Engineer : | Kai Wang | | Polarization : | Vertical | | | | | |
| Remark : | Spurious emissions within 30-1000MHz were found more than 20dB below limit line. | | | | | | | | |
| Frequency (MHz) | ERP (dBm) | Limit (dBm) | Over Limit (dB) | SPA Reading (dBm) | S.G. Power (dBm) | TX Cable loss (dB) | TX Antenna Gain (dBi) | Polarization (H/V) | Result |
| 3756 | -51.46 | -13 | -38.46 | -65.43 | -57.76 | 2.51 | 8.81 | V | Pass |
| 5639 | -44.8 | -13 | -31.80 | -63.02 | -52.51 | 2.99 | 10.70 | V | Pass |
| 7522 | -41.96 | -13 | -28.96 | -66.67 | -50.49 | 3.59 | 12.12 | V | Pass |
| 9398 | -41.87 | -13 | -28.87 | -65.89 | -50.97 | 4.1 | 13.20 | V | Pass |
| 13159 | -36.18 | -13 | -23.18 | -65.29 | -45.70 | 4.27 | 13.79 | V | Pass |



<High Channel>

| Band : | GSM1900 | | Temperature : | 21~24°C | | | | | |
|------------------------|--|------------------|----------------------------|---------------------------|--------------------------|----------------------------|-------------------------------|-------------------------|--------|
| Test Mode : | EDGE class 8 Link (8PSK) | | Relative Humidity : | 44~48% | | | | | |
| Test Engineer : | Kai Wang | | Polarization : | Horizontal | | | | | |
| Remark : | Spurious emissions within 30-1000MHz were found more than 20dB below limit line. | | | | | | | | |
| Frequency (MHz) | ERP (dBm) | Limit (dBm) | Over Limit (dB) | SPA Reading (dBm) | S.G. Power (dBm) | TX Cable loss (dB) | TX Antenna Gain (dBi) | Polarization (H/V) | Result |
| 3819 | -45.71 | -13 | -32.71 | -58.99 | -52.12 | 2.47 | 8.88 | H | Pass |
| 5730 | -38.35 | -13 | -25.35 | -57.1 | -46.05 | 3 | 10.70 | H | Pass |
| 7641 | -40.80 | -13 | -27.80 | -64.79 | -49.58 | 3.43 | 12.21 | H | Pass |
| 9552 | -41.11 | -13 | -28.11 | -65.61 | -50.32 | 3.99 | 13.20 | H | Pass |
| 13366 | -32.82 | -13 | -19.82 | -64.15 | -42.17 | 4.68 | 14.03 | H | Pass |

| Band : | GSM1900 | | Temperature : | 21~24°C | | | | | |
|------------------------|--|------------------|----------------------------|---------------------------|--------------------------|----------------------------|-------------------------------|-------------------------|--------|
| Test Mode : | EDGE class 8 Link (8PSK) | | Relative Humidity : | 44~48% | | | | | |
| Test Engineer : | Kai Wang | | Polarization : | Vertical | | | | | |
| Remark : | Spurious emissions within 30-1000MHz were found more than 20dB below limit line. | | | | | | | | |
| Frequency (MHz) | ERP (dBm) | Limit (dBm) | Over Limit (dB) | SPA Reading (dBm) | S.G. Power (dBm) | TX Cable loss (dB) | TX Antenna Gain (dBi) | Polarization (H/V) | Result |
| 3819 | -47.90 | -13 | -34.90 | -62.06 | -54.31 | 2.47 | 8.88 | V | Pass |
| 5730 | -43.85 | -13 | -30.85 | -62.38 | -51.55 | 3 | 10.70 | V | Pass |
| 7641 | -41.98 | -13 | -28.98 | -65.8 | -50.76 | 3.43 | 12.21 | V | Pass |
| 9552 | -42.18 | -13 | -29.18 | -66.44 | -51.39 | 3.99 | 13.20 | V | Pass |
| 13366 | -35.25 | -13 | -22.25 | -64.62 | -44.60 | 4.68 | 14.03 | V | Pass |



<Low Channel>

| Band : | WCDMA Band V | Temperature : | 21~24°C | | | | | | |
|------------------------|--|----------------------------|-------------------------|---------------------------|--------------------------|----------------------------|-------------------------------|-------------------------|--------|
| Test Mode : | RMC 12.2Kbps Link (QPSK) | Relative Humidity : | 44~48% | | | | | | |
| Test Engineer : | Kai Wang | Polarization : | Horizontal | | | | | | |
| Remark : | Spurious emissions within 30-1000MHz were found more than 20dB below limit line. | | | | | | | | |
| Frequency (MHz) | EIRP (dBm) | Limit (dBm) | Over Limit (dB) | SPA Reading (dBm) | S.G. Power (dBm) | TX Cable loss (dB) | TX Antenna Gain (dBi) | Polarization (H/V) | Result |
| 1648 | -58.21 | -13 | -45.21 | -64.63 | -60.06 | 1.53 | 5.53 | H | Pass |
| 2480 | -38.10 | -13 | -25.10 | -48.94 | -40.04 | 2.06 | 6.15 | H | Pass |
| 3298 | -56.17 | -13 | -43.17 | -67.85 | -59.47 | 2.48 | 7.93 | H | Pass |

| Band : | WCDMA Band V | Temperature : | 21~24°C | | | | | | |
|------------------------|--|----------------------------|-------------------------|---------------------------|--------------------------|----------------------------|-------------------------------|-------------------------|--------|
| Test Mode : | RMC 12.2Kbps Link (QPSK) | Relative Humidity : | 44~48% | | | | | | |
| Test Engineer : | Kai Wang | Polarization : | Vertical | | | | | | |
| Remark : | Spurious emissions within 30-1000MHz were found more than 20dB below limit line. | | | | | | | | |
| Frequency (MHz) | EIRP (dBm) | Limit (dBm) | Over Limit (dB) | SPA Reading (dBm) | S.G. Power (dBm) | TX Cable loss (dB) | TX Antenna Gain (dBi) | Polarization (H/V) | Result |
| 1648 | -53.50 | -13 | -40.50 | -62.15 | -55.35 | 1.53 | 5.53 | V | Pass |
| 2480 | -40.57 | -13 | -27.57 | -51.87 | -42.51 | 2.06 | 6.15 | V | Pass |
| 3298 | -54.61 | -13 | -41.61 | -67.88 | -57.91 | 2.48 | 7.93 | V | Pass |



<Middle Channel>

| Band : | WCDMA Band V | Temperature : | 21~24°C | | | | | | |
|------------------------|--|----------------------------|-------------------------|---------------------------|--------------------------|----------------------------|-------------------------------|-------------------------|--------|
| Test Mode : | RMC 12.2Kbps Link (QPSK) | Relative Humidity : | 44~48% | | | | | | |
| Test Engineer : | Kai Wang | Polarization : | Horizontal | | | | | | |
| Remark : | Spurious emissions within 30-1000MHz were found more than 20dB below limit line. | | | | | | | | |
| Frequency (MHz) | ERP (dBm) | Limit (dBm) | Over Limit (dB) | SPA Reading (dBm) | S.G. Power (dBm) | TX Cable loss (dB) | TX Antenna Gain (dBi) | Polarization (H/V) | Result |
| 1672 | -58.90 | -13 | -45.90 | -65.47 | -60.62 | 1.62 | 5.49 | H | Pass |
| 2504 | -38.21 | -13 | -25.21 | -49.15 | -40.18 | 2.1 | 6.22 | H | Pass |
| 3345 | -55.75 | -13 | -42.75 | -67.51 | -58.64 | 3.03 | 8.07 | H | Pass |

| Band : | WCDMA Band V | Temperature : | 21~24°C | | | | | | |
|------------------------|--|----------------------------|-------------------------|---------------------------|--------------------------|----------------------------|-------------------------------|-------------------------|--------|
| Test Mode : | RMC 12.2Kbps Link (QPSK) | Relative Humidity : | 44~48% | | | | | | |
| Test Engineer : | Kai Wang | Polarization : | Vertical | | | | | | |
| Remark : | Spurious emissions within 30-1000MHz were found more than 20dB below limit line. | | | | | | | | |
| Frequency (MHz) | ERP (dBm) | Limit (dBm) | Over Limit (dB) | SPA Reading (dBm) | S.G. Power (dBm) | TX Cable loss (dB) | TX Antenna Gain (dBi) | Polarization (H/V) | Result |
| 1672 | -55.80 | -13 | -42.80 | -64.61 | -57.52 | 1.62 | 5.49 | V | Pass |
| 2504 | -42.01 | -13 | -29.01 | -53.36 | -43.98 | 2.1 | 6.22 | V | Pass |
| 3345 | -53.80 | -13 | -40.80 | -67.06 | -56.69 | 3.03 | 8.07 | V | Pass |



<High Channel>

| Band : | WCDMA Band V | Temperature : | 21~24°C | | | | | | |
|------------------------|--|----------------------------|-------------------------|---------------------------|--------------------------|----------------------------|-------------------------------|-------------------------|--------|
| Test Mode : | RMC 12.2Kbps Link (QPSK) | Relative Humidity : | 44~48% | | | | | | |
| Test Engineer : | Kai Wang | Polarization : | Horizontal | | | | | | |
| Remark : | Spurious emissions within 30-1000MHz were found more than 20dB below limit line. | | | | | | | | |
| Frequency (MHz) | ERP (dBm) | Limit (dBm) | Over Limit (dB) | SPA Reading (dBm) | S.G. Power (dBm) | TX Cable loss (dB) | TX Antenna Gain (dBi) | Polarization (H/V) | Result |
| 1696 | -48.10 | -13 | -35.10 | -54.79 | -49.83 | 1.57 | 5.45 | H | Pass |
| 2536 | -38.65 | -13 | -25.65 | -49.63 | -40.76 | 2.02 | 6.28 | H | Pass |
| 3392 | -52.08 | -13 | -39.08 | -63.94 | -55.83 | 2.3 | 8.20 | H | Pass |

| Band : | WCDMA Band V | Temperature : | 21~24°C | | | | | | |
|------------------------|--|----------------------------|-------------------------|---------------------------|--------------------------|----------------------------|-------------------------------|-------------------------|--------|
| Test Mode : | RMC 12.2Kbps Link (QPSK) | Relative Humidity : | 44~48% | | | | | | |
| Test Engineer : | Kai Wang | Polarization : | Vertical | | | | | | |
| Remark : | Spurious emissions within 30-1000MHz were found more than 20dB below limit line. | | | | | | | | |
| Frequency (MHz) | ERP (dBm) | Limit (dBm) | Over Limit (dB) | SPA Reading (dBm) | S.G. Power (dBm) | TX Cable loss (dB) | TX Antenna Gain (dBi) | Polarization (H/V) | Result |
| 1696 | -49.80 | -13 | -36.80 | -58.74 | -51.5272 | 1.57 | 5.45 | V | Pass |
| 2536 | -43.75 | -13 | -30.75 | -55.22 | -45.8592 | 2.02 | 6.28 | V | Pass |
| 3392 | -54.10 | -13 | -41.10 | -67.33 | -57.8504 | 2.3 | 8.20 | V | Pass |



<Low Channel>

| Band : | WCDMA Band IV | Temperature : | 21~24°C | | | | | | |
|------------------------|--|----------------------------|-------------------------|---------------------------|--------------------------|----------------------------|-------------------------------|-------------------------|--------|
| Test Mode : | RMC 12.2Kbps Link (QPSK) | Relative Humidity : | 44~48% | | | | | | |
| Test Engineer : | Kai Wang | Polarization : | Horizontal | | | | | | |
| Remark : | Spurious emissions within 30-1000MHz were found more than 20dB below limit line. | | | | | | | | |
| Frequency (MHz) | EIRP (dBm) | Limit (dBm) | Over Limit (dB) | SPA Reading (dBm) | S.G. Power (dBm) | TX Cable loss (dB) | TX Antenna Gain (dBi) | Polarization (H/V) | Result |
| 3427 | -45.88 | -13 | -32.88 | -59.46 | -49.71 | 4.48 | 8.31 | H | Pass |
| 5142 | -40.07 | -13 | -27.07 | -58.31 | -44.71 | 5.332 | 9.98 | H | Pass |
| 6849 | -41.47 | -13 | -28.47 | -66.64 | -46.71 | 6.1 | 11.34 | H | Pass |

| Band : | WCDMA Band IV | Temperature : | 21~24°C | | | | | | |
|------------------------|--|----------------------------|-------------------------|---------------------------|--------------------------|----------------------------|-------------------------------|-------------------------|--------|
| Test Mode : | RMC 12.2Kbps Link (QPSK) | Relative Humidity : | 44~48% | | | | | | |
| Test Engineer : | Kai Wang | Polarization : | Vertical | | | | | | |
| Remark : | Spurious emissions within 30-1000MHz were found more than 20dB below limit line. | | | | | | | | |
| Frequency (MHz) | EIRP (dBm) | Limit (dBm) | Over Limit (dB) | SPA Reading (dBm) | S.G. Power (dBm) | TX Cable loss (dB) | TX Antenna Gain (dBi) | Polarization (H/V) | Result |
| 3420 | -43.45 | -13 | -30.45 | -58.6 | -47.28 | 4.48 | 8.31 | V | Pass |
| 5142 | -44.03 | -13 | -31.03 | -62.17 | -48.67 | 5.332 | 9.98 | V | Pass |
| 6843 | -39.77 | -13 | -26.77 | -64.29 | -45.01 | 6.1 | 11.34 | V | Pass |



<Middle Channel>

| Band : | WCDMA Band IV | Temperature : | 21~24°C | | | | | | |
|------------------------|--|----------------------------|-------------------------|---------------------------|--------------------------|----------------------------|-------------------------------|-------------------------|--------|
| Test Mode : | RMC 12.2Kbps Link (QPSK) | Relative Humidity : | 44~48% | | | | | | |
| Test Engineer : | Kai Wang | Polarization : | Horizontal | | | | | | |
| Remark : | Spurious emissions within 30-1000MHz were found more than 20dB below limit line. | | | | | | | | |
| Frequency (MHz) | EIRP (dBm) | Limit (dBm) | Over Limit (dB) | SPA Reading (dBm) | S.G. Power (dBm) | TX Cable loss (dB) | TX Antenna Gain (dBi) | Polarization (H/V) | Result |
| 3469 | -47.19 | -13 | -34.19 | -61.17 | -51.02 | 4.48 | 8.31 | H | Pass |
| 5198 | -39.64 | -13 | -26.64 | -58.19 | -44.28 | 5.332 | 9.98 | H | Pass |
| 6934 | -40.44 | -13 | -27.44 | -66.11 | -45.68 | 6.1 | 11.34 | H | Pass |

| Band : | WCDMA Band IV | Temperature : | 21~24°C | | | | | | |
|------------------------|--|----------------------------|-------------------------|---------------------------|--------------------------|----------------------------|-------------------------------|-------------------------|--------|
| Test Mode : | RMC 12.2Kbps Link (QPSK) | Relative Humidity : | 44~48% | | | | | | |
| Test Engineer : | Kai Wang | Polarization : | Vertical | | | | | | |
| Remark : | Spurious emissions within 30-1000MHz were found more than 20dB below limit line. | | | | | | | | |
| Frequency (MHz) | EIRP (dBm) | Limit (dBm) | Over Limit (dB) | SPA Reading (dBm) | S.G. Power (dBm) | TX Cable loss (dB) | TX Antenna Gain (dBi) | Polarization (H/V) | Result |
| 3469 | -46.45 | -13 | -33.45 | -62.21 | -50.28 | 4.48 | 8.31 | V | Pass |
| 5198 | -48.57 | -13 | -35.57 | -67.15 | -53.21 | 5.332 | 9.98 | V | Pass |
| 6934 | -39.87 | -13 | -26.87 | -64.91 | -45.11 | 6.1 | 11.34 | V | Pass |



<High Channel>

| Band : | WCDMA Band IV | Temperature : | 21~24°C | | | | | | |
|------------------------|--|----------------------------|-------------------------|---------------------------|--------------------------|----------------------------|-------------------------------|-------------------------|--------|
| Test Mode : | RMC 12.2Kbps Link (QPSK) | Relative Humidity : | 44~48% | | | | | | |
| Test Engineer : | Kai Wang | Polarization : | Horizontal | | | | | | |
| Remark : | Spurious emissions within 30-1000MHz were found more than 20dB below limit line. | | | | | | | | |
| Frequency (MHz) | EIRP (dBm) | Limit (dBm) | Over Limit (dB) | SPA Reading (dBm) | S.G. Power (dBm) | TX Cable loss (dB) | TX Antenna Gain (dBi) | Polarization (H/V) | Result |
| 3504 | -41.90 | -13 | -28.90 | -55.83 | -46.17 | 4.16 | 8.43 | H | Pass |
| 5261 | -44.77 | -13 | -31.77 | -63.41 | -49.73 | 5.13 | 10.09 | H | Pass |
| 7010 | -42.73 | -13 | -29.73 | -68.67 | -48.01 | 6.15 | 11.43 | H | Pass |

| Band : | WCDMA Band IV | Temperature : | 21~24°C | | | | | | |
|------------------------|--|----------------------------|-------------------------|---------------------------|--------------------------|----------------------------|-------------------------------|-------------------------|--------|
| Test Mode : | RMC 12.2Kbps Link (QPSK) | Relative Humidity : | 44~48% | | | | | | |
| Test Engineer : | Kai Wang | Polarization : | Vertical | | | | | | |
| Remark : | Spurious emissions within 30-1000MHz were found more than 20dB below limit line. | | | | | | | | |
| Frequency (MHz) | EIRP (dBm) | Limit (dBm) | Over Limit (dB) | SPA Reading (dBm) | S.G. Power (dBm) | TX Cable loss (dB) | TX Antenna Gain (dBi) | Polarization (H/V) | Result |
| 3504 | -42.97 | -13 | -29.97 | -58.01 | -47.24 | 4.16 | 8.43 | V | Pass |
| 5261 | -45.47 | -13 | -32.47 | -64.68 | -50.43 | 5.13 | 10.09 | V | Pass |
| 7010 | -42.84 | -13 | -29.84 | -68.12 | -48.12 | 6.15 | 11.43 | V | Pass |



<Low Channel>

| Band : | WCDMA Band II | Temperature : | 21~24°C | | | | | | |
|------------------------|--|----------------------------|-------------------------|---------------------------|--------------------------|----------------------------|-------------------------------|-------------------------|--------|
| Test Mode : | RMC 12.2Kbps Link (QPSK) | Relative Humidity : | 44~48% | | | | | | |
| Test Engineer : | Kai Wang | Polarization : | Horizontal | | | | | | |
| Remark : | Spurious emissions within 30-1000MHz were found more than 20dB below limit line. | | | | | | | | |
| Frequency (MHz) | EIRP (dBm) | Limit (dBm) | Over Limit (dB) | SPA Reading (dBm) | S.G. Power (dBm) | TX Cable loss (dB) | TX Antenna Gain (dBi) | Polarization (H/V) | Result |
| 3707 | -44.02 | -13 | -31.02 | -57.87 | -50.17 | 2.59 | 8.74 | H | Pass |
| 5555 | -41.13 | -13 | -28.13 | -59.23 | -48.79 | 3.04 | 10.70 | H | Pass |
| 7405 | -41.23 | -13 | -28.23 | -66.35 | -49.97 | 3.28 | 12.02 | H | Pass |

| Band : | WCDMA Band II | Temperature : | 21~24°C | | | | | | |
|------------------------|--|----------------------------|-------------------------|---------------------------|--------------------------|----------------------------|-------------------------------|-------------------------|--------|
| Test Mode : | RMC 12.2Kbps Link (QPSK) | Relative Humidity : | 44~48% | | | | | | |
| Test Engineer : | Kai Wang | Polarization : | Vertical | | | | | | |
| Remark : | Spurious emissions within 30-1000MHz were found more than 20dB below limit line. | | | | | | | | |
| Frequency (MHz) | EIRP (dBm) | Limit (dBm) | Over Limit (dB) | SPA Reading (dBm) | S.G. Power (dBm) | TX Cable loss (dB) | TX Antenna Gain (dBi) | Polarization (H/V) | Result |
| 3707 | -45.44 | -13 | -32.44 | -59.25 | -51.59 | 2.59 | 8.74 | V | Pass |
| 5555 | -41.95 | -13 | -28.95 | -59.88 | -49.61 | 3.04 | 10.70 | V | Pass |
| 7405 | -43.25 | -13 | -30.25 | -67.92 | -51.99 | 3.28 | 12.02 | V | Pass |



<Middle Channel>

| Band : | WCDMA Band II | Temperature : | 21~24°C | | | | | | |
|------------------------|--|----------------------------|-------------------------|---------------------------|--------------------------|----------------------------|-------------------------------|-------------------------|--------|
| Test Mode : | RMC 12.2Kbps Link (QPSK) | Relative Humidity : | 44~48% | | | | | | |
| Test Engineer : | Kai Wang | Polarization : | Horizontal | | | | | | |
| Remark : | Spurious emissions within 30-1000MHz were found more than 20dB below limit line. | | | | | | | | |
| Frequency (MHz) | ERP (dBm) | Limit (dBm) | Over Limit (dB) | SPA Reading (dBm) | S.G. Power (dBm) | TX Cable loss (dB) | TX Antenna Gain (dBi) | Polarization (H/V) | Result |
| 3760 | -50.12 | -13 | -37.12 | -63.2 | -56.42 | 2.51 | 8.81 | H | Pass |
| 5636 | -43.96 | -13 | -30.96 | -62.39 | -51.67 | 2.99 | 10.70 | H | Pass |
| 7520 | -42.97 | -13 | -29.97 | -67.89 | -51.50 | 3.59 | 12.12 | H | Pass |

| Band : | WCDMA Band II | Temperature : | 21~24°C | | | | | | |
|------------------------|--|----------------------------|-------------------------|---------------------------|--------------------------|----------------------------|-------------------------------|-------------------------|--------|
| Test Mode : | RMC 12.2Kbps Link (QPSK) | Relative Humidity : | 44~48% | | | | | | |
| Test Engineer : | Kai Wang | Polarization : | Vertical | | | | | | |
| Remark : | Spurious emissions within 30-1000MHz were found more than 20dB below limit line. | | | | | | | | |
| Frequency (MHz) | ERP (dBm) | Limit (dBm) | Over Limit (dB) | SPA Reading (dBm) | S.G. Power (dBm) | TX Cable loss (dB) | TX Antenna Gain (dBi) | Polarization (H/V) | Result |
| 3760 | -50.85 | -13 | -37.85 | -64.86 | -57.15 | 2.51 | 8.81 | V | Pass |
| 5636 | -45.57 | -13 | -32.57 | -63.8 | -53.28 | 2.99 | 10.70 | V | Pass |
| 7520 | -43.46 | -13 | -30.46 | -68.17 | -51.99 | 3.59 | 12.12 | V | Pass |



<High Channel>

| Band : | WCDMA Band II | Temperature : | 21~24°C | | | | | | |
|------------------------|--|----------------------------|-------------------------|---------------------------|--------------------------|----------------------------|-------------------------------|-------------------------|--------|
| Test Mode : | RMC 12.2Kbps Link (QPSK) | Relative Humidity : | 44~48% | | | | | | |
| Test Engineer : | Kai Wang | Polarization : | Horizontal | | | | | | |
| Remark : | Spurious emissions within 30-1000MHz were found more than 20dB below limit line. | | | | | | | | |
| Frequency (MHz) | ERP (dBm) | Limit (dBm) | Over Limit (dB) | SPA Reading (dBm) | S.G. Power (dBm) | TX Cable loss (dB) | TX Antenna Gain (dBi) | Polarization (H/V) | Result |
| 3812 | -43.85 | -13 | -30.85 | -57.06 | -50.26 | 2.47 | 8.88 | H | Pass |
| 5723 | -41.18 | -13 | -28.18 | -59.93 | -48.88 | 3 | 10.70 | H | Pass |
| 7635 | -43.50 | -13 | -30.50 | -67.63 | -52.28 | 3.43 | 12.21 | H | Pass |

| Band : | WCDMA Band II | Temperature : | 21~24°C | | | | | | |
|------------------------|--|----------------------------|-------------------------|---------------------------|--------------------------|----------------------------|-------------------------------|-------------------------|--------|
| Test Mode : | RMC 12.2Kbps Link (QPSK) | Relative Humidity : | 44~48% | | | | | | |
| Test Engineer : | Kai Wang | Polarization : | Vertical | | | | | | |
| Remark : | Spurious emissions within 30-1000MHz were found more than 20dB below limit line. | | | | | | | | |
| Frequency (MHz) | ERP (dBm) | Limit (dBm) | Over Limit (dB) | SPA Reading (dBm) | S.G. Power (dBm) | TX Cable loss (dB) | TX Antenna Gain (dBi) | Polarization (H/V) | Result |
| 3812 | -45.41 | -13 | -32.41 | -59.53 | -51.82 | 2.47 | 8.88 | V | Pass |
| 5723 | -42.80 | -13 | -29.80 | -61.32 | -50.50 | 3 | 10.70 | V | Pass |
| 7635 | -43.80 | -13 | -30.80 | -67.75 | -52.58 | 3.43 | 12.21 | V | Pass |



<For Sample 3>

<Low Channel>

| Band : | GSM850 | Temperature : | 21~24°C | | | | | | |
|------------------------|--|----------------------------|-------------------------|---------------------------|--------------------------|----------------------------|-------------------------------|-------------------------|--------|
| Test Mode : | GPRS class 8 Link (GMSK) | Relative Humidity : | 44~48% | | | | | | |
| Test Engineer : | Kai Wang | Polarization : | Horizontal | | | | | | |
| Remark : | Spurious emissions within 30-1000MHz were found more than 20dB below limit line. | | | | | | | | |
| Frequency (MHz) | ERP (dBm) | Limit (dBm) | Over Limit (dB) | SPA Reading (dBm) | S.G. Power (dBm) | TX Cable loss (dB) | TX Antenna Gain (dBi) | Polarization (H/V) | Result |
| 1649 | -44.34 | -13 | -31.34 | -55.07 | -46.09 | 0.98 | 4.88 | H | Pass |
| 2474 | -36.02 | -13 | -23.02 | -51.44 | -37.91 | 1.28 | 5.32 | H | Pass |
| 3298 | -49.79 | -13 | -36.79 | -65.86 | -53.21 | 1.54 | 7.11 | H | Pass |

| Band : | GSM850 | Temperature : | 21~24°C | | | | | | |
|------------------------|--|----------------------------|-------------------------|---------------------------|--------------------------|----------------------------|-------------------------------|-------------------------|--------|
| Test Mode : | GPRS class 8 Link (GMSK) | Relative Humidity : | 44~48% | | | | | | |
| Test Engineer : | Kai Wang | Polarization : | Vertical | | | | | | |
| Remark : | Spurious emissions within 30-1000MHz were found more than 20dB below limit line. | | | | | | | | |
| Frequency (MHz) | ERP (dBm) | Limit (dBm) | Over Limit (dB) | SPA Reading (dBm) | S.G. Power (dBm) | TX Cable loss (dB) | TX Antenna Gain (dBi) | Polarization (H/V) | Result |
| 1649 | -47.46 | -13 | -34.46 | -61.47 | -49.21 | 0.98 | 4.88 | V | Pass |
| 2474 | -38.50 | -13 | -25.50 | -54.58 | -40.39 | 1.28 | 5.32 | V | Pass |
| 3298 | -47.79 | -13 | -34.79 | -65.73 | -51.21 | 1.54 | 7.11 | V | Pass |



<Middle Channel>

| Band : | GSM850 | Temperature : | 21~24°C | | | | | | |
|------------------------|--|----------------------------|-------------------------|---------------------------|--------------------------|----------------------------|-------------------------------|-------------------------|--------|
| Test Mode : | GPRS class 8 Link (GMSK) | Relative Humidity : | 44~48% | | | | | | |
| Test Engineer : | Kai Wang | Polarization : | Horizontal | | | | | | |
| Remark : | Spurious emissions within 30-1000MHz were found more than 20dB below limit line. | | | | | | | | |
| Frequency (MHz) | ERP (dBm) | Limit (dBm) | Over Limit (dB) | SPA Reading (dBm) | S.G. Power (dBm) | TX Cable loss (dB) | TX Antenna Gain (dBi) | Polarization (H/V) | Result |
| 1672 | -51.13 | -13 | -38.13 | -61.82 | -52.81 | 0.99 | 4.82 | H | Pass |
| 2509 | -34.05 | -13 | -21.05 | -49.21 | -36.01 | 1.29 | 5.41 | H | Pass |
| 3345 | -49.70 | -13 | -36.70 | -65.75 | -53.31 | 1.56 | 7.32 | H | Pass |

| Band : | GSM850 | Temperature : | 21~24°C | | | | | | |
|------------------------|--|----------------------------|-------------------------|---------------------------|--------------------------|----------------------------|-------------------------------|-------------------------|--------|
| Test Mode : | GPRS class 8 Link (GMSK) | Relative Humidity : | 44~48% | | | | | | |
| Test Engineer : | Kai Wang | Polarization : | Vertical | | | | | | |
| Remark : | Spurious emissions within 30-1000MHz were found more than 20dB below limit line. | | | | | | | | |
| Frequency (MHz) | ERP (dBm) | Limit (dBm) | Over Limit (dB) | SPA Reading (dBm) | S.G. Power (dBm) | TX Cable loss (dB) | TX Antenna Gain (dBi) | Polarization (H/V) | Result |
| 1672 | -48.88 | -13 | -35.88 | -62.22 | -50.56 | 0.99 | 4.82 | V | Pass |
| 2509 | -35.23 | -13 | -22.23 | -52.06 | -37.19 | 1.29 | 5.41 | V | Pass |
| 3345 | -47.60 | -13 | -34.60 | -66.08 | -51.21 | 1.56 | 7.32 | V | Pass |



<High Channel>

| Band : | GSM850 | Temperature : | 21~24°C | | | | | | |
|------------------------|--|----------------------------|-------------------------|---------------------------|--------------------------|----------------------------|-------------------------------|-------------------------|--------|
| Test Mode : | GPRS class 8 Link (GMSK) | Relative Humidity : | 44~48% | | | | | | |
| Test Engineer : | Kai Wang | Polarization : | Horizontal | | | | | | |
| Remark : | Spurious emissions within 30-1000MHz were found more than 20dB below limit line. | | | | | | | | |
| Frequency (MHz) | ERP (dBm) | Limit (dBm) | Over Limit (dB) | SPA Reading (dBm) | S.G. Power (dBm) | TX Cable loss (dB) | TX Antenna Gain (dBi) | Polarization (H/V) | Result |
| 1696 | -49.69 | -13 | -36.69 | -60.75 | -51.29 | 1.00 | 4.75 | H | Pass |
| 2544 | -31.63 | -13 | -18.63 | -46.92 | -33.61 | 1.30 | 5.44 | H | Pass |
| 3393 | -48.50 | -13 | -35.50 | -65.22 | -52.31 | 1.57 | 7.53 | H | Pass |

| Band : | GSM850 | Temperature : | 21~24°C | | | | | | |
|------------------------|--|----------------------------|-------------------------|---------------------------|--------------------------|----------------------------|-------------------------------|-------------------------|--------|
| Test Mode : | GPRS class 8 Link (GMSK) | Relative Humidity : | 44~48% | | | | | | |
| Test Engineer : | Kai Wang | Polarization : | Vertical | | | | | | |
| Remark : | Spurious emissions within 30-1000MHz were found more than 20dB below limit line. | | | | | | | | |
| Frequency (MHz) | ERP (dBm) | Limit (dBm) | Over Limit (dB) | SPA Reading (dBm) | S.G. Power (dBm) | TX Cable loss (dB) | TX Antenna Gain (dBi) | Polarization (H/V) | Result |
| 1696 | -50.69 | -13 | -37.69 | -64.45 | -52.29 | 1.00 | 4.75 | V | Pass |
| 2544 | -34.33 | -13 | -21.33 | -50.52 | -36.31 | 1.30 | 5.44 | V | Pass |
| 3393 | -47.62 | -13 | -34.62 | -65.57 | -51.43 | 1.57 | 7.53 | V | Pass |

3.8 Frequency Stability Measurement

3.8.1 Description of Frequency Stability Measurement

The frequency stability shall be measured by variation of ambient temperature and variation of primary supply voltage to ensure that the fundamental emission stays within the authorized frequency block. The frequency stability of the transmitter shall be maintained within $\pm 0.00025\%$ ($\pm 2.5\text{ppm}$) of the center frequency.

3.8.2 Measuring Instruments

The measuring equipment is listed in the section 4 of this test report.

3.8.3 Test Procedures for Temperature Variation

1. The testing follows FCC KDB 971168 v02r01 Section 9.0.
2. The EUT was set up in the thermal chamber and connected with the system simulator.
3. With power OFF, the temperature was decreased to -30°C and the EUT was stabilized before testing. Power was applied and the maximum change in frequency was recorded within one minute.
4. With power OFF, the temperature was raised in 10°C steps up to 50°C . The EUT was stabilized at each step for at least half an hour. Power was applied and the maximum frequency change was recorded within one minute.

3.8.4 Test Procedures for Voltage Variation

1. The testing follows FCC KDB 971168 v02r01 Section 9.0.
2. The EUT was placed in a temperature chamber at $25\pm 5^{\circ}\text{C}$ and connected with the system simulator.
3. The power supply voltage to the EUT was varied from BEP to 115% of the nominal value measured at the input to the EUT.
4. The variation in frequency was measured for the worst case.

3.8.5 Test Setup

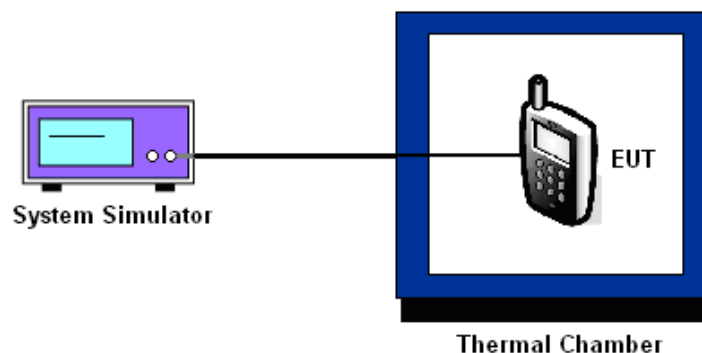



3.8.6 Test Result of Temperature Variation

| | | | |
|---------------|---------|-------------|-----------|
| Band : | GSM 850 | Channel : | 189 |
| Limit (ppm) : | 2.5 | Frequency : | 836.4 MHz |

| Temperature (°C) | GPRS class 8 | | EDGE class 8 | | Result |
|------------------|-----------------|-----------------|-----------------|-----------------|--------|
| | Freq. Dev. (Hz) | Deviation (ppm) | Freq. Dev. (Hz) | Deviation (ppm) | |
| 50 | 36 | 0.0060 | 23 | 0.0012 | PASS |
| 40 | 33 | 0.0024 | 21 | 0.0012 | |
| 30 | 30 | 0.0012 | 19 | 0.0036 | |
| 20(Ref.) | 31 | 0.0000 | 22 | 0.0000 | |
| 10 | 32 | 0.0012 | 18 | 0.0048 | |
| 0 | 33 | 0.0024 | 20 | 0.0024 | |
| -10 | 29 | 0.0024 | 21 | 0.0012 | |
| -20 | 35 | 0.0048 | 26 | 0.0048 | |
| -30 | 37 | 0.0072 | 24 | 0.0024 | |

| | | | |
|---------------|------------------------|-------------|------------|
| Band : | GSM 1900 | Channel : | 661 |
| Limit (ppm) : | within authorized band | Frequency : | 1880.0 MHz |

| Temperature (°C) | GPRS class 8 | | EDGE class 8 | | Result |
|------------------|-----------------|-----------------|-----------------|-----------------|--------|
| | Freq. Dev. (Hz) | Deviation (ppm) | Freq. Dev. (Hz) | Deviation (ppm) | |
| 50 | 74 | 0.0016 | 69 | 0.0011 | PASS |
| 40 | 75 | 0.0021 | 66 | 0.0005 | |
| 30 | 68 | 0.0016 | 70 | 0.0016 | |
| 20(Ref.) | 71 | 0.0000 | 67 | 0.0000 | |
| 10 | 72 | 0.0005 | 65 | 0.0011 | |
| 0 | 69 | 0.0011 | 64 | 0.0016 | |
| -10 | 68 | 0.0016 | 66 | 0.0005 | |
| -20 | 73 | 0.0011 | 70 | 0.0016 | |
| -30 | 76 | 0.0027 | 68 | 0.0005 | |

Note: The frequency fundamental emissions stay within the authorized frequency block based on the frequency deviation measured is small.



| | | | |
|----------------------|--------------|--------------------|-----------|
| Band : | WCDMA Band V | Channel : | 4182 |
| Limit (ppm) : | 2.5 | Frequency : | 836.4 MHz |

| Temperature (°C) | RMC 12.2Kbps | | Result |
|------------------|-----------------|-----------------|--------|
| | Freq. Dev. (Hz) | Deviation (ppm) | |
| 50 | 9 | 0.0179 | PASS |
| 40 | 5 | 0.0132 | |
| 30 | 4 | 0.0120 | |
| 20(Ref.) | -6 | 0.0000 | |
| 10 | -5 | 0.0012 | |
| 0 | -7 | 0.0012 | |
| -10 | -5 | 0.0012 | |
| -20 | -8 | 0.0024 | |
| -30 | -10 | 0.0048 | |

| | | | |
|----------------------|------------------------|--------------------|------------|
| Band : | WCDMA Band IV | Channel : | 1413 |
| Limit (ppm) : | within authorized band | Frequency : | 1732.6 MHz |

| Temperature (°C) | RMC 12.2Kbps | | Result |
|------------------|-----------------|-----------------|--------|
| | Freq. Dev. (Hz) | Deviation (ppm) | |
| 50 | -14 | 0.0035 | PASS |
| 40 | -9 | 0.0006 | |
| 30 | -7 | 0.0006 | |
| 20(Ref.) | -8 | 0.0000 | |
| 10 | -6 | 0.0012 | |
| 0 | -10 | 0.0012 | |
| -10 | -11 | 0.0017 | |
| -20 | -13 | 0.0029 | |
| -30 | -12 | 0.0023 | |

Note: The frequency fundamental emissions stay within the authorized frequency block based on the frequency deviation measured is small.



| | | | |
|----------------------|------------------------|--------------------|------------|
| Band : | WCDMA Band II | Channel : | 9400 |
| Limit (ppm) : | within authorized band | Frequency : | 1880.0 MHz |

| Temperature (°C) | RMC 12.2Kbps | | Result |
|------------------|-----------------|-----------------|--------|
| | Freq. Dev. (Hz) | Deviation (ppm) | |
| 50 | 11 | 0.0021 | PASS |
| 40 | 9 | 0.0011 | |
| 30 | 6 | 0.0005 | |
| 20(Ref.) | 7 | 0.0000 | |
| 10 | 8 | 0.0005 | |
| 0 | 5 | 0.0011 | |
| -10 | 9 | 0.0011 | |
| -20 | 10 | 0.0016 | |
| -30 | 12 | 0.0027 | |

Note: The frequency fundamental emissions stay within the authorized frequency block based on the frequency deviation measured is small.



3.8.7 Test Result of Voltage Variation

| Band & Channel | Mode | Voltage (Volt) | Freq. Dev. (Hz) | Deviation (ppm) | Limit (ppm) | Result |
|-------------------------|-----------------|----------------|-----------------|-----------------|----------------|--------|
| GSM 850 CH189 | GPRS class 8 | 4.40 | 31 | 0.0000 | 2.5 Note 3. | PASS |
| | | 3.80 | 32 | 0.0012 | | |
| | | BEP | 34 | 0.0036 | | |
| | EDGE class 8 | 4.40 | 19 | 0.0036 | | |
| | | 3.80 | 20 | 0.0024 | | |
| | | BEP | 23 | 0.0012 | | |
| GSM 1900 CH661 | GPRS class 8 | 4.40 | 73 | 0.0011 | | |
| | | 3.80 | 74 | 0.0016 | | |
| | | BEP | 79 | 0.0043 | | |
| | EDGE class 8 | 4.40 | 66 | 0.0005 | | |
| | | 3.80 | 63 | 0.0021 | | |
| | | BEP | 67 | 0.0000 | | |
| WCDMA Band V CH4182 | RMC 12.2Kbps | 4.40 | -6 | 0.0000 | | |
| | | 3.80 | -7 | 0.0012 | | |
| | | BEP | -5 | 0.0012 | | |
| WCDMA Band IV CH1413 | RMC 12.2Kbps | 4.40 | -11 | 0.0017 | | |
| | | 3.80 | -10 | 0.0012 | | |
| | | BEP | -12 | 0.0023 | | |
| WCDMA Band II CH9400 | RMC 12.2Kbps | 4.40 | 7 | 0.0000 | | |
| | | 3.80 | 9 | 0.0011 | | |
| | | BEP | 8 | 0.0005 | | |

Note:

1. Normal Voltage = 3.80V.
2. Battery End Point (BEP) = 3.60 V.
3. The frequency fundamental emissions stay within the authorized frequency block based on the frequency deviation measured is small.



4 List of Measuring Equipment

| Instrument | Manufacturer | Model No. | Serial No. | Characteristics | Calibration Date | Test Date | Due Date | Remark |
|---------------------------|-----------------|---------------|-------------------|------------------|------------------|---------------------------------|---------------|-----------------------|
| System Simulator | Rohde & Schwarz | CMU200 | 117995 | N/A | Jul. 29, 2014 | Aug. 13, 2014 | Jul. 28, 2015 | Conducted (TH02-HY) |
| Spectrum Analyzer | Rohde & Schwarz | FSP40 | 100055 | 9kHz~40GHz | Jun. 09, 2014 | Aug. 13, 2014 | Jun. 08, 2015 | Conducted (TH02-HY) |
| Thermal Chamber | Ten Billion | TTH-D3SP | TBN-930701 | N/A | Jul. 17, 2014 | Aug. 13, 2014 | Jul. 16, 2015 | Conducted (TH02-HY) |
| Spectrum Analyzer | Rohde & Schwarz | FSV30 | 101749 | 10Hz ~ 30GHz | Feb. 10, 2014 | Aug. 10, 2014~ Oct. 02, 2014 | Feb. 09, 2015 | Radiation (03CH07-HY) |
| Bilog Antenna | Schaffner | CBL6111C | 2726 | 30MHz ~ 1GHz | Oct. 10, 2013 | Aug. 10, 2014~ Oct. 02, 2014 | Oct. 09, 2014 | Radiation (03CH07-HY) |
| Double Ridge Horn Antenna | ESCO | 3117 | 75962 | 1GHz~18GHz | Aug. 22, 2013 | Aug. 10, 2014~ Aug. 18, 2014 | Aug. 21, 2014 | Radiation (03CH07-HY) |
| Double Ridge Horn Antenna | ESCO | 3117 | 75962 | 1GHz~18GHz | Aug. 19, 2014 | Aug. 19, 2014~ Oct. 02, 2014 | Aug. 18, 2015 | Radiation (03CH07-HY) |
| Double Ridge Horn Antenna | ESCO | 3117 | 75962 | 1GHz~18GHz | Aug. 19, 2014 | Aug. 10, 2014~ Oct. 02, 2014 | Aug. 18, 2015 | Radiation (03CH07-HY) |
| Preamplifier | COM-POWER | PA-103A | 161241 | 10 MHz ~ 1000MHz | Mar. 17, 2014 | Aug. 10, 2014~ Oct. 02, 2014 | Mar. 16, 2015 | Radiation (03CH07-HY) |
| Preamplifier | Agilent | 8449B | 3008A02362 | 1 GHz~26.5 GHz | Nov. 29, 2013 | Aug. 10, 2014~ Oct. 02, 2014 | Nov. 28, 2014 | Radiation (03CH07-HY) |
| Turn Table | ChainTek | ChainTek 3000 | N/A | 0 ~ 360 degree | N/A | Aug. 10, 2014~ Oct. 02, 2014 | N/A | Radiation (03CH07-HY) |
| Antenna Mast | ChainTek | M-400-0 | 114/800060 4/L | N/A | N/A | Aug. 10, 2014~ Oct. 02, 2014 | N/A | Radiation (03CH07-HY) |
| SHF-EHF Horn Antenna | SCHWARZBECK | BBHA 9170 | BBHA91702 51 | 15GHz- 40GHz | Oct. 03, 2013 | Aug. 10, 2014~ Oct. 01, 2014 | Oct. 02, 2014 | Radiation (03CH07-HY) |
| SHF-EHF Horn Antenna | SCHWARZBECK | BBHA 9170 | BBHA91702 51 | 15GHz- 40GHz | Oct. 02, 2014 | Oct. 02, 2014 | Oct. 01, 2015 | Radiation (03CH07-HY) |



5 Uncertainty of Evaluation

Uncertainty of Radiated Emission Measurement (30 MHz ~ 1000 MHz)

| | |
|---|------|
| Measuring Uncertainty for a Level of Confidence of 95% ($U = 2Uc(y)$) | 4.50 |
|---|------|