



# FCC RF Test Report

**APPLICANT** : HTC Corporation  
**EQUIPMENT** : Smartphone  
**MODEL NAME** : 0PF1100  
**FCC ID** : NM80PF1100  
**STANDARD** : FCC Part 15 Subpart C §15.247  
**CLASSIFICATION** : (DTS) Digital Transmission System

The product was received on Aug. 12, 2014 and testing was completed on Sep. 06, 2014. We, SPORTON INTERNATIONAL (KUNSHAN) INC., would like to declare that the tested sample has been evaluated in accordance with the test procedures and has been in compliance with the applicable technical standards.

The test results in this report apply exclusively to the tested model / sample. Without written approval of SPORTON INTERNATIONAL (KUNSHAN) INC., the test report shall not be reproduced except in full.

Reviewed by: Joseph Lin / Supervisor

Approved by: Jones Tsai / Manager



**SPORTON INTERNATIONAL (KUNSHAN) INC.**  
**No. 3-2, PingXiang Road, Kunshan, Jiangsu Province, P.R.C.**



## TABLE OF CONTENTS

|  |           |
|--|-----------|
| REVISION HISTORY.....  | 3         |
| SUMMARY OF TEST RESULT .....                                     | 4         |
| <b>1 GENERAL DESCRIPTION.....</b>                                | <b>5</b>  |
| 1.1 Applicant.....   | 5         |
| 1.2 Manufacturer.....  | 5         |
| 1.3 Product Feature of Equipment Under Test.....                 | 5         |
| 1.4 Product Specification subjective to this standard .....      | 5         |
| 1.5 Modification of EUT .....                                    | 6         |
| 1.6 Testing Location .....                                       | 6         |
| 1.7 Applicable Standards.....                                    | 6         |
| <b>2 TEST CONFIGURATION OF EQUIPMENT UNDER TEST.....</b>         | <b>7</b>  |
| 2.1 Descriptions of Test Mode.....                               | 7         |
| 2.2 Test Mode.....   | 8         |
| 2.3 Connection Diagram of Test System.....                       | 9         |
| 2.4 Support Unit used in test configuration and system.....      | 10        |
| 2.5 EUT Operation Test Setup .....                               | 10        |
| 2.6 Measurement Results Explanation Example.....                 | 11        |
| <b>3 TEST RESULT .....</b>                                       | <b>12</b> |
| 3.1 6dB and 99% Bandwidth Measurement.....                       | 12        |
| 3.2 Peak Output Power Measurement .....                          | 17        |
| 3.3 Power Spectral Density Measurement .....                     | 19        |
| 3.4 Conducted Band Edges and Spurious Emission Measurement ..... | 25        |
| 3.5 Radiated Band Edges and Spurious Emission Measurement .....  | 31        |
| 3.6 AC Conducted Emission Measurement.....                       | 40        |
| 3.7 Antenna Requirements.....                                    | 44        |
| <b>4 LIST OF MEASURING EQUIPMENT.....</b>                        | <b>45</b> |
| <b>5 UNCERTAINTY OF EVALUATION.....</b>                          | <b>46</b> |





### SUMMARY OF TEST RESULT

| Report Section | FCC Rule              | IC Rule            | Description                                   | Limit                          | Result | Remark                                  |
|----------------|-----------------------|--------------------|---|--------------------------------|--------|---|
| 3.1            | 15.247(a)(2)          | RSS-210<br>A8.2(a) | 6dB Bandwidth                                 | $\geq 0.5\text{MHz}$           | Pass   | -                                       |
| 3.1            | -                     | RSS-Gen<br>4.6.1   | 99% Bandwidth                                 | -                              | Pass   | -                                       |
| 3.2            | 15.247(b)(1)          | RSS-210<br>A8.1(b) | Peak Output Power                             | $\leq 30\text{dBm}$            | Pass   | -                                       |
| 3.3            | 15.247(e)             | RSS-210<br>A8.2(b) | Power Spectral Density                        | $\leq 8\text{dBm}/3\text{kHz}$ | Pass   | -                                       |
| 3.4            | 15.247(d)             | RSS-210<br>A8.5    | Conducted Band Edges<br>and Spurious Emission | $\leq 20\text{dBc}$            | Pass   | -                                       |
| 3.5            | 15.247(d)             | RSS-210<br>A8.5    | Radiated Band Edges<br>and Spurious Emission  | 15.209(a) &<br>15.247(d)       | Pass   | Under limit<br>8.38 dB at<br>30.000 MHz |
| 3.6            | 15.207                | RSS-Gen<br>7.2.4   | AC Conducted Emission                         | 15.207(a)                      | Pass   | Under limit<br>5.94 dB at<br>0.500 MHz  |
| 3.7            | 15.203 &<br>15.247(b) | RSS-210<br>A8.4    | Antenna Requirement                           | N/A                            | Pass   | -                                       |



# 1 General Description

## 1.1 Applicant

HTC Corporation

No.23, Xinghua Rd., Taoyuan City, Taoyuan County 330, Taiwan.

## 1.2 Manufacturer

Compal Electronics, Inc.

Asia Plaza Building B, No. 385, YangGuang Street, Neihu, Taipei, 11491,Taiwan

## 1.3 Product Feature of Equipment Under Test

| Product Feature                 |  |
|---------------------------------|--|
| Equipment                       | Smartphone   |
| Sample 1                        | EUT with LCD panel 1, touch panel 1, Camera and Battery  |
| Sample 2                        | EUT with LCD panel 1, touch panel 2, Camera and Battery  |
| Sample 3                        | EUT with LCD panel 2, touch panel 3, Camera and Battery  |
| Model Name                      | 0PF1100  |
| FCC ID                          | NM80PF1100   |
| EUT supports Radios application | GSM/GPRS/EGPRS/WCDMA/HSPA/HSPA+ (Downlink Only)/<br>WLAN 2.4GHz 802.11b/g/n HT20/HT40/<br>Bluetooth v3.0 + EDR/Bluetooth v4.0 LE |
| HW Version                      | GA-424   |
| SW Version                      | 1.00.506.4   |
| EUT Stage                       | Identical Prototype  |

Remark: The above EUT's information was declared by manufacturer. Please refer to the specifications or user's manual for more detailed description.

## 1.4 Product Specification subjective to this standard

| Product Specification subjective to this standard |  |
|---|--|
| Tx/Rx Frequency Range                             | 2402 MHz ~ 2480 MHz                            |
| Number of Channels                                | 40   |
| Carrier Frequency of Each Channel                 | 40 Channel(37 hopping + 3 advertising channel) |
| Maximum Output Power to Antenna                   | 5.45 dBm (0.0035 W)                            |
| 99% Occupied Bandwidth                            | 1.020MHz                                       |
| Antenna Type/Gain                                 | Monopole Antenna with gain 2 dBi               |
| Type of Modulation                                | Bluetooth v4.0 LE : GFSK                       |



### 1.5 Modification of EUT

No modifications are made to the EUT during all test items.

### 1.6 Testing Location

|                           |  |           |         |                                |
|---------------------------|--|-----------|---------|--------------------------------|
| <b>Test Site</b>          | SPORTON INTERNATIONAL (KUNSHAN) INC.   |           |         |                                |
| <b>Test Site Location</b> | No. 3-2, PingXiang Road, Kunshan, Jiangsu Province, P.R.C.<br>TEL: +86-0512-5790-0158<br>FAX: +86-0512-5790-0958 |           |         |                                |
| <b>Test Site No.</b>      | <b>Sporton Site No.</b>  |           |         | <b>FCC/IC Registration No.</b> |
|                           | TH01-KS  | 03CH01-KS | CO01-KS | 149928/4086E-1                 |

### 1.7 Applicable Standards

According to the specifications of the manufacturer, the EUT must comply with the requirements of the following standards:

- ♦ FCC Part 15 Subpart C §15.247
- ♦ FCC KDB Publication No. 558074 D01 DTS Meas. Guidance v03r02
- ♦ ANSI C63.4-2003
- ♦ IC RSS-210 Issue 8
- ♦ IC RSS-Gen Issue 3
- ♦ NOTICE 2012-DRS0126

**Remark:**

1. All test items were verified and recorded according to the standards and without any deviation during the test.
2. This EUT has also been tested and complied with the requirements of FCC Part 15, Subpart B, recorded in a separate test report.
3. Per the section 2.2.3 of Notice of 2012-DRS0126, “ Receivers Excluded from Industry Canada Requirements”, only radiocommunication receivers operating in stand-alone mode within the band 30-960 MHz and scanner receivers are subject to Industry Canada requirements.



## 2 Test Configuration of Equipment Under Test

### 2.1 Descriptions of Test Mode

The RF output power was recorded in the following table:

| Channel | Frequency | Bluetooth v4.0 LE RF Output Power |  |
|---------|-----------|-----------------------------------|--|
|         |           | Data Rate / Modulation            |  |
|         |           | GFSK                              |  |
|         |           | 1Mbps                             |  |
| Ch00    | 2402MHz   | 4.71 dBm                          |  |
| Ch19    | 2440MHz   | 5.19 dBm                          |  |
| Ch39    | 2480MHz   | 5.45 dBm                          |  |

- a. The EUT has been associated with peripherals and configuration operated in a manner tended to maximize its emission characteristics in a typical application. Frequency range investigated: conduction (150 kHz to 30 MHz), radiation (9 kHz to the 10th harmonic of the highest fundamental frequency or to 40 GHz, whichever is lower). Pre-scanned tests, X, Y, Z in three orthogonal panels to determine the final configuration (Z plane as worst plane) from all possible combinations.
  
- b. AC power line Conducted Emission was tested under maximum output power.



## 2.2 Test Mode

The following summary table is showing all test modes to demonstrate in compliance with the standard.

| Summary table of Test Cases  |  |
|--|--|
| Test Item  | Data Rate / Modulation   |
|  | Bluetooth v4.0 LE / GFSK   |
| Conducted TCs  | Mode 1: Bluetooth Tx CH00_2402 MHz_1Mbps<br>Mode 2: Bluetooth Tx CH19_2440 MHz_1Mbps<br>Mode 3: Bluetooth Tx CH39_2480 MHz_1Mbps |
| Radiated TCs   | Mode 1: Bluetooth Tx CH00_2402 MHz_1Mbps<br>Mode 2: Bluetooth Tx CH19_2440 MHz_1Mbps<br>Mode 3: Bluetooth Tx CH39_2480 MHz_1Mbps |
| AC Conducted Emission  | Mode 1: GSM850 Idle + Bluetooth Link + WLAN Link + USB Cable1 (Charging from Adapter1) + Earphone1 for Sample 1                  |
| <b>Remark:</b><br>1. For Radiated TCs, the tests were performance with adapter 1, battery, earphone1 and USB cable1.<br>2. All the radiated test cases were performance with Sample 1. |  |



## 2.3 Connection Diagram of Test System

### <Bluetooth v4.0 LE Tx Mode>

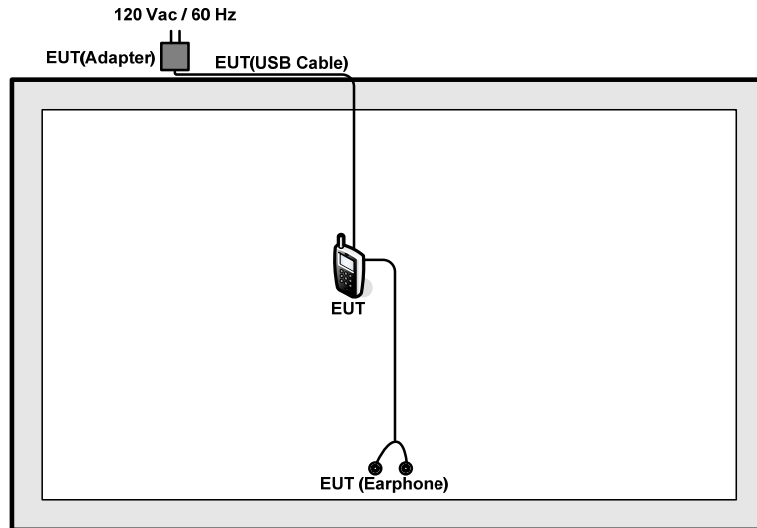

### <AC Conducted Emission Mode>

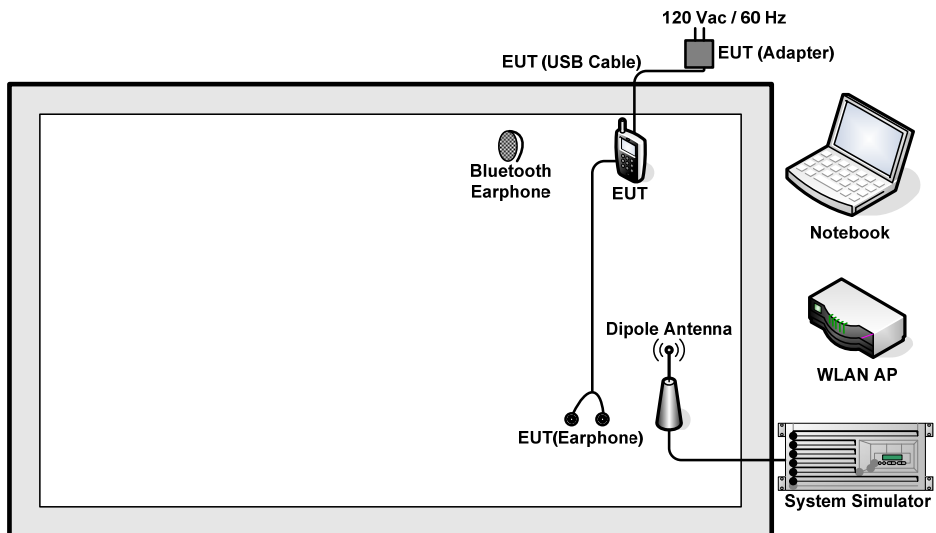



## 2.4 Support Unit used in test configuration and system

| Item | Equipment          | Trade Name | Model Name | FCC ID      | Data Cable | Power Cord   |
|------|--------------------|------------|------------|-------------|------------|--|
| 1.   | System Simulator   | R&S        | CMU 200    | N/A         | N/A        | Unshielded, 1.8 m  |
| 2.   | WLAN AP            | D-Link     | DIR-855    | KA2DIR855A2 | N/A        | Unshielded, 1.8 m  |
| 3.   | Notebook           | Lenovo     | G480       | PRC4        | N/A        | shielded cable<br>DC O/P 1.8 m<br>unshielded AC<br>I/P cable 1.8 m |
| 4.   | Bluetooth Earphone | Lenovo     | LBH505     | N/A         | N/A        | N/A  |

## 2.5 EUT Operation Test Setup

For Bluetooth v4.0 LE function, the engineering test program was provided and enabled to make EUT continuous transmit/receive.

For AC power line conducted emissions, the EUT was set to connect with the WLAN AP under large package sizes transmission.



## 2.6 Measurement Results Explanation Example

For all conducted test items:

The offset level is set in the spectrum analyzer to compensate the RF cable loss and attenuator factor between EUT conducted output port and spectrum analyzer. With the offset compensation, the spectrum analyzer reading level is exactly the EUT RF output level.

Example :

The spectrum analyzer offset is derived from RF cable loss and attenuator factor.

*Offset = RF cable loss + attenuator factor.*

Following shows an offset computation example with cable loss 6.0 dB and 0dB attenuator.

$$\begin{aligned} \text{Offset(dB)} &= \text{RF cable loss(dB)} + \text{attenuator factor(dB)}. \\ &= 6.0 + 0 = 6.0 \text{ (dB)} \end{aligned}$$

### 3 Test Result

#### 3.1 6dB and 99% Bandwidth Measurement

##### 3.1.1 Limit of 6dB and 99% Bandwidth

The minimum 6 dB bandwidth shall be at least 500 kHz.

##### 3.1.2 Measuring Instruments

The section 4.0 of List of Measuring Equipment of this test report is used for test.

##### 3.1.3 Test Procedures

1. The testing follows FCC KDB Publication No. 558074 D01 DTS Meas. Guidance v03r02.
2. The RF output of EUT was connected to the spectrum analyzer by RF cable and attenuator. The path loss was compensated to the results for each measurement.
3. Set to the maximum power setting and enable the EUT transmit continuously.
4. Make the measurement with the spectrum analyzer's resolution bandwidth (RBW) = 100 kHz. Set the Video bandwidth (VBW) = 300 kHz. In order to make an accurate measurement. The 6 dB bandwidth must be greater than 500 kHz.
5. For 99% Bandwidth Measurement, the spectrum analyzer's resolution bandwidth (RBW) is set 30kHz and set the Video bandwidth (VBW) = 100kHz.
6. Measure and record the results in the test report.

##### 3.1.4 Test Setup





3.1.5 Test Result of 6dB Bandwidth

|                 |                   |                     |         |
|-----------------|-------------------|---------------------|---------|
| Test Mode :     | Bluetooth v4.0 LE | Temperature :       | 24~25°C |
| Test Engineer : | Issac Song        | Relative Humidity : | 49~51%  |

| Channel | Frequency (MHz) | 6dB Bandwidth (MHz) | 6dB Bandwidth Min. Limit (MHz) | Pass/Fail |
|---------|-----------------|---------------------|--------------------------------|-----------|
| 00      | 2402            | 0.688               | 0.5                            | Pass      |
| 19      | 2440            | 0.684               | 0.5                            | Pass      |
| 39      | 2480            | 0.696               | 0.5                            | Pass      |

6 dB Bandwidth Plot on Channel 00

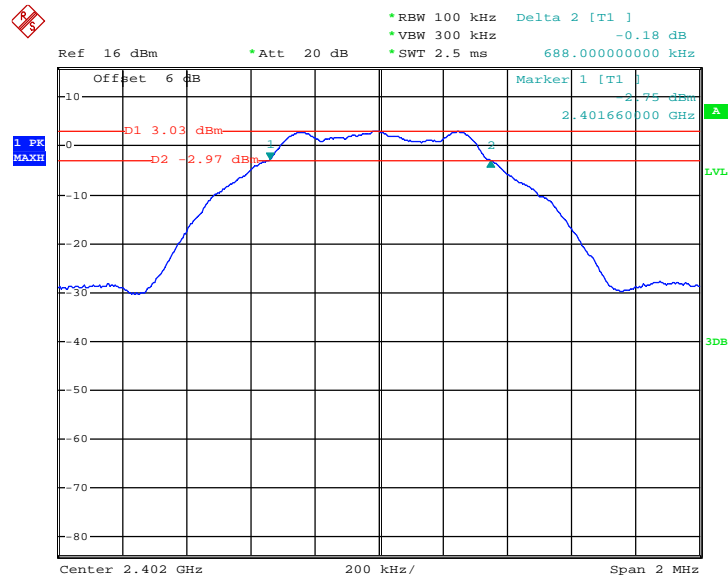

Date: 16.AUG.2014 11:22:51



6 dB Bandwidth Plot on Channel 19

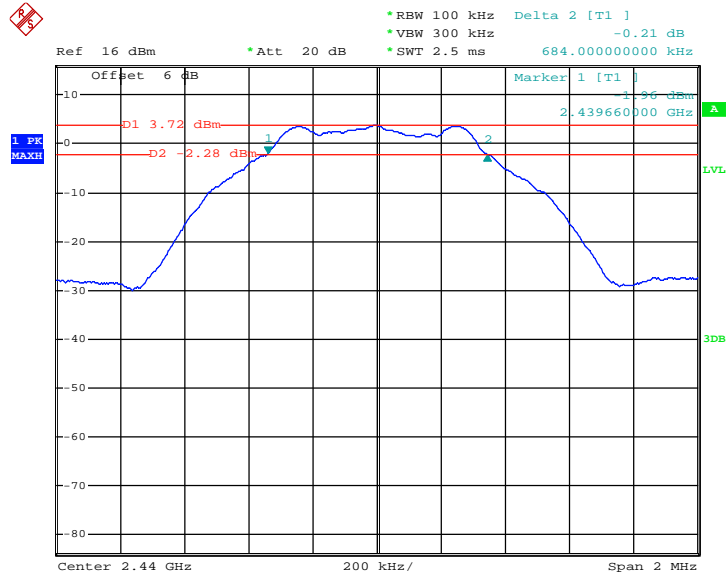

Date: 16.AUG.2014 11:27:09

6 dB Bandwidth Plot on Channel 39

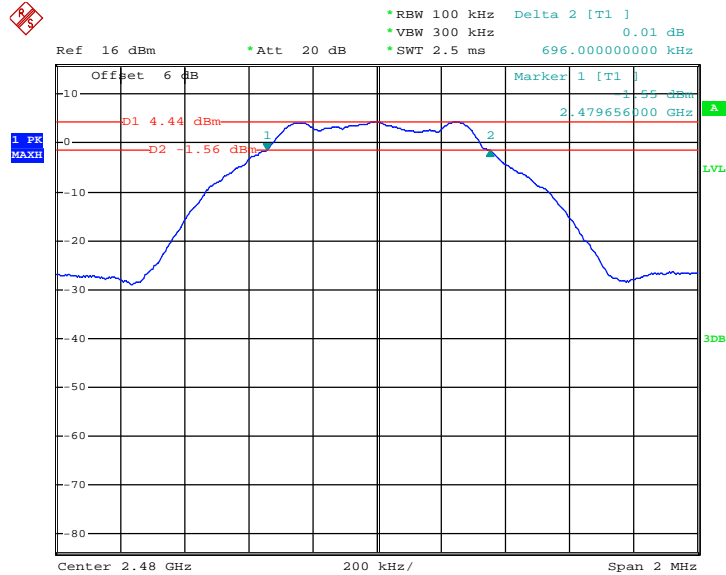

Date: 16.AUG.2014 11:29:55



3.1.6 Test Result of 99% Occupied Bandwidth

|                 |                   |                     |         |
|-----------------|-------------------|---------------------|---------|
| Test Mode :     | Bluetooth v4.0 LE | Temperature :       | 24~25°C |
| Test Engineer : | Issac Song        | Relative Humidity : | 49~51%  |

| Channel | Frequency (MHz) | 99% Occupied Bandwidth (MHz) |
|---------|-----------------|------------------------------|
| 00      | 2402            | 1.020                        |
| 19      | 2440            | 1.020                        |
| 39      | 2480            | 1.020                        |

99% Bandwidth Plot on Channel 00

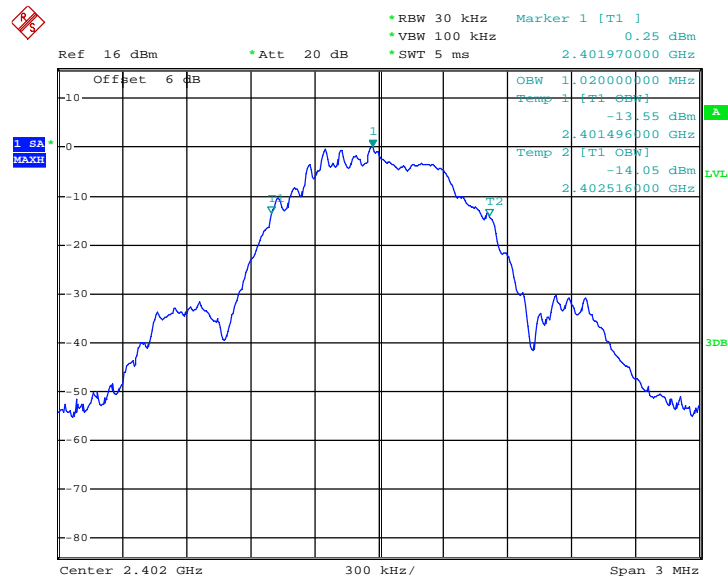

Date: 16.AUG.2014 12:15:47



99% Occupied Bandwidth Plot on Channel 19

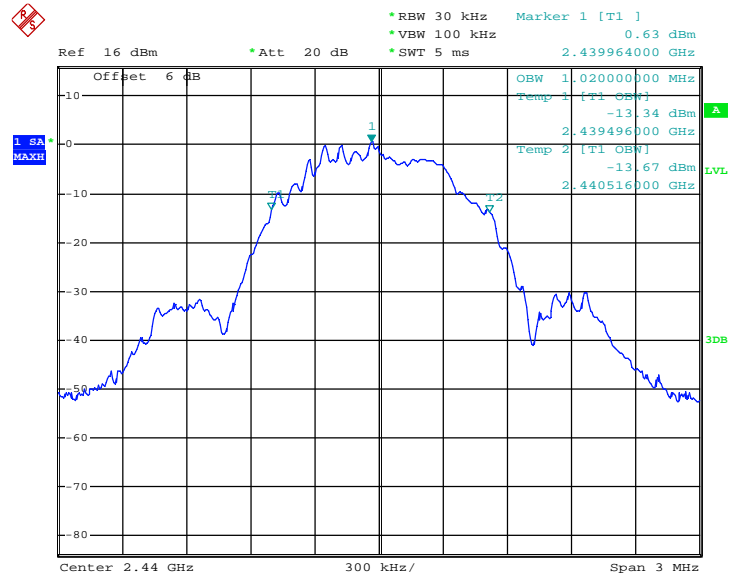

Date: 16.AUG.2014 12:17:12

99% Occupied Bandwidth Plot on Channel 39

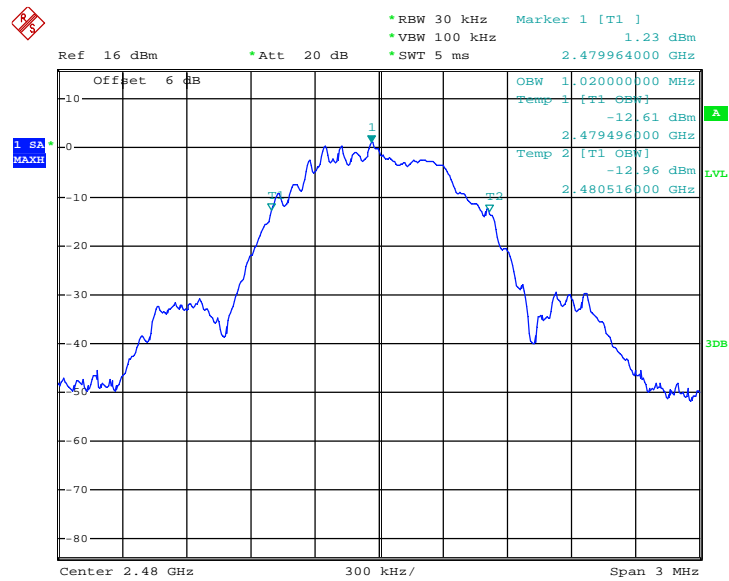

Date: 16.AUG.2014 12:18:06

Note : The occupied channel bandwidth is maintained within the band of operation for all of the modulations.



## 3.2 Peak Output Power Measurement

### 3.2.1 Limit of Peak Output Power

For systems using digital modulation in the 2400-2483.5MHz, the limit for peak output power is 30dBm. If transmitting antenna of directional gain greater than 6dBi is used, the peak output power from the intentional radiator shall be reduced below the above stated value by the amount in dB that the directional gain of the antenna exceeds 6 dBi. In case of point-to-point operation, the limit has to be reduced by 1dB for every 3dB that the directional gain of the antenna exceeds 6dBi.

### 3.2.2 Measuring Instruments

The section 4.0 of List of Measuring Equipment of this test report is used for test.

### 3.2.3 Test Procedures

1. The testing follows the Measurement Procedure of FCC KDB No. 558074 DTS D01 Meas. Guidance v03r02.
2. The RF output of EUT was connected to the power meter by RF cable and attenuator. The path loss was compensated to the results for each measurement.
3. Set to the maximum power setting and enable the EUT transmit continuously.
4. Measure the conducted output power and record the results in the test report.

### 3.2.4 Test Setup

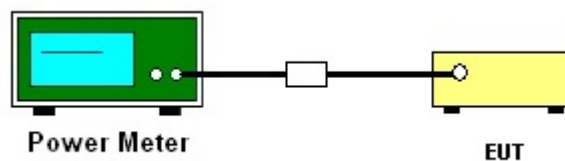



3.2.5 Test Result of Peak Output Power

|                 |                   |                     |         |
|-----------------|-------------------|---------------------|---------|
| Test Mode :     | Bluetooth v4.0 LE | Temperature :       | 24~25°C |
| Test Engineer : | Issac Song        | Relative Humidity : | 49~51%  |

| Channel | Frequency (MHz) | RF Power (dBm) |                   |           |
|---------|-----------------|----------------|-------------------|-----------|
|         |                 | GFSK           | Max. Limits (dBm) | Pass/Fail |
|         |                 | 1 Mbps         |                   |           |
| 00      | 2402            | 4.71           | 30.00             | Pass      |
| 19      | 2440            | 5.19           | 30.00             | Pass      |
| 39      | 2480            | 5.45           | 30.00             | Pass      |

### 3.3 Power Spectral Density Measurement

#### 3.3.1 Limit of Power Spectral Density

The peak power spectral density shall not be greater than 8dBm in any 3kHz band at any time interval of continuous transmission.

#### 3.3.2 Measuring Instruments

The section 4.0 of List of Measuring Equipment of this test report is used for test.

#### 3.3.3 Test Procedures

1. The testing follows Measurement Procedure 10.2 Method PKPSD of FCC KDB Publication No. 558074 D01 DTS Meas. Guidance v03r02
2. The RF output of EUT was connected to the spectrum analyzer by RF cable and attenuator. The path loss was compensated to the results for each measurement.
3. Set to the maximum power setting and enable the EUT transmit continuously.
4. Make the measurement with the spectrum analyzer's resolution bandwidth (RBW) = 3 kHz. Video bandwidth VBW = 10 kHz In order to make an accurate measurement, set the span to 1.5 times DTS Channel Bandwidth. (6dB BW)
5. Detector = peak, Sweep time = auto couple, Trace mode = max hold, Allow trace to fully stabilize. Use the peak marker function to determine the maximum power level.
6. Measure and record the results in the test report.
7. The Measured power density (dBm)/ 100kHz is a reference level and used as 20dBc down limit line for Conducted Band Edges and Conducted Spurious Emission.

#### 3.3.4 Test Setup

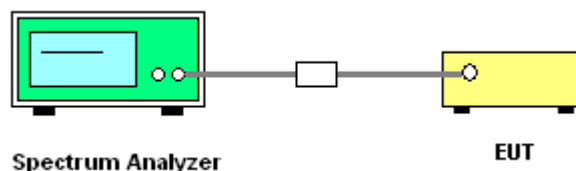



### 3.3.5 Test Result of Power Spectral Density

|                 |                   |                     |         |
|-----------------|-------------------|---------------------|---------|
| Test Mode :     | Bluetooth v4.0 LE | Temperature :       | 24~25°C |
| Test Engineer : | Issac Song        | Relative Humidity : | 49~51%  |

| Channel | Frequency (MHz) | Power Density    |                | Max. Limits (dBm/3kHz) | Pass/Fail |
|---------|-----------------|------------------|----------------|------------------------|-----------|
|         |                 | PSD/100kHz (dBm) | PSD/3kHz (dBm) |                        |           |
| 00      | 2402            | 3.64             | -10.84         | 8                      | Pass      |
| 19      | 2440            | 4.17             | -10.49         | 8                      | Pass      |
| 39      | 2480            | 4.69             | -9.96          | 8                      | Pass      |

**Note:**

1. Measured power density (dBm) has offset with cable loss.
2. The Measured power density (dBm)/ 100kHz is reference level and used as 20dBc down for Conducted Band Edges and Conducted Spurious Emission limit line.



### 3.3.6 Test Result of Power Spectral Density Plots (100kHz)

PSD 100kHz Plot on Channel 00

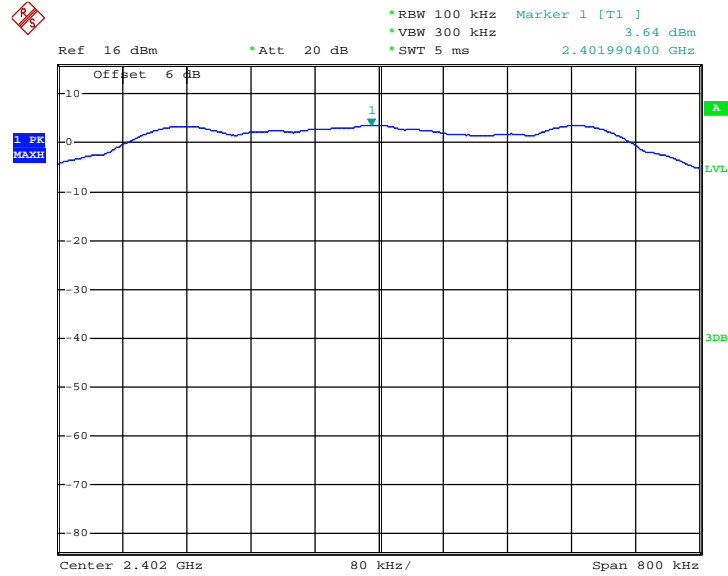

Date: 16.AUG.2014 11:34:21



PSD 100kHz Plot on Channel 19

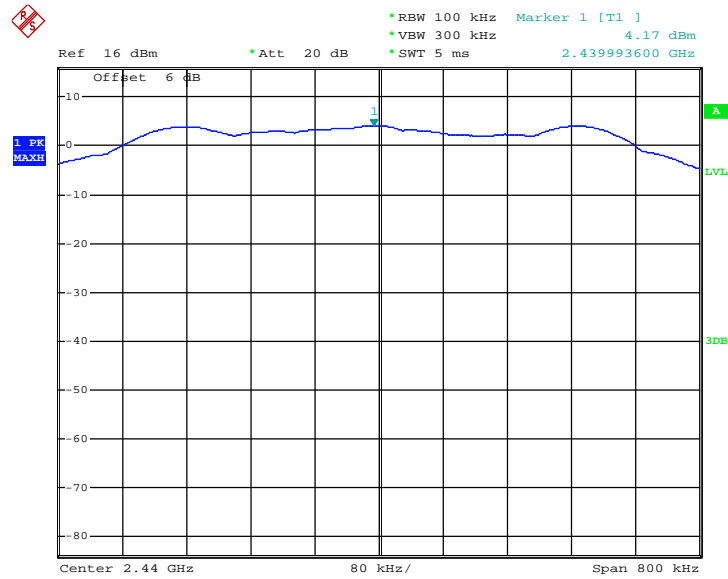

Date: 16.AUG.2014 12:36:51

PSD 100kHz Plot on Channel 39

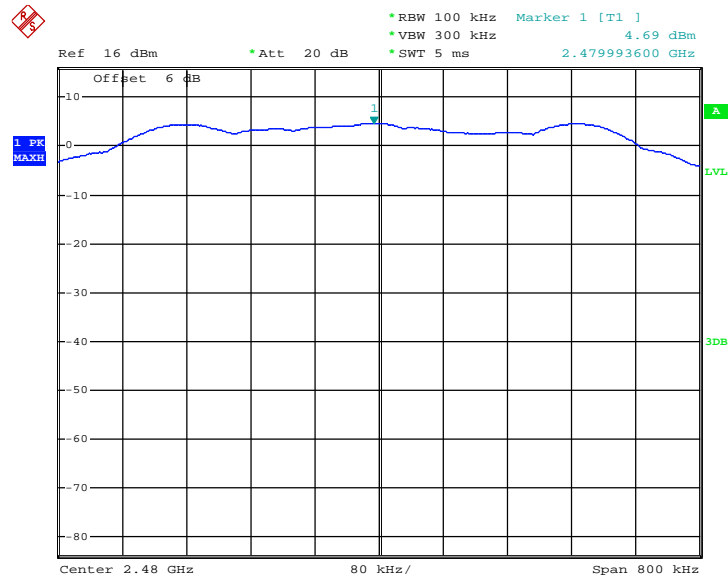

Date: 16.AUG.2014 11:37:43



### 3.3.7 Test Result of Power Spectral Density Plots (3kHz)

PSD 3kHz Plot on Channel 00

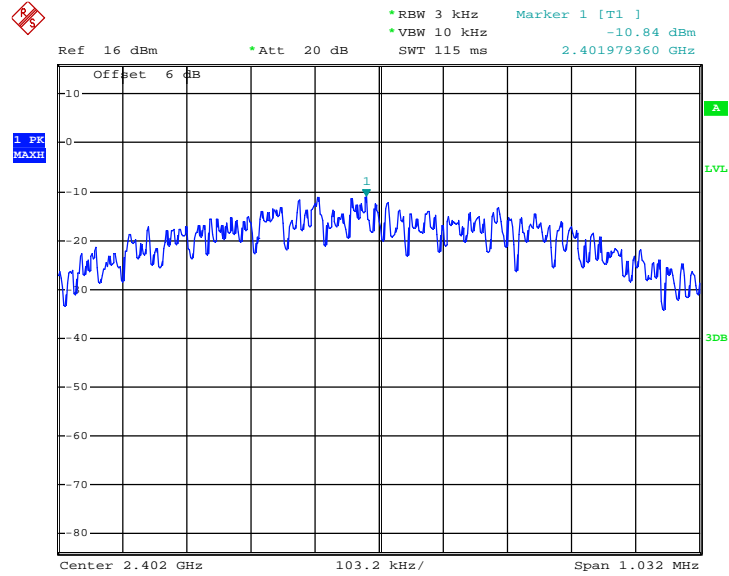

Date: 16.AUG.2014 12:23:10



PSD 3kHz Plot on Channel 19

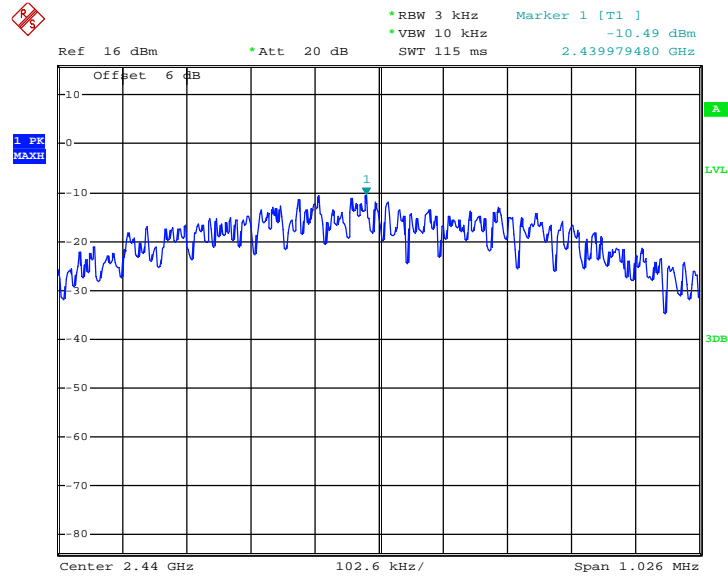

Date: 16.AUG.2014 12:24:39

PSD 3kHz Plot on Channel 39

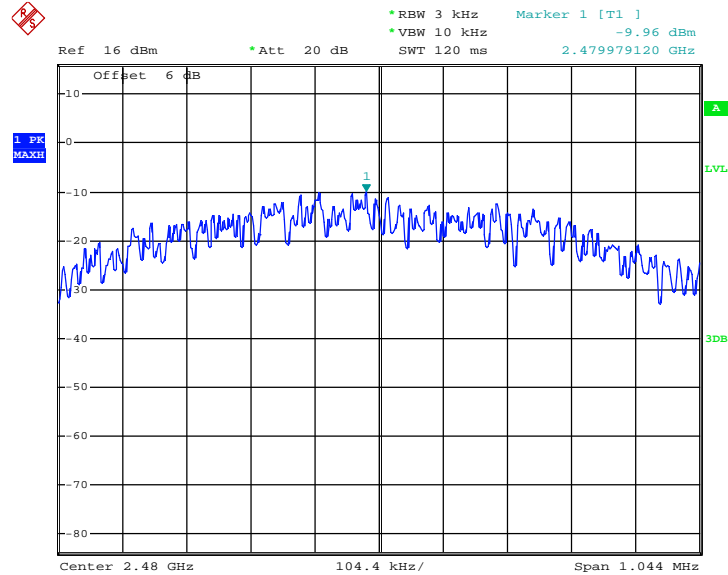

Date: 16.AUG.2014 12:25:52



## 3.4 Conducted Band Edges and Spurious Emission Measurement

### 3.4.1 Limit of Conducted Band Edges and Spurious Emission

All harmonics/spurious must be at least 20 dB down from the highest emission level within the authorized band.

### 3.4.2 Measuring Instruments

The section 4.0 of List of Measuring Equipment of this test report is used for test.

### 3.4.3 Test Procedure

1. The testing follows FCC KDB Publication No. 558074 D01 DTS Meas. Guidance v03r02.
2. The RF output of EUT was connected to the spectrum analyzer by RF cable and attenuator. The path loss was compensated to the results for each measurement.
3. Set to the maximum power setting and enable the EUT transmit continuously.
4. Set RBW = 100 kHz, VBW=300 kHz, Peak Detector. Unwanted Emissions measured in any 100 kHz bandwidth outside of the authorized frequency band shall be attenuated by at least 20 dB relative to the maximum in-band peak PSD level in 100 kHz when maximum peak conducted output power procedure is used. If the transmitter complies with the conducted power limits based on the use of RMS averaging over a time interval, the attenuation required under this paragraph shall be 30 dB instead of 20 dB per 15.247(d).
5. Measure and record the results in the test report.
6. The RF fundamental frequency should be excluded against the limit line in the operating frequency band.

### 3.4.4 Test Setup

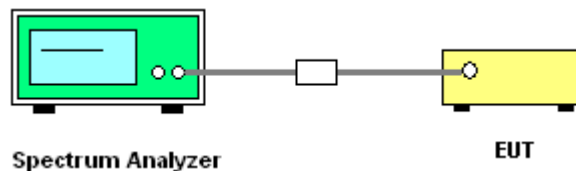



### 3.4.5 Test Result of Conducted Band Edges

|                |                   |                     |            |
|----------------|-------------------|---------------------|------------|
| Test Mode :    | Bluetooth v4.0 LE | Temperature :       | 24~25°C    |
| Test Channel : | 00 and 39         | Relative Humidity : | 49~51%     |
|                |                   | Test Engineer :     | Issac Song |

#### Low Band Edge Plot on Channel 00

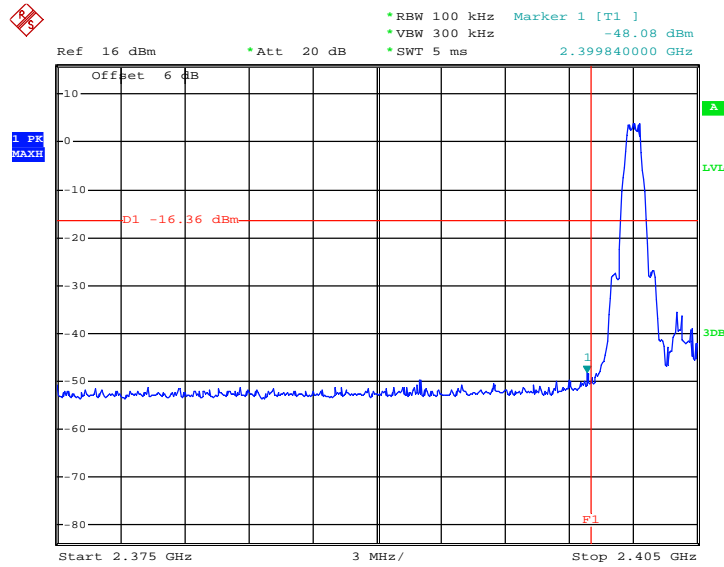

Date: 16.AUG.2014 11:44:47

#### High Band Edge Plot on Channel 39

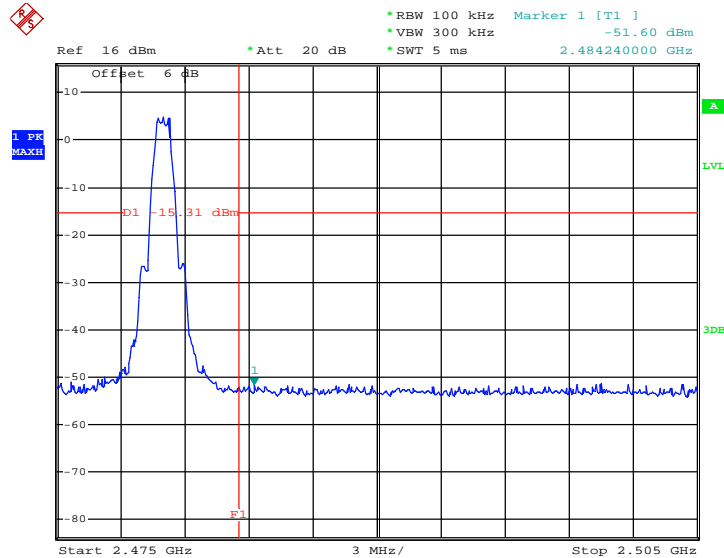

Date: 16.AUG.2014 11:48:36



### 3.4.6 Test Result of Conducted Spurious Emission

|                |                   |                     |            |
|----------------|-------------------|---------------------|------------|
| Test Mode :    | Bluetooth v4.0 LE | Temperature :       | 24~25°C    |
| Test Channel : | 00                | Relative Humidity : | 49~51%     |
|                |                   | Test Engineer :     | Issac Song |

Conducted Spurious Emission Plot on Bluetooth v4.0 LE 1Mbps GFSK Channel 00

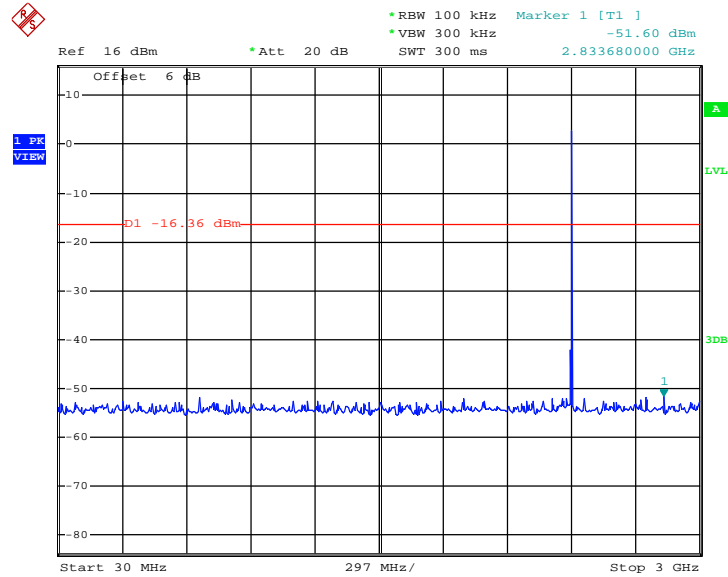

Date: 16.AUG.2014 12:06:36



Conducted Spurious Emission Plot on Bluetooth v4.0 LE 1Mbps  
GFSK Channel 00

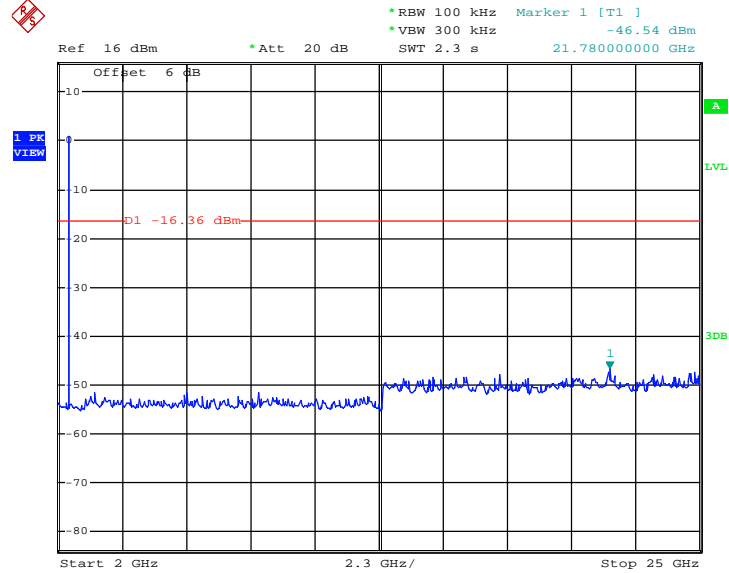

Date: 16.AUG.2014 12:07:34



|                |                   |                     |            |
|----------------|-------------------|---------------------|------------|
| Test Mode :    | Bluetooth v4.0 LE | Temperature :       | 24~25°C    |
| Test Channel : | 19                | Relative Humidity : | 49~51%     |
|                |                   | Test Engineer :     | Issac Song |

**Conducted Spurious Emission Plot on Bluetooth v4.0 LE 1Mbps  
GFSK Channel 19**

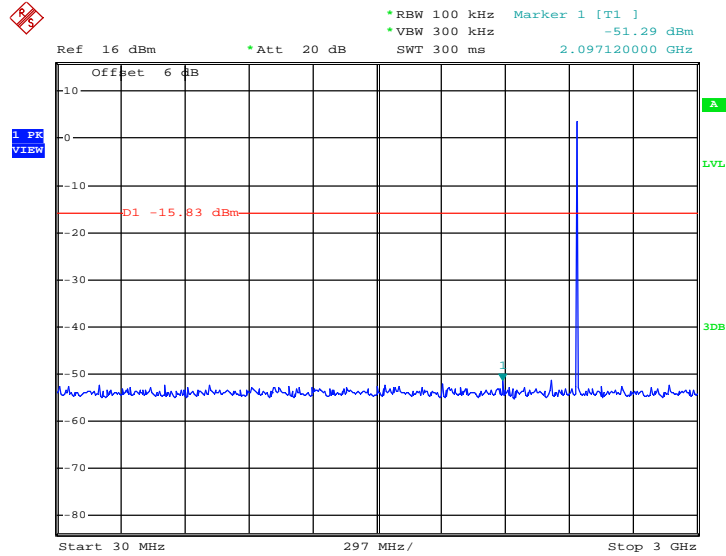

Date: 16.AUG.2014 12:41:26

**Conducted Spurious Emission Plot on Bluetooth v4.0 LE 1Mbps  
GFSK Channel 19**

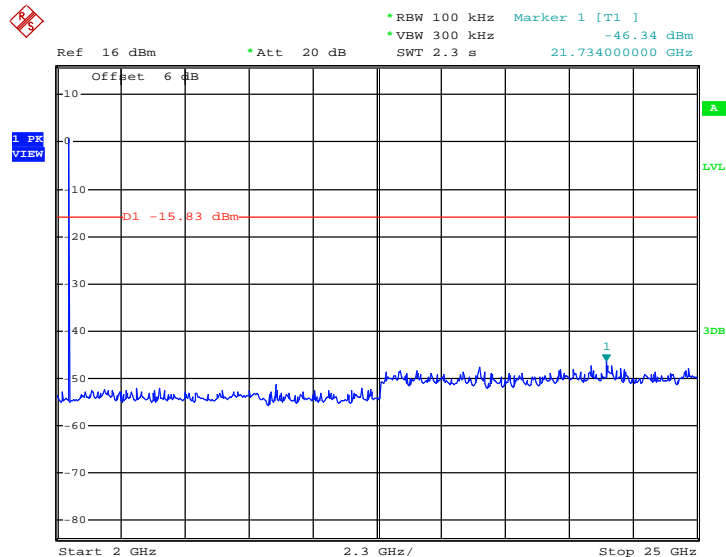

Date: 16.AUG.2014 12:43:32



|                |                   |                     |            |
|----------------|-------------------|---------------------|------------|
| Test Mode :    | Bluetooth v4.0 LE | Temperature :       | 24~25°C    |
| Test Channel : | 39                | Relative Humidity : | 49~51%     |
|                |                   | Test Engineer :     | Issac Song |

**Conducted Spurious Emission Plot on Bluetooth v4.0 LE 1Mbps  
GFSK Channel 39**

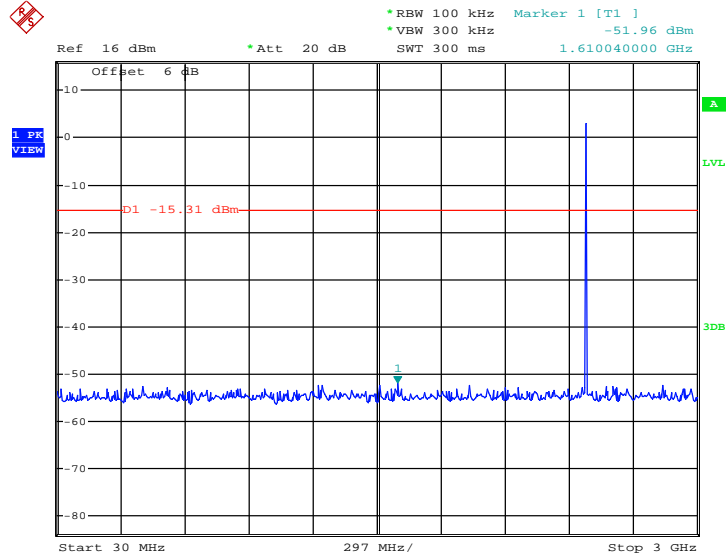

Date: 16.AUG.2014 12:12:37

**Conducted Spurious Emission Plot on Bluetooth v4.0 LE 1Mbps  
GFSK Channel 39**

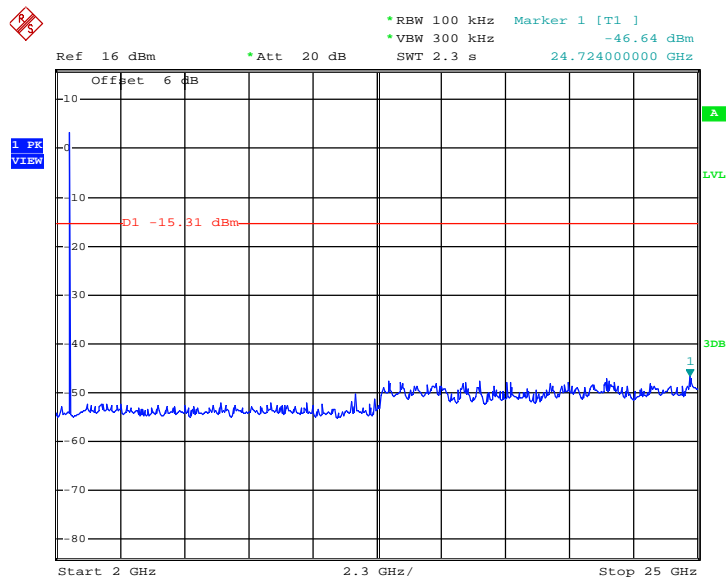

Date: 16.AUG.2014 12:10:11



### 3.5 Radiated Band Edges and Spurious Emission Measurement

#### 3.5.1 Limit of Radiated Band Edges and Spurious Emission

In any 100 kHz bandwidth outside the intentional radiator frequency band, all harmonics/spurious must be at least 20 dB below the highest emission level within the authorized band. If the output power of this device was measured by spectrum analyzer, the attenuation under this paragraph shall be 30 dB instead of 20 dB. In addition, radiated emissions which fall in the restricted bands must also comply with the FCC section 15.209 limits as below.

| Frequency (MHz) | Field Strength (microvolts/meter) | Measurement Distance (meters) |
|-----------------|-----------------------------------|-------------------------------|
| 0.009 – 0.490   | 2400/F(kHz)                       | 300                           |
| 0.490 – 1.705   | 24000/F(kHz)                      | 30                            |
| 1.705 – 30.0    | 30                                | 30                            |
| 30 – 88         | 100                               | 3                             |
| 88 – 216        | 150                               | 3                             |
| 216 - 960       | 200                               | 3                             |
| Above 960       | 500                               | 3                             |

#### 3.5.2 Measuring Instruments

The section 4.0 of List of Measuring Equipment of this test report is used for test.



3.5.3 Test Procedures

1. The testing follows FCC KDB Publication No. 558074 D01 DTS Meas. Guidance v03r02.
2. The EUT was arranged to its worst case and then tune the antenna tower (from 1 m to 4 m) and turntable (from 0 degree to 360 degrees) to find the maximum reading. A pre-amp and a high pass filter are used for the test in order to get better signal level.
3. The EUT was placed on a turntable with 0.8 meter above ground.
4. The EUT was set 3 meters from the interference receiving antenna, which was mounted on the top of a variable height antenna tower.
5. Corrected Reading: Antenna Factor + Cable Loss + Read Level - Preamp Factor = Level
6. For measurement below 1GHz, If the emission level of the EUT measured by the peak detector is 3 dB lower than the applicable limit, the peak emission level will be reported. Otherwise, the emission measurement will be repeated using the quasi-peak detector and reported.
7. Use the following spectrum analyzer settings:
  - (1) Span shall wide enough to fully capture the emission being measured;
  - (2) Set RBW=100 kHz for  $f < 1$  GHz;  $VBW \geq RBW$ ; Sweep = auto; Detector function = peak; Trace = max hold;
  - (3) Set RBW = 1 MHz, VBW= 3MHz for  $f \geq 1$  GHz for peak measurement.  
 For average measurement:
    - $VBW = 10$  Hz, when duty cycle is no less than 98 percent.
    - $VBW \geq 1/T$ , when duty cycle is less than 98 percent where T is the minimum transmission duration over which the transmitter is on and is transmitting at its maximum power control level for the tested mode of operation.

| Band              | Duty Cycle(%) | T(ms) | 1/T(kHz) | VBW Setting |
|-------------------|---------------|-------|----------|-------------|
| Bluetooth v4.0 LE | 60.13         | 0.38  | 2.63     | 3kHz        |



### 3.5.4 Test Setup

For radiated emissions below 30MHz

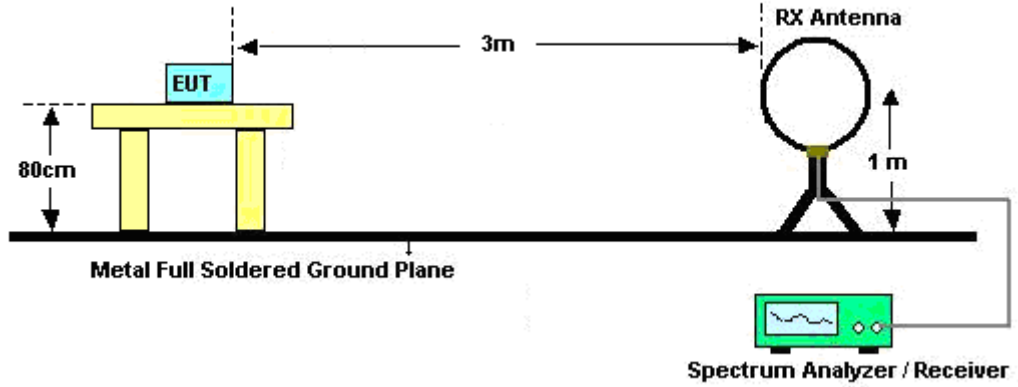

For radiated emissions from 30MHz to 1GHz

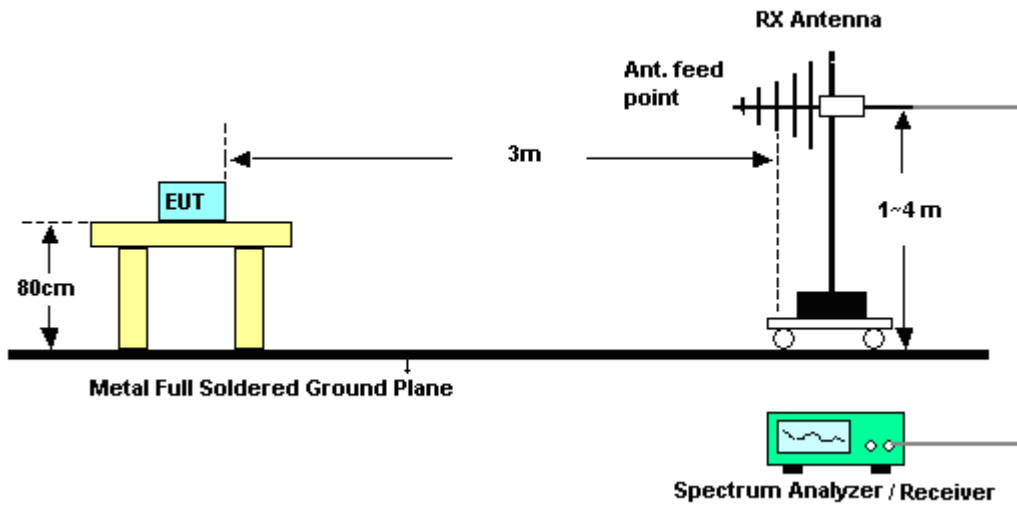

For radiated emissions above 1GHz

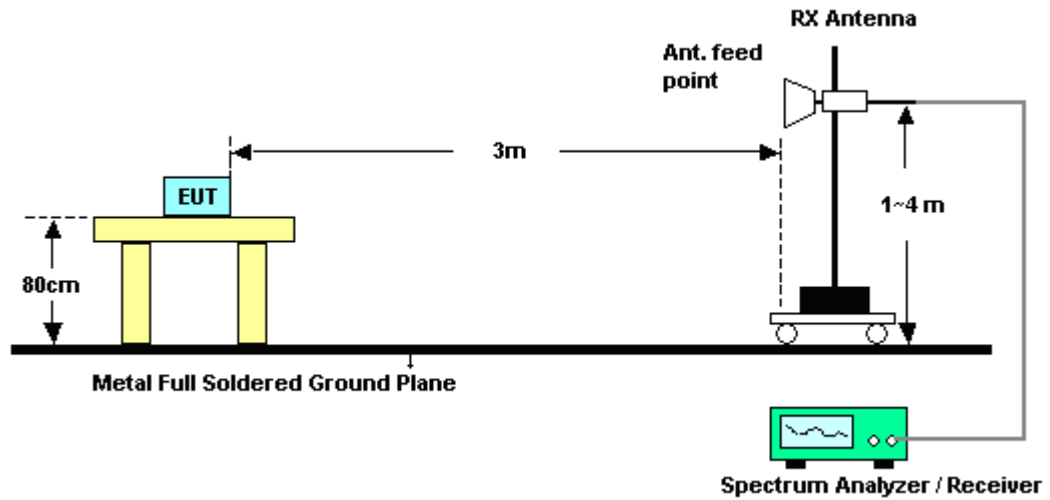

### 3.5.5 Test Results of Radiated Spurious Emissions (9 kHz ~ 30 MHz)

The low frequency, which started from 9 kHz to 30MHz, was pre-scanned and the result which was 20dB lower than the limit line per 15.31(o) was not reported.



3.5.6 Test Result of Radiated Spurious at Band Edges

|                |        |                     |          |
|----------------|--------|---------------------|----------|
| Test Mode :    | Mode 1 | Temperature :       | 22~23°C  |
| Test Channel : | 00     | Relative Humidity : | 42~43%   |
|                |        | Test Engineer :     | Simon Lu |

| ANTENNA POLARITY : HORIZONTAL |                    |                         |                            |                         |                             |                         |                            |                      |                         |         |
|-------------------------------|--------------------|-------------------------|----------------------------|-------------------------|-----------------------------|-------------------------|----------------------------|----------------------|-------------------------|---------|
| Frequency<br>( MHz )          | Level<br>(dBμV /m) | Over<br>Limit<br>( dB ) | Limit<br>Line<br>(dBμV /m) | Read<br>Level<br>(dBμV) | Antenna<br>Factor<br>( dB ) | Cable<br>Loss<br>( dB ) | Preamp<br>Factor<br>( dB ) | Ant<br>Pos<br>( cm ) | Table<br>Pos<br>( deg ) | Remark  |
| 2388.39                       | 45.19              | -28.81                  | 74                         | 46.62                   | 32.01                       | 2.64                    | 36.08                      | 200                  | 25                      | Peak    |
| 2389.2                        | 32.96              | -21.04                  | 54                         | 34.39                   | 32.01                       | 2.64                    | 36.08                      | 200                  | 25                      | Average |

| ANTENNA POLARITY : VERTICAL |                    |                         |                            |                         |                             |                         |                            |                      |                         |         |
|-----------------------------|--------------------|-------------------------|----------------------------|-------------------------|-----------------------------|-------------------------|----------------------------|----------------------|-------------------------|---------|
| Frequency<br>( MHz )        | Level<br>(dBμV /m) | Over<br>Limit<br>( dB ) | Limit<br>Line<br>(dBμV /m) | Read<br>Level<br>(dBμV) | Antenna<br>Factor<br>( dB ) | Cable<br>Loss<br>( dB ) | Preamp<br>Factor<br>( dB ) | Ant<br>Pos<br>( cm ) | Table<br>Pos<br>( deg ) | Remark  |
| 2384.52                     | 45.48              | -28.52                  | 74                         | 47.05                   | 31.95                       | 2.64                    | 36.16                      | 100                  | 53                      | Peak    |
| 2388.75                     | 33.15              | -20.85                  | 54                         | 34.58                   | 32.01                       | 2.64                    | 36.08                      | 100                  | 53                      | Average |

|                |        |                     |          |
|----------------|--------|---------------------|----------|
| Test Mode :    | Mode 3 | Temperature :       | 22~23°C  |
| Test Channel : | 39     | Relative Humidity : | 42~43%   |
|                |        | Test Engineer :     | Simon Lu |

| ANTENNA POLARITY : HORIZONTAL |                    |                         |                            |                         |                             |                         |                            |                      |                         |         |
|-------------------------------|--------------------|-------------------------|----------------------------|-------------------------|-----------------------------|-------------------------|----------------------------|----------------------|-------------------------|---------|
| Frequency<br>( MHz )          | Level<br>(dBμV /m) | Over<br>Limit<br>( dB ) | Limit<br>Line<br>(dBμV /m) | Read<br>Level<br>(dBμV) | Antenna<br>Factor<br>( dB ) | Cable<br>Loss<br>( dB ) | Preamp<br>Factor<br>( dB ) | Ant<br>Pos<br>( cm ) | Table<br>Pos<br>( deg ) | Remark  |
| 2484.07                       | 49.17              | -24.83                  | 74                         | 49.94                   | 32.34                       | 2.68                    | 35.79                      | 100                  | 30                      | Peak    |
| 2484.19                       | 36.27              | -17.73                  | 54                         | 37.04                   | 32.34                       | 2.68                    | 35.79                      | 100                  | 30                      | Average |

| ANTENNA POLARITY : VERTICAL |                    |                         |                            |                         |                             |                         |                            |                      |                         |         |
|-----------------------------|--------------------|-------------------------|----------------------------|-------------------------|-----------------------------|-------------------------|----------------------------|----------------------|-------------------------|---------|
| Frequency<br>( MHz )        | Level<br>(dBμV /m) | Over<br>Limit<br>( dB ) | Limit<br>Line<br>(dBμV /m) | Read<br>Level<br>(dBμV) | Antenna<br>Factor<br>( dB ) | Cable<br>Loss<br>( dB ) | Preamp<br>Factor<br>( dB ) | Ant<br>Pos<br>( cm ) | Table<br>Pos<br>( deg ) | Remark  |
| 2483.98                     | 48.38              | -25.62                  | 74                         | 49.15                   | 32.34                       | 2.68                    | 35.79                      | 120                  | 53                      | Peak    |
| 2483.5                      | 35.33              | -18.67                  | 54                         | 36.1                    | 32.34                       | 2.68                    | 35.79                      | 120                  | 53                      | Average |



3.5.7 Test Result of Radiated Spurious Emission (30MHz ~ 10<sup>th</sup> Harmonic)

Note: Pre-scanned all test modes and only choose the worst case mode recorded in the test report for radiated spurious emission below 1GHz.

|                        |  |                            |            |
|------------------------|--|----------------------------|------------|
| <b>Test Mode :</b>     | Mode 1   | <b>Temperature :</b>       | 22~23°C    |
| <b>Test Channel :</b>  | 00   | <b>Relative Humidity :</b> | 42~43%     |
| <b>Test Engineer :</b> | Simon Lu   | <b>Polarization :</b>      | Horizontal |
| <b>Remark :</b>        | 1. 2402 MHz is fundamental signal which can be ignored.<br>2. Average measurement was not performed if peak level went lower than the average limit. |                            |            |

| Frequency ( MHz ) | Level ( dBμV/m ) | Over Limit ( dB ) | Limit Line ( dBμV/m ) | Read Level ( dBμV ) | Antenna Factor ( dB ) | Cable Loss ( dB ) | Preamp Factor ( dB ) | Ant Pos ( cm ) | Table Pos ( deg ) | Remark  |
|-------------------|------------------|-------------------|-----------------------|---------------------|-----------------------|-------------------|----------------------|----------------|-------------------|---------|
| 2402              | 100.09           | -                 | -                     | 101.51              | 32.01                 | 2.65              | 36.08                | 200            | 25                | Peak    |
| 2402              | 98.94            | -                 | -                     | 100.36              | 32.01                 | 2.65              | 36.08                | 200            | 25                | Average |
| 4804              | 44.74            | -29.26            | 74                    | 43.35               | 34.2                  | 3.78              | 36.59                | 109            | 147               | Peak    |

Note: Other harmonics are lower than background noise.

|                        |  |                            |          |
|------------------------|--|----------------------------|----------|
| <b>Test Mode :</b>     | Mode 1   | <b>Temperature :</b>       | 22~23°C  |
| <b>Test Channel :</b>  | 00   | <b>Relative Humidity :</b> | 42~43%   |
| <b>Test Engineer :</b> | Simon Lu   | <b>Polarization :</b>      | Vertical |
| <b>Remark :</b>        | 1. 2402 MHz is fundamental signal which can be ignored.<br>2. Average measurement was not performed if peak level went lower than the average limit. |                            |          |

| Frequency ( MHz ) | Level ( dBμV/m ) | Over Limit ( dB ) | Limit Line ( dBμV/m ) | Read Level ( dBμV ) | Antenna Factor ( dB ) | Cable Loss ( dB ) | Preamp Factor ( dB ) | Ant Pos ( cm ) | Table Pos ( deg ) | Remark  |
|-------------------|------------------|-------------------|-----------------------|---------------------|-----------------------|-------------------|----------------------|----------------|-------------------|---------|
| 2402              | 99.92            | -                 | -                     | 101.34              | 32.01                 | 2.65              | 36.08                | 100            | 53                | Peak    |
| 2402              | 99.12            | -                 | -                     | 100.54              | 32.01                 | 2.65              | 36.08                | 100            | 53                | Average |
| 4804              | 44.26            | -29.74            | 74                    | 42.87               | 34.2                  | 3.78              | 36.59                | 196            | 350               | Peak    |

Note: Other harmonics are lower than background noise.



|                        |  |                            |            |
|------------------------|--|----------------------------|------------|
| <b>Test Mode :</b>     | Mode 2   | <b>Temperature :</b>       | 22~23°C    |
| <b>Test Channel :</b>  | 19   | <b>Relative Humidity :</b> | 42~43%     |
| <b>Test Engineer :</b> | Simon Lu   | <b>Polarization :</b>      | Horizontal |
| <b>Remark :</b>        | 1. 2440 MHz is fundamental signal which can be ignored.<br>2. Average measurement was not performed if peak level went lower than the average limit. |                            |            |

| Frequency ( MHz ) | Level ( dBμV/m ) | Over Limit ( dB ) | Limit Line ( dBμV/m ) | Read Level ( dBμV ) | Antenna Factor ( dB ) | Cable Loss ( dB ) | Preamp Factor ( dB ) | Ant Pos ( cm ) | Table Pos ( deg ) | Remark  |
|-------------------|------------------|-------------------|-----------------------|---------------------|-----------------------|-------------------|----------------------|----------------|-------------------|---------|
| 2440              | 102.84           | -                 | -                     | 103.88              | 32.21                 | 2.66              | 35.91                | 103            | 23                | Peak    |
| 2440              | 102.08           | -                 | -                     | 103.12              | 32.21                 | 2.66              | 35.91                | 103            | 23                | Average |
| 4880              | 45.69            | -28.31            | 74                    | 44.55               | 34.2                  | 3.78              | 36.84                | 102            | 321               | Peak    |
| 7320              | 44.85            | -29.15            | 74                    | 43.3                | 35.73                 | 4.74              | 38.92                | 100            | 23                | Peak    |

**Note:** Other harmonics are lower than background noise.

|                        |  |                            |          |
|------------------------|--|----------------------------|----------|
| <b>Test Mode :</b>     | Mode 2   | <b>Temperature :</b>       | 22~23°C  |
| <b>Test Channel :</b>  | 19   | <b>Relative Humidity :</b> | 42~43%   |
| <b>Test Engineer :</b> | Simon Lu   | <b>Polarization :</b>      | Vertical |
| <b>Remark :</b>        | 1. 2440 MHz is fundamental signal which can be ignored.<br>2. Average measurement was not performed if peak level went lower than the average limit. |                            |          |

| Frequency ( MHz ) | Level ( dBμV/m ) | Over Limit ( dB ) | Limit Line ( dBμV/m ) | Read Level ( dBμV ) | Antenna Factor ( dB ) | Cable Loss ( dB ) | Preamp Factor ( dB ) | Ant Pos ( cm ) | Table Pos ( deg ) | Remark  |
|-------------------|------------------|-------------------|-----------------------|---------------------|-----------------------|-------------------|----------------------|----------------|-------------------|---------|
| 2440              | 100.16           | -                 | -                     | 101.2               | 32.21                 | 2.66              | 35.91                | 100            | 125               | Peak    |
| 2440              | 98.99            | -                 | -                     | 100.03              | 32.21                 | 2.66              | 35.91                | 100            | 125               | Average |
| 4880              | 44.02            | -29.98            | 74                    | 42.88               | 34.2                  | 3.78              | 36.84                | 125            | 348               | Peak    |
| 7320              | 46.51            | -27.49            | 74                    | 44.96               | 35.73                 | 4.74              | 38.92                | 124            | 201               | Peak    |

**Note:** Other harmonics are lower than background noise.



|                        |  |                            |            |
|------------------------|--|----------------------------|------------|
| <b>Test Mode :</b>     | Mode 3   | <b>Temperature :</b>       | 22~23°C    |
| <b>Test Channel :</b>  | 39   | <b>Relative Humidity :</b> | 42~43%     |
| <b>Test Engineer :</b> | Simon Lu   | <b>Polarization :</b>      | Horizontal |
| <b>Remark :</b>        | 1. 2480 MHz is fundamental signal which can be ignored.<br>2. Average measurement was not performed if peak level went lower than the average limit. |                            |            |

| Frequency<br>( MHz ) | Level<br>( dBμV/m ) | Over<br>Limit<br>( dB ) | Limit<br>Line<br>( dBμV/m ) | Read<br>Level<br>( dBμV ) | Antenna<br>Factor<br>( dB ) | Cable<br>Loss<br>( dB ) | Preamp<br>Factor<br>( dB ) | Ant<br>Pos<br>( cm ) | Table<br>Pos<br>( deg ) | Remark  |
|----------------------|---------------------|-------------------------|-----------------------------|---------------------------|-----------------------------|-------------------------|----------------------------|----------------------|-------------------------|---------|
| 30                   | 23.04               | -16.96                  | 40                          | 37.51                     | 18                          | 0.19                    | 32.66                      | 142                  | 200                     | Peak    |
| 72.68                | 18.57               | -21.43                  | 40                          | 45.25                     | 5.5                         | 0.47                    | 32.65                      | -                    | -                       | Peak    |
| 133.79               | 26.51               | -16.99                  | 43.5                        | 46.91                     | 11.52                       | 0.67                    | 32.59                      | -                    | -                       | Peak    |
| 224                  | 18.65               | -27.35                  | 46                          | 41.44                     | 8.9                         | 0.8                     | 32.49                      | -                    | -                       | Peak    |
| 394.72               | 17.75               | -28.25                  | 46                          | 33.4                      | 15.68                       | 0.96                    | 32.29                      | -                    | -                       | Peak    |
| 593.57               | 19.4                | -26.6                   | 46                          | 31.58                     | 18.62                       | 1.22                    | 32.02                      | -                    | -                       | Peak    |
| 2480                 | 100.13              | -                       | -                           | 100.91                    | 32.34                       | 2.67                    | 35.79                      | 100                  | 30                      | Peak    |
| 2480                 | 98.83               | -                       | -                           | 99.61                     | 32.34                       | 2.67                    | 35.79                      | 100                  | 30                      | Average |
| 4960                 | 43.96               | -30.04                  | 74                          | 43.13                     | 34.2                        | 3.78                    | 37.15                      | 100                  | 254                     | Peak    |
| 7440                 | 46.85               | -27.15                  | 74                          | 45.18                     | 35.78                       | 4.8                     | 38.91                      | 148                  | 325                     | Peak    |

**Note:** Other harmonics are lower than background noise.



|                        |  |                            |          |
|------------------------|--|----------------------------|----------|
| <b>Test Mode :</b>     | Mode 3   | <b>Temperature :</b>       | 22~23°C  |
| <b>Test Channel :</b>  | 39   | <b>Relative Humidity :</b> | 42~43%   |
| <b>Test Engineer :</b> | Simon Lu   | <b>Polarization :</b>      | Vertical |
| <b>Remark :</b>        | 1. 2480 MHz is fundamental signal which can be ignored.<br>2. Average measurement was not performed if peak level went lower than the average limit. |                            |          |

| Frequency<br>( MHz ) | Level<br>( dBμV/m ) | Over<br>Limit<br>( dB ) | Limit<br>Line<br>( dBμV/m ) | Read<br>Level<br>( dBμV ) | Antenna<br>Factor<br>( dB ) | Cable<br>Loss<br>( dB ) | Preamp<br>Factor<br>( dB ) | Ant<br>Pos<br>( cm ) | Table<br>Pos<br>( deg ) | Remark  |
|----------------------|---------------------|-------------------------|-----------------------------|---------------------------|-----------------------------|-------------------------|----------------------------|----------------------|-------------------------|---------|
| 30                   | 31.62               | -8.38                   | 40                          | 46.09                     | 18                          | 0.19                    | 32.66                      | 100                  | 56                      | Peak    |
| 45.52                | 29.61               | -10.39                  | 40                          | 52.31                     | 9.65                        | 0.31                    | 32.66                      | -                    | -                       | Peak    |
| 54.25                | 30.55               | -9.45                   | 40                          | 56.44                     | 6.4                         | 0.31                    | 32.6                       | -                    | -                       | Peak    |
| 132.82               | 18.34               | -25.16                  | 43.5                        | 38.67                     | 11.59                       | 0.67                    | 32.59                      | -                    | -                       | Peak    |
| 227.88               | 15.23               | -30.77                  | 46                          | 37.5                      | 9.42                        | 0.8                     | 32.49                      | -                    | -                       | Peak    |
| 566.41               | 20.14               | -25.86                  | 46                          | 32.54                     | 18.43                       | 1.25                    | 32.08                      | -                    | -                       | Peak    |
| 2480                 | 98.65               | -                       | -                           | 99.43                     | 32.34                       | 2.67                    | 35.79                      | 120                  | 53                      | Peak    |
| 2480                 | 98.13               | -                       | -                           | 98.91                     | 32.34                       | 2.67                    | 35.79                      | 120                  | 53                      | Average |
| 4960                 | 44.28               | -29.72                  | 74                          | 43.45                     | 34.2                        | 3.78                    | 37.15                      | 148                  | 97                      | Peak    |
| 7440                 | 47.59               | -26.41                  | 74                          | 45.92                     | 35.78                       | 4.8                     | 38.91                      | 198                  | 268                     | Peak    |

**Note:** Other harmonics are lower than background noise.



### 3.6 AC Conducted Emission Measurement

#### 3.6.1 Limit of AC Conducted Emission

For equipment that is designed to be connected to the public utility (AC) power line, the radio frequency voltage that is conducted back onto the AC power line on any frequency or frequencies within the band 150 kHz to 30 MHz shall not exceed the limits in the following table.

| Frequency of emission (MHz) | Conducted limit (dB $\mu$ V) |           |
|-----------------------------|------------------------------|-----------|
|                             | Quasi-peak                   | Average   |
| 0.15-0.5                    | 66 to 56*                    | 56 to 46* |
| 0.5-5                       | 56                           | 46        |
| 5-30                        | 60                           | 50        |

\*Decreases with the logarithm of the frequency.

#### 3.6.2 Measuring Instruments

The section 4.0 of List of Measuring Equipment of this test report is used for test.

#### 3.6.3 Test Procedures

1. The EUT was placed 0.4 meter from the conducting wall of the shielding room was kept at least 80 centimeters from any other grounded conducting surface.
2. Connect EUT to the power mains through a line impedance stabilization network (LISN).
3. All the support units are connecting to the other LISN.
4. The LISN provides 50 ohm coupling impedance for the measuring instrument.
5. The FCC states that a 50 ohm, 50 microhenry LISN should be used.
6. Both sides of AC line were checked for maximum conducted interference.
7. The frequency range from 150 kHz to 30 MHz was searched.
8. Set the test-receiver system to Peak Detect Function and specified bandwidth (IF Bandwidth = 9kHz) with Maximum Hold Mode. Then measurement is also conducted by Average Detector and Quasi-Peak Detector Function respectively.



### 3.6.4 Test Setup

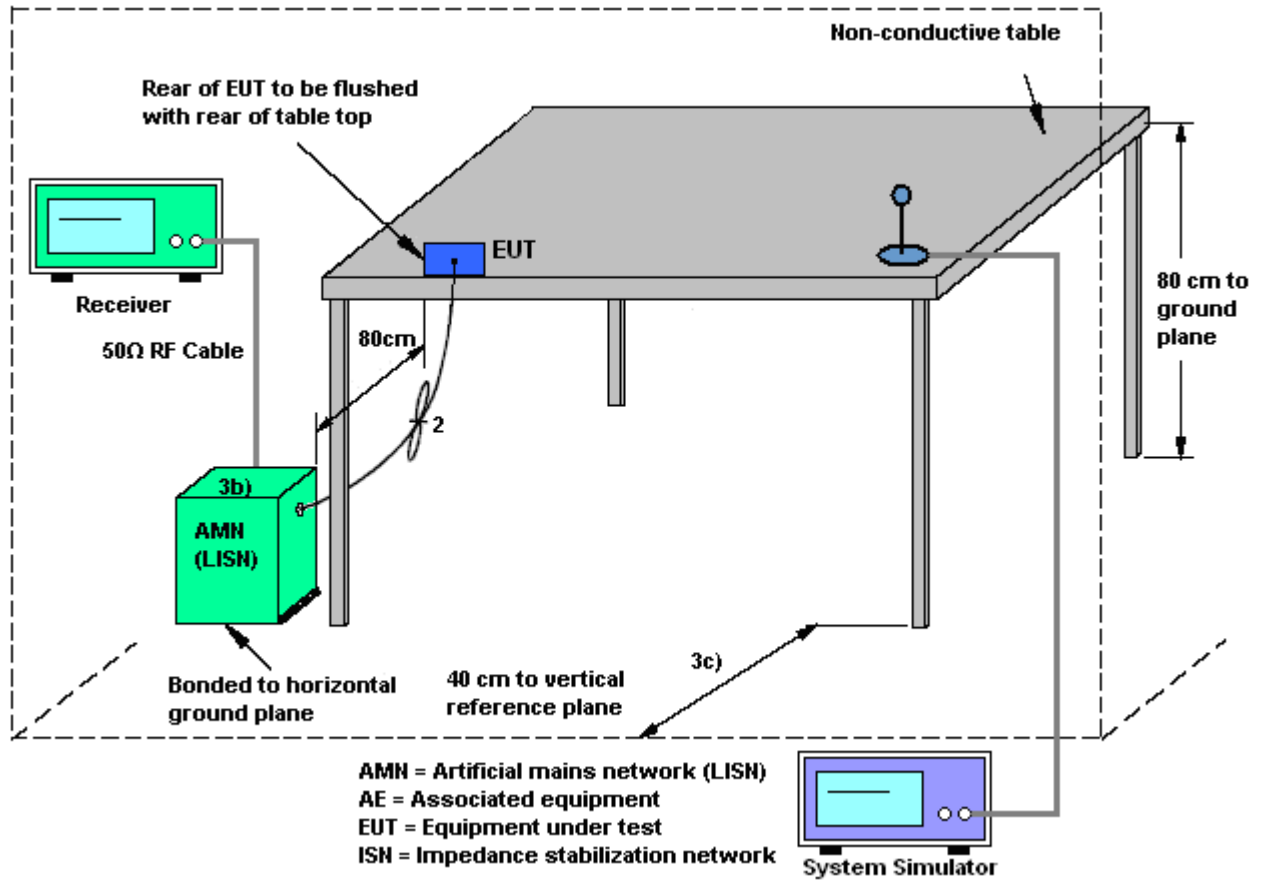



3.6.5 Test Result of AC Conducted Emission

|                 |   |                     |         |
|-----------------|---|---------------------|---------|
| Test Mode :     | Mode 1  | Temperature :       | 22~24°C |
| Test Engineer : | Eligah Wang   | Relative Humidity : | 46~49%  |
| Test Voltage :  | 120Vac / 60Hz   | Phase :             | Line    |
| Function Type : | GSM850 Idle + Bluetooth Link + WLAN Link + USB Cable1 (Charging from Adapter1) + Earphone1 for Sample 1 |                     |         |

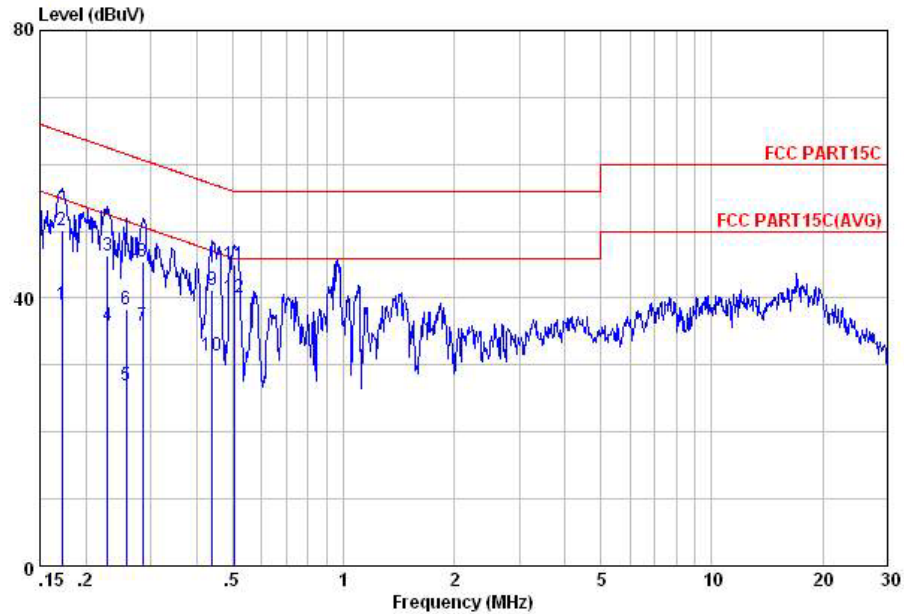

Site : C001-KS  
 Condition: FCC PART15C LISN-L20130306 LINE

mode : Mode 1

|    | Freq | Level | Over   | Limit | Read  | LISN   | Cable | Remark  |
|----|------|-------|--------|-------|-------|--------|-------|---------|
|    | MHz  | dBuV  | Limit  | Line  | Level | Factor | Loss  |         |
|    |      |       | dB     | dBuV  | dBuV  | dB     | dB    |         |
| 1  | 0.17 | 38.94 | -15.92 | 54.86 | 26.80 | 1.50   | 10.64 | Average |
| 2  | 0.17 | 50.04 | -14.82 | 64.86 | 37.90 | 1.50   | 10.64 | QP      |
| 3  | 0.23 | 46.37 | -16.11 | 62.48 | 34.90 | 0.93   | 10.54 | QP      |
| 4  | 0.23 | 35.77 | -16.71 | 52.48 | 24.30 | 0.93   | 10.54 | Average |
| 5  | 0.26 | 26.95 | -24.56 | 51.51 | 15.60 | 0.86   | 10.49 | Average |
| 6  | 0.26 | 38.25 | -23.26 | 61.51 | 26.90 | 0.86   | 10.49 | QP      |
| 7  | 0.28 | 35.78 | -14.90 | 50.68 | 24.60 | 0.76   | 10.42 | Average |
| 8  | 0.28 | 45.48 | -15.20 | 60.68 | 34.30 | 0.76   | 10.42 | QP      |
| 9  | 0.44 | 41.13 | -15.94 | 57.07 | 30.60 | 0.26   | 10.27 | QP      |
| 10 | 0.44 | 31.43 | -15.64 | 47.07 | 20.90 | 0.26   | 10.27 | Average |
| 11 | 0.50 | 45.06 | -10.94 | 56.00 | 34.60 | 0.20   | 10.26 | QP      |
| 12 | 0.50 | 40.06 | -5.94  | 46.00 | 29.60 | 0.20   | 10.26 | Average |



|                 |   |                     |         |
|-----------------|---|---------------------|---------|
| Test Mode :     | Mode 1  | Temperature :       | 22~24°C |
| Test Engineer : | Eligah Wang   | Relative Humidity : | 46~49%  |
| Test Voltage :  | 120Vac / 60Hz   | Phase :             | Neutral |
| Function Type : | GSM850 Idle + Bluetooth Link + WLAN Link + USB Cable1 (Charging from Adapter1) + Earphone1 for Sample 1 |                     |         |

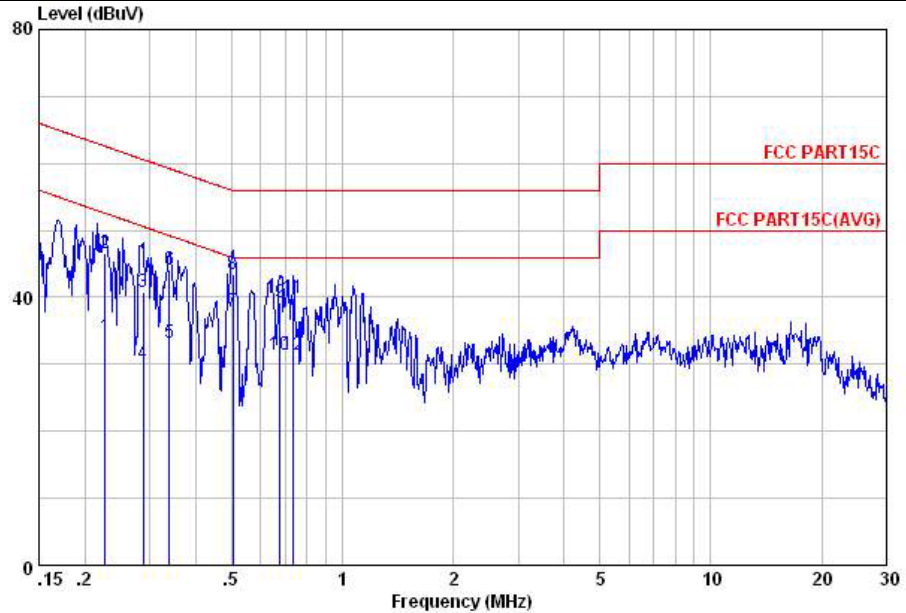

Site : C001-KS  
 Condition: FCC PART15C LISN-N20130306 NEUTRAL

mode : Mode 1

|    | Freq | Level | Over   | Limit | Read  | LISN | Cable | Remark  |
|----|------|-------|--------|-------|-------|------|-------|---------|
|    | MHz  | dBuV  | dB     | dBuV  | dBuV  | dB   | dB    |         |
| 1  | 0.23 | 34.09 | -18.48 | 52.57 | 22.60 | 0.95 | 10.54 | Average |
| 2  | 0.23 | 46.59 | -15.98 | 62.57 | 35.10 | 0.95 | 10.54 | QP      |
| 3  | 0.29 | 40.80 | -19.79 | 60.59 | 29.60 | 0.78 | 10.42 | QP      |
| 4  | 0.29 | 30.10 | -20.49 | 50.59 | 18.90 | 0.78 | 10.42 | Average |
| 5  | 0.34 | 33.17 | -16.05 | 49.22 | 22.30 | 0.54 | 10.33 | Average |
| 6  | 0.34 | 44.17 | -15.05 | 59.22 | 33.30 | 0.54 | 10.33 | QP      |
| 7  | 0.50 | 37.96 | -8.04  | 46.00 | 27.40 | 0.30 | 10.26 | Average |
| 8  | 0.50 | 43.46 | -12.54 | 56.00 | 32.90 | 0.30 | 10.26 | QP      |
| 9  | 0.68 | 39.33 | -16.67 | 56.00 | 28.90 | 0.21 | 10.22 | QP      |
| 10 | 0.68 | 31.33 | -14.67 | 46.00 | 20.90 | 0.21 | 10.22 | Average |
| 11 | 0.74 | 40.00 | -16.00 | 56.00 | 29.60 | 0.19 | 10.21 | QP      |
| 12 | 0.74 | 31.50 | -14.50 | 46.00 | 21.10 | 0.19 | 10.21 | Average |



## **3.7 Antenna Requirements**

### **3.7.1 Standard Applicable**

If directional gain of transmitting antennas is greater than 6dBi, the power shall be reduced by the same level in dB comparing to gain minus 6dBi. The use of a permanently attached antenna or of an antenna that uses a unique coupling to the intentional radiator shall be considered sufficient to comply with the FCC rule.

### **3.7.2 Antenna Anti-Replacement Construction**

An embedded-in antenna design is used.

### **3.7.3 Antenna Gain**

The antenna peak gain of EUT is less than 6 dBi. Therefore, it is not necessary to reduce maximum peak output power limit.



## 4 List of Measuring Equipment

| Instrument                        | Manufacturer | Model No. | Serial No.   | Characteristics         | Calibration Date | Test Date     | Due Date      | Remark                |
|-----------------------------------|--------------|-----------|--------------|-------------------------|------------------|---------------|---------------|-----------------------|
| Spectrum Analyzer                 | R&S          | FSP40     | 100319       | 9kHz~40GHz              | Dec. 28, 2013    | Aug. 16, 2014 | Dec. 27, 2014 | Conducted (TH01-KS)   |
| Pulse Power Sensor                | Anritsu      | MA2411B   | 0917070      | 30MHz~40GHz             | Feb. 27, 2014    | Aug. 16, 2014 | Feb. 26, 2015 | Conducted (TH01-KS)   |
| Power Meter                       | Anritsu      | ML2495A   | 1005002      | 50MHz Bandwidth         | Feb. 27, 2014    | Aug. 16, 2014 | Feb. 26, 2015 | Conducted (TH01-KS)   |
| EMI Test Receiver                 | R&S          | ESCI      | 100534       | 9kHz~3GHz               | Nov. 05, 2013    | Sep. 06, 2014 | Nov. 04, 2014 | Radiation (03CH01-KS) |
| Spectrum Analyzer                 | R&S          | FSP30     | 101399       | 9kHz~30GHz              | May 04, 2014     | Sep. 06, 2014 | May 03, 2015  | Radiation (03CH01-KS) |
| Loop Antenna                      | R&S          | HFH2-Z2   | 100321       | 9kHz~30MHz              | Oct. 09, 2013    | Sep. 06, 2014 | Oct. 08, 2014 | Radiation (03CH01-KS) |
| Bilog Antenna                     | SCHAFFNER    | CBL6112D  | 23182        | 25MHz~2GHz              | Jan. 08, 2014    | Sep. 06, 2014 | Jan. 07, 2015 | Radiation (03CH01-KS) |
| Double Ridge Horn Antenna         | ETS-Lindgren | 3117      | 75959        | 1GHz~18GHz              | Jan. 08, 2014    | Sep. 06, 2014 | Jan. 07, 2015 | Radiation (03CH01-KS) |
| Active Horn Antenna               | com-power    | AHA-118   | 701030       | 1GHz~18GHz              | Nov. 18, 2013    | Sep. 06, 2014 | Nov. 17, 2014 | Radiation (03CH01-KS) |
| SHF-EHF Horn                      | Schwarzbeck  | BBHA 9170 | BBHA170249   | 15GHz~40GHz             | Mar. 10, 2014    | Sep. 06, 2014 | Mar. 09, 2015 | Radiation (03CH01-KS) |
| Amplifier                         | com-power    | PA-103A   | 161073       | 1MHz~1GHz               | May 04, 2014     | Sep. 06, 2014 | May 03, 2015  | Radiation (03CH01-KS) |
| Amplifier                         | Agilent      | 8449B     | 3008A02371   | 1GHz~26.5GHz            | Dec. 10, 2013    | Sep. 06, 2014 | Dec. 09, 2014 | Radiation (03CH01-KS) |
| AC Power Source                   | Chroma       | 61601     | F104090004   | N/A                     | NCR              | Sep. 06, 2014 | NCR           | Radiation (03CH01-KS) |
| Turn Table                        | MF           | MF7802    | N/A          | 0~360 degree            | NCR              | Sep. 06, 2014 | NCR           | Radiation (03CH01-KS) |
| Antenna Mast                      | MF           | MF7802    | N/A          | 1 m~4 m                 | NCR              | Sep. 06, 2014 | NCR           | Radiation (03CH01-KS) |
| EMI Receiver                      | R&S          | ESCI7     | 100768       | 9kHz~7GHz;              | May 04, 2014     | Aug. 15, 2014 | May 03, 2015  | Conduction (CO01-KS)  |
| AC LISN                           | MessTec      | AN3016    | 060103       | 9kHz~30MHz              | Dec. 10, 2013    | Aug. 15, 2014 | Dec. 09, 2014 | Conduction (CO01-KS)  |
| AC LISN (for auxiliary equipment) | MessTec      | AN3016    | 060105       | 9kHz~30MHz              | Dec. 10, 2013    | Aug. 15, 2014 | Dec. 09, 2014 | Conduction (CO01-KS)  |
| AC Power Source                   | Chroma       | 61602     | ABP000000811 | AC 0V~300V, 45Hz~1000Hz | Nov. 12, 2013    | Aug. 15, 2014 | Nov. 11, 2014 | Conduction (CO01-KS)  |



## 5 Uncertainty of Evaluation

### Uncertainty of Conducted Emission Measurement (150 kHz ~ 30 MHz)

|   |     |
|---|-----|
| Measuring Uncertainty for a Level of Confidence of 95% ( $U = 2Uc(y)$ ) | 2.3 |
|---|-----|

### Uncertainty of Radiated Emission Measurement (30 MHz ~ 1000 MHz)

|   |     |
|---|-----|
| Measuring Uncertainty for a Level of Confidence of 95% ( $U = 2Uc(y)$ ) | 2.5 |
|---|-----|