

htc

User guide

# Contents

## Unboxing

HTC Desire 510	9
Back cover	10
micro SIM card	11
Storage card	12
Battery	13
Switching the power on or off	14
Want some quick guidance on your phone?	15

## Phone setup and transfer

Setting up your new phone for the first time	16
Restoring your backup from your online storage	17
Transferring content from an Android phone	18
Transferring content from an iPhone	18
Transferring contacts from your old phone through Bluetooth	19
Other ways of getting contacts and other content	19
Transferring photos, videos, and music between your phone and computer	20
Home screen	20
Using Quick Settings	20
Getting to know your settings	21
Updating your phone's software	22
Getting apps from Google Play	23
Downloading apps from the web	24
Uninstalling an app	25

## Your first week with your new phone

About your phone	26
Basics	27
HTC BlinkFeed	35
Notifications	38
Working with text	39
Battery	43
HTC Guide	47

## Personalizing

Making HTC Desire 510 truly yours	48
Ringtones, notification sounds, and alarms	48
Home wallpaper	49
Launch bar	49
Adding Home screen widgets	49

### 3 Contents

Adding Home screen shortcuts	50
Editing Home screen panels	51
Changing your main Home screen	52
Grouping apps on the widget panel and launch bar	53
Arranging apps	53
Lock screen	55

---

## Camera

Camera basics	56
Taking a photo	58
Tips for capturing better photos	58
Recording video	58
Taking continuous camera shots	59
Taking selfies	60
Improving portrait shots	60
Taking a panoramic photo	60
Using HDR	61
Recording videos in slow motion	61
Saving your settings as a camera mode	61

---

## Gallery

Viewing photos and videos in Gallery	63
Viewing photos and videos organized by time	63
Viewing photos and videos by album	63
Viewing photos by location	64
Editing your photos	66
Trimming a video	66
Saving a photo from a video	67
Creating a Zoe in Gallery	67

---

## Phone calls

Making a call with Smart dial	69
Dialing an extension number	69
Returning a missed call	70
Speed dial	70
Calling a number in a message, email, or calendar event	71
Making an emergency call	71
Receiving calls	71
What can I do during a call?	72
Setting up a conference call	73
Call History	73
Switching between silent, vibrate, and normal modes	74
Home dialing	74

---

## Messages

Sending a text message (SMS)	75
Sending a multimedia message (MMS)	75
Sending a group message	76
Resuming a draft message	76
Replying to a message	76
Saving a text message as a task	77

## 4 Contents

Forwarding a message	77
Moving messages to the secure box	77
Blocking unwanted messages	78
Copying a text message to the micro SIM card	79
Deleting messages and conversations	79

---

## Search and web browser

Getting instant information with Google Now	80
Searching HTC Desire 510 and the Web	82
Browsing the Web	83
Bookmarking a webpage	85
Using your browsing history	85
Clearing your browsing history	85

---

## Entertainment

HTC Music	87
YouTube	91
FM Radio	92
Wireless media	93

---

## Storage

Phone storage	94
Your files	96
Google Drive	97

---

## Sync, backup, and reset

Online sync	102
Backup	103
HTC Sync Manager	108
Reset	111

---

## People

Your contacts list	113
Setting up your profile	114
Adding a new contact	114
Editing a contact's information	115
Getting in touch with a contact	116
Importing or copying contacts	116
Merging contact information	117
Sending contact information	118
Contact groups	118
Private contacts	119

---

## Email

Gmail	121
Mail	123

---

## Calendar

---

Viewing the Calendar	128
Scheduling or editing an event	129
Choosing which calendars to show	129
Sharing an event	130
Accepting or declining a meeting invitation	130
Dismissing or snoozing event reminders	131

---

## Travel and maps

---

Location settings	132
Google Maps	132
HTC Car	134

---

## Other apps

---

Using the Clock	136
Checking Weather	137
Recording voice clips	137
Keeping track of your tasks	138
Kid Mode	139

---

## Internet connections

---

Turning the data connection on or off	140
Managing your data usage	140
Wi-Fi	142
Connecting to VPN	143
Using HTC Desire 510 as a Wi-Fi hotspot	145
Sharing your phone's Internet connection by USB tethering	146

---

## Wireless sharing

---

Bluetooth	147
HTC Mini+	149

---

## Settings and security

---

Airplane mode	151
Do not disturb mode	151
Scheduling when to turn data connection off	153
Automatic screen rotation	153
Setting when to turn off the screen	153
Screen brightness	153
Changing the display font	154
Touch sounds and vibration	154
Changing the display language	154
Accessibility settings	155
Turning Magnification gestures on or off	155
Installing a digital certificate	155
Disabling an app	156
Assigning a PIN to a micro SIM card	156
Lock screen notifications	156
Hiding the caller from the lock screen	157

6 Contents

Setting a screen lock	157
Setting up face unlock	157
Bypassing the lock screen	158
Navigating HTC Desire 510 with TalkBack	158

---

**Trademarks and copyrights**

---

---

**Index**

---

## Conventions used in this guide

In this user guide, we use the following symbols to indicate useful and important information:



This is a note. A note often gives additional information, such as what happens when you choose to do or not to do a certain action. A note also provides information that may only be applicable to some situations.



This is a tip. A tip gives you an alternative way to do a particular step or procedure, or lets you know of an option that you may find helpful.



This indicates important information that you need in order to accomplish a certain task or to get a feature to work properly.



This provides safety precaution information, that is, information that you need to be careful about to prevent potential problems.

### Important note on recoverable data

Files and other data that have been deleted, cleared, removed, or erased from your device may still be recoverable by third-party data recovery software. Even a factory reset may not permanently erase all data from your phone, including personal information.



# Unboxing

## HTC Desire 510

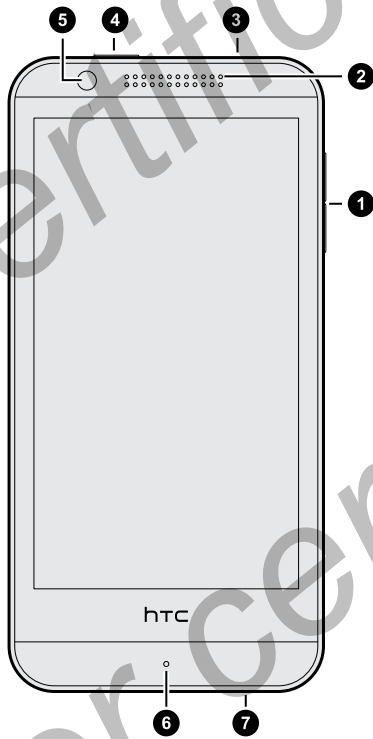

1. VOLUME buttons
2. Earpiece
3. 3.5mm headset jack
4. POWER
5. Front camera
6. Microphone
7. USB connector

 You need a 4G/LTE™ plan to use your operator's 4G/LTE network for voice calls and data services. Check with your operator for details.

## Back cover

### Removing the back cover

1. Securely hold HTC Desire 510 facing down.
2. With your thumb or finger, open the back cover from the small opening at the bottom of HTC Desire 510.

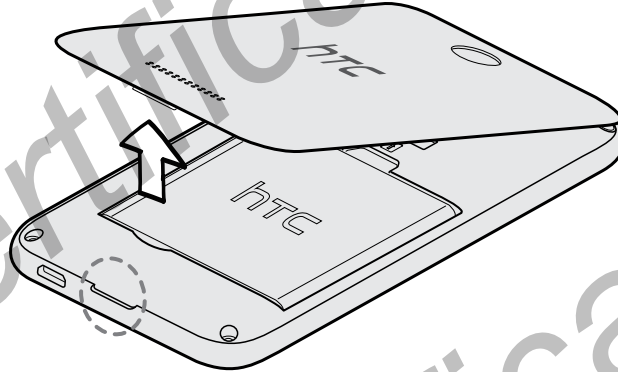

### Replacing the back cover

1. Align the back cover onto the top part of HTC Desire 510.
2. Press the sides and the bottom part of the back cover down to lock the cover into place.

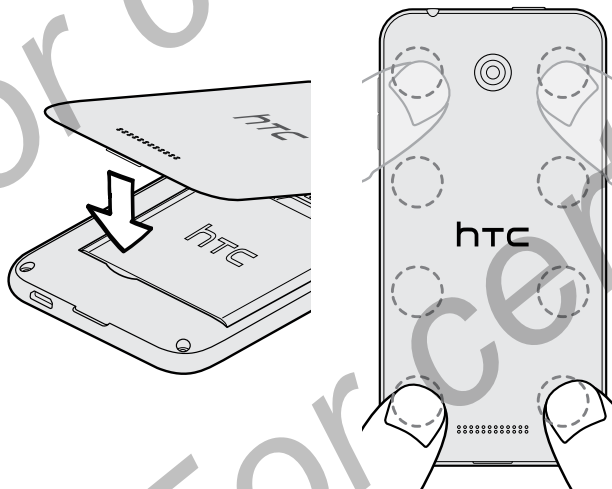

You will hear a click when the back cover is locked in place.

## micro SIM card

HTC Desire 510 uses a micro SIM card.



Use a standard micro SIM card only. Inserting a modified card or an empty card adapter may cause the card to not fit properly or damage the card slot.

### Inserting a micro SIM card

1. Take the back cover off.
2. Remove the battery.
3. Remove the placeholder card from the micro SIM card slot, if there's one pre-inserted.
4. With its gold contacts facing down and its cut-off corner facing in, insert the micro SIM all the way into the slot.

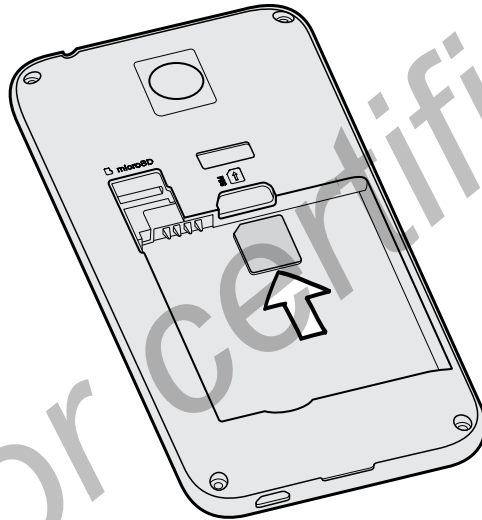

### Removing a micro SIM card



Make sure to switch off HTC Desire 510 before removing the card.

1. Take the back cover off.
2. Remove the battery.
3. Slide the card out from the card slot.

## Storage card

Use a storage card to store your photos, videos, and music. When you need to free up phone storage space, you can also move certain apps to the storage card, if the apps support this feature.



The storage card is optional and sold separately.



- Moving apps to the storage card doesn't back up the apps. If you do a factory reset, your phone loses the apps. You'll need to reinstall them.
- When you remove the storage card and insert it in another phone, the apps on the storage card won't be installed automatically to the other phone. You'll need to reinstall them.

---

### Inserting the storage card

---

1. Take the back cover off.
2. Make sure to remove the battery first before inserting the microSD™ card.
3. Insert the microSD card into the storage card slot with its gold contacts facing down and push it all the way in.

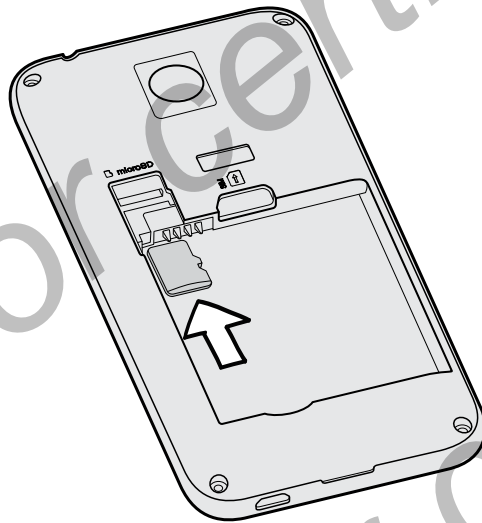

---

### Unmounting the storage card

---

When you need to remove the storage card while HTC Desire 510 is on, unmount the storage card first to prevent corrupting or damaging the files in the storage card.

1. Go to Settings, and then tap **Storage**.
2. Tap **Unmount SD card**.

---

### Removing the storage card

---

1. Take the back cover off.
2. Make sure to remove the battery first before removing the microSD card.
3. Slide the microSD card out from its slot.

## Battery

---

### Removing the battery

---

1. Take the back cover off.
2. With your thumb or finger, lift the battery from the battery compartment.

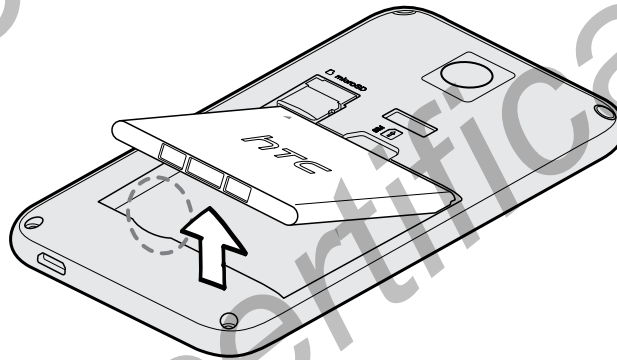

---

### Inserting the battery

---

 Please use only original batteries that came in the box or replacements that we recommend.

1. Take the back cover off.
2. Insert the battery (with its exposed copper contacts first) into the battery compartment.

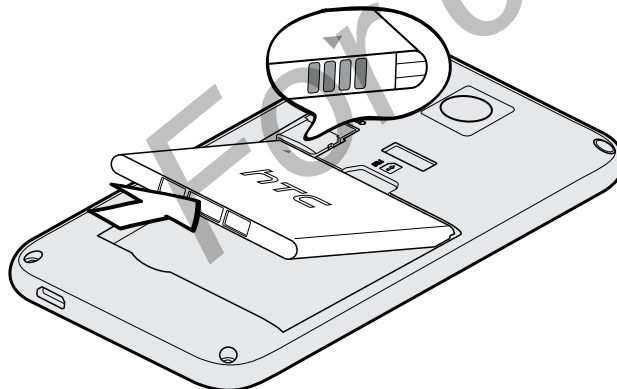

## Charging the battery

Before you turn on and start using HTC Desire 510, it is recommended that you charge the battery.



- Use only the adapter and the USB cable that came with HTC Desire 510 to charge the battery. When the battery power is too low, make sure to use the power adapter to charge, not the USB cable connection with your computer.
- Do not remove the battery from HTC Desire 510 while you are charging it using the power or car adapter.

1. Insert the small end of the USB cable into the USB connector.

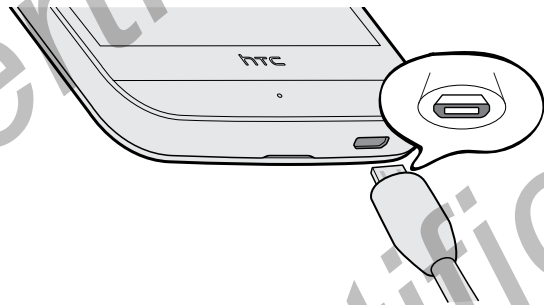

2. Insert the other end of the USB cable into the power adapter.
3. Plug in the power adapter to an electrical outlet to start charging the battery.



- As a safety precaution, the battery may stop charging to avoid overheating.
- When you're using the Internet and charging the battery, HTC Desire 510 may become warmer. This is normal.
- To conserve energy, unplug the power adapter from the electrical outlet after you finish charging.

## Switching the power on or off

### Switching the power on

Press the POWER button until HTC Desire 510 vibrates.



When you turn on HTC Desire 510 for the first time, you'll need to set it up.

---

## Switching the power off

---

1. If the display is off, press the POWER button to turn it back on. If you've set up a lock screen, you need to unlock it.
2. Press and hold the POWER button for a few seconds.
3. Tap **Power off** on the options menu.

## Want some quick guidance on your phone?

Check out the friendly walkthroughs and the FAQs in the Tips & Help app to learn how to use your phone.

- When you see a Tips & Help tile in HTC BlinkFeed™, just tap the tile to know more about the tip.
- To open Tips & Help from the Home screen, tap  > Tips & Help.

You can then browse by subject matter and topic. Or tap , and then enter what you want to search for.

# Phone setup and transfer

## Setting up your new phone for the first time

When you switch on your new phone for the first time, you'll be asked to set it up.



You can enable TalkBack to navigate by voice feedback before selecting the language. Press and hold two fingers on the screen until you hear a message saying that accessibility mode is enabled.

Walk through the on-device setup to choose your Internet connection, sign in to your accounts, and more.

There are different options you can choose to set up your new phone:

- If you don't plan to restore a previous backup from your online storage, you can use the HTC Get Started service to first personalize your new phone and set up your accounts from your computer.

On the Fast and easy setup screen, tap **I want to use Get Started**. Your phone will show you the URL of the HTC Get Started site and a pair code. On your computer's web browser, just go to the URL and enter the pair code to start your web setup. Save your setup to your HTC Account so you can download your personalized settings to your phone.

If you already finished the HTC Get Started setup before turning on your new phone, just download your web setup.

- If you have content from another phone that you want to transfer, whether it's from an Android™ or other phone, select **Get content from old phone**.
- If you have a previous phone backup that you want to restore from your online storage, select **Restore from HTC Backup**.

To make it easier for you to back up and restore content from HTC Desire 510 to another HTC phone in the future, select **Back up phone daily**.



Some features that need to connect to the Internet such as location-based services and auto-sync of your online accounts may incur extra data fees. To avoid incurring data fees, disable these features under Settings. For more information on location services, see [Turning location services on or off](#) on page 132.



## Restoring your backup from your online storage

If you used HTC Backup before, you can restore your backup to HTC Desire 510 when you turn the phone on for the first time or after a factory reset.

⚠ Depending on the amount of content, restoring your backup to your phone through your data connection may incur additional data costs and take a long time. Using a Wi-Fi® connection is recommended.

1. When you're asked whether you have a Google® Account, sign in to your account.
2. Use your mobile data or Wi-Fi connection to connect your phone to the Internet.
3. If you used your Google login credentials as your HTC Account and your backup is in Google Drive™, tap **Sign in with Google**.

If not, tap **Remind me later**, go to the Transfer or restore screen, and select **Restore from HTC Backup**.

4. Follow the onscreen instructions to restore your backup and to continue setting up your phone.
5. Slide open the Notifications panel to check if there's any notification to finish setting up your phone.

Free apps from Google Play™ will be restored in the background, and you can track the progress via a notification in the status bar. To restore paid apps, you need to download and install them from Google Play.

Your apps will appear on the Apps screen as they are installed. The Apps and Home screen shortcuts will be reorganized as in your backup after all of your apps have been installed. You may continue using HTC Desire 510 while apps are being restored.

## Transferring content from an Android phone

On your old Android phone, download the HTC Transfer Tool and use it to transfer your content to your new HTC phone. The types of locally stored content on your old phone that the tool can transfer include contacts, messages, calendar events, web bookmarks, music, photos, and videos. Some settings can also be transferred.

-  ■ You need Android version 2.2 or later to use the HTC Transfer Tool on your old phone.
- If your old phone has Android version 2.1 or an earlier version, you need to use Bluetooth® transfer. For details, see [Transferring contacts from your old phone through Bluetooth](#) on page 19.

1. If you're setting up your new HTC phone for the first time, select **Get content from old phone**.  
Or go to Settings, and then tap **Get content from another phone**.
2. Choose whether to transfer from an old HTC Android phone or other Android phone.
3. Tap **Full transfer**, and then tap **Next**.
4. Follow the steps shown on your new phone to download the HTC Transfer Tool from Google Play to your old phone, install it, and open the tool.
5. When you see a PIN on your old phone, make sure the same PIN also appears on your new phone before you continue.



If the PIN code doesn't appear, this may mean that your old phone is unable to connect to your new phone. If this happens, try another transfer method.

6. On your old phone, choose the types of content you want to transfer, and then tap **Start** or **Transfer**.
7. Wait for the transfer to finish.
8. Tap **Done** on both phones.

## Transferring content from an iPhone

If you have an iPhone, it's fast and easy to transfer your contacts, messages, and other content when you use HTC Sync Manager.

To find out how, see [Transferring iPhone content and apps to your HTC phone](#) on page 110.

If you only need to migrate your contacts, you can also use Bluetooth transfer. For details, see [Transferring contacts from your old phone through Bluetooth](#) on page 19.

## Transferring contacts from your old phone through Bluetooth

Use Bluetooth to transfer contacts from an iPhone, a phone that has Android version 2.1 (or earlier version), or other types of phones. Depending on the capabilities of your old phone, you may be able to transfer not only contacts but also other data such as calendar events and text messages to your new HTC phone.



Use HTC Sync Manager to transfer more types of content from an iPhone.

1. If you're setting up your new HTC phone for the first time, select **Get content from old phone**.  
Or go to Settings, and then tap **Get content from another phone**.
2. Choose whether to transfer from an Android phone, iPhone, or other phone types. If you chose to transfer from an Android phone, tap **Quick transfer**.
3. On your old phone, turn Bluetooth on.
4. Follow the onscreen instructions on your old and new phones to pair them and start the data transfer.

## Other ways of getting contacts and other content

There are different ways you can individually add contacts and other content to HTC Desire 510.

<b>Sync with your computer</b>	Use HTC Sync Manager to sync contacts, documents, playlists, and more between HTC Desire 510 and your computer running a Windows® or Mac OS operating system.  You can also use it to transfer your iTunes backup that contains contacts, messages, and other content from an iPhone from your computer to HTC Desire 510.
<b>Google Account</b>	Google contacts are imported to HTC Desire 510 after you sign in to your Google Account. You can also create more Google contacts right from HTC Desire 510.
<b>Social network accounts</b>	Log in to your favorite social networks to sync contact information from them.
<b>Microsoft® Exchange ActiveSync®</b>	HTC Desire 510 syncs your work contacts from the Microsoft Exchange ActiveSync Server in your workplace.
<b>Phone contacts</b>	You can create contacts locally on HTC Desire 510, if you don't prefer to store them on your online accounts.
<b>micro SIM card</b>	Copy all your micro SIM contacts to HTC Desire 510.

## Transferring photos, videos, and music between your phone and computer

There are two ways you can transfer your media from or to your computer.

- Connect HTC Desire 510 to your computer. Your computer will recognize it just like any removable USB drive, and you can copy your media between them.
- Download and use the HTC Sync Manager software on your computer. You can set it up to automatically get music, photos, and videos off HTC Desire 510 to your computer. You can also sync playlists from your computer to the phone.

If you have an iPhone, you can even connect it and transfer camera roll photos to your computer. Then reconnect HTC Desire 510 and copy them over.

## Home screen

After you've turned on and set up HTC Desire 510 for the first time, you'll see HTC BlinkFeed.

- Customize HTC BlinkFeed to show posts from your social networks, headlines from your favorite news media, and more. For details, see [Your dynamic Home screen](#) on page 35.
- Swipe left and you'll discover widget panels for adding your favorite widgets, apps, and more so they're just a tap away. If you need more room for your stuff, you can add more panels. For details, see [Personalizing](#) on page 48.
- You can change the apps on the launch bar at the bottom of the Home screen. See [Launch bar](#) on page 49.



While you're in another screen or app, press  to return to the last Home screen you visited.

## Using Quick Settings

In the Quick Settings panel, easily turn settings such as Wi-Fi and Bluetooth on or off.



1. With two fingers, swipe down from the status bar to open Quick Settings.
2. To turn a setting on or off, just tap its tile.
3. To change the options for a setting, press and hold its tile. Or tap **⋮**.



You can also tap  to switch to Quick Settings from the Notifications panel.

## Customizing Quick Settings

Aside from the default tiles, there are several other tiles available in Quick Settings.



1. With two fingers, swipe down from the status bar to open Quick Settings.
2. Tap  and do one of the following:
  - In the Quick Settings list, press and hold  next to the item you want to move and drag it to rearrange the list.
  - Under Hidden items, press and hold  and drag it up to make it available in Quick Settings.



There is a limit to the number of tiles that can be shown in Quick Settings. You may need to remove an existing item to make space for another one. To remove an item, drag it below Hidden items.

## Getting to know your settings

Want to change the ringtone, set up a Wi-Fi connection, or add your accounts? Do this and more in Settings.

1. Open Settings either from the Quick Settings panel or the Apps screen.
  - With two fingers, swipe down from the status bar to open Quick Settings, and then tap .
  - From the Home screen, tap  to switch to the Apps screen, and then tap **Settings**.
2. Here are some of the basic settings you can change:
  - Tap the **On/Off** switch next to an item such as Wi-Fi to turn it on or off. Tap the item itself to configure its settings.
  - Tap **Sound** to set a ringtone, choose a sound profile, and configure incoming call sound settings.
  - Tap **Personalize** to change the wallpaper, add apps and widgets to the Home screen, and more.
  - Tap **Accounts & sync** to add and sign in to your different accounts, such as email, social networks, and more.
  - Tap **Security** to help secure HTC Desire 510, for example with a screen lock.

## Updating your phone's software

HTC Desire 510 can check and notify you if there's a new update available. You can also choose to automatically download updates or manually check if there's an available update.

---

### Checking your system software version

---

Before installing a system software update, you can check first what Android and HTC Sense™ versions you have on your phone.

1. Go to Settings, and then tap **About**.
2. Tap **Software information**.

---

### Enabling automatic updates

---

You can choose to automatically download and install software updates for HTC or mobile operator apps.

1. Go to Settings, and then tap **About**.
2. Tap **Software updates**.
3. To save on data usage, you can choose to update through Wi-Fi only.
4. Choose whether to auto-download system updates, app updates, or both.

App updates are installed automatically. You'll still need to confirm when to install system software updates.

---

### Installing a software update

---

When Internet connection is on and there's a new software update available, the update notification icon  appears in the status bar.

1. Slide the Notifications panel open, and then tap the system update notification.
2. If you don't want to download the update using your data connection, select **Update over Wi-Fi only**.
3. Tap **Download**.
4. When download is complete, select **Install now**, and then tap **OK**.

After updating, HTC Desire 510 will restart.

---

## Installing an application update

---

When Internet connection is on and there's an available update for your HTC or mobile operator apps, the update notification icon  appears in the status bar.

1. Slide the Notifications panel open, and then tap the update notification.  
The Updates screen opens with the list of application updates to be installed.
2. Tap an item to view its details, and then tap .
3. When you're done reviewing the updates, tap **Install**. You'll be asked to restart HTC Desire 510 if needed.

---

## Checking for updates manually

---

1. Go to Settings, and then tap **About**.
2. Tap **Software updates**. HTC Desire 510 checks if updates are available.



If you don't have Internet connection, you'll be prompted to turn on mobile data or connect to a Wi-Fi network. Once connected, tap **Check now** to check for updates.

## Getting apps from Google Play

Google Play is the place to go to find new apps for HTC Desire 510. Choose from a wide variety of free and paid apps ranging from productivity apps, entertainment, to games.



- A Google Wallet™ payment service is required to purchase a paid app. You will be asked to confirm method of payment when you purchase an app.
- The name of the Play Store app may differ depending on your region.
- The ability to purchase apps varies by region.

---

## Finding and installing an app

---

When you install apps and use them on HTC Desire 510, they may require access to your personal information or access to certain functions or settings. Download and install only apps that you trust.



Be cautious when downloading apps that have access to functions or a significant amount of your data on HTC Desire 510. You're responsible for the results of using downloaded apps.

1. Open the Play Store app.
2. Browse or search for an app.
3. When you find the app that you like, tap it and read its description and user reviews.

4. To download or purchase the app, tap **Install** (for free apps) or the price button (for paid apps).
5. Tap **Accept**.



Apps sometimes get updated with improvements or bug fixes. To automatically download updates, after installing the app, tap **⋮** > **Auto-update**.

To open the app, go to the Apps screen and tap the app.

### Restoring apps from Google Play

Upgraded to a new phone, replaced a lost one, or performed a factory reset? Restore apps that you previously downloaded.

1. Open the Play Store app.
2. Tap **≡** to open the slideout menu.
3. Tap **My apps**, swipe to the All tab, and then tap the app you want to restore.
4. Install the app.

For more details, refer to the Google Play help.

### Downloading apps from the web

You can download apps directly from websites.



- Apps downloaded from websites can be from unknown sources. To help protect HTC Desire 510 and your personal data, we strongly recommend that you only download from websites you trust.
- Before you can install the downloaded app, make sure that you've set HTC Desire 510 to allow installation of third-party apps in **Settings > Security > Unknown sources**.

1. Open the browser, and then go to the website where you can download the app you want.
2. Follow the website's download instructions for the app.



After installing the app, make sure to go back to **Settings > Security** and clear the **Unknown sources** option.



## Uninstalling an app

If you no longer need an app that you've downloaded and installed, you can uninstall it.



Most of the preloaded apps cannot be uninstalled.

From the Apps screen, press and hold the app you want to remove, and then drag it to Uninstall.



If you purchased an app in Play Store, you can uninstall it for a refund within a limited time. To know more about the refund policy for paid apps, refer to the Google Play help.

# Your first week with your new phone

## About your phone

---

### Features you'll enjoy on HTC Desire 510

---

HTC Desire 510 gives you options for quick and easy setup. Transferring your old phone's content such as your contacts, messages, and media can be done right from HTC Desire 510.

Also, enjoy taking shots with the camera, checking personalized content with HTC BlinkFeed, and more.

### Easy phone setup and transfer

- With our HTC Get Started service, you can set up and personalize HTC Desire 510 from your computer, and just download your settings to HTC Desire 510. See [Setting up your new phone for the first time](#) on page 16.
- Easily transfer your contacts, messages, music, photos, videos, and more from an Android phone to HTC Desire 510. See [Transferring content from an Android phone](#) on page 18.

By using [HTC Sync Manager](#), you can even migrate content from an iPhone. See [Transferring iPhone content and apps to your HTC phone](#) on page 110.

- Back up HTC Desire 510 to the cloud so it'll be a lot easier to restore your content to a new phone next time.

### Dynamic Home screen

With [HTC BlinkFeed](#), personalize your Home screen with the information and updates that matter most to you. See a variety of content such as feeds about news and your interests, social network updates, HTC Desire 510 tips, and more. The content refreshes periodically when you're connected to the Internet. See [Your dynamic Home screen](#) on page 35.

### New ways to share memories

Show off the excitement of your event. A [Zoe](#) is automatically created from selected highlights of an event or album with background music and special effects. See [Creating a Zoe in Gallery](#) on page 67.

## Outstanding camera features

- Choose from a variety of pre-defined camera modes, or create your own camera profiles. See [Choosing a capture mode](#) on page 56.
- With **VideoPic**, you can snap a picture while you're shooting video. See [Taking a photo while recording a video — VideoPic](#) on page 59.
- Switch to **Sweep panorama** and pan the camera to capture a wide-angle view of the scenery. See [Taking a panoramic photo](#) on page 60.
- Use **Continuous shooting** mode to capture consecutive shots of a subject in motion.
- By just tapping the shutter button, take multiple shots of your subject at different exposures and combine them into a nice, evenly exposed photo. See [Using HDR](#) on page 61.

## Immerse in music

Watch mesmerizing visualizations as you play songs in HTC Music. And if lyrics are available, they'll show onscreen. See [Viewing song lyrics](#) on page 90.

## Google Drive integration

HTC Desire 510 features an additional 50GB of Google Drive storage free for 2 years. See [Activating your free Google Drive storage](#) on page 98.



## Basics

---

### Onscreen navigation buttons

---

HTC Desire 510 has onscreen navigation buttons at the bottom of the screen which rotate when you change the orientation.

	Goes to the previous screen.
	Goes to the home screen.
	Shows thumbnails of the most recently used apps.

Swipe up from any of the navigation buttons to access Google search.

---

## Sleep mode

---

Sleep mode saves battery power by putting HTC Desire 510 into a low power state while the display is off. It also stops accidental button presses when HTC Desire 510 is in your bag.

### Switching to Sleep mode

To turn off the display and switch to Sleep mode, you briefly press the POWER button.

HTC Desire 510 also automatically goes into Sleep mode when it's left idle for a while. You can change the time before HTC Desire 510 sleeps by setting the screen timeout. For details, see [Setting when to turn off the screen](#) on page 153.

### Waking up from Sleep mode

Press the POWER button.

---

## Unlocking the screen

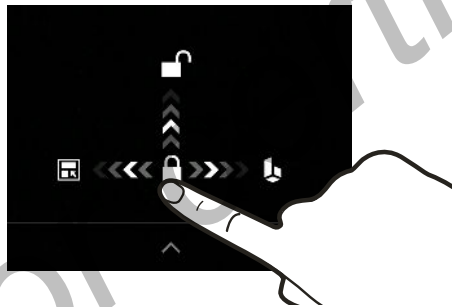

---

- Swipe up to unlock the screen, swipe right to go directly to HTC BlinkFeed, or swipe left to go to the Home widget panel.
- You can also press and hold the lock icon, and then drag it up, right, or left.



If you've set up a screen lock, you'll be asked to provide your credentials before HTC Desire 510 unlocks.



If you've set an event reminder or an alarm, you can snooze or dismiss the event or alarm right from the lock screen. Just drag  or  up.

## Motion gestures

Use motion gestures to mute HTC Desire 510, lower the ring volume, and more.

### Flip to mute



If your phone is facing up when a call comes in, turn the phone over to mute it.

If you go to Settings and then tap **Sound > Flip to mute**, you can set your phone to:

<b>Mute once</b>	Mute only once after flipping the phone. While the phone is still facing down, it will ring again when there are other incoming calls.
<b>Mute always</b>	After flipping the phone to mute a call, keep it always muted while it's still facing down when there are other incoming calls.

### Pick up to lower volume

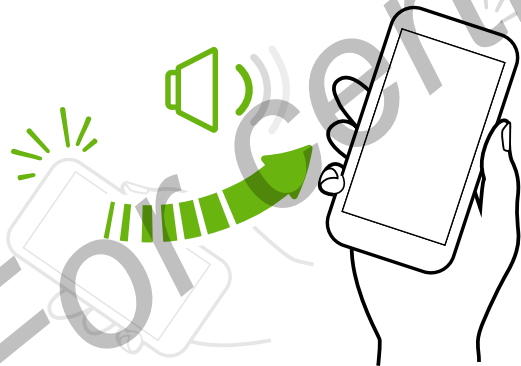

In a business meeting or restaurant, pick HTC Desire 510 up when a call comes in to lower the ring volume automatically.

You can turn this feature on or off. Go to Settings, tap **Sound**, and then select or clear **Quiet ring on pickup**.

### Increase ring volume automatically while phone is in your pocket or bag



Pocket mode makes HTC Desire 510 recognize when your phone is in your bag or pocket and raise the ring volume so that you can hear it in noisy environments.

You can turn this feature on or off. Go to Settings, tap **Sound**, and then select or clear **Pocket mode**.

## Rotate HTC Desire 510 for a better view

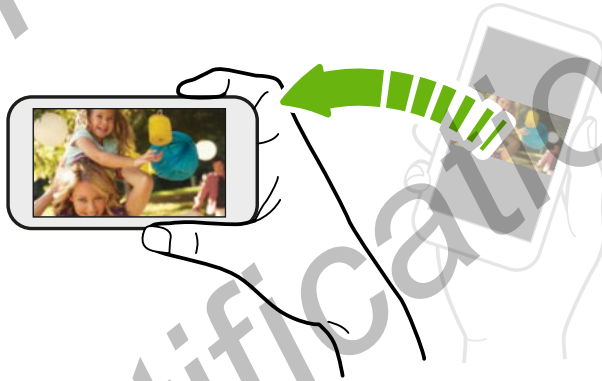

For many screens, you can automatically change the screen orientation from portrait to landscape by turning HTC Desire 510 sideways.

When entering text, you can turn HTC Desire 510 sideways to bring up a bigger keyboard.

---

## Touch gestures

---

Use touch gestures to get around the Home screen, open apps, scroll through lists, and more.

### Tap

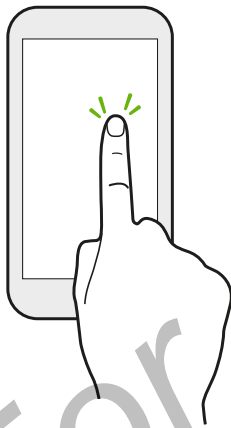

- Tap the screen with your finger when you want to select onscreen items such as application and settings icons, or press onscreen buttons.
- After you've scrolled down a long list or screen (in apps such as Mail and People), tap the status bar to jump straight to the top of your screen.

### Press and hold



To open the available options for an item (for example, a contact or link in a webpage), just press and hold the item.

### Swipe or slide



Quickly swipe your finger horizontally across the screen to go to other Home screen panels. Swipe vertically to scroll through a list, document, and more.

### Drag

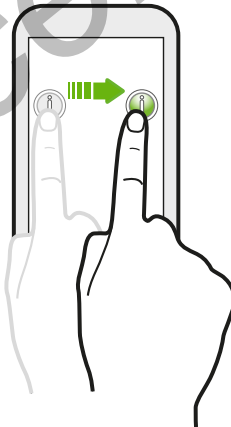

Press and hold your finger with some pressure before you start to drag. While dragging, don't release your finger until you have reached the target position.

### Flick

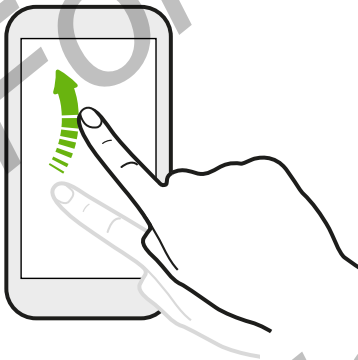

Flicking the screen is similar to swiping, except that you need to swipe your finger in light, quicker strokes, such as when moving right and left on the Home screen, or flicking through a contacts or message list.

### Press and flick



On the Home screen, you can easily move a widget or icon from one screen to another.

Press and hold the widget or icon with one finger, and flick the screen to the new location with another finger.

### Slide with two fingers



In some apps, like Gallery, Messages, Mail, or the web browser, slide two fingers apart to zoom in when viewing a picture or text.



Slide two fingers together to zoom out of the picture or text.



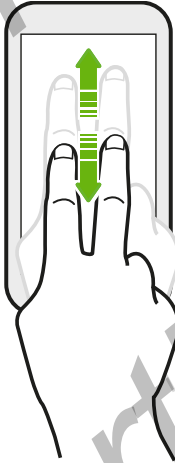

## Two-finger swipe



Swipe down from the status bar using two fingers to access Quick Settings.

## Opening an app

- Tap an app on the launch bar at the bottom of the Home screen.
- Tap  to go to the Apps screen, and then tap the app you want to use.
- On the Apps screen, tap , and then enter the name of the app you're looking for.

## Opening an app or folder from the lock screen

On the lock screen, drag an app or folder icon up to unlock the screen and directly go to the app or folder.





The shortcuts on the lock screen are the same ones on your Home screen's launch bar. To change the lock screen shortcuts, replace the apps or folders on the launch bar.

If you've set up another security layer like a screen lock pattern or PIN, you'll be asked to provide your credentials first before HTC Desire 510 opens the app or folder.

## Sharing content

Have something to share, such as a photo or video?

- In an app, just tap the share icon:  or .
- If you don't see the icon, tap  > Share.

## Switching between recently opened apps

When you're multitasking and using different apps on HTC Desire 510, you can easily switch between the apps you've recently opened.

Press  to see recently-opened apps.

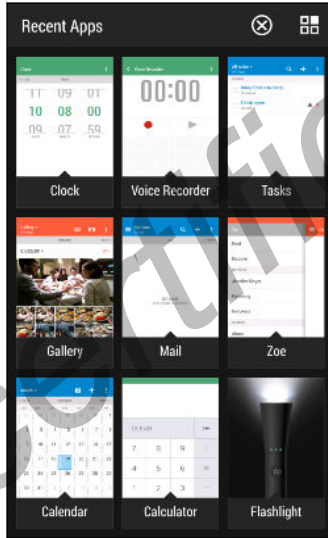

- To switch back to an app, just tap it.
- To remove an app from the list, drag it up.
- To clear the recent apps list, tap .



To see a list of apps that are running, tap .

## Refreshing content

In some apps, you can easily refresh content that's synced or downloaded from the Web with a simple finger gesture.

1. While viewing content such as weather or Mail inbox, scroll to the top of the screen.
2. Pull down with your finger, and then release to refresh.



## Capturing your phone's screen

Want to show off your high game score or write a blog post about HTC Desire 510 features? It's easy to take a picture of the screen and share it from Gallery.

Press and hold POWER and VOLUME DOWN at the same time.

The image is saved in the Screenshots album in Gallery.





You can also share the image when you see  in the status bar. Open the Notifications panel and tap  under the screenshot notification. If you don't see , slide two fingers apart on the screenshot notification.

## HTC BlinkFeed

### Your dynamic Home screen

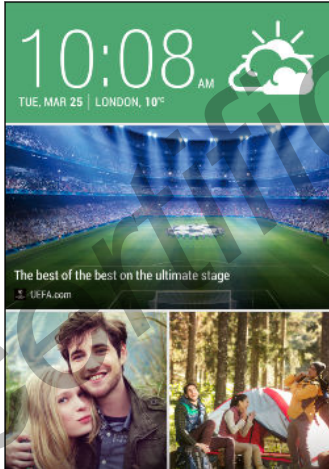
Get the latest about your interests or stay in touch with friends right on HTC BlinkFeed. Set up which social networks, news sources, and more will appear.



- Swipe up or down to browse stories on HTC BlinkFeed.
- Tap a tile to view the content or to comment on a post or status update.
- While viewing a news article, swipe left or right to see more stories.
- While in HTC BlinkFeed, you can press  or  or tap the status bar to scroll to the top.
- Scroll to the top and pull down on the screen to manually refresh the stream.
- Swipe right on HTC BlinkFeed to open the slideout menu where you can choose the type of feeds or add your custom topics to display.



You'll see the clock widget on HTC BlinkFeed if you've set HTC BlinkFeed as the main Home screen.

### Turning HTC BlinkFeed on or off

1. On HTC BlinkFeed, slide two fingers together, and then tap .
2. While HTC BlinkFeed is selected, tap **Remove**.
3. To add it back, swipe right, and then tap the **+** button that has the word **BlinkFeed**.

### Ways of adding content on HTC BlinkFeed

Personalize HTC BlinkFeed to show articles and status updates from your favorite news sources, categories, editions, and apps.

#### Selecting feeds

Discover stories and articles on HTC BlinkFeed based on your interests, favorite categories, and popular news channels or websites.

1. On HTC BlinkFeed, swipe right to open the slideout menu.
2. Tap  > **Add content**.

3. Choose a category.

Or, if it's your first time to add content on HTC BlinkFeed, tap the tile that says **Get automatic recommendations from BlinkFeed**. Sign in to get recommendations.

4. Select one or more feed sources.

You can tap a name first to check out a particular feed, and then tap  to add it to HTC BlinkFeed.

### Showing content from your apps and social networks

See your friends' posts in social networks or show content from your HTC apps right on HTC BlinkFeed.



You need to sign in to your social networks to see their feeds on HTC BlinkFeed.

1. On HTC BlinkFeed, swipe right to open the slideout menu.
2. Tap  > **Services & Apps**, and then select the apps and social networks you like.



### Searching and adding a topic of interest

Looking for a more specific topic? Search for and select topics of interest to display them on HTC BlinkFeed.

1. On HTC BlinkFeed, swipe right to open the slideout menu.
2. Tap **Search for content**, and then enter the topic you're looking for.
3. Tap a result, and then tap  to add it under Custom topics.

### Subscribing to multiple regional editions

Want to keep up to date on current events in more than one region? You can show one or more editions of your choice on HTC BlinkFeed.

1. On HTC BlinkFeed, swipe right to open the slideout menu.
2. Tap  > **Add content**.
3. Tap , and then select a locale or region.
4. Select the feed sources to add.

### Subscribing to an RSS feed

Don't want to miss out on news and updates from your favorite blog or website? Add custom RSS feeds on HTC BlinkFeed.

1. Open the Internet app.
2. Go to the RSS feed URL of the blog or website you want to subscribe to.
3. Tap  to add it to HTC BlinkFeed.

---

## Customizing the Highlights feed

---

Go to the Highlights feed to see a mix of top trending articles and status updates from the feed sources you added. You can also set the Highlights feed to only show items from your favorite news sources, categories, and apps.



You cannot add custom topics and RSS to the Highlights feed.

1. On HTC BlinkFeed, swipe right to open the slideout menu.
2. Tap > **Settings** > **Choose Highlights topics**.
3. Select the feed sources you want to appear in Highlights.

---

## Saving articles for later

---

Don't have time to read that potentially interesting article? You can bookmark articles to your reading list.

Do one of the following:

- While viewing an article, tap .
- On HTC BlinkFeed, press and hold the tile of the article you want to bookmark. Then tap **Read later**.

You'll find the reading list in the slideout menu.

---

## Posting to your social networks

---

You can easily post a status update from HTC BlinkFeed.

1. On HTC BlinkFeed, swipe right to open the slideout menu.
2. Tap > **Compose**, and then choose a social network.
3. Compose your status update and post it on your social network.

---

## Removing content from HTC BlinkFeed

---

Whether it's a tile or an entire feed, you can remove content you don't want to see on HTC BlinkFeed.

- To remove a tile, press and hold the tile you want to remove, and then tap **Remove**.
- To remove a feed source, in the slideout menu, tap > **Remove content**, select one or more items, and then tap **Remove**.

To unsubscribe to a localized edition, tap on the Remove content screen. Tap **Remove editions**, select one or more items, and then tap **Remove**.

## Notifications

### Notifications panel

Notification icons inform you of new messages, calendar events, alarms, and activities in progress such as files downloading.



When you see notification icons, open the Notifications panel to check out details of the notifications that you've received.

1. To open the Notifications panel, slide down from the top of the screen. If you have several notifications, scroll down the screen to see them all.
2. To quickly access the Notifications panel from Quick Settings, tap .

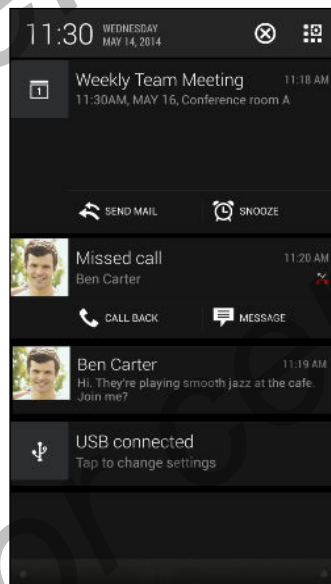

- To see more information, such as email previews and calendar events, slide two fingers apart to expand a notification. To collapse it, slide two fingers together.
- Some notifications allow you to take immediate action. For example, tap a missed call notification to return the call or reply with a text message.
- Tap the notification icon on the left to open the corresponding app.
- To dismiss just one notification in the list, drag it left or right. To dismiss all notifications and close the Notifications panel, tap .

## Working with text

### Selecting, copying, and pasting text

In HTC apps such as Internet and Mail, you can select and copy text, and then paste or share it.

1. Press and hold on a word.
2. Drag the start and end anchors to highlight the surrounding text you want to select.

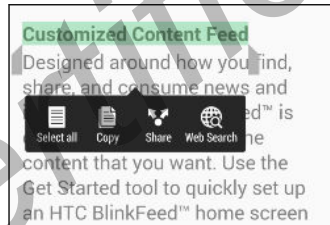

You can use the magnifier to zoom in while selecting your text. To turn on the magnifier, go to **Settings > Accessibility**, and then select the **Show magnifier** option. You'll see the magnifier when you press and hold one of the text selection anchors.

3. After you have selected the text you want to copy, tap **Copy**.

The selected text is then copied to the clipboard.

4. In a text entry field (for example while composing an email), press and hold at the point where you want to paste the text.
5. Tap **Paste**.



To copy the address of a linked webpage in the Internet app, press and hold the link, and then tap **Copy link URL**.

### Sharing text

1. After you have selected the text you want to share, tap **Share**.
2. Choose where to paste and share the selected text, such as in an email message or social network status update.

### The HTC Sense keyboard

Typing is fast and accurate with the HTC Sense keyboard.

- Word prediction also saves typing time. As you type, you'll see word suggestions that you can choose from. You can even add words, phrases, and shortcuts to the word prediction dictionary. See [Entering text with word prediction](#) on page 41.
- You can type words by just speaking. See [Entering text by speaking](#) on page 43.

- Turn on the Trace keyboard so you can type words by just sliding your finger from one letter to another. See [Using the Trace keyboard](#) on page 42.
- Just swipe right to access the numeric and symbol keyboard. Or swipe left to switch between languages.
- The keys have secondary numbers, punctuation symbols, or other characters that you can insert without having to switch to the numeric and symbol keyboard.

For example, just press and hold a key on the first row to insert a number.

- Choose from a wide selection of emoji.
- Show or hide navigational arrow keys on the keyboard. If you enable the arrow keys in Settings, they'll only appear on the portrait keyboard.



---

### Entering text

---

The onscreen keyboard becomes available when you tap a text field in an app. Enter letters and numbers, change the keyboard layout or language, and more.

Tap the keys on the onscreen keyboard to enter letters and numbers, as well as punctuation marks and symbols.

- Tap  to enter an uppercase letter. Tap twice to turn on caps lock.
- Press and hold keys with gray characters at the top to enter numbers, symbols, or accented letters. Some keys have multiple characters or accents associated with them.
- Swipe right to show number and symbol keys. To return to the main keyboard, swipe left.
- Press  to close the onscreen keyboard.



To open the keyboard settings, press and hold the comma key if you see  above the key. Or go to **Settings > Language & keyboard > HTC Sense Input**.

### Selecting a keyboard layout

Choose a keyboard layout that suits your typing style.

1. Go to Settings, and then tap **Language & keyboard > HTC Sense Input**.
2. Tap **Keyboard selection > Keyboard types**.
3. Select the keyboard layout that you want to use.

### Choosing and switching between keyboard languages

If multiple keyboard languages are available on HTC Desire 510, you can choose which languages to enable in the onscreen keyboard.

1. Go to Settings, and then tap **Language & keyboard > HTC Sense Input**.
2. Tap **Keyboard selection**, and then choose the languages you want.

To change the keyboard language, do any of the following:



- Swipe left on the onscreen keyboard (not available if you're using trace keyboard).
- Tap the language key, for example, **EN**, until you see the keyboard language you want to use.
- Press and hold the language key, and then drag your finger to the keyboard language you want to use.

### Entering text with word prediction

Ever started typing something you weren't sure how to spell? With word prediction, you'll see suggested words displayed just above the keyboard.



Word prediction and next word prediction are enabled by default.

To enter text in word prediction mode, do any of the following:

- Tap the space bar to insert a highlighted word in the suggestion list.
- Tap a word from the suggestion list.
- Tap the arrow next to the suggestion list to see more choices.



If you've accidentally chosen a wrong word from the suggestion list, you can always go back and change it by tapping the word and selecting another suggestion.

### Setting a second language for word prediction

You can set the word prediction to be bilingual. As you type, you'll get word suggestions in the languages that you've selected.



Bilingual prediction is available only when you're using a Latin-based keyboard.

1. Go to Settings, and then tap **Language & keyboard** > **HTC Sense Input**.
2. Tap **Keyboard selection** > **Bilingual prediction**, and then choose the language you want.

### Adding words and phrases to the word prediction dictionary

Add frequently-used names, acronyms, and even phrases to the word prediction dictionary to easily find them in the suggestion list.

Type even faster when you create text shortcuts to words and phrases. Instead of typing "Talk to you later", save a few keystrokes by adding the ttyl shortcut. In your message or email, just type "ttyl", and then tap the spacebar to enter the complete phrase.

1. Go to Settings, and then tap **Language & keyboard** > **HTC Sense Input**.
2. Tap **Personal dictionary** > **+**.
3. Enter a word or phrase, and then enter its text shortcut. Be sure to remember this shortcut, including the uppercase and lowercase letters you've typed.
4. Tap **OK**.



While you're entering text using the Standard keyboard layout, tapping a suggested word that's not in the dictionary (usually the first word shown in the suggestion list) automatically stores it.

### Editing or deleting words and phrases in the word prediction dictionary

1. Go to Settings, and then tap **Language & keyboard** > **HTC Sense Input**.
2. Tap **Personal dictionary**.
  - To edit a word, phrase, or shortcut, tap the item in the list.
  - To delete items from the dictionary, tap **⋮** > **Delete**. Select the words you want to remove, and then tap **Delete**.

### Using the Trace keyboard

Instead of tapping the keys on the onscreen keyboard, you can "trace" to type words.



You need to turn on the Trace keyboard in **Settings** > **Language & keyboard** > **HTC Sense Input**.

1. Slide your finger from one letter to the next to enter a word.
2. Lift your finger when the word is completed.
3. If you want to continue entering text, slide your finger over the letters again to enter the next word.



If the word that appears after you traced isn't the one you want, you can:

- Tap a word from the suggestion list.
- Tap the arrow next to the suggestion list to see more choices.

---

## Entering text by speaking

---

No time to type? Try speaking the words to enter them.

1. Tap an area where you want to enter text.
2. On the onscreen keyboard, press and hold .
3. When you see the animated microphone button and the words "Speak now", say the words you want to enter.



To set the voice input language, tap the language bar above the microphone button. You can choose one or more languages. Available languages may vary.

4. If a word doesn't match what you've spoken and it's underlined, tap the underlined word to delete it or to see more choices.
5. Enter punctuation marks by saying the name (for example, say "comma").

## Battery

---

### Displaying the battery percentage

---

You can check the percentage of remaining battery power right from the status bar.

1. Go to Settings, and then tap **Power**.
2. Select **Show battery level**.

---

### Checking battery usage

---

See a ranking list of apps that are using the battery. You can also see how much and how long the battery has been used for each app.

1. Go to Settings, and then tap **Power**.
2. Tap **Battery usage**, and then tap an app to check how it's using the battery. You'll see how much battery power is used by resources such as the CPU for the app and other use details.



If you see buttons while viewing an app's battery use details, you can tap them to adjust settings that affect battery usage, stop the app, and more.

---

### Checking battery history

---

Check how long you've been using HTC Desire 510 since the last charge. You can also see a chart that shows how long the screen has been on, and how long you've been using connections like the mobile network or Wi-Fi.

1. Go to Settings, and then tap **Power**.
2. Tap **History**.
3. If you've used HTC Desire 510 for a long time since the last charge, swipe left or right to scale the graph that details battery usage over time.

You can also slide two fingers together or apart to scale the graph.

---

### Using power saver mode

---

Power saver mode helps to increase battery life. It reduces the usage of phone features that drain the battery such as the display and data connection.

1. Go to Settings, and then tap **Power**.
2. Tap the Power saver **On/Off** switch to turn power saver mode on or off.

If you want to choose which phone features to conserve power for, tap **Power saver**.



If power saver mode's **Data connection** option is selected, HTC Desire 510 automatically disconnects from the mobile network after 15 minutes when the screen is off and the data connection is idle (no download activity, streaming, or data usage). It reconnects and then disconnects periodically when the data connection is idle to save battery power.

Keep in mind though that the **Sleep mode** option for the data connection in **Settings > Power**, when enabled, overrides power saver mode.

---

### Extreme power saving mode

---

In times when you don't need to use much of your phone, turn Extreme power saving mode on to extend battery life longer. In this mode, standby time can last longer than usual, and you can only use the most basic functions such as phone calls, text messaging, and email.

1. Go to Settings, and then tap **Power**.
2. Tap the Extreme power saving mode **On/Off** switch to turn extreme power saving mode on or off.

If you want to set when to automatically switch this mode on, tap **Extreme power saving mode** and select a battery level.

---

## Tips for extending battery life

---

How long the battery can last before it needs recharging depends on how you use HTC Desire 510. HTC Desire 510 power management helps to increase battery life.

If you like more control by tweaking settings on your own, try out some of these battery saving tips.

### Check your battery usage

Monitoring your battery usage helps you identify what's using the most power so you can choose what to do about it. For details, see [Checking battery usage](#) on page 43.

### Manage your connections

- Turn off wireless connections such as mobile data, Wi-Fi, or Bluetooth when not in use.
- Turn GPS on only when a precise location is needed, such as while using navigation or location-based apps. See [Turning location services on or off](#) on page 132.
- If the **Sleep mode** option in **Settings > Power** is enabled, at low peak times, your phone will turn off the data connection after the screen has been off for 15 minutes and there's no network activity (no downloads, streaming, or data usage). The data connection resumes when you switch the screen back on.
- Turn on Airplane mode when you don't need any wireless connections and you don't want to receive calls or messages.

### Manage your display

Lowering the brightness, letting the display sleep when not in use, and keeping it simple helps save battery power.

- Use automatic brightness (the default), or manually lower the brightness.
- Set the screen timeout to a shorter time.
- Don't use a live wallpaper for your Home screen. Animation effects are nice to show off to other people but they drain your battery.

Changing your wallpaper to a plain, black background can also help a little. The less color is displayed, the less battery is used.

For more details, see [Settings and security](#) on page 151 and [Personalizing](#) on page 48.

## Manage your apps

- Install the latest software and application updates. Updates sometimes include battery performance improvements.
- Uninstall or disable apps that you never use.

Many apps run processes or sync data in the background even when you're not using them. If there are apps that you don't need anymore, uninstall them.

If an app came preloaded and can't be uninstalled, disabling the app can still prevent it from continuously running or syncing data. See [Disabling an app](#) on page 156.

## Limit background data and sync

Background data and sync can use a lot of battery power if you have many apps syncing data in the background. It's recommended not to let apps sync data too often. Determine which apps can be set with longer sync times, or sync manually.

- In Settings, tap **Accounts & sync** and check what types of data are being synced in your online accounts. When the battery is starting to run low, temporarily disable syncing some data.
- If you have many email accounts, consider prolonging the sync time of some accounts.

In the Mail app, select an account, tap  > **Settings** > **Sync, Send & Receive**, and then adjust the settings under Sync schedule.

- When you're not traveling from one place to another, sync weather updates of only your current location, rather than in all of your named cities. Open the Weather app, and then tap  to edit and remove unneeded cities.
- Choose widgets wisely.

Some widgets constantly sync data. Consider removing the ones that are not important from your Home screen.

- In Play Store, tap  > **Settings**, and then clear **Add icon to Home screen** to avoid automatically adding Home screen app shortcuts whenever you've installed new apps. Also tap **Auto-update apps** > **Do not auto-update apps** if you're fine with updating apps from Play Store manually.

## Other tips

To squeeze in a little bit more battery power, try these tips:

- Tone down the ringtone and media volume.
- Minimize the use of vibration or sound feedback. In Settings, tap **Sound** and choose which ones you don't need and can disable.
- Check your apps' settings as you may find more options to optimize the battery.

## HTC Guide

---

### Having hardware or connection problems?

---

Before calling for support, you can first use the HTC Guide app to troubleshoot or perform diagnostics on your phone. This helps you in finding the problem cause, and in determining whether you can resolve the problem or you need to call for support.

To use the app, tap  > HTC Guide.



If HTC Guide is not preinstalled on your phone, you can download it from Google Play.

# Personalizing

## Making HTC Desire 510 truly yours

Make HTC Desire 510 look and sound just the way you want it.

- Choose a ringtone and other sounds that you like to use. See [Ringtones, notification sounds, and alarms](#) on page 48.
- Personalize your Home screen with a different wallpaper. See [Home wallpaper](#) on page 49.
- Change the apps on the launch bar. See [Launch bar](#) on page 49.
- Populate your Home screen with widgets and shortcuts. See [Adding Home screen widgets](#) on page 49 and [Adding Home screen shortcuts](#) on page 50.
- Need another widget panel? See [Adding or removing a widget panel](#) on page 51.
- Set HTC BlinkFeed or a widget panel as your main Home screen. See [Changing your main Home screen](#) on page 52.
- Organize your apps. See [Arranging apps](#) on page 53.

## Ringtones, notification sounds, and alarms

1. Go to Settings, and then tap **Personalize**.
2. Under **Sound**, choose different sounds for your ringtone, system notification, and alarm.

Go to the Messages, Mail, Calendar, and Tasks apps to choose sounds for new messages, email, calendar, and task reminders respectively.



Want alarms to ring louder but notifications to be more discreet? In Settings, tap **Sound > Volumes** and set the volume levels for each sound type.



## Home wallpaper

Choose from the available wallpapers, or use any photo you've taken with the camera.

1. Press and hold an empty space on a widget panel.
2. In the pop-up menu, tap **Choose wallpaper**.
3. Choose from where you want to select a wallpaper.
  - To use a photo you captured with the camera, tap **Gallery**, choose and crop a photo, and then tap **Done**.
  - Tap **Computer photos** to use the HTC Get Started service to choose a photo from your computer.

## Launch bar

The launch bar gives you one-touch access to commonly used apps (and other shortcuts). You can replace the apps on the launch bar with the ones you often use.

1. Press and hold the app you want to replace, and then drag it out to .





2. Tap  to go to the Apps screen.
3. Press and hold an app, and then drag it to the empty slot on the launch bar.

- You can also group apps on the launch bar into a folder. See [Grouping apps on the widget panel and launch bar](#) on page 53.
- The apps (or other shortcuts) on the lock screen are the same as the ones on the launch bar.

## Adding Home screen widgets

Widgets make at-a-glance important information and media content easily available. Choose from a selection of widgets and add the most useful ones to your Home screen.

1. Press and hold an empty space on a widget panel.
2. In the pop-menu, tap **Add apps and widgets**.
3. Tap  > **Widgets**.

4. Scroll through the widgets, or tap  to search for a specific widget.  
Some widgets are available in different styles and sizes.
5. Press and hold and then drag the widget to a widget panel you want to add it to.

You can also add widgets that allow you to quickly switch on or off certain settings such as Wi-Fi and Bluetooth.

---

### Changing the settings of a widget

---

You can modify basic settings of some widgets (for example, the People widget).

1. Press and hold a widget on your Home screen, and then drag it to .

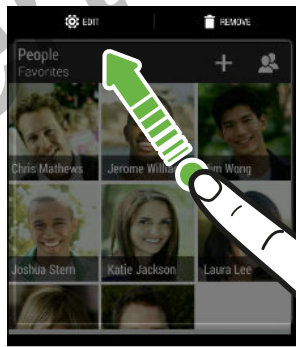

2. Customize the widget settings.

---

### Resizing a widget

---

Some widgets can be resized after you've added them to your Home screen.

1. Press and hold a widget on the Home screen, and then release your finger. If a border appears, that means the widget is resizable.
2. Drag the sides of the border to enlarge or shrink the widget size.

## Adding Home screen shortcuts

Place apps you often use on any widget panel of your Home screen. You can also add shortcuts to frequently used settings, bookmarked webpages, and more.

1. Press and hold an empty space on a widget panel.
2. In the pop-up menu, tap **Add apps and widgets**.
3. Tap  > **Apps** or **Shortcuts**.

4. Scroll through the apps or shortcuts, or tap  to search for one.
5. Press and hold and then drag an app or a shortcut to a widget panel you want to add it to.



To add an app from the Apps screen, press and hold the app, and then drag it to a widget panel.

## Editing Home screen panels

### Adding or removing a widget panel



- You won't be able to add a new widget panel if you've already reached the maximum limit.
- HTC BlinkFeed always appears as the first panel (if it's not removed). A widget panel cannot be added before HTC BlinkFeed.

1. Press and hold an empty space on a widget panel.
2. In the pop-up menu, tap **Manage home screen panels**.
3. To add a new widget panel, swipe left until you see the **+** icon, and then tap it.
4. To remove a widget panel, swipe left or right until you see the panel, and then tap **Remove**.
5. When done, press .

### Arranging widget panels



A widget panel cannot be moved and inserted before HTC BlinkFeed.

1. On HTC BlinkFeed or any widget panel, slide two fingers together to customize the Home screen.
2. Press and hold a widget panel thumbnail, and then drag it left or right to the position that you want.
3. When you're done arranging widget panels, press .

### Moving a widget or icon

You can easily move a widget or icon from one widget panel to another.

1. Press and hold the widget or icon with one finger.
2. With another finger, flick left or right to rotate the screen to another widget panel.

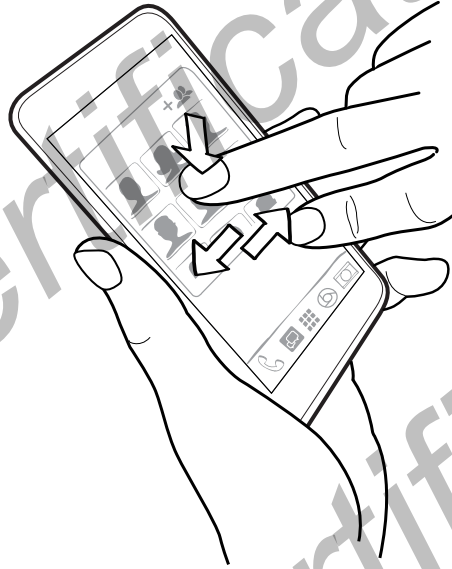

3. Release the widget or icon.

### Removing a widget or icon



1. Press and hold the widget or icon you want to remove, and then drag it to .
2. When the widget or icon turns red, lift your finger.

### Changing your main Home screen

Set HTC BlinkFeed or a widget panel as your main Home screen.

1. Press and hold an empty space on a widget panel.
2. In the pop-up menu, tap **Manage home screen panels**.
3. Swipe left or right until you see the panel that you want to use as your main Home screen.
4. Tap **Set as home**.
5. Press .



Pressing  from an app will first return you to the last panel you were in. Just press  again to go to your main Home screen.

## Grouping apps on the widget panel and launch bar

1. Press and hold an app, and then drag it over to another app to automatically create a folder.

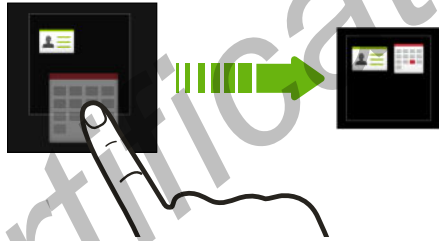

2. Tap the folder to open it.
3. Tap the folder window's title bar, and then enter a new folder name.
4. Add more apps into the folder. Tap **+**, select your apps, and then tap **Done**.

You can also add shortcuts to settings or information to a folder. Add a shortcut first to a widget panel, and then drag it over to the folder.

---



### Removing items from a folder

---

1. On the launch bar or widget panel, tap a folder to open it.
2. Press and hold an app or shortcut in the folder, and then drag it out to .

## Arranging apps



On the Apps screen, you can rearrange the apps and change the layout.



1. From HTC BlinkFeed or any widget panel, tap .
2. Tap , and then choose how to arrange apps, such as alphabetically. If you want to group apps into folders or rearrange them, select **Custom**.
3. Tap  > **Grid size** to choose whether to display more or fewer apps per page.

---

### Moving apps and folders

---



1. On the Apps screen, tap  > **Custom**.
2. Tap  > **Rearrange apps**.

3. Press and hold an app or folder, and then do one of the following:
  - Drag the app or folder to another position on the same page. Wait until you see the occupying icon move away before releasing your finger.
  - Drag the app or folder to the  or  arrow to move it to another page.
4. When you're done moving apps and folders, tap .

---

### Grouping apps into a folder



---

1. On the Apps screen, tap  > Custom.
2. Tap  > Rearrange apps.
3. Press and hold an app, and then drag it over to another app to automatically create a folder.
4. To add more apps, drag each app over to the folder.
5. To name the folder, open the folder, tap its title bar, and then enter a folder name.
6. When done, tap .

---

### Removing apps from a folder

---

1. On the Apps screen, tap  > Custom.
2. Tap  > Rearrange apps.
3. Tap the folder to open it.
4. Press and hold an app, and then drag it out to the Apps screen. Wait until you see the occupying icon move away before releasing your finger.
5. When you're done removing apps, tap .

---

### Hiding or un hiding apps

---

1. On the Apps screen, tap  > Hide/Unhide apps.
2. Select the apps you want to hide, or clear their check boxes to unhide them.
3. Tap Done.

## Lock screen

### Adding a widget on the lock screen

Choose from our selection of lock screen widgets.



Before you can add a widget on the lock screen, you must select the **Enable lock screen widgets** option in **Settings > Security**.

1. On the lock screen, pull from the right edge until you see a **+** icon.
2. Tap **+**.
3. Tap a widget that you want to add to the lock screen.

### Moving or deleting a lock screen widget

1. On the lock screen, pull from the right edge until you see the widget you want to move or delete.
2. Press and hold the widget, and then drag it left or right to the position that you want.
3. Press and hold the widget, and then drag it to  to remove it.

### Changing lock screen shortcuts

To change apps (or other shortcuts) on the lock screen, change the ones on the launch bar. To find out how, see [Launch bar](#) on page 49.

### Turning the lock screen off

Rather not have to unlock your phone every time you wake it up? You can turn the lock screen off in Settings.

1. Go to Settings, and then tap **Security**.
2. Tap **Screen lock > No lock screen**.

To turn the lock screen on again, in Security settings, tap **Screen lock > Lock screen**.

# Camera

## Camera basics

Take great photos and videos with the camera, and make them more memorable by applying a variety of filters and scenes.

Open the Camera app and tap  to see all controls on the Viewfinder screen. You can use the controls to switch capture modes, add filters, and more.

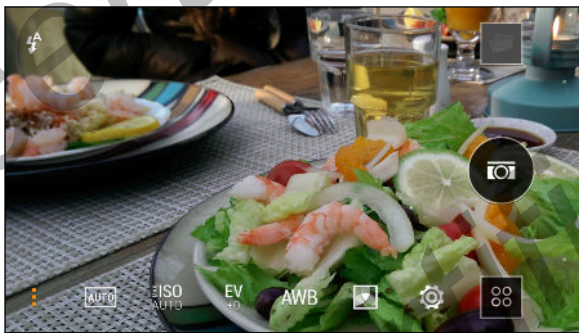

	See a collection of camera scenes when taking photos and videos.
	Choose an ISO level or set it back to Auto. Higher ISO works best in low light conditions.
	Adjust the exposure settings. Higher exposure settings capture more light for your photos or videos.
	Select a white balance setting that matches your current lighting environment.
	Apply photo or video filters.
	Modify basic and advanced camera settings.

## Choosing a capture mode

HTC Desire 510 gives you a variety of capture modes to use.

On the Viewfinder screen, tap , and then select a capture mode to use.

## Zooming

- Before taking a photo or video, slide two fingers apart to zoom in or together to zoom out.
- When you're recording video, you can freely zoom in or out while recording.



## Applying a filter

Use the available filters to make your photos and videos look like they've been taken through special lenses.





Some camera modes may not support filters.



1. On the Viewfinder screen, tap  to show the camera options.
2. Tap , and then choose one of the available filters.



## Using the volume buttons for taking photos and videos

If you feel much comfortable with using push-buttons when taking photos and videos, you can set HTC Desire 510 to use the VOLUME buttons as the Camera app's shutter release or zoom controls.

1. Switch to **Camera** or **Video** mode.
2. On the Viewfinder screen, tap  to show the camera options.
3. Tap  > **Volume button options**.
4. Choose how you want to use the volume buttons when you're in the Camera app.

## Closing the Camera app

To give you a full view of the Viewfinder screen, HTC Desire 510 replaces , , and  with small dots.

Tap a dot to show these buttons again, and then tap  or  to close the Camera app and return to the Home screen or the previous screen.

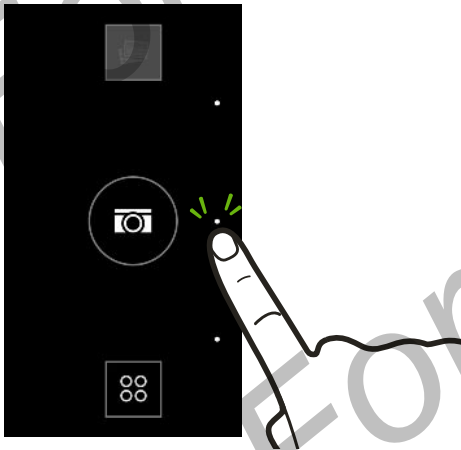

## Taking a photo

1. Open the Camera app.
2. Switch to **Camera** mode.
3. Point the camera at what you want to capture. The camera adjusts the focus automatically as you move it.
4. When you're ready to take the photo, tap .



## Tips for capturing better photos

To get better captures with the Camera app, here are some tips on what to do while taking your shots.

- If there are parts of the image that are in shadows and others are in highlights, use HDR to capture multiple shots of different exposures and combine them into one shot. Keep HTC Desire 510 steady or place it on a level surface when using HDR.
- When taking a panoramic photo, consider the whole scene and focus on an object that has a neutral tone to help keep the exposure balanced in the composite image.
- If your subject is lit from the back, use Backlight scene to highlight the foreground and keep some details of the background.
- If you are using the default settings and the photo still appears too dark, switch to Night scene, but place HTC Desire 510 on a level surface to keep it steady.
- In Camera settings, tap **Grid** to help frame the subject better or improve the composition.
- If taking photos under fluorescent or incandescent bulbs and the subject appears to be off-color, tap **AWB**, and then choose a white balance setting. Check the image on the Viewfinder and select the option that displays the closest color to the natural color of the subject.
- In Camera settings, you can tap **Image adjustments** and adjust the contrast, saturation, and sharpness before taking the photo.
- After capturing the photo, you can continue to edit the sharpness, contrast, brightness, and other settings in Gallery.

## Recording video

1. Open the Camera app.
2. Switch to **Video** mode.
3. When you're ready to start recording, tap .

4. Tap  to pause the recording, and then tap  to resume.
5. To stop recording, tap .



### Taking a photo while recording a video — VideoPic



Choose **Normal** scene to use this feature.

While you're recording video using the main camera, tap  to capture a still shot of your subject.

### Setting the video resolution

1. Switch to **Video** mode.
2. On the Viewfinder screen, tap  to show the camera options.
3. Tap .
4. Tap **Video Quality**, and then choose a video resolution.

## Taking continuous camera shots

Do you want to take photos of moving subjects? Whether it's your kid's football game or a car race, you can capture the action.



Choose **Auto** scene to use this feature.

1. Open the Camera app.
2. Switch to **Camera** mode.
3. On the Viewfinder screen, just press and hold . The camera takes up to 20 consecutive shots of your subject.
4. To keep just one photo, select the photo that you like the most, and then tap **Best shot**.

To save the photos as a batch, press .

## Taking selfies

No one around to take your photo?

1. Open the Camera app.
2. Switch to **Selfie** mode.

Or, switch to the front camera by swiping from the left or right edge of your phone's screen.





3. Tap anywhere on the screen to start the timer. The camera takes a photo after the countdown.



Some camera features are not available when you're using the front camera, such as zooming.

## Improving portrait shots

If you'd like your family or friends to look their best in your photos, make sure to use the Portrait scene. It smoothens the skin of the people in your shots.





1. Open the Camera app.
2. Switch to **Camera** or **Selfie** mode.
3. On the Viewfinder screen, tap  to show the camera options.
4. Tap  > .
5. When you're ready to take the photo, tap .

## Taking a panoramic photo

Get a wider shot of landscapes in one sweep.



Some camera features are not available when you're in this mode, such as zooming.

1. Open the Camera app.
2. Switch to **Camera** mode.
3. On the Viewfinder screen, tap  to show the camera options.
4. Tap , and then tap .
5. When you're ready to take the shot, tap .
6. Pan left or right in either landscape or portrait view. Hold HTC Desire 510 as smoothly as you can to automatically capture frames.

You can also tap  to stop capturing anytime.

The camera stitches the frames into a single photo.

## Using HDR

When shooting portraits against a bright background, use HDR, short for High Dynamic Range, to capture your subjects clearly. HDR brings out the details of both the highlights and shadows, even in high contrast lighting.



HDR works best when your subject is steady. The camera takes multiple shots at different exposure levels and combines them into one enhanced photo.





1. Open the Camera app.
2. Switch to Camera mode.
3. Tap **AUTO**, and then tap **HDR**.
4. To take an HDR photo, tap .

## Recording videos in slow motion

Relive high speed action bit by bit and add a touch of suspense to your videos.



Audio is recorded when you're in this scene, but will only be available when video is played back in normal speed.

1. Open the Camera app.
2. Switch to Video mode.
3. On the Viewfinder screen, tap  to show the camera options.
4. Tap  beside the menu button, and then tap .
5. Tap  to start recording.
6. To stop recording, tap .

## Saving your settings as a camera mode

Save a scene or custom settings as a new camera mode so you can conveniently use it anytime you need it.

1. Open the Camera app.
2. Switch to the camera mode you want to use.



Some camera modes may not support modifying the camera settings.

3. On the Viewfinder screen, tap  to show the camera options.
4. Modify the settings as desired.

5. When done, tap  > Save custom camera.
6. Enter a name, and then tap Save.

To select and use the newly created camera mode, tap  on the Viewfinder screen.

---

### Modifying a camera mode you've created

---

1. Switch to a camera mode that you've created.
2. Modify the scene or settings.
3. Tap  > Save custom camera.
4. Tap Yes to save changes to the existing mode.



To delete a custom camera mode, tap . Press and hold a camera mode you've created, and then drag it to  to delete it.

# Gallery

## Viewing photos and videos in Gallery

Reminisce about good times. Use Gallery to view all your photos and videos. View them by time, album, or location. When viewing your photos and videos, the onscreen navigation buttons will be hidden. Tap anywhere on the screen to see Gallery controls and onscreen navigation buttons.

## Viewing photos and videos organized by time

Photos and videos on HTC Desire 510 are grouped together in Timeline view according to when they were taken.

1. On the Gallery app's main screen, swipe to the Timeline tab. You'll see thumbnails for every time period.
2. Scale the time period by sliding two fingers together or apart or tapping ▼. You can choose between event, day, month, and year.
3. Tap a time period to see all related photos and videos.
4. Tap a photo or video to see it in full screen.

## Viewing photos and videos by album

1. On the Gallery app's main screen, swipe to the Albums tab.
2. Tap a tile to open an album.
3. Tap a photo or video to see it in full screen.

---

### Viewing photo highlights

---

Easily see all your favorite photos in one place. Gallery automatically groups all your most viewed or shared photos (your highlights) in one album. You can also manually edit the Highlights album.

- To view these favorite photos, open the Highlights album.
- To manually add a photo, find and view the photo in full screen, tap the photo, and then tap ★.
- To remove a photo from the Highlights album, press and hold the thumbnail and then tap Remove.

## Copying or moving photos or videos to another album

1. On the Gallery app's main screen, swipe to the Albums tab.
2. Tap a tile to open an album.
3. Tap  > **Move to** or **Copy to**.
4. Select the photos or videos you want to move or copy and then tap **Next**.
5. Select an album to move or copy the photos or videos to. To create a new album to move or copy to, tap **+**.



To move or copy a single photo or video, open an album and then press and hold the photo or video. Choose whether to move or copy the photo or video and then select the destination album or create a new album.

## Showing or hiding albums

Have too many albums cluttering up Gallery? You can choose to show or hide albums.

1. On the Gallery app's main screen, swipe to the Albums tab.
2. Tap  > **Show/hide albums** and choose which albums you'd like to show or hide.

## Renaming an album

If you have created albums to organize photos, you can rename these albums.

1. On the Gallery app's Albums tab, press and hold the album that you want to rename.
2. Tap **Rename**.



Some albums, such as Camera shots and Highlights, cannot be renamed.

## Viewing photos by location

Using Map view, you can view photos according to location.



Only photos with geo-tag info appear on the map.

1. On the Gallery app's main screen, swipe to the Locations tab.  
You'll see tiles of photos taken at specific locations, with numbers that indicate how many photos were taken in each location.
2. Tap  to display Map view.



3. Zoom out or pan across the map until a numerical location indicator  appears.

The number in the location indicator shows how many photos were taken in that area.

4. Tap the location indicator to see the photos taken in that area.



Want to know where you took a particular photo? While viewing the photo in full screen, tap anywhere on the screen, and then tap  > **Show on map**. (**Show on map** is available when you've enabled **Geo-tag photos** in Camera.)

### Adding location information

Want to specify more than just the city? You can add names of points of interests (POI) to your photos too.

1. On the Gallery app's main screen, swipe to the Locations tab.
2. Tap a tile to open it.
3. Swipe to the Places tab.
4. Tap **Tap to edit location** > **Add a new place**.
5. Tap a point of interest to add a POI from Foursquare™ or tap **New place** to manually enter a new name.
6. Tap **Save**.

### Changing location information

1. On the Gallery app's main screen, swipe to the Locations tab.
2. Tap a tile to open it.
3. Swipe to the Places tab.
4. Find the grouping you want to rename, then tap  and try one of the following:

Selecting another POI

1. Tap **Edit location** > **Tap to edit location**.
2. Tap a point of interest to add a POI from Foursquare or tap **New place** to manually enter a new name.
3. Tap **Save**.



Renaming the location

1. Tap **Rename this place**.
2. Enter a new name.
3. Tap **Save**.

You'll only see **Rename this place** if the name is stored on HTC Desire 510.

## Editing your photos

Make your pictures even better. Gallery has an array of editing tools that let you crop, rotate, apply and create photo filters, and much more to your photos.

1. In Gallery, open the photo you want in full screen, tap it, and then tap .
2. Do any of the following:
  - Tap  to apply a special effect to the photo.
  - Tap  to apply a filter to the photo.
  - Tap  to add a decorative frame to the photo.
  - Tap  to rotate, crop, flip, or straighten the photo.
3. Tap **Save**.









Except for when applying rotation, edited photos are saved as copies of the original.

## Applying custom filters to photos



Filters can only be applied to photos that are stored locally.

1. In Gallery, open the photo you want in full screen, tap it, and then tap .
2. Tap  > . You'll find  at the right end of the predefined filters bar.
3. On the Custom Effects screen you can:
  - Make changes to the filter by adjusting the controls on exposure, saturation, white balance, and more.
  - Rearrange filters to modify the effect. Press and hold the filter you want to move. Then drag it to a new position.
  - Remove filters. Press and hold the filter you want to remove. Then drag it to **Remove**.
  - Tap  to add more filters.
4. Tap **Save Preset** to name your filter and save it. After saving your filter, you'll see a preview of your photo with the filter applied.
5. Tap  to save the modified photo as a new photo.



## Trimming a video

1. On the Gallery app's main screen, swipe to the Timeline or Albums tab.
2. Tap a tile to open a time period or album.
3. When you see the video you want, tap it to play in full screen.

4. Tap the onscreen controls to pause or resume playback, adjust the volume, and more.



Tap  to share the video on your home network.

5. To trim the video, tap  > **Edit**.
6. Drag the trim sliders to the part where you want the video to begin and end.
7. Tap  to preview your trimmed video.
8. Tap **Save**.

The trimmed video is saved as a copy. The original video remains unedited.

## Saving a photo from a video

It's easy to save a still shot from a video.

While you're watching a video in Gallery, tap  to capture a still shot.

You can also pause the playback and drag the slider to the image you want before tapping .

## Creating a Zoe in Gallery

When you view a group of photos and videos such as an album, Gallery automatically composes a Zoe™. A Zoe is a collection of photos and videos that Gallery has preselected, with added background music and special effects.

You can change the content, theme, and music. You can also save or share the Zoe as a video.

1. On the Gallery app's main screen, swipe to the Timeline, Albums, or Locations tab.
2. Tap a tile to open a group of photos and videos. You'll then see the Zoe play automatically.
3. In portrait view, tap the Zoe tile if you want to edit it.
4. To change the content in the Zoe:
  - Swipe to the Content tab to select the ones you want to include in the Zoe.
  - Tap **⋮** > **Remix** to shuffle the content.
  - Tap **⋮** > **Choose start and end clips** to select specific photos or videos to start and end the Zoe.
5. Swipe to the Themes tab to choose the special effects and music to apply to the Zoe.

6. Swipe to the Music tab, tap **Search my library** to change the background soundtrack for all themes.

To restore the default soundtrack, tap **⋮** > **Restore theme's music**.



Do not reproduce, distribute, or otherwise use copyrighted materials in connection with the Zoe unless you have secured the copyright owner's permission first.

7. To trim the chosen soundtrack and include audio that was captured with the video included in the Zoe, tap **⋮** > **Music settings**.
8. To preview the Zoe in full screen, hold HTC Desire 510 in landscape orientation.
9. To create a video file of the Zoe, tap **⋮** > **Save**, and then choose a video quality.

Your video will be saved in the Zoe Highlights album.



# Phone calls

## Making a call with Smart dial

You can either dial a number directly, or use Smart dial to quickly place a call. Smart dial searches and calls a stored/synced contact or a number from your call history.

1. Open the Phone app.
2. Enter the phone number or first few letters of the contact's name to see the top matching contact.
3. If there are a number of matches found (for example, 8 matches), tap the number to see all the matches.
4. Tap the contact you want to call.



- To check other phone numbers associated with the contact, tap  beside the contact name.
- If the phone number has an extension, tap  after connecting to the main line and then dial the extension number.

## Dialing an extension number

To skip voice prompts when dialing an extension number, do one of the following:

- After dialing the main number, press and hold **\***. The letter **p** is added to the number you are dialing. Enter the extension number, and then tap the call button. You will be connected to the mainline and then to the extension number.
- After dialing the main number, press and hold **#** to add a **w**. Enter the extension number after the letter **w**, and then tap the call button. After connecting to the main line, tap **Send** to dial the extension number.

You can save phone numbers with an extension in the People app.

## Returning a missed call



You'll see the missed call icon  in the status bar when you miss a call.

1. Slide the Notifications panel open to check who the caller is.
2. To return the call, spread your two fingers on the missed call notification to expand it, and then tap **Call back**.

If you have multiple missed calls, tap the missed calls notification to open the Call History tab.

## Speed dial

Use Speed dial to call a phone number with a single tap.

1. Open the Phone app.
2. Tap  > **Speed dial** > . You can also press and hold an unassigned key on the dialpad, and then tap **Yes**.
3. Select a contact from the list.
4. On the Speed dial screen, choose the phone number of the contact to use, and a speed dial key to assign.
5. Tap **Save**.

To use Speed dial, press and hold the speed dial number you want to call.

## Calling a number in a message, email, or calendar event

When you receive a text message, email, or calendar event that has a phone number in it, you can just tap the number to place a call.

## Making an emergency call

In some regions, you can make emergency calls from HTC Desire 510 even if the micro SIM card has been blocked or if you don't have one installed.



If you don't have a network signal, you won't be able to make an emergency call.

1. Open the Phone app.
2. Dial the emergency number for your locale, and then tap **Call**.



If you've enabled but forgotten your lock password or lock pattern, you can still make emergency calls by tapping **Emergency call** on the screen.

## Receiving calls



When you receive a phone call from a contact, the Incoming call screen appears.



HTC Desire 510 will automatically adjust the ringtone volume when you use the polite ringer and pocket mode features.

### Answering or rejecting a call

Do one of the following:

- If the display is on when you get a call, tap **Answer** or **Decline**.
- If the display is locked when you get a call, drag  or  upwards.
- Press the POWER button twice to reject a call.

### Muting the ringing sound without rejecting the call

Do one of the following:

- Press the VOLUME DOWN or VOLUME UP button.
- Press the POWER button.
- Place HTC Desire 510 face down on a level surface.





If HTC Desire 510 is already facing down, it will still ring when there are subsequent incoming calls.

## What can I do during a call?

When a call is in progress, you can turn the speakerphone on, place the call on hold, and more.

### Putting a call on hold

To put the call on hold, tap  > Hold. The status bar then displays the hold call icon .

To resume the call, tap  > Unhold.

### Switching between calls



If you're already in a call and you accept another call, you can switch between the two calls.

1. When you receive another call, tap **Answer** to accept the second call and put the first call on hold.
2. To switch between the calls, tap the person you want to talk to on the screen.

### Turning the speakerphone on or off during a call



To decrease potential damage to your hearing, do not hold HTC Desire 510 to your ear when the speakerphone is on.

- On the call screen, tap . The speakerphone icon  appears in the status bar.
- To turn the speakerphone off, tap .

### Muting the microphone during a call

On the call screen, tap  to toggle between turning the microphone on or off. When the microphone is turned off, the mute icon  appears in the status bar.

### Ending a call

Do one of the following to end the call:





- On the call screen, tap **End Call**.
- Slide the Notifications panel open, then tap .



## Setting up a conference call

Conference calling with your friends, family, or co-workers is easy. Make or accept a call, and then simply dial each subsequent call to add it to the conference.

 Make sure that you have conference calling service activated. Contact your mobile operator for details.

1. Make a call to the first conference call participant.
2. When connected, tap  > **Add call**, and then dial the number of the second participant. The first participant is put on hold.
3. When connected to the second participant, tap .
4. To add another participant, tap , and then dial the number of the contact.
5. When connected, tap  to add the participant to the conference call. Tap  to access options such as ending the call with a participant.
6. To end the conference call, tap **End Call**.

## Call History

Use Call History to check missed calls, your dialed numbers, and received calls.

1. Open the Phone app.
2. Swipe to view the Call History tab.
3. Do one of the following:
  - Tap a name or number in the list to call.
  - Press and hold a name or number in the list to display the options menu.
  - Tap  to display just a particular type of call such as missed calls or outgoing calls.

---

### Adding a new phone number to your contacts from Call History



---

1. On the Call History tab, tap  next to the new phone number.
2. Choose whether to create a new contact or save the number to an existing contact.

---

### Clearing the Call History list

---

1. On the Call History tab, tap  > **Remove call history**.
2. Select the items you want to delete, or tap  > **Select all**.
3. Tap **Delete**.

---

## Blocking a caller

---

When you block a phone number or a contact, all calls from the phone number or contact will be declined automatically.

On the Call History tab, press and hold the contact or phone number you want to block, and then tap **Block contact**.



You can always remove a caller from your blocked list. On the Call History tab, tap **> Blocked contacts**. Press and hold a contact, and then tap **Unblock contacts**.

## Switching between silent, vibrate, and normal modes

Do one of the following:

- To change from silent to normal mode, press the VOLUME UP button.
- To change from vibrate to normal mode, press the VOLUME UP button twice.
- Go to Settings, and then tap **Sound > Sound profile**.

## Home dialing

When you're on a trip abroad, it's easy to dial friends and family from home.

Your home country code is automatically added when you call your contacts while roaming. But when manually entering a phone number to call, you need to enter a plus (+) sign and country code before the number.



Using a roaming service may incur additional charges. Check with your mobile operator for rates before using a roaming service.

---

## Changing the default country code for Home dialing

---

1. Go to Settings, and then tap **Call**.
2. Tap **Home dialing settings**.
3. Select a country, and then tap **OK**.

---

## Turning off Home dialing



---

If you prefer to manually enter complete phone numbers to call while roaming, you can turn off Home dialing.

1. Go to Settings, and then tap **Call**.
2. Under **Other settings**, clear the **Home dialing** option.

# Messages





## Sending a text message (SMS)

1. Open the Messages app.
2. Tap **+**.
3. Enter a contact name or mobile number in the To field.
4. Tap the box that says **Add text**, and then enter your message.
5. Tap , or press  to save the message as a draft.



- There is a limit on the number of characters for a single text message (displayed above ). If you exceed the limit, your text message will be delivered as one but will be billed as more than one message.
- Your text message automatically becomes a multimedia message if you enter an email address as the recipient, attach an item, or compose a very long message.

## Sending a multimedia message (MMS)

1. Open the Messages app.
2. Tap **+**.
3. Enter a contact name, mobile number, or email address in the To field.
4. Tap the box that says **Add text**, and then enter your message.
5. Tap , and then choose an attachment type.
6. Select or browse for the item to attach.
7. After adding an attachment, tap  to see options for replacing, viewing or removing your attachment.
8. Tap , or press  to save the message as a draft.

## Sending a group message

Group messaging makes it easy to send a message to multiple contacts all at once. You can choose to send a group SMS or group MMS.



Group MMS may incur extra data fees.

1. Open the Messages app.
2. Tap **+**.
3. Tap **⋮**, and then select multiple recipients.
4. To send a group SMS, make sure that **Send as individual messages** is selected. Clear this option to send your message as a group MMS.

Group SMS	Your message will be sent to the recipients as a text message and you will be charged by your mobile operator for each message sent. Replies of your recipients are sorted separately.
Group MMS	Similar to a group chat, sending a group MMS lets your recipients join the conversation you've started.  HTC Desire 510 also organizes message replies in a single conversation thread. If this is your first time to send a group MMS, you may need to enter your mobile phone number.

5. Tap the box that says **Add text**, then enter your message.
6. Tap **⏏**.

## Resuming a draft message

If you switch to another app or if you receive an incoming call while composing a text message, the message is automatically saved as a draft.

1. Open the Messages app.
2. Tap a draft message, and then edit the message.



To see all draft messages in one place, tap **☰**, and then tap **Drafts**.

3. Tap **⏏**.

## Replying to a message

1. Open the Messages app.
2. Tap a contact (or phone number) to display the exchange of messages with that contact.

3. Tap the box that says **Add text**, and then enter your message.
4. Tap .



---

### Replying to a contact's other phone number

---

When a contact has multiple phone numbers stored on HTC Desire 510, you can select which phone number to reply to.

Keep in mind that if you don't select another number, your response will be sent to the phone number that your contact used to send the last message.

1. While viewing the exchange of messages with a contact, tap  and select which phone number you want to reply to.
2. Tap the box that says **Add text**, then enter your reply message.
3. Tap .

### Saving a text message as a task

Save a text message in your Tasks list so you can remind yourself when to reply.

1. Open the Messages app.
2. Tap a contact (or phone number) to display the exchange of messages with that contact.
3. Tap the message you want to save, and then tap **Save as task**.

### Forwarding a message

1. Open the Messages app.
2. Tap a contact (or phone number) to view the exchange of messages with that contact.
3. Tap a message, and then tap **Forward**.

### Moving messages to the secure box

You can move private messages to the secure box. You will need to enter a password to read these messages.



- The secure box does not encrypt messages.
- Messages stored on a micro SIM card cannot be moved to the secure box.

1. Open the Messages app.
2. Tap a contact (or phone number) to display the exchange of messages with that contact.

3. Tap  > **Move to secure box**.
4. Select the messages, and then tap **Move**.



To move all the messages from a contact, on the Messages screen, press and hold the contact and tap **Move to secure box**.

- To read messages in the secure box, on the Messages screen, tap  > **Secure**. If it is your first time to use the secure box, set a password.
- To remove messages or contacts from the secure box, press and hold the contact (or phone number) and tap **Move to general box**.

## Blocking unwanted messages

Declutter your Messages screen by moving spam messages from contacts to the block box. If you have blocked a contact, that contact's text or picture messages will also be in the block box.

- Open the Messages app, press and hold a contact (or phone number) and tap **Block contact**.
- To block multiple contacts, tap  > **Block contacts**, select the contacts, and tap **Block**.

When the contact sends you messages, you will not see them in the Messages screen or receive notifications and calls.

To read messages in the block box, on the Messages screen, tap  > **Block**.





- To remove messages or contacts from the block box, press and hold the contact (or phone number) and tap **Unblock**.
- To completely discard future messages from blocked contacts, clear the **Save block message** option in the Messages settings.

## Copying a text message to the micro SIM card

1. Open the Messages app.
2. Tap a contact (or phone number) to display the exchange of messages with that contact.
3. Tap the message, and then tap **Copy to SIM**. The  icon is displayed.

## Deleting messages and conversations

Open the Messages app and do any of the following:

<b>Delete a message</b>	Open the conversation thread with a contact, tap the message, and then tap <b>Delete message</b> .  To delete multiple messages within a conversation, tap  > <b>Delete messages</b> > <b>Delete by selection</b> , and then select the messages to delete.
<b>Delete a conversation</b>	Press and hold a contact (or phone number), and then tap <b>Delete</b> .  To delete multiple conversations, tap  > <b>Delete threads</b> , and then select the conversations to delete.



In the Messages settings, tap **General** > **Delete old messages** to auto delete old messages.

### Preventing a message from being deleted

You can lock a message to prevent it from being deleted even if you delete the other messages in the conversation.

1. On the Messages screen, tap a contact (or phone number) to display the exchange of messages with that contact.
2. Tap the message that you want to lock.
3. Tap **Lock message** on the options menu. A lock icon  is displayed.

# Search and web browser

## Getting instant information with Google Now

Do you want to check the weather or your morning commute time before you start your day? Google Now™ delivers quick and up-to-date information that matters to you—all without the search.

Depending on your location, time of day, and previous Google searches, Google Now displays information cards that include:

- The day's weather and the weather forecast for upcoming days.
- The traffic conditions on your way to work or your commute back home.
- The directions and travel time to your next appointment.
- The next train or bus arriving at your platform or bus stop.
- Your favorite team's score and stats while you enjoy the game.

Open the Google Search app to use Google Now. To open, tap **Google** on the Apps screen. Or just swipe up from the onscreen navigation buttons.

---

### Setting up Google Now

---



Before setting up Google Now:

- Make sure that you're signed in to your Google account.
- Turn location services on and make sure that you have an Internet connection. For more information on location services, see [Turning location services on or off](#) on page 132.

1. Open the Google Search app.



To launch Google Now from the lock screen, drag  up the screen.



2. Tap **Next** on the **Get Google Now!** screen.
3. Tap **Yes, I'm in**. Google Now information cards will start to appear on the Google search screen.
4. To see all available information cards, swipe up the screen and tap **More**.

Depending on the information that you've allowed to share, more information cards will appear on the Google search screen as you use HTC Desire 510 to search the Web, create appointments, set reminders, and more.



## Changing card settings

You can easily customize the settings of Google Now cards to suit your information needs. For example, you can change the weather units in the Weather card or your transportation mode in the Traffic card.

1. Open the Google Search app.
2. Do any of the following:
  - To change a card setting, such as the weather unit on the Weather card, tap , and then tap the arrow buttons when available.
  - To change specific card information such as your work address and sports teams or stocks you follow, scroll to the bottom of the screen, tap , and then tap the information you want to change.

## Dismissing and hiding cards



1. Open the Google Search app.
2. Do any of the following:
  - To dismiss a card, swipe it left or right.
  - To keep the card from appearing on the Google search screen, tap  on the card you want to hide, and then tap **No**.

## Setting reminders in Google Now

Creating reminders in Google Now is an easy way to keep tab of things to do. You can set time or location-based reminders. When the reminder time is up or when you've arrived at the specified location, Google Now displays the Reminder card in the Google search screen and sounds a notification to alert you.



This feature may not be available in all languages.

1. Open the Google Search app.
2. Scroll to the bottom of the screen, and then tap  > .
3. Enter the reminder title, such as the task you want to be reminded of.
4. Select **When** to set a time-based reminder or **Where** to set a location-based reminder.
5. Set the reminder time or location details.
6. Tap **Remind me at this time** or **Remind me at this place**.

When the reminder time is due or when you've arrived at the location, the Reminder card will appear in the Google search screen. You can then dismiss or snooze the reminder.



To see a list of all your reminders, scroll to the bottom of the Google search screen, and then tap .

---

## Refreshing Google Now

---

Refresh Google Now to update the information cards or show relevant cards for information that you've just added on HTC Desire 510, like an upcoming event in Calendar.

1. Open the Google Search app.
2. Pull down the screen with your finger, and then release to refresh.

---

## Turning off Google Now

---

1. Open the Google Search app.
2. Scroll to the bottom of the screen, and then tap **⋮** > **Settings**.
3. Tap the **On/Off** switch next to Google Now, and then tap **Turn off**.

## Searching HTC Desire 510 and the Web

You can search for information on HTC Desire 510 and on the Web. In the Google Search app, start your search by entering a keyword or by using Google Voice Search™.

To open Google Search, tap **Google** on the Apps screen. Or just swipe up from the onscreen navigation buttons.



Some apps, such as People or Mail, have their own search function, which you can use to search only within those apps.

---

## Performing searches on the Web and HTC Desire 510

---

1. Open the Google Search app.



If you've already set up a Google account on HTC Desire 510, you will be given the option to sign in to Google Now. To sign in to Google Now at a later time, tap **↶**. See [Getting instant information with Google Now](#) on page 80.

2. In the search box, enter what you want to search for. As you type, matching items on HTC Desire 510 and suggestions from Google web search are shown.





To search for the information exclusively on HTC Desire 510, swipe your finger up the screen, and then tap **Search Phone**.



3. If what you're searching for is in the list of suggestions, tap the item to open it in its compatible app.

## Searching the Web with your voice

Use Google Voice Search to find information on the Web by speaking to HTC Desire 510.

1. Open the Google Search app.
2. Tap , and then say what you want to search for. After speaking, matching items from Google web search are shown.
3. If what you're searching for is in the list, tap the item to open it in its compatible app. Otherwise, tap  to search again.

## Setting search options

1. Open the Google Search app.
2. Tap  > **Settings**, and then tap an option you want to set.
3. To get help or provide feedback, tap  > **Help & feedback**.





You can also access the settings when viewing the search results. Pull down the screen to show the hidden menu button, and then tap  > **Settings**.

## Browsing the Web



1. Open the Internet app.
2. Tap the URL box on top of the screen.



If the webpage is in fullscreen mode, flick the screen down to show the URL box and other options.

3. Enter the webpage address or your search keywords.
4. On the webpage, you can:
  - Tap a link to open it, or press and hold a link to see more options.
  - Tap an email address to send a message to the email address, save it to People, and more.
  - Press and hold an image to save, copy, or set it as your wallpaper.
5. To return to the previous webpage you've viewed, tap , and then tap  or .

## Maximizing your browsing space

- To hide the status bar when browsing, tap  > **Settings** > **General**, and then select **Fullscreen**.
- While browsing a webpage, tap  > **Desktop View** to display the full desktop version of the webpage.



## Using browser tabs

Open multiple browser tabs and quickly switch from one webpage to another.

Open the Internet app.

- To add a browser tab, tap  > . Repeat the same to open new browser tabs.
- To switch among browser tabs, tap  and swipe to the webpage you want to view. Tap the browser tab to display the webpage in full screen.





- To close a browser tab, tap , and then tap .

## Saving web content for later

Save webpages to read later, even without an Internet connection. You can also add some video clips on webpages to the Watch list so you can quickly find and watch them whenever you like.

 HTC Desire 510 saves webpage text and images only. You will need Internet connection to open linked pages and play video clips.

1. While viewing a webpage, tap  > .
2. Tap Reading list or Watch list.

 When the webpage you're adding to the Watch list has one or more video clips, you'll be asked to choose which videos you want to add.

To view a saved webpage or video clip, tap  > **Saved**. Swipe to the Reading list or Watch list, and then tap a webpage or video you want to view.



## Setting browser options

Customize the web browser to suit your browsing style. Set display, privacy, and security options when using the web browser.

From the browser screen, tap  > **Settings**.



## Bookmarking a webpage

Add your favorite webpages as bookmarks so you can access them quickly.

1. While viewing a webpage, tap  >  > **Bookmarks**.
2. On the Bookmark this page screen, you can edit the bookmark name or save the bookmark in a new category folder.
3. Tap **Done**.

To view and open a bookmark, tap  > **Bookmarks**. Navigate to the bookmark you want to open, and then tap it.



You can also add a bookmark directly to the Home screen. While viewing a webpage, tap  >  > **Home screen**.

## Using your browsing history

HTC Desire 510 keeps a record of webpages you've visited.



If you don't want HTC Desire 510 to keep your browsing history, browse using an incognito tab. See [Private browsing](#) on page 86.

1. While viewing a webpage, tap  > **History**.
2. Swipe to the History or Most visited tab.
3. Navigate to the webpage that you want to view, and then tap it.

## Clearing your browsing history

1. While viewing a webpage, tap  > **Settings** > **Privacy & security** > **Clear history**.
2. Tap **OK**.

All webpage entries in the History and Most visited tabs are deleted.



If you want to delete a single webpage entry, go to the History or Most visited tab, press and hold the webpage entry, and then tap **Remove from history** or **Remove from most visited**.



Only the browsing history stored by the Internet app is deleted. Browsing history stored by other browsers on HTC Desire 510 will remain unaffected.

---

## Private browsing

---

You can use incognito tabs to browse the Web with more privacy. Browser cookies are deleted and not shared when you close all incognito tabs. Pages you view in incognito also won't appear in your browser history (except for files you've downloaded).

From the browser screen, tap  > .

# Entertainment

## HTC Music

### Listening to music

Enjoy your favorite songs on HTC Desire 510 using the Music app.



When you open the Music app for the first time, you'll be asked if you would like to automatically download related content, such as album covers and artist photos, to HTC Desire 510.

1. Open the Music app.
2. Swipe to the different tabs to browse by category.
3. Tap a song to play.
4. Tap the onscreen icons to control music playback, repeat songs, and more.

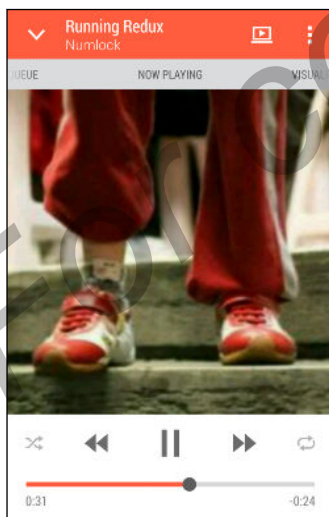

Press and drag your finger across the progress bar to jump to any part of the song.



Turn shuffle on or off. (Shuffle is off when button is gray.)



Cycle through the repeat modes: repeat all songs, repeat current song, and don't repeat.



Play your music on a DLNA® compliant TV or audio system, HTC Media Link HD, or stereo Bluetooth device.



Minimize the Now playing screen to continue browsing your music collection.



When you're listening to music and the screen display turns off, press POWER to turn the screen back on and control the music playback directly on the Lock screen.

## Playing music from the Lock screen

If you want to launch the Music app directly from the Lock screen, go to Settings, and then tap **Security > Unlock Music automatically**.

You can:

- While playing music and the screen turns off, press POWER to turn the screen back on, swipe down from the Music widget, and then tap on the widget.
- If you've added the Music app as a shortcut on the launch bar, drag it up to open the Music app.

## Music playlists

Personalize your music experience by creating music playlists. Make a playlist containing just your favorite songs or create one to match your mood for the day. You can make as many playlists as you like.

1. Open the Music app.
2. Swipe to the Playlists tab.
3. Tap **+**, and then enter a playlist name.
4. To add songs, tap **+** beside the title text box, browse your music collection, and then tap a song to add.

Repeat this step to add more songs.

5. You can also:

<b>Rearrange songs</b>	Press and hold <b>≡</b> next to the song title you want to move, and then drag it to its new position.
<b>Delete songs</b>	Select the songs you want to remove from the playlist.
<b>Change playlist name</b>	Type the new name of the playlist in the title text box.

6. Tap **Save**.

You'll find newly created playlists on the Music app's Playlists tab.

To edit or delete a playlist you've created, from the Playlists tab, tap a playlist to open it, and then tap **⋮ > Edit playlist** or **Delete**.



---

### Adding a song to the queue

---

While playing a song, you can also browse other tracks stored on HTC Desire 510. Add a song or an album to the queue so it plays when the current playlist has finished playing.

1. While a song is playing, browse for other tracks.
2. Do any of the following:
  - Browse for the album or playlist that you want, press and hold it, and then tap **Add to queue**.
  - Browse for an artist or song, and then tap **⋮** > **Add to queue**.

The songs you've added appear on the Queue tab.

---

### Updating album covers and artist photos

---

 To save on data usage, you might want to connect to a Wi-Fi network when updating your album covers and artist photos. In Music settings, select **Wi-Fi only**.

1. Open the Music app.
2. Swipe to the Artists or Albums tab.
3. Tap **⋮** > **Update artist photos** or **Update album art**.

If you want HTC Desire 510 to automatically check and update your music collection, tap **⋮** on the Music app's main screen, and then tap **Settings**. Select **Album art** and **Artist photos**.

---

### Setting a song as a ringtone

---



Pick a song from your Music library and set it as your ringtone or as ringtone for a favorite contact.

1. Open the Music app.
2. Play the song that you want to set as a ringtone.
3. Tap **⋮** > **Set as ringtone**.
4. Tap **Phone ringtone** or **Contact ringtone**.

If you select **Contact ringtone**, choose the contacts you want to associate the ringtone with.

### Trimming an MP3 ringtone

Use the Music app's ringtone trimmer if you want to set only a part of the song as ringtone.

1. When you find the song that you want, tap  > **Set as ringtone** > **Trim the ringtone**.
2. Drag the trim sliders  to the part where you want the ringtone to begin and end.  
For a more precise trimming, tap the left or right arrow buttons. Time markers indicate where you are on the song.
3. When you're done trimming, tap **Set as**.
4. Choose whether to set your trimmed song as your **Phone ringtone** or **Contact ringtone**.



You can see your new ringtone in the phone settings. Go to **Settings > Sound > Ringtone**.

### Viewing song lyrics

Love a song so much that you want to sing along? HTC Desire 510 gives your music an extra kick with song lyrics and cool music visualizations.





To save on data usage, connect to a Wi-Fi network when downloading lyrics. In Music settings, select **Wi-Fi only**.

1. Open the Music app.
2. Browse to the song you want to play and tap it.
3. Swipe to the Visualizer tab to view the lyrics. Song lyrics appear onscreen if content has been successfully downloaded.



Want a different visual for your music? Tap  > **Scene** and select a scene. If you want the scene to change for every song, select **Random**.

4. Tap the screen to display the lyrics in full screen.
5. To jump to another part of the song, tap the screen to make the progress bar appear. Press and drag your finger across the progress bar, or press and hold  or .



Not all languages are supported.

## Finding music videos on YouTube

It's easy to find music videos of the song you're listening to on YouTube®.

On the Now playing screen, tap  > Search > YouTube.

## YouTube

### Watching videos on YouTube

Check out the latest video sensations using the YouTube app.

1. Open the YouTube app.
2. Browse or search for a video.
3. When you find the video that you like, tap it.



Want to watch the video at a later time instead? Tap  next to the video title, and then tap Add to > Watch later. You can access the video again from your account profile's Watch Later list.

4. While watching a video, you can:
  - Turn HTC Desire 510 sideways to watch the video in full screen.
  - Tap the video screen to pause or to resume playback, or drag the slider to jump to a different part of the video.
  - Scroll down the video information panel to see related videos and comments from other viewers.
  - Browse other videos by minimizing the video screen. Tap  or drag the video screen down to minimize. To close the video thumbnail, swipe it left or right.

Minimize the video screen, and then tap  to open the slideout menu. You can view your account profile and manage your subscriptions and video lists.

### Creating video playlists

Organize your favorite videos into playlists and watch them in the YouTube app.



Make sure that you're signed in to your Google account.

1. Open the YouTube app.
2. Browse or search for a video.
3. Tap  next to the video title, and then tap Add to > New playlist.
4. Enter the playlist name, and then tap OK.

If you don't want to share the video playlist, select **Private** before you tap OK.

5. To add another video to your playlist, browse or search for the video, and then tap  next to the video title.
6. Tap **Add to**, and then tap the playlist name.

To access and watch your video playlists, minimize the video screen and then tap  to open the slideout menu. Tap the playlist you want.

## FM Radio

### Listening to FM Radio

Listen to your favorite radio stations using the FM Radio app.



You need to connect a headset first to the audio jack of HTC Desire 510 to use FM Radio. FM Radio uses the stereo headset as the FM radio antenna.

1. Open the FM Radio app.

The first time you open FM Radio, it scans for local FM stations that you can listen to.

2. While you're listening to an FM station, you can:
  - Tap  or  to go to the next or previous station.
  - Drag the slider to tune in to a frequency on the FM band. To fine tune the radio frequency, tap  or .
  - Tap  to mark a radio station as a favorite. To see your other favorites and preset stations, tap .

3. To turn off FM Radio, tap .

## Wireless media

### Connecting to your home entertainment system

Want to make your HTC Desire 510 experience bigger and louder? Share your videos, music, and even streaming media to external devices through DLNA, A2DP (Bluetooth), or other supported wireless display connection.



Some devices may need to be paired before you can share to them.

### Sharing your media on DLNA devices



If you'll be using a DLNA compliant TV or audio system, refer to its documentation on how to connect it to your home network.

1. Connect HTC Desire 510 to your home network via Wi-Fi.
2. Open the Gallery or Music app.
3. Locate the media stored on HTC Desire 510 that you want to share, and then tap it.
4. Tap .
5. Choose the device on your network where you want to play the media.
6. Once connected to the device on your network, tap the onscreen controls to control playback, adjust the volume, and more.



For more information about DLNA, visit [www.dlna.org](http://www.dlna.org).

# Storage

## Phone storage

### Types of storage

Want to know what types of storage you can use for your apps, data, and files?

HTC Desire 510 has these storage types:

<b>Phone storage</b>	This storage combines both the internal storage, where apps, email, data, and text messages are stored, and the file storage, where photos, videos, and music files are kept.  If you are running out of phone storage, see <a href="#">Making more storage space</a> on page 95 for some tips on how to free up space.
<b>Storage card</b>	Use a storage card for storing more files. You can also set some apps to store data or files directly to the card.

- ⚠
  - Moving apps to the storage card doesn't back up the apps. If you do a factory reset, your phone loses the apps. You'll need to reinstall them.
  - When you remove the storage card and insert it in another phone, the apps on the storage card won't be installed automatically to the other phone. You'll need to reinstall them.

### Copying files to or from HTC Desire 510

You can copy your music, photos, and other files to HTC Desire 510.

- ⚠ Save and close your files before copying them from your computer to HTC Desire 510, or vice versa.

1. Connect HTC Desire 510 to the computer using the supplied USB cable. You'll see options for viewing or importing files on the computer screen.
2. Choose to view files.
3. Copy the files from your computer to HTC Desire 510, or vice versa.
4. After copying the files, disconnect HTC Desire 510 from the computer.

---

## Making more storage space

---

As you use HTC Desire 510, you'll accumulate data and fill its storage capacity over time. Here are some tips on how to increase storage space.

### Run the storage wizard

Free up space in the storage by uninstalling apps and deleting files you no longer want to keep. In Settings, tap **Storage** > **Make more space**.

### Manage photos and videos

- After taking continuous camera shots, keep only the best shot. Discard the rest, if you don't need them.
- After editing a photo or trimming a video, the original file is kept. Delete original files or move them elsewhere, such as to your computer.
- If you're only sending videos through MMS, use a lower resolution. Hi-res video takes up more space. In Camera settings, tap **Video Quality** to change the resolution.

### Back up data and files

Keep only the most recent data in your apps and files that you often need to use. You can back up your other data and files. For some tips, see [Ways of backing up files, data, and settings](#) on page 103.

### Disable some apps

See [Disabling an app](#) on page 156.

### Move some apps to the storage card

Some third-party apps can be moved from the phone storage to the storage card. Go to **Settings** > **Apps** > **On SD card** to see which apps can be moved. To move, tap an app, and then tap **Move**.

- ⚠
- Moving apps to the storage card doesn't back up the apps. If you do a factory reset, your phone loses the apps. You'll need to reinstall them.
  - When you remove the storage card and insert it in another phone, the apps on the storage card won't be installed automatically to the other phone. You'll need to reinstall them.

## Your files

### File Manager

Use the File Manager app to browse and organize your files and folders on your phone storage and storage card.

#### Switching between storage types

1. Open the File Manager app. The slideout menu listing the types of storage automatically opens.
2. Select a file storage where you want to browse or organize your files.

To open the slideout menu again and switch to a different storage, tap .



#### Searching for files

1. In File Manager, tap .
2. In the search box, enter a few characters of the filename. Matching filenames from the root and subfolders are then displayed.
3. Tap a file to open it.

#### Sorting your files

1. In File Manager, tap  > Sort.
2. Choose how you want to sort your files and folders.

#### Copying or moving files

1. In File Manager, browse for the file or folder.
2. Press and hold the item to copy or move.  
To copy or move multiple items, tap , select the files or folders, and then tap .
3. Tap Copy or Cut.
4. Tap the folder where you want to copy or move the files.  
Or tap  > New folder to create a new folder.
5. Tap  > Paste.

#### Deleting files or folders

1. In File Manager, browse for the file or folder.
2. Press and hold the item to delete.  
To delete multiple items, tap , select the files or folders, and then tap .
3. Tap Delete.



## Google Drive

---

### Using Google Drive on HTC Desire 510

---

Store your photos, documents, and other files on Google Drive to access them on HTC Desire 510, your computer, and your other mobile devices.

On HTC Desire 510, just use your Google Account to sign in to your Google Drive storage. You can then:

- Use Gallery to upload your captured photos to Google Drive.
- Share a link to your Google Drive files by email.
- View and edit Office documents that are stored in Google Drive. After creating new Office documents, you can also save them to Google Drive.
- View PDFs that are stored in Google Drive. You can also export Office documents as PDFs to Google Drive.
- Check your available Google Drive storage space in Settings.
- Back up HTC Desire 510 to Google Drive, so you can easily restore your backup to another HTC phone next time.
- Use the Google Drive app to manage your online storage.



Uploading files requires you have the Drive app installed on HTC Desire 510. If this app is not preloaded, you can download and install it from Google Play.

## Activating your free Google Drive storage

Use up to 65GB of free Google Drive storage. In addition to the default storage that you get from Google Drive, HTC Desire 510 features an additional 50GB of online storage free for two years. Sign in to your Google Account on HTC Desire 510—and not from your computer or other non-HTC phones—to claim this offer.

1. If you see the promotional Google Drive offer on HTC BlinkFeed, just tap the tile.

Or open the Drive app. If this app is not preloaded on your phone, you can download it from Google Play.

2. On the screen that shows the additional storage offer, tap **Redeem**. The additional storage will then be added to your account.
3. Follow the onscreen prompts to learn the things you can do with Google Drive.



- If you don't see the screen for redeeming the offer, tap  > **Product Tour** in the Drive app to access it.
- View the offer details to know up to when you can redeem the offer.
- Additional terms and requirements may apply, including a subscription fee, after your two-year trial expires. For details, refer to the terms and conditions on the Google Drive support site at [support.google.com/drive/?p=drive\\_offers\\_htc](http://support.google.com/drive/?p=drive_offers_htc).
- The Drive app is owned by Google and is not provided by or associated with HTC Corporation.

## Checking your Google Drive storage space

In Settings, you can check your available Google Drive storage space.



Before your Google Drive storage info appears in Settings, you need to access your Google Drive from an HTC app first. For example, use the Mail app to share a link to your Google Drive Google Drive file.

Go to Settings, and then tap **Storage**. Under Online storage, you'll see your Google Drive storage space.

You can also check your online storage space in the Drive app. Tap  , and you'll see your storage space on the slideout menu.

From time to time, check back on how much online storage space you still have before you upload more content.

---

## Uploading your photos and videos to Google Drive

---

Use Gallery to upload your photos and videos to Google Drive.



1. On the Gallery app's main screen, swipe to the Timeline, Albums, or Locations tab.
2. Tap an album or event that contains the photos and videos you want to upload.
3. Tap .
4. If you see the Zoe screen, tap **Close** to close it.
5. From the selection menu, tap **Drive**.
6. Select the photos and videos you want to upload, and then tap **Next**.
7. Choose or create a folder in Google Drive.
8. Tap **OK** to upload.

---

## Sharing links to documents or files in Google Drive

---

No more attaching large files to your email. Using the Mail app, you can easily share links to documents or other files in your Google Drive by email.

1. Open the Mail app.
2. If you have several email accounts, switch to an email account you want to use.
3. Create a new email message and fill in your recipients, or reply to an email.
4. Tap .
5. Tap **Document**, and then choose whether to share PDFs or Office documents.  
Or tap **File** to choose any file type.
6. On the HTC files screen, tap **Drive**.  
If you don't see this screen, press  first.
7. In your Google Drive storage, open the folder that contains the files that you want.
8. Select the files you want to share, and then tap **OK**.  
You'll then see the links to your selected files added to your email message.
9. Tap  to send your email.

Shared links are not accessible by your recipients automatically. Once your recipients receive the link, they can request access, and then you'll receive an email that notifies you to give them access. Or, before sharing, you can first use the Drive app to add the recipients you will share your Google Drive link with.

---

### Giving people access through the Drive app

---

Using the Drive app, add the people you want to share your Google Drive link with. You can also set permissions, such as to let the recipients view, edit, or comment on your shared content.

1. Open the Drive app.
2. Tap ⓘ next to a file or a folder, depending on which one you will share.
3. Tap 👤.
4. Enter the first few characters of the name or email address from your Google contacts, and then select one from the matching results.

Repeat this step to add more people.

5. set permissions to allow recipients to:
  - View or edit a folder.
  - View, edit, or comment on a file.
6. Tap Add.

---

### Working with documents that are stored in Google Drive

---

With Polaris™Office 5, view PDFs and edit Office documents that are stored in your Google Drive. You can also create Office documents in this app, save them to Google Drive, and even export them as PDFs to Google Drive.

1. Open the Polaris Office app.
2. Tap 🗂️ to see your documents by file type.

Documents listed under your Google Account are the files that are stored in your Google Drive storage. If necessary, tap ▼ next to your account to see the file list.







3. Tap a PDF document to view it, or tap an Office document to edit it.
4. After making changes to an Office document, tap the icon on the top left to open a selection menu.
5. Tap Save or Save as.



If you want to export this document as a PDF, tap the icon on the top left, and then tap PDF Export.

## Saving a document from HTC Desire 510 to Google Drive

In Polaris Office 5, you can save a PDF you're viewing or an Office document you created to your Google Drive storage.

1. In Polaris Office, tap  to see your documents by file type.  
Documents listed below the  icon are the files that are locally stored on HTC Desire 510. If necessary, tap  to see the file list.
2. Open a PDF document, or create a new Office document.
3. To save the document to Google Drive, tap the icon on the top left, and then tap **Save as**.
4. Tap the Folder path box.
5. Tap , and then tap your Google Account to switch to your Google Drive storage.
6. Tap a folder where to save the document, and then tap .
7. Enter a file name, and then tap .

# Sync, backup, and reset

## Online sync

### Adding your social networks, email accounts, and more

You can sync contacts, calendars, and other information from your social networks, email accounts, and online services on HTC Desire 510. Depending on the account type, signing in to your online accounts lets you sync updates between HTC Desire 510 and the Web.

1. Go to Settings, and then tap **Accounts & sync**.
2. Tap **+**.
3. Tap the account type you want to add.
4. Follow the onscreen instructions to enter your account information.



- In Settings > Accounts & sync, tap the Auto sync On/Off switch to turn automatic sync of all your accounts.
- You can add several Google Accounts.

### Syncing your accounts

1. Go to Settings, and then tap **Accounts & sync**.
2. Tap the Auto sync **On/Off** switch to turn automatic sync of all your accounts on or off.
3. To manually sync individual accounts, tap an account type, and then do one of the following:
  - Tap **⋮** next to the account you want to sync, and then tap **Sync now**.
  - Tap **⋮** > **Sync now** on the Account settings screen.





- On the Account settings screen, you can also change the sync settings for an account.

### Removing an account

Remove accounts from HTC Desire 510 if you no longer use them. Removing an account does not remove accounts and information from the online service itself.

1. Go to Settings, and then tap **Accounts & sync**.
2. Tap an account type.

3. Tap  next to the account you want to remove.  
Or if you're on the Account settings screen, tap .
4. Tap Remove.



Some personal data may be retained by the third-party app after you have removed the account from HTC Desire 510.

## Backup

### Ways of backing up files, data, and settings

Worried that you might lose important stuff on HTC Desire 510? Back up HTC Desire 510 before you erase the storage, do a factory reset, or upgrade to a new phone.

#### HTC Backup

Use the built-in HTC Backup to back up your accounts, settings, contacts stored on your phone, text messages, and more to the cloud so that it will be easier to restore them on HTC Desire 510 (after a factory reset) or newer phone.

#### HTC Sync Manager

Use HTC Sync Manager to import music, photos, and videos from HTC Desire 510 to your computer. You can also sync locally stored contacts, calendar events, bookmarks, and playlists between HTC Desire 510 and your computer.

Likewise, HTC Sync Manager is a good alternative if you don't want to back up your accounts, settings, and other personal content to the cloud. You can use it to create backups of HTC Desire 510 on your computer.

#### Other backup options

If you want, you can separately back up your data or files.

Some apps allow you to back up data to the phone storage or storage card so you can easily restore them after a factory reset. Just make sure not to erase the phone storage or storage card when you do a factory reset.



- Moving apps to the storage card doesn't back up the apps. If you do a factory reset, your phone loses the apps. You'll need to reinstall them.
- When you remove the storage card and insert it in another phone, the apps on the storage card won't be installed automatically to the other phone. You'll need to reinstall them.

<b>Messages</b>	Back up your text messages to the phone storage or storage card, or save them as an email attachment.
<b>Contacts</b>	<ul style="list-style-type: none"> <li>▪ Save contacts and other personal data to your online accounts so you can just sync them when switching to another phone.</li> <li>▪ If you have locally stored contacts in the People app, export them to the phone storage or storage card.</li> </ul>
<b>Files</b>	Manually copy and paste files by connecting HTC Desire 510 to your computer as a disk drive.
<b>Other data</b>	<ul style="list-style-type: none"> <li>▪ If you added new words to your personal dictionary in the onscreen keyboard, back up the dictionary to the storage card or save it as an email attachment.</li> <li>▪ Check the other apps to see if they support exporting data to the storage.</li> </ul>

### Using HTC Backup

Save the time and frustration of re-creating your personalized HTC Desire 510 experience when you do a factory reset or buy another phone. On HTC Desire 510, use HTC Backup to do a daily backup to the cloud so you can easily restore your content and settings next time.

HTC Backup uses your Google Drive or Dropbox™ storage to keep your content and settings. It can back up and restore the following:

<b>Personalization settings</b>	These include your feed sources in HTC BlinkFeed, widgets, wallpaper, Home screen layout, and ringtones.
<b>Accounts and passwords</b>	HTC Backup stores the login credentials for many popular email and social network accounts, such as Exchange ActiveSync, Outlook.com, and POP/IMAP.
<b>Apps and settings</b>	These include your contacts stored on HTC Desire 510, text messages, call history, web bookmarks, personal dictionary, Wi-Fi networks, free apps you've installed, grid size and sort order on the Apps screen, and more.

### Backing up HTC Desire 510 to Google Drive

Turn on HTC Backup to do a daily backup of your phone over Wi-Fi. Turn it on by selecting **Back up phone daily** while doing the on-device setup. If you didn't do so, use the HTC Backup app.

 Depending on the amount of content, doing a manual backup through data connection may incur additional data costs and take a long time. Using a Wi-Fi connection is recommended.

1. Open the HTC Backup app.
2. Tap **Turn on automatic backup**.



3. Make sure **Back up phone daily** is selected, and then tap **Next**.
4. Sign in with your Google Account, HTC Account, or Facebook account.
5. On the Cloud storage screen, tap the **Google Drive** option, and then tap **OK**.
6. If prompted, sign in to your Google Account to access your Google Drive.
7. To do a daily backup, make sure the **Automatic backup** switch is on. You can also tap **Back up now** to manually back up your phone anytime.

You'll see the most recent backup date and time under Backup history.

### Restoring your backup to HTC Desire 510 from Google Drive

If you backed up your phone to your online storage before, you can restore your backup to HTC Desire 510, or to a new HTC phone.



- Depending on the amount of content, restoring your backup to your phone through your data connection may incur additional data costs and take a long time. Using a Wi-Fi connection is recommended.
- To restore paid apps, you need to download and install them from Google Play.

1. When you turn on a new HTC phone for the first time or after a factory reset, select **Restore from HTC Backup** on the Get content from old phone screen.
2. Make sure to sign in using the same account that you used to back up your phone before. Your backup history will then be displayed.
3. Select a backup, and then tap **Next**.
4. If you used your HTC Account or Facebook account to backup your phone, sign in to your Google Account to access your Google Drive.
5. Follow the onscreen instructions to restore your backup and to continue setting up your phone.
6. Slide open the Notifications panel to check if there's any notification to finish setting up your phone.

Free apps from Google Play will be restored in the background, and you can track the progress via a notification in the status bar.

The Apps and Home screen shortcuts will be reorganized as in your backup after all of your apps have been installed. You may continue using your phone while apps are being restored.



You can also open the HTC Backup app, and then tap **Restore from backup**. Just make sure that you've already signed in to the same account that you used to back up your phone before.

Restoring a backup will overwrite the current data and settings on HTC Desire 510.

## Switching from your previous online storage to Google Drive

After you've restored a saved backup from your Dropbox storage to HTC Desire 510, remember to change your backup storage and use Google Drive from now on.

1. Open the HTC Backup app.
2. Tap **Change backup settings**.
3. Tap  > **Select storage service**.
4. Select **Google Drive**, and then tap **OK**.
5. Sign in to your Google Account, if you haven't done so.

---

## Backing up your data locally

---

If you want to separately back up your content such as contacts and text messages on HTC Desire 510, here are some tips on how to export or import your data.

### Backing up your contacts

1. Open the People app.
2. On the People tab, tap  > **Manage contacts**.
3. Tap **Import/Export contacts** > **Export to phone storage** or **Export to SD card**.
4. Select an account or type of contacts to export.
5. To help protect your data, tap **Yes**, and then set a password for this backup. Be sure to remember this password. You'll need to enter it again when importing contacts.

If you don't need a password, tap **No**.

6. Tap **OK**.

### Restoring contacts

1. On the People tab, tap  > **Manage contacts**.
2. Tap **Import/Export contacts** > **Import from phone storage** or **Import from SD card**.
3. If you have more than one account set up, tap the type for the imported contacts.
4. If you have multiple backups available, select the backup you want to import, and then tap **OK**.
5. Enter the password you've set for this backup, and then tap **OK**.

## Backing up your text messages

Keep important text messages by backing them up to the phone storage. You can easily restore backed up text messages after you've deleted them from your message list.



Text messages in the secure box and blocked messages will not be backed up. To include such messages to your backup, move them first to the general message box.

1. Open the Messages app.
2. Tap > Back up/Restore SMS > Back up > Back up SMS.
3. To help protect your data, set a password for your backup. Be sure to remember this password. You'll need to enter it again when restoring messages. If you don't need a password, select **Do not password protect this backup**.
4. Enter a name for your backup file, and then tap OK.

## Backing up text messages by email



You need to set up your email account in the Mail app.

1. Open the Messages app.
2. Tap > Back up/Restore SMS.
3. Tap Back up > Back up SMS via mail.
4. To help protect your data, set a password for your backup. Be sure to remember this password. You'll need to enter it again when restoring messages. If you don't need a password, select **Do not password protect this backup**.
5. Enter your email address.
6. Compose your email message, and then send it.

## Restoring text messages

1. Open the Messages app.
2. Tap > Back up/Restore SMS > Restore.
3. Choose how you want to restore the messages, and tap Next.
4. Tap the backup to import.
5. Enter the password you've set for this backup. If you didn't set a password, select **This backup file is not password protected**.
6. Tap OK.

To restore text messages that were backed up via email, open the email message with the backup file attachment from the Mail app. Tap the attachment to download it first,

and then tap it again to open the backup file to import. Enter the password you've set for this backup or select **This backup file is not password protected**.

### Backing up your personal dictionary

You can back up new words you've added to the predictive text dictionary.

1. Go to Settings, and then tap **Language & keyboard**.
2. Tap **HTC Sense Input**.
3. Tap **Personal dictionary** >  > **Back up to storage card** or **Back up to email**.
4. When prompted, tap **OK**.

### Importing your personal dictionary

- Go to **Settings** > **Language & keyboard** > **HTC Sense Input**. Tap **Personal dictionary** >  > **Restore from storage card**.
- To import your personal dictionary backed up via email, open the email message with the backup file attachment from the Mail app. Tap the attachment to download it first, and then tap it again to open the backup file to import.

### Backing up or restoring tasks

1. Go to the list that contains the tasks you want to back up.
2. Tap  > **Import/Export**.
3. Tap **Export to SD card** to back up your tasks, or tap **Import from SD card** to restore tasks on HTC Desire 510.

## HTC Sync Manager

---

### About HTC Sync Manager

---

HTC Sync Manager supports a computer running a Windows or Mac operating system.

Here's what you can do with HTC Sync Manager.

### View and manage media on your computer and phone

- Browse and manage music, photos, and videos that are on your computer and your phone.
- Import iTunes and Windows Media® Player playlists from your computer to HTC Sync Manager.
- Play music, videos, and playlists using the built-in player.

## Transfer content

- Transfer iPhone photos, text messages, contacts, and more to your HTC phone. You can also find and install the same apps that you were using on your iPhone.
- Import all music, photos, and videos from your HTC phone to your computer.
- Copy selected music, photos, or videos from your computer to your phone.
- Import documents from your computer to your phone.

## Back up and restore

Back up your HTC phone to your computer so you can easily restore your backup to the same phone or to another HTC phone.

## Sync playlists and data

Sync music playlists and data such as contacts and calendar between your phone and your computer.

---

### Installing HTC Sync Manager on your computer

---



- You can install HTC Sync Manager on Windows XP or later versions. To install it on a Mac computer, you need Mac OS 10.6 or later versions.
- If you have problem in installing HTC Sync Manager, close all your running programs and reinstall. If the problem persists, temporarily disable your anti-virus program and try installing again.

1. Download the HTC Sync Manager installer from the HTC support site: [htc.com/hsm/](http://htc.com/hsm/).
2. Launch the installer and follow the onscreen instructions.
3. Connect your phone to your computer using the supplied USB cable. HTC Sync Manager opens.



If you disabled your anti-virus program, make sure to turn it back on after installing HTC Sync Manager.

---

## Transferring iPhone content and apps to your HTC phone

---

With HTC Sync Manager, easily transfer iPhone content such as contacts, messages, wallpaper, camera photos, and more to your HTC phone. If you're using an HTC phone that has HTC Sense 6, HTC Sync Manager also enables your phone to find and install the same apps that you were using on your iPhone.



You need to use iTunes 9.0 or later to back up your iPhone content first to your computer.

1. Connect your iPhone and your HTC phone to your computer.
2. In HTC Sync Manager, click **Home > Transfer & Backup**.
3. Click the **Get Started** button.
4. If you haven't used iTunes to back up your iPhone content to your computer, please do so before proceeding.
5. Select your iPhone backup file, and then click **OK**.
6. Select the types of content you want to transfer to your HTC phone.  
You can choose whether to replace the content on your HTC phone with the iPhone content.
7. Click **Start**. Wait for HTC Sync Manager to finish transferring content.
8. When done, slide open the Notifications panel on your HTC phone, and then tap .  
Choose which apps you were using on iPhone you want to find in Google Play and download to your HTC phone.

---

## Getting help

---

To find out more about using HTC Sync Manager, download the user guide PDF from the HTC support site ([htc.com/hsm/](http://htc.com/hsm/)). Or open the Help that comes with the software.



On Windows, click  in HTC Sync Manager, and then click **Help**.

## Reset

### Restarting HTC Desire 510 (Soft reset)

If HTC Desire 510 is running slower than normal, is unresponsive, or has an app that is not performing properly, try rebooting and see if that helps solve the problem.

1. If the display is off, press the POWER button to turn it back on. If you've set up a lock screen, you need to unlock it.
2. Press and hold the POWER button, and then tap **Restart**.
3. When asked to confirm, tap **Restart**.



If these steps don't work, you can remove and reinstall the battery, and then turn HTC Desire 510 on to restart it.

### Resetting HTC Desire 510 (Hard reset)

If HTC Desire 510 has a persistent problem that cannot be solved, you can perform a factory reset (also called a hard reset or master reset). A factory reset reverts the phone back to its initial state — the state before you turned on the phone for the first time.

The following will be removed from the phone when you do a factory reset:

- Your Google Account
- All accounts you've added in **Settings > Accounts & sync** and the data associated with these accounts
- Personal data that you've created or synced to the phone such as your profile, contacts, messages, email, calendar events, and more
- System and application data and settings
- Downloaded apps

Files such as your music, photos, videos, and documents can also be deleted from the storage, if you chose to do so.

Be sure to back up any data and files you want to keep before you do a factory reset.



A factory reset may not permanently erase all data from your phone, including personal information.

#### Performing a factory reset from settings

1. Go to **Settings**, and then tap **Backup & reset**.
2. Tap **Reset phone**.

3. If you want to delete media, documents, and other data from the phone storage, select **Erase all data**.

To also delete media and other data from your storage card, select **Erase SD card**.

4. Tap **OK**.

#### Performing a factory reset using hardware buttons

If you can't turn HTC Desire 510 on or access settings, you can still perform a factory reset by using the hardware buttons on HTC Desire 510.



The **Fast boot** option in **Settings > Power** must not be selected.

1. Remove the battery, wait for a few seconds, then reinsert the battery.
2. Press and hold the **VOLUME DOWN** button, and then press and hold the **POWER** button.
3. Wait for the screen with the three Android images to appear, and then release the **POWER** and **VOLUME DOWN** buttons.
4. Press **VOLUME DOWN** to select **FACTORY RESET**, and then press the **POWER** button.



# People

## Your contacts list

The People app lists all contacts you've stored on HTC Desire 510 and from online accounts you're logged in to. Use the People app to easily manage communications with people that matter to you.

1. Open the People app.

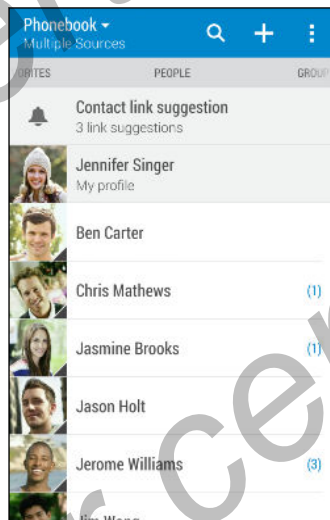

2. On your contacts list, you can:
  - View your profile and edit your contact information.
  - Create, edit, find, or send contacts.
  - Tap a contact photo to find ways to quickly connect with the contact.
  - See when a contact has sent you new messages.



To sort your contacts by their first or last name, tap **☰** > Settings > Sort contacts by.

## Filtering your contacts list

When your contacts list gets long, you can choose which contact accounts to show.

1. On the People tab, tap **▼**.
2. Choose the accounts that contain the contacts you want to display.
3. Press **↶**.

## Finding people

Search for contacts stored on HTC Desire 510, your company directory if you have an Exchange ActiveSync account, or social networks you've signed into.

1. Open the People app.
2. On the People tab, you can:
  - Find people in your contacts list. Tap **Q**, and then enter the first few letters of the contact name in the Search people box.
  - Find people on your company directory. Tap **Q**, enter the first few letters of the contact name in the Search people box, and then tap **Search contacts in your Company Directory**.
  - Search for people you know on your social networks. Tap **☰** > **Settings** > **Find people you know on**, and then select the social networks you're signed in to. The People app then uploads your contacts to the selected social networks to help you find friends.



Aside from searching for a contact by name, you can search using a contact's email address or company name. On the People tab, tap **☰** > **Settings** > **Search contacts by**, and then choose a search criteria.

## Setting up your profile

Store your personal contact information to easily send it to other people.

1. Open the People app.
2. Tap **My profile**.
3. Tap **Edit my contact card**.
4. Enter or edit your name and contact details.
5. Tap **📷** or the current photo to change your contact photo.
6. Tap **Save**.

Aside from your contact details, your profile also shows updates you've posted on your social networks and your online photo albums.

## Adding a new contact

1. On the People tab, tap **+**.
2. Tap the **Name** field, and then enter the contact name. Tap **📄** to separately enter the contact's given, middle, or family name and name suffix, such as Jr.
3. Select the Contact type. This determines which account the contact will sync with.

4. Enter the contact information in the fields provided.
5. Tap **Save**.

When you tap the added contact in your contacts list, you'll see the contact information and your exchange of messages and calls. Depending on the contact type, you may also see the person's social network updates or events.

### How do I add an extension number to a contact number?

While creating a new contact in People, you can add an extension number to their number so you can skip the voice prompts when calling.

1. After entering the number of the main line, do one of the following:
  - Tap **P(,)** to insert a pause before the extension number is dialed automatically. To make the pause longer, tap **P(,)** again.
  - Tap **W(;)** to be prompted to confirm the extension number.
2. Enter the extension number.

## Editing a contact's information



Social network contacts cannot be edited.

1. On the People tab, press and hold the contact, and then tap **Edit contact**.
2. Enter the new information.
3. Tap **Save**.

## Getting in touch with a contact

1. Open the People app.
2. Tap a contact's photo (not the name), and then choose how you want to get in touch with that contact.

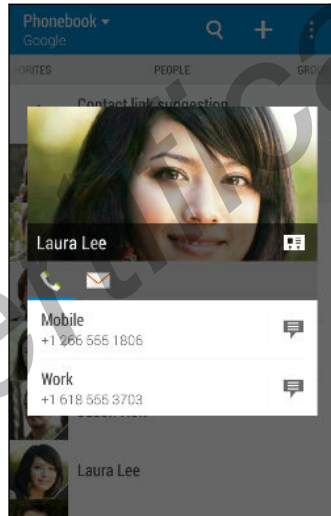

For more ways of getting in touch with your contact, tap an icon below the contact photo.

## Importing or copying contacts

### Importing contacts from your micro SIM card

1. On the People tab, tap > Manage contacts.
2. Tap Import/Export contacts > Import from SIM card.
3. If prompted, select which account you'd like to import your contacts to.
4. Select the contacts you want to import.
5. Tap Save.

### Importing a contact from an Exchange ActiveSync account

1. On the People tab, tap and enter the contact's name or email address in the search box.
2. Tap Search contacts in your Company Directory.
3. Tap the name of the contact you want copied to HTC Desire 510.
4. Tap to import the contact.

## Copying contacts from one account to another



Contacts from your social network accounts may not be copied.

1. On the People tab, tap > **Manage contacts**.
2. Tap **Copy contacts**, and then choose a contact type or online account to copy from.
3. Select a contact type or account you want to save to.

## Merging contact information

Avoid duplicate entries by merging contact information from different sources, such as your social network accounts, into one contact.

### Accepting contact link suggestions

When HTC Desire 510 finds contacts that can be merged, you'll see a link notification when you open the People app.

1. On the People tab, tap the Contact link suggestion notification when available. You'll see a list of suggested contacts to merge.
2. Tap next to the contact you want to merge. Otherwise, tap to dismiss the link suggestion.



If you don't want to receive contact link suggestions, on the People tab, tap > **Settings**. Clear the **Suggest contact link** option.

### Manually merging contact information

1. On the People tab, tap the name of the contact (not the icon or photo) you want to link.
2. Tap > **Link**.
3. You can:
  - Under **Suggest links**, link the contact to an account.
  - Under **Add contact**, tap one of the options to link to another contact.

### Breaking the link

1. On the People tab, tap the name of the contact (not the icon or photo) whose link you want to break.
2. Tap > **Link**.
3. Under the **Linked contacts** section, tap beside an account to break the link.

## Sending contact information

1. On the People tab, do one of the following:

To send	Do this
Someone's contact information	Press and hold the name of the contact (not the icon or photo), and then tap <b>Send contact as vCard</b> .
Your contact information	Press and hold <b>My profile</b> , and then tap <b>Send my profile</b> .

2. Choose how you want to send the vCard.
3. Select the type of information you want to send.
4. Tap **Send**.

---

### Sending multiple contact cards

---

1. On the People tab, tap **⋮** > **Send contacts**.
2. Select the contacts whose contact information you want to share.
3. Tap **Send**.
4. Choose how you want to send the contact cards.

## Contact groups

Organize your friends, family, and colleagues into groups so you can quickly send a message or email to everyone in the group. We've also set up the **Frequent** group to automatically add the contacts you dial or get calls from the most.

HTC Desire 510 also syncs with groups you've created in your Google Account.

---

### Creating a group

---

1. On the Groups tab, tap **+**.
2. Enter a name for the group, and then tap **⋮** > **Add contact to group**.
3. Select the contacts you want to add, and then tap **Save**.
4. When your group is complete, tap **Save**.

## Sending a message or email to a group



You will be charged for each text message sent. For example, if you send a message to a group of five people, you will be charged for five messages.

1. On the Groups tab, tap the group you want to send a message or email to.
2. Go to the Group action tab.
3. Choose if you want to send a group message or group email.

## Editing a group



1. On the Groups tab, press and hold the group, and then tap **Edit group**.
2. You can:
  - Change the group name. You can only change the name for groups that you have created.
  - Add more contacts to the group. Tap  > **Add contact to group**.



Contact not in your list? On the Groups tab, tap the name of the group where you want to add the contact, and then tap  > **Create a new contact**.

- Rearrange the group members. Drag  at the end of the contact's name and move it to its new position.
  - Select the contacts you want to remove from the group.
3. Tap **Save**.

## Managing your contact groups

1. On the Groups tab, tap  > **Edit groups**.
2. You can:
  - Rearrange the contact groups. Drag  at the end of the group name to its new position.
  - Select the contact groups you want to remove.
3. Tap **Save**.

## Private contacts

If you don't want to show a contact's name and photo on the lock screen when you have an incoming call, add the contact to your private contacts list.

## Adding a contact to the private contacts list



On the People tab, press and hold the contact, and then tap **Add to private contacts**.

To view your private contacts list, on the People tab, tap  > **Manage contacts** > **Private contacts**.

---

## Organizing your private contacts

---

1. On the People tab, tap  > Manage contacts > Private contacts.
2. To add contacts to the private contacts list, tap , select the contacts you want to add, and then tap Save.
3. To remove private contacts from the list, tap  > Remove private contact, select the contacts you want to remove, and then tap Remove.



# Email

## Gmail



### Viewing your Gmail Inbox

All your received email messages are delivered to your Inbox.

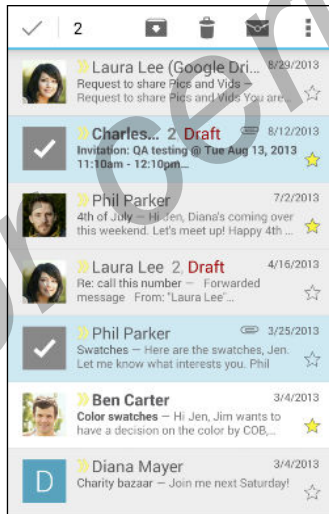
1. Open the Gmail app.
2. Do any of the following from your Inbox.
  - Tap an email message preview to read, forward, or reply to the message.
  - Open the slideout menu to change an inbox category such as **Primary**, switch to other Gmail™ accounts, or display by different email labels.
  - Tap the sender image or letter tile to select one or more messages or conversations. You can then tap the onscreen buttons at the top bar to archive, delete, or mark the selected messages or conversations.





### Sending an email message in Gmail

1. In the inbox of the Gmail account you want to use, tap  (or tap  > Compose).
2. Fill in one or more recipients.



Want to loop in more recipients in a carbon copy (Cc) or blind carbon copy (Bcc) of the email message? Tap  > Add Cc/Bcc.



3. Enter the email subject, and then compose your message.

4. If you want to attach a photo, video or file, tap  > **Attach file**, tap the attachment source, and then select the files you want.
5. Tap  to send.

---

### Replying to or forwarding email messages in Gmail

---

1. In the Gmail inbox, tap the email message or conversation.
2. To reply to the sender, tap . Or, tap  and choose whether to **Reply all** or **Forward**.
3. Do one of the following:
  - If you're replying to the sender or you selected **Reply all**, enter your reply message.
  - If you selected **Forward**, specify the message recipients.



Tap **Respond inline** if you want to interleave your new message with the received email. But this removes any attachments or formatting in the original email message.

4. Tap  to send.

## Mail

### Checking your mail

The Mail app is where you read, send, and organize email messages from one or more email accounts that you've set up on HTC Desire 510.

1. Open the Mail app. The inbox of one of your email accounts appears.
2. Do any of the following:
  - Tap an email message to read.
  - To display email messages in another mail folder, tap **☰** > **Folder**, and then tap the folder you want to view.
  - To switch between email accounts or view email messages from all your accounts, tap **☰**.

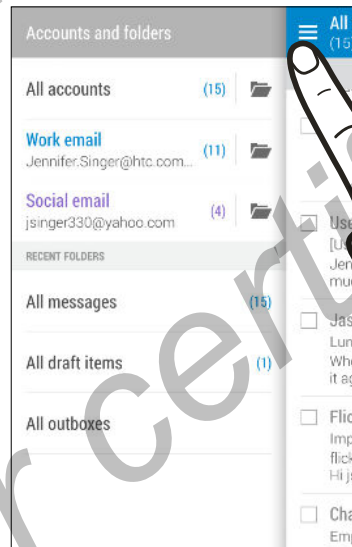

- To change an email account's settings, select the account first and then tap **☰** > **Settings**.

### Organizing your inbox

Do you have a big pile of email messages in your inbox? Organize your email messages into tabs and quickly find the messages you want.

1. Switch to the email account that you want to use.
2. In the inbox, tap **☰** > **Edit tabs**.
3. Select the tabs you want to add to the inbox.
4. To arrange the tabs, drag **☰**, and then move the tab to its new location.
5. Tap **Done**.
6. Swipe to the added tab to check your email messages.

## Sending an email message

1. Open the Mail app.
2. Switch to the email account that you want to use.
3. Tap **+**.
4. Fill in one or more recipients.



Want to loop in more recipients in a carbon copy (Cc) or blind carbon copy (Bcc) of the email message? Tap **⋮** > **Show Cc/Bcc**.

5. Enter the subject, and then compose your message.
6. Do any of the following:
  - Add an attachment. Tap **📎** and then choose what you want to attach.
  - Set the priority for an important message. Tap **⋮** > **Set priority**.
7. Tap **✉**.



To save the email as draft and send it later, tap **⋮** > **Save**. Or press **↶**.

### Resuming a draft email message

1. In an email account inbox, tap **⋮** > **Folder** > **Drafts**.
2. Tap the message.
3. When you finish editing the message, tap **✉**.

## Reading and replying to an email message

1. Open the Mail app.
2. Switch to the email account you want to use.
3. In the email account inbox, tap the email message or conversation you want to read.



If you want to read a particular message inside an email conversation, tap **⌵** to expand the conversation, and then tap the email message.

4. Tap **Reply** or **Reply All**.



Tap **⋮** for more actions for the email.

### Quickly replying to an email message

You can quickly respond to a new email message from the Home screen or lock screen.

1. When you receive a new email message notification, slide the Notifications panel down.
2. On the email preview, tap **Reply all**.  
If you have several notifications and you don't see the email options, expand the email preview by sliding two fingers apart on the notification.
3. Compose your reply message and tap .

### Saving an image in an email message



Depending on your mail size limit settings, you may need to tap **Display images** to see images that are embedded in an email.

While viewing an email message, press and hold an embedded image, and then tap **Save image**. You'll find the saved image under the Downloads folder.

You can also copy the image to the clipboard or set it as your wallpaper.

### Saving an email message in the Tasks app

Save an email message in your Tasks list so you can remind yourself when to reply.

1. In an email account inbox, press and hold the email message, and then tap **Save as task**.
2. Enter the task details, and then tap **Save**.

---

## Managing email messages

---

The Mail app provides easy ways to sort, move, or delete your email messages.

### Sorting email messages

Customize how you sort your email messages.

In an email account inbox, tap  > **Sort**, and select from the sorting options.

### Moving email messages to another folder

1. Switch to the email account you want to use.
2. Select the email messages you want to move.



To select all, select one email message first, and then tap  > **Select all**.

3. Tap **Move to**, and then select a folder.

## Deleting email messages



1. Switch to the email account you want to use.
2. Select the email messages you want to delete.



To select all, select one email message first, and then tap  > **Select all**.

3. Tap **Delete**.

## Searching email messages

1. Tap .
2. If you want to refine or filter your search, tap , check the search options, and then tap **OK**. For example, you can focus the search on a part of an email or filter email messages that have attachments or tagged as high priority.
3. In the search box, enter the words you want to search for.
4. Tap a result to open the email message.

## Searching for emails from a contact

Do you remember the sender, but can't find a particular email from him or her?

1. Switch to the email account you want to use.
2. Press and hold an email message from a contact.
3. Tap **Show all mail from sender**. A list of email messages from that contact appears.

## Working with Exchange ActiveSync email

Enjoy the powerful email features of Microsoft Exchange ActiveSync right on HTC Desire 510. Flag important email messages, set your out of the office reply, or send invites to your next team meeting while you're on the go.

## Flagging an email

1. Switch to your Exchange ActiveSync account.
2. While viewing the inbox, tap the flag icon that appears beside an email message or conversation.



To flag an email message inside a conversation, tap  to expand the conversation, and then tap the flag icon of the email message.

## Setting your Out of the office status

1. Switch to your Exchange ActiveSync account.
2. Tap  > **Out of the office**.

3. Tap your current office status, and then select **Out of the office**.
4. Set the dates and times.
5. Enter the auto-reply message.
6. If you want a different auto-reply message for recipients outside your organization, tap the **Send replies to external senders** option, and then enter the auto-reply message in the box.
7. Tap **Save**.

#### Sending a meeting request

1. Switch to your Exchange ActiveSync account.
2. Tap  > **New meeting invitation**.
3. Enter the meeting details.
4. Tap **Save**. Or tap **Send** if you've invited people to the meeting.

---

#### Adding an email account

---

Set up additional email accounts such as another Microsoft Exchange ActiveSync account or an account from a Web-based email service or email provider.

 If you're adding a Microsoft Exchange ActiveSync or a POP3/IMAP email account, ask your network administrator or email service provider for additional email settings that you may need.

1. Open the Mail app.
2. Tap  > **Add account**.
3. Select an email account type from the list of email providers. Otherwise, tap **Other (POP3/IMAP)**.
4. Enter the email address and password for your email account, and then tap **Next**.



Some email accounts allow you to set the sync schedule. By default, HTC Desire 510 uses Smart Sync to save battery power. See [What is Smart Sync?](#) on page 127.

5. Enter a name for your email account, and then tap **Finish setup**.

---

#### What is Smart Sync?

---

Smart Sync automatically extends the sync time the longer the Mail app is inactive. Set your email account to Smart Sync when you don't need to check new email messages frequently. Smart Sync helps save battery power.

If you want to receive email messages as they arrive, select another **Peak time sync** and **Off-peak sync** schedule in the email account's **Sync, Send & Receive** settings.

# Calendar

## Viewing the Calendar

Use the Calendar app to view your events, meetings, and appointments. If you've signed into your online accounts, related events will also appear in Calendar.

1. Open the Calendar app.
2. Tap , and then choose a calendar view.



In any calendar view, return to the current date by tapping .

### Month view

In month view, you will see markers on days that have events. Upcoming events for the day are also shown at the bottom of the screen.

- Swipe left or right across the screen to view succeeding or previous months.
- Tap a day to view the events for that day.
- Press and hold a day to see more options.

### Day and agenda views

Day view shows your day's schedule and weather forecast for the next few days, while agenda view gives a quick glance of all your day's events.

- Swipe left or right across the screen to view succeeding or previous days.
- Tap an event to view its details.
- If the event is a contact's birthday or anniversary, tap it to send a greeting.



Need to see the event time in another time zone? In Day view, tap  > **Select 2nd time zone** > **Choose location**, and then enter the city name.

### Week view

Week view displays a chart of the events of one week.

- Swipe left or right across the screen to view succeeding or previous weeks.
- Tap an event (shown as colored blocks) to view its details.



## Scheduling or editing an event

You can create or edit events on HTC Desire 510, and also sync events with your Exchange ActiveSync calendar. You can also create, modify, and sync events with your Google calendar.



Editing events is not supported for all accounts.

1. Open the Calendar app.
2. On any Calendar view, do one of the following:

**Create an event** Tap **+**. Tap **▼**, and then select the calendar you will add the event to.

**Edit an event** View an event, and then tap .

3. Enter and set the event details.
4. To invite contacts from your Exchange ActiveSync account, tap . You can also invite contacts from your Google account.
5. Tap **Save**.

If you've invited people to the event, tap **Send** or **Send update**.

### Checking your schedule for an event

Avoid juggling multiple meetings at the same time. In Calendar, you can check your appointments to see if a new event would conflict with your schedule.

1. When creating or editing an event, tap **Check calendar**.
2. Press and hold the event box, and then drag it to an available time slot.
3. Drag the top and bottom nodes to adjust the event's time duration. You'll see a message if there are conflicts with other scheduled events.
4. Tap **Done** to return to the event screen, and then save your event.

## Choosing which calendars to show

1. In any calendar view, tap  > **Accounts (All calendars)** or **Accounts (Multi-calendar)**.
2. Select or clear an account you wish to show or hide.

If you have multiple calendars under an online account, tap  to select the items to include.



- Calendars are synced on HTC Desire 510, even if they are hidden.
- You can also show or hide tasks that you've created on HTC Desire 510.

## Sharing an event

You can share a calendar event as a vCalendar using Bluetooth or by sending it as a file attachment with your email or message.

1. Do one of the following:
  - While viewing an event, tap  > **Share via**.
  - In day, agenda or week view, press and hold an event and then tap **Share via**.
2. Choose how you want to send the event.



You can also forward accepted meeting invitations from your Exchange ActiveSync calendar. While viewing an event, tap  > **Forward**. Compose your email message, and then send it.

## Accepting or declining a meeting invitation

Switch to Invites view to see meeting invitations which you have not yet accepted or declined.



You must set up an Exchange ActiveSync account to receive meeting invitations in Calendar.

1. Open the Calendar app.
2. Tap  > **Invites**, and then tap a meeting invitation.
3. Accept, decline, or tentatively accept the invitation, or propose a new time.



Tap  to choose from more options, such as moving the invitation to a folder.

If you need to cancel an accepted meeting invitation or propose a new time, view the event details in Calendar, and then tap **Response**.

## Dismissing or snoozing event reminders

If you have set at least one reminder for an event, the upcoming event icon  will appear in the notifications area of the status bar to remind you.

1. Slide the Notifications panel open.
2. If the notification shows that there are multiple reminders, tap it to see all the reminders. You can then choose to snooze or dismiss them.
3. If you see a single event notification, spread your two fingers on the notification to expand it. You can then:
  - Tap **Snooze** or **Dismiss**. Or drag the notification left or right to dismiss it.
  - Tap **Send mail** to send a quick response to the meeting attendees.



To edit the preset quick responses or add your own, open Calendar, and then tap **> Settings > Quick response**.

If you don't want to dismiss or snooze the calendar reminders, press  from the Notifications panel to keep them pending in the notifications area of the status bar.

# Travel and maps

## Location settings

### Turning location services on or off

In order to find your location on HTC Desire 510, you need to enable location sources.

1. Go to Settings, and then tap **Location**.
2. Tap the **On/Off** switch to turn location services on and off.
3. Under Location sources, select the location mode you want. For example, for a better estimate of your location, choose **High accuracy**. To save battery power, choose **Battery saving**.

Turning off a location source (for example GPS) means no applications on HTC Desire 510 will collect your location data through that location source. However, third party applications may collect — and HTC Desire 510 may continue to provide — location data through other sources, including through Wi-Fi and signal triangulation.

## Google Maps

### About Google Maps

Google Maps™ lets you track your current location, view real-time traffic situations, and receive detailed directions to your destination.





It also provides a search tool where you can locate places of interest or an address on a map, or view locations at street level.



- To find your location with Google Maps, you need to enable location sources.
- The Google Maps app does not cover every country or city.

### Getting around maps

When you open Google Maps, you can easily find your location on the map or check out nearby places by panning and zooming in and out on the map.

1. Open the Maps app.
2. Tap  to show your current location. The blue marker  or  shows your current location on the map.
3. If you want to see more information overlaid on the map, tap , and then tap a map view such as **Traffic** or **Public transit** to toggle the view on and off.

## Navigating the map

You can navigate the map using finger gestures.

- Slide your finger in any direction to pan.
- Double-tap the map or slide two fingers apart over an area to zoom in.  
To zoom in while holding the phone with one hand, double-tap with your thumb and hold the second tap, and then drag your thumb down.
- Double-tap the map with two fingers or slide two fingers together over an area to zoom out.  
To zoom out while holding the phone with one hand, double-tap with your thumb and hold the second tap, and then drag your thumb up.
- Press and hold an area with two fingers and then drag your fingers in a circular motion to rotate the map.
- Press and hold an area with two fingers and then swipe up to see an angled view of the map. Swipe down to return to overhead view.

---

## Searching for a location

---

Use Google Maps to search for a location, such as an address or a type of business or establishment (for example, museums).

1. Open the Maps app.
2. Tap the search box and then enter the place you want to search for.
3. Tap the **Enter** key on the keyboard or tap a suggested search item. The first location on the search appears with a place marker  and its info sheet displays at the bottom of the screen. All other search results are indicated by a red dot or a smart map icon.

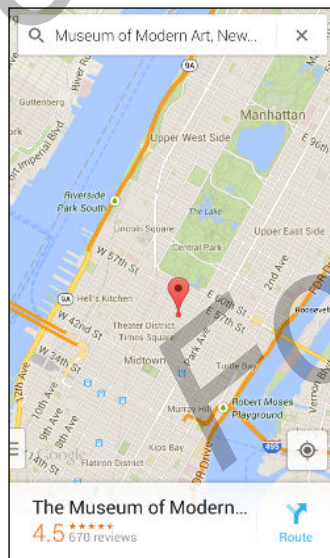

4. If there is more than one search result, tap  to view the search results list.

5. Tap the info sheet to check the address, get directions, see the location in Street View (if available), and more.
6. To check the next or previous location on the search, swipe the info sheet left or right.

To clear the map and search for another location, swipe the info sheet down (if it's expanded), and then tap **X**.

---

### Getting directions

---

Get detailed directions to your destination. Google Maps provides travel directions by car, public transit, bike, or foot.

1. Open the Maps app.
2. Tap **📍**.
3. Choose how you want to get to your destination.
4. Use your current location as starting point, or tap **My location** to enter your starting point or select a location from your search history.
5. Tap **Choose destination**, and then enter or select your destination.



If you're taking public transit, tap **🚆** to set the date and time of travel, or tap **Options** to set your route preferences.

6. Tap a route or transit option to view the directions on the map. You'll also see the travel duration on the info sheet at the bottom of the screen.
7. Tap the info sheet to view the directions in a list.

When you're finished viewing or following the directions, tap **X** to reset the map. Your destination is automatically saved in the Google Maps history.

## HTC Car

---

### On the road with HTC Car

---

Now when you drive, you can easily use HTC Desire 510 to reach your destination, keep you entertained, and help you stay in touch with the people that matter to you. Access music, phone calls, maps, and more with HTC Car.

1. HTC Car instantly launches when you mount HTC Desire 510 in HTC Car Kit.
2. Swipe up or down to see what you can do in HTC Car.



When using HTC Car, return to the main screen from any other screen by pressing **🏠**.

When you remove HTC Desire 510 from HTC Car Kit, HTC Car will automatically exit. You can also manually close HTC Car by pressing **↶** from the main screen.

---

### Finding places in HTC Car

---

1. In HTC Car, tap **Navigation**.
2. To search for a place, tap **Q** and enter a location in the search box.
3. To look up a previously searched for place, tap **Previous**.
4. To get directions for an upcoming event in Calendar, tap **Appointments** and then tap an upcoming appointment.

---

### Exploring what's around you

---

Feeling adventurous? With just a few taps, you can find interesting places around you quickly.

1. In HTC Car, tap **Navigation**.
2. Tap a category, for example **Restaurant** or **Parking** to see what's available near you.
3. Tap **Q** to enter your own search keywords.

---

### Playing music in HTC Car

---

1. In HTC Car, tap **Music**.
2. Swipe left or right to browse by category.
3. Tap **Q** to search your collection.
4. Tap an album, song, or playlist to listen to it.

---

### Making phone calls in HTC Car

---

- Tap **Dialer** to open the dialpad.
- Tap **People** and then browse a category or search by entering a name.

---

### Handling incoming calls in HTC Car

---

When you receive an incoming call, you can easily answer or decline.

Tap **Answer** or **Decline**.

---

### Customizing HTC Car

---

- To change the default behavior of HTC Car, tap **Settings**.
- To add more apps to HTC Car, tap **+** and select an app.

## Other apps

### Using the Clock

Get more from the Clock app than just the regular date and time. Use HTC Desire 510 as a world clock to see the date and time in cities across the globe. You can also set alarms or track your time using the stopwatch or timer.

---

#### Setting the date and time manually

---

1. Open the Clock app.
2. On the World Clock tab, tap  > Local time settings.
3. Clear **Automatic date & time** and **Automatic time zone**, and then set the time zone, date, and time as required.



To display military time, choose the **Use 24-hour format** option.

---

#### Setting an alarm

---

You can set up one or more alarms.

1. Open the Clock app.
2. On the Alarms tab, select the check box of an alarm and then tap that alarm.
3. Under Set alarm, use the scroll wheels to set the alarm time.
4. If you want the alarm for multiple days, tap **Repeat**.
5. Tap **Done**.



- To turn off an alarm, clear the check box of that alarm.
- If you need to set more than three alarms, tap **+**.



## Checking Weather

Use the Weather app and widget to check the current weather and weather forecasts for the next few days. In addition to your current location, you can view weather forecasts for other cities around the globe.

1. Open the Weather app. You'll see the weather for different cities, including where you are.
2. Tap a city to view weather information.
3. Swipe to the Hourly and Forecast tabs to view the forecast in your selected location.
4. To check the weather in other cities, tap ▼, and then select the city you want.
5. To add more cities, tap + and then enter the location.

Your settings in the Weather app also control the weather information that is shown in the Clock and Calendar.

## Recording voice clips

Use Voice Recorder to capture information during lectures, interviews, or even to create your own audio log.

1. Open the Voice Recorder app.
2. Hold the microphone near the sound source.
3. Tap ● to start recording a voice clip.



Voice Recorder can run in the background while you do other things on HTC Desire 510, except when you open other apps that also use audio functions.

4. Tap ■ to stop recording.

To play back the voice clip, tap ▶.



To see your recorded voice clips, tap ◀. Press and hold a voice clip to see options for sharing, setting it as a ringtone, and more.

## Keeping track of your tasks

Use the Tasks app to organize and track to do and task lists. Create tasks on your phone or sync them with your Microsoft Exchange ActiveSync account. You can also sync tasks with your Google account.

You can even choose to see your tasks in the Calendar app .

### Creating a task

1. Open the Tasks app.
2. To select the task account where you want to create the task, tap ▼ .
3. Tap + , and then enter the task details.



Tasks created under My tasks can be linked to a contact (tap 👤) or to a location (tap 📍).

4. Tap Save.

### Managing tasks

1. Go to the list that contains the task.
2. In the list of tasks, you can:
  - Tap the check box next to the task to mark a task complete.
  - Press and hold a task to delete, postpone, or move it to another list.
  - Tap ☰ to view completed tasks, sort them, and more.

### Managing task lists

1. In the Tasks app, tap ☰ > Manage lists.
2. From here, you can:
  - Tap a list to show all tasks under that list.
  - Tap + and choose an account to create a list.



You can't create lists for Microsoft Exchange ActiveSync accounts.

- Tap ⋮ to rename or delete a list.



Some lists can't be deleted.

## Kid Mode

Worried that your kids might wander off to inappropriate web sites or mess with your important work files while using HTC Desire 510? Use Kid Mode™ to let your children enjoy fun and age-appropriate games and more, while helping to protect your important data from accidental deletion. To learn more about Kid Mode, visit [www.zoodles.com](http://www.zoodles.com).

### Creating a child profile

1. Open **Parent Dashboard** from the All Apps screen. The first time you use Kid Mode, you need to create or sign in to your account.
2. Tap the default name at the top of the screen, and then tap **Add Child**.
3. Fill out the information on the screen and then tap **Save**.

### Switching to Kid Mode

1. Open the Kid Mode app.
2. If prompted, follow the instructions on the screen to set a child lock.
3. On the Zoodles™ main screen, tap the profile that you created for your child.
4. Tap the icons to access games and apps, play recorded storybook readings, and more.

### Setting child-accessible apps in Kid Mode

When in Kid Mode, you can choose which apps on HTC Desire 510 your child will have access to.

1. Open **Parent Dashboard** from the All Apps screen. You can also go to **Parent Dashboard** from **Settings > Security > Kid Mode**.
2. Confirm your action by entering the required information.
3. Under **Basic Features**, tap **Apps**. You'll see a list of apps installed on HTC Desire 510.
4. Tap the check option beside the app that you want your child to be able to use in Zoodles.



Want to receive or block incoming calls while in Kid Mode? Tap  > **Device Options**, and then select or clear the **Allow Incoming Calls** option.

### Closing Kid Mode

On the Zoodles main screen, tap  and then confirm your action by entering the required information.

# Internet connections

## Turning the data connection on or off

Turning your data connection off saves battery life and money on data charges.



You need a 4G/LTE plan to use your operator's 4G/LTE network for voice calls and data services. Check with your operator for details.

1. With two fingers, swipe down from the status bar to open Quick Settings.
2. Tap the **Mobile data** tile to turn the data connection on and off.



If you don't have the data connection turned on and you're also not connected to a Wi-Fi network, you won't receive automatic updates to your email, social network accounts, and other synced information.

## Managing your data usage

If you're on a limited data allowance, it's important to keep track of the activities and apps that usually send and receive data, such as browsing the web, syncing online accounts, and sending email or sharing status updates.

Here are some other examples:

- Streaming web videos and music
- Playing online games
- Downloading apps, maps, and files
- Refreshing apps to update info and feeds
- Uploading and backing up your files to your online storage account
- Using HTC Desire 510 as a Wi-Fi hotspot
- Sharing your mobile data connection by USB tethering

To help you save on data usage, connect to a Wi-Fi network whenever possible and set your online accounts and emails to sync less frequently.

## Turning data roaming on or off

Connect to your mobile operator's partner networks and access data services when you're out of your mobile operator's coverage area.



Using data services while roaming may be costly. Check with your mobile operator for data roaming rates before you use data roaming.

1. With two fingers, swipe down from the status bar to open Quick Settings.
2. If Mobile data is off, tap the **Mobile data** tile to turn it on.
3. Tap **⋮**. The Mobile network settings screen opens.
4. Select or clear the **Data roaming** option.

Select the **Data roaming sound** option if you'd like HTC Desire 510 to play a sound so you'll know when it's connecting to a roaming network.

## Keeping track of your data usage

Monitor your data usage to help prevent going over your monthly data allowance.



Data usage measured by HTC Desire 510 may differ from, and be less than, your actual data usage.

1. Go to Settings, and then under Wireless & networks, tap **More**.
2. Tap **Data usage**.
3. On the Mobile tab, select **Limit mobile data usage** and tap **OK** to automatically disable your data connection when you reach the set limit.
4. Drag the upper **LIMIT** line to set your monthly data limit.
5. Select **Alert me about data usage**, and then drag the lower **ALERT** line to set an alert before you reach your monthly data limit.
6. Tap **Reset data usage**, and then set the day of the month when your usage cycle resets. This date is usually the start of your monthly billing cycle.
7. Drag the vertical line markers to see how much data you've used during a particular time interval.



If you're connecting HTC Desire 510 to another portable Wi-Fi hotspot, tap **⋮** > **Mobile hotspots** to restrict background data from downloading that may incur extra data fees.

## Viewing the data usage of apps

1. Go to Settings, and then under Wireless & networks, tap **More**.
2. Tap **Data usage**.
3. On the Mobile tab, drag the vertical line markers to see how much data you've used during a particular time interval.

4. Scroll down the screen to see a list of apps and their data usage info.
5. Tap an app to see more details.

## Wi-Fi

To use Wi-Fi, you need access to a wireless access point or “hotspot”.



The availability and strength of a Wi-Fi signal varies depending on objects the Wi-Fi signal has to pass through (such as buildings or a wall between rooms).

### Turning Wi-Fi on

1. With two fingers, swipe down from the status bar to open Quick Settings.
2. Tap the **Wi-Fi** tile to turn Wi-Fi on.
3. Tap **⋮** to see a list of detected wireless networks.



- To manually scan for Wi-Fi networks, tap **⋮** > **Scan**.
- If the wireless network that you want is not listed, tap **⋮** > **Add network** to manually add it.

### Connecting to a Wi-Fi network

1. Turn Wi-Fi on, and check the list of detected Wi-Fi networks.  
See [Turning Wi-Fi on](#) on page 142.
2. Tap a Wi-Fi network you want to connect to.
3. If you selected a secured network, enter the network key or password.
4. Tap **Connect**. You'll see the Wi-Fi icon  in the status bar when connected.

### Preventing notifications from unsecured Wi-Fi networks

You can prevent getting notified about unsecured Wi-Fi networks.

1. Turn Wi-Fi on, and check the list of detected Wi-Fi networks.  
See [Turning Wi-Fi on](#) on page 142.
2. Press and hold an unsecured Wi-Fi network you want to stop being notified about, and tap **Block network notification**.
3. To unblock an unsecured Wi-Fi network, press and hold the network name and tap **Unblock network notification**.

## Connecting to a Wi-Fi network via WPS

If you're using a Wi-Fi router with Wi-Fi Protected Setup (WPS), you can connect HTC Desire 510 easily.

1. Turn Wi-Fi on, and check the list of detected Wi-Fi networks.  
See [Turning Wi-Fi on](#) on page 142.
2. Tap **☰** > **WPS Push**, and then press the WPS button on your Wi-Fi router.



To use the Wi-Fi Protected Setup (WPS) PIN method, tap **☰** > **WPS Pin Entry**.

## Logging into a public Wi-Fi network automatically (WISPr)

You can set HTC Desire 510 to automatically log into a public Wi-Fi network that you regularly use. This saves you the trouble of going through the Wi-Fi provider's web authentication every time you connect to their Wi-Fi network. Just add your login credentials to the WISPr (Wireless Internet Service Provider roaming) settings.



The access point of the Wi-Fi network needs to support the WISPr web portal. Consult the Wi-Fi provider for details.

1. With two fingers, swipe down from the status bar to open Quick Settings.
2. If Wi-Fi connection is off, tap the **Wi-Fi** tile to turn it on.
3. Tap **⋮**.
4. Tap **☰** > **Advanced**.
5. Under WISPr settings, select **Auto login** and then tap **WISPr account settings** > **Add a new account**.
6. Enter the service provider name, your login name (the full domain name), and password.
7. Tap **☑** > **Save**
8. Connect to the public Wi-Fi network.



- If you have access to several public Wi-Fi networks, you can add up to five sets of login credentials to the WISPr accounts list.
- In the WISPr accounts list, press and hold an account to remove or edit it.

## Connecting to VPN

Add virtual private networks (VPNs) so you can connect and access resources inside a local network, such as your corporate network.

Before you can connect to your organization's local network, you may be asked to:

- Install security certificates
- Enter your login credentials
- Download and install a required VPN app on HTC Desire 510

Contact your network administrator for details. Also, HTC Desire 510 must first establish a Wi-Fi or data connection before you can start a VPN connection.

---

### Adding a VPN connection

---

 You must first set a lock screen PIN or password before you can use credential storage and set up the VPN.

1. Go to Settings, and then under Wireless & networks, tap **More**.
2. Tap VPN >  > Add VPN profile.
3. Enter the VPN settings and set them up according to the security details your network administrator gave you.
4. Tap **Save**.

---

### Connecting to a VPN

---

1. Go to Settings, and then under Wireless & networks, tap **More**.
2. Tap **VPN**.
3. Tap the VPN that you want to connect to.
4. Enter your log in credentials, and then tap **Connect**. When you're connected, the VPN connected icon  appears in the notification area of the status bar.

You can then open the web browser to access resources such as your corporate network intranet.

---

### Disconnecting from a VPN

---

1. Slide the Notifications panel open.
2. Tap the VPN notification, and then tap **Disconnect**.



## Using HTC Desire 510 as a Wi-Fi hotspot

Share your data connection with other devices by turning HTC Desire 510 into a Wi-Fi hotspot.



- Make sure the data connection is turned on.
- You must have an approved data plan associated with your account from your mobile service provider to use this service. Devices connected to your Wi-Fi hotspot use data from your subscribed data plan.

1. Go to Settings, and then under Wireless & networks, tap **More**.
2. Tap **Mobile network sharing > Portable Wi-Fi hotspot**.

The first time you turn on the Wi-Fi hotspot, you'll need to set it up.

3. Enter a hotspot name or use the default.
4. Enter a password or use the default.

The password is the key other people need to enter on their device so they can connect and use HTC Desire 510 as a wireless router.

5. To help make your Wi-Fi hotspot more secure, tap **⋮ > Advanced**.

Choose from the available settings, and then press **↩**.

6. Tap the Portable Wi-Fi Hotspot **On/Off** switch to turn it on.

HTC Desire 510 is ready to be used as a Wi-Fi hotspot when you see  on the status bar.



To help minimize security risks, use the default security settings and set a strong and unique password.

## Sharing your phone's Internet connection by USB tethering

No Internet connection available for your computer? No problem. Use the data connection of HTC Desire 510 to connect to the Internet.



- To make sure that the USB drivers for HTC Desire 510 are up-to-date, install the latest version of HTC Sync Manager on your computer.
- Make sure you have a USB tethering service enabled by your mobile operator.
- You may need to have USB tethering added to your data plan, and it may incur additional cost. Contact your mobile service provider for details.
- Make sure that mobile data is turned on.

1. Go to Settings, and then under Wireless & networks, tap **More**.
2. Tap **Mobile network sharing > USB network setting > USB tethering** (or **Mobile network sharing > USB tethering**).
3. Connect HTC Desire 510 to your computer using the provided USB cable. The next time HTC Desire 510 connects to a computer, it will remember your settings.

# Wireless sharing

## Bluetooth

### Turning Bluetooth on or off

1. With two fingers, swipe down from the status bar to open Quick Settings.
2. Tap the **Bluetooth** tile to turn Bluetooth on or off.
3. Tap **•••** to see a list of available devices.



Turn off Bluetooth when not in use to save battery power, or in places where using a wireless device is prohibited, such as on board an aircraft and in hospitals.

### Connecting a Bluetooth headset

You can listen to music over a Bluetooth A2DP stereo headset, or have hands-free conversations using a compatible Bluetooth headset.



Before you connect your headset, make it discoverable so HTC Desire 510 can find it. Refer to your headset manual for details.

1. Turn Bluetooth on and check the list of available devices.  
See [Turning Bluetooth on or off](#) on page 147.
2. If you don't see your headset listed, tap **Scan for devices** to refresh the list.
3. Tap the name of your headset in the Available Devices section. HTC Desire 510 pairs with the headset and the headset connection status is displayed in the Paired Devices section.
4. If prompted to enter a passcode, try 0000 or 1234, or consult the headset documentation to find the passcode.

When the Bluetooth headset is connected, you'll see  in the status bar.

## Reconnecting a Bluetooth headset

Normally, you can easily reconnect your headset by switching on Bluetooth on HTC Desire 510, and then turning on the headset.

However, you might have to connect manually if your headset has been used with another Bluetooth device.

1. Turn Bluetooth on and check the list of paired devices.  
See [Turning Bluetooth on or off](#) on page 147.
2. Tap the headset's name in the Paired Devices section.
3. If prompted to enter a passcode, try 0000 or 1234, or consult the headset documentation to find the passcode.

If you still cannot reconnect to the headset, follow the instructions in [Unpairing from a Bluetooth device](#) on page 148, and then follow the steps under [Connecting a Bluetooth headset](#) on page 147.

---

## Unpairing from a Bluetooth device

---

1. Turn Bluetooth on and check the list of paired devices.  
See [Turning Bluetooth on or off](#) on page 147.
2. In the Paired devices section, tap  next to the device to unpair.
3. Tap **Unpair**.

---

## Receiving files using Bluetooth

---

HTC Desire 510 lets you receive various files with Bluetooth, including photos, music tracks, contact info, calendar events, and documents such as PDFs.

 Refer to the device's documentation for instructions on sending information over Bluetooth.

1. Turn Bluetooth on.  
See [Turning Bluetooth on or off](#) on page 147.
2. On the sending device, send one or more files to HTC Desire 510.
3. If asked, accept the pairing request on HTC Desire 510 and on the sending device. You may also be prompted to enter the same passcode or confirm the auto-generated passcode on both devices.  
You'll then get a Bluetooth authorization request.
4. Tap **Pair**.
5. When HTC Desire 510 receives a file transfer request notification, slide the Notifications panel down, tap the incoming file notification, and then tap **Accept**.

6. When a file is transferred, a notification is displayed. Slide the Notifications panel down, and then tap the relevant notification to view the file.
7. You can also tap  > **Show received files** to view files received via Bluetooth.

## HTC Mini+

### About HTC Mini+

Want to multitask and take calls, read text messages, and more while browsing the Web or watching videos? Buy the HTC Mini+ and use it with HTC Desire 510.

Here are some of the things you can do right on HTC Mini+:

- See instant notifications of text messages, calendar events, and email messages.
- Make and receive phone calls.
- View new text messages. Choose a preset response to send a quick reply, or call the sender.
- View ongoing and upcoming calendar events.
- Dismiss or snooze the alarm.
- Use as a laser pointer.
- Use as a remote control for HTC Desire 510. Remotely play music, control the shutter to take photos, or control a PowerPoint® presentation.

For complete details on how to use HTC Mini+, see its user guide.

### Connecting HTC Mini+ to your phone

Use NFC or Bluetooth to pair and connect HTC Mini+ to your phone.



NFC may not be available in some phones.

You only need to pair once. The next time you turn on HTC Mini+, it will automatically reconnect to your phone.

For more convenience, you can purchase and pair with several HTC Mini+ devices. For instance, you can have a device in your living room, bedroom, and study room. You can pair your phone with all HTC Mini+ devices, but your phone can only connect to two at the same time. Disconnect an HTC Mini+ device first before connecting to another one.

#### Pairing via Bluetooth

1. Go to Settings, and then under Wireless & networks, tap **More**.
2. Tap **HTC Mini+**.
3. Follow the instruction and illustration on your phone to turn HTC Mini+ on.
4. Tap **Bluetooth**, and then tap **Next**.

5. Follow the instruction and illustration on your phone to make HTC Mini+ discoverable via Bluetooth.
6. Tap **Connect**.

#### Disconnecting HTC Mini+

Slide the Notifications panel open, and then tap **HTC Mini+** to disconnect.

---

#### Managing HTC Mini+

---

While HTC Mini+ is connected, you can manage it from your phone. You can create your own Quick text replies to add to HTC Mini+, find the device if you misplaced it, and more.

1. Turn HTC Mini+ on.
2. On your phone, turn Bluetooth on. HTC Mini+ then automatically connects to your phone.
3. Go to Settings, and then under **Wireless & networks**, tap **More**.
4. Tap **HTC Mini+**.
5. Under **Paired devices**, tap  next to the HTC Mini+ device name, and then choose what you want to do.

# Settings and security

## Airplane mode

When you enable Airplane (Flight) mode, all wireless radios on HTC Desire 510 are turned off, including the call function, data services, Bluetooth, and Wi-Fi.

When you disable Airplane mode, the call function is turned back on and the previous state of Bluetooth and Wi-Fi is restored.



- You can manually turn Bluetooth and Wi-Fi back on after enabling Airplane mode.
- If USB tethering is turned on, enabling Airplane mode turns it off. You need to manually turn USB tethering on after you disable Airplane mode.

Do any of the following to turn Airplane mode on or off:

- Press and hold **POWER**, and then tap **Airplane mode**.
- With two fingers, swipe down from the status bar to open the Quick Settings panel. Tap the **Airplane mode** tile to turn airplane mode on or off.

When enabled, the Airplane mode icon  is displayed in the status bar.

## Do not disturb mode

Use Do not disturb mode to reject calls, and silence audible alerts and notifications, but still want to have a data connection available.

1. Go to Settings, and then tap **Sound**.
2. Tap the Do not disturb **On/Off** switch to turn it on and off.
3. Tap **Do not disturb** to set when you want Do not disturb to turn off, or to allow the Clock app alarm and timer sounds to play when Do not disturb is on.

The Do not disturb icon  will appear in the notifications area of the status bar. Even when Do not disturb mode is on, you'll still see notification icons in the status bar to alert you of missed calls, new messages, calendar events, alarms, and other notifications.

---

### Allowing incoming calls to bypass Do not disturb mode

---

Add important contacts to an exceptions list so that you can still receive their calls even when Do not disturb mode is on.

1. Go to Settings, and then tap **Sound**.
2. Tap **Do not disturb**.

3. Tap **Do not disturb exceptions** and then tap **+**.
4. Choose whether to select contacts or groups to add to the exceptions list.
5. Select the checkbox to allow incoming calls from contacts on the exceptions list.

To remove contacts or numbers from the exceptions list, tap **⋮** > **Remove contact**.

### Setting a Do not disturb schedule

You can schedule when you want Do not disturb to turn on. For example, if you can set it to turn on during a weekly meeting.

1. Go to Settings, and then tap **Sound**.
2. Tap **Do not disturb**.
3. Tap **Do not disturb schedule** and then tap **+**.
4. Set the start and end times for the schedule.
5. To have the schedule repeat on specific days, tap **Repeat** and select which days you want it to occur.
6. To select which contacts will be allowed to reach you when the Do not disturb schedule is active, tap **Contacts to allow calls**.
7. Tap **Done**.

The schedule will be listed on the Do not disturb schedule screen.

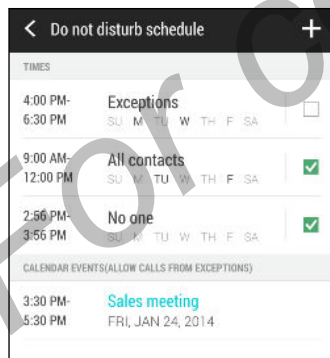

Calendar events that have Do not disturb enabled will also be listed on the Do not disturb schedule screen.



## Scheduling when to turn data connection off

To help conserve power and data usage, you can set a time period when the data connection will automatically turn off during low peak times. This takes effect after the screen has been off for 15 minutes and there's no network activity (no downloads, streaming, or data usage).

1. Go to Settings, and then tap **Power**.
2. Tap **Sleep mode**.
3. To manually change the settings, clear **Learn sleep time automatically** if it's selected.
4. Under **Sleep time**, choose the start and end time when data connection is disabled.
5. Tap the **Sleep mode On/Off** switch to turn it on.

The data connection resumes when you switch the screen back on.

## Automatic screen rotation



Automatic rotation is not supported in all applications.

1. Go to Settings, and then tap **Display**.
2. Select or clear the **Auto-rotate screen** option to turn it on or off.

## Setting when to turn off the screen

After a period of inactivity, the screen turns off to conserve battery power. You can set the idle time before the screen turns off.

1. Go to Settings, and then tap **Display**.
2. Tap **Screen timeout**, and then tap the time before the screen turns off.

## Screen brightness

1. Go to Settings, and then tap **Display**.
2. Tap **Brightness**.
3. With the **Automatic brightness** option selected, drag the slider to set the maximum brightness level. This sets a limit on how bright the screen will be when **Automatic brightness** is selected.
4. To set the brightness manually, clear the **Automatic brightness** option, and then drag the brightness slider to the left to decrease or to the right to increase the screen brightness.

## Changing the display font

You can change the font style and size of the display font.

1. Go to Settings, and then tap **Display**.
2. Tap **Font style** and choose one of the built-in fonts or tap **Get fonts online** to go online and download new fonts.
3. Tap **Font size** to choose the size of the font.

## Touch sounds and vibration

Some people like the sound or vibration feedback they get when touching the screen, and some don't. You can turn on or off various types of touch sounds and vibration on HTC Desire 510.

- Touch tones when tapping the phone dial pad
- Touch sounds when tapping onscreen items
- Screen lock sounds
- Pull-to-refresh sounds
- Vibration when pressing hardware buttons
- Touch sound and vibration when tapping the HTC Sense keyboard

---

### Turning touch sounds and vibration on and off

---

1. Go to Settings, and then tap **Sound**.
2. Under System, select the option you want to turn on or off.

---

### Turning off keyboard sounds and vibration

---

1. Go to Settings, and then tap **Language & keyboard**.
2. Tap HTC Sense Input.
3. Tap **Sound feedback** and then select **None** to turn off keyboard sounds.
4. Clear the **Vibration feedback** option to turn off keyboard vibration.

## Changing the display language

Changing the language adjusts the keyboard layout, date and time formatting, and more.

1. Go to Settings, and then tap **Language & keyboard**.
2. Tap **Language**, and then choose the language you want to use.

## Accessibility settings

Use these settings when you've downloaded and installed an accessibility tool, such as a screen reader that provides voice feedback. You can turn accessibility functions or services on or off.

1. Go to Settings, and then tap **Accessibility**.
2. Choose the settings you want.

## Turning Magnification gestures on or off

If you're visually impaired or would just like to get a closer view of what's on the screen, use Magnification gestures to enlarge portions of your phone's screen.

1. Go to Settings, and then tap **Accessibility**.
2. Tap **Magnification gestures**, and then tap the **On/Off** switch to turn it on or off.

Follow the onscreen instructions to learn how to use Magnification gestures.

## Installing a digital certificate

Use client and Certificate Authority (CA) digital certificates to enable HTC Desire 510 to access VPN or secured Wi-Fi networks, and also to provide authentication to online secure servers. You can get a certificate from your system administrator or download it from sites that require authentication.



- You must set a lock screen PIN or password before installing a digital certificate.
- Some apps such as your browser or email client let you install certificates directly in the app. See the app's help for details.

1. Save the certificate file in the root folder on HTC Desire 510.
2. Go to Settings, and then tap **Security**.
3. Tap **Install from storage**.
4. If you have more than one certificate in the root folder, select the certificate you want to install.
5. Enter a name for the certificate and tap **OK**.

## Disabling an app

Apps, even if not used often, may be running in the background and downloading data. If an app cannot be uninstalled, you can disable it.

1. Go to Settings, and then tap **Apps**.
2. Swipe to the All tab.
3. Tap the app, and then tap **Disable**.

## Assigning a PIN to a micro SIM card

You can help to protect the micro SIM card by assigning a Personal Identification Number (PIN).



Make sure you have the default PIN provided by your mobile operator before continuing.

1. Go to Settings, and then tap **Security**.
2. Tap **Set up SIM card lock**.
3. Choose to lock the card, enter the default PIN of the card, and then tap **OK**.
4. To change the card PIN, tap **Change SIM PIN**.

---

### Restoring a micro SIM card that has been locked out

---

If you enter the wrong PIN more times than the maximum number of attempts allowed, the card will become “PUK-locked.”

You need a Pin Unlock Key (PUK) code to restore access to HTC Desire 510. Contact your mobile operator for this code.

1. On the Phone dialer screen, enter the PUK code, and then tap **Next**.
2. Enter the new PIN you want to use, and then tap **Next**.
3. Enter the new PIN again, and then tap **OK**.

## Lock screen notifications

Choose the types of notifications to show or hide on the lock screen.

1. Go to Settings, and then tap **Security**.
2. Under Lock screen, tap **Notification settings**.
3. Choose whether to show or hide notifications such as missed calls and text messages.

## Hiding the caller from the lock screen

You can prevent the names and photos of incoming callers from appearing on the lock or security screens.



The caller must be in your private contacts list.

1. Go to Settings, and then tap **Security**.
2. Under Lock screen, select **Incoming phone calls**.

## Setting a screen lock

Help protect your personal information and help prevent others from using HTC Desire 510 without your permission.

Choose to set a screen lock pattern, numeric PIN, or other means of securing your phone. You'll be asked to unlock the screen every time HTC Desire 510 is turned on or when it's idle for a certain period of time.

1. Go to Settings, and then tap **Security**.
2. Tap **Screen lock**.
3. Select a screen lock option and set up the screen lock.
4. Tap **Lock phone after**, then specify the idle time before the screen is locked.



You can also clear **Make pattern visible** or **Make passwords visible** if you don't want your screen lock to display as you enter it onscreen.

## Setting up face unlock

Set up face unlock if you want to unlock HTC Desire 510 using the front camera.

1. Go to Settings, and then tap **Security**.
2. Tap **Screen lock > Face Unlock**.
3. Tap **Set it up** and follow the onscreen instructions.
4. Choose a backup unlock method to use in case the phone doesn't recognize you.
5. Tap **Lock phone after**, and then specify the idle time before the screen is locked.

To help make face unlock more reliable and more secure, you can:

- Tap **Improve face matching** to train HTC Desire 510 to recognize your face in different situations, such as when you're wearing glasses or sporting a beard.
- Select the **Liveness check** option and you will be asked to blink to unlock the screen.

## Bypassing the lock screen

If you've set a screen lock for HTC Desire 510, you can just skip the lock screen and go straight to the security screen for unlocking HTC Desire 510.

1. Go to Settings, and then tap **Security**.
2. Select the **Bypass lock screen on wake** option.

## Navigating HTC Desire 510 with TalkBack

Use TalkBack if you need to navigate HTC Desire 510 by spoken feedback. When you touch the screen, HTC Desire 510 vibrates and gives you an audible response so you know what you are touching.



Not all languages are supported.

---

### Turning TalkBack on

---

1. Go to Settings, and then tap **Accessibility**.
2. Tap **TalkBack**, and then tap the **On/Off** switch.
3. Read the TalkBack disclaimer and then tap **OK**. You'll be prompted to enable **Explore by touch**, which provides an audible description of what you're touching on the screen.

A short tutorial explaining how to use TalkBack will begin playing after you turn on TalkBack.



TalkBack works best if you turn off auto-rotate and turn on **Explore by touch**.

## Using TalkBack gestures

When TalkBack is turned on and the Explore by touch setting is selected, the regular touch gestures are replaced by the TalkBack gestures.



Media gestures such as 3-finger swiping may not be available when TalkBack gestures are enabled.

Do one of the following:

Open an item	<ol style="list-style-type: none"> <li>1. Drag your finger on the screen to find and select the item.</li> <li>2. Double-tap anywhere on the screen to open the item.</li> </ol>
Move an item	<ol style="list-style-type: none"> <li>1. Drag your finger on the screen to find the item.</li> <li>2. Double-tap anywhere on the screen, but don't lift your finger on the second tap.</li> <li>3. Drag the item to a new spot and then lift your finger.</li> </ol>
Scroll through a screen	Use two fingers to swipe up, down, left or right.
Unlock the lock screen	Use two fingers to swipe up from the bottom of the screen.
Open the Notifications panel	Use two fingers to swipe down from the top of the screen.

### Assigning TalkBack shortcuts

TalkBack has customizable gestures that can be used to open the Notifications panel, view recent apps, access TalkBack controls, and more.



The steps below are described using the regular gestures. Use the corresponding TalkBack gestures if you already have TalkBack turned on.

1. Go to Settings, and then tap **Accessibility**.
2. Tap **TalkBack**, and then tap **Settings** > **Manage gestures**.
3. Tap any of the shortcut gestures, and then select an action.

---

## Using TalkBack context menus

---

TalkBack has context menus for controlling continuous reading and global TalkBack controls. These menus can be accessed using TalkBack shortcut gestures.

1. Turn TalkBack on.
2. Do one of the following:
  - To open the continuous reading menu, use one finger to swipe up and right in one continuous movement.
  - To open the global context menu, use one finger to swipe down and right in one continuous movement.



If you already changed the TalkBack shortcut gestures, check your TalkBack settings for the appropriate gesture.

3. Press and hold anywhere on the screen.
4. Drag your finger around the screen to explore the options.



To cancel an action, drag your finger to your starting position.

---

## Changing the TalkBack reading speed

---



The steps below are described using the regular gestures. Use the corresponding TalkBack gestures if you already have TalkBack turned on.

1. Go to Settings, and then tap Accessibility.
2. Tap Text-to-speech output > Speech rate.
3. Select a speech rate.



You can test the speech rate by tapping Listen to an example.





---

## TalkBack language settings

---

1. Go to Settings, and then tap Accessibility.
2. Tap Text-to-speech output > Google Text-to-speech Engine, and do one of the following:

Select a different language	Tap Language.
Install a voice	Tap Install voice data, and then tap the language. Tap  next to the voice data you want to install. When installation is completed, press  twice and tap Language.

3. Select the language you want to use.



Not all languages are supported.

# Trademarks and copyrights

©2014 HTC Corporation. All Rights Reserved.

HTC, the HTC logo, HTC Desire, HTC BlinkFeed, HTC BoomSound, HTC Connect, HTC Sense, VideoPic, and Zoe are trademarks or service marks of HTC Corporation.

Google, the Google logo, Android, the Android logo, Android Market, Google Apps, Google Calendar, Google Checkout, Google Drive, Google Earth, Google Maps, Google Play, Google Wallet, Gmail, Picasa, and YouTube are trademarks of Google Inc.

Microsoft, Windows, ActiveSync, Excel, Outlook, PowerPoint, Windows Media, and Windows Vista are either registered trademarks or trademarks of Microsoft Corporation in the United States and/or other countries.

The *Bluetooth*<sup>®</sup> word mark and logos are registered trademarks owned by Bluetooth SIG, Inc.

Wi-Fi<sup>®</sup> is a registered trademark of the Wireless Fidelity Alliance, Inc.

LTE is a trademark of European Telecommunications Standards Institute (ETSI).

Facebook is a trademark of Facebook, Inc.

Twitter is a trademark of Twitter, Inc., and is used under license.

FLICKR and the FLICKR Dots logo are the trademarks and/or registered trademarks of Yahoo! Inc.

DLNA and the DLNA disc logo are trademarks or registered trademarks of Digital Living Network Alliance. All rights reserved. Unauthorized use is strictly prohibited.

Apple, Finder, iPhone, iTunes, iCal, iPhoto, Mac, Mac OS, and Safari are trademarks of Apple Inc. registered in the U.S. and other countries.

Dropbox is a trademark of Dropbox, Inc.

Polaris Office is a trademark of Infracore, Inc.

microSD is a trademark of SD-3C LLC.

All other trademarks and service marks mentioned herein, including company names, product names, service names and logos, are the property of their respective owners and their use herein does not indicate an affiliation with, association with, or endorsement of or by HTC Corporation. Not all marks listed necessarily appear in this User Guide.

The HTC Sync Manager software can be used with materials that you own or are lawfully authorized to use and/or duplicate. Unauthorized use and/or duplication of copyrighted material may be a violation of copyright law in the United States and/or other countries/regions. Violation of U.S. and international copyright laws may subject you to significant civil and/or criminal penalties. HTC Corporation shall not be held responsible for any damages or losses (direct or indirect) that you may incur as a result of using this software.

Screen images contained herein are simulated. HTC shall not be liable for technical or editorial errors or omissions contained herein, nor for incidental or consequential damages resulting from furnishing this material. The information is provided "as is" without warranty of any kind and is subject to change without notice. HTC also reserves the right to revise the content of this document at any time without prior notice.

No part of this document may be reproduced or transmitted in any form or by any means, electronic or mechanical, including photocopying, recording or storing in a retrieval system, or translated into any language in any form without prior written permission of HTC.

# Index

## A

### Accounts

- syncing 102

### Airplane mode 151

### Alarms

- setting 136

### Apps

- arranging 53
- grouping into a folder 53, 54
- hiding or unhiding 54
- icons on Home screen 50
- installing 24
- installing from Google Play 23
- installing from the web 24
- on Home screen 50
- restoring 24
- uninstalling 25
- updating 23

## B

### Backup

- about 103
- HTC Backup 104
- HTC Sync Manager 108
- options 103
- restoring backed up apps 24

### Battery

- charging 14
- checking usage 43
- saving battery power 45

### BlinkFeed

See HTC BlinkFeed

### Bluetooth

- connecting a Bluetooth headset 147
- receiving information 148

### Browser

- bookmarks 85
- history 85, 86
- incognito tab 86
- Reading list or Watch list 84
- tabs 84

- using 83

- viewing desktop version 83

### Burst mode 59

## C

### Calendar

- creating an event 129
- dual time zone 128
- meeting conflicts 129
- meeting invitations 130
- reminders 131
- sending quick response 131
- views 128

### Call history 73

### Camera

- basics 56, 58
- capture modes 56
- continuous shooting 59
- filters 57
- HDR 61
- recording a video 58
- selfie 60
- slow motion 61
- standby 56
- sweep panorama 60
- taking a photo 58
- taking photo while recording 59
- using volume buttons as controls 57
- video resolution 59
- zooming 56

### Capture modes

- modifying and saving 61
- switching to 56

### Capture screen 34

### Car

- about 134
- handling calls 135
- HTC Car Kit 134
- navigation 135
- playing music 135

### Change phone language 154

- Clock
  - alarm *136*
  - setting date and time *136*
- Conference call *73*
- Contacts
  - adding *114*
  - copying contacts *19, 116*
  - importing contacts *19, 116*
  - transferring contacts *19, 116*
- Continuous shooting *59*
- Copy
  - files *94*
- Copying
  - text *39*

---

## D

- Data connection
  - data roaming *141*
  - sharing *146*
  - turning on or off *140*
  - usage *140*
- Data transfer
  - from Android phone *18*
  - from iPhone and other phones *19*
  - transferring contacts *19*
- Display
  - changing the time before the screen turns off *153*
  - screen brightness *153*
  - screen rotation *153*
  - Sleep mode *28*
- DLNA *93*
- Do not disturb mode *151*
- Driving
  - See Car

---

## E

- Email
  - See Mail
- Exchange ActiveSync
  - flagging an email *126*
  - meeting request *127*
  - Out of office *126*
  - sending a meeting request *127*
- expanded storage *94*

---

## F

- Face unlock *157*
- Factory reset *111*
- Files
  - copying *94*
- Finger gestures *30*
- Firmware
  - See Software update
- FM Radio
  - using *92*
- Folder
  - grouping apps *53*
  - grouping bookmarks *85*
  - removing items *53, 54*
- FOTA
  - See Software update

---

## G

- Gallery
  - custom effects *66*
  - editing photos *66*
  - Video Highlights
    - See Zoe
    - video trimming *66*
    - viewing photos and videos *63*
    - viewing photos and videos by event *63*
    - viewing photos by location *64*
    - watching videos *66*
- Geotag *63*
- Gestures
  - motion gestures *29*
  - touch gestures *30*
- Gmail *121*
- Google Drive
  - about *97*
  - saving to Google Drive *101*
  - storage space *98*
  - uploading photos and videos *99*
  - working with documents *100*
- Google Maps *132*
- Google Now
  - setting up *80*
  - turning off *82*
- Google Play
  - installing apps *23*
  - refund *25*

Google Voice Search *83*

GPS (Global Positioning System)

See Location settings

Group messaging *76*

## H

Hands free *147*

Hard reset

See Factory reset

HDR *61*

Headphones

See Bluetooth

Home screen

- widgets *49*
- adding or removing widget panel *51*
- apps *50*
- arranging widget panels *51*
- changing your main Home screen *52*
- feeds *35*
- folder *53*
- launch bar *49*
- rearranging widgets and icons *51*
- removing widgets and icons *51*
- shortcuts *50*
- wallpaper *49*
- widget panel *20*

Hotspot

See Wireless router

HTC Backup *104*

HTC BlinkFeed

- about *35*
- adding regional editions *36*
- adding RSS feeds *36*
- deleting items *37*
- posting to social networks *37*
- saving articles for later *37*
- selecting feeds *35*
- setting up custom topics *36*
- showing social network and app feeds *36*
- turning on or off *35*

HTC Car

See Car

HTC Clock

- setting an alarm *136*

HTC Mini+

- adding Quick text *150*
- disconnecting *149*

- find feature *150*

- pairing and connecting *149*

- renaming *150*

- unpairing *150*

HTC Sense version *22*

HTC Sync Manager *108*

## I

Idle screen

See Lock screen

Incognito mode

See Browser, incognito tab

Internet

- browsing *83*

Internet connection

- VPN *143*
- Wi-Fi *142*
- wireless router *145*

## K

Keyboard

- dictionary *42*
- entering text *40*
- entering text by speaking *43*
- HTC Sense keyboard *39*
- layout *40*
- multi-language keyboard *40*
- predictive text *41*
- shortcuts *42*
- speech recognition *43*

Kid mode

- about *139*
- choosing apps *139*
- closing *139*

## L

Language

- system language *154*

Location settings *132*

Lock screen

- answering a call *71*
- dismissing an alarm *28*
- opening an app *33*
- rejecting a call *71*
- unlocking *28*
- widgets *55*

Low battery *45*

Low storage 95

---

**M**

---

Mail

- attachments 124
- carbon copy, blind copy (cc, bcc) 124
- deleting 126
- draft 124
- replying 124
- searching 126
- sending 124
- sorting 125

Mail folders

- moving email messages 125

Making calls

- calling 69

Maps

- Google Maps 132

Master reset

- See Factory reset

Meeting request 127

Messages

- block box 78
- deleting a conversation 79
- draft message 75, 76
- forwarding 77
- group SMS 76
- locking 79
- replying 76
- saving as task 77
- secure box 77
- sending 75

microSD card 12

MMS

- See Multimedia message

Multimedia message

- attachment 75
- group MMS 76
- sending 75

Music

- adding a song to a queue 89
- album covers 89
- artist photos 89
- listening 87
- lyrics 90
- playing music from the Lock screen 87

- playlist 88
- setting a song as ringtone 89
- transferring from iPhone 110

---

**N**

---

Navigation

- See Car

Notifications

- panel 38

---

**O**

---

Online accounts

- adding accounts 102
- removing accounts 102
- syncing manually 102
- what can you sync with 102

Online storage

- Google Drive 97

---

**P**

---

Pair a Bluetooth headset 147

People

- adding a new contact 114
- contact groups 118
- contact link suggestions 117
- copying contacts 19, 116, 117
- editing contacts 115
- filtering your contacts 113
- groups 118
- importing contacts 19, 116
- merging contact information 117
- personal profile 114
- sending contact information 118
- transferring contacts 19, 116

Phone calls

- blocking a call 74
- call history 73
- calling 69
- conference call 73
- emergency call 71
- extension number 69
- missed calls 70
- muting the microphone 72
- putting a call on hold 72
- receiving calls 71
- Smart Dial 69

- speakerphone 72
- speed dial 70

Phone information 22

Phone settings

See Settings

Phone updates 22

Photos

- custom effects 66
- location 64
- transferring from computer 20
- transferring from iPhone 110
- viewing photos and videos 63
- viewing photos and videos by event 63
- viewing photos by location 64

Power

- charging the battery 14
- checking battery usage 43
- saving power 45
- sleep mode 28

Print screen

See Capture screen

PUK (PIN Unblock Key) 156

## Q

Quick settings 20

## R

Radio

See FM Radio

Reading list 84

Recent apps 34

Recording your voice 137

Reset 111

Ringtone

- editing 90
- setting song as ringtone 89

Router

See Wireless router

## S

Screen

- adjusting brightness 153
- capture 34
- changing the time before the screen turns off 153
- idle screen 28

- rotation 153

- Sleep mode settings 153

Screen lock 157

Screen shot

See Capture screen

SD card 12

Search

- searching phone and Web 82
- voice search 83

Security

- protecting phone with screen lock 157
- security certificates 143

Settings

- About 22
- Accessibility 155
- display language 154
- Storage 94

Setup

- contacts from old phone 19
- initial setup 16
- photos, music, videos from old phone 20

Sharing

- events 130
- Google Drive 99
- text 39
- TV 93

Shortcuts 33

Sleep mode 28

Slideshow

- highlight video 67

Slow motion video 61

Smart network sharing 146

SMS

See Messages

Soft reset 111

Software update 22

Sound

- ringtone, notifications, and alarm 48
- switching profiles 74

Speakerphone 72

Speed dial 70

Storage 94

Sweep panorama 60

Sync

- HTC Sync Manager 108



---

T

---

Tasks

- about 138
- creating a task 138
- managing 138
- managing lists 138

Tethering

See USB Tethering

Text message 75

---

U

---

Upgrade

See Software update

Upload

- Google Drive 99

USB Tethering 146

---

V

---

Video Highlights

See Zoe

VideoPic 59

Videos

- editing 66
- recording 58
- taking photo while recording 59
- transferring from computer 20
- watching 66

Voice input 43

Voice Recorder 137

Voice search 83

VPN

- adding a connection 144
  - connecting 144
  - disconnecting 144
- 

W

---

Waking up phone

- through power button 28

Wallpaper

- changing 49

Watch list 84

Weather

- checking weather 137

Wi-Fi

- connecting via WPS 143
- turning on 142

Widgets

- adding 49
- changing settings 50
- lock screen widgets 55
- rearranging 51
- removing 51, 52
- resizing 50

Wireless display 93

Wireless router 145

Word prediction

- bilingual prediction 41
- 

Y

---

YouTube

- finding videos of songs 91
  - watching 91
- 

Z

---

Zoe 67