



A D T

# FCC TEST REPORT (PART 24)

**REPORT NO.:** RF140324C25-6

**MODEL NO.:** 0PAJ500

**FCC ID:** NM80PAJ500

**RECEIVED:** Mar. 24, 2014

**TESTED:** Apr. 17, 2014 ~ May 24, 2014

**ISSUED:** Jun. 04, 2014

**APPLICANT:** HTC Corporation

**ADDRESS:** 1F, 6-3 Baoqiang Road, Xindian District, New Taipei City, Taiwan 231

**ISSUED BY:** Bureau Veritas Consumer Products Services (H.K.) Ltd., Taoyuan Branch

**LAB ADDRESS:** No. 47, 14th Ling, Chia Pau Vil., Lin Kou Dist., New Taipei City, Taiwan ( R.O.C. )

**TEST LOCATION:** No. 19, Hwa Ya 2nd Rd, Wen Hwa Tsuen, Kwei Shan Hsiang, Taoyuan Hsien 333, Taiwan, R.O.C.

This report should not be used by the client to claim product certification, approval, or endorsement by TAF or any government agencies.



This report is for your exclusive use. Any copying or replication of this report to or for any other person or entity, or use of our name or trademark, is permitted only with our prior written permission. This report sets forth our findings solely with respect to the test samples identified herein. The results set forth in this report are not indicative or representative of the quality or characteristics of the lot from which a test sample was taken or any similar or identical product unless specifically and expressly noted. Our report includes all of the tests requested by you and the results thereof based upon the information that you provided to us. You have 60 days from date of issuance of this report to notify us of any material error or omission caused by our negligence, provided, however, that such notice shall be in writing and shall specifically address the issue you wish to raise. A failure to raise such issue within the prescribed time shall constitute your unqualified acceptance of the completeness of this report, the tests conducted and the correctness of the report contents. Unless specific mention, the uncertainty of measurement has been explicitly taken into account to declare the compliance or non-compliance to the specification

## TABLE OF CONTENTS

RELEASE CONTROL RECORD .....	3
1 CERTIFICATION .....	4
2 SUMMARY OF TEST RESULTS.....	5
2.1 MEASUREMENT UNCERTAINTY .....	5
2.2 TEST SITE AND INSTRUMENTS .....	6
3 GENERAL INFORMATION .....	7
3.1 GENERAL DESCRIPTION OF EUT.....	7
3.2 CONFIGURATION OF SYSTEM UNDER TEST .....	9
3.3 DESCRIPTION OF SUPPORT UNITS.....	9
3.4 TEST ITEM AND TEST CONFIGURATION .....	10
3.5 EUT OPERATING CONDITIONS.....	13
3.6 GENERAL DESCRIPTION OF APPLIED STANDARDS .....	13
4 TEST TYPES AND RESULTS.....	14
4.1 OUTPUT POWER MEASUREMENT .....	14
4.1.1 LIMITS OF OUTPUT POWER MEASUREMENT .....	14
4.1.2 TEST PROCEDURES .....	14
4.1.3 TEST SETUP .....	15
4.1.4 TEST RESULTS .....	16
4.2 FREQUENCY STABILITY MEASUREMENT .....	25
4.2.1 LIMITS OF FREQUENCY STABILITY MEASUREMENT .....	25
4.2.2 TEST PROCEDURE .....	25
4.2.3 TEST SETUP .....	25
4.2.4 TEST RESULTS .....	26
4.3 OCCUPIED BANDWIDTH MEASUREMENT.....	27
4.3.1 TEST PROCEDURES.....	27
4.3.2 TEST SETUP .....	27
4.3.3 TEST RESULTS .....	28
4.4 PEAK TO AVERAGE RATIO.....	32
4.4.1 LIMITS OF PEAK TO AVERAGE RATIO MEASUREMENT .....	32
4.4.2 TEST SETUP .....	32
4.4.3 TEST PROCEDURES .....	32
4.4.4 TEST RESULTS .....	33
4.5 BAND EDGE MEASUREMENT .....	37
4.5.1 LIMITS OF BAND EDGE MEASUREMENT .....	37
4.5.2 TEST SETUP .....	37
4.5.3 TEST PROCEDURES.....	37
4.5.4 TEST RESULTS .....	38
4.6 CONDUCTED SPURIOUS EMISSIONS.....	44
4.6.1 LIMITS OF CONDUCTED SPURIOUS EMISSIONS MEASUREMENT.....	44
4.6.2 TEST PROCEDURE .....	44
4.6.3 TEST SETUP .....	44
4.6.4 TEST RESULTS .....	45
4.7 RADIATED EMISSION MEASUREMENT .....	47
4.7.1 LIMITS OF RADIATED EMISSION MEASUREMENT .....	47
4.7.2 TEST PROCEDURES.....	47
4.7.3 DEVIATION FROM TEST STANDARD.....	47
4.7.4 TEST SETUP .....	48
4.7.5 TEST RESULTS .....	49
5 PHOTOGRAPHS OF THE TEST CONFIGURATION .....	67
6 INFORMATION ON THE TESTING LABORATORIES .....	68
7 APPENDIX A – MODIFICATIONS RECORDERS FOR ENGINEERING CHANGES TO THE EUT BY THE LAB.....	69



A D T

## RELEASE CONTROL RECORD

ISSUE NO.	REASON FOR CHANGE	DATE ISSUED
RF140324C25-6	Original release	Jun. 04, 2014



## 1 CERTIFICATION

**PRODUCT:** Smartphone

**MODEL:** 0PAJ500

**BRAND:** HTC

**APPLICANT:** HTC Corporation

**TESTED:** Apr. 17, 2014 ~ May 24, 2014

**TEST SAMPLE:** Production Unit

**STANDARDS:** FCC Part 24, Subpart E

The above equipment (model: 0PAJ500) has been tested by **Bureau Veritas Consumer Products Services (H.K.) Ltd., Taoyuan Branch**, and found compliance with the requirement of the above standards. The test record, data evaluation & Equipment Under Test (EUT) configurations represented herein are true and accurate accounts of the measurements of the sample's EMC characteristics under the conditions specified in this report.

**PREPARED BY** : Ivonne Wu , **DATE** : Jun. 04, 2014  
Ivonne Wu / Supervisor

**APPROVED BY** : Sam Chen , **DATE** : Jun. 04, 2014  
Sam Chen / Senior Project Engineer

## 2 SUMMARY OF TEST RESULTS

The EUT has been tested according to the following specifications:

APPLIED STANDARD: FCC Part 24 & Part 2			
STANDARD SECTION	TEST TYPE	RESULT	REMARK
2.1046 24.232	Equivalent Isotropically Radiated Power	PASS	Meet the requirement of limit.
2.1055 24.235	Frequency Stability	PASS	Meet the requirement of limit.
2.1049 24.238(b)	Occupied Bandwidth	PASS	Meet the requirement of limit.
24.232(d)	Peak to average ratio	PASS	Meet the requirement of limit.
24.238(b)	Band Edge Measurements	PASS	Meet the requirement of limit.
2.1051 24.238	Conducted Spurious Emissions	PASS	Meet the requirement of limit.
2.1053 24.238	Radiated Spurious Emissions	PASS	Meet the requirement of limit. Minimum passing margin is -24.65dB at 41.61MHz.

### 2.1 MEASUREMENT UNCERTAINTY

Where relevant, the following measurement uncertainty levels have been estimated for tests performed on the EUT as specified in CISPR 16-4-2:

MEASUREMENT	FREQUENCY	UNCERTAINTY
Conducted emissions	150kHz~30MHz	2.44 dB
Radiated emissions	30MHz ~ 200MHz	2.93 dB
	200MHz ~1000MHz	2.95 dB
	1GHz ~ 18GHz	2.26 dB
	18GHz ~ 40GHz	1.94 dB

This uncertainty represents an expanded uncertainty expressed at approximately the 95% confidence level using a coverage factor of k=2.



## 2.2 TEST SITE AND INSTRUMENTS

DESCRIPTION & MANUFACTURER	MODEL NO.	SERIAL NO.	DATE OF CALIBRATION	DUE DATE OF CALIBRATION
Test Receiver AGILENT	N9038A	MY51210203	Jan. 17, 2014	Jan. 16, 2015
Spectrum Analyzer ROHDE & SCHWARZ	FSU43	101261	Dec. 21, 2013	Dec. 20, 2014
BILOG Antenna SCHWARZBECK	VULB9168	9168-472	Feb. 27, 2014	Feb. 26, 2015
HORN Antenna SCHWARZBECK	BBHA 9120 D	9120D-969	Feb. 19, 2014	Feb. 18, 2015
HORN Antenna SCHWARZBECK	BBHA 9170	9170-480	Dec. 18, 2013	Dec. 17, 2014
Preamplifier EMCI	EMC 012645	980115	Dec. 26, 2013	Dec. 25, 2014
Preamplifier EMCI	EMC 184045	980116	Jan. 13, 2014	Jan. 12, 2015
Preamplifier EMCI	EMC 330H	980112	Dec. 27, 2013	Dec. 26, 2014
RF signal cable HUBER+SUHNNER	SUCOFLEX 104	309219/4 2950114	Oct. 18, 2013	Oct. 17, 2014
RF signal cable HUBER+SUHNNER	SUCOFLEX 104	250130/4	Oct. 18, 2013	Oct. 17, 2014
RF signal cable Worken	RG-213	NA	Nov. 07, 2013	Nov. 06, 2014
Software BV ADT	E3 6.120103	NA	NA	NA
Antenna Tower MF	MFA-440H	NA	NA	NA
Turn Table MF	MFT-201SS	NA	NA	NA
Antenna Tower & Turn Table Controller MF	MF-7802	NA	NA	NA
Mini-Circuits Power Splitter	ZN2PD-9G	NA	Jul. 18, 2013	Jul. 17, 2014
JFW 20dB attenuation	50HF-020-SMA	NA	NA	NA
Communications Tester-Wireless	E5515C	MY52102544	Sep. 05, 2012	Sep. 04, 2014
Radio Communication Analyzer	MT8820C	6201300640	Aug. 01, 2013	Jul. 31, 2014

**NOTE:** 1. The calibration interval of the above test instruments is 12 months and the calibrations are traceable to NML/ROC and NIST/USA.

2. The test was performed in HwaYa Chamber 10.

3. The horn antenna and HP preamplifier (model: 8449B) are used only for the measurement of emission frequency above 1GHz if tested.

4. The FCC Site Registration No. is 690701.

5. The IC Site Registration No. is IC 7450F-10.

### 3 GENERAL INFORMATION

#### 3.1 GENERAL DESCRIPTION OF EUT

<b>EUT</b>	Smartphone	
<b>MODEL NO.</b>	0PAJ500	
<b>POWER SUPPLY</b>	5.0Vdc (adapter or host equipment) 3.8Vdc (battery)	
<b>MODULATION TYPE</b>	CDMA	QPSK, OQPSK, HPSK
	LTE Band 25	QPSK, 16QAM
<b>FREQUENCY RANGE</b>	CDMA	1851.3MHz ~ 1908.8MHz
	LTE Band 25 (Channel Bandwidth: 1.4MHz)	1850.7MHz ~ 1914.3MHz
	LTE Band 25 (Channel Bandwidth: 3MHz)	1851.5MHz ~ 1913.5MHz
	LTE Band 25 (Channel Bandwidth: 5MHz)	1852.5MHz ~ 1912.5MHz
	LTE Band 25 (Channel Bandwidth: 10MHz)	1855MHz ~ 1910MHz
	LTE Band 25 (Channel Bandwidth: 15MHz)	1857.5MHz ~ 1907.5MHz
	LTE Band 25 (Channel Bandwidth: 20MHz)	1860.0MHz ~ 1905.0MHz
<b>MAX. EIRP POWER</b>	CDMA	303.67mW
	LTE Band 25 (Channel Bandwidth: 1.4MHz)	239.33mW
	LTE Band 25 (Channel Bandwidth: 3MHz)	246.04mW
	LTE Band 25 (Channel Bandwidth: 5MHz)	264.24mW
	LTE Band 25 (Channel Bandwidth: 10MHz)	279.90mW
	LTE Band 25 (Channel Bandwidth: 15MHz)	322.11mW
	LTE Band 25 (Channel Bandwidth: 20MHz)	329.61mW
<b>EMISSION DESIGNATOR</b>	CDMA	1M27F9W
	LTE Band 25 (Channel Bandwidth: 1.4MHz)	1M08G7D
	LTE Band 25 (Channel Bandwidth: 3MHz)	2M68G7D
	LTE Band 25 (Channel Bandwidth: 5MHz)	4M49G7D
	LTE Band 25 (Channel Bandwidth: 10MHz)	8M92G7D
	LTE Band 25 (Channel Bandwidth: 15MHz)	13M4G7D
	LTE Band 25 (Channel Bandwidth: 20MHz)	17M8W7D
<b>ANTENNA TYPE</b>	Fixed Internal Antenna	
<b>I/O PORTS</b>	Refer to users' manual	
<b>DATA CABLE</b>	Refer to NOTE as below	
<b>ACCESSORY DEVICES</b>	Refer to NOTE as below	



A D T

**NOTE:**

1. The EUT's accessories list refers to Ext. Pho.
2. There're 2 configurations for the EUT listed as below.  
Main sample (A): Phone + Battery 1 + LCM 1  
2<sup>nd</sup> sample (B): Phone + Battery 2 + LCM 2  
✧ Only the worst test data was presented in the report.
3. The above EUT information was declared by manufacturer and for more detailed features description, please refer to the manufacturer's specifications or User's Manual.



### 3.2 CONFIGURATION OF SYSTEM UNDER TEST

#### FOR RADIATION EMISSION TEST

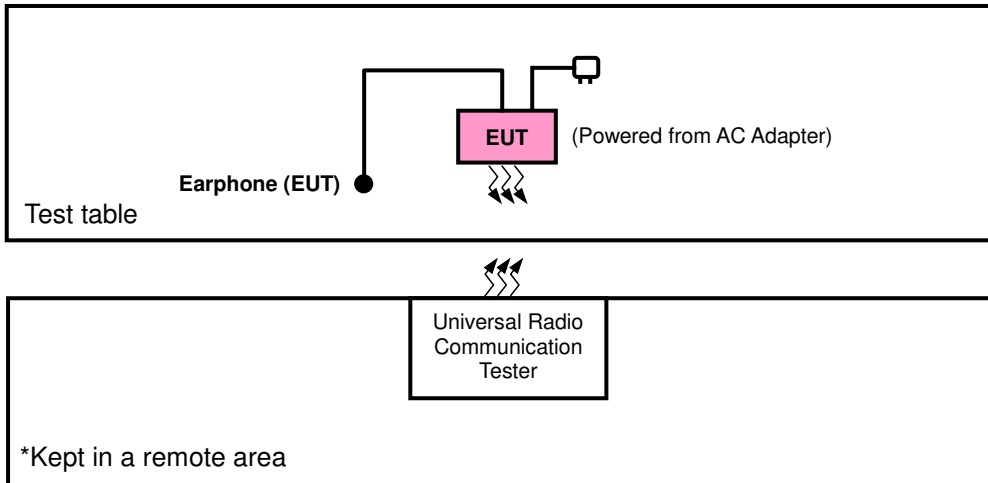

#### FOR E.I.R.P. TEST

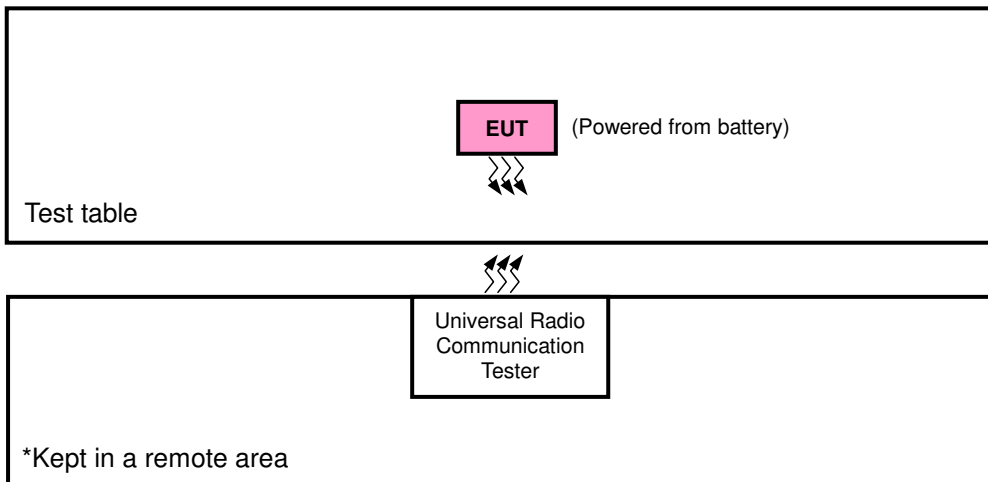

### 3.3 DESCRIPTION OF SUPPORT UNITS

The EUT has been tested as an independent unit together with other necessary accessories or support units.

### 3.4 TEST ITEM AND TEST CONFIGURATION

Pre-Scan has been conducted to determine the worst-case mode from all possible combinations between available modulations, data rates, XYZ axis and antenna ports. The worst case was found as the list below. Following channel(s) was (were) selected for the final test as listed below:

EUT CONFIGURE MODE	DESCRIPTION
A	Main sample
B	2 <sup>nd</sup> sample

BAND	ERP	RADIATED EMISSION
CDMA	Z-plane	Y-axis (Mode A) X-axis (Mode B)
LTE Band 25	X-plane	Z-axis

#### CDMA MODE

EUT CONFIGURE MODE	TEST ITEM	AVAILABLE CHANNEL	TESTED CHANNEL	MODE
A, B	EIRP	25 to 1175	25, 600, 1175	1xRTT
A	FREQUENCY STABILITY	25 to 1175	600	1xRTT
A	OCCUPIED BANDWIDTH	25 to 1175	25, 600, 1175	1xRTT
A	PEAK TO AVERAGE RATIO	25 to 1175	25, 600, 1175	1xRTT
A	BAND EDGE	25 to 1175	25, 1175	1xRTT
A	CONDCUDED EMISSION	25 to 1175	600	1xRTT
A, B	RADIATED EMISSION	25 to 1175	600	1xRTT



**LTE BAND 25 MODE**

EUT CONFIGURE MODE	TEST ITEM	AVAILABLE CHANNEL	TESTED CHANNEL	CHANNEL BANDWIDTH	MODULATION	MODE
A	EIRP	26047 to 26683	26047, 26365, 26683	1.4MHz	QPSK / 16QAM	1 RB / 2 RB Offset
		26055 to 26675	26055, 26365, 26675	3MHz	QPSK / 16QAM	1 RB / 7 RB Offset
		26065 to 26665	26065, 26365, 26665	5MHz	QPSK / 16QAM	1 RB / 12 RB Offset
		26090 to 26640	26090, 26365, 26640	10MHz	QPSK / 16QAM	1 RB / 24 RB Offset
		26115 to 26615	26115, 26365, 26615	15MHz	QPSK / 16QAM	1 RB / 37 RB Offset
		26140 to 26590	26140, 26365, 26590	20MHz	QPSK / 16QAM	1 RB / 50 RB Offset
B	EIRP	26140 to 26590	26140, 26365, 26590	20MHz	QPSK / 16QAM	1 RB / 50 RB Offset
A	FREQUENCY STABILITY	26047 to 26683	26365	1.4MHz	QPSK	1 RB / 2 RB Offset
		26055 to 26675	26365	3MHz	QPSK	1 RB / 7 RB Offset
		26065 to 26665	26365	5MHz	QPSK	1 RB / 12 RB Offset
		26090 to 26640	26365	10MHz	QPSK	1 RB / 24 RB Offset
		26115 to 26615	26365	15MHz	QPSK	1 RB / 37 RB Offset
		26140 to 26590	26365	20MHz	QPSK	1 RB / 50 RB Offset
A	OCCUPIED BANDWIDTH	26047 to 26683	26047, 26365, 26683	1.4MHz	QPSK / 16QAM	6 RB / 0 RB Offset
		26055 to 26675	26055, 26365, 26675	3MHz	QPSK / 16QAM	15 RB / 0 RB Offset
		26065 to 26665	26065, 26365, 26665	5MHz	QPSK / 16QAM	25 RB / 0 RB Offset
		26090 to 26640	26090, 26365, 26640	10MHz	QPSK / 16QAM	50 RB / 0 RB Offset
		26115 to 26615	26115, 26365, 26615	15MHz	QPSK / 16QAM	75 RB / 0 RB Offset
		26140 to 26590	26140, 26365, 26590	20MHz	QPSK / 16QAM	100 RB / 0 RB Offset
A	PEAK TO AVERAGE RATIO	26047 to 26683	26047, 26365, 26683	1.4MHz	QPSK / 16QAM	1 RB / 2 RB Offset
		26055 to 26675	26055, 26365, 26675	3MHz	QPSK / 16QAM	1 RB / 7 RB Offset
		26065 to 26665	26065, 26365, 26665	5MHz	QPSK / 16QAM	1 RB / 12 RB Offset
		26090 to 26640	26090, 26365, 26640	10MHz	QPSK / 16QAM	1 RB / 24 RB Offset
		26115 to 26615	26115, 26365, 26615	15MHz	QPSK / 16QAM	1 RB / 37 RB Offset
		26140 to 26590	26140, 26365, 26590	20MHz	QPSK / 16QAM	1 RB / 50 RB Offset



A D T

EUT CONFIGURE MODE	TEST ITEM	AVAILABLE CHANNEL	TESTED CHANNEL	CHANNEL BANDWIDTH	MODULATION	MODE		
A	BAND EDGE	26047 to 26683	26047	1.4MHz	QPSK	1 RB / 0 RB Offset 6 RB / 0 RB Offset		
			26683	1.4MHz	QPSK	1 RB / 5 RB Offset 6 RB / 0 RB Offset		
		26055 to 26675	26055	3MHz	QPSK	1 RB / 0 RB Offset 15 RB / 0 RB Offset		
			26675	3MHz	QPSK	1 RB / 14 RB Offset 15 RB / 0 RB Offset		
		26065 to 26665	26065	5MHz	QPSK	1 RB / 0 RB Offset 25 RB / 0 RB Offset		
			26665	5MHz	QPSK	1 RB / 24 RB Offset 25 RB / 0 RB Offset		
		26090 to 26640	26090	10MHz	QPSK	1 RB / 0 RB Offset 50 RB / 0 RB Offset		
			26640	10MHz	QPSK	1 RB / 49 RB Offset 50 RB / 0 RB Offset		
		26115 to 26615	26115	15MHz	QPSK	1 RB / 0 RB Offset 75 RB / 0 RB Offset		
			26615	15MHz	QPSK	1 RB / 74 RB Offset 75 RB / 0 RB Offset		
		26140 to 26590	26140	20MHz	QPSK	1 RB / 0 RB Offset 100 RB / 0 RB Offset		
			26590	20MHz	QPSK	1 RB / 99 RB Offset 100 RB / 0 RB Offset		
		A	CONDCUETED EMISSION	26047 to 26683	26365	1.4MHz	QPSK	1 RB / 2 RB Offset
				26055 to 26675	26365	3MHz	QPSK	1 RB / 7 RB Offset
				26065 to 26665	26365	5MHz	QPSK	1 RB / 12 RB Offset
				26090 to 26640	26365	10MHz	QPSK	1 RB / 24 RB Offset
26115 to 26615	26365			15MHz	QPSK	1 RB / 37 RB Offset		
26140 to 26590	26365			20MHz	QPSK	1 RB / 50 RB Offset		
A	RADIATED EMISSION	26047 to 26683	26365	1.4MHz	QPSK	1 RB / 2 RB Offset		
		26055 to 26675	26365	3MHz	QPSK	1 RB / 7 RB Offset		
		26065 to 26665	26365	5MHz	QPSK	1 RB / 12 RB Offset		
		26090 to 26640	26365	10MHz	QPSK	1 RB / 24 RB Offset		
		26115 to 26615	26365	15MHz	QPSK	1 RB / 37 RB Offset		
		26140 to 26590	26365	20MHz	QPSK	1 RB / 50 RB Offset		
B	RADIATED EMISSION	26047 to 26683	26365	1.4MHz	QPSK	1 RB / 2 RB Offset		

**Note:** This device was tested under all bandwidths, RB configurations and modulations. The worst case was found in QPSK modulation.

**TEST CONDITION:**

TEST ITEM	ENVIRONMENTAL CONDITIONS	INPUT POWER	TESTED BY
EIRP	26deg. C, 58%RH	3.8Vdc	Howard Kao
FREQUENCY STABILITY	26deg. C, 58%RH	3.8Vdc	Howard Kao
OCCUPIED BANDWIDTH	26deg. C, 58%RH	3.8Vdc	Howard Kao
PEAK TO AVERAGE RATIO	26deg. C, 58%RH	3.8Vdc	Howard Kao
BAND EDGE	26deg. C, 58%RH	3.8Vdc	Howard Kao
CONDCUDED EMISSION	26deg. C, 58%RH	3.8Vdc	Howard Kao
RADIATED EMISSION	25deg. C, 65%RH	120Vac, 60Hz	Johnson Liao / Peter Weng

**3.5 EUT OPERATING CONDITIONS**

The EUT makes a call to the communication simulator. The communication simulator station system controlled a EUT to export maximum output power under transmission mode and specific channel frequency

**3.6 GENERAL DESCRIPTION OF APPLIED STANDARDS**

The EUT is a RF product. According to the specifications of the manufacturer, it must comply with the requirements of the following standards:

**FCC 47 CFR Part 2**

**FCC 47 CFR Part 24**

**ANSI/TIA/EIA-603-C 2004**

**NOTE:** All test items have been performed and recorded as per the above standards.

## 4 TEST TYPES AND RESULTS

### 4.1 OUTPUT POWER MEASUREMENT

#### 4.1.1 LIMITS OF OUTPUT POWER MEASUREMENT

Mobile and portable stations are limited to 2 watts EIRP.

#### 4.1.2 TEST PROCEDURES

##### **EIRP MEASUREMENT:**

- a. All measurements were done at low, middle and high operational frequency range. RBW and VBW is 5MHz for CDMA, and 10MHz for LTE mode.
- b. Substitution method is used for E.I.R.P measurement. In the semi-anechoic chamber, EUT placed on the 0.8m height of Turn Table, rotated the table around 360 degrees to search the maximum radiation power and receiver antenna shall be rotated vertical and horizontal polarization and moved height from 1m to 4m to find the maximum polar radiated power. The “Read Value” is the spectrum reading the maximum power value.
- c. The substitution horn antenna is substituted for EUT at the same position and signals generator export the CW signal to the substitution antenna via a tx cable. Rotated the Turn Table and moved receiving antenna to find the maximum radiation power. Adjust output power level of S.G to get a Value of spectrum reading equal to “Read Value” of step b. Record the power level of S.G
- d.  $EIRP = \text{Output power level of S.G} - \text{TX cable loss} + \text{Antenna gain of substitution horn}.$

##### **CONDUCTED POWER MEASUREMENT:**

The EUT was set up for the maximum power with CDMA & LTE link data modulation and link up with simulator. Set the EUT to transmit under low, middle and high channel and record the power level shown on simulator.

### 4.1.3 TEST SETUP

#### EIRP / ERP MEASUREMENT:

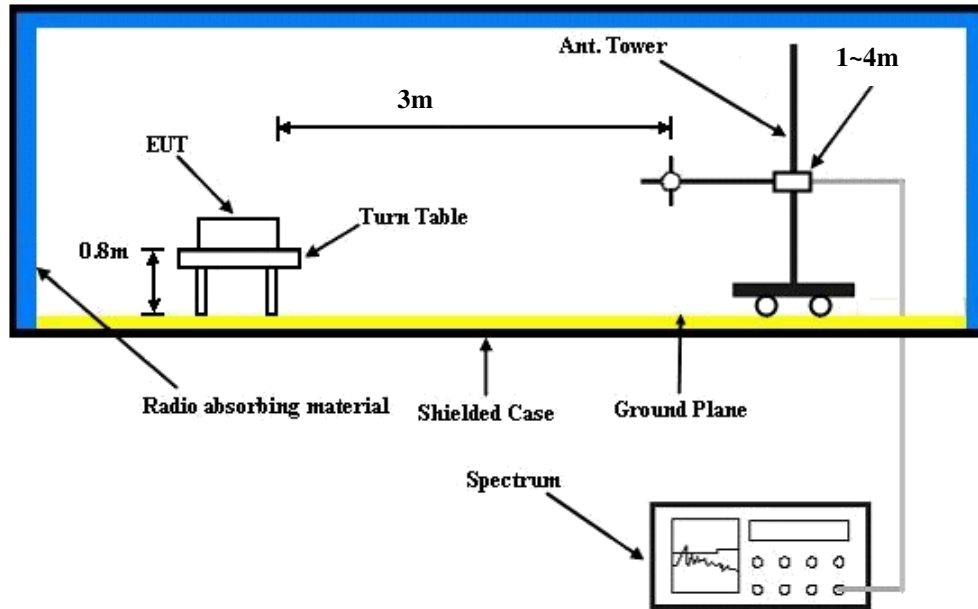

#### CONDUCTED POWER MEASUREMENT:

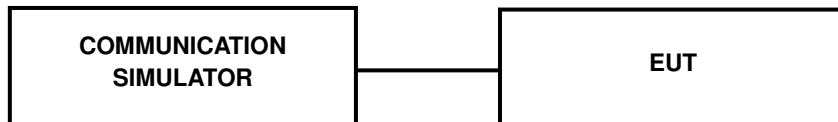



A D T

#### 4.1.4 TEST RESULTS

##### CONDUCTED OUTPUT POWER (dBm)

Band	CDMA		
Channel	25	600	1175
Frequency (MHz)	1851.25	1880	1908.75
RC1+SO55	24.44	24.45	24.26
RC3+SO55	24.40	24.49	24.22
RC3+SO32(+ F-SCH)	24.39	24.44	24.21
RC3+SO32(+SCH)	24.40	24.45	24.22
RTAP 153.6	24.42	24.47	24.24
RETAP 4096	24.43	24.48	24.25
RC1+SO3	24.32	24.33	24.14
RC3+SO3	24.23	24.32	24.05

Band / BW	Modulation	RB Size	RB Offset	Low CH	Mid CH	High CH	3GPP MPR (dB)	
				26047	26365	26683		
				Frequency	Frequency	Frequency		
				1850.7 MHz	1882.5 MHz	1914.3 MHz		
25 / 1.4M	QPSK	1	0	23.68	23.66	23.65	0	
		1	2	23.89	23.73	23.72	0	
		1	5	23.56	23.48	23.42	0	
		3	0	23.84	23.77	23.62	0	
		3	1	23.86	23.79	23.58	0	
		3	3	23.80	23.55	23.48	0	
		6	0	22.75	22.57	22.45	1	
	16QAM	1	0	22.68	22.66	22.65	1	
		1	2	22.89	22.73	22.72	1	
		1	5	22.56	22.48	22.42	1	
		3	0	22.74	22.67	22.52	1	
		3	1	22.76	22.69	22.48	1	
		3	3	22.70	22.45	22.41	1	
		6	0	21.75	21.57	21.45	2	

Band / BW	Modulation	RB Size	RB Offset	Low CH	Mid CH	High CH	3GPP MPR (dB)	
				26055	26365	26675		
				Frequency	Frequency	Frequency		
				1851.5 MHz	1882.5 MHz	1913.5 MHz		
25 / 3M	QPSK	1	0	23.78	23.76	23.75	0	
		1	7	23.99	23.83	23.82	0	
		1	14	23.66	23.58	23.52	0	
		8	0	22.84	22.77	22.62	1	
		8	3	22.86	22.79	22.58	1	
		8	7	22.80	22.55	22.48	1	
		15	0	22.85	22.67	22.55	1	
	16QAM	1	0	22.78	22.76	22.75	1	
		1	7	22.99	22.83	22.82	1	
		1	14	22.66	22.58	22.52	1	
		8	0	21.84	21.77	21.62	2	
		8	3	21.86	21.79	21.58	2	
		8	7	21.80	21.55	21.48	2	
		15	0	21.85	21.67	21.55	2	





A D T

Band / BW	Modulation	RB Size	RB Offset	Low CH 26065	Mid CH 26365	High CH 26665	3GPP MPR (dB)
				Frequency 1852.5 MHz	Frequency 1882.5 MHz	Frequency 1912.5 MHz	
25 / 5M	QPSK	1	0	23.88	23.86	23.85	0
		1	12	24.09	23.93	23.92	0
		1	24	23.76	23.68	23.62	0
		12	0	22.94	22.87	22.72	1
		12	6	22.96	22.89	22.68	1
		12	13	22.90	22.65	22.58	1
		25	0	22.95	22.77	22.65	1
	16QAM	1	0	22.88	22.86	22.85	1
		1	12	23.09	22.93	22.92	1
		1	24	22.76	22.68	22.62	1
		12	0	21.94	21.87	21.72	2
		12	6	21.96	21.89	21.68	2
		12	13	21.90	21.65	21.58	2
		25	0	21.95	21.77	21.65	2

Band / BW	Modulation	RB Size	RB Offset	Low CH 26090	Mid CH 26365	High CH 26640	3GPP MPR (dB)
				Frequency 1855.0 MHz	Frequency 1882.5 MHz	Frequency 1910.0 MHz	
25 / 10M	QPSK	1	0	23.97	23.95	23.94	0
		1	24	24.18	24.02	24.01	0
		1	49	23.85	23.77	23.71	0
		25	0	23.03	22.96	22.81	1
		25	12	23.05	22.98	22.77	1
		25	25	22.99	22.74	22.67	1
		50	0	23.04	22.86	22.74	1
	16QAM	1	0	22.97	22.95	22.94	1
		1	24	23.18	23.02	23.01	1
		1	49	22.85	22.77	22.71	1
		25	0	22.03	21.96	21.81	2
		25	12	22.05	21.98	21.77	2
		25	25	21.99	21.74	21.67	2
		50	0	22.04	21.86	21.74	2

Band / BW	Modulation	RB Size	RB Offset	Low CH 26115	Mid CH 26365	High CH 26615	3GPP MPR (dB)
				Frequency 1857.5 MHz	Frequency 1882.5 MHz	Frequency 1907.5 MHz	
25 / 15M	QPSK	1	0	24.08	24.06	24.05	0
		1	37	24.29	24.13	24.12	0
		1	74	23.96	23.88	23.82	0
		36	0	23.14	23.07	22.92	1
		36	19	23.16	23.09	22.88	1
		36	39	23.10	22.85	22.78	1
		75	0	23.15	22.97	22.85	1
	16QAM	1	0	23.08	23.06	23.05	1
		1	37	23.29	23.13	23.12	1
		1	74	22.96	22.88	22.82	1
		36	0	22.14	22.07	21.92	2
		36	19	22.16	22.09	21.88	2
		36	39	22.10	21.85	21.78	2
		75	0	22.15	21.97	21.85	2



A D T

Band / BW	Modulation	RB Size	RB Offset	Low CH 26140	Mid CH 26365	High CH 26590	3GPP MPR (dB)
				Frequency 1860.0 MHz	Frequency 1882.5 MHz	Frequency 1905.0 MHz	
25 / 20M	QPSK	1	0	24.18	24.16	24.15	0
		1	50	24.39	24.23	24.22	0
		1	99	24.06	23.98	23.92	0
		50	0	23.24	23.17	23.02	1
		50	25	23.26	23.19	22.98	1
		50	50	23.20	22.95	22.88	1
		100	0	23.25	23.07	22.95	1
	16QAM	1	0	23.18	23.16	23.15	1
		1	50	23.39	23.23	23.22	1
		1	99	23.06	22.98	22.92	1
		50	0	22.24	22.17	22.02	2
		50	25	22.26	22.19	21.98	2
		50	50	22.20	21.95	21.88	2
		100	0	22.25	22.07	21.95	2



A D T

**EIRP POWER (dBm)**

**MODE A**

CDMA							
Plane	Channel	Frequency (MHz)	LVL (dBm)	Correction Factor(dB)	EIRP(dBm)	EIRP(mW)	Polarization (H/V)
Z	25	1851.25	-12.21	36.57	24.36	273.02	H
	600	1880.00	-12.40	37.22	24.82	303.67	H
	1175	1908.75	-12.61	37.18	24.57	286.55	H
	25	1851.25	-20.10	37.65	17.55	56.90	V
	600	1880.00	-19.99	37.58	17.59	57.45	V
	1175	1908.75	-20.40	37.48	17.08	51.05	V

LTE Band 25							
Channel Bandwidth: 1.4MHz / QPSK							
Plane	Channel	Frequency (MHz)	LVL (dBm)	Correction Factor(dB)	EIRP(dBm)	EIRP(mW)	Polarization (H/V)
X	26047	1850.7	-13.37	36.57	23.20	209.03	H
	26365	1882.5	-13.62	37.22	23.60	229.30	H
	26683	1914.3	-15.30	39.09	23.79	239.33	H
	26047	1850.7	-18.39	37.65	19.26	84.35	V
	26365	1882.5	-18.87	37.58	18.71	74.35	V
	26683	1914.3	-19.99	37.92	17.93	62.09	V

LTE Band 25							
Channel Bandwidth: 1.4MHz / 16QAM							
Plane	Channel	Frequency (MHz)	LVL (dBm)	Correction Factor(dB)	EIRP(dBm)	EIRP(mW)	Polarization (H/V)
X	26047	1850.7	-15.32	36.57	21.25	133.41	H
	26365	1882.5	-15.26	37.22	21.96	157.18	H
	26683	1914.3	-16.47	39.09	22.62	182.81	H
	26047	1850.7	-19.47	37.65	18.18	65.78	V
	26365	1882.5	-20.13	37.58	17.45	55.63	V
	26683	1914.3	-20.29	37.92	17.63	57.94	V



A D T

LTE Band 25							
Channel Bandwidth: 3MHz / QPSK							
Plane	Channel	Frequency (MHz)	LVL (dBm)	Correction Factor(dB)	EIRP(dBm)	EIRP(mW)	Polarization (H/V)
X	26055	1851.5	-13.41	36.57	23.16	207.11	H
	26365	1882.5	-13.41	37.22	23.81	240.66	H
	26675	1913.5	-15.20	39.11	23.91	246.04	H
	26055	1851.5	-18.45	37.65	19.20	83.20	V
	26365	1882.5	-19.04	37.58	18.54	71.50	V
	26675	1913.5	-19.94	37.93	17.99	62.95	V

LTE Band 25							
Channel Bandwidth: 3MHz / 16QAM							
Plane	Channel	Frequency (MHz)	LVL (dBm)	Correction Factor(dB)	EIRP(dBm)	EIRP(mW)	Polarization (H/V)
X	26055	1851.5	-15.35	36.57	21.22	132.50	H
	26365	1882.5	-15.17	37.22	22.05	160.47	H
	26675	1913.5	-16.48	39.11	22.63	183.23	H
	26055	1851.5	-19.46	37.65	18.19	65.93	V
	26365	1882.5	-20.26	37.58	17.32	53.99	V
	26675	1913.5	-20.92	37.93	17.01	50.23	V

LTE Band 25							
Channel Bandwidth: 5MHz / QPSK							
Plane	Channel	Frequency (MHz)	LVL (dBm)	Correction Factor(dB)	EIRP(dBm)	EIRP(mW)	Polarization (H/V)
X	26065	1852.5	-13.38	36.57	23.19	208.55	H
	26365	1882.5	-13.10	37.22	24.12	258.46	H
	26665	1912.5	-14.89	39.11	24.22	264.24	H
	26065	1852.5	-18.33	37.65	19.32	85.53	V
	26365	1882.5	-19.07	37.58	18.51	71.01	V
	26665	1912.5	-19.44	37.96	18.52	71.12	V



A D T

LTE Band 25							
Channel Bandwidth: 5MHz / 16QAM							
Plane	Channel	Frequency (MHz)	LVL (dBm)	Correction Factor(dB)	EIRP(dBm)	EIRP(mW)	Polarization (H/V)
X	26065	1852.5	-15.03	36.57	21.54	142.63	H
	26365	1882.5	-14.96	37.22	22.26	168.42	H
	26665	1912.5	-16.37	39.11	22.74	187.93	H
	26065	1852.5	-19.51	37.65	18.14	65.18	V
	26365	1882.5	-20.01	37.58	17.57	57.19	V
	26665	1912.5	-19.97	37.96	17.99	62.95	V

LTE Band 25							
Channel Bandwidth: 10MHz / QPSK							
Plane	Channel	Frequency (MHz)	LVL (dBm)	Correction Factor(dB)	EIRP(dBm)	EIRP(mW)	Polarization (H/V)
X	26090	1855	-13.30	36.57	23.27	212.42	H
	26365	1882.5	-13.00	37.22	24.22	264.48	H
	26640	1910	-14.72	39.19	24.47	279.90	H
	26090	1855	-18.05	37.65	19.60	91.22	V
	26365	1882.5	-19.18	37.58	18.40	69.23	V
	26640	1910	-19.78	38.15	18.37	68.71	V

LTE Band 25							
Channel Bandwidth: 10MHz / 16QAM							
Plane	Channel	Frequency (MHz)	LVL (dBm)	Correction Factor(dB)	EIRP(dBm)	EIRP(mW)	Polarization (H/V)
X	26090	1855	-14.93	36.57	21.64	145.95	H
	26365	1882.5	-14.79	37.22	22.43	175.15	H
	26640	1910	-15.97	39.19	23.22	209.89	H
	26090	1855	-18.78	37.65	18.87	77.11	V
	26365	1882.5	-20.00	37.58	17.58	57.32	V
	26640	1910	-20.35	38.15	17.80	60.26	V



A D T

LTE Band 25							
Channel Bandwidth: 15MHz / QPSK							
Plane	Channel	Frequency (MHz)	LVL (dBm)	Correction Factor(dB)	EIRP(dBm)	EIRP(mW)	Polarization (H/V)
X	26115	1857.5	-12.92	36.57	23.65	231.85	H
	26365	1882.5	-12.89	37.22	24.33	271.27	H
	26615	1907.5	-14.15	39.23	25.08	322.11	H
	26115	1857.5	-17.21	37.65	20.44	110.69	V
	26365	1882.5	-19.23	37.58	18.35	68.44	V
	26615	1907.5	-19.40	38.22	18.82	76.21	V

LTE Band 25							
Channel Bandwidth: 15MHz / 16QAM							
Plane	Channel	Frequency (MHz)	LVL (dBm)	Correction Factor(dB)	EIRP(dBm)	EIRP(mW)	Polarization (H/V)
X	26115	1857.5	-14.83	36.57	21.74	149.35	H
	26365	1882.5	-14.59	37.22	22.63	183.40	H
	26615	1907.5	-16.15	39.23	23.08	203.24	H
	26115	1857.5	-18.80	37.65	18.85	76.75	V
	26365	1882.5	-19.02	37.58	18.56	71.83	V
	26615	1907.5	-19.85	38.22	18.37	68.71	V

LTE Band 25							
Channel Bandwidth: 20MHz / QPSK							
Plane	Channel	Frequency (MHz)	LVL (dBm)	Correction Factor(dB)	EIRP(dBm)	EIRP(mW)	Polarization (H/V)
X	26140	1860	-13.19	36.57	23.38	217.87	H
	26365	1882.5	-12.75	37.22	24.47	280.16	H
	26590	1905	-13.54	38.72	25.18	329.61	H
	26140	1860	-18.13	37.65	19.52	89.56	V
	26365	1882.5	-19.26	37.58	18.32	67.97	V
	26590	1905	-18.19	37.56	19.37	86.50	V



A D T

LTE Band 25							
Channel Bandwidth: 20MHz / 16QAM							
Plane	Channel	Frequency (MHz)	LVL (dBm)	Correction Factor(dB)	EIRP(dBm)	EIRP(mW)	Polarization (H/V)
X	26140	1860	-14.16	36.57	22.41	174.26	H
	26365	1882.5	-14.43	37.22	22.79	190.28	H
	26590	1905	-15.22	38.72	23.50	223.87	H
	26140	1860	-18.66	37.65	18.99	79.27	V
	26365	1882.5	-19.53	37.58	18.05	63.87	V
	26590	1905	-19.21	37.56	18.35	68.39	V



**MODE B**

CDMA							
Plane	Channel	Frequency (MHz)	LVL (dBm)	Correction Factor(dB)	EIRP(dBm)	EIRP(mW)	Polarization (H/V)
Z	25	1851.25	-12.22	36.57	24.35	272.40	H
	600	1880.00	-12.66	37.22	24.56	286.02	H
	1175	1908.75	-12.92	37.18	24.26	266.81	H
	25	1851.25	-20.71	37.65	16.94	49.44	V
	600	1880.00	-21.01	37.58	16.57	45.43	V
	1175	1908.75	-20.88	37.48	16.60	45.71	V

LTE Band 25							
Channel Bandwidth: 20MHz / QPSK							
Plane	Channel	Frequency (MHz)	LVL (dBm)	Correction Factor(dB)	EIRP(dBm)	EIRP(mW)	Polarization (H/V)
X	26140	1860	-12.55	36.57	24.02	252.46	H
	26365	1882.5	-12.50	37.22	24.72	296.76	H
	26590	1905	-13.97	38.72	24.75	298.54	H
	26140	1860	-18.91	37.65	18.74	74.83	V
	26365	1882.5	-19.40	37.58	18.18	65.81	V
	26590	1905	-19.22	37.56	18.34	68.23	V

LTE Band 25							
Channel Bandwidth: 20MHz / 16QAM							
Plane	Channel	Frequency (MHz)	LVL (dBm)	Correction Factor(dB)	EIRP(dBm)	EIRP(mW)	Polarization (H/V)
X	26140	1860	-13.92	36.57	22.65	184.16	H
	26365	1882.5	-13.66	37.22	23.56	227.20	H
	26590	1905	-15.44	38.72	23.28	212.81	H
	26140	1860	-19.31	37.65	18.34	68.25	V
	26365	1882.5	-20.45	37.58	17.13	51.68	V
	26590	1905	-20.12	37.56	17.44	55.46	V



## 4.2 FREQUENCY STABILITY MEASUREMENT

### 4.2.1 LIMITS OF FREQUENCY STABILITY MEASUREMENT

The frequency stability shall be sufficient to ensure that the fundamental emission stays within the authorized frequency block.

### 4.2.2 TEST PROCEDURE

- Device is placed at the oven room. The oven room could control the temperatures and humidity. Power warm up is at least 15 min and power applied should perform before recording frequency error.
- EUT is connected the external power supply to control the DC input power. The test voltage range is from minimum to maximum working voltage. Each step shall be record the frequency error rate.
- The temperature range step is 10 degrees in this test items. All temperature levels shall be hold the  $\pm 0.5^{\circ}\text{C}$  during the measurement testing. The each temperature step shall be at least 0.5 hours, consider the EUT could be test under the stability condition.

**NOTE:** The frequency error was recorded frequency error from the communication simulator.

### 4.2.3 TEST SETUP

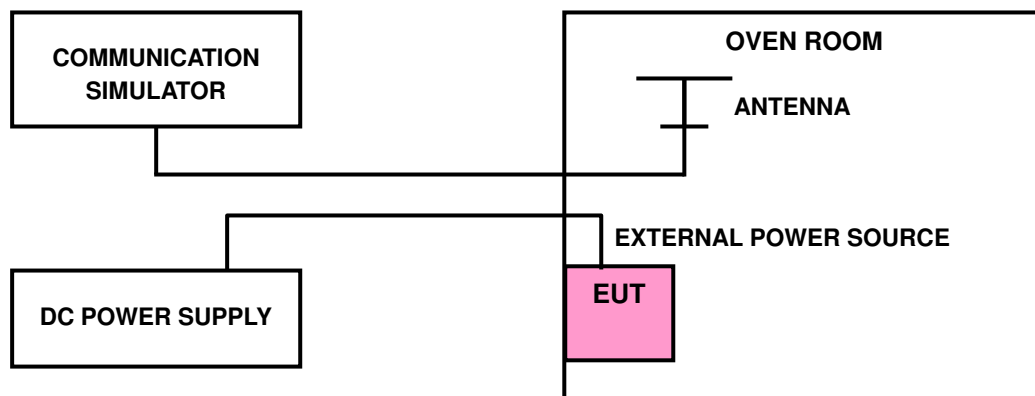

#### 4.2.4 TEST RESULTS

##### FREQUENCY ERROR vs. VOLTAGE

VOLTAGE (Volts)	FREQUENCY ERROR (ppm)							LIMIT (ppm)
	CDMA	LTE Band 25						
		1.4MHz	3MHz	5MHz	10MHz	15MHz	20MHz	
3.8	0.003	-0.0022	0.0010	-0.0010	-0.0020	-0.0015	-0.0012	2.5
3.6	0.006	-0.0037	-0.0013	-0.0012	-0.0038	-0.0019	-0.0024	2.5
4.35	0.004	0.0015	-0.0030	-0.0031	-0.0025	-0.0036	-0.0017	2.5

**NOTE:** The applicant defined the normal working voltage of the battery is from 3.6Vdc to 4.35Vdc.

##### FREQUENCY ERROR vs. TEMPERATURE

TEMP. (°C)	FREQUENCY ERROR (ppm)							LIMIT (ppm)
	CDMA	LTE Band 26						
		1.4MHz	3MHz	5MHz	10MHz	15MHz	20MHz	
-30	-0.007	-0.0021	-0.0029	-0.0033	0.0003	-0.0023	-0.0033	2.5
-20	0.008	0.0006	-0.0022	-0.0030	0.0007	-0.0020	-0.0007	2.5
-10	0.005	-0.0024	-0.0031	-0.0055	0.0013	0.0022	-0.0029	2.5
0	0.002	-0.0036	-0.0045	-0.0008	-0.0028	-0.0010	-0.0003	2.5
10	0.003	-0.0017	-0.0013	-0.0022	-0.0018	0.0004	-0.0017	2.5
20	-0.004	-0.0019	0.0009	0.0004	-0.0004	-0.0017	-0.0018	2.5
30	0.002	-0.0039	-0.0005	-0.0015	-0.0015	-0.0012	-0.0015	2.5
40	0.001	-0.0015	-0.0038	-0.0020	-0.0008	-0.0025	0.0010	2.5
50	-0.001	-0.0043	0.0013	-0.0023	-0.0011	0.0009	-0.0033	2.5
60	-0.001	-0.0013	0.0010	-0.0019	0.0014	0.0010	-0.0029	2.5

## 4.3 OCCUPIED BANDWIDTH MEASUREMENT

### 4.3.1 TEST PROCEDURES

The EUT makes a call to the communication simulator. All measurements were done at low, middle and high operational frequency range. The communication simulator station system controlled a EUT to export maximum output power under transmission mode and specific channel frequency. Use OBW measurement function of Spectrum analyzer to measure 99 % occupied bandwidth.

### 4.3.2 TEST SETUP

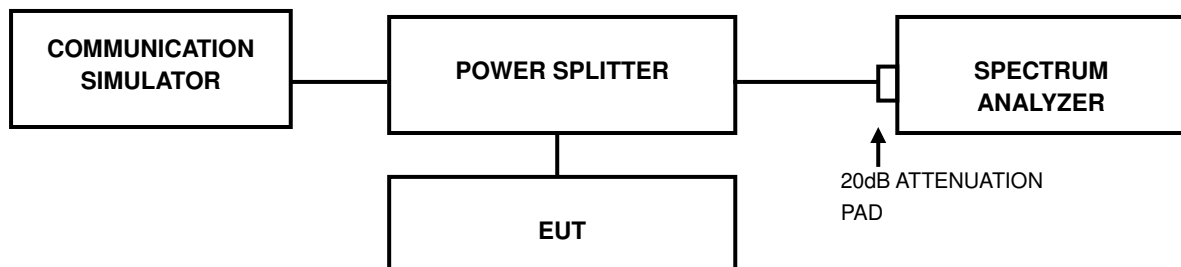



A D T

### 4.3.3 TEST RESULTS

CDMA			
CHANNEL	FREQUENCY	99% OCCUPIED BANDWIDTH (MHz)	26dB BANDWIDTH (MHz)
25	1851.25	1.2703	1.414
600	1880.00	1.2704	1.409
1175	1908.75	1.2709	1.408

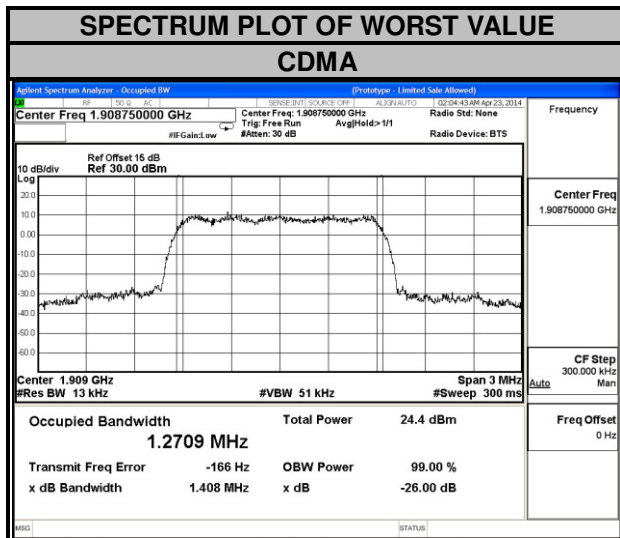



A D T

LTE BAND 25							
CHANNEL BANDWIDTH: 1.4MHz				CHANNEL BANDWIDTH: 3MHz			
CHANNEL	FREQUENCY	99% OCCUPIED BANDWIDTH (MHz)		CHANNEL	FREQUENCY	99% OCCUPIED BANDWIDTH (MHz)	
		QPSK	16QAM			QPSK	16QAM
26047	1850.7	1.0781	1.0768	26055	1851.5	2.6795	2.6805
26365	1882.5	1.0790	1.0779	26365	1882.5	2.6796	2.6807
26683	1914.3	1.0796	1.0767	26675	1913.5	2.6810	2.6796
CHANNEL	FREQUENCY	26dB BANDWIDTH (MHz)		CHANNEL	FREQUENCY	26dB BANDWIDTH (MHz)	
		QPSK	16QAM			QPSK	16QAM
26047	1850.7	1.223	1.229	26055	1851.5	2.872	2.879
26365	1882.5	1.231	1.226	26365	1882.5	2.870	2.874
26683	1914.3	1.225	1.236	26675	1913.5	2.879	2.889

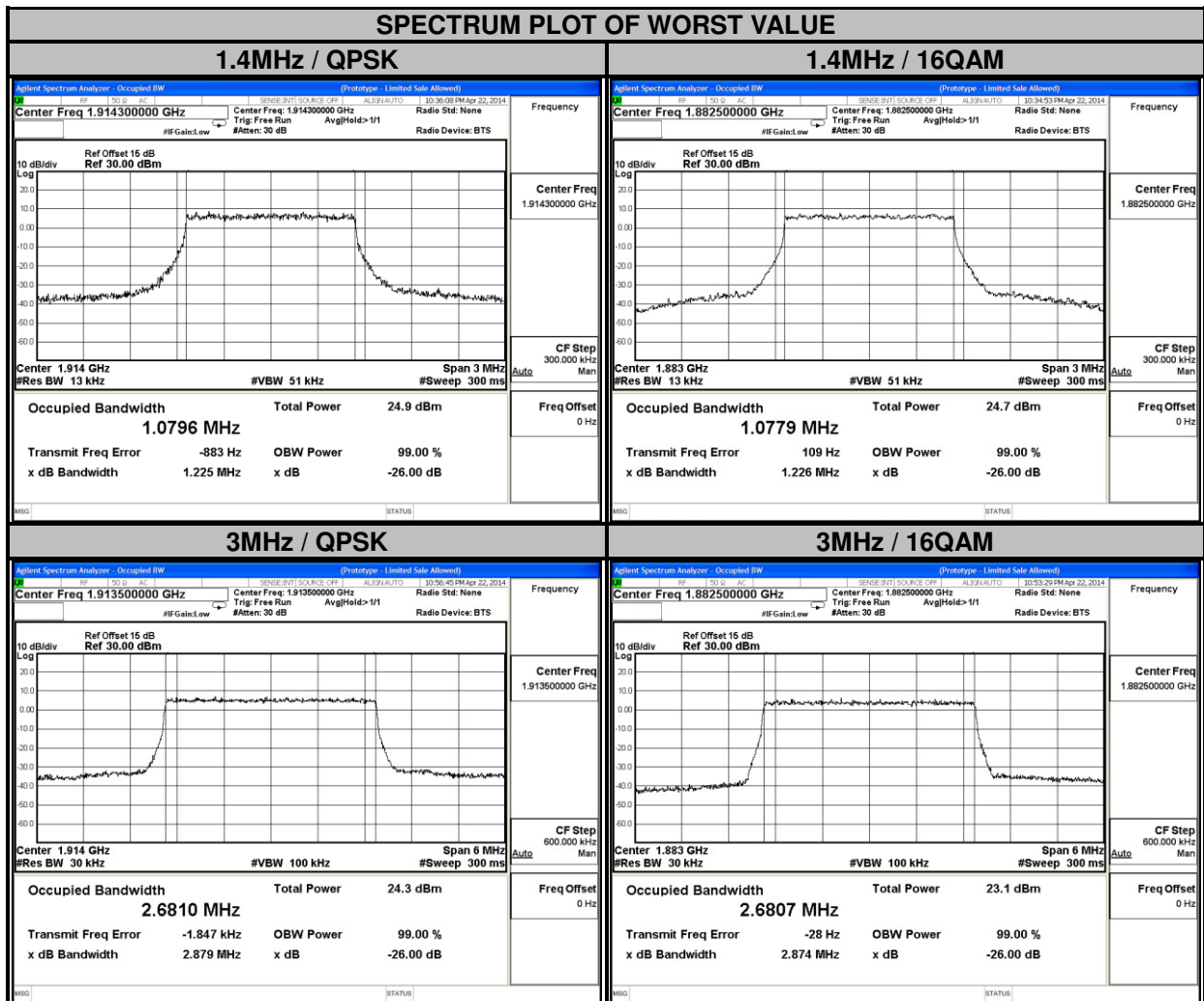



A D T

LTE BAND 25							
CHANNEL BANDWIDTH: 5MHz				CHANNEL BANDWIDTH: 10MHz			
CHANNEL	FREQUENCY	99% OCCUPIED BANDWIDTH (MHz)		CHANNEL	FREQUENCY	99% OCCUPIED BANDWIDTH (MHz)	
		QPSK	16QAM			QPSK	16QAM
26065	1852.5	4.4854	4.4918	26090	1855.0	8.9180	8.9172
26365	1882.5	4.4872	4.4871	26365	1882.5	8.9228	8.9203
26665	1912.5	4.4942	4.4882	26640	1910.0	8.9147	8.9058
CHANNEL	FREQUENCY	26dB BANDWIDTH (MHz)		CHANNEL	FREQUENCY	26dB BANDWIDTH (MHz)	
		QPSK	16QAM			QPSK	16QAM
26065	1852.5	4.807	4.807	26090	1855.0	9.342	9.350
26365	1882.5	4.820	4.809	26365	1882.5	9.374	9.357
26665	1912.5	4.832	4.790	26640	1910.0	9.343	9.315

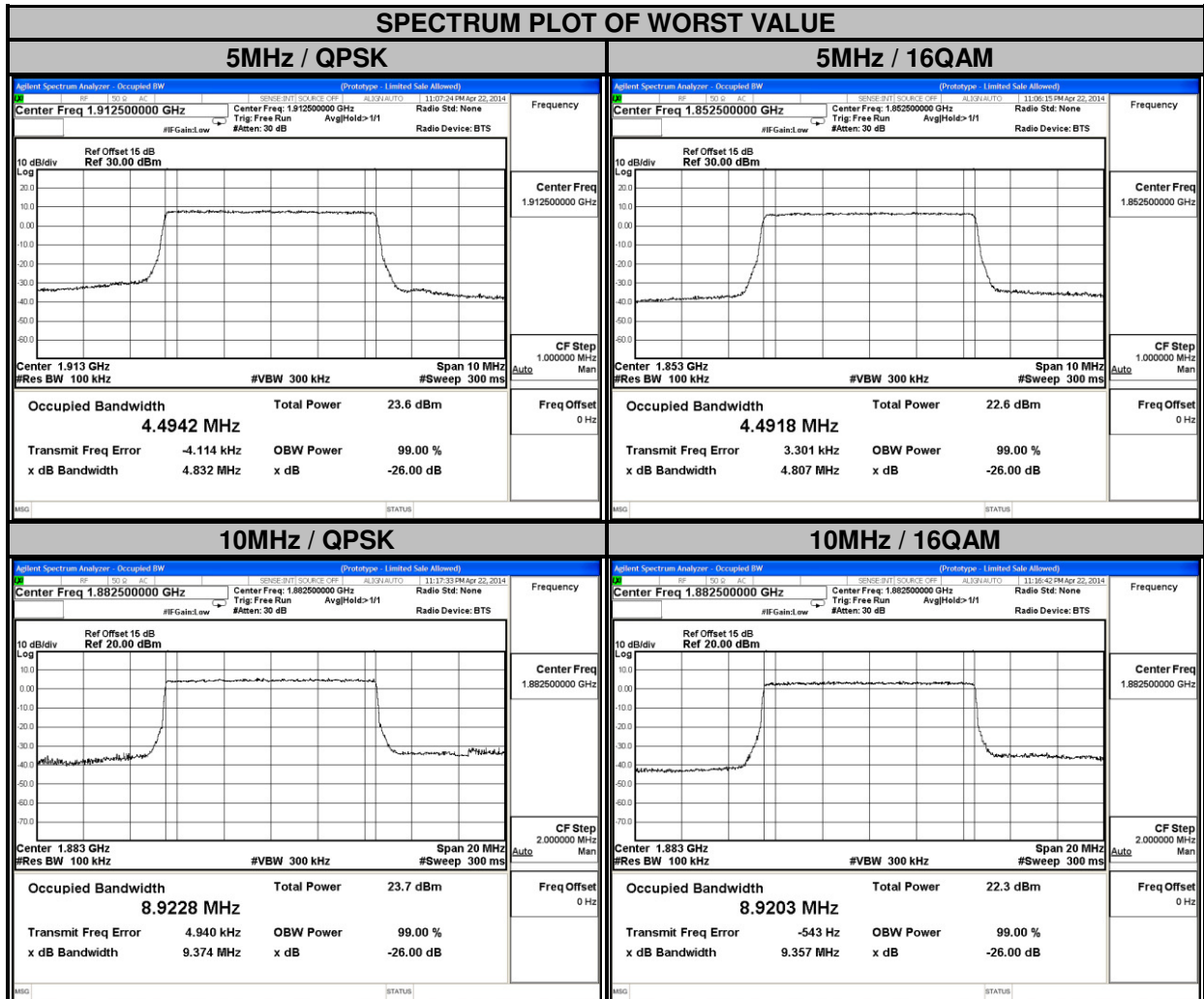



A D T

LTE BAND 25							
CHANNEL BANDWIDTH: 15MHz				CHANNEL BANDWIDTH: 20MHz			
CHANNEL	FREQUENCY	99% OCCUPIED BANDWIDTH (MHz)		CHANNEL	FREQUENCY	99% OCCUPIED BANDWIDTH (MHz)	
		QPSK	16QAM			QPSK	16QAM
26115	1857.5	13.368	13.363	26140	1860	17.800	17.805
26365	1882.5	13.370	13.365	26365	1882.5	17.799	17.813
26615	1907.5	13.357	13.359	26590	1905	17.808	17.811
CHANNEL	FREQUENCY	26dB BANDWIDTH (MHz)		CHANNEL	FREQUENCY	26dB BANDWIDTH (MHz)	
		QPSK	16QAM			QPSK	16QAM
26115	1857.5	13.970	13.960	26140	1860	18.480	18.500
26365	1882.5	13.920	13.920	26365	1882.5	18.520	18.510
26615	1907.5	13.960	13.940	26590	1905	18.560	18.490

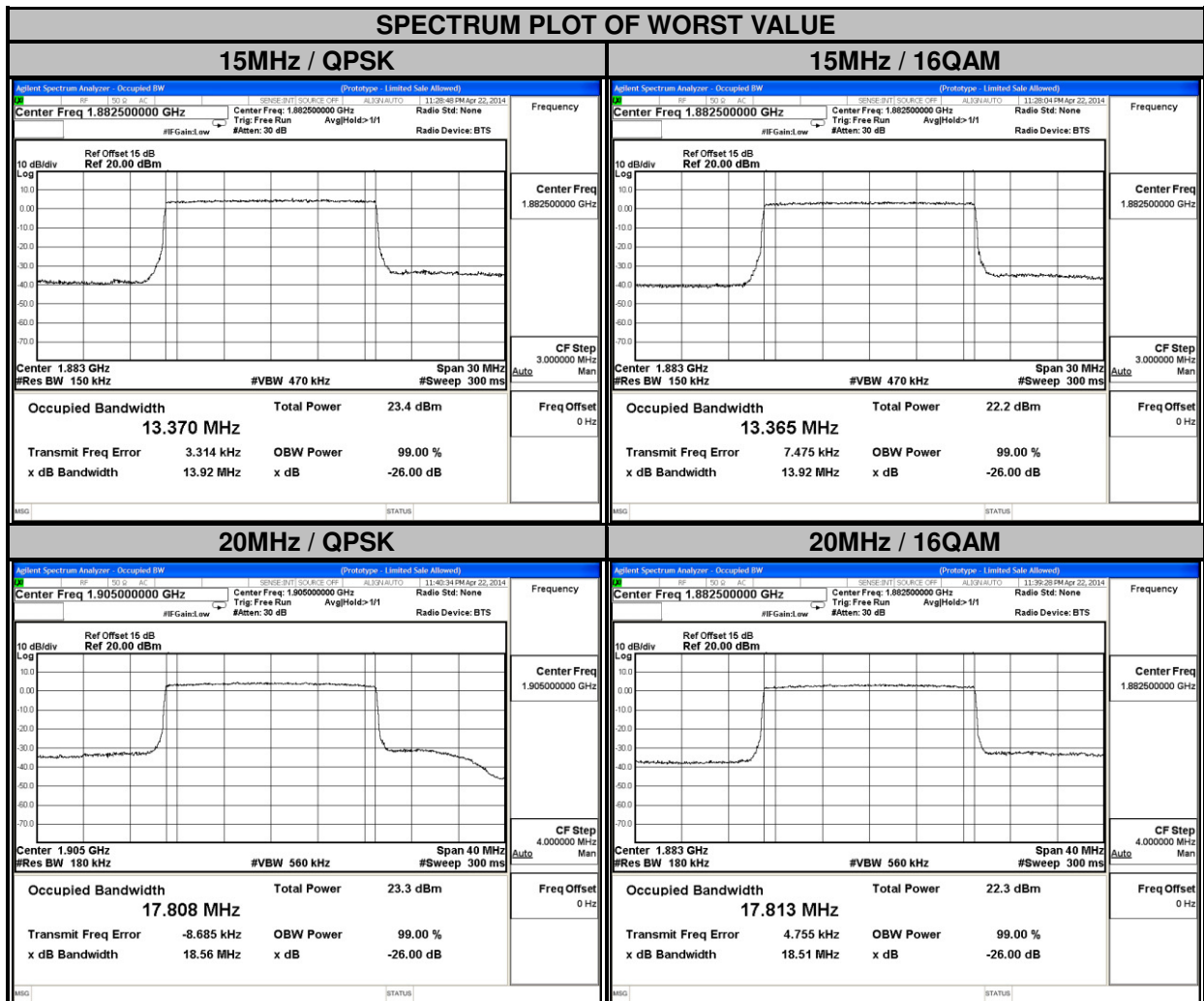

## 4.4 PEAK TO AVERAGE RATIO

### 4.4.1 LIMITS OF PEAK TO AVERAGE RATIO MEASUREMENT

In measuring transmissions in this band using an average power technique, the peak to-average ratio (PAR) of the transmission may not exceed 13 dB.

### 4.4.2 TEST SETUP

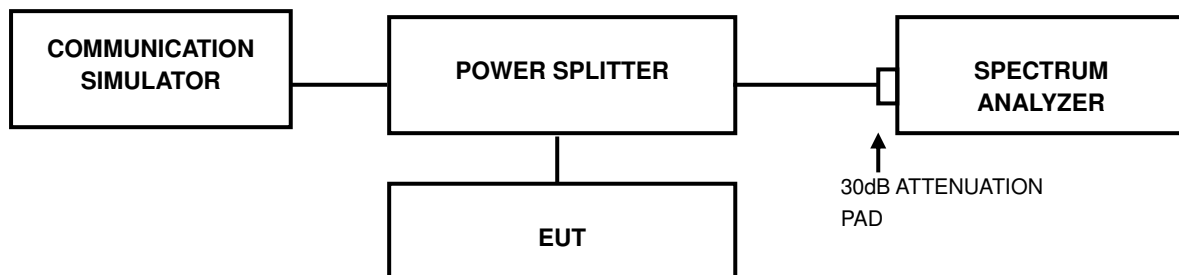

### 4.4.3 TEST PROCEDURES

1. Set resolution/measurement bandwidth  $\geq$  signal's occupied bandwidth;
2. Set the number of counts to a value that stabilizes the measured CCDF curve;
3. Record the maximum PAPR level associated with a probability of 0.1%.





A D T

#### 4.4.4 TEST RESULTS

CHANNEL	FREQUENCY (MHz)	PEAK TO AVERAGE RATIO (dB)
		CDMA
25	1851.25	3.53
600	1880.00	4.44
1175	1908.75	4.00

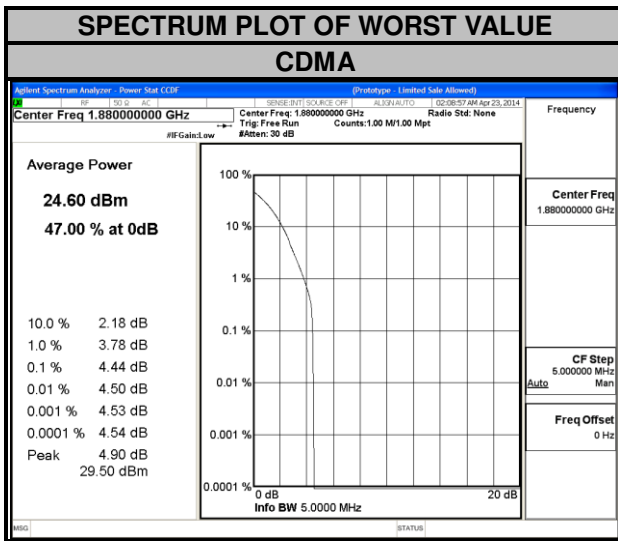



A D T

LTE BAND 25							
CHANNEL BANDWIDTH: 1.4MHz				CHANNEL BANDWIDTH: 3MHz			
CHANNEL	FREQUENCY (MHz)	PEAK TO AVERAGE RATIO (dB)		CHANNEL	FREQUENCY (MHz)	PEAK TO AVERAGE RATIO (dB)	
		QPSK	16QAM			QPSK	16QAM
26047	1850.7	4.26	4.52	26055	1851.5	4.36	4.71
26365	1882.5	4.47	5.61	26365	1882.5	4.56	5.58
26683	1914.3	3.94	5.20	26675	1913.5	3.78	5.07

**SPECTRUM PLOT OF WORST VALUE**

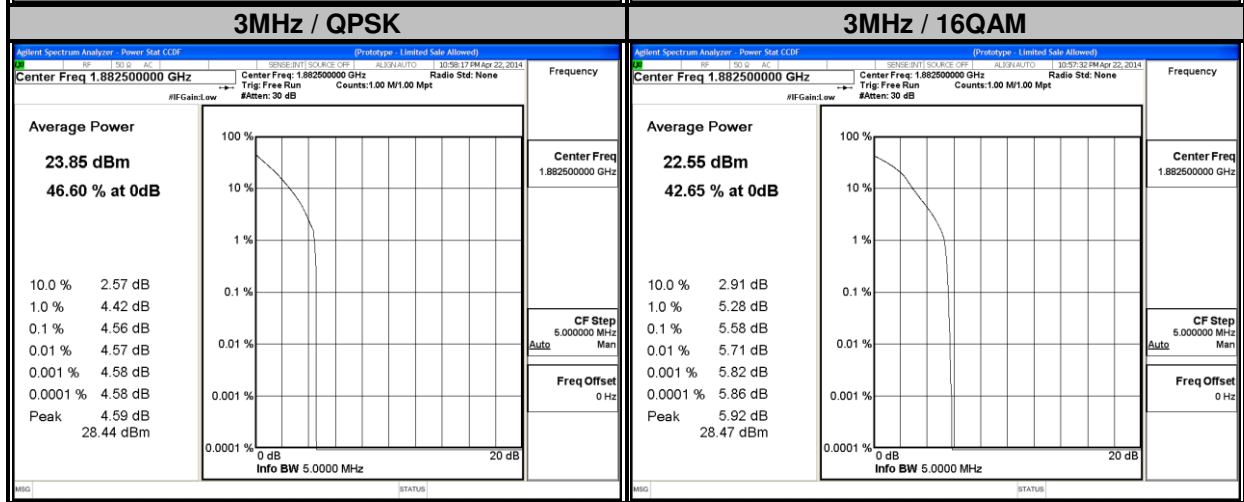
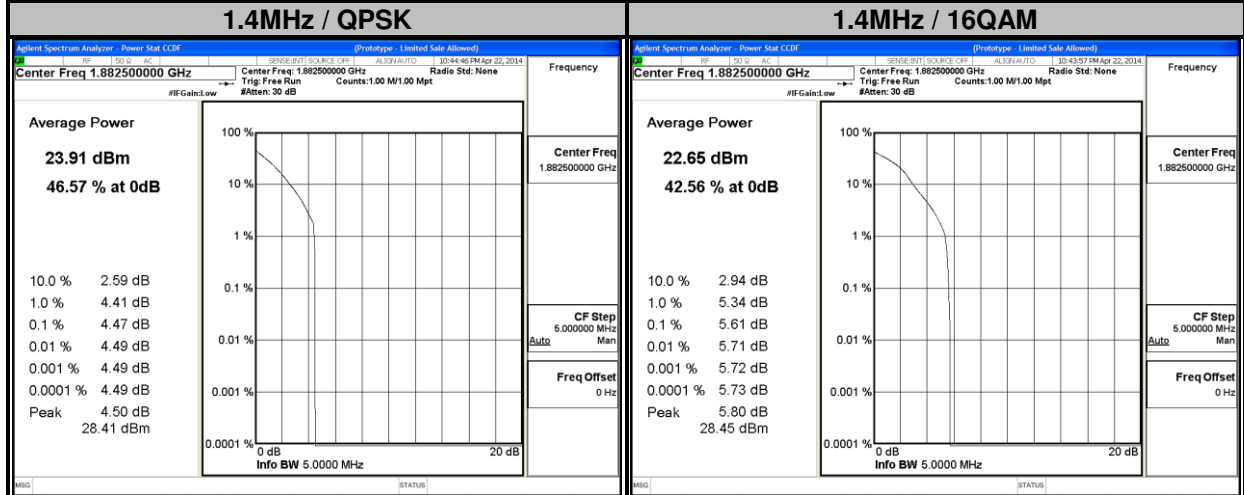



A D T

LTE BAND 25							
CHANNEL BANDWIDTH: 5MHz				CHANNEL BANDWIDTH: 10MHz			
CHANNEL	FREQUENCY (MHz)	PEAK TO AVERAGE RATIO (dB)		CHANNEL	FREQUENCY (MHz)	PEAK TO AVERAGE RATIO (dB)	
		QPSK	16QAM			QPSK	16QAM
26065	1852.5	4.40	4.68	26090	1855.0	4.45	4.73
26365	1882.5	4.33	5.50	26365	1882.5	4.41	5.44
26665	1912.5	3.73	5.05	26640	1910.0	4.23	5.49

**SPECTRUM PLOT OF WORST VALUE**

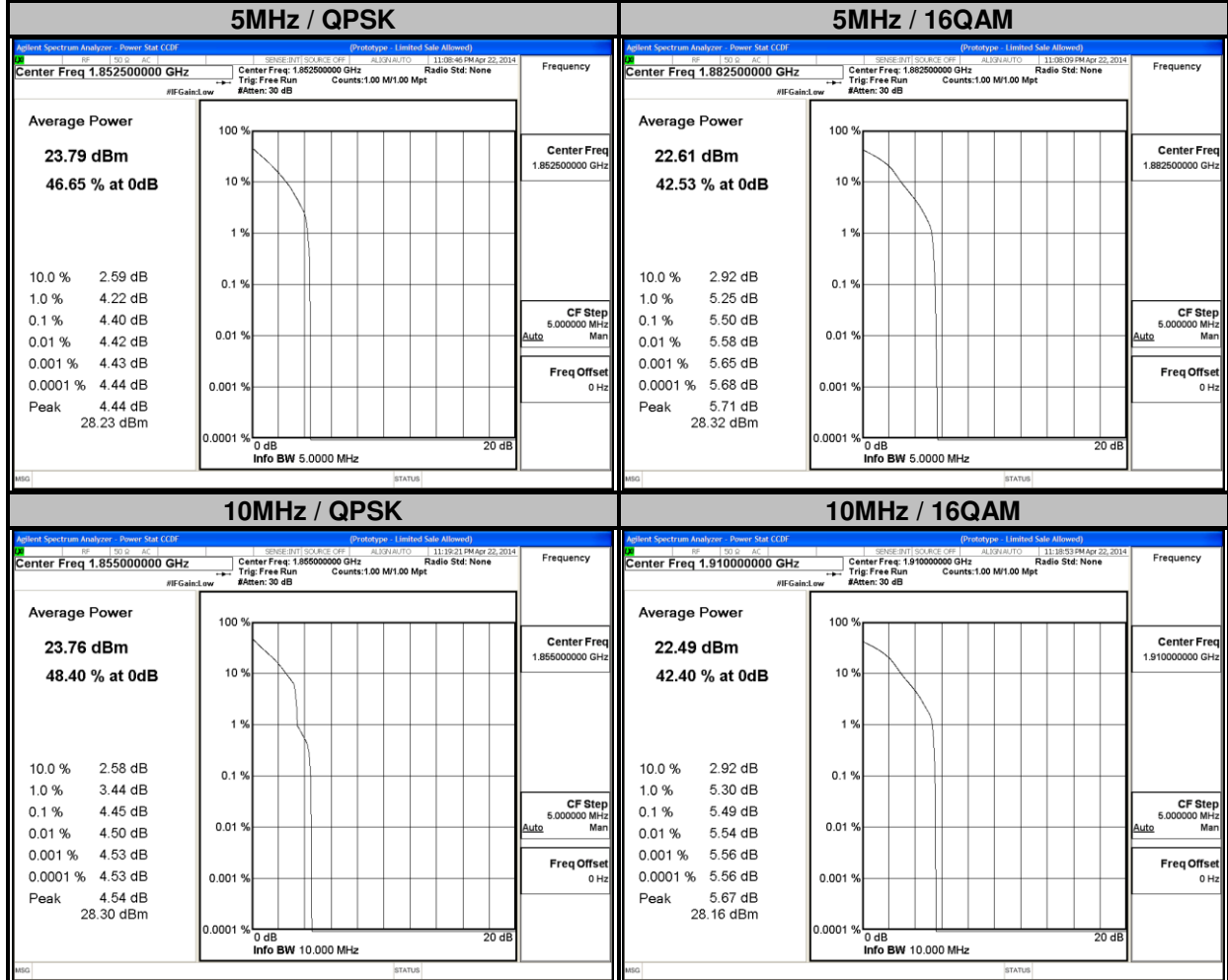



A D T

LTE BAND 25							
CHANNEL BANDWIDTH: 15MHz				CHANNEL BANDWIDTH: 20MHz			
CHANNEL	FREQUENCY (MHz)	PEAK TO AVERAGE RATIO (dB)		CHANNEL	FREQUENCY (MHz)	PEAK TO AVERAGE RATIO (dB)	
		QPSK	16QAM			QPSK	16QAM
26115	1857.5	4.44	4.63	26140	1860.0	4.33	4.55
26365	1882.5	4.32	5.37	26365	1882.5	4.18	5.39
26615	1907.5	4.36	5.46	26590	1905.0	4.19	5.40

**SPECTRUM PLOT OF WORST VALUE**

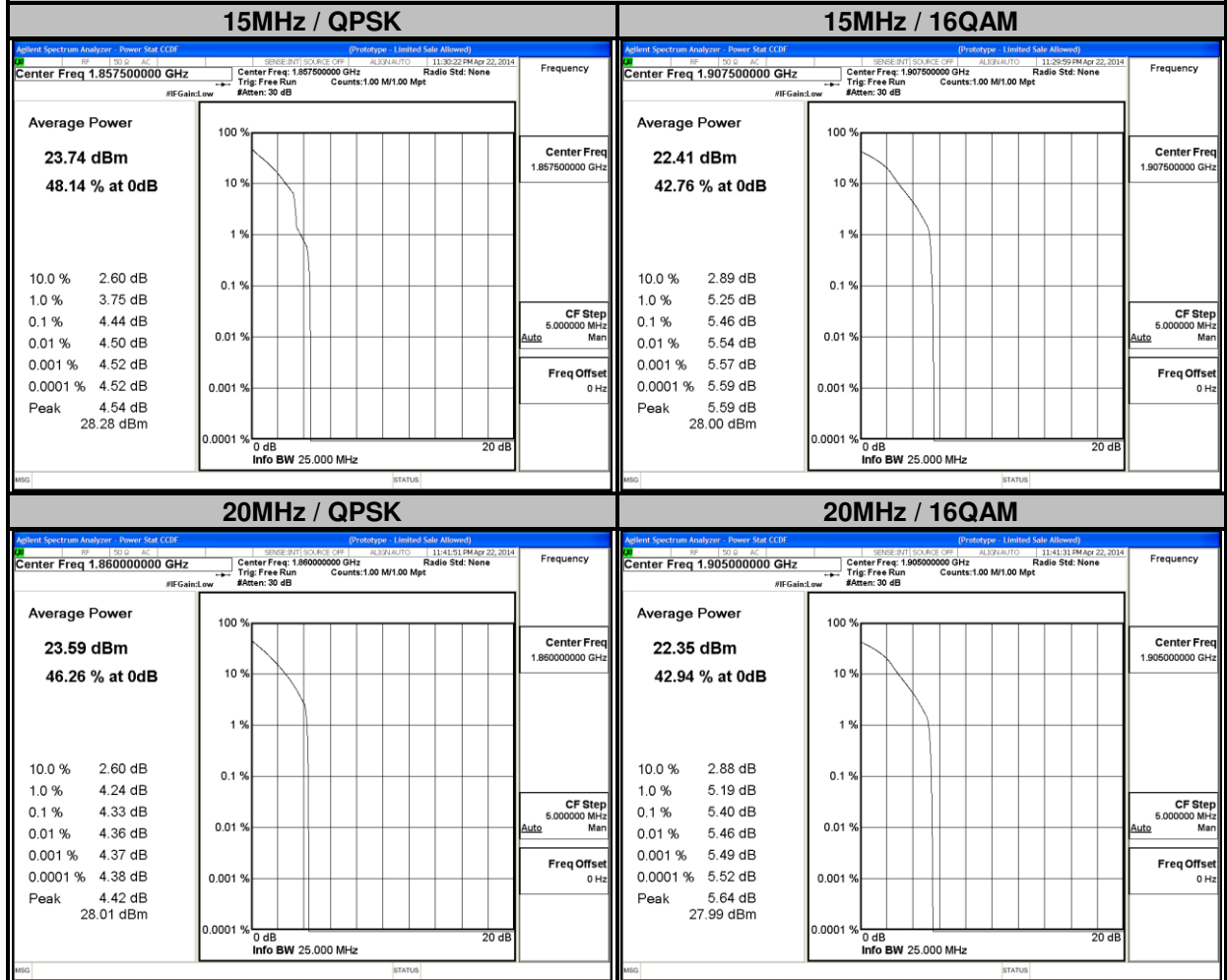

## 4.5 BAND EDGE MEASUREMENT

### 4.5.1 LIMITS OF BAND EDGE MEASUREMENT

Power of any emission outside of the authorized operating frequency ranges must be attenuated below the transmitting power (P) by a factor of at least  $43 + 10 \log(P)$  dB. In the 1 MHz bands immediately outside and adjacent to the frequency block a resolution bandwidth of at least one percent of the emission bandwidth of the fundamental emission of the transmitter may be employed.

### 4.5.2 TEST SETUP

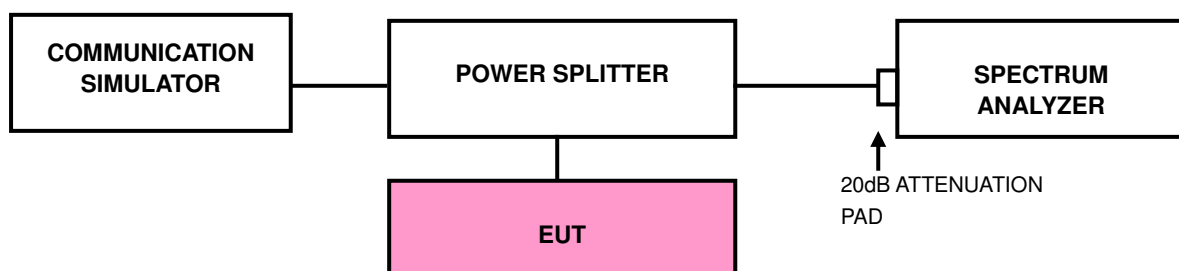

### 4.5.3 TEST PROCEDURES

- a. All measurements were done at low and high operational frequency range.
- b. The center frequency of spectrum is the band edge frequency and span is 1MHz. RB of the spectrum is 13kHz and VB of the spectrum is 51kHz (CDMA/LTE Channel Bandwidth 1.4MHz).
- c. The center frequency of spectrum is the band edge frequency and span is 1MHz. RB of the spectrum is 30kHz and VB of the spectrum is 100kHz (LTE Channel Bandwidth 3MHz).
- d. The center frequency of spectrum is the band edge frequency and span is 1MHz. RB of the spectrum is 100kHz and VB of the spectrum is 300kHz (LTE Channel Bandwidth 5MHz/10MHz).
- e. The center frequency of spectrum is the band edge frequency and span is 1MHz. RB of the spectrum is 150kHz and VB of the spectrum is 470kHz (LTE Channel Bandwidth 15MHz).
- f. The center frequency of spectrum is the band edge frequency and span is 1MHz. RB of the spectrum is 180kHz and VB of the spectrum is 560kHz (LTE Channel Bandwidth 20MHz).
- g. Record the max trace plot into the test report.



A D T

### 4.5.4 TEST RESULTS

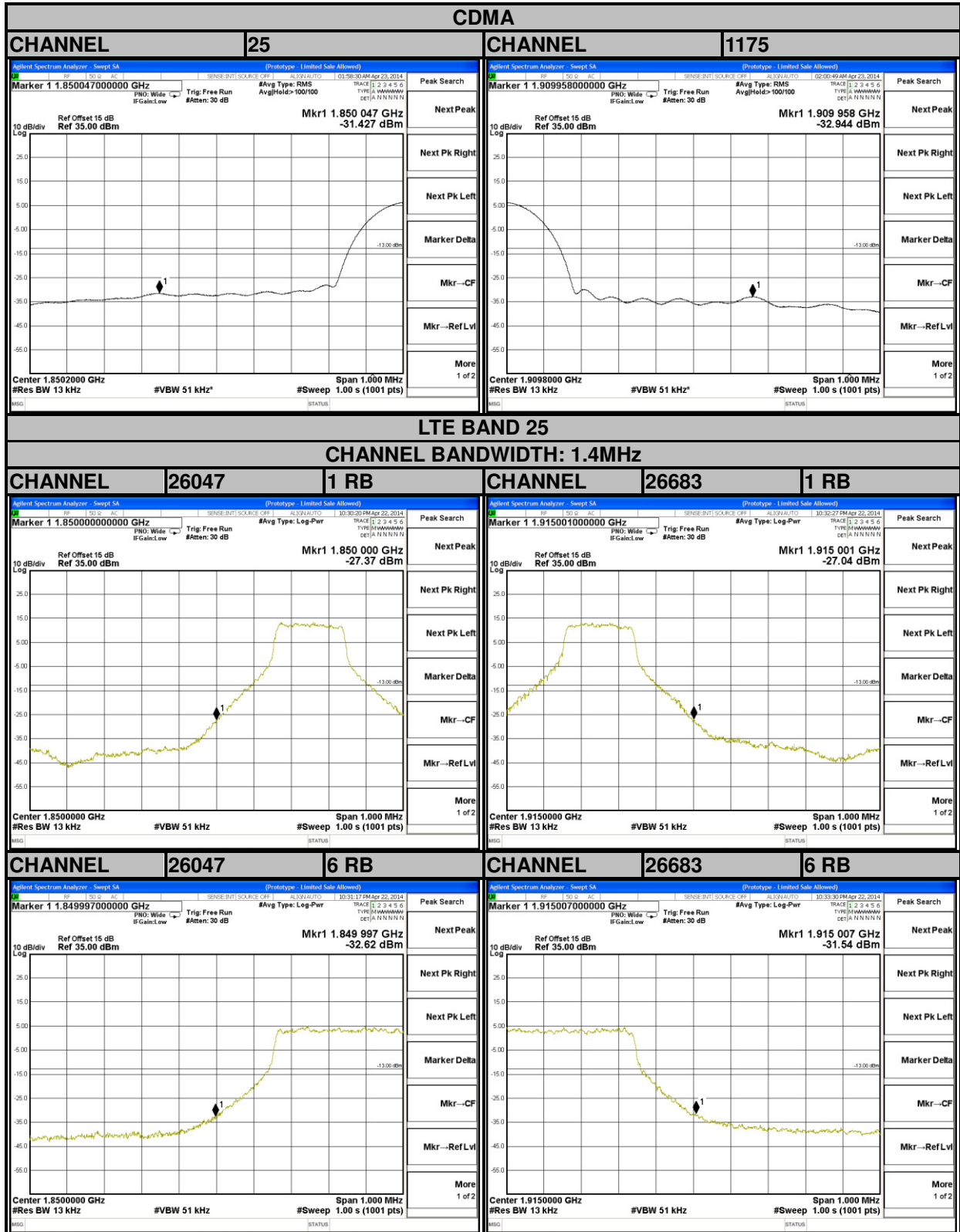



A D T

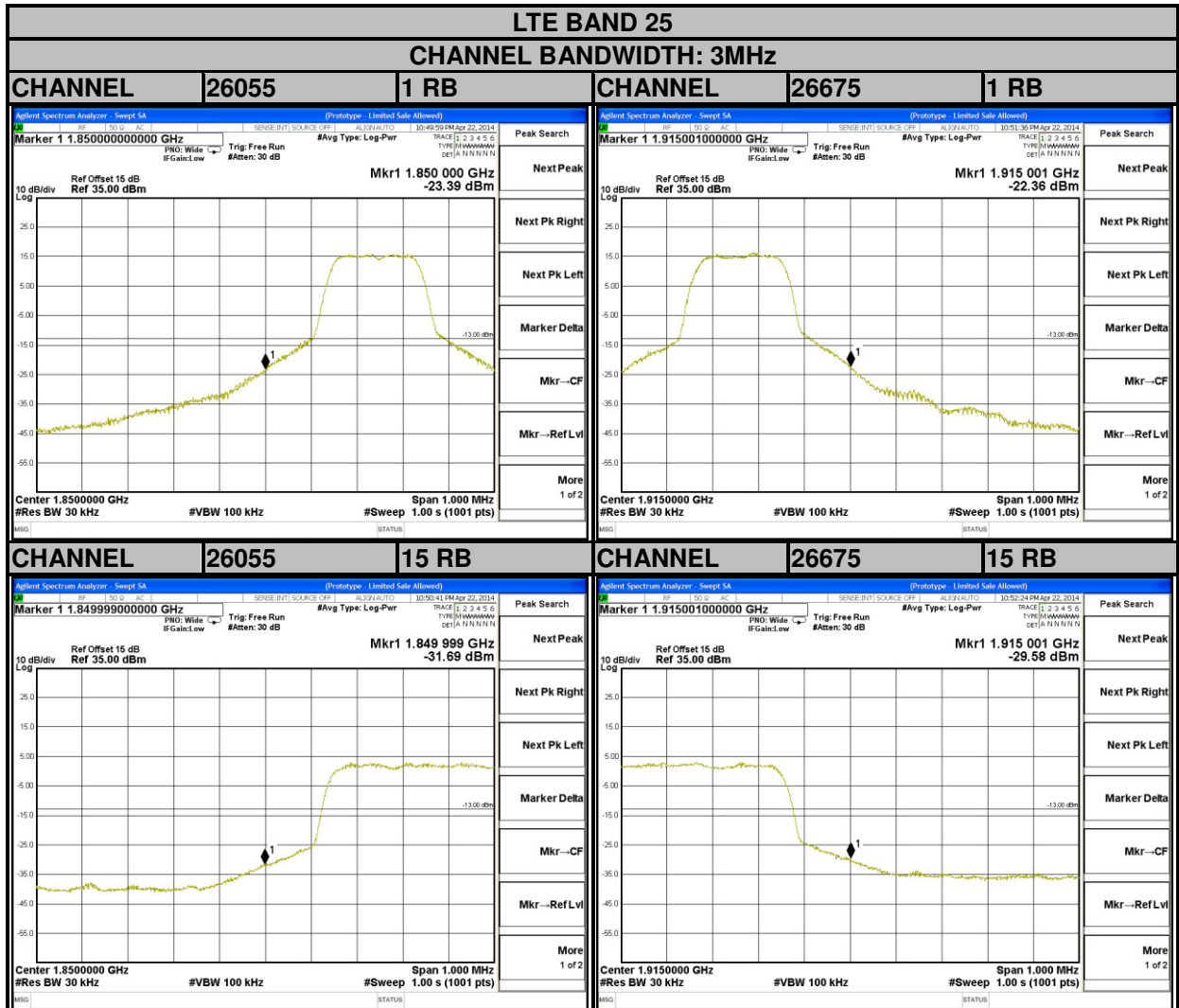



A D T

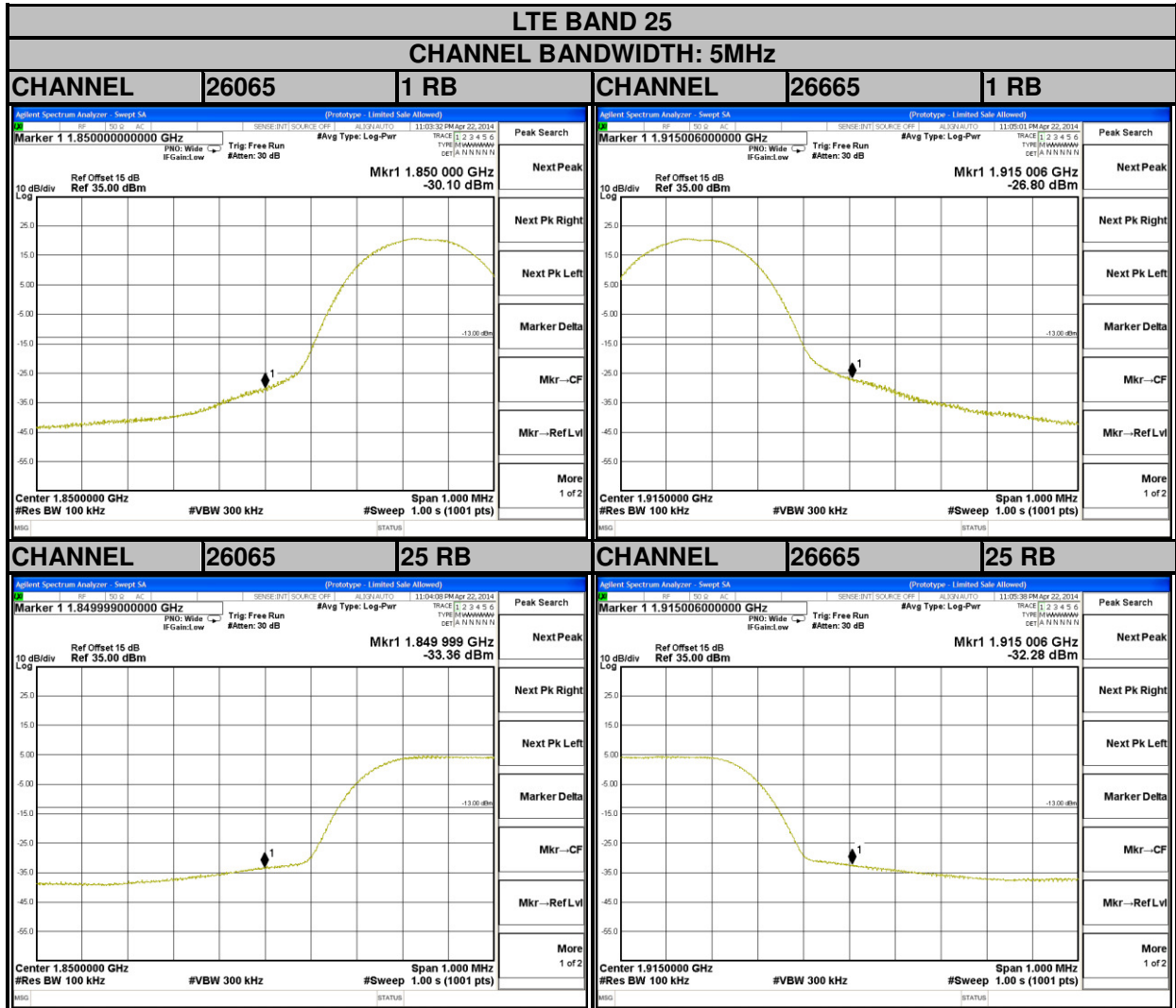





A D T

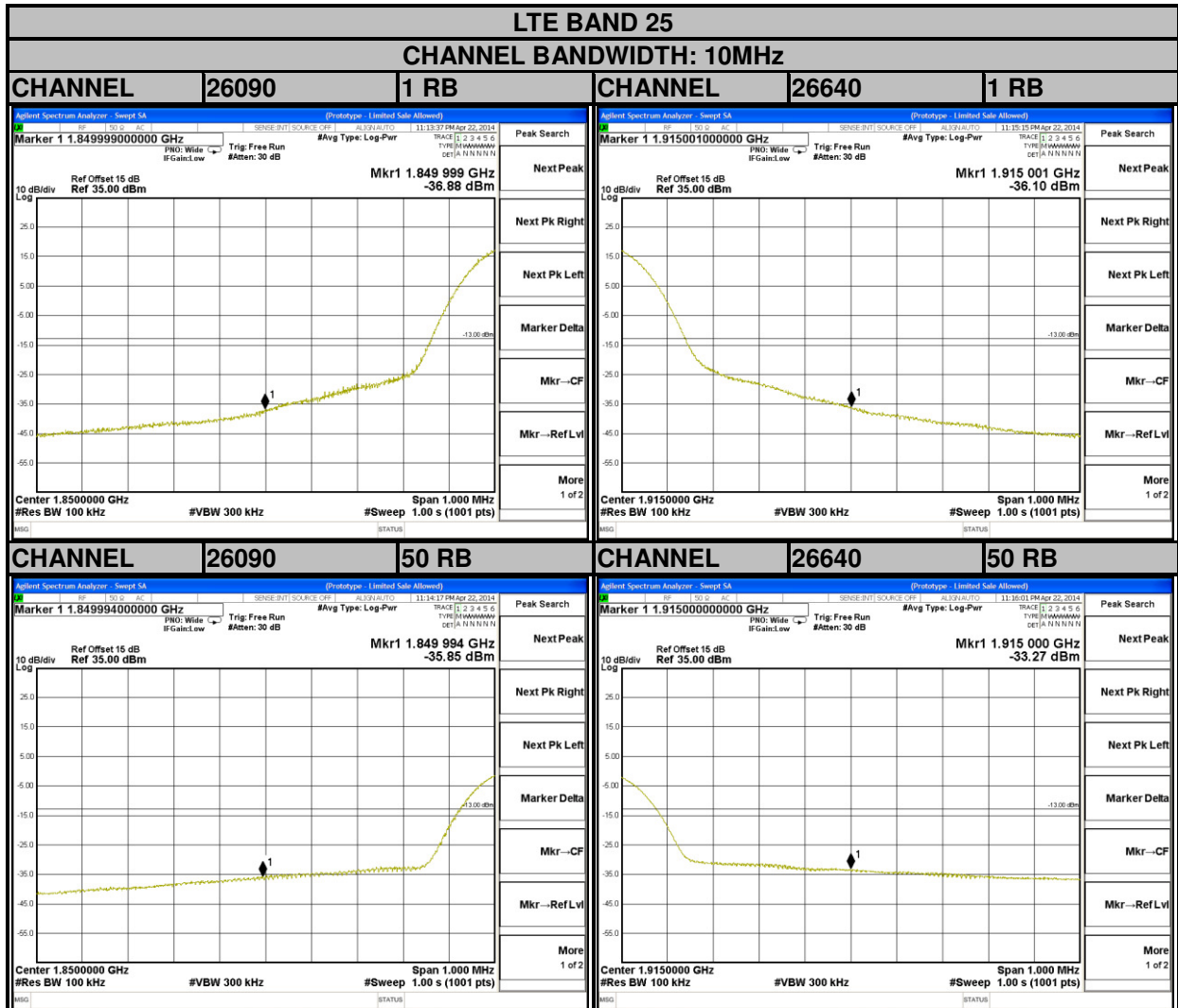



A D T

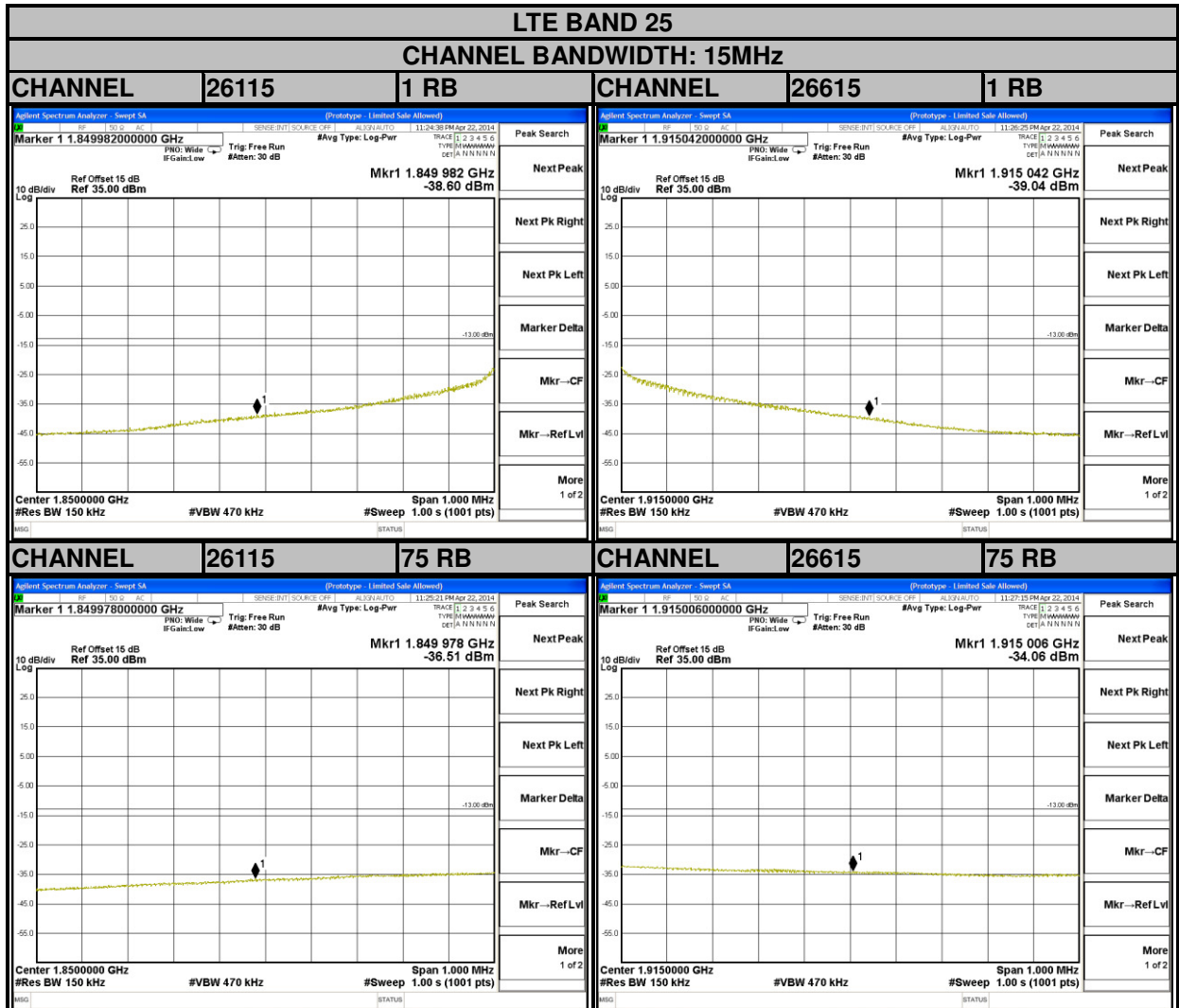



A D T

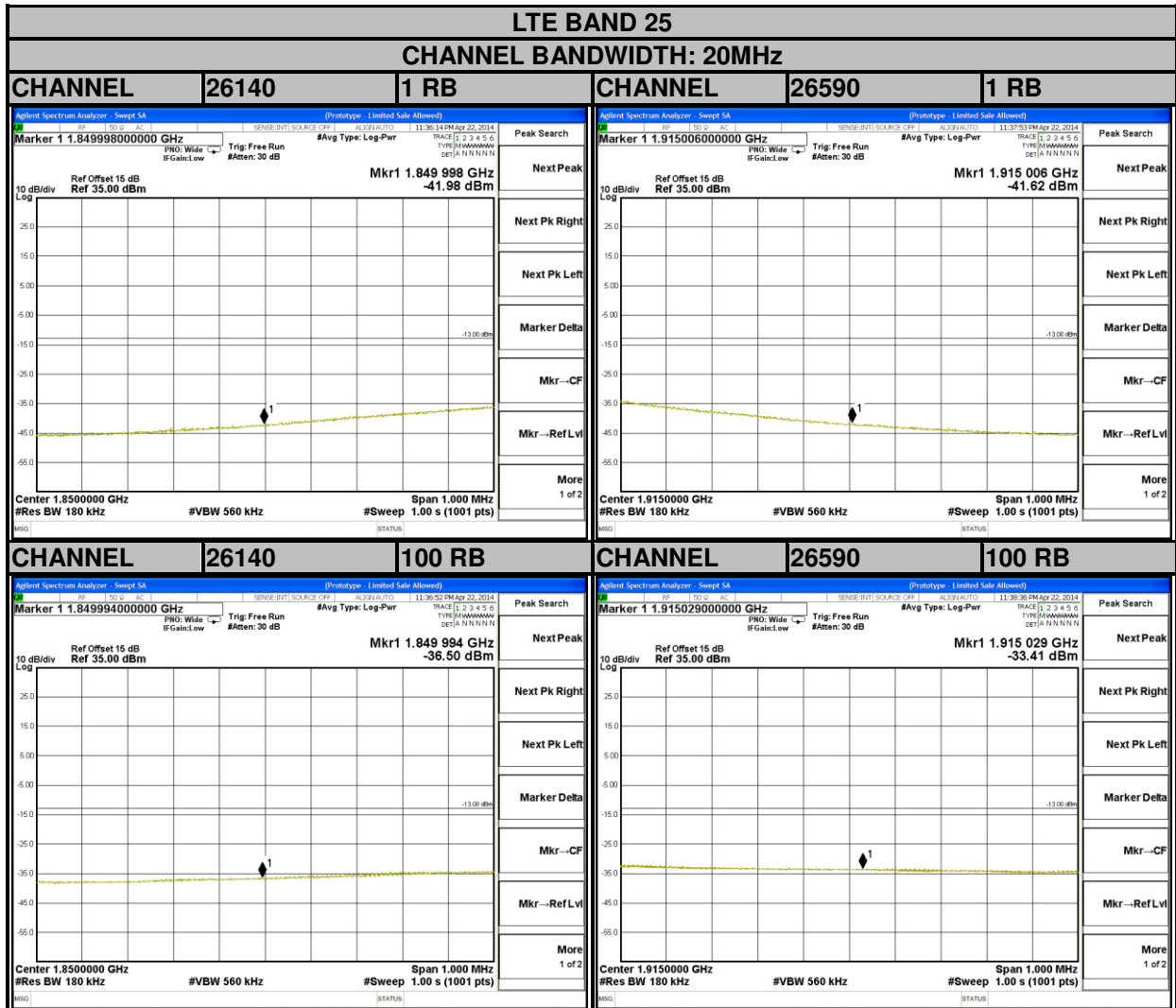

## 4.6 CONDUCTED SPURIOUS EMISSIONS

### 4.6.1 LIMITS OF CONDUCTED SPURIOUS EMISSIONS MEASUREMENT

The power of any emission outside of the authorized operating frequency ranges must be attenuated below the transmitting power (P) by a factor of at least  $43 + 10 \log(P)$  dB. The emission limit is equal to -13dBm.

### 4.6.2 TEST PROCEDURE

- The EUT makes a phone call to the communication simulator. All measurements were done at low, middle and high operational frequency range.
- Measuring frequency range is from 30 MHz to 19.1GHz. 10dB attenuation pad is connected with spectrum. RBW=1MHz and VBW=3MHz is used for conducted emission measurement.

### 4.6.3 TEST SETUP

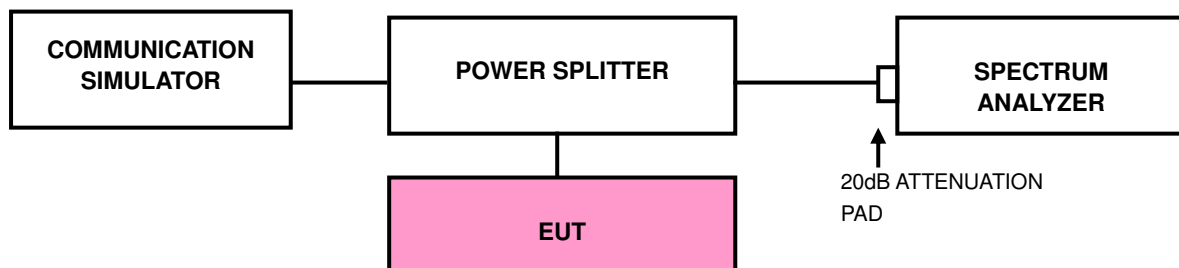



A D T

#### 4.6.4 TEST RESULTS

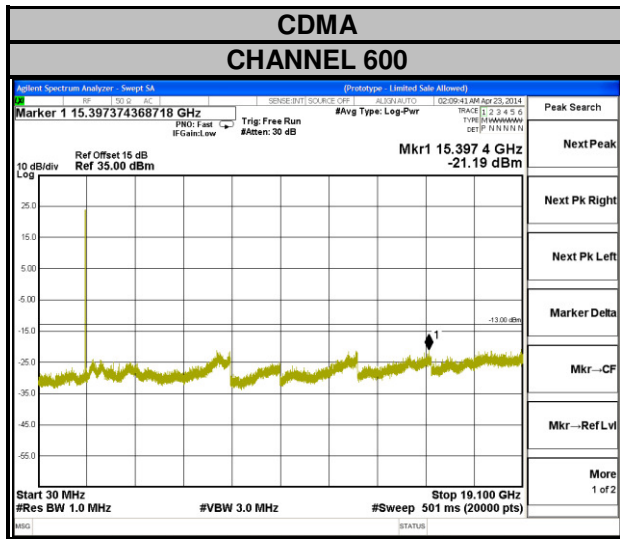



A D T

### LTE Band 25 CHANNEL 26365

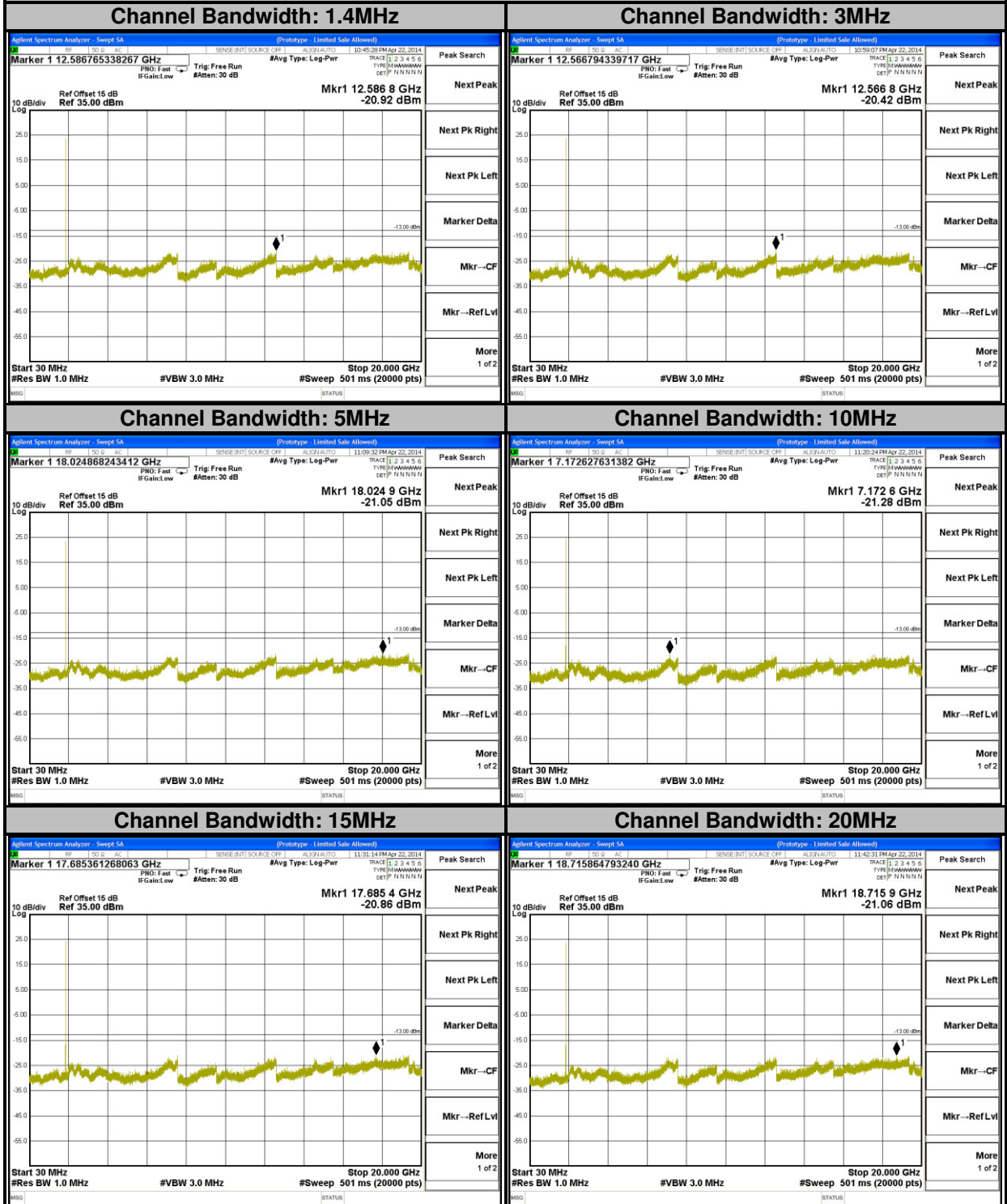

## 4.7 RADIATED EMISSION MEASUREMENT

### 4.7.1 LIMITS OF RADIATED EMISSION MEASUREMENT

The power of any emission outside of the authorized operating frequency ranges must be attenuated below the transmitting power (P) by a factor of at least  $43 + 10 \log(P)$  dB. The emission limit is equal to -13dBm.

### 4.7.2 TEST PROCEDURES

- a. Substitution method is used for E.I.R.P measurement. In the semi-anechoic chamber, EUT placed on the 0.8m height of Turn Table, rotated the table around 360 degrees to search the maximum radiation power and receiver antenna shall be rotated vertical and horizontal polarization and moved height from 1m to 4m to find the maximum polar radiated power. The “Read Value” is the spectrum reading the maximum power value.
- b. The substitution horn antenna is substituted for EUT at the same position and signals generator export the CW signal to the substitution antenna via a TX cable. Rotated the Turn Table and moved receiving antenna to find the maximum radiation power. Adjust output power level of S.G to get a Value of spectrum reading equal to “Read Value” of step a. Record the power level of S.G
- c. EIRP = Output power level of S.G – TX cable loss + Antenna gain of substitution horn.
- d. E.R.P power can be calculated form E.I.R.P power by subtracting the gain of dipole, E.R.P power = E.I.R.P power - 2.15dBi.

**NOTE:** The resolution bandwidth and video bandwidth of test receiver/spectrum analyzer is 1MHz/3MHz.

### 4.7.3 DEVIATION FROM TEST STANDARD

No deviation

#### 4.7.4 TEST SETUP

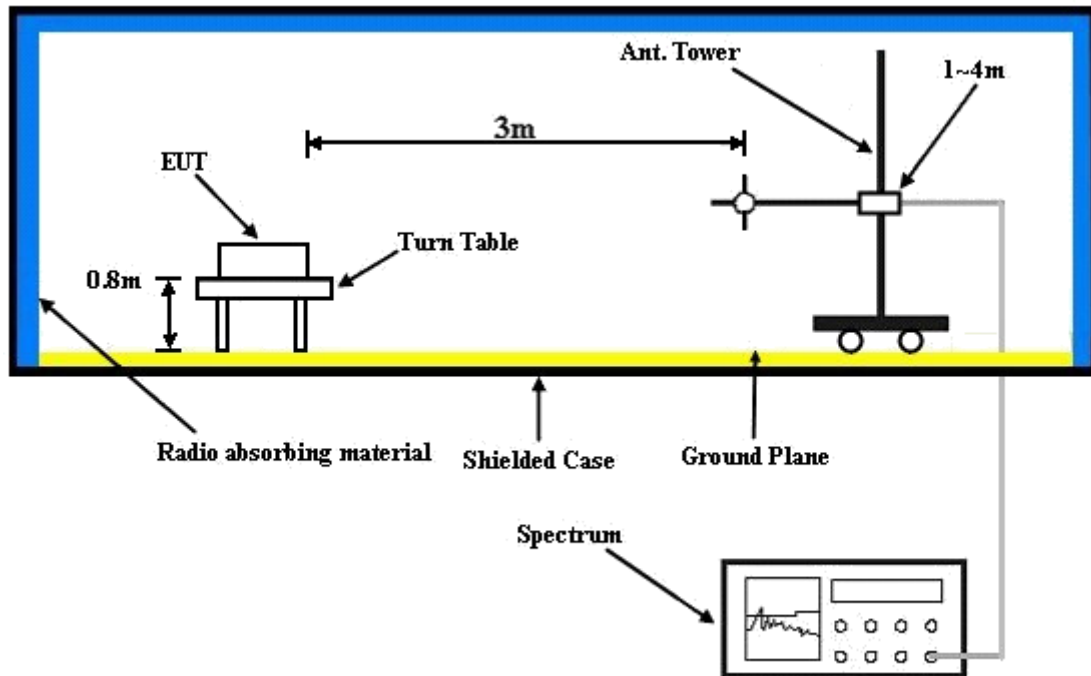

For the actual test configuration, please refer to the attached file (Test Setup Photo).





A D T

### 4.7.5 TEST RESULTS

MODE A

CDMA:



Bureau Veritas Consumer Products Services Ltd., Taoyuan Branch

A D T

Data: 15

Date: 2014-04-19

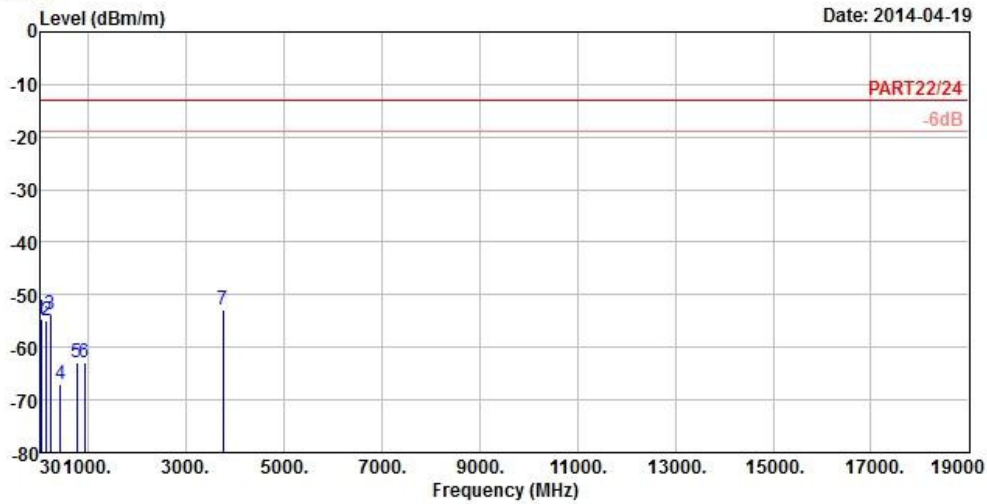

Site : 966 Chamber 5  
 Condition: PART22/24 3m HORIZONTAL  
 Remark : 1XRTT1900 Link  
 Tested by: Johnson Liao  
 Plane : Y

	Freq	Level	Read Level	Limit Line	Over Limit	Factor	Remark
	MHz	dBm/m	dBm	dBm/m	dB	dB/m	
1	41.34	-54.52	-53.13	-13.00	-41.52	-1.39	Peak
2	139.08	-54.79	-48.86	-13.00	-41.79	-5.93	Peak
3	230.34	-53.66	-47.11	-13.00	-40.66	-6.55	Peak
4	431.60	-66.96	-62.13	-13.00	-53.96	-4.83	Peak
5	764.80	-62.82	-64.71	-13.00	-49.82	1.89	Peak
6	930.70	-62.76	-66.07	-13.00	-49.76	3.31	Peak
7 pp	3760.00	-52.77	-44.47	-13.00	-39.77	-8.30	Peak



A D T



Bureau Veritas Consumer Products Services Ltd., Taoyuan Branch

A D T

Data: 16

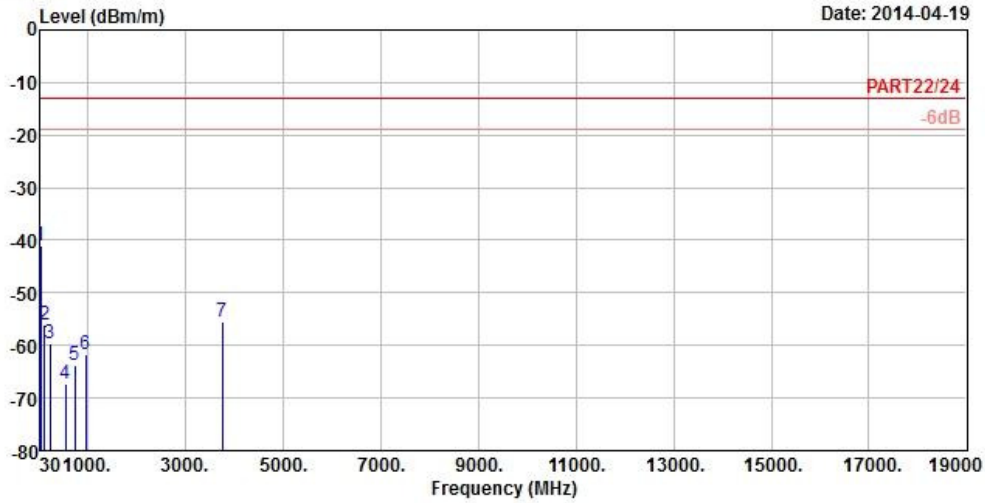

Site : 966 Chamber 5  
 Condition: PART22/24 3m VERTICAL  
 Remark : 1XRTT1900 Link  
 Tested by: Johnson Liao  
 Plane : Y

	Freq	Level	Read Level	Limit Line	Over Limit	Factor	Remark
	MHz	dBm/m	dBm	dBm/m	dB	dB/m	
1	pp	39.99	-41.18	-39.65	-13.00	-28.18	-1.53 Peak
2		108.57	-56.19	-45.60	-13.00	-43.19	-10.59 Peak
3		226.56	-59.54	-52.81	-13.00	-46.54	-6.73 Peak
4		549.90	-67.30	-65.57	-13.00	-54.30	-1.73 Peak
5		735.40	-63.87	-65.56	-13.00	-50.87	1.69 Peak
6		952.40	-61.63	-65.36	-13.00	-48.63	3.73 Peak
7		3760.00	-55.36	-47.06	-13.00	-42.36	-8.30 Peak



A D T

LTE BAND 25  
CHANNEL BANDWIDTH: 1.4MHz / QPSK



Bureau Veritas Consumer Products Services Ltd., Taoyuan Branch

A D T

Data: 15

Date: 2014-04-20

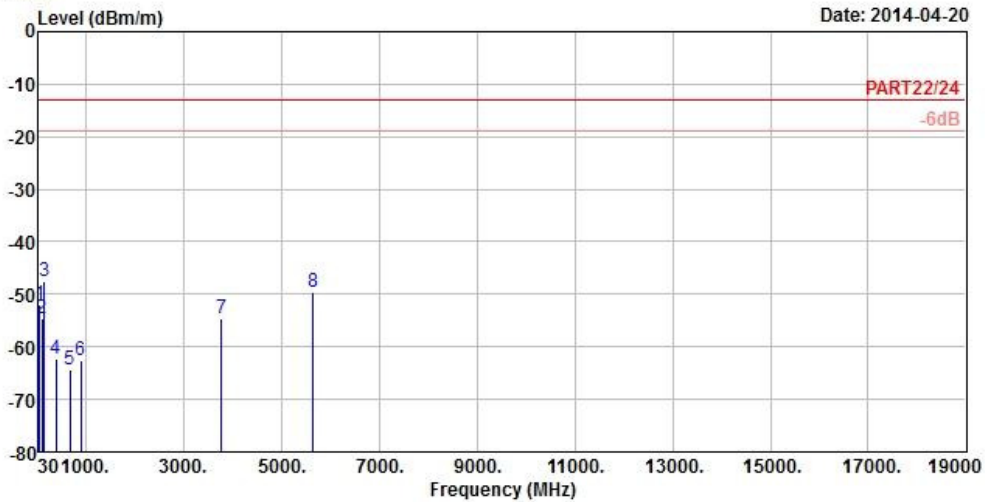

Site : 966 Chamber 5  
 Condition: PART22/24 3m HORIZONTAL  
 Remark : LTE Band 25\_1.4M\_QPSK(1,2) Link  
 Tested by: PeterWeng  
 Plane : Z

	Read	Limit	Over			
Freq	Level	Level	Line	Limit	Factor	Remark
MHz	dBm/m	dBm	dBm/m	dB	dB/m	
1	57.00	-51.88	-46.23	-13.00	-38.88	-5.65 Peak
2	104.52	-54.54	-44.04	-13.00	-41.54	-10.50 Peak
3	153.12	-47.62	-41.21	-13.00	-34.62	-6.41 Peak
4	377.70	-62.36	-56.55	-13.00	-49.36	-5.81 Peak
5	668.20	-64.33	-65.20	-13.00	-51.33	0.87 Peak
6	891.50	-62.55	-65.20	-13.00	-49.55	2.65 Peak
7	3765.00	-54.69	-46.45	-13.00	-41.69	-8.24 Peak
8	5647.50	-49.70	-47.80	-13.00	-36.70	-1.90 Peak



A D T



Bureau Veritas Consumer Products Services Ltd., Taoyuan Branch

A D T

Data: 16

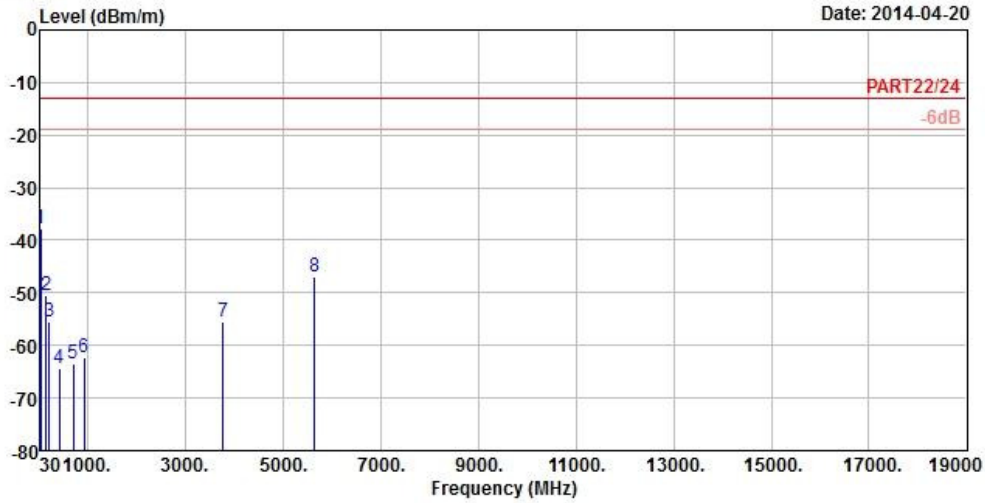

Site : 966 Chamber 5  
 Condition: PART22/24 3m VERTICAL  
 Remark : LTE Band 25\_1.4M\_QPSK(1,2) Link  
 Tested by: PeterWeng  
 Plane : Z

	Freq	Level	Read Level	Limit Line	Over Limit	Factor	Remark
	MHz	dBm/m	dBm	dBm/m	dB	dB/m	
1 pp	41.61	-37.65	-36.26	-13.00	-24.65	-1.39	Peak
2	148.53	-50.59	-44.36	-13.00	-37.59	-6.23	Peak
3	204.96	-55.37	-47.64	-13.00	-42.37	-7.73	Peak
4	421.10	-64.25	-59.15	-13.00	-51.25	-5.10	Peak
5	699.00	-63.60	-65.03	-13.00	-50.60	1.43	Peak
6	918.10	-62.36	-65.42	-13.00	-49.36	3.06	Peak
7	3765.00	-55.41	-47.17	-13.00	-42.41	-8.24	Peak
8	5647.50	-47.07	-45.17	-13.00	-34.07	-1.90	Peak



A D T

LTE BAND 25  
CHANNEL BANDWIDTH: 3MHz / QPSK



Bureau Veritas Consumer Products Services Ltd., Taoyuan Branch

A D T

Data: 11

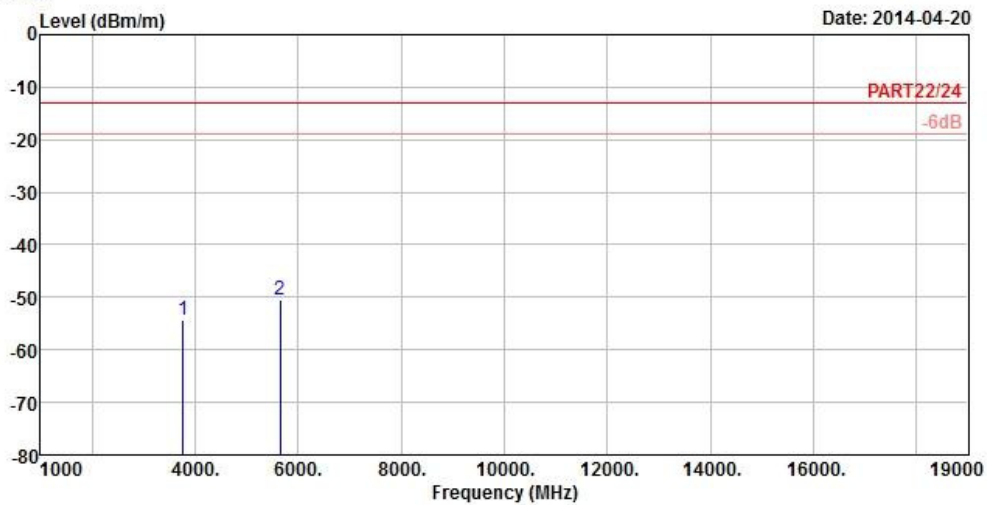

Site : 966 Chamber 5  
 Condition: PART22/24 3m HORIZONTAL  
 Remark : LTE Band 25\_3M\_QPSK(1,7) Link  
 Tested by: PeterWeng  
 Plane : Z

	Freq	Level	Read Level	Limit Line	Over Limit	Factor	Remark
	MHz	dBm/m	dBm	dBm/m	dB	dB/m	
1	3765.00	-54.21	-45.97	-13.00	-41.21	-8.24	Peak
2 pp	5647.50	-50.40	-48.50	-13.00	-37.40	-1.90	Peak



A D T



Bureau Veritas Consumer Products Services Ltd., Taoyuan Branch

A D T

Data: 12

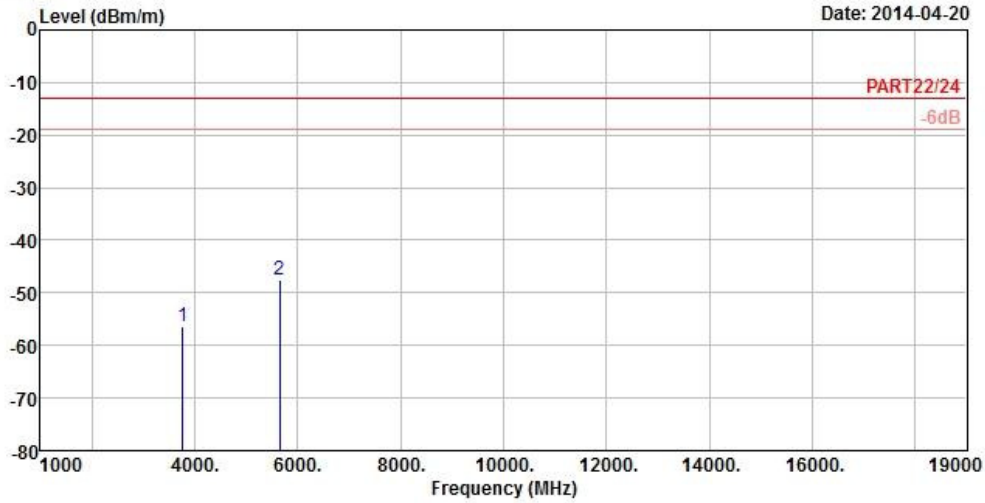

Site : 966 Chamber 5  
 Condition: PART22/24 3m VERTICAL  
 Remark : LTE Band 25\_3M\_QPSK(1,7) Link  
 Tested by: PeterWeng  
 Plane : Z

	Freq	Level	Read Level	Limit Line	Over Limit	Factor	Remark
	MHz	dBm/m	dBm	dBm/m	dB	dB/m	
1	3765.00	-56.30	-48.06	-13.00	-43.30	-8.24	Peak
2	5647.50	-47.62	-45.72	-13.00	-34.62	-1.90	Peak



A D T

LTE BAND 25  
CHANNEL BANDWIDTH: 5MHz / QPSK



Bureau Veritas Consumer Products Services Ltd., Taoyuan Branch

A D T

Data: 11

Date: 2014-04-20

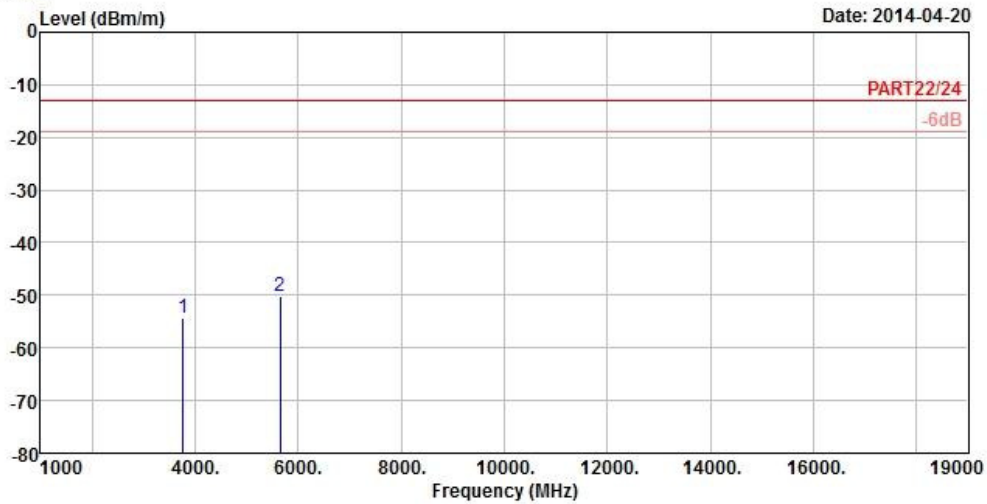

Site : 966 Chamber 5  
 Condition: PART22/24 3m HORIZONTAL  
 Remark : LTE Band 25\_5M\_QPSK(1,12) Link  
 Tested by: PeterWeng  
 Plane : Z

	Freq	Level	Read Level	Limit Line	Over Limit	Factor	Remark
	MHz	dBm/m	dBm	dBm/m	dB	dB/m	
1	3765.00	-54.24	-46.00	-13.00	-41.24	-8.24	Peak
2 pp	5647.50	-50.25	-48.35	-13.00	-37.25	-1.90	Peak





A D T



Bureau Veritas Consumer Products Services Ltd., Taoyuan Branch

A D T

Data: 12

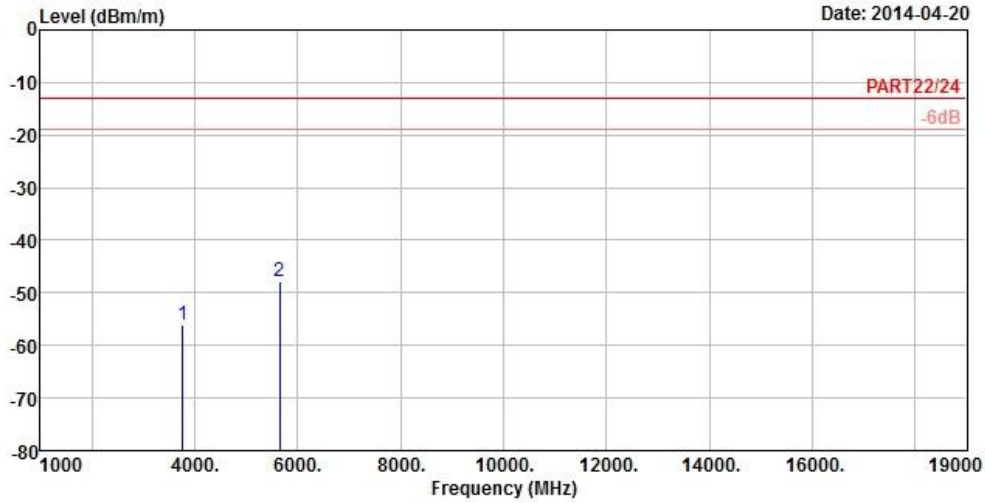

Site : 966 Chamber 5  
 Condition: PART22/24 3m VERTICAL  
 Remark : LTE Band 25\_5M\_QPSK(1,12) Link  
 Tested by: PeterWeng  
 Plane : Z

	Freq	Level	Read Level	Limit Line	Over Limit	Factor	Remark
	MHz	dBm/m	dBm	dBm/m	dB	dB/m	
1	3765.00	-56.13	-47.89	-13.00	-43.13	-8.24	Peak
2	5647.50	-47.80	-45.90	-13.00	-34.80	-1.90	Peak





A D T

LTE BAND 25  
CHANNEL BANDWIDTH: 10MHz / QPSK



Bureau Veritas Consumer Products Services Ltd., Taoyuan Branch

A D T

Data: 11

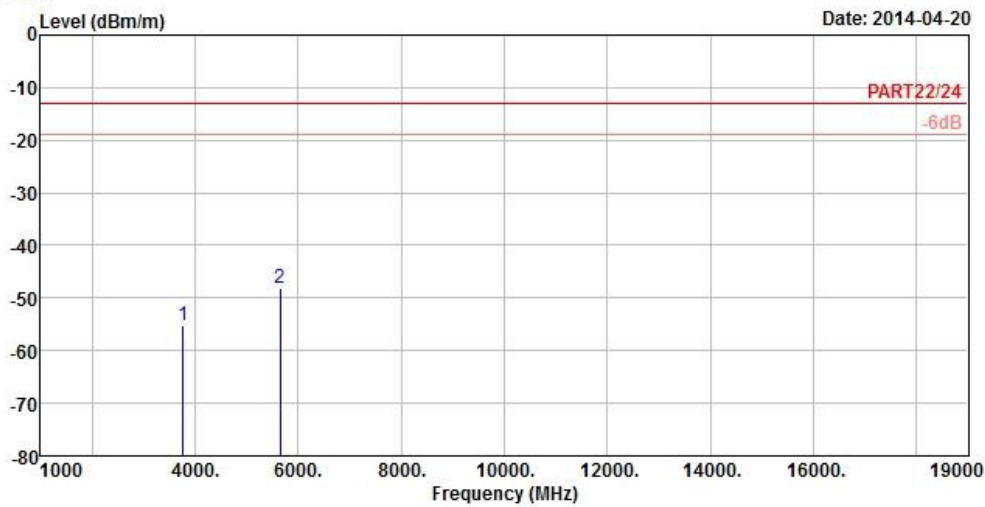

Site : 966 Chamber 5  
 Condition: PART22/24 3m HORIZONTAL  
 Remark : LTE Band 25\_10M\_QPSK(1,24) Link  
 Tested by: PeterWeng  
 Plane : Z

	Freq	Level	Read Level	Limit Line	Over Limit	Factor	Remark
	MHz	dBm/m	dBm	dBm/m	dB	dB/m	
1	3765.00	-55.10	-46.86	-13.00	-42.10	-8.24	Peak
2 pp	5647.50	-48.18	-46.28	-13.00	-35.18	-1.90	Peak



A D T



Bureau Veritas Consumer Products Services Ltd., Taoyuan Branch

A D T

Data: 12

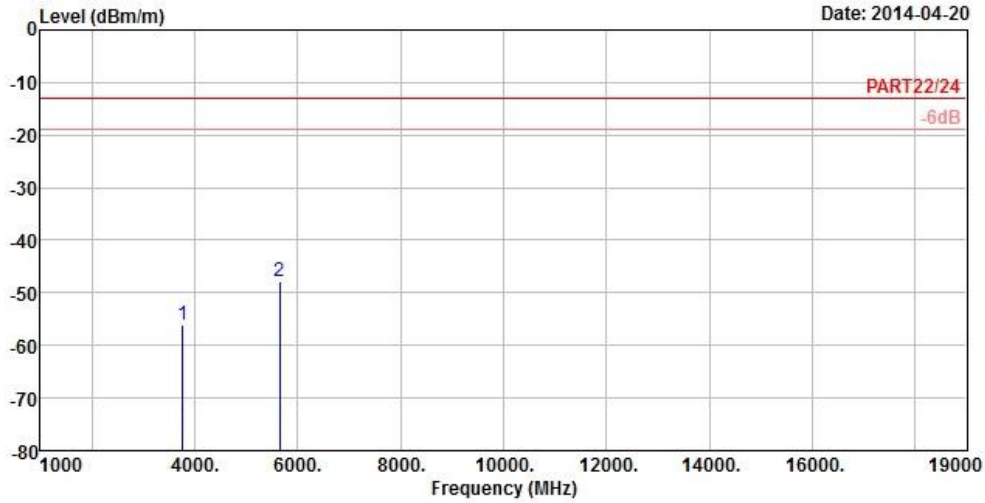

Site : 966 Chamber 5  
 Condition: PART22/24 3m VERTICAL  
 Remark : LTE Band 25\_10M\_QPSK(1,24) Link  
 Tested by: PeterWeng  
 Plane : Z

	Freq	Level	Read Level	Limit Line	Over Limit	Factor	Remark
	MHz	dBm/m	dBm	dBm/m	dB	dB/m	
1	3765.00	-55.98	-47.74	-13.00	-42.98	-8.24	Peak
2	5647.50	-47.97	-46.07	-13.00	-34.97	-1.90	Peak



A D T

LTE BAND 25  
CHANNEL BANDWIDTH: 15MHz / QPSK



Bureau Veritas Consumer Products Services Ltd., Taoyuan Branch

A D T

Data: 11

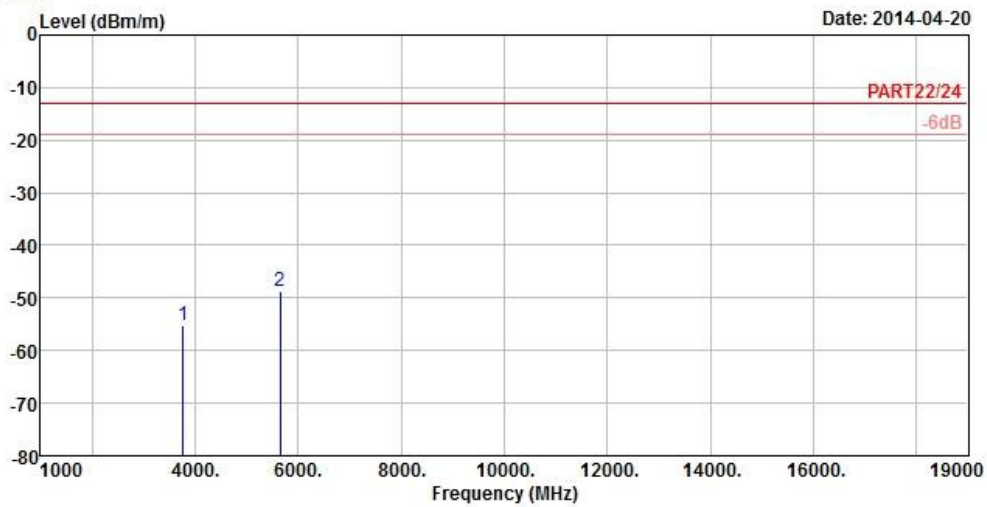

Site : 966 Chamber 5  
 Condition: PART22/24 3m HORIZONTAL  
 Remark : LTE Band 25\_15M\_QPSK(1,37) Link  
 Tested by: PeterWeng  
 Plane : Z

	Freq	Level	Read Level	Limit Line	Over Limit	Factor	Remark
	MHz	dBm/m	dBm	dBm/m	dB	dB/m	
1	3765.00	-55.27	-47.03	-13.00	-42.27	-8.24	Peak
2 pp	5647.50	-48.82	-46.92	-13.00	-35.82	-1.90	Peak



A D T



Bureau Veritas Consumer Products Services Ltd., Taoyuan Branch

A D T

Data: 12

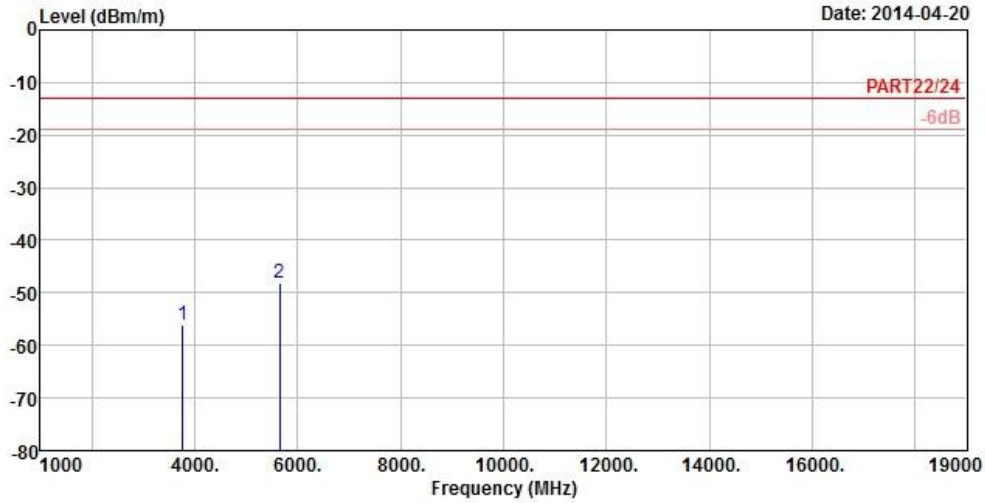

Site : 966 Chamber 5  
 Condition: PART22/24 3m VERTICAL  
 Remark : LTE Band 25\_15M\_QPSK(1,37) Link  
 Tested by: PeterWeng  
 Plane : Z

	Freq	Level	Read Level	Limit Line	Over Limit	Factor	Remark
	MHz	dBm/m	dBm	dBm/m	dB	dB/m	
1	3765.00	-56.23	-47.99	-13.00	-43.23	-8.24	Peak
2	5647.50	-48.02	-46.12	-13.00	-35.02	-1.90	Peak



A D T

LTE BAND 25  
CHANNEL BANDWIDTH: 20MHz / QPSK



Bureau Veritas Consumer Products Services Ltd., Taoyuan Branch

A D T

Data: 11

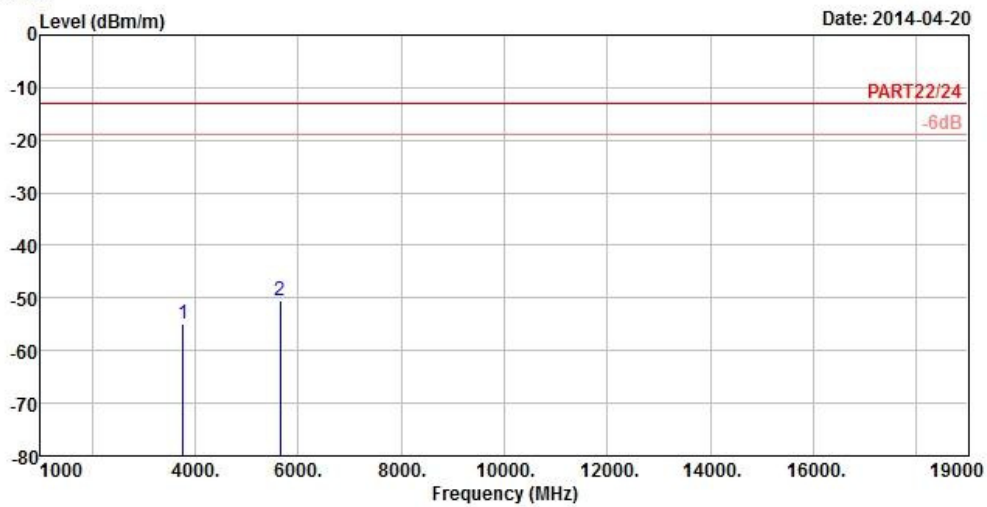

Site : 966 Chamber 5  
 Condition: PART22/24 3m HORIZONTAL  
 Remark : LTE Band 25\_20M\_QPSK(1,50) Link  
 Tested by: PeterWeng  
 Plane : Z

	Freq	Level	Read Level	Limit Line	Over Limit	Factor	Remark
	MHz	dBm/m	dBm	dBm/m	dB	dB/m	
1	3765.00	-54.77	-46.53	-13.00	-41.77	-8.24	Peak
2 pp	5647.50	-50.43	-48.53	-13.00	-37.43	-1.90	Peak



A D T



Bureau Veritas Consumer Products Services Ltd., Taoyuan Branch

A D T

Data: 12

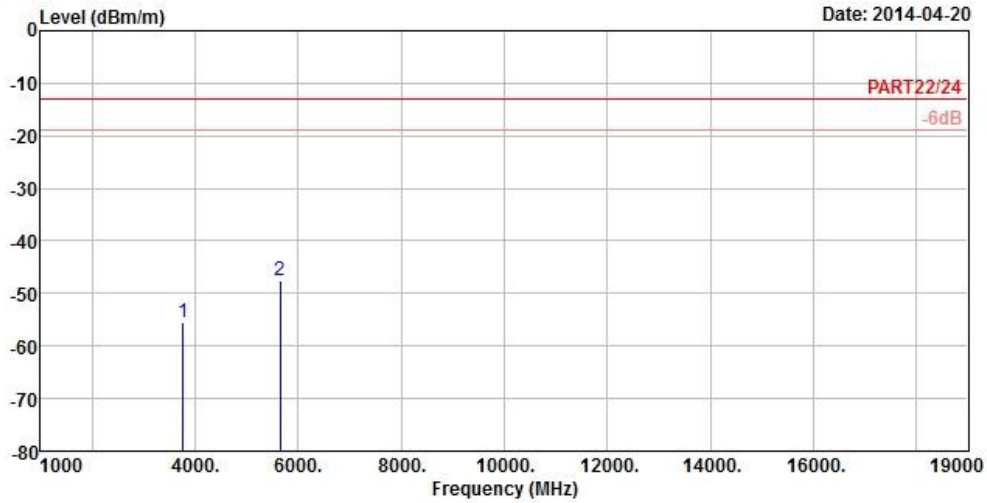

Site : 966 Chamber 5  
 Condition: PART22/24 3m VERTICAL  
 Remark : LTE Band 25\_20M\_QPSK(1,50) Link  
 Tested by: PeterWeng  
 Plane : Z

	Freq	Level	Read Level	Limit Line	Over Limit	Factor	Remark
	MHz	dBm/m	dBm	dBm/m	dB	dB/m	
1	3765.00	-55.52	-47.28	-13.00	-42.52	-8.24	Peak
2	5647.50	-47.58	-45.68	-13.00	-34.58	-1.90	Peak



A D T

MODE B

CDMA:



Bureau Veritas Consumer Products Services Ltd., Taoyuan Branch

A D T

Data: 11

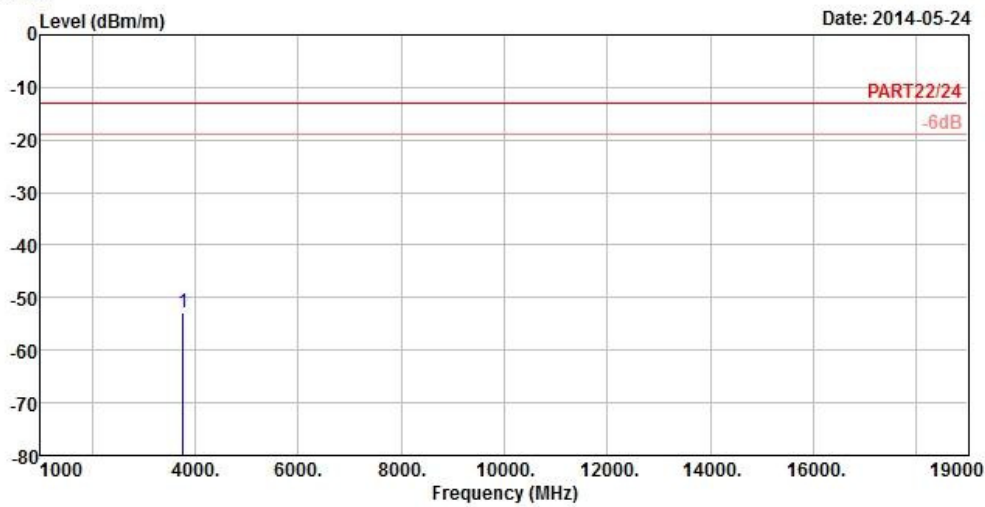

Site : 966 Chamber 5  
 Condition: PART22/24 3m HORIZONTAL  
 Remark : 1xRTT1900 Link  
 Tested by: PeterWeng  
 Plane : X

	Read	Limit	Over			
Freq	Level	Level	Line	Limit	Factor	Remark
MHz	dBm/m	dBm	dBm/m	dB	dB/m	
1 pp 3760.00	-52.91	-44.61	-13.00	-39.91	-8.30	Peak



A D T



Bureau Veritas Consumer Products Services Ltd., Taoyuan Branch

A D T

Data: 12

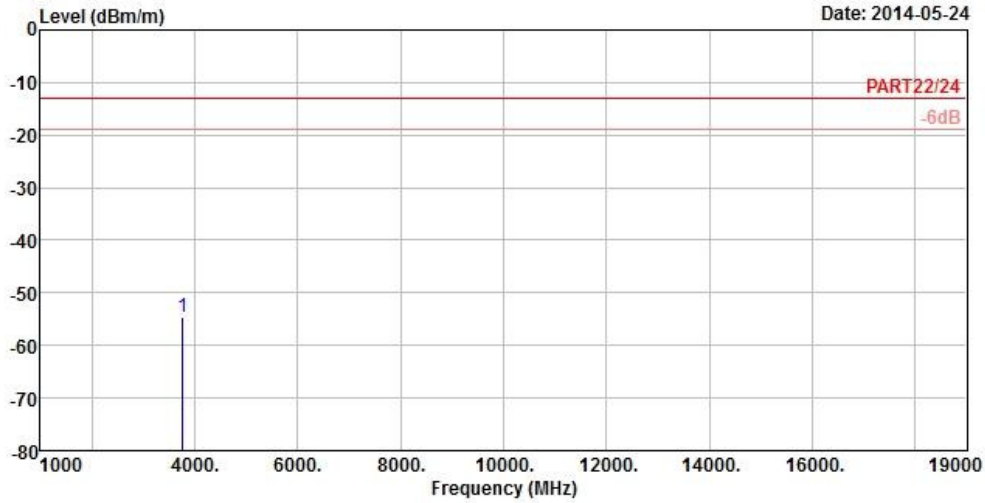

Site : 966 Chamber 5  
 Condition: PART22/24 3m VERTICAL  
 Remark : 1xRTT1900 Link  
 Tested by: PeterWeng  
 Plane : X

Freq	Level	Read Level	Limit Line	Over Limit	Factor	Remark
MHz	dBm/m	dBm	dBm/m	dB	dB/m	
1 pp 3760.00	-54.61	-46.31	-13.00	-41.61	-8.30	Peak





A D T

LTE BAND 25  
CHANNEL BANDWIDTH: 1.4MHz / QPSK



Bureau Veritas Consumer Products Services Ltd., Taoyuan Branch

A D T

Data: 11

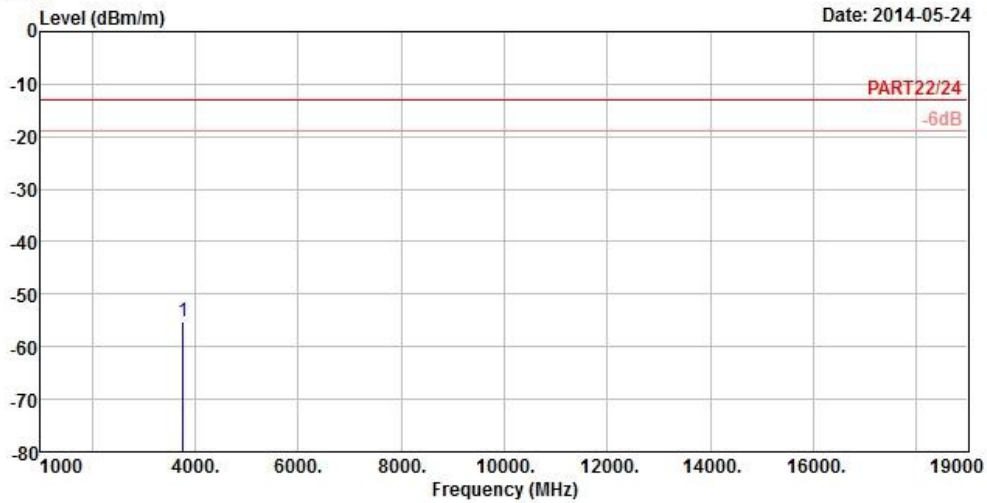

Site : 966 Chamber 5  
 Condition: PART22/24 3m HORIZONTAL  
 Remark : LTE Band 25\_1.4M\_QPSK(1,2) Link  
 Tested by: PeterWeng  
 Plane : Z

	Read	Limit	Over			
Freq	Level	Level	Line	Limit	Factor	Remark
MHz	dBm/m	dBm	dBm/m	dB	dB/m	
1 pp 3765.00	-55.19	-46.95	-13.00	-42.19	-8.24	Peak



A D T



Bureau Veritas Consumer Products Services Ltd., Taoyuan Branch

A D T

Data: 12

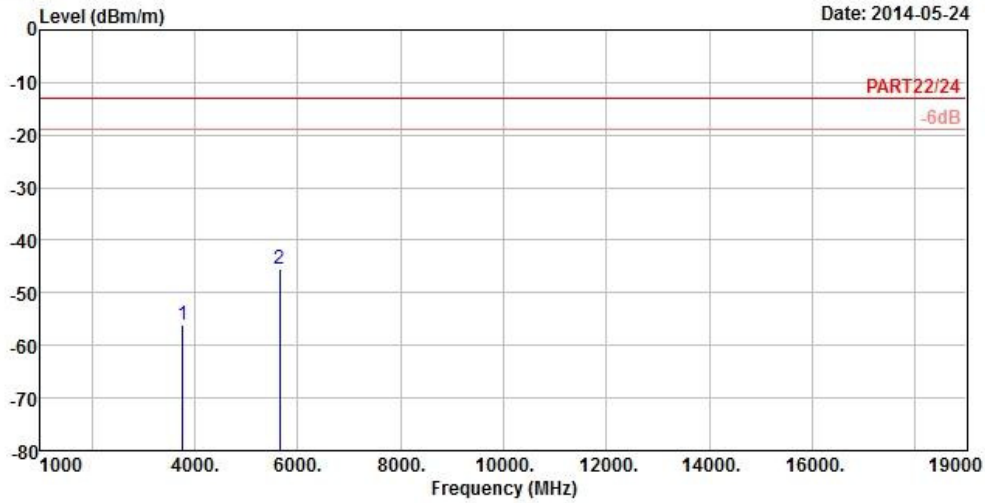

Site : 966 Chamber 5  
 Condition: PART22/24 3m VERTICAL  
 Remark : LTE Band 25\_1.4M\_QPSK(1,2) Link  
 Tested by: PeterWeng  
 Plane : Z

	Freq	Level	Read Level	Limit Line	Over Limit	Factor	Remark
	MHz	dBm/m	dBm	dBm/m	dB	dB/m	
1	3765.00	-56.20	-47.96	-13.00	-43.20	-8.24	Peak
2	5647.50	-45.60	-43.70	-13.00	-32.60	-1.90	Peak

## 5 PHOTOGRAPHS OF THE TEST CONFIGURATION

Please refer to the attached file (Test Setup Photo).



## 6 INFORMATION ON THE TESTING LABORATORIES

We, Bureau Veritas Consumer Products Services (H.K.) Ltd., Taoyuan Branch, were founded in 1988 to provide our best service in EMC, Radio, Telecom and Safety consultation. Our laboratories are accredited and approved according to ISO/IEC 17025.

If you have any comments, please feel free to contact us at the following:

**Linko EMC/RF Lab:**

Tel: 886-2-26052180

Fax: 886-2-26051924

**Hsin Chu EMC/RF Lab:**

Tel: 886-3-5935343

Fax: 886-3-5935342

**Hwa Ya EMC/RF/Safety/Telecom Lab:**

Tel: 886-3-3183232

Fax: 886-3-3270892

**Email:** [service.adt@tw.bureauveritas.com](mailto:service.adt@tw.bureauveritas.com)

**Web Site:** [www.bureauveritas-adt.com](http://www.bureauveritas-adt.com)

The address and road map of all our labs can be found in our web site also.



A D T

## **7 APPENDIX A – MODIFICATIONS RECORDERS FOR ENGINEERING CHANGES TO THE EUT BY THE LAB**

No any modifications were made to the EUT by the lab during the test.

**---END---**