



# FCC TEST REPORT (15.407)

**REPORT NO.:** RF140324C25-2  
**MODEL NO.:** OPAJ500  
**FCC ID:** NM80PAJ500  
**RECEIVED:** Mar. 24, 2014  
**TESTED:** Apr. 19, 2014 ~ Apr. 24, 2014  
**ISSUED:** Jun. 04, 2014

**APPLICANT:** HTC Corporation

**ADDRESS:** 1F, 6-3 Baoqiang Road, Xindian District, New Taipei City, Taiwan 231

**ISSUED BY:** Bureau Veritas Consumer Products Services (H.K.) Ltd., Taoyuan Branch

**LAB ADDRESS:** No. 47, 14th Ling, Chia Pau Vil., Lin Kou Dist., New Taipei City, Taiwan ( R.O.C )

**TEST LOCATION:** No. 19, Hwa Ya 2nd Rd, Wen Hwa Tsuen, Kwei Shan Hsiang, Taoyuan Hsien 333, Taiwan, R.O.C.

This report should not be used by the client to claim product certification, approval, or endorsement by TAF or any government agencies.



This report is for your exclusive use. Any copying or replication of this report to or for any other person or entity, or use of our name or trademark, is permitted only with our prior written permission. This report sets forth our findings solely with respect to the test samples identified herein. The results set forth in this report are not indicative or representative of the quality or characteristics of the lot from which a test sample was taken or any similar or identical product unless specifically and expressly noted. Our report includes all of the tests requested by you and the results thereof based upon the information that you provided to us. You have 60 days from date of issuance of this report to notify us of any material error or omission caused by our negligence, provided, however, that such notice shall be in writing and shall specifically address the issue you wish to raise. A failure to raise such issue within the prescribed time shall constitute your unqualified acceptance of the completeness of this report, the tests conducted and the correctness of the report contents. Unless specific mention, the uncertainty of measurement has been explicitly taken into account to declare the compliance or non-compliance to the specification.



# TABLE OF CONTENTS

RELEASE CONTROL RECORD .....	4
1. CERTIFICATION.....	5
2. SUMMARY OF TEST RESULTS .....	6
2.1 MEASUREMENT UNCERTAINTY.....	6
3. GENERAL INFORMATION .....	7
3.1 GENERAL DESCRIPTION OF EUT .....	7
3.2 DESCRIPTION OF TEST MODES .....	8
3.2.1 TEST MODE APPLICABILITY AND TESTED CHANNEL DETAIL .....	9
3.3 DESCRIPTION OF SUPPORT UNITS .....	11
3.3.1 CONFIGURATION OF SYSTEM UNDER TEST .....	11
3.4 DUTY CYCLE TEST SIGNAL .....	12
3.5 GENERAL DESCRIPTION OF APPLIED STANDARDS .....	16
4. TEST TYPES AND RESULTS .....	17
4.1 RADIATED EMISSION AND BANDEDGE MEASUREMENT .....	17
4.1.1 LIMITS OF RADIATED EMISSION AND BANDEDGE MEASUREMENT .....	17
4.1.2 LIMITS OF UNWANTED EMISSION OUT OF THE RESTRICTED BANDS .....	17
4.1.3 TEST INSTRUMENTS.....	18
4.1.4 TEST PROCEDURES .....	19
4.1.5 DEVIATION FROM TEST STANDARD .....	19
4.1.6 TEST SETUP .....	20
4.1.7 EUT OPERATING CONDITIONS .....	21
4.1.8 TEST RESULTS.....	22
4.2 CONDUCTED EMISSION MEASUREMENT .....	53
4.2.1 LIMITS OF CONDUCTED EMISSION MEASUREMENT .....	53
4.2.2 TEST INSTRUMENTS.....	53
4.2.3 TEST PROCEDURES .....	54
4.2.4 DEVIATION FROM TEST STANDARD .....	54
4.2.5 TEST SETUP .....	55
4.2.6 EUT OPERATING CONDITIONS .....	55
4.2.7 TEST RESULTS.....	56
4.3 PEAK TRANSMIT POWER MEASUREMENT .....	60
4.3.1 LIMITS OF PEAK TRANSMIT POWER MEASUREMENT .....	60
4.3.2 TEST SETUP .....	60
4.3.3 TEST INSTRUMENTS.....	60
4.3.4 TEST PROCEDURE .....	61
4.3.5 DEVIATION FROM TEST STANDARD .....	61
4.3.6 EUT OPERATING CONDITIONS .....	61
4.3.7 TEST RESULTS.....	62
4.4 PEAK POWER SPECTRAL DENSITY MEASUREMENT .....	66
4.4.1 LIMITS OF PEAK POWER SPECTRAL DENSITY MEASUREMENT .....	66
4.4.2 TEST SETUP .....	66
4.4.3 TEST INSTRUMENTS.....	66
4.4.4 TEST PROCEDURES .....	66
4.4.5 DEVIATION FROM TEST STANDARD .....	66
4.4.6 EUT OPERATING CONDITIONS .....	66
4.4.7 TEST RESULTS.....	67
4.5 PEAK POWER EXCURSION MEASUREMENT .....	70
4.5.1 LIMITS OF POWER SPECTRAL DENSITY MEASUREMENT .....	70
4.5.2 TEST SETUP .....	70
4.5.3 TEST INSTRUMENTS.....	70
4.5.4 TEST PROCEDURE .....	70
4.5.5 DEVIATION FROM TEST STANDARD .....	70



A D T

4.5.6	EUT OPERATING CONDITION.....	70
4.5.7	TEST RESULTS.....	71
4.6	FREQUENCY STABILITY .....	72
4.6.1	LIMITS OF FREQUENCY STABILITY MEASUREMENT .....	72
4.6.2	TEST SETUP .....	72
4.6.3	TEST INSTRUMENTS .....	72
4.6.4	TEST PROCEDURE .....	73
4.6.5	DEVIATION FROM TEST STANDARD .....	73
4.6.6	EUT OPERATING CONDITION.....	73
4.6.7	TEST RESULTS.....	74
5.	PHOTOGRAPHS OF THE TEST CONFIGURATION.....	82
6.	INFORMATION ON THE TESTING LABORATORIES .....	83
7.	APPENDIX A - MODIFICATIONS RECORDERS FOR ENGINEERING CHANGES TO THE EUT BY THE LAB .....	84



A D T

## RELEASE CONTROL RECORD

ISSUE NO.	REASON FOR CHANGE	DATE ISSUED
RF140324C25-2	Original release	Jun. 04, 2014



## 1. CERTIFICATION

**PRODUCT:** Smartphone  
**MODEL NO.:** 0PAJ500  
**BRAND:** HTC  
**APPLICANT:** HTC Corporation  
**TESTED:** Apr. 19, 2014 ~ Apr. 24, 2014  
**TEST SAMPLE:** Production Unit  
**STANDARDS:** **FCC Part 15, Subpart E (Section 15.407)**  
ANSI C63.10-2009

The above equipment (model: 0PAJ500) has been tested by **Bureau Veritas Consumer Products Services (H.K.) Ltd., Taoyuan Branch**, and found compliance with the requirement of the above standards. The test record, data evaluation & Equipment Under Test (EUT) configurations represented herein are true and accurate accounts of the measurements of the sample's EMC characteristics under the conditions specified in this report.

**PREPARED BY** : Ivonne Wu , **DATE** : Jun. 04, 2014  
Ivonne Wu / Supervisor

**APPROVED BY** : Sam Chen , **DATE** : Jun. 04, 2014  
Sam Chen / Senior Project Engineer

## 2. SUMMARY OF TEST RESULTS

The EUT has been tested according to the following specifications:

APPLIED STANDARD: FCC PART 15, SUBPART E (SECTION 15.407)			
STANDARD SECTION	TEST TYPE	RESULT	REMARK
15.407(b)(6)	AC Power Conducted Emission	PASS	Meet the requirement of limit. Minimum passing margin is -3.03dB at 13.56250MHz.
15.407(b/1/2/3) (b)(6)	Spurious Emissions	PASS	Meet the requirement of limit. Minimum passing margin is -3.58dB at 5725MHz.
15.407(a/1/2)	Peak Transmit Power	PASS	Meet the requirement of limit.
15.407(a)(6)	Peak Power Excursion	PASS	Meet the requirement of limit.
15.407(a/1/2)	Peak Power Spectral Density	PASS	Meet the requirement of limit.
15.407(g)	Frequency Stability	PASS	Meet the requirement of limit.
15.203	Antenna Requirement	PASS	No antenna connector is used.

### 2.1 MEASUREMENT UNCERTAINTY

Where relevant, the following measurement uncertainty levels have been estimated for tests performed on the EUT as specified in CISPR 16-4-2:

MEASUREMENT	FREQUENCY	UNCERTAINTY
Conducted emissions	9kHz~30MHz	2.44 dB
Radiated emissions	30MHz ~ 200MHz	2.93 dB
	200MHz ~1000MHz	2.95 dB
	1GHz ~ 18GHz	2.26 dB
	18GHz ~ 40GHz	1.94 dB

This uncertainty represents an expanded uncertainty expressed at approximately the 95% confidence level using a coverage factor of  $k = 2$ .

### 3. GENERAL INFORMATION

#### 3.1 GENERAL DESCRIPTION OF EUT

<b>EUT</b>	Smartphone
<b>MODEL NO.</b>	0PAJ500
<b>POWER SUPPLY</b>	5.0Vdc (adapter or host equipment) 3.8Vdc (Li-ion battery)
<b>MODULATION TYPE</b>	64QAM, 16QAM, QPSK, BPSK
<b>MODULATION TECHNOLOGY</b>	OFDM
<b>TRANSFER RATE</b>	802.11a: 54.0/ 48.0/ 36.0/ 24.0/ 18.0/ 12.0/ 9.0/ 6.0Mbps 802.11n: up to MCS7
<b>OPERATING FREQUENCY</b>	5180 ~ 5240MHz, 5260 ~ 5320MHz & 5500 ~ 5700MHz
<b>NUMBER OF CHANNEL</b>	5180 ~ 5240MHz: 4 for 802.11a, 802.11n (20MHz) 2 for 802.11n (40MHz) 5260 ~ 5320MHz: 4 for 802.11a, 802.11n (20MHz) 2 for 802.11n (40MHz) 5500 ~ 5700MHz: 8 for 802.11a, 802.11n (20MHz) 3 for 802.11n (40MHz)
<b>OUTPUT POWER</b>	42.76mW for 5180 ~ 5240MHz 42.46mW for 5260 ~ 5320MHz 44.57mW for 5500 ~ 5700MHz
<b>ANTENNA TYPE</b>	PIFA antenna with -3.5dBi gain (5180 ~ 5240MHz) PIFA antenna with -3dBi gain (5260 ~ 5320MHz) PIFA antenna with -3dBi gain (5500 ~ 5700MHz)
<b>ANTENNA CONNECTOR</b>	NA
<b>DATA CABLE</b>	Refer to Note as below
<b>I/O PORTS</b>	Refer to user's manual
<b>ACCESSORY DEVICES</b>	Refer to Note as below

**NOTE:**

- The EUT's accessories list refers to Ext. Pho.
- There're 2 configurations for the EUT listed as below.  
Main sample (A): Phone + Battery 1 + LCM 1  
2<sup>nd</sup> sample (B): Phone + Battery 2 + LCM 2  
✧ Only the worst test data was presented in the report.
- The above EUT information is declared by the manufacturer and for more detailed features description, please refer to the manufacturer's specifications or User's Manual.

### 3.2 DESCRIPTION OF TEST MODES

#### WLAN 5180 ~ 5240MHz

4 channels are provided for 802.11a, 802.11n (20MHz):

CHANNEL	FREQUENCY	CHANNEL	FREQUENCY
36	5180 MHz	44	5220 MHz
40	5200 MHz	48	5240 MHz

2 channels are provided for 802.11n (40MHz):

CHANNEL	FREQUENCY	CHANNEL	FREQUENCY
38	5190 MHz	46	5230 MHz

#### FOR 5260 ~ 5320MHz

4 channels are provided for 802.11a, 802.11n (20MHz):

CHANNEL	FREQUENCY	CHANNEL	FREQUENCY
52	5260 MHz	60	5300 MHz
56	5280 MHz	64	5320 MHz

2 channels are provided for 802.11n (40MHz):

CHANNEL	FREQUENCY	CHANNEL	FREQUENCY
54	5270 MHz	62	5310 MHz

#### WLAN 5500 ~ 5700MHz

8 channels are provided for 802.11a, 802.11n (20MHz):

CHANNEL	FREQUENCY	CHANNEL	FREQUENCY
100	5500MHz	116	5580MHz
104	5520MHz	132	5660MHz
108	5540MHz	136	5680MHz
112	5560MHz	140	5700MHz

3 channels are provided for 802.11n (40MHz):

CHANNEL	FREQUENCY	CHANNEL	FREQUENCY
102	5510MHz	134	5670MHz
110	5550MHz		





A D T

### 3.2.1 TEST MODE APPLICABILITY AND TESTED CHANNEL DETAIL

EUT CONFIGURE MODE	APPLICABLE TO				DESCRIPTION
	RE≥1G	RE<1G	PLC	APCM	
A	√	√	√	√	Main sample
B					

Where **RE≥1G**: Radiated Emission above 1GHz **RE<1G**: Radiated Emission below 1GHz

**PLC**: Power Line Conducted Emission

**APCM**: Antenna Port Conducted Measurement

**NOTE:** The EUT had been pre-tested on the positioned of each 3 axis. The worst case was found when positioned on **X-plane** for 5180-5240MHz and **Z-plane** for 5260-5320MHz & 5500-5700MHz.

#### **RADIATED EMISSION TEST (ABOVE 1GHz):**

Pre-Scan has been conducted to determine the worst-case mode from all possible combinations between available modulations, data rates and antenna ports (if EUT with antenna diversity architecture).

Following channel(s) was (were) selected for the final test as listed below.

EUT CONFIGURE MODE	MODE	FREQ. BAND (MHz)	AVAILABLE CHANNEL	TESTED CHANNEL	MODULATION TECHNOLOGY	MODULATION TYPE	DATA RATE (Mbps)
A	802.11a	5180-5240	36 to 48	36, 44, 48	OFDM	BPSK	6.0
	802.11n (20MHz)		36 to 48	36, 44, 48	OFDM	BPSK	MCS0
	802.11n (40MHz)		38 to 46	38, 46	OFDM	BPSK	MCS0
	802.11a	5260-5320	52 to 64	52, 60, 64	OFDM	BPSK	6.0
	802.11n (20MHz)		52 to 64	52, 60, 64	OFDM	BPSK	MCS0
	802.11n (40MHz)		54 to 62	54, 62	OFDM	BPSK	MCS0
	802.11a	5500-5700	100 to 140	100, 116, 140	OFDM	BPSK	6.0
	802.11n (20MHz)		100 to 140	100, 116, 140	OFDM	BPSK	MCS0
	802.11n (40MHz)		102 to 134	102, 110, 134	OFDM	BPSK	MCS0
B	802.11n (40MHz)	5180-5240	38 to 46	38	OFDM	BPSK	MCS0
	802.11n (20MHz)	5260-5320	52 to 64	64	OFDM	BPSK	MCS0
	802.11a	5500-5700	100 to 140	140	OFDM	BPSK	6.0

#### **RADIATED EMISSION TEST (BELOW 1GHz):**

Pre-Scan has been conducted to determine the worst-case mode from all possible combinations between available modulations, data rates and antenna ports (if EUT with antenna diversity architecture).

Following channel(s) was (were) selected for the final test as listed below.

EUT CONFIGURE MODE	MODE	FREQ. BAND (MHz)	AVAILABLE CHANNEL	TESTED CHANNEL	MODULATION TECHNOLOGY	MODULATION TYPE	DATA RATE (Mbps)
A	802.11n (40MHz)	5180-5240	38 to 46	38	OFDM	BPSK	MCS0
	802.11n (20MHz)	5260-5320	52 to 64	64	OFDM	BPSK	MCS0
	802.11a	5500-5700	100 to 140	140	OFDM	BPSK	6.0



A D T

**POWER LINE CONDUCTED EMISSION TEST:**

EUT CONFIGURE MODE	MODE	FREQ. BAND (MHz)	AVAILABLE CHANNEL	TESTED CHANNEL	MODULATION TECHNOLOGY	MODULATION TYPE	DATA RATE (Mbps)
A, B	802.11a	5500-5700	100 to 140	140	OFDM	BPSK	6.0

**BANDEDGE MEASUREMENT:**

- Pre-Scan has been conducted to determine the worst-case mode from all possible combinations between available modulations, data rates and antenna ports (if EUT with antenna diversity architecture).
- Following channel(s) was (were) selected for the final test as listed below.

EUT CONFIGURE MODE	MODE	FREQ. BAND (MHz)	AVAILABLE CHANNEL	TESTED CHANNEL	MODULATION TECHNOLOGY	MODULATION TYPE	DATA RATE (Mbps)
A	802.11a	5180-5240	36 to 48	36, 48	OFDM	BPSK	6.0
	802.11n (20MHz)		36 to 48	36, 48	OFDM	BPSK	MCS0
	802.11n (40MHz)		38 to 46	38, 46	OFDM	BPSK	MCS0
	802.11a	5260-5320	52 to 64	52, 64	OFDM	BPSK	6.0
	802.11n (20MHz)		52 to 64	52, 64	OFDM	BPSK	MCS0
	802.11n (40MHz)		54 to 62	54, 62	OFDM	BPSK	MCS0
	802.11a	5500-5700	100 to 140	100, 140	OFDM	BPSK	6.0
	802.11n (20MHz)		100 to 140	100, 140	OFDM	BPSK	MCS0
	802.11n (40MHz)		102 to 134	102, 134	OFDM	BPSK	MCS0

**ANTENNA PORT CONDUCTED MEASUREMENT:**

- This item includes all test value of each mode, but only includes spectrum plot of worst value of each mode.
- Pre-Scan has been conducted to determine the worst-case mode from all possible combinations between available modulations, data rates and antenna ports (if EUT with antenna diversity architecture).
- Following channel(s) was (were) selected for the final test as listed below.

EUT CONFIGURE MODE	MODE	FREQ. BAND (MHz)	AVAILABLE CHANNEL	TESTED CHANNEL	MODULATION TECHNOLOGY	MODULATION TYPE	DATA RATE (Mbps)
A	802.11a	5180-5240	36 to 48	36, 44, 48	OFDM	BPSK	6.0
	802.11n (20MHz)		36 to 48	36, 44, 48	OFDM	BPSK	MCS0
	802.11n (40MHz)		38 to 46	38, 46	OFDM	BPSK	MCS0
	802.11a	5260-5320	52 to 64	52, 60, 64	OFDM	BPSK	6.0
	802.11n (20MHz)		52 to 64	52, 60, 64	OFDM	BPSK	MCS0
	802.11n (40MHz)		54 to 62	54, 62	OFDM	BPSK	MCS0
	802.11a	5500-5700	100 to 140	100, 116, 140	OFDM	BPSK	6.0
	802.11n (20MHz)		100 to 140	100, 116, 140	OFDM	BPSK	MCS0
	802.11n (40MHz)		102 to 134	102, 110, 134	OFDM	BPSK	MCS0

**Test CONDITION:**

APPLICABLE TO	ENVIRONMENTAL CONDITIONS	INPUT POWER	TESTED BY
RE≥1G	25deg. C, 65%RH	120Vac, 60Hz	Johnson Liao
RE<1G	25deg. C, 65%RH	120Vac, 60Hz	Johnson Liao
PLC	25deg. C, 65%RH	120Vac, 60Hz	Peter Weng
APCM	25deg. C, 65%RH	120Vac, 60Hz	David Huang

**3.3 DESCRIPTION OF SUPPORT UNITS**

The EUT has been tested as an independent unit together with other necessary accessories or support units.

**3.3.1 CONFIGURATION OF SYSTEM UNDER TEST**

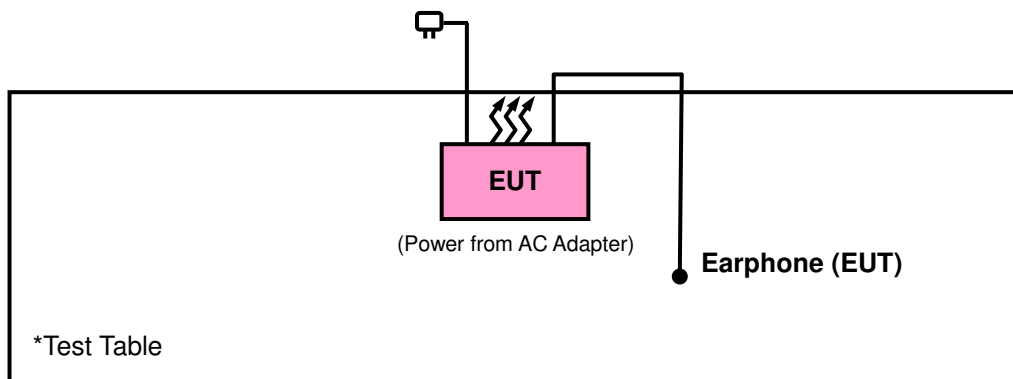

### 3.4 DUTY CYCLE TEST SIGNAL

#### MODULATION TYPE: BPSK

Duty cycle of test signal is > 98 %, duty factor is not required.

**802.11a:** Duty cycle = 1.354/1.378 = 0.982

**802.11n (20MHz):** Duty cycle = 1.274/1.290 = 0.988

If duty cycle is < 98%, duty factor shall be considered.

**802.11n (40MHz):** Duty cycle = 592.95/641.02 = 0.925, Duty factor =  $10 * \log(1/0.925) = 0.34$

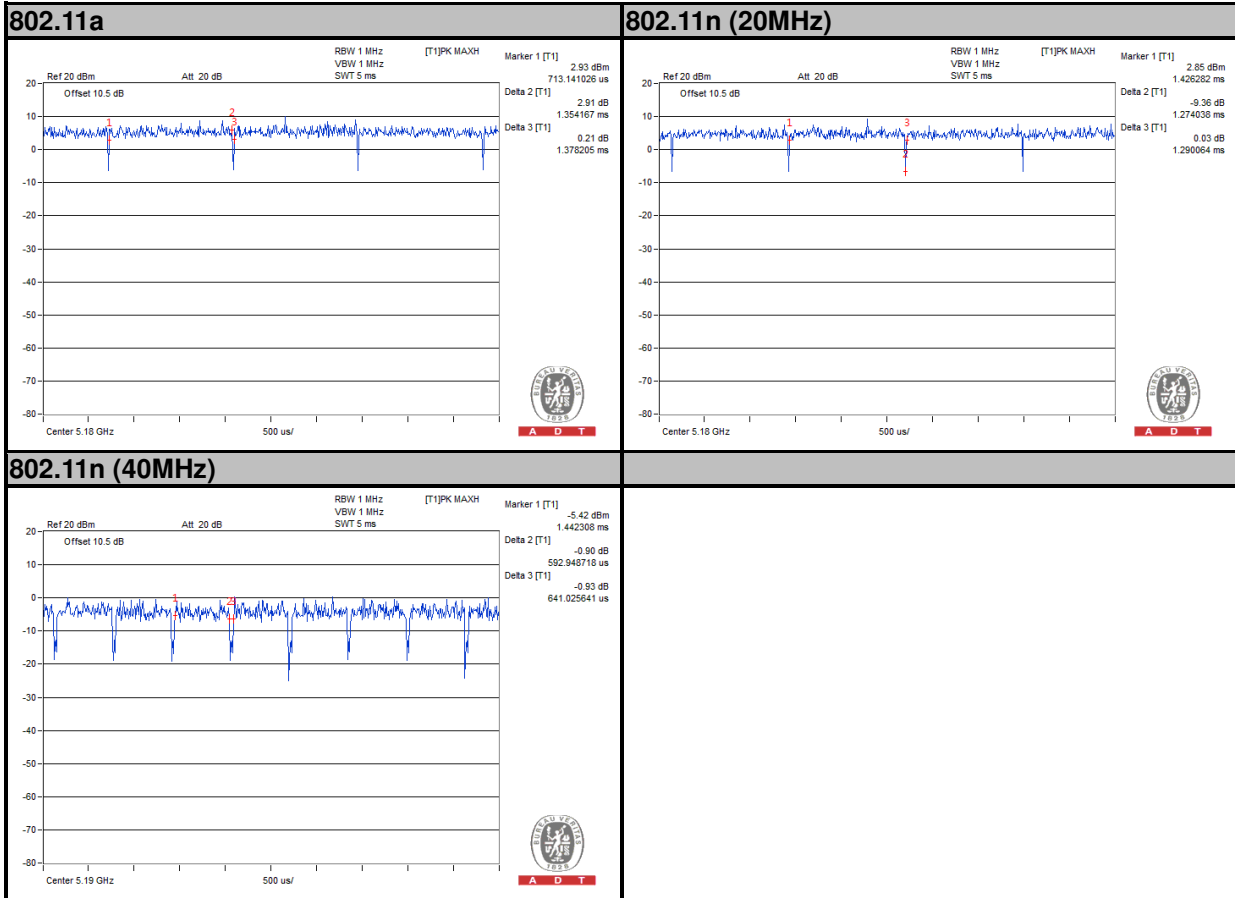



A D T

### MODULATION TYPE: QPSK

If duty cycle is < 98%, duty factor shall be considered.

**802.11a:** Duty cycle = 681.09/697.11 = 0.977, Duty factor =  $10 * \log(1/0.977) = 0.10$

**802.11n (20MHz):** Duty cycle = 649.04/665.06 = 0.976, Duty factor =  $10 * \log(1/0.976) = 0.11$

**802.11n (40MHz):** Duty cycle = 304.49/344.55 = 0.884, Duty factor =  $10 * \log(1/0.884) = 0.54$

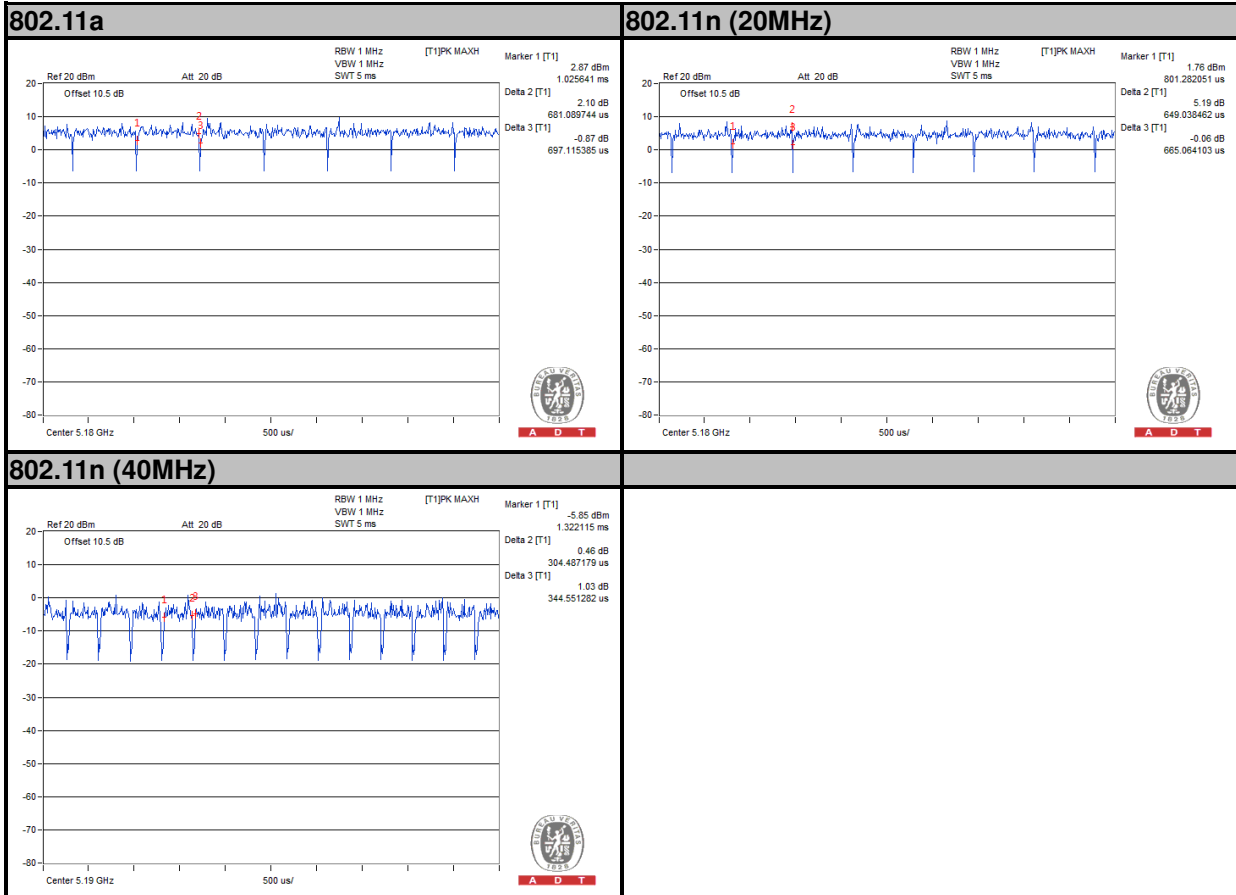



A D T

### MODULATION TYPE: 16QAM

If duty cycle is < 98%, duty factor shall be considered.

**802.11a:** Duty cycle = 358.97/366.99 = 0.978, Duty factor =  $10 * \log(1/0.978) = 0.10$

**802.11n (20MHz):** Duty cycle = 336.54/352.56 = 0.955, Duty factor =  $10 * \log(1/0.955) = 0.20$

**802.11n (40MHz):** Duty cycle = 157.05/200.32 = 0.784, Duty factor =  $10 * \log(1/0.784) = 1.06$

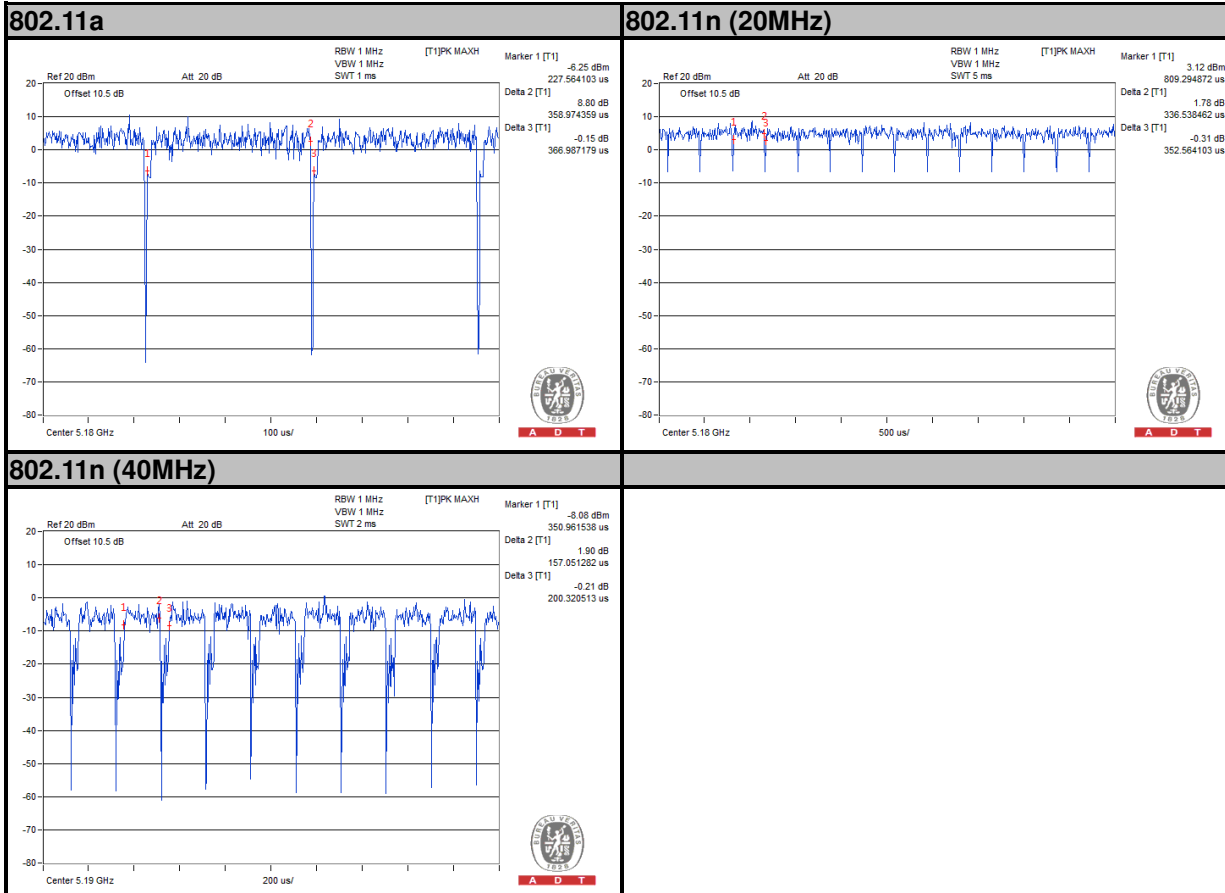



A D T

### MODULATION TYPE: 64QAM

If duty cycle is < 98%, duty factor shall be considered.

**802.11a:** Duty cycle = 181.09/197.11 = 0.919, Duty factor =  $10 * \log(1/0.919) = 0.37$

**802.11n (20MHz):** Duty cycle = 185.90/201.92 = 0.921, Duty factor =  $10 * \log(1/0.921) = 0.36$

**802.11n (40MHz):** Duty cycle = 80.13/123.40 = 0.649, Duty factor =  $10 * \log(1/0.649) = 1.87$

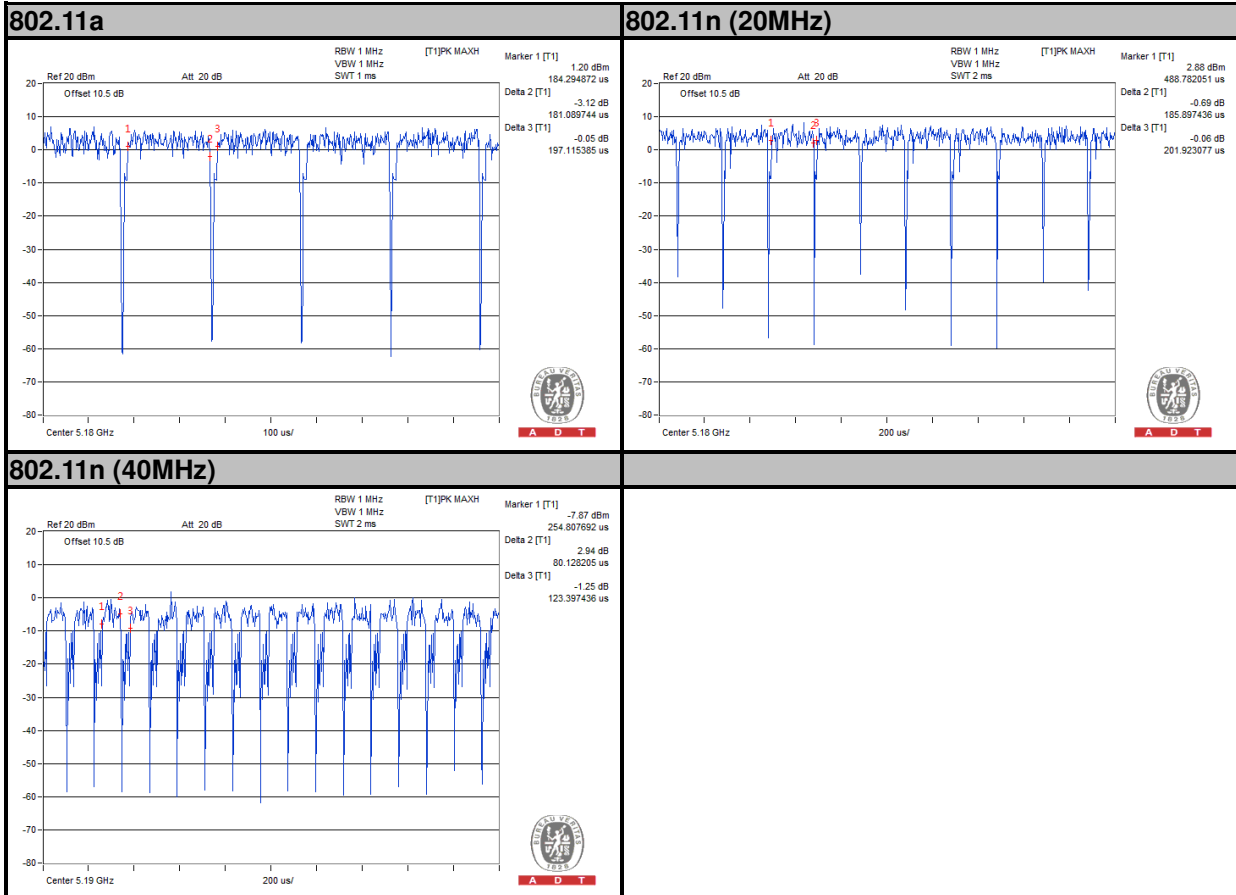

### 3.5 GENERAL DESCRIPTION OF APPLIED STANDARDS

The EUT is a RF Product. According to the specifications of the manufacturer, it must comply with the requirements of the following standards:

**FCC Part 15, Subpart E (15.407)**

**KDB 789033 D01 General UNII Test Procedures v01r03**

ANSI C63.10-2009

All test items have been performed and recorded as per the above standards.

**NOTE:** The EUT is also considered as a kind of computer peripheral, because the connection to computer is necessary for typical use. It has been verified to comply with the requirements of FCC Part 15, Subpart B, Class B (DoC). The test report has been issued separately.



## 4. TEST TYPES AND RESULTS

### 4.1 RADIATED EMISSION AND BANDEDGE MEASUREMENT

#### 4.1.1 LIMITS OF RADIATED EMISSION AND BANDEDGE MEASUREMENT

Radiated emissions which fall in the restricted bands must comply with the radiated emission limits specified as below table:

FREQUENCIES (MHz)	FIELD STRENGTH (microvolts/meter)	MEASUREMENT DISTANCE (meters)
0.009 ~ 0.490	2400/F(kHz)	300
0.490 ~ 1.705	24000/F(kHz)	30
1.705 ~ 30.0	30	30
30 ~ 88	100	3
88 ~ 216	150	3
216 ~ 960	200	3
Above 960	500	3

**NOTE:**

1. The lower limit shall apply at the transition frequencies.
2. Emission level (dBuV/m) = 20 log Emission level (uV/m).
3. For frequencies above 1000MHz, the field strength limits are based on average detector, however, the peak field strength of any emission shall not exceed the maximum permitted average limits, specified above by more than 20dB under any condition of modulation.

#### 4.1.2 LIMITS OF UNWANTED EMISSION OUT OF THE RESTRICTED BANDS

APPLICABLE TO	LIMIT	
	FIELD STRENGTH AT 3m (dBμV/m)	
	PK	AV
	74	54
	EIRP LIMIT (dBm)	EQUIVALENT FIELD STRENGTH AT 3m (dBμV/m)
√	PK	PK
	-27	68.3

**NOTE:** The following formula is used to convert the equipment isotropic radiated power (eirp) to field strength:

$$E = \frac{1000000\sqrt{30P}}{3} \mu\text{V/m, where } P \text{ is the eirp (Watts).}$$



### 4.1.3 TEST INSTRUMENTS

DESCRIPTION & MANUFACTURER	MODEL NO.	SERIAL NO.	DATE OF CALIBRATION	DUE DATE OF CALIBRATION
Test Receiver AGILENT	N9038A	MY51210203	Jan. 17, 2014	Jan. 16, 2015
Spectrum Analyzer ROHDE & SCHWARZ	FSU43	101261	Dec. 21, 2013	Dec. 20, 2014
BILOG Antenna SCHWARZBECK	VULB9168	9168-472	Feb. 27, 2014	Feb. 26, 2015
HORN Antenna SCHWARZBECK	BBHA 9120 D	9120D-969	Feb. 19, 2014	Feb. 18, 2015
HORN Antenna SCHWARZBECK	BBHA 9170	9170-480	Dec. 18, 2013	Dec. 17, 2014
Loop Antenna	HFH2-Z2	100070	Mar. 06, 2014	Mar. 05, 2016
Preamplifier EMCI	EMC 012645	980115	Dec. 26, 2013	Dec. 25, 2014
Preamplifier EMCI	EMC 184045	980116	Jan. 13, 2014	Jan. 12, 2015
Preamplifier EMCI	EMC 330H	980112	Dec. 27, 2013	Dec. 26, 2014
RF signal cable HUBER+SUHNNER	SUCOFLEX 104	309219/4 2950114	Oct. 18, 2013	Oct. 17, 2014
RF signal cable HUBER+SUHNNER	SUCOFLEX 104	250130/4	Oct. 18, 2013	Oct. 17, 2014
RF signal cable Worken	RG-213	NA	Nov. 07, 2013	Nov. 06, 2014
Software BV ADT	E3 6.120103	NA	NA	NA
Antenna Tower MF	MFA-440H	NA	NA	NA
Turn Table MF	MFT-201SS	NA	NA	NA
Antenna Tower & Turn Table Controller MF	MF-7802	NA	NA	NA
Power Meter	ML2495A	1232002	Aug. 23, 2013	Aug. 22, 2014
Power Sensor	MA2411B	1207325	Aug. 23, 2013	Aug. 22, 2014

- NOTE:**
1. The calibration interval of the above test instruments is 12 months and the calibrations are traceable to NML/ROC and NIST/USA.
  2. The calibration interval of the loop antenna is 24 months and the calibrations are traceable to NML/ROC and NIST/USA.
  3. The test was performed in HwaYa Chamber 10.
  4. The horn antenna and HP preamplifier (model: 8449B) are used only for the measurement of emission frequency above 1GHz if tested.
  5. The FCC Site Registration No. is 690701.
  6. The IC Site Registration No. is IC 7450F-10.

#### 4.1.4 TEST PROCEDURES

- a. The EUT was placed on the top of a rotating table 0.8 meters above the ground at a 3 meters semi-anechoic chamber. The table was rotated 360 degrees to determine the position of the highest radiation.
- b. The EUT was set 3 meters away from the interference-receiving antenna, which was mounted on the top of a variable-height antenna tower.
- c. The antenna is a broadband antenna, and its height is varied from one meter to four meters above the ground to determine the maximum value of the field strength. Both horizontal and vertical polarizations of the antenna are set to make the measurement.
- d. For each suspected emission, the EUT was arranged to its worst case and then the antenna was tuned to heights from 1 meter to 4 meters and the rotatable table was turned from 0 degrees to 360 degrees to find the maximum reading.
- e. The test-receiver system was set to Peak Detect Function and Specified Bandwidth with Maximum Hold Mode.
- f. If the emission level of the EUT in peak mode was 10dB lower than the limit specified, then testing could be stopped and the peak values of the EUT would be reported. Otherwise the emissions that did not have 10dB margin would be re-tested one by one using peak, quasi-peak or average method as specified and then reported in a data sheet.

#### NOTE:

1. The resolution bandwidth and video bandwidth of test receiver/spectrum analyzer is 120kHz for Peak detection (PK) and Quasi-peak detection (QP) at frequency below 1GHz.
2. The resolution bandwidth of test receiver/spectrum analyzer is 1MHz and video bandwidth is 3MHz for Peak detection at frequency above 1GHz.
3. The resolution bandwidth of test receiver/spectrum analyzer is 1MHz and the video bandwidth is 1kHz (Duty cycle < 98%) or 10Hz (Duty cycle > 98%) for Average detection (AV) at frequency above 1GHz.
4. All modes of operation were investigated and the worst-case emissions are reported.

#### 4.1.5 DEVIATION FROM TEST STANDARD

No deviation.

### 4.1.6 TEST SETUP

Frequency Range 30MHz ~ 1GHz

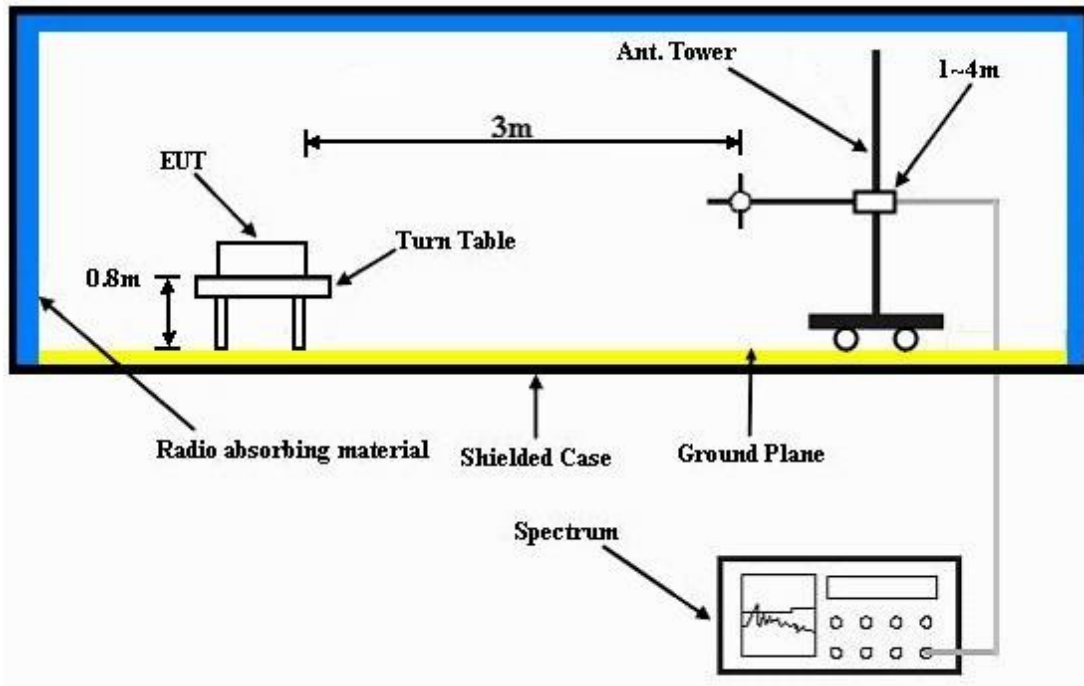

Frequency Range above 1GHz

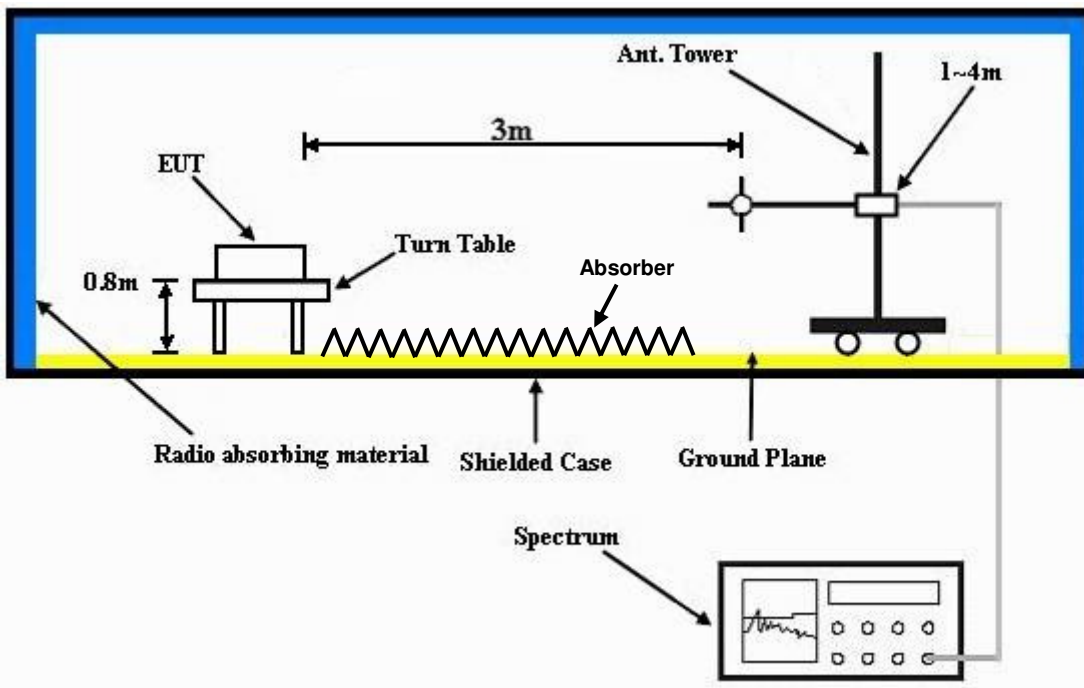

For the actual test configuration, please refer to the attached file (Test Setup Photo).



A D T

#### **4.1.7 EUT OPERATING CONDITIONS**

- a. Placed the EUT on a testing table.
- b. Use the software to control the EUT under transmission condition continuously at specific channel frequency.



A D T

### 4.1.8 TEST RESULTS

#### ABOVE 1GHz WORST-CASE DATA

#### MODE A

#### 802.11a

EUT TEST CONDITION		MEASUREMENT DETAIL	
CHANNEL	Channel 36	FREQUENCY RANGE	1GHz ~ 40GHz
INPUT POWER	120Vac, 60 Hz	DETECTOR FUNCTION	Peak (PK) Average (AV)
ENVIRONMENTAL CONDITIONS	25deg. C, 65%RH	TESTED BY	Johnson Liao

ANTENNA POLARITY & TEST DISTANCE: HORIZONTAL AT 3 M										
FREQ. (MHz)	EMISSION LEVEL (dBuV/m)	READ LEVEL (dBuV)	LIMIT (dBuV/m)	MARGIN (dB)	ANTENNA FACTOR (dB/m)	CABLE LOSS (dB)	PREAMP FACTOR (dB)	ANTENNA HEIGHT (cm)	TABLE ANGLE (Degree)	REMARK
5150	42.32	43.03	54	-11.68	31.32	5.29	37.32	100	238	Average
5150	54.47	55.18	74	-19.53	31.32	5.29	37.32	100	238	Peak
5180	94.83	95.51			31.35	5.31	37.34	100	238	Average
5180	104.19	104.87			31.35	5.31	37.34	100	238	Peak
5350	37.57	37.88	54	-16.43	31.48	5.39	37.18	100	238	Average
5350	54.28	54.59	74	-19.72	31.48	5.39	37.18	100	238	Peak
ANTENNA POLARITY & TEST DISTANCE: VERTICAL AT 3 M										
FREQ. (MHz)	EMISSION LEVEL (dBuV/m)	READ LEVEL (dBuV)	LIMIT (dBuV/m)	MARGIN (dB)	ANTENNA FACTOR (dB/m)	CABLE LOSS (dB)	PREAMP FACTOR (dB)	ANTENNA HEIGHT (cm)	TABLE ANGLE (Degree)	REMARK
5150	39.8	40.51	54	-14.2	31.32	5.29	37.32	100	7	Average
5150	54.03	54.74	74	-19.97	31.32	5.29	37.32	100	7	Peak
5180	89.5	90.18			31.35	5.31	37.34	100	7	Average
5180	98.56	99.24			31.35	5.31	37.34	100	7	Peak
5350	37.48	37.79	54	-16.52	31.48	5.39	37.18	100	7	Average
5350	53.5	53.81	74	-20.5	31.48	5.39	37.18	100	7	Peak

#### REMARKS:

- Emission Level = Read Level + Antenna Factor + Cable Loss - Preamp Factor  
Margin value = Emission level – Limit value
- 5180MHz: Fundamental frequency.



A D T

EUT TEST CONDITION		MEASUREMENT DETAIL	
CHANNEL	Channel 44	FREQUENCY RANGE	1GHz ~ 40GHz
INPUT POWER	120Vac, 60 Hz	DETECTOR FUNCTION	Peak (PK) Average (AV)
ENVIRONMENTAL CONDITIONS	25deg. C, 65%RH	TESTED BY	Johnson Liao

ANTENNA POLARITY & TEST DISTANCE: HORIZONTAL AT 3 M										
FREQ. (MHz)	EMISSION LEVEL (dBuV/m)	READ LEVEL (dBuV)	LIMIT (dBuV/m)	MARGIN (dB)	ANTENNA FACTOR (dB/m)	CABLE LOSS (dB)	PREAMP FACTOR (dB)	ANTENNA HEIGHT (cm)	TABLE ANGLE (Degree)	REMARK
5150	37.75	38.46	54	-16.25	31.32	5.29	37.32	100	238	Average
5150	53.53	54.24	74	-20.47	31.32	5.29	37.32	100	238	Peak
5220	94.95	95.61			31.37	5.33	37.36	100	238	Average
5220	104.5	105.16			31.37	5.33	37.36	100	238	Peak
5350	37.51	37.82	54	-16.49	31.48	5.39	37.18	100	238	Average
5350	52.9	53.21	74	-21.1	31.48	5.39	37.18	100	238	Peak
ANTENNA POLARITY & TEST DISTANCE: VERTICAL AT 3 M										
FREQ. (MHz)	EMISSION LEVEL (dBuV/m)	READ LEVEL (dBuV)	LIMIT (dBuV/m)	MARGIN (dB)	ANTENNA FACTOR (dB/m)	CABLE LOSS (dB)	PREAMP FACTOR (dB)	ANTENNA HEIGHT (cm)	TABLE ANGLE (Degree)	REMARK
5028	37.21	37.98	54	-16.79	31.23	5.24	37.24	100	6	Average
5028	55.36	56.13	74	-18.64	31.23	5.24	37.24	100	6	Peak
5220	89.58	90.24			31.37	5.33	37.36	100	6	Average
5220	98.95	99.61			31.37	5.33	37.36	100	6	Peak
5412	37.64	37.88	54	-16.36	31.53	5.41	37.18	100	6	Average
5412	56.13	56.37	74	-17.87	31.53	5.41	37.18	100	6	Peak

**REMARKS:**

- Emission Level = Read Level + Antenna Factor + Cable Loss - Preamp Factor  
Margin value = Emission level – Limit value
- 5220MHz: Fundamental frequency.



A D T

EUT TEST CONDITION		MEASUREMENT DETAIL	
CHANNEL	Channel 48	FREQUENCY RANGE	1GHz ~ 40GHz
INPUT POWER	120Vac, 60 Hz	DETECTOR FUNCTION	Peak (PK) Average (AV)
ENVIRONMENTAL CONDITIONS	25deg. C, 65%RH	TESTED BY	Johnson Liao

ANTENNA POLARITY & TEST DISTANCE: HORIZONTAL AT 3 M										
FREQ. (MHz)	EMISSION LEVEL (dBuV/m)	READ LEVEL (dBuV)	LIMIT (dBuV/m)	MARGIN (dB)	ANTENNA FACTOR (dB/m)	CABLE LOSS (dB)	PREAMP FACTOR (dB)	ANTENNA HEIGHT (cm)	TABLE ANGLE (Degree)	REMARK
5150	37.61	38.32	54	-16.39	31.32	5.29	37.32	102	216	Average
5150	52.97	53.68	74	-21.03	31.32	5.29	37.32	102	216	Peak
5240	95.29	95.88			31.39	5.34	37.32	102	216	Average
5240	104.55	105.14			31.39	5.34	37.32	102	216	Peak
5350	37.48	37.79	54	-16.52	31.48	5.39	37.18	102	216	Average
5350	53.25	53.56	74	-20.75	31.48	5.39	37.18	102	216	Peak
ANTENNA POLARITY & TEST DISTANCE: VERTICAL AT 3 M										
FREQ. (MHz)	EMISSION LEVEL (dBuV/m)	READ LEVEL (dBuV)	LIMIT (dBuV/m)	MARGIN (dB)	ANTENNA FACTOR (dB/m)	CABLE LOSS (dB)	PREAMP FACTOR (dB)	ANTENNA HEIGHT (cm)	TABLE ANGLE (Degree)	REMARK
5150	37.24	37.95	54	-16.76	31.32	5.29	37.32	100	6	Average
5150	54.11	54.82	74	-19.89	31.32	5.29	37.32	100	6	Peak
5240	88.99	89.58			31.39	5.34	37.32	100	6	Average
5240	97.99	98.58			31.39	5.34	37.32	100	6	Peak
5350	37.56	37.87	54	-16.44	31.48	5.39	37.18	100	6	Average
5350	53.66	53.97	74	-20.34	31.48	5.39	37.18	100	6	Peak

**REMARKS:**

- Emission Level = Read Level + Antenna Factor + Cable Loss - Preamp Factor  
Margin value = Emission level – Limit value
- 5240MHz: Fundamental frequency.





A D T

EUT TEST CONDITION		MEASUREMENT DETAIL	
CHANNEL	Channel 52	FREQUENCY RANGE	1GHz ~ 40GHz
INPUT POWER	120Vac, 60 Hz	DETECTOR FUNCTION	Peak (PK) Average (AV)
ENVIRONMENTAL CONDITIONS	25deg. C, 65%RH	TESTED BY	Johnson Liao

ANTENNA POLARITY & TEST DISTANCE: HORIZONTAL AT 3 M										
FREQ. (MHz)	EMISSION LEVEL (dBuV/m)	READ LEVEL (dBuV)	LIMIT (dBuV/m)	MARGIN (dB)	ANTENNA FACTOR (dB/m)	CABLE LOSS (dB)	PREAMP FACTOR (dB)	ANTENNA HEIGHT (cm)	TABLE ANGLE (Degree)	REMARK
5150	37.52	38.23	54	-16.48	31.32	5.29	37.32	101	232	Average
5150	56.62	57.33	74	-17.38	31.32	5.29	37.32	101	232	Peak
5260	95.95	96.47			31.41	5.34	37.27	101	232	Average
5260	105	105.52			31.41	5.34	37.27	101	232	Peak
5350	37.79	38.1	54	-16.21	31.48	5.39	37.18	101	232	Average
5350	56.88	57.19	74	-17.12	31.48	5.39	37.18	101	232	Peak

ANTENNA POLARITY & TEST DISTANCE: VERTICAL AT 3 M										
FREQ. (MHz)	EMISSION LEVEL (dBuV/m)	READ LEVEL (dBuV)	LIMIT (dBuV/m)	MARGIN (dB)	ANTENNA FACTOR (dB/m)	CABLE LOSS (dB)	PREAMP FACTOR (dB)	ANTENNA HEIGHT (cm)	TABLE ANGLE (Degree)	REMARK
5150	37.46	38.17	54	-16.54	31.32	5.29	37.32	102	293	Average
5150	57.17	57.88	74	-16.83	31.32	5.29	37.32	102	293	Peak
5260	94.26	94.78			31.41	5.34	37.27	102	293	Average
5260	103.71	104.23			31.41	5.34	37.27	102	293	Peak
5350	37.67	37.98	54	-16.33	31.48	5.39	37.18	102	293	Average
5350	57.13	57.44	74	-16.87	31.48	5.39	37.18	102	293	Peak

**REMARKS:**

- Emission Level = Read Level + Antenna Factor + Cable Loss - Preamp Factor  
Margin value = Emission level – Limit value
- 5260MHz: Fundamental frequency.



A D T

EUT TEST CONDITION		MEASUREMENT DETAIL	
CHANNEL	Channel 60	FREQUENCY RANGE	1GHz ~ 40GHz
INPUT POWER	120Vac, 60 Hz	DETECTOR FUNCTION	Peak (PK) Average (AV)
ENVIRONMENTAL CONDITIONS	25deg. C, 65%RH	TESTED BY	Johnson Liao

ANTENNA POLARITY & TEST DISTANCE: HORIZONTAL AT 3 M										
FREQ. (MHz)	EMISSION LEVEL (dBuV/m)	READ LEVEL (dBuV)	LIMIT (dBuV/m)	MARGIN (dB)	ANTENNA FACTOR (dB/m)	CABLE LOSS (dB)	PREAMP FACTOR (dB)	ANTENNA HEIGHT (cm)	TABLE ANGLE (Degree)	REMARK
5150	37.64	38.35	54	-16.36	31.32	5.29	37.32	100	230	Average
5150	57.64	58.35	74	-16.36	31.32	5.29	37.32	100	230	Peak
5300	95.79	96.17			31.44	5.37	37.19	100	230	Average
5300	105.12	105.5			31.44	5.37	37.19	100	230	Peak
5350	41.99	42.3	54	-12.01	31.48	5.39	37.18	100	230	Average
5350	57.73	58.04	74	-16.27	31.48	5.39	37.18	100	230	Peak
ANTENNA POLARITY & TEST DISTANCE: VERTICAL AT 3 M										
FREQ. (MHz)	EMISSION LEVEL (dBuV/m)	READ LEVEL (dBuV)	LIMIT (dBuV/m)	MARGIN (dB)	ANTENNA FACTOR (dB/m)	CABLE LOSS (dB)	PREAMP FACTOR (dB)	ANTENNA HEIGHT (cm)	TABLE ANGLE (Degree)	REMARK
5150	37.55	38.26	54	-16.45	31.32	5.29	37.32	104	296	Average
5150	56.97	57.68	74	-17.03	31.32	5.29	37.32	104	296	Peak
5300	93.98	94.36	54	39.98	31.44	5.37	37.19	104	296	Average
5300	103.99	104.37	74	29.99	31.44	5.37	37.19	104	296	Peak
5350	40.69	41	54	-13.31	31.48	5.39	37.18	104	296	Average
5350	56.88	57.19	74	-17.12	31.48	5.39	37.18	104	296	Peak

**REMARKS:**

- Emission Level = Read Level + Antenna Factor + Cable Loss - Preamp Factor  
Margin value = Emission level – Limit value
- 5300MHz: Fundamental frequency.



A D T

EUT TEST CONDITION		MEASUREMENT DETAIL	
CHANNEL	Channel 64	FREQUENCY RANGE	1GHz ~ 40GHz
INPUT POWER	120Vac, 60 Hz	DETECTOR FUNCTION	Peak (PK) Average (AV)
ENVIRONMENTAL CONDITIONS	25deg. C, 65%RH	TESTED BY	Johnson Liao

ANTENNA POLARITY & TEST DISTANCE: HORIZONTAL AT 3 M										
FREQ. (MHz)	EMISSION LEVEL (dBuV/m)	READ LEVEL (dBuV)	LIMIT (dBuV/m)	MARGIN (dB)	ANTENNA FACTOR (dB/m)	CABLE LOSS (dB)	PREAMP FACTOR (dB)	ANTENNA HEIGHT (cm)	TABLE ANGLE (Degree)	REMARK
5150	37.73	38.44	54	-16.27	31.32	5.29	37.32	100	231	Average
5150	56.98	57.69	74	-17.02	31.32	5.29	37.32	100	231	Peak
5320	96.06	96.42			31.45	5.38	37.19	100	231	Average
5320	105.43	105.79			31.45	5.38	37.19	100	231	Peak
5438	42.49	42.63	54	-11.51	31.55	5.44	37.13	100	231	Average
5438	59.44	59.58	74	-14.56	31.55	5.44	37.13	100	231	Peak
ANTENNA POLARITY & TEST DISTANCE: VERTICAL AT 3 M										
FREQ. (MHz)	EMISSION LEVEL (dBuV/m)	READ LEVEL (dBuV)	LIMIT (dBuV/m)	MARGIN (dB)	ANTENNA FACTOR (dB/m)	CABLE LOSS (dB)	PREAMP FACTOR (dB)	ANTENNA HEIGHT (cm)	TABLE ANGLE (Degree)	REMARK
5012	37.24	38.04	54	-16.76	31.21	5.22	37.23	102	296	Average
5012	58.98	59.78	74	-15.02	31.21	5.22	37.23	102	296	Peak
5320	94.36	94.72			31.45	5.38	37.19	102	296	Average
5320	103.52	103.88			31.45	5.38	37.19	102	296	Peak
5456	41.73	41.81	54	-12.27	31.56	5.44	37.08	102	296	Average
5456	59.51	59.59	74	-14.49	31.56	5.44	37.08	102	296	Peak

**REMARKS:**

- Emission Level = Read Level + Antenna Factor + Cable Loss - Preamp Factor  
Margin value = Emission level – Limit value
- 5320MHz: Fundamental frequency.



A D T

EUT TEST CONDITION		MEASUREMENT DETAIL	
CHANNEL	Channel 100	FREQUENCY RANGE	1GHz ~ 40GHz
INPUT POWER	120Vac, 60 Hz	DETECTOR FUNCTION	Peak (PK) Average (AV)
ENVIRONMENTAL CONDITIONS	25deg. C, 65%RH	TESTED BY	Johnson Liao

ANTENNA POLARITY & TEST DISTANCE: HORIZONTAL AT 3 M										
FREQ. (MHz)	EMISSION LEVEL (dBuV/m)	READ LEVEL (dBuV)	LIMIT (dBuV/m)	MARGIN (dB)	ANTENNA FACTOR (dB/m)	CABLE LOSS (dB)	PREAMP FACTOR (dB)	ANTENNA HEIGHT (cm)	TABLE ANGLE (Degree)	REMARK
5458	43.89	43.97	54	-10.11	31.56	5.44	37.08	100	225	Average
5458	59.32	59.4	74	-14.68	31.56	5.44	37.08	100	225	Peak
5470	59.17	59.23	68.3	-9.13	31.57	5.45	37.08	100	225	Peak
5500	96.38	96.35			31.6	5.46	37.03	100	225	Average
5500	106.2	106.17			31.6	5.46	37.03	100	225	Peak
5725	58.99	58.87	68.3	-9.31	31.96	5.59	37.43	100	225	Peak
ANTENNA POLARITY & TEST DISTANCE: VERTICAL AT 3 M										
FREQ. (MHz)	EMISSION LEVEL (dBuV/m)	READ LEVEL (dBuV)	LIMIT (dBuV/m)	MARGIN (dB)	ANTENNA FACTOR (dB/m)	CABLE LOSS (dB)	PREAMP FACTOR (dB)	ANTENNA HEIGHT (cm)	TABLE ANGLE (Degree)	REMARK
5398	42.48	42.73	54	-11.52	31.52	5.41	37.18	100	281	Average
5398	59.31	59.56	74	-14.69	31.52	5.41	37.18	100	281	Peak
5470	58.15	58.21	68.3	-10.15	31.57	5.45	37.08	100	281	Peak
5500	95.11	95.08			31.6	5.46	37.03	100	281	Average
5500	104.49	104.46			31.6	5.46	37.03	100	281	Peak
5725	60.39	60.27	68.3	-7.91	31.96	5.59	37.43	100	281	Peak

**REMARKS:**

- Emission Level = Read Level + Antenna Factor + Cable Loss - Preamp Factor  
Margin value = Emission level – Limit value
- 5500MHz: Fundamental frequency.
- 5470MHz & 5725MHz: Out of restricted band



A D T

EUT TEST CONDITION		MEASUREMENT DETAIL	
CHANNEL	Channel 116	FREQUENCY RANGE	1GHz ~ 40GHz
INPUT POWER	120Vac, 60 Hz	DETECTOR FUNCTION	Peak (PK) Average (AV)
ENVIRONMENTAL CONDITIONS	25deg. C, 65%RH	TESTED BY	Johnson Liao

ANTENNA POLARITY & TEST DISTANCE: HORIZONTAL AT 3 M										
FREQ. (MHz)	EMISSION LEVEL (dBuV/m)	READ LEVEL (dBuV)	LIMIT (dBuV/m)	MARGIN (dB)	ANTENNA FACTOR (dB/m)	CABLE LOSS (dB)	PREAMP FACTOR (dB)	ANTENNA HEIGHT (cm)	TABLE ANGLE (Degree)	REMARK
5394	37.83	38.09	54	-16.17	31.51	5.41	37.18	105	233	Average
5394	60.44	60.7	74	-13.56	31.51	5.41	37.18	105	233	Peak
5470	57.69	57.75	68.3	-10.61	31.57	5.45	37.08	105	233	Peak
5580	96.96	96.91			31.71	5.5	37.16	105	233	Average
5580	106.62	106.57			31.71	5.5	37.16	105	233	Peak
5725	57.98	57.86	68.3	-10.32	31.96	5.59	37.43	105	233	Peak
ANTENNA POLARITY & TEST DISTANCE: VERTICAL AT 3 M										
FREQ. (MHz)	EMISSION LEVEL (dBuV/m)	READ LEVEL (dBuV)	LIMIT (dBuV/m)	MARGIN (dB)	ANTENNA FACTOR (dB/m)	CABLE LOSS (dB)	PREAMP FACTOR (dB)	ANTENNA HEIGHT (cm)	TABLE ANGLE (Degree)	REMARK
5406	37.62	37.87	54	-16.38	31.52	5.41	37.18	100	128	Average
5406	59.71	59.96	74	-14.29	31.52	5.41	37.18	100	128	Peak
5470	56.68	56.74	68.3	-11.62	31.57	5.45	37.08	100	128	Peak
5580	95.15	95.1			31.71	5.5	37.16	100	128	Average
5580	104.55	104.5			31.71	5.5	37.16	100	128	Peak
5725	58.19	58.07	68.3	-10.11	31.96	5.59	37.43	100	128	Peak

**REMARKS:**

- Emission Level = Read Level + Antenna Factor + Cable Loss - Preamp Factor  
Margin value = Emission level – Limit value
- 5580MHz: Fundamental frequency.
- 5470MHz & 5725MHz: Out of restricted band



A D T

EUT TEST CONDITION		MEASUREMENT DETAIL	
CHANNEL	Channel 140	FREQUENCY RANGE	1GHz ~ 40GHz
INPUT POWER	120Vac, 60 Hz	DETECTOR FUNCTION	Peak (PK) Average (AV)
ENVIRONMENTAL CONDITIONS	25deg. C, 65%RH	TESTED BY	Johnson Liao

ANTENNA POLARITY & TEST DISTANCE: HORIZONTAL AT 3 M										
FREQ. (MHz)	EMISSION LEVEL (dBuV/m)	READ LEVEL (dBuV)	LIMIT (dBuV/m)	MARGIN (dB)	ANTENNA FACTOR (dB/m)	CABLE LOSS (dB)	PREAMP FACTOR (dB)	ANTENNA HEIGHT (cm)	TABLE ANGLE (Degree)	REMARK
5392	37.74	38	54	-16.26	31.51	5.41	37.18	102	234	Average
5392	59.67	59.93	74	-14.33	31.51	5.41	37.18	102	234	Peak
5470	57.79	57.85	68.3	-10.51	31.57	5.45	37.08	102	234	Peak
5700	97.05	96.98			31.9	5.57	37.4	102	234	Average
5700	106.63	106.56			31.9	5.57	37.4	102	234	Peak
5725	64.72	64.6	68.3	-3.58	31.96	5.59	37.43	102	234	Peak
ANTENNA POLARITY & TEST DISTANCE: VERTICAL AT 3 M										
FREQ. (MHz)	EMISSION LEVEL (dBuV/m)	READ LEVEL (dBuV)	LIMIT (dBuV/m)	MARGIN (dB)	ANTENNA FACTOR (dB/m)	CABLE LOSS (dB)	PREAMP FACTOR (dB)	ANTENNA HEIGHT (cm)	TABLE ANGLE (Degree)	REMARK
5442	37.58	37.72	54	-16.42	31.55	5.44	37.13	100	198	Average
5442	59.14	59.28	74	-14.86	31.55	5.44	37.13	100	198	Peak
5470	58.53	58.59	68.3	-9.77	31.57	5.45	37.08	100	198	Peak
5700	94.52	94.45			31.9	5.57	37.4	100	198	Average
5700	104.16	104.09			31.9	5.57	37.4	100	198	Peak
5725	61.1	60.98	68.3	-7.2	31.96	5.59	37.43	100	198	Peak

**REMARKS:**

- Emission Level = Read Level + Antenna Factor + Cable Loss - Preamp Factor  
Margin value = Emission level – Limit value
- 5700MHz: Fundamental frequency.
- 5470MHz & 5725MHz: Out of restricted band



A D T

**802.11n (20MHz)**

EUT TEST CONDITION		MEASUREMENT DETAIL	
CHANNEL	Channel 36	FREQUENCY RANGE	1GHz ~ 40GHz
INPUT POWER	120Vac, 60 Hz	DETECTOR FUNCTION	Peak (PK) Average (AV)
ENVIRONMENTAL CONDITIONS	25deg. C, 65%RH	TESTED BY	Johnson Liao

ANTENNA POLARITY & TEST DISTANCE: HORIZONTAL AT 3 M										
FREQ. (MHz)	EMISSION LEVEL (dBuV/m)	READ LEVEL (dBuV)	LIMIT (dBuV/m)	MARGIN (dB)	ANTENNA FACTOR (dB/m)	CABLE LOSS (dB)	PREAMP FACTOR (dB)	ANTENNA HEIGHT (cm)	TABLE ANGLE (Degree)	REMARK
5148	42.61	43.32	54	-11.39	31.32	5.29	37.32	100	238	Average
5148	55.98	56.69	74	-18.02	31.32	5.29	37.32	100	238	Peak
5180	94.26	94.94			31.35	5.31	37.34	100	238	Average
5180	104.27	104.95			31.35	5.31	37.34	100	238	Peak
5350	37.62	37.93	54	-16.38	31.48	5.39	37.18	100	238	Average
5350	54.85	55.16	74	-19.15	31.48	5.39	37.18	100	238	Peak
ANTENNA POLARITY & TEST DISTANCE: VERTICAL AT 3 M										
FREQ. (MHz)	EMISSION LEVEL (dBuV/m)	READ LEVEL (dBuV)	LIMIT (dBuV/m)	MARGIN (dB)	ANTENNA FACTOR (dB/m)	CABLE LOSS (dB)	PREAMP FACTOR (dB)	ANTENNA HEIGHT (cm)	TABLE ANGLE (Degree)	REMARK
5150	39.89	40.6	54	-14.11	31.32	5.29	37.32	100	6	Average
5150	53.46	54.17	74	-20.54	31.32	5.29	37.32	100	6	Peak
5180	88.71	89.39			31.35	5.31	37.34	100	6	Average
5180	97.95	98.63			31.35	5.31	37.34	100	6	Peak
5350	37.5	37.81	54	-16.5	31.48	5.39	37.18	100	6	Average
5350	52.99	53.3	74	-21.01	31.48	5.39	37.18	100	6	Peak

**REMARKS:**

- Emission Level = Read Level + Antenna Factor + Cable Loss - Preamp Factor  
Margin value = Emission level – Limit value
- 5180MHz: Fundamental frequency.



A D T

EUT TEST CONDITION		MEASUREMENT DETAIL	
CHANNEL	Channel 44	FREQUENCY RANGE	1GHz ~ 40GHz
INPUT POWER	120Vac, 60 Hz	DETECTOR FUNCTION	Peak (PK) Average (AV)
ENVIRONMENTAL CONDITIONS	25deg. C, 65%RH	TESTED BY	Johnson Liao

ANTENNA POLARITY & TEST DISTANCE: HORIZONTAL AT 3 M										
FREQ. (MHz)	EMISSION LEVEL (dBuV/m)	READ LEVEL (dBuV)	LIMIT (dBuV/m)	MARGIN (dB)	ANTENNA FACTOR (dB/m)	CABLE LOSS (dB)	PREAMP FACTOR (dB)	ANTENNA HEIGHT (cm)	TABLE ANGLE (Degree)	REMARK
5150	37.6	38.31	54	-16.4	31.32	5.29	37.32	113	239	Average
5150	53.84	54.55	74	-20.16	31.32	5.29	37.32	113	239	Peak
5220	94.94	95.6			31.37	5.33	37.36	113	239	Average
5220	104.08	104.74			31.37	5.33	37.36	113	239	Peak
5350	37.47	37.78	54	-16.53	31.48	5.39	37.18	113	239	Average
5350	53.27	53.58	74	-20.73	31.48	5.39	37.18	113	239	Peak
ANTENNA POLARITY & TEST DISTANCE: VERTICAL AT 3 M										
FREQ. (MHz)	EMISSION LEVEL (dBuV/m)	READ LEVEL (dBuV)	LIMIT (dBuV/m)	MARGIN (dB)	ANTENNA FACTOR (dB/m)	CABLE LOSS (dB)	PREAMP FACTOR (dB)	ANTENNA HEIGHT (cm)	TABLE ANGLE (Degree)	REMARK
5150	37.57	38.28	54	-16.43	31.32	5.29	37.32	100	5	Average
5150	53.01	53.72	74	-20.99	31.32	5.29	37.32	100	5	Peak
5220	89.08	89.74			31.37	5.33	37.36	100	5	Average
5220	98.84	99.5			31.37	5.33	37.36	100	5	Peak
5350	37.64	37.95	54	-16.36	31.48	5.39	37.18	100	5	Average
5350	53.38	53.69	74	-20.62	31.48	5.39	37.18	100	5	Peak

**REMARKS:**

- Emission Level = Read Level + Antenna Factor + Cable Loss - Preamp Factor  
Margin value = Emission level – Limit value
- 5220MHz: Fundamental frequency.





A D T

EUT TEST CONDITION		MEASUREMENT DETAIL	
CHANNEL	Channel 48	FREQUENCY RANGE	1GHz ~ 40GHz
INPUT POWER	120Vac, 60 Hz	DETECTOR FUNCTION	Peak (PK) Average (AV)
ENVIRONMENTAL CONDITIONS	25deg. C, 65%RH	TESTED BY	Johnson Liao

ANTENNA POLARITY & TEST DISTANCE: HORIZONTAL AT 3 M										
FREQ. (MHz)	EMISSION LEVEL (dBuV/m)	READ LEVEL (dBuV)	LIMIT (dBuV/m)	MARGIN (dB)	ANTENNA FACTOR (dB/m)	CABLE LOSS (dB)	PREAMP FACTOR (dB)	ANTENNA HEIGHT (cm)	TABLE ANGLE (Degree)	REMARK
5150	37.64	38.35	54	-16.36	31.32	5.29	37.32	126	240	Average
5150	54.22	54.93	74	-19.78	31.32	5.29	37.32	126	240	Peak
5240	94.66	95.25			31.39	5.34	37.32	126	240	Average
5240	103.53	104.12			31.39	5.34	37.32	126	240	Peak
5444	37.66	37.8	54	-16.34	31.55	5.44	37.13	126	240	Average
5444	55.7	55.84	74	-18.3	31.55	5.44	37.13	126	240	Peak
ANTENNA POLARITY & TEST DISTANCE: VERTICAL AT 3 M										
FREQ. (MHz)	EMISSION LEVEL (dBuV/m)	READ LEVEL (dBuV)	LIMIT (dBuV/m)	MARGIN (dB)	ANTENNA FACTOR (dB/m)	CABLE LOSS (dB)	PREAMP FACTOR (dB)	ANTENNA HEIGHT (cm)	TABLE ANGLE (Degree)	REMARK
5150	37.44	38.15	54	-16.56	31.32	5.29	37.32	100	6	Average
5150	52.85	53.56	74	-21.15	31.32	5.29	37.32	100	6	Peak
5240	88.56	89.15			31.39	5.34	37.32	100	6	Average
5240	97.73	98.32			31.39	5.34	37.32	100	6	Peak
5350	37.6	37.91	54	-16.4	31.48	5.39	37.18	100	6	Average
5350	52.96	53.27	74	-21.04	31.48	5.39	37.18	100	6	Peak

**REMARKS:**

- Emission Level = Read Level + Antenna Factor + Cable Loss - Preamp Factor  
Margin value = Emission level – Limit value
- 5240MHz: Fundamental frequency.



A D T

EUT TEST CONDITION		MEASUREMENT DETAIL	
CHANNEL	Channel 52	FREQUENCY RANGE	1GHz ~ 40GHz
INPUT POWER	120Vac, 60 Hz	DETECTOR FUNCTION	Peak (PK) Average (AV)
ENVIRONMENTAL CONDITIONS	25deg. C, 65%RH	TESTED BY	Johnson Liao

ANTENNA POLARITY & TEST DISTANCE: HORIZONTAL AT 3 M										
FREQ. (MHz)	EMISSION LEVEL (dBuV/m)	READ LEVEL (dBuV)	LIMIT (dBuV/m)	MARGIN (dB)	ANTENNA FACTOR (dB/m)	CABLE LOSS (dB)	PREAMP FACTOR (dB)	ANTENNA HEIGHT (cm)	TABLE ANGLE (Degree)	REMARK
5122	37.73	38.46	54	-16.27	31.29	5.28	37.3	111	231	Average
5122	59.21	59.94	74	-14.79	31.29	5.28	37.3	111	231	Peak
5260	96.3	96.82			31.41	5.34	37.27	111	231	Average
5260	105.59	106.11			31.41	5.34	37.27	111	231	Peak
5430	37.84	38	54	-16.16	31.55	5.42	37.13	111	231	Average
5430	59.68	59.84	74	-14.32	31.55	5.42	37.13	111	231	Peak
ANTENNA POLARITY & TEST DISTANCE: VERTICAL AT 3 M										
FREQ. (MHz)	EMISSION LEVEL (dBuV/m)	READ LEVEL (dBuV)	LIMIT (dBuV/m)	MARGIN (dB)	ANTENNA FACTOR (dB/m)	CABLE LOSS (dB)	PREAMP FACTOR (dB)	ANTENNA HEIGHT (cm)	TABLE ANGLE (Degree)	REMARK
5044	37.03	37.79	54	-16.97	31.24	5.25	37.25	116	88	Average
5044	58.95	59.71	74	-15.05	31.24	5.25	37.25	116	88	Peak
5260	93.99	94.51			31.41	5.34	37.27	116	88	Average
5260	103.56	104.08			31.41	5.34	37.27	116	88	Peak
5432	37.58	37.74	54	-16.42	31.55	5.42	37.13	116	88	Average
5432	59.99	60.15	74	-14.01	31.55	5.42	37.13	116	88	Peak

**REMARKS:**

- Emission Level = Read Level + Antenna Factor + Cable Loss - Preamp Factor  
Margin value = Emission level – Limit value
- 5260MHz: Fundamental frequency.



A D T

EUT TEST CONDITION		MEASUREMENT DETAIL	
CHANNEL	Channel 60	FREQUENCY RANGE	1GHz ~ 40GHz
INPUT POWER	120Vac, 60 Hz	DETECTOR FUNCTION	Peak (PK) Average (AV)
ENVIRONMENTAL CONDITIONS	25deg. C, 65%RH	TESTED BY	Johnson Liao

ANTENNA POLARITY & TEST DISTANCE: HORIZONTAL AT 3 M										
FREQ. (MHz)	EMISSION LEVEL (dBuV/m)	READ LEVEL (dBuV)	LIMIT (dBuV/m)	MARGIN (dB)	ANTENNA FACTOR (dB/m)	CABLE LOSS (dB)	PREAMP FACTOR (dB)	ANTENNA HEIGHT (cm)	TABLE ANGLE (Degree)	REMARK
5102	37.72	38.45	54	-16.28	31.28	5.27	37.28	110	234	Average
5102	59.46	60.19	74	-14.54	31.28	5.27	37.28	110	234	Peak
5300	96.61	96.99			31.44	5.37	37.19	110	234	Average
5300	106.36	106.74			31.44	5.37	37.19	110	234	Peak
5352	43.88	44.19	54	-10.12	31.48	5.39	37.18	110	234	Average
5352	59.51	59.82	74	-14.49	31.48	5.39	37.18	110	234	Peak
ANTENNA POLARITY & TEST DISTANCE: VERTICAL AT 3 M										
FREQ. (MHz)	EMISSION LEVEL (dBuV/m)	READ LEVEL (dBuV)	LIMIT (dBuV/m)	MARGIN (dB)	ANTENNA FACTOR (dB/m)	CABLE LOSS (dB)	PREAMP FACTOR (dB)	ANTENNA HEIGHT (cm)	TABLE ANGLE (Degree)	REMARK
5136	37.32	38.03	54	-16.68	31.31	5.28	37.3	116	88	Average
5136	59.61	60.32	74	-14.39	31.31	5.28	37.3	116	88	Peak
5300	94.6	94.98			31.44	5.37	37.19	116	88	Average
5300	103.92	104.3			31.44	5.37	37.19	116	88	Peak
5442	40.96	41.1	54	-13.04	31.55	5.44	37.13	116	88	Average
5442	60.53	60.67	74	-13.47	31.55	5.44	37.13	116	88	Peak

**REMARKS:**

- Emission Level = Read Level + Antenna Factor + Cable Loss - Preamp Factor  
Margin value = Emission level – Limit value
- 5300MHz: Fundamental frequency.



A D T

EUT TEST CONDITION		MEASUREMENT DETAIL	
CHANNEL	Channel 64	FREQUENCY RANGE	1GHz ~ 40GHz
INPUT POWER	120Vac, 60 Hz	DETECTOR FUNCTION	Peak (PK) Average (AV)
ENVIRONMENTAL CONDITIONS	25deg. C, 65%RH	TESTED BY	Johnson Liao

ANTENNA POLARITY & TEST DISTANCE: HORIZONTAL AT 3 M										
FREQ. (MHz)	EMISSION LEVEL (dBuV/m)	READ LEVEL (dBuV)	LIMIT (dBuV/m)	MARGIN (dB)	ANTENNA FACTOR (dB/m)	CABLE LOSS (dB)	PREAMP FACTOR (dB)	ANTENNA HEIGHT (cm)	TABLE ANGLE (Degree)	REMARK
5150	37.66	38.37	54	-16.34	31.32	5.29	37.32	111	231	Average
5150	59.89	60.6	74	-14.11	31.32	5.29	37.32	111	231	Peak
5320	96.77	97.13			31.45	5.38	37.19	111	231	Average
5320	105.97	106.33			31.45	5.38	37.19	111	231	Peak
5390	43.91	44.17	54	-10.09	31.51	5.41	37.18	111	231	Average
5390	59.63	59.89	74	-14.37	31.51	5.41	37.18	111	231	Peak
ANTENNA POLARITY & TEST DISTANCE: VERTICAL AT 3 M										
FREQ. (MHz)	EMISSION LEVEL (dBuV/m)	READ LEVEL (dBuV)	LIMIT (dBuV/m)	MARGIN (dB)	ANTENNA FACTOR (dB/m)	CABLE LOSS (dB)	PREAMP FACTOR (dB)	ANTENNA HEIGHT (cm)	TABLE ANGLE (Degree)	REMARK
5076	37.22	37.96	54	-16.78	31.27	5.26	37.27	116	88	Average
5076	59.43	60.17	74	-14.57	31.27	5.26	37.27	116	88	Peak
5320	95.02	95.38			31.45	5.38	37.19	116	88	Average
5320	103.82	104.18			31.45	5.38	37.19	116	88	Peak
5460	41.18	41.26	54	-12.82	31.56	5.44	37.08	116	88	Average
5460	59.18	59.26	74	-14.82	31.56	5.44	37.08	116	88	Peak

**REMARKS:**

- Emission Level = Read Level + Antenna Factor + Cable Loss - Preamp Factor  
Margin value = Emission level – Limit value
- 5320MHz: Fundamental frequency.



A D T

EUT TEST CONDITION		MEASUREMENT DETAIL	
CHANNEL	Channel 100	FREQUENCY RANGE	1GHz ~ 40GHz
INPUT POWER	120Vac, 60 Hz	DETECTOR FUNCTION	Peak (PK) Average (AV)
ENVIRONMENTAL CONDITIONS	25deg. C, 65%RH	TESTED BY	Johnson Liao

ANTENNA POLARITY & TEST DISTANCE: HORIZONTAL AT 3 M										
FREQ. (MHz)	EMISSION LEVEL (dBuV/m)	READ LEVEL (dBuV)	LIMIT (dBuV/m)	MARGIN (dB)	ANTENNA FACTOR (dB/m)	CABLE LOSS (dB)	PREAMP FACTOR (dB)	ANTENNA HEIGHT (cm)	TABLE ANGLE (Degree)	REMARK
5448	45.27	45.4	54	-8.73	31.56	5.44	37.13	100	232	Average
5448	60.76	60.89	74	-13.24	31.56	5.44	37.13	100	232	Peak
5470	61.51	61.57	68.3	-6.79	31.57	5.45	37.08	100	232	Peak
5500	96.66	96.63			31.6	5.46	37.03	100	232	Average
5500	106.2	106.17			31.6	5.46	37.03	100	232	Peak
5725	58.49	58.37	68.3	-9.81	31.96	5.59	37.43	100	232	Peak
ANTENNA POLARITY & TEST DISTANCE: VERTICAL AT 3 M										
FREQ. (MHz)	EMISSION LEVEL (dBuV/m)	READ LEVEL (dBuV)	LIMIT (dBuV/m)	MARGIN (dB)	ANTENNA FACTOR (dB/m)	CABLE LOSS (dB)	PREAMP FACTOR (dB)	ANTENNA HEIGHT (cm)	TABLE ANGLE (Degree)	REMARK
5374	43.72	44.01	54	-10.28	31.49	5.4	37.18	100	295	Average
5374	59.72	60.01	74	-14.28	31.49	5.4	37.18	100	295	Peak
5470	59.83	59.89	68.3	-8.47	31.57	5.45	37.08	100	295	Peak
5500	94.99	94.96			31.6	5.46	37.03	100	295	Average
5500	104.89	104.86			31.6	5.46	37.03	100	295	Peak
5725	57.93	57.81	68.3	-10.37	31.96	5.59	37.43	100	295	Peak

**REMARKS:**

- Emission Level = Read Level + Antenna Factor + Cable Loss - Preamp Factor  
Margin value = Emission level – Limit value
- 5500MHz: Fundamental frequency.
- 5470MHz & 5725MHz: Out of restricted band



A D T

EUT TEST CONDITION		MEASUREMENT DETAIL	
CHANNEL	Channel 116	FREQUENCY RANGE	1GHz ~ 40GHz
INPUT POWER	120Vac, 60 Hz	DETECTOR FUNCTION	Peak (PK) Average (AV)
ENVIRONMENTAL CONDITIONS	25deg. C, 65%RH	TESTED BY	Johnson Liao

ANTENNA POLARITY & TEST DISTANCE: HORIZONTAL AT 3 M										
FREQ. (MHz)	EMISSION LEVEL (dBuV/m)	READ LEVEL (dBuV)	LIMIT (dBuV/m)	MARGIN (dB)	ANTENNA FACTOR (dB/m)	CABLE LOSS (dB)	PREAMP FACTOR (dB)	ANTENNA HEIGHT (cm)	TABLE ANGLE (Degree)	REMARK
5350	37.73	38.04	54	-16.27	31.48	5.39	37.18	101	233	Average
5350	56.76	57.07	74	-17.24	31.48	5.39	37.18	101	233	Peak
5470	58.48	58.54	68.3	-9.82	31.57	5.45	37.08	101	233	Peak
5580	96.43	96.38			31.71	5.5	37.16	101	233	Average
5580	106.42	106.37			31.71	5.5	37.16	101	233	Peak
5725	59.14	59.02	68.3	-9.16	31.96	5.59	37.43	101	233	Peak
ANTENNA POLARITY & TEST DISTANCE: VERTICAL AT 3 M										
FREQ. (MHz)	EMISSION LEVEL (dBuV/m)	READ LEVEL (dBuV)	LIMIT (dBuV/m)	MARGIN (dB)	ANTENNA FACTOR (dB/m)	CABLE LOSS (dB)	PREAMP FACTOR (dB)	ANTENNA HEIGHT (cm)	TABLE ANGLE (Degree)	REMARK
5430	37.72	37.88	54	-16.28	31.55	5.42	37.13	100	296	Average
5430	59.46	59.62	74	-14.54	31.55	5.42	37.13	100	296	Peak
5470	58.99	59.05	68.3	-9.31	31.57	5.45	37.08	100	296	Peak
5580	94.36	94.31			31.71	5.5	37.16	100	296	Average
5580	104.08	104.03			31.71	5.5	37.16	100	296	Peak
5725	59.21	59.09	68.3	-9.09	31.96	5.59	37.43	100	296	Peak

**REMARKS:**

- Emission Level = Read Level + Antenna Factor + Cable Loss - Preamp Factor  
Margin value = Emission level – Limit value
- 5580MHz: Fundamental frequency.
- 5470MHz & 5725MHz: Out of restricted band



A D T

EUT TEST CONDITION		MEASUREMENT DETAIL	
CHANNEL	Channel 140	FREQUENCY RANGE	1GHz ~ 40GHz
INPUT POWER	120Vac, 60 Hz	DETECTOR FUNCTION	Peak (PK) Average (AV)
ENVIRONMENTAL CONDITIONS	25deg. C, 65%RH	TESTED BY	Johnson Liao

ANTENNA POLARITY & TEST DISTANCE: HORIZONTAL AT 3 M										
FREQ. (MHz)	EMISSION LEVEL (dBuV/m)	READ LEVEL (dBuV)	LIMIT (dBuV/m)	MARGIN (dB)	ANTENNA FACTOR (dB/m)	CABLE LOSS (dB)	PREAMP FACTOR (dB)	ANTENNA HEIGHT (cm)	TABLE ANGLE (Degree)	REMARK
5350	37.63	37.94	54	-16.37	31.48	5.39	37.18	102	236	Average
5350	58.01	58.32	74	-15.99	31.48	5.39	37.18	102	236	Peak
5470	56.94	57	68.3	-11.36	31.57	5.45	37.08	102	236	Peak
5700	96.67	96.6			31.9	5.57	37.4	102	236	Average
5700	105.87	105.8			31.9	5.57	37.4	102	236	Peak
5725	59.66	59.54	68.3	-8.64	31.96	5.59	37.43	102	236	Peak
ANTENNA POLARITY & TEST DISTANCE: VERTICAL AT 3 M										
FREQ. (MHz)	EMISSION LEVEL (dBuV/m)	READ LEVEL (dBuV)	LIMIT (dBuV/m)	MARGIN (dB)	ANTENNA FACTOR (dB/m)	CABLE LOSS (dB)	PREAMP FACTOR (dB)	ANTENNA HEIGHT (cm)	TABLE ANGLE (Degree)	REMARK
5434	37.56	37.72	54	-16.44	31.55	5.42	37.13	100	200	Average
5434	58.67	58.83	74	-15.33	31.55	5.42	37.13	100	200	Peak
5470	58.72	58.78	68.3	-9.58	31.57	5.45	37.08	100	200	Peak
5700	94.06	93.99			31.9	5.57	37.4	100	200	Average
5700	103.61	103.54			31.9	5.57	37.4	100	200	Peak
5725	62.3	62.18	68.3	-6	31.96	5.59	37.43	100	200	Peak

**REMARKS:**

- Emission Level = Read Level + Antenna Factor + Cable Loss - Preamp Factor  
Margin value = Emission level – Limit value
- 5700MHz: Fundamental frequency.
- 5470MHz & 5725MHz: Out of restricted band



A D T

**802.11n (40MHz)**

EUT TEST CONDITION		MEASUREMENT DETAIL	
CHANNEL	Channel 38	FREQUENCY RANGE	1GHz ~ 40GHz
INPUT POWER	120Vac, 60 Hz	DETECTOR FUNCTION	Peak (PK) Average (AV)
ENVIRONMENTAL CONDITIONS	25deg. C, 65%RH	TESTED BY	Johnson Liao

ANTENNA POLARITY & TEST DISTANCE: HORIZONTAL AT 3 M										
FREQ. (MHz)	EMISSION LEVEL (dBuV/m)	READ LEVEL (dBuV)	LIMIT (dBuV/m)	MARGIN (dB)	ANTENNA FACTOR (dB/m)	CABLE LOSS (dB)	PREAMP FACTOR (dB)	ANTENNA HEIGHT (cm)	TABLE ANGLE (Degree)	REMARK
5150	43.42	44.13	54	-10.58	31.32	5.29	37.32	100	238	Average
5150	56.35	57.06	74	-17.65	31.32	5.29	37.32	100	238	Peak
5190	91.12	91.79			31.35	5.32	37.34	100	238	Average
5190	100.42	101.09			31.35	5.32	37.34	100	238	Peak
5350	37.92	38.23	54	-16.08	31.48	5.39	37.18	100	238	Average
5350	53.4	53.71	74	-20.6	31.48	5.39	37.18	100	238	Peak
ANTENNA POLARITY & TEST DISTANCE: VERTICAL AT 3 M										
FREQ. (MHz)	EMISSION LEVEL (dBuV/m)	READ LEVEL (dBuV)	LIMIT (dBuV/m)	MARGIN (dB)	ANTENNA FACTOR (dB/m)	CABLE LOSS (dB)	PREAMP FACTOR (dB)	ANTENNA HEIGHT (cm)	TABLE ANGLE (Degree)	REMARK
5150	40.68	41.39	54	-13.32	31.32	5.29	37.32	100	6	Average
5150	54.56	55.27	74	-19.44	31.32	5.29	37.32	100	6	Peak
5190	85.24	85.91			31.35	5.32	37.34	100	6	Average
5190	94.3	94.97			31.35	5.32	37.34	100	6	Peak
5350	38.07	38.38	54	-15.93	31.48	5.39	37.18	100	6	Average
5350	52.72	53.03	74	-21.28	31.48	5.39	37.18	100	6	Peak

**REMARKS:**

- Emission Level = Read Level + Antenna Factor + Cable Loss - Preamp Factor  
Margin value = Emission level – Limit value
- 5190MHz: Fundamental frequency.





A D T

EUT TEST CONDITION		MEASUREMENT DETAIL	
CHANNEL	Channel 46	FREQUENCY RANGE	1GHz ~ 40GHz
INPUT POWER	120Vac, 60 Hz	DETECTOR FUNCTION	Peak (PK) Average (AV)
ENVIRONMENTAL CONDITIONS	25deg. C, 65%RH	TESTED BY	Johnson Liao

ANTENNA POLARITY & TEST DISTANCE: HORIZONTAL AT 3 M										
FREQ. (MHz)	EMISSION LEVEL (dBuV/m)	READ LEVEL (dBuV)	LIMIT (dBuV/m)	MARGIN (dB)	ANTENNA FACTOR (dB/m)	CABLE LOSS (dB)	PREAMP FACTOR (dB)	ANTENNA HEIGHT (cm)	TABLE ANGLE (Degree)	REMARK
5150	39.02	39.73	54	-14.98	31.32	5.29	37.32	112	239	Average
5150	54.09	54.8	74	-19.91	31.32	5.29	37.32	112	239	Peak
5230	91.02	91.62			31.39	5.33	37.32	112	239	Average
5230	100.1	100.7			31.39	5.33	37.32	112	239	Peak
5350	37.9	38.21	54	-16.1	31.48	5.39	37.18	112	239	Average
5350	54.25	54.56	74	-19.75	31.48	5.39	37.18	112	239	Peak
ANTENNA POLARITY & TEST DISTANCE: VERTICAL AT 3 M										
FREQ. (MHz)	EMISSION LEVEL (dBuV/m)	READ LEVEL (dBuV)	LIMIT (dBuV/m)	MARGIN (dB)	ANTENNA FACTOR (dB/m)	CABLE LOSS (dB)	PREAMP FACTOR (dB)	ANTENNA HEIGHT (cm)	TABLE ANGLE (Degree)	REMARK
5150	38.16	38.87	54	-15.84	31.32	5.29	37.32	100	6	Average
5150	53.31	54.02	74	-20.69	31.32	5.29	37.32	100	6	Peak
5230	85.56	86.16			31.39	5.33	37.32	100	6	Average
5230	94.54	95.14			31.39	5.33	37.32	100	6	Peak
5350	37.78	38.09	54	-16.22	31.48	5.39	37.18	100	6	Average
5350	53.83	54.14	74	-20.17	31.48	5.39	37.18	100	6	Peak

**REMARKS:**

- Emission Level = Read Level + Antenna Factor + Cable Loss - Preamp Factor  
Margin value = Emission level – Limit value
- 5230MHz: Fundamental frequency.



A D T

EUT TEST CONDITION		MEASUREMENT DETAIL	
CHANNEL	Channel 54	FREQUENCY RANGE	1GHz ~ 40GHz
INPUT POWER	120Vac, 60 Hz	DETECTOR FUNCTION	Peak (PK) Average (AV)
ENVIRONMENTAL CONDITIONS	25deg. C, 65%RH	TESTED BY	Johnson Liao

ANTENNA POLARITY & TEST DISTANCE: HORIZONTAL AT 3 M										
FREQ. (MHz)	EMISSION LEVEL (dBuV/m)	READ LEVEL (dBuV)	LIMIT (dBuV/m)	MARGIN (dB)	ANTENNA FACTOR (dB/m)	CABLE LOSS (dB)	PREAMP FACTOR (dB)	ANTENNA HEIGHT (cm)	TABLE ANGLE (Degree)	REMARK
5018	37.74	38.53	54	-16.26	31.21	5.24	37.24	101	230	Average
5018	59.02	59.81	74	-14.98	31.21	5.24	37.24	101	230	Peak
5270	92.76	93.27			31.41	5.35	37.27	101	230	Average
5270	101.87	102.38			31.41	5.35	37.27	101	230	Peak
5410	39.55	39.8	54	-14.45	31.52	5.41	37.18	101	230	Average
5410	59.6	59.85	74	-14.4	31.52	5.41	37.18	101	230	Peak
ANTENNA POLARITY & TEST DISTANCE: VERTICAL AT 3 M										
FREQ. (MHz)	EMISSION LEVEL (dBuV/m)	READ LEVEL (dBuV)	LIMIT (dBuV/m)	MARGIN (dB)	ANTENNA FACTOR (dB/m)	CABLE LOSS (dB)	PREAMP FACTOR (dB)	ANTENNA HEIGHT (cm)	TABLE ANGLE (Degree)	REMARK
5118	37.75	38.46	54	-16.25	31.29	5.28	37.28	126	88	Average
5118	59.02	59.73	74	-14.98	31.29	5.28	37.28	126	88	Peak
5270	90.09	90.6			31.41	5.35	37.27	126	88	Average
5270	99.14	99.65			31.41	5.35	37.27	126	88	Peak
5384	38.75	39.02	54	-15.25	31.51	5.4	37.18	126	88	Average
5384	60.04	60.31	74	-13.96	31.51	5.4	37.18	126	88	Peak

**REMARKS:**

- Emission Level = Read Level + Antenna Factor + Cable Loss - Preamp Factor  
Margin value = Emission level – Limit value
- 5270MHz: Fundamental frequency.



A D T

EUT TEST CONDITION		MEASUREMENT DETAIL	
CHANNEL	Channel 62	FREQUENCY RANGE	1GHz ~ 40GHz
INPUT POWER	120Vac, 60 Hz	DETECTOR FUNCTION	Peak (PK) Average (AV)
ENVIRONMENTAL CONDITIONS	25deg. C, 65%RH	TESTED BY	Johnson Liao

ANTENNA POLARITY & TEST DISTANCE: HORIZONTAL AT 3 M										
FREQ. (MHz)	EMISSION LEVEL (dBuV/m)	READ LEVEL (dBuV)	LIMIT (dBuV/m)	MARGIN (dB)	ANTENNA FACTOR (dB/m)	CABLE LOSS (dB)	PREAMP FACTOR (dB)	ANTENNA HEIGHT (cm)	TABLE ANGLE (Degree)	REMARK
5144	37.91	38.62	54	-16.09	31.32	5.29	37.32	100	230	Average
5144	60.05	60.76	74	-13.95	31.32	5.29	37.32	100	230	Peak
5310	92.93	93.3			31.45	5.37	37.19	100	230	Average
5310	102.16	102.53			31.45	5.37	37.19	100	230	Peak
5410	42.4	42.65	54	-11.6	31.52	5.41	37.18	100	230	Average
5410	59.7	59.95	74	-14.3	31.52	5.41	37.18	100	230	Peak
ANTENNA POLARITY & TEST DISTANCE: VERTICAL AT 3 M										
FREQ. (MHz)	EMISSION LEVEL (dBuV/m)	READ LEVEL (dBuV)	LIMIT (dBuV/m)	MARGIN (dB)	ANTENNA FACTOR (dB/m)	CABLE LOSS (dB)	PREAMP FACTOR (dB)	ANTENNA HEIGHT (cm)	TABLE ANGLE (Degree)	REMARK
5114	37.77	38.48	54	-16.23	31.29	5.28	37.28	125	101	Average
5114	59.34	60.05	74	-14.66	31.29	5.28	37.28	125	101	Peak
5310	90.96	91.33			31.45	5.37	37.19	125	101	Average
5310	100.08	100.45			31.45	5.37	37.19	125	101	Peak
5440	40.53	40.67	54	-13.47	31.55	5.44	37.13	125	101	Average
5440	59.47	59.61	74	-14.53	31.55	5.44	37.13	125	101	Peak

**REMARKS:**

- Emission Level = Read Level + Antenna Factor + Cable Loss - Preamp Factor  
Margin value = Emission level – Limit value
- 5310MHz: Fundamental frequency.



A D T

EUT TEST CONDITION		MEASUREMENT DETAIL	
CHANNEL	Channel 102	FREQUENCY RANGE	1GHz ~ 40GHz
INPUT POWER	120Vac, 60 Hz	DETECTOR FUNCTION	Peak (PK) Average (AV)
ENVIRONMENTAL CONDITIONS	25deg. C, 65%RH	TESTED BY	Johnson Liao

ANTENNA POLARITY & TEST DISTANCE: HORIZONTAL AT 3 M										
FREQ. (MHz)	EMISSION LEVEL (dBuV/m)	READ LEVEL (dBuV)	LIMIT (dBuV/m)	MARGIN (dB)	ANTENNA FACTOR (dB/m)	CABLE LOSS (dB)	PREAMP FACTOR (dB)	ANTENNA HEIGHT (cm)	TABLE ANGLE (Degree)	REMARK
5460	39.88	39.96	54	-14.12	31.56	5.44	37.08	107	233	Average
5460	58.94	59.02	74	-15.06	31.56	5.44	37.08	107	233	Peak
5470	59.44	59.5	68.3	-8.86	31.57	5.45	37.08	107	233	Peak
5510	92.83	92.83			31.6	5.46	37.06	107	233	Average
5510	102.3	102.3			31.6	5.46	37.06	107	233	Peak
5725	58.08	57.96	68.3	-10.22	31.96	5.59	37.43	107	233	Peak
ANTENNA POLARITY & TEST DISTANCE: VERTICAL AT 3 M										
FREQ. (MHz)	EMISSION LEVEL (dBuV/m)	READ LEVEL (dBuV)	LIMIT (dBuV/m)	MARGIN (dB)	ANTENNA FACTOR (dB/m)	CABLE LOSS (dB)	PREAMP FACTOR (dB)	ANTENNA HEIGHT (cm)	TABLE ANGLE (Degree)	REMARK
5438	40.01	40.15	54	-13.99	31.55	5.44	37.13	100	296	Average
5438	58.82	58.96	74	-15.18	31.55	5.44	37.13	100	296	Peak
5470	57.99	58.05	68.3	-10.31	31.57	5.45	37.08	100	296	Peak
5510	91.52	91.52			31.6	5.46	37.06	100	296	Average
5510	100.62	100.62			31.6	5.46	37.06	100	296	Peak
5725	58.28	58.16	68.3	-10.02	31.96	5.59	37.43	100	296	Peak

**REMARKS:**

- Emission Level = Read Level + Antenna Factor + Cable Loss - Preamp Factor  
Margin value = Emission level – Limit value
- 5510MHz: Fundamental frequency.
- 5470MHz & 5725MHz: Out of restricted band



A D T

EUT TEST CONDITION		MEASUREMENT DETAIL	
CHANNEL	Channel 110	FREQUENCY RANGE	1GHz ~ 40GHz
INPUT POWER	120Vac, 60 Hz	DETECTOR FUNCTION	Peak (PK) Average (AV)
ENVIRONMENTAL CONDITIONS	25deg. C, 65%RH	TESTED BY	Johnson Liao

ANTENNA POLARITY & TEST DISTANCE: HORIZONTAL AT 3 M										
FREQ. (MHz)	EMISSION LEVEL (dBuV/m)	READ LEVEL (dBuV)	LIMIT (dBuV/m)	MARGIN (dB)	ANTENNA FACTOR (dB/m)	CABLE LOSS (dB)	PREAMP FACTOR (dB)	ANTENNA HEIGHT (cm)	TABLE ANGLE (Degree)	REMARK
5442	40.89	41.03	54	-13.11	31.55	5.44	37.13	100	232	Average
5442	59.33	59.47	74	-14.67	31.55	5.44	37.13	100	232	Peak
5470	58.46	58.52	68.3	-9.84	31.57	5.45	37.08	100	232	Peak
5550	93.15	93.07			31.68	5.49	37.09	100	232	Average
5550	103.33	103.25			31.68	5.49	37.09	100	232	Peak
5725	58.1	57.98	68.3	-10.2	31.96	5.59	37.43	100	232	Peak
ANTENNA POLARITY & TEST DISTANCE: VERTICAL AT 3 M										
FREQ. (MHz)	EMISSION LEVEL (dBuV/m)	READ LEVEL (dBuV)	LIMIT (dBuV/m)	MARGIN (dB)	ANTENNA FACTOR (dB/m)	CABLE LOSS (dB)	PREAMP FACTOR (dB)	ANTENNA HEIGHT (cm)	TABLE ANGLE (Degree)	REMARK
5424	40.19	40.42	54	-13.81	31.53	5.42	37.18	100	294	Average
5424	59.18	59.41	74	-14.82	31.53	5.42	37.18	100	294	Peak
5470	56.53	56.59	68.3	-11.77	31.57	5.45	37.08	100	294	Peak
5550	92.02	91.94			31.68	5.49	37.09	100	294	Average
5550	101.83	101.75			31.68	5.49	37.09	100	294	Peak
5725	57.9	57.78	68.3	-10.4	31.96	5.59	37.43	100	294	Peak

**REMARKS:**

- Emission Level = Read Level + Antenna Factor + Cable Loss - Preamp Factor  
Margin value = Emission level – Limit value
- 5550MHz: Fundamental frequency.
- 5470MHz & 5725MHz: Out of restricted band



A D T

EUT TEST CONDITION		MEASUREMENT DETAIL	
CHANNEL	Channel 134	FREQUENCY RANGE	1GHz ~ 40GHz
INPUT POWER	120Vac, 60 Hz	DETECTOR FUNCTION	Peak (PK) Average (AV)
ENVIRONMENTAL CONDITIONS	25deg. C, 65%RH	TESTED BY	Johnson Liao

ANTENNA POLARITY & TEST DISTANCE: HORIZONTAL AT 3 M										
FREQ. (MHz)	EMISSION LEVEL (dBuV/m)	READ LEVEL (dBuV)	LIMIT (dBuV/m)	MARGIN (dB)	ANTENNA FACTOR (dB/m)	CABLE LOSS (dB)	PREAMP FACTOR (dB)	ANTENNA HEIGHT (cm)	TABLE ANGLE (Degree)	REMARK
5350	38.02	38.33	54	-15.98	31.48	5.39	37.18	103	233	Average
5350	57.8	58.11	74	-16.2	31.48	5.39	37.18	103	233	Peak
5470	57.95	58.01	68.3	-10.35	31.57	5.45	37.08	103	233	Peak
5670	93.7	93.6			31.88	5.56	37.34	103	233	Average
5670	102.59	102.49			31.88	5.56	37.34	103	233	Peak
5725	58.94	58.82	68.3	-9.36	31.96	5.59	37.43	103	233	Peak
ANTENNA POLARITY & TEST DISTANCE: VERTICAL AT 3 M										
FREQ. (MHz)	EMISSION LEVEL (dBuV/m)	READ LEVEL (dBuV)	LIMIT (dBuV/m)	MARGIN (dB)	ANTENNA FACTOR (dB/m)	CABLE LOSS (dB)	PREAMP FACTOR (dB)	ANTENNA HEIGHT (cm)	TABLE ANGLE (Degree)	REMARK
5432	38.01	38.17	54	-15.99	31.55	5.42	37.13	102	196	Average
5432	59.25	59.41	74	-14.75	31.55	5.42	37.13	102	196	Peak
5470	58.85	58.91	68.3	-9.45	31.57	5.45	37.08	102	196	Peak
5670	91.42	91.32			31.88	5.56	37.34	102	196	Average
5670	100.16	100.06			31.88	5.56	37.34	102	196	Peak
5725	58.13	58.01	68.3	-10.17	31.96	5.59	37.43	102	196	Peak

**REMARKS:**

- Emission Level = Read Level + Antenna Factor + Cable Loss - Preamp Factor  
Margin value = Emission level – Limit value
- 5670MHz: Fundamental frequency.
- 5470MHz & 5725MHz: Out of restricted band



A D T

**MODE B**

**802.11n (40MHz)**

EUT TEST CONDITION		MEASUREMENT DETAIL	
CHANNEL	Channel 38	FREQUENCY RANGE	1GHz ~ 40GHz
INPUT POWER	120Vac, 60 Hz	DETECTOR FUNCTION	Peak (PK) Average (AV)
ENVIRONMENTAL CONDITIONS	25deg. C, 65%RH	TESTED BY	Johnson Liao

ANTENNA POLARITY & TEST DISTANCE: HORIZONTAL AT 3 M										
FREQ. (MHz)	EMISSION LEVEL (dBuV/m)	READ LEVEL (dBuV)	LIMIT (dBuV/m)	MARGIN (dB)	ANTENNA FACTOR (dB/m)	CABLE LOSS (dB)	PREAMP FACTOR (dB)	ANTENNA HEIGHT (cm)	TABLE ANGLE (Degree)	REMARK
5150	43.74	44.45	54	-10.26	31.32	5.29	37.32	100	236	Average
5150	56.68	57.39	74	-17.32	31.32	5.29	37.32	100	236	Peak
5190	91.7	92.37			31.35	5.32	37.34	100	236	Average
5190	100.66	101.33			31.35	5.32	37.34	100	236	Peak
5356	38.02	38.33	54	-15.98	31.48	5.39	37.18	100	236	Average
5356	58.87	59.18	74	-15.13	31.48	5.39	37.18	100	236	Peak
ANTENNA POLARITY & TEST DISTANCE: VERTICAL AT 3 M										
FREQ. (MHz)	EMISSION LEVEL (dBuV/m)	READ LEVEL (dBuV)	LIMIT (dBuV/m)	MARGIN (dB)	ANTENNA FACTOR (dB/m)	CABLE LOSS (dB)	PREAMP FACTOR (dB)	ANTENNA HEIGHT (cm)	TABLE ANGLE (Degree)	REMARK
5150	40.39	41.1	54	-13.61	31.32	5.29	37.32	100	355	Average
5150	55.62	56.33	74	-18.38	31.32	5.29	37.32	100	355	Peak
5190	85.23	85.9			31.35	5.32	37.34	100	355	Average
5190	94.19	94.86			31.35	5.32	37.34	100	355	Peak
5354	38.19	38.5	54	-15.81	31.48	5.39	37.18	100	355	Average
5354	58.67	58.98	74	-15.33	31.48	5.39	37.18	100	355	Peak

**REMARKS:**

- Emission Level = Read Level + Antenna Factor + Cable Loss - Preamp Factor  
Margin value = Emission level – Limit value
- 5190MHz: Fundamental frequency.



A D T

802.11n (20MHz)

EUT TEST CONDITION		MEASUREMENT DETAIL	
CHANNEL	Channel 64	FREQUENCY RANGE	1GHz ~ 40GHz
INPUT POWER	120Vac, 60 Hz	DETECTOR FUNCTION	Peak (PK) Average (AV)
ENVIRONMENTAL CONDITIONS	25deg. C, 65%RH	TESTED BY	Johnson Liao

ANTENNA POLARITY & TEST DISTANCE: HORIZONTAL AT 3 M

FREQ. (MHz)	EMISSION LEVEL (dBuV/m)	READ LEVEL (dBuV)	LIMIT (dBuV/m)	MARGIN (dB)	ANTENNA FACTOR (dB/m)	CABLE LOSS (dB)	PREAMP FACTOR (dB)	ANTENNA HEIGHT (cm)	TABLE ANGLE (Degree)	REMARK
5136	37.8	38.51	54	-16.2	31.31	5.28	37.3	100	230	Average
5136	58.18	58.89	74	-15.82	31.31	5.28	37.3	100	230	Peak
5320	96.04	96.4			31.45	5.38	37.19	100	230	Average
5320	105.2	105.56			31.45	5.38	37.19	100	230	Peak
5390	43.38	43.64	54	-10.62	31.51	5.41	37.18	100	230	Average
5390	59.27	59.53	74	-14.73	31.51	5.41	37.18	100	230	Peak

ANTENNA POLARITY & TEST DISTANCE: VERTICAL AT 3 M

FREQ. (MHz)	EMISSION LEVEL (dBuV/m)	READ LEVEL (dBuV)	LIMIT (dBuV/m)	MARGIN (dB)	ANTENNA FACTOR (dB/m)	CABLE LOSS (dB)	PREAMP FACTOR (dB)	ANTENNA HEIGHT (cm)	TABLE ANGLE (Degree)	REMARK
5116	37.67	38.38	54	-16.33	31.29	5.28	37.28	103	295	Average
5116	59.99	60.7	74	-14.01	31.29	5.28	37.28	103	295	Peak
5320	94.56	94.92			31.45	5.38	37.19	103	295	Average
5320	103.69	104.05			31.45	5.38	37.19	103	295	Peak
5370	41.78	42.07	54	-12.22	31.49	5.4	37.18	103	295	Average
5370	59.23	59.52	74	-14.77	31.49	5.4	37.18	103	295	Peak

REMARKS:

- Emission Level = Read Level + Antenna Factor + Cable Loss - Preamp Factor  
Margin value = Emission level – Limit value
- 5320MHz: Fundamental frequency.





A D T

802.11a

EUT TEST CONDITION		MEASUREMENT DETAIL	
CHANNEL	Channel 140	FREQUENCY RANGE	1GHz ~ 40GHz
INPUT POWER	120Vac, 60 Hz	DETECTOR FUNCTION	Peak (PK) Average (AV)
ENVIRONMENTAL CONDITIONS	25deg. C, 65%RH	TESTED BY	Johnson Liao

ANTENNA POLARITY & TEST DISTANCE: HORIZONTAL AT 3 M										
FREQ. (MHz)	EMISSION LEVEL (dBuV/m)	READ LEVEL (dBuV)	LIMIT (dBuV/m)	MARGIN (dB)	ANTENNA FACTOR (dB/m)	CABLE LOSS (dB)	PREAMP FACTOR (dB)	ANTENNA HEIGHT (cm)	TABLE ANGLE (Degree)	REMARK
5454	37.95	38.03	54	-16.05	31.56	5.44	37.08	100	229	Average
5454	59.63	59.71	74	-14.37	31.56	5.44	37.08	100	229	Peak
5470	57.73	57.79	68.3	-10.57	31.57	5.45	37.08	100	229	Peak
5700	97.41	97.34			31.9	5.57	37.4	100	229	Average
5700	106.38	106.31			31.9	5.57	37.4	100	229	Peak
5725	63.47	63.35	68.3	-4.83	31.96	5.59	37.43	100	229	Peak
ANTENNA POLARITY & TEST DISTANCE: VERTICAL AT 3 M										
FREQ. (MHz)	EMISSION LEVEL (dBuV/m)	READ LEVEL (dBuV)	LIMIT (dBuV/m)	MARGIN (dB)	ANTENNA FACTOR (dB/m)	CABLE LOSS (dB)	PREAMP FACTOR (dB)	ANTENNA HEIGHT (cm)	TABLE ANGLE (Degree)	REMARK
5434	37.86	38.02	54	-16.14	31.55	5.42	37.13	111	148	Average
5434	59.77	59.93	74	-14.23	31.55	5.42	37.13	111	148	Peak
5470	57.05	57.11	68.3	-11.25	31.57	5.45	37.08	111	148	Peak
5700	94.17	94.1			31.9	5.57	37.4	111	148	Average
5700	103.76	103.69			31.9	5.57	37.4	111	148	Peak
5725	62.42	62.3	68.3	-5.88	31.96	5.59	37.43	111	148	Peak

REMARKS:

- Emission Level = Read Level + Antenna Factor + Cable Loss - Preamp Factor  
Margin value = Emission level – Limit value
- 5700MHz: Fundamental frequency.
- 5470MHz & 5725MHz: Out of restricted band



A D T

**BELOW 1GHz WORST-CASE DATA:**

**802.11n (40MHz)**

EUT TEST CONDITION		MEASUREMENT DETAIL	
CHANNEL	Channel 38	FREQUENCY RANGE	30MHz ~ 1GHz
INPUT POWER	120Vac, 60 Hz	DETECTOR FUNCTION	Peak (PK)
ENVIRONMENTAL CONDITIONS	25deg. C, 65%RH	TESTED BY	Johnson Liao

**ANTENNA POLARITY & TEST DISTANCE: HORIZONTAL AT 3 M**

FREQ. (MHz)	EMISSION LEVEL (dBuV/m)	READ LEVEL (dBuV)	LIMIT (dBuV/m)	MARGIN (dB)	ANTENNA FACTOR (dB/m)	CABLE LOSS (dB)	PREAMP FACTOR (dB)	ANTENNA HEIGHT (cm)	TABLE ANGLE (Degree)	REMARK
105.6	24.56	45.73	43.5	-18.94	9.62	1.1	31.89	100	169	Peak
142.86	24.18	42.06	43.5	-19.32	12.44	1.31	31.63	100	245	Peak
234.12	20.65	39.93	46	-25.35	10.79	1.76	31.83	100	176	Peak
503.7	21.39	32.81	46	-24.61	17.4	2.79	31.61	100	251	Peak
732.6	25.65	32.43	46	-20.35	21.27	3.52	31.57	100	198	Peak
950.3	27.61	31.57	46	-18.39	23.79	4.08	31.83	100	306	Peak

**ANTENNA POLARITY & TEST DISTANCE: VERTICAL AT 3 M**

FREQ. (MHz)	EMISSION LEVEL (dBuV/m)	READ LEVEL (dBuV)	LIMIT (dBuV/m)	MARGIN (dB)	ANTENNA FACTOR (dB/m)	CABLE LOSS (dB)	PREAMP FACTOR (dB)	ANTENNA HEIGHT (cm)	TABLE ANGLE (Degree)	REMARK
30.51	35.62	54.03	40	-4.38	12.14	0.57	31.12	100	53	Peak
62.94	29.37	48.43	40	-10.63	11.59	0.85	31.5	100	189	Peak
102.36	20.93	42.43	43.5	-22.57	9.34	1.08	31.92	100	200	Peak
669.6	23.93	32	46	-22.07	20.44	3.31	31.82	100	192	Peak
847.4	26.58	31.79	46	-19.42	22.84	3.81	31.86	100	173	Peak
988.1	28.16	31.76	54	-25.84	24	4.15	31.75	100	42	Peak

**REMARKS:** Emission Level = Read Level + Antenna Factor + Cable Loss - Preamp Factor

Margin value = Emission level – Limit value



A D T

**802.11n (20MHz)**

EUT TEST CONDITION		MEASUREMENT DETAIL	
CHANNEL	Channel 64	FREQUENCY RANGE	30MHz ~ 1GHz
INPUT POWER	120Vac, 60 Hz	DETECTOR FUNCTION	Peak (PK)
ENVIRONMENTAL CONDITIONS	25deg. C, 65%RH	TESTED BY	Johnson Liao

**ANTENNA POLARITY & TEST DISTANCE: HORIZONTAL AT 3 M**

FREQ. (MHz)	EMISSION LEVEL (dBuV/m)	READ LEVEL (dBuV)	LIMIT (dBuV/m)	MARGIN (dB)	ANTENNA FACTOR (dB/m)	CABLE LOSS (dB)	PREAMP FACTOR (dB)	ANTENNA HEIGHT (cm)	TABLE ANGLE (Degree)	REMARK
62.67	20.56	39.62	40	-19.44	11.59	0.85	31.5	100	112	Peak
108.57	22.23	43.06	43.5	-21.27	9.9	1.12	31.85	100	209	Peak
207.12	21.21	41.53	43.5	-22.29	9.69	1.63	31.64	100	139	Peak
422.5	18.93	32.67	46	-27.07	15.79	2.51	32.04	100	198	Peak
678.7	24.05	31.98	46	-21.95	20.56	3.35	31.84	100	202	Peak
929.3	27.57	31.86	46	-18.43	23.67	4.03	31.99	100	116	Peak

**ANTENNA POLARITY & TEST DISTANCE: VERTICAL AT 3 M**

FREQ. (MHz)	EMISSION LEVEL (dBuV/m)	READ LEVEL (dBuV)	LIMIT (dBuV/m)	MARGIN (dB)	ANTENNA FACTOR (dB/m)	CABLE LOSS (dB)	PREAMP FACTOR (dB)	ANTENNA HEIGHT (cm)	TABLE ANGLE (Degree)	REMARK
31.37	35.67	54.08	40	-4.33	12.14	0.57	31.12	100	148	Peak
40.53	29.96	46.76	40	-10.04	13.55	0.67	31.02	100	246	Peak
65.1	27.09	46.47	40	-12.91	11.35	0.86	31.59	100	103	Peak
377.7	18.26	33.07	46	-27.74	14.8	2.33	31.94	100	87	Peak
468	19.78	32.31	46	-26.22	16.7	2.68	31.91	100	260	Peak
801.2	25.81	31.3	46	-20.19	22.24	3.7	31.43	100	155	Peak

**REMARKS:** Emission Level = Read Level + Antenna Factor + Cable Loss - Preamp Factor  
 Margin value = Emission level – Limit value



A D T

802.11a

EUT TEST CONDITION		MEASUREMENT DETAIL	
CHANNEL	Channel 140	FREQUENCY RANGE	30MHz ~ 1GHz
INPUT POWER	120Vac, 60 Hz	DETECTOR FUNCTION	Peak (PK)
ENVIRONMENTAL CONDITIONS	25deg. C, 65%RH	TESTED BY	Johnson Liao

**ANTENNA POLARITY & TEST DISTANCE: HORIZONTAL AT 3 M**

FREQ. (MHz)	EMISSION LEVEL (dBuV/m)	READ LEVEL (dBuV)	LIMIT (dBuV/m)	MARGIN (dB)	ANTENNA FACTOR (dB/m)	CABLE LOSS (dB)	PREAMP FACTOR (dB)	ANTENNA HEIGHT (cm)	TABLE ANGLE (Degree)	REMARK
57.54	20.82	39.11	40	-19.18	12.25	0.81	31.35	100	120	Peak
107.76	24.19	45.13	43.5	-19.31	9.81	1.11	31.86	100	265	Peak
152.31	25.05	42.65	43.5	-18.45	12.71	1.35	31.66	100	66	Peak
516.3	20.84	31.91	46	-25.16	17.68	2.83	31.58	100	325	Peak
726.3	25.21	32.13	46	-20.79	21.19	3.51	31.62	100	211	Peak
960.8	28.22	32.19	54	-25.78	23.85	4.1	31.92	100	42	Peak

**ANTENNA POLARITY & TEST DISTANCE: VERTICAL AT 3 M**

FREQ. (MHz)	EMISSION LEVEL (dBuV/m)	READ LEVEL (dBuV)	LIMIT (dBuV/m)	MARGIN (dB)	ANTENNA FACTOR (dB/m)	CABLE LOSS (dB)	PREAMP FACTOR (dB)	ANTENNA HEIGHT (cm)	TABLE ANGLE (Degree)	REMARK
31.02	35.66	54.07	40	-4.34	12.14	0.57	31.12	100	253	Peak
57	28.97	47.26	40	-11.03	12.25	0.81	31.35	100	76	Peak
139.62	22.75	40.76	43.5	-20.75	12.34	1.29	31.64	100	59	Peak
668.9	23.78	31.85	46	-22.22	20.44	3.31	31.82	100	140	Peak
799.8	26.42	31.93	46	-19.58	22.23	3.69	31.43	100	338	Peak
916	27.47	31.89	46	-18.53	23.6	4	32.02	100	203	Peak

**REMARKS:** Emission Level = Read Level + Antenna Factor + Cable Loss - Preamp Factor  
 Margin value = Emission level – Limit value

## 4.2 CONDUCTED EMISSION MEASUREMENT

### 4.2.1 LIMITS OF CONDUCTED EMISSION MEASUREMENT

FREQUENCY OF EMISSION (MHz)	CONDUCTED LIMIT (dB $\mu$ V)	
	Quasi-peak	Average
0.15 ~ 0.5	66 to 56	56 to 46
0.5 ~ 5	56	46
5 ~ 30	60	50

**NOTE:**

1. The lower limit shall apply at the transition frequencies.
2. The limit decreases in line with the logarithm of the frequency in the range of 0.15 to 0.50MHz.
3. All emanations from a class A/B digital device or system, including any network of conductors and apparatus connected thereto, shall not exceed the level of field strengths specified above.

### 4.2.2 TEST INSTRUMENTS

DESCRIPTION & MANUFACTURER	MODEL NO.	SERIAL NO.	DATE OF CALIBRATION	DUE DATE OF CALIBRATION
Test Receiver ROHDE & SCHWARZ	ESCS30	100288	Nov. 17, 2013	Nov. 16, 2014
RF signal cable Woken	5D-FB	Cable-HYCO2-01	Dec. 27, 2013	Dec. 26, 2014
LISN ROHDE & SCHWARZ (EUT)	ESH2-Z5	100100	Dec. 23, 2013	Dec. 22, 2014
LISN ROHDE & SCHWARZ (Peripheral)	ESH3-Z5	100312	Jul. 08, 2013	Jul. 07, 2014
Software ADT	BV ADT_Cond_ V7.3.7.3	NA	NA	NA

- NOTE:**
1. The calibration interval of the above test instruments is 12 months and the calibrations are traceable to NML/ROC and NIST/USA.
  2. The test was performed in HwaYa Shielded Room 2.
  3. The VCCI Site Registration No. is C-2047.

### 4.2.3 TEST PROCEDURES

- a. The EUT was placed 0.4 meters from the conducting wall of the shielded room with EUT being connected to the power mains through a line impedance stabilization network (LISN). Other support units were connected to the power mains through another LISN. The two LISNs provide 50 ohm/ 50uH of coupling impedance for the measuring instrument.
- b. Both lines of the power mains connected to the EUT were checked for maximum conducted interference.
- c. The frequency range from 150kHz to 30MHz was searched. Emission levels under (Limit - 20dB) was not recorded.

**NOTE:** All modes of operation were investigated and the worst-case emissions are reported.

### 4.2.4 DEVIATION FROM TEST STANDARD

No deviation.

#### 4.2.5 TEST SETUP

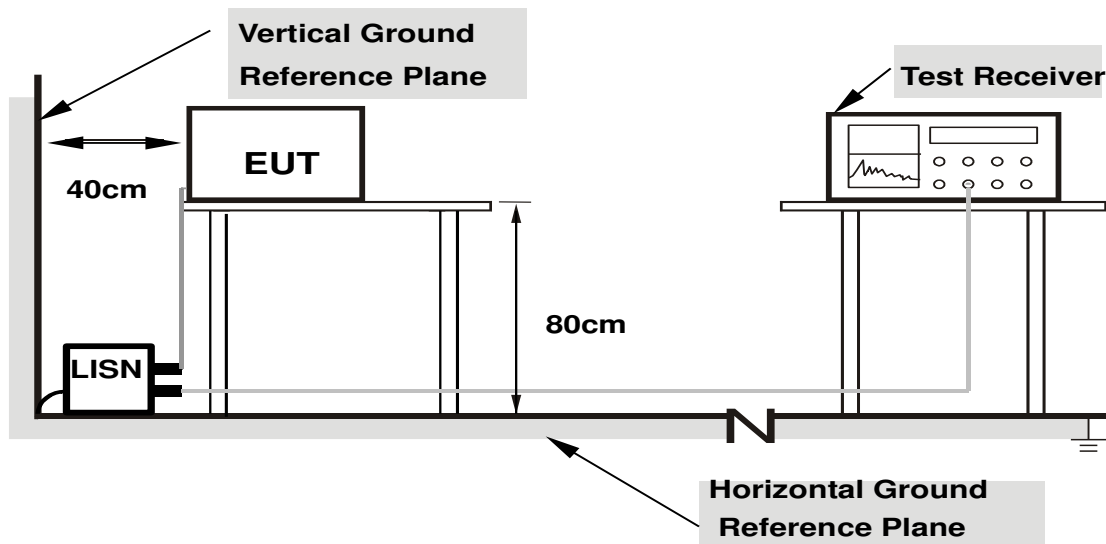

- Note:**
1. Support units were connected to second LISN.
  2. Both of LISNs (AMN) are 80 cm from EUT and at least 80 from other units and other metal planes

For the actual test configuration, please refer to the attached file (Test Setup Photo).

#### 4.2.6 EUT OPERATING CONDITIONS

Same as 4.1.6.

### 4.2.7 TEST RESULTS

#### CONDUCTED WORST-CASE DATA :

#### MODE A

<b>PHASE</b>	Line 1	<b>6dB BANDWIDTH</b>	9kHz
--------------	--------	----------------------	------

No	Freq.	Corr. Factor	Reading Value		Emission Level		Limit		Margin	
	[MHz]		[dB (uV)]		[dB (uV)]		[dB (uV)]		(dB)	
			Q.P.	AV.	Q.P.	AV.	Q.P.	AV.	Q.P.	AV.
1	0.20469	0.28	36.00	10.35	36.28	10.63	63.42	53.42	-27.14	-42.79
2	0.50938	0.31	43.57	31.44	43.88	31.75	56.00	46.00	-12.12	-14.25
3	1.27344	0.35	39.69	25.43	40.04	25.78	56.00	46.00	-15.96	-20.22
4	1.74219	0.35	35.97	28.08	36.32	28.43	56.00	46.00	-19.68	-17.57
5	13.56250	0.52	53.40	46.45	53.92	46.97	60.00	50.00	-6.08	-3.03
6	21.29688	0.58	30.96	16.93	31.54	17.51	60.00	50.00	-28.46	-32.49

#### REMARKS:

1. Q.P. and AV. are abbreviations of quasi-peak and average individually.
2. The emission levels of other frequencies were very low against the limit.
3. Margin value = Emission level - Limit value
4. Correction factor = Insertion loss + Cable loss
5. Emission Level = Correction Factor + Reading Value

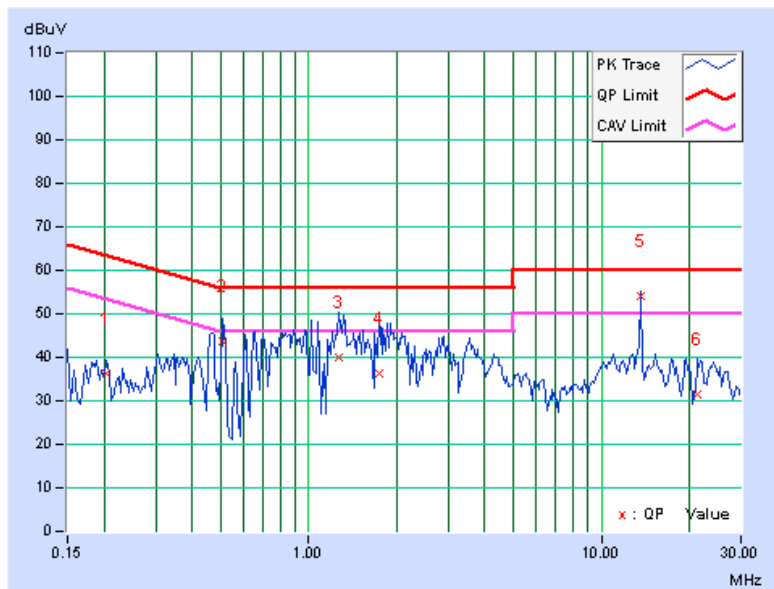





A D T

PHASE	Line 2	6dB BANDWIDTH	9kHz
-------	--------	---------------	------

No	Freq. [MHz]	Corr. Factor (dB)	Reading Value [dB (uV)]		Emission Level [dB (uV)]		Limit [dB (uV)]		Margin (dB)	
			Q.P.	AV.	Q.P.	AV.	Q.P.	AV.	Q.P.	AV.
			1	0.16953	0.27	34.95	16.06	35.22	16.33	64.98
2	0.30625	0.29	31.64	15.99	31.93	16.28	60.07	50.07	-28.14	-33.79
3	0.50000	0.31	21.26	9.03	21.57	9.34	56.00	46.00	-34.43	-36.66
4	2.26172	0.38	31.68	17.63	32.06	18.01	56.00	46.00	-23.94	-27.99
5	13.55859	0.55	43.68	41.81	44.23	42.36	60.00	50.00	-15.77	-7.64
6	23.48047	0.59	26.49	18.34	27.08	18.93	60.00	50.00	-32.92	-31.07

**REMARKS:**

1. Q.P. and AV. are abbreviations of quasi-peak and average individually.
2. The emission levels of other frequencies were very low against the limit.
3. Margin value = Emission level - Limit value
4. Correction factor = Insertion loss + Cable loss
5. Emission Level = Correction Factor + Reading Value

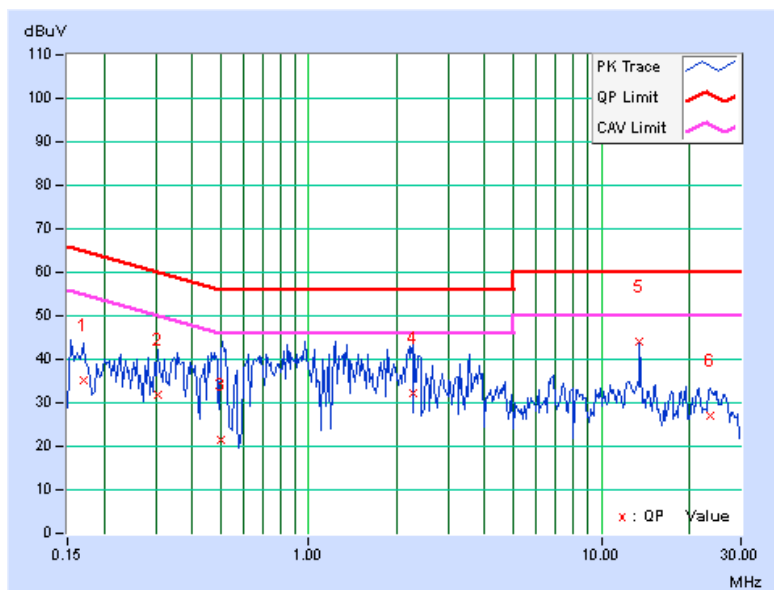

**MODE B**

<b>PHASE</b>	Line 1	<b>6dB BANDWIDTH</b>	9kHz
--------------	--------	----------------------	------

No	Freq. [MHz]	Corr. Factor (dB)	Reading Value [dB (uV)]		Emission Level [dB (uV)]		Limit [dB (uV)]		Margin (dB)	
			Q.P.	AV.	Q.P.	AV.	Q.P.	AV.	Q.P.	AV.
1	0.19687	0.28	37.05	23.85	37.33	24.13	63.74	53.74	-26.41	-29.61
2	0.51328	0.31	35.57	19.40	35.88	19.71	56.00	46.00	-20.12	-26.29
3	0.89219	0.33	38.47	28.22	38.80	28.55	56.00	46.00	-17.20	-17.45
4	2.08203	0.36	35.74	22.93	36.10	23.29	56.00	46.00	-19.90	-22.71
5	10.30078	0.50	35.99	26.98	36.49	27.48	60.00	50.00	-23.51	-22.52
6	13.56250	0.52	47.63	42.88	48.15	43.40	60.00	50.00	-11.85	-6.60

**REMARKS:**

1. Q.P. and AV. are abbreviations of quasi-peak and average individually.
2. The emission levels of other frequencies were very low against the limit.
3. Margin value = Emission level - Limit value
4. Correction factor = Insertion loss + Cable loss
5. Emission Level = Correction Factor + Reading Value

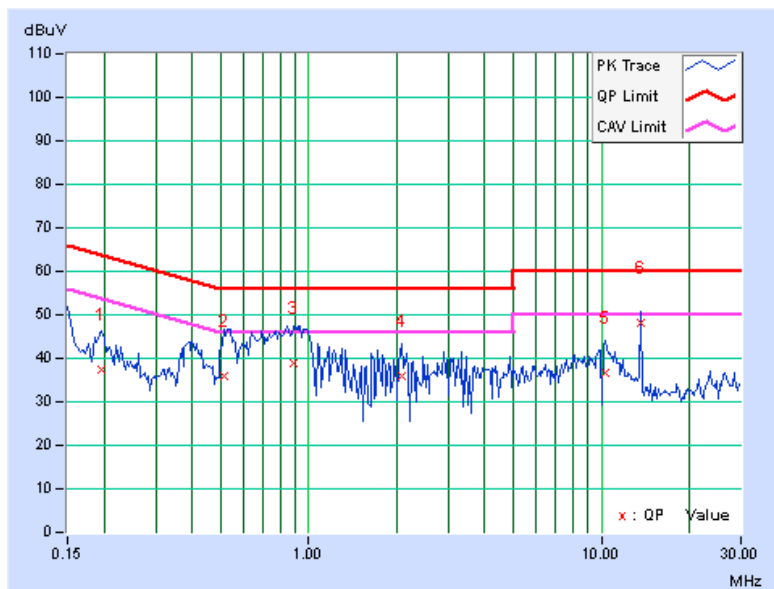



A D T

PHASE	Line 2	6dB BANDWIDTH	9kHz
-------	--------	---------------	------

No	Freq. [MHz]	Corr. Factor (dB)	Reading Value [dB (uV)]		Emission Level [dB (uV)]		Limit [dB (uV)]		Margin (dB)	
			Q.P.	AV.	Q.P.	AV.	Q.P.	AV.	Q.P.	AV.
			1	0.18125	0.27	30.89	18.14	31.16	18.41	64.43
2	0.44688	0.30	40.78	33.07	41.08	33.37	56.93	46.93	-15.85	-13.56
3	0.54844	0.31	38.21	28.50	38.52	28.81	56.00	46.00	-17.48	-17.19
4	0.95469	0.34	36.55	27.55	36.89	27.89	56.00	46.00	-19.11	-18.11
5	10.55469	0.52	33.04	24.81	33.56	25.33	60.00	50.00	-26.44	-24.67
6	13.56250	0.55	46.19	41.39	46.74	41.94	60.00	50.00	-13.26	-8.06

**REMARKS:**

1. Q.P. and AV. are abbreviations of quasi-peak and average individually.
2. The emission levels of other frequencies were very low against the limit.
3. Margin value = Emission level - Limit value
4. Correction factor = Insertion loss + Cable loss
5. Emission Level = Correction Factor + Reading Value

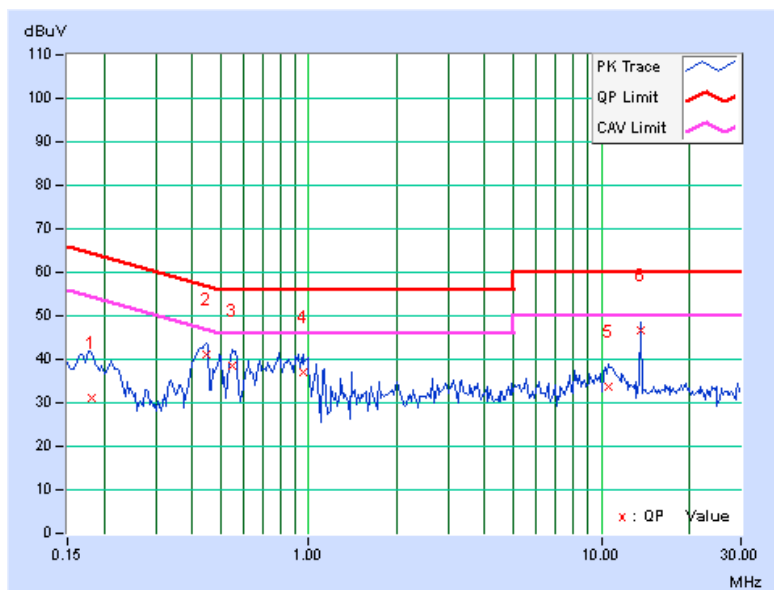

### 4.3 PEAK TRANSMIT POWER MEASUREMENT

#### 4.3.1 LIMITS OF PEAK TRANSMIT POWER MEASUREMENT

FREQUENCY BAND	LIMIT
5.150 ~ 5.250GHz	The lesser of 50mW (17dBm) or 4dBm + 10logB
5.250 ~ 5.350GHz	The lesser of 250mW (24dBm) or 11dBm + 10logB
5.470 ~ 5.725GHz	The lesser of 250mW (24dBm) or 11dBm + 10logB

**NOTE:** Where B is the 26dB emission bandwidth in MHz.

#### 4.3.2 TEST SETUP

##### FOR POWER OUTPUT MEASUREMENT

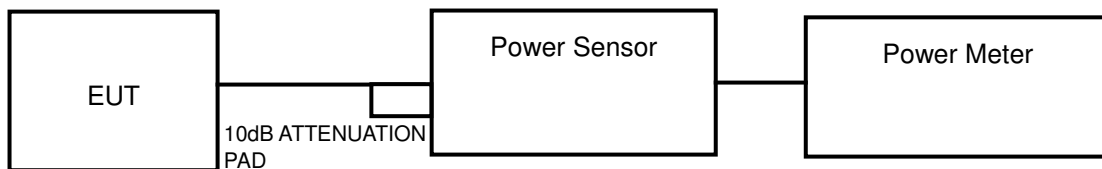

##### FOR 26dB BANDWIDTH

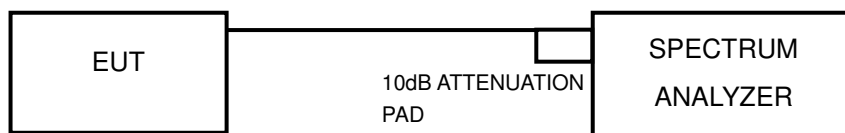

#### 4.3.3 TEST INSTRUMENTS

Refer to section 4.1.3 to get information of above instrument.



A D T

#### **4.3.4 TEST PROCEDURE**

##### **FOR AVERAGE POWER MEASUREMENT**

<802.11a, 802.11n (20MHz), 802.11n (40MHz)>

Method PM is used to perform output power measurement, trigger and gating function of wide band power meter is enabled to measure max output power of TX on burst. Duty factor is not added to measured value.

##### **FOR 26dB BANDWIDTH**

- 1) Set RBW = approximately 1% of the emission bandwidth.
- 2) Set the VBW > RBW.
- 3) Detector = Peak.
- 4) Trace mode = max hold.
- 5) Measure the maximum width of the emission that is 26 dB down from the peak of the emission. Compare this with the RBW setting of the analyzer. Readjust RBW and repeat measurement as needed until the RBW/EBW ratio is approximately 1%.

#### **4.3.5 DEVIATION FROM TEST STANDARD**

No deviation.

#### **4.3.6 EUT OPERATING CONDITIONS**

The software provided by client to enable the EUT under transmission condition continuously at specific channel frequencies individually.

### 4.3.7 TEST RESULTS

#### POWER OUTPUT

##### 802.11a

CHANNEL	CHANNEL FREQUENCY (MHz)	AVERAGE POWER (mW)	AVERAGE POWER (dBm)	POWER LIMIT (dBm)	PASS/FAIL
36	5180	40.93	16.12	17	PASS
44	5220	40.64	16.09	17	PASS
48	5240	42.76	16.31	17	PASS
52	5260	42.46	16.28	24	PASS
60	5300	40.36	16.06	24	PASS
64	5320	40.27	16.05	24	PASS
100	5500	44.36	16.47	24	PASS
116	5580	42.17	16.25	24	PASS
140	5700	41.88	16.22	24	PASS

##### 802.11n (20MHz)

CHANNEL	CHANNEL FREQUENCY (MHz)	AVERAGE POWER (mW)	AVERAGE POWER (dBm)	POWER LIMIT (dBm)	PASS/FAIL
36	5180	41.88	16.22	17	PASS
44	5220	40.74	16.10	17	PASS
48	5240	40.93	16.12	17	PASS
52	5260	40.83	16.11	24	PASS
60	5300	40.64	16.09	24	PASS
64	5320	40.55	16.08	24	PASS
100	5500	44.57	16.49	24	PASS
116	5580	40.64	16.09	24	PASS
140	5700	40.46	16.07	24	PASS



A D T

**802.11n (40MHz)**

CHANNEL	CHANNEL FREQUENCY (MHz)	AVERAGE POWER (mW)	AVERAGE POWER (dBm)	POWER LIMIT (dBm)	PASS/FAIL
38	5190	21.93	13.41	17	PASS
46	5230	21.33	13.29	17	PASS
54	5270	21.63	13.35	24	PASS
62	5310	21.73	13.37	24	PASS
102	5510	22.34	13.49	24	PASS
110	5550	21.28	13.28	24	PASS
134	5670	20.14	13.04	24	PASS



A D T

## 26dB BANDWIDTH

### 802.11a

CHANNEL	CHANNEL FREQUENCY (MHz)	26dBc BANDWIDTH (MHz)	PASS / FAIL
36	5180	22.84	PASS
44	5220	22.95	PASS
48	5240	23.20	PASS
52	5260	24.21	PASS
60	5300	23.35	PASS
64	5320	23.40	PASS
100	5500	22.32	PASS
116	5580	24.09	PASS
140	5700	22.72	PASS

### 802.11n (20MHz)

CHANNEL	CHANNEL FREQUENCY (MHz)	26dBc BANDWIDTH (MHz)	PASS / FAIL
36	5180	23.45	PASS
44	5220	24.00	PASS
48	5240	24.54	PASS
52	5260	24.48	PASS
60	5300	27.10	PASS
64	5320	23.80	PASS
100	5500	23.11	PASS
116	5580	23.09	PASS
140	5700	22.56	PASS

### 802.11n (40MHz)

CHANNEL	CHANNEL FREQUENCY (MHz)	26dBc BANDWIDTH (MHz)	PASS / FAIL
38	5190	46.43	PASS
46	5230	46.05	PASS
54	5270	46.49	PASS
62	5310	45.83	PASS
102	5510	46.23	PASS
110	5550	45.70	PASS
134	5670	46.30	PASS





A D T

### SPECTRUM PLOT OF WORST VALUE

#### 802.11a

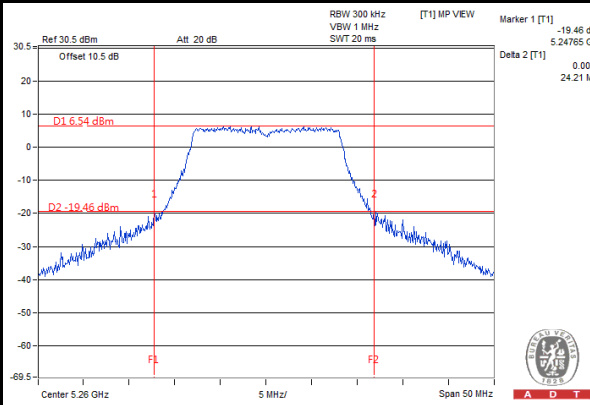

#### 802.11n (20MHz)

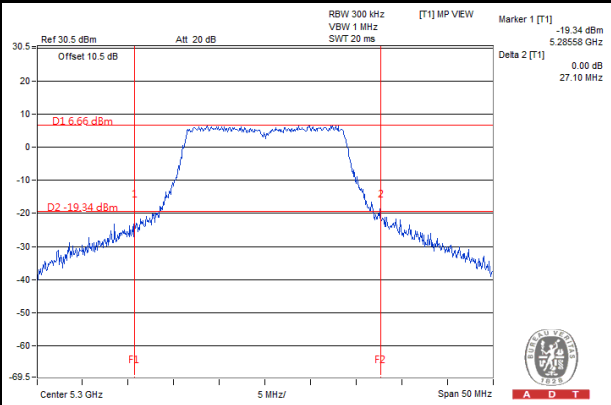

#### 802.11n (40MHz)

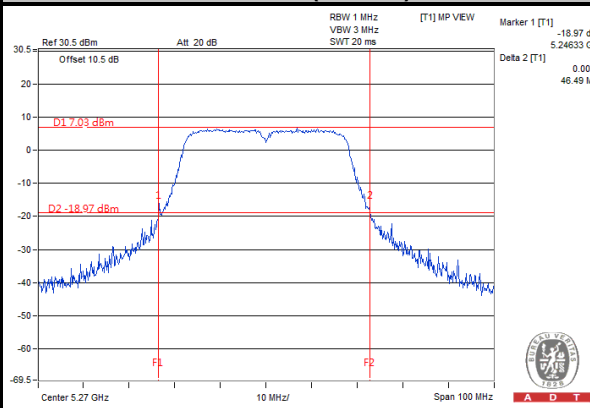

## 4.4 PEAK POWER SPECTRAL DENSITY MEASUREMENT

### 4.4.1 LIMITS OF PEAK POWER SPECTRAL DENSITY MEASUREMENT

FREQUENCY BAND	LIMIT
5.150 ~ 5.250GHz	4dBm
5.250 ~ 5.350GHz	11dBm
5.470 ~ 5.725GHz	11dBm

### 4.4.2 TEST SETUP

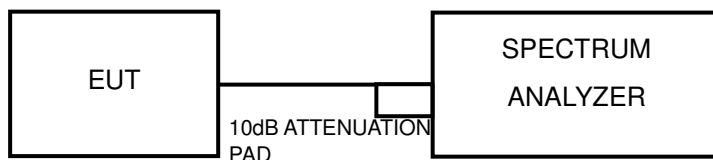

### 4.4.3 TEST INSTRUMENTS

Refer to section 4.1.3 to get information of above instrument.

### 4.4.4 TEST PROCEDURES

<802.11a, 802.11n (20MHz)>

Using method SA-2 alternative

- 1) Set span to encompass the entire emission bandwidth (EBW) of the signal.
- 2) Set RBW = 1 MHz, Set VBW  $\geq$  3 MHz, Detector = RMS
- 3) Sweep time = 4second.
- 4) Perform a single sweep.

<802.11n (40MHz)>

Using method SA-2 alternative

- 1) Set span to encompass the entire emission bandwidth (EBW) of the signal.
- 2) Set RBW = 1 MHz, Set VBW  $\geq$  3 MHz, Detector = RMS
- 3) Sweep time = 4second.
- 4) Perform a single sweep.
- 5) Record the max value and add 10 log (1/duty cycle)

### 4.4.5 DEVIATION FROM TEST STANDARD

No deviation.

### 4.4.6 EUT OPERATING CONDITIONS

Same as Item 4.3.6.



#### 4.4.7 TEST RESULTS

##### 802.11a

CHANNEL	FREQUENCY (MHz)	PSD (dBm)	MAXIMUM LIMIT (dBm)	PASS/FAIL
36	5180	2.77	4	PASS
44	5220	3.01	4	PASS
48	5240	3.30	4	PASS
52	5260	3.12	11	PASS
60	5300	3.49	11	PASS
64	5320	3.55	11	PASS
100	5500	4.06	11	PASS
116	5580	4.09	11	PASS
140	5700	3.20	11	PASS

##### 802.11n (20MHz)

CHANNEL	FREQUENCY (MHz)	PSD (dBm)	MAXIMUM LIMIT (dBm)	PASS/FAIL
36	5180	2.50	4	PASS
44	5220	2.73	4	PASS
48	5240	3.09	4	PASS
52	5260	3.10	11	PASS
60	5300	3.43	11	PASS
64	5320	3.34	11	PASS
100	5500	3.95	11	PASS
116	5580	3.49	11	PASS
140	5700	2.81	11	PASS



A D T

### 802.11n (40MHz)

CHANNEL	FREQUENCY (MHz)	PSD W/O DUTY FACTOR (dBm)	DUTY FACTOR	PSD WITH DUTY FACTOR (dBm)	MAXIMUM LIMIT (dBm)	PASS/FAIL
38	5190	-2.63	0.34	-2.29	4	PASS
46	5230	-2.90	0.34	-2.56	4	PASS
54	5270	-2.35	0.34	-2.01	11	PASS
62	5310	-1.67	0.34	-1.33	11	PASS
102	5510	-2.11	0.34	-1.77	11	PASS
110	5550	-2.44	0.34	-2.10	11	PASS
134	5670	-2.87	0.34	-2.53	11	PASS

**NOTE:** Refer to section 3.3 for duty cycle spectrum plot.



A D T

### SPECTRUM PLOT OF WORST VALUE

#### 802.11a

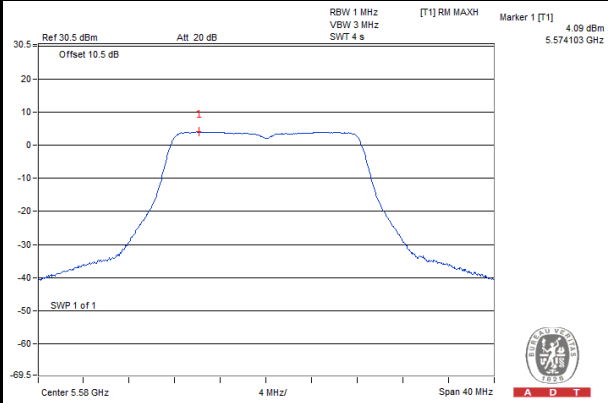

#### 802.11n (20MHz)

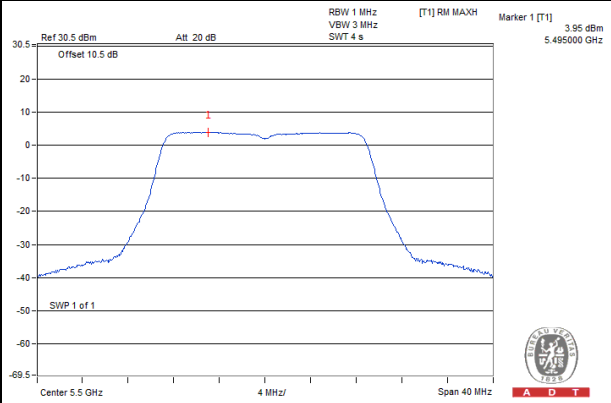

#### 802.11n (40MHz)

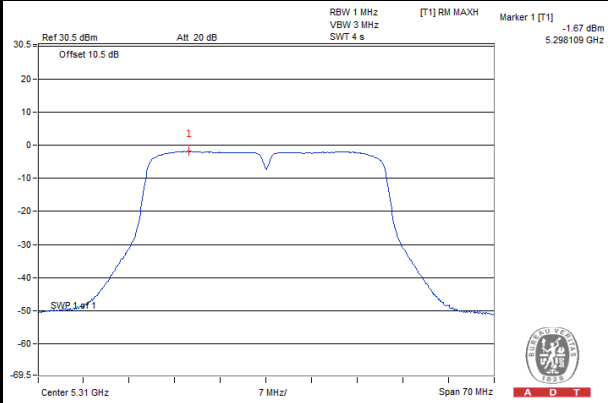

## 4.5 PEAK POWER EXCURSION MEASUREMENT

### 4.5.1 LIMITS OF POWER SPECTRAL DENSITY MEASUREMENT

Shall not exceed 13 dB.

### 4.5.2 TEST SETUP

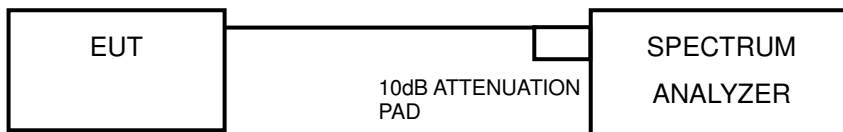

### 4.5.3 TEST INSTRUMENTS

Refer to section 4.1.3 to get information of above instrument.

### 4.5.4 TEST PROCEDURE

- Set the RBW = 1 kHz, VBW  $\geq$  3 MHz, Detector = peak.
- Trace mode = max-hold. Allow the sweeps to continue until the trace stabilizes.
- Use the peak search function to find the peak of the spectrum.
- Measure the PPSD.
- Compute the ratio of the maximum of the peak-max-hold spectrum to the PPSD.  
Find the worst channel and modulation mode as above test procedure, and follow KDB 789033 D01 General UNII Test Procedures v01r03 and repeat step 1 to 5 for final testing of each modulation mode on a single channel (all modulation types) in a single operating band to compliance with the peak excursion requirement.

### 4.5.5 DEVIATION FROM TEST STANDARD

No deviation.

### 4.5.6 EUT OPERATING CONDITION

Same as Item 4.3.6.



A D T

### 4.5.7 TEST RESULTS

MODULATION MODE	MODULATION TYPE	CHAN. FREQ. (MHz)	PEAK VALUE (dBm)	PPSD WITHOUT DUTY FACTOR (dBm)	PPSD WITH DUTY FACTOR (dBm)	PEAK EXCURSION (dB)	LIMIT (dB)	PASS/FAIL
802.11a	BPSK	5500	13.27	4.06	4.06	9.21	13	PASS
	QPSK		13.35	4.02	3.92	9.33	13	PASS
	16QAM		14.24	3.97	3.87	10.27	13	PASS
	64QAM		14.32	4.29	3.92	10.03	13	PASS
802.11n (20MHz)	BPSK	5500	13.44	3.95	3.95	9.49	13	PASS
	QPSK		14.07	4.11	4.00	9.96	13	PASS
	16QAM		14.19	4.13	3.93	10.06	13	PASS
	64QAM		14.34	4.31	3.95	10.03	13	PASS
802.11n (40MHz)	BPSK	5510	7.70	-1.77	-2.11	9.47	13	PASS
	QPSK		8.32	-1.61	-2.15	9.93	13	PASS
	16QAM		7.74	-1.11	-2.17	8.85	13	PASS
	64QAM		7.97	-0.25	-2.12	8.22	13	PASS

**NOTE:** Refer to section 3.3 for duty cycle spectrum plot.

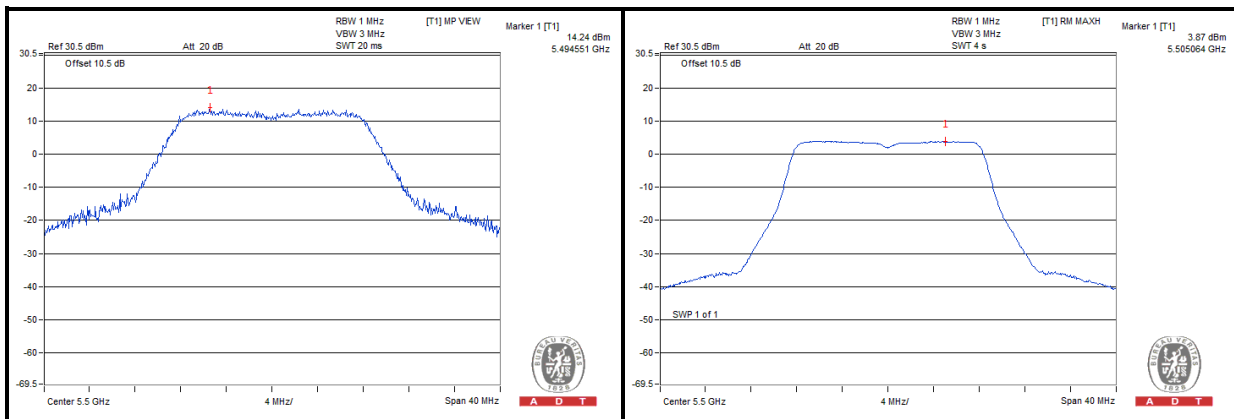

## 4.6 FREQUENCY STABILITY

### 4.6.1 LIMITS OF FREQUENCY STABILITY MEASUREMENT

The frequency of the carrier signal shall be maintained within band of operation.

### 4.6.2 TEST SETUP

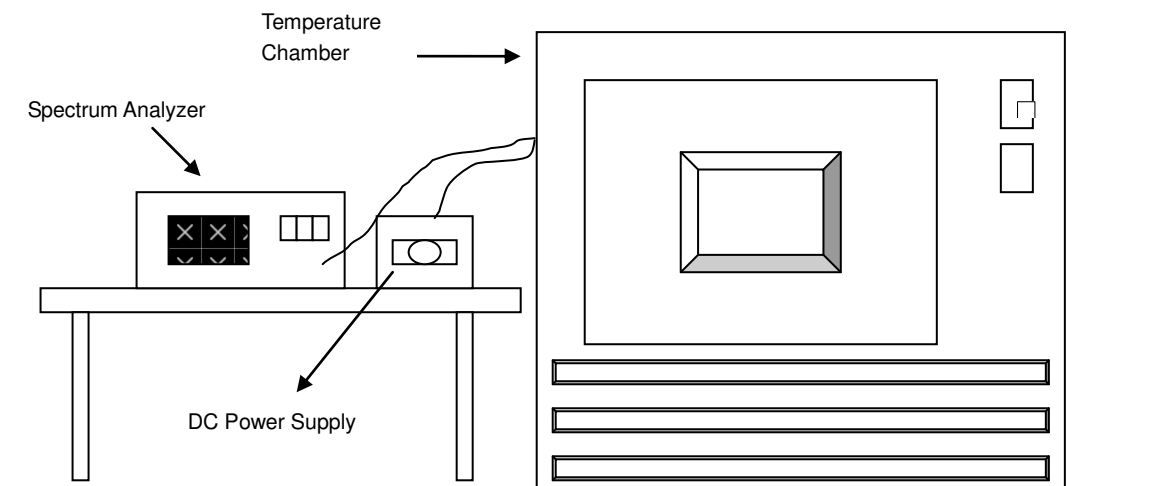

### 4.6.3 TEST INSTRUMENTS

Refer to section 4.1.3 to get information of above instrument.



#### **4.6.4 TEST PROCEDURE**

- a. To ensure emission at the band edge is maintained within the authorized band, those values shall be measured by radiation emissions at upper and lower frequency points, and finally compensated by frequency deviation as procedures below.
- b. The EUT was operated at the maximum output power, and connected to the spectrum analyzer, which is set to maximum hold function and peak detector. The peak value of the power envelope was measured and noted. The upper and lower frequency points were respectively measured relatively 10dB lower than the measured peak value.
- c. The frequency deviation was calculated by adding the upper frequency point and the lower frequency point divided by two. Those detailed values of frequency deviation are provided in table below.

#### **4.6.5 DEVIATION FROM TEST STANDARD**

No deviation.

#### **4.6.6 EUT OPERATING CONDITION**

Set the EUT transmit at un-modulation mode to test frequency stability.



A D T

### 4.6.7 TEST RESULTS

FREQUENCY STABILITY VERSUS TEMP.									
OPERATING FREQUENCY: 5320MHz									
TEMP. (°C)	POWER SUPPLY (Vdc)	0 MINUTE		2 MINUTE		5 MINUTE		10 MINUTE	
		Measured Frequency (MHz)	Frequency Drift (ppm)	Measured Frequency (MHz)	Frequency Drift (ppm)	Measured Frequency (MHz)	Frequency Drift (ppm)	Measured Frequency (MHz)	Frequency Drift (ppm)
60	3.8	5320.037477	7.045	5320.036971	6.949	5320.037069	6.968	5320.037021	6.959
50	3.8	5320.037547	7.058	5320.038188	7.178	5320.037892	7.123	5320.038192	7.179
40	3.8	5320.037903	7.125	5320.037887	7.122	5320.038045	7.151	5320.038424	7.223
30	3.8	5320.039490	7.423	5320.039558	7.436	5320.038839	7.301	5320.038920	7.316
20	3.8	5320.040285	7.572	5320.039991	7.517	5320.040277	7.571	5320.039825	7.486
10	3.8	5320.041510	7.803	5320.041365	7.775	5320.041650	7.829	5320.041535	7.807
0	3.8	5320.040112	7.540	5320.040244	7.565	5320.039820	7.485	5320.040364	7.587
-10	3.8	5320.038663	7.267	5320.038622	7.260	5320.038615	7.258	5320.038793	7.292
-20	3.8	5320.037942	7.132	5320.038294	7.198	5320.038191	7.179	5320.037965	7.136
-30	3.8	5320.037255	7.003	5320.037297	7.011	5320.037127	6.979	5320.036994	6.954

FREQUENCY STABILITY VERSUS VOLTAGE									
OPERATING FREQUENCY: 5320MHz									
TEMP. (°C)	POWER SUPPLY (Vdc)	0 MINUTE		2 MINUTE		5 MINUTE		10 MINUTE	
		Measured Frequency (MHz)	Frequency Drift (ppm)	Measured Frequency (MHz)	Frequency Drift (ppm)	Measured Frequency (MHz)	Frequency Drift (ppm)	Measured Frequency (MHz)	Frequency Drift (ppm)
20	3.6	5320.039867	7.494	5320.039780	7.477	5320.039701	7.463	5320.039592	7.442
	3.8	5320.040285	7.572	5320.039991	7.517	5320.040277	7.571	5320.039825	7.486
	4.35	5320.041450	7.791	5320.041432	7.788	5320.041403	7.783	5320.041236	7.751

## 4.7 20dBc BANDWIDTH MEASUREMENT

### 4.7.1 LIMITS OF 20dBc BANDWIDTH MEASUREMENT

20dBc point shall not overlap in 5150~5700MHz.

### 4.7.2 TEST SETUP

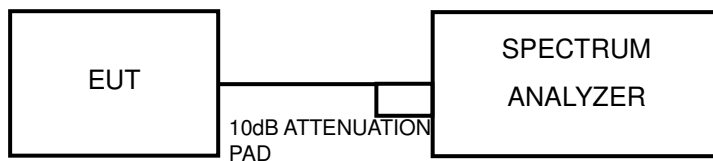

### 4.7.3 TEST INSTRUMENTS

Refer to section 4.1.3 to get information of above instrument.

### 4.7.4 TEST PROCEDURES

789033 D01 General UNII Test Procedures v01r03

#### Emission bandwidth

- 1) Set RBW = approximately 1% of the emission bandwidth.
- 2) Set the VBW > RBW.
- 3) Detector = Peak
- 4) Trace mode = max hold.
- 5) Measurement the maximum width of the emission that is 20dB down from the peak of the emission. Compare this with RBW setting of the analyzer. Readjust RBW and repeat measurement as needed until the RBW/EBW ratio is approximately 1%.



A D T

### 4.7.5 TEST RESULTS

#### 802.11a

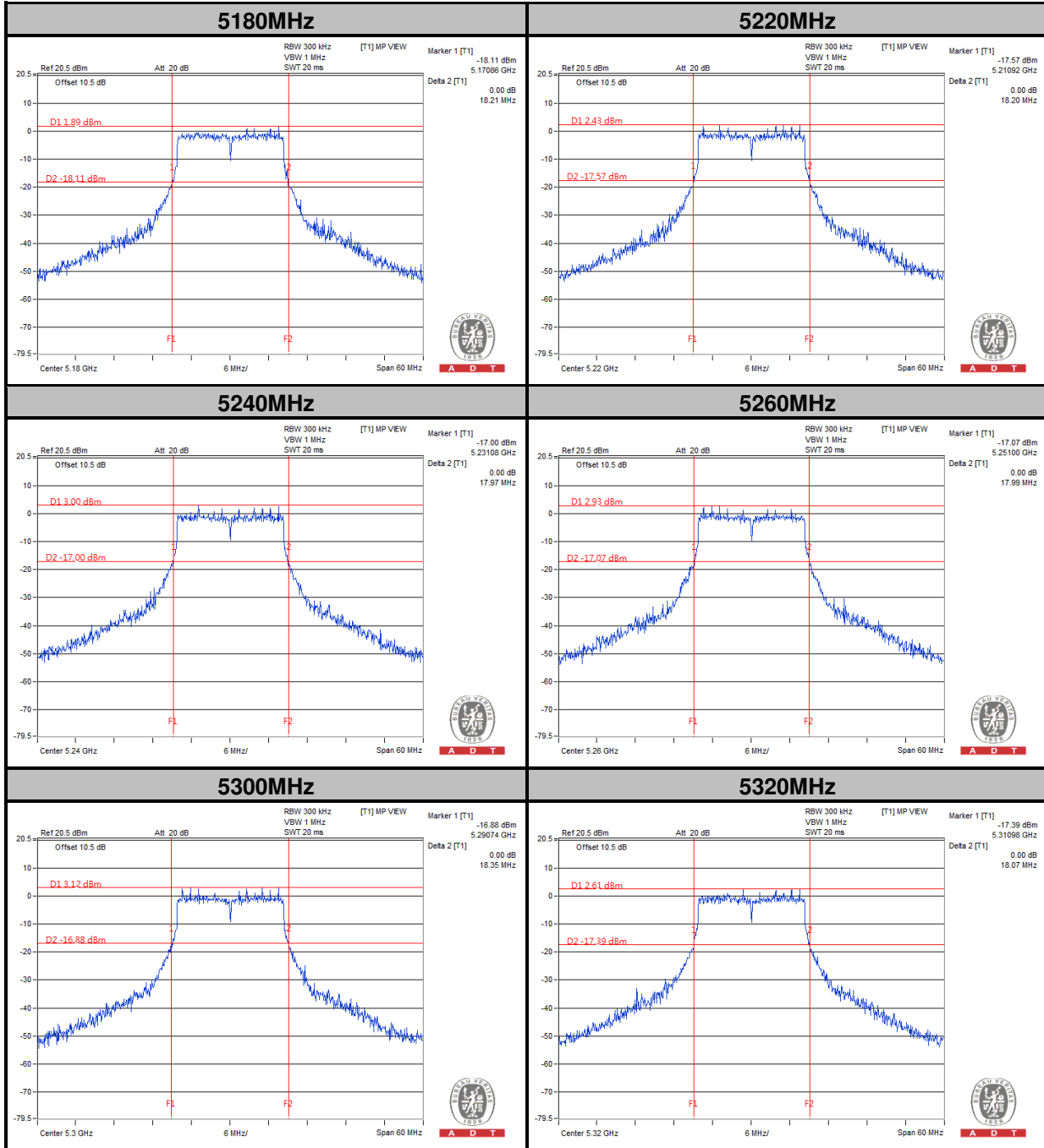



A D T

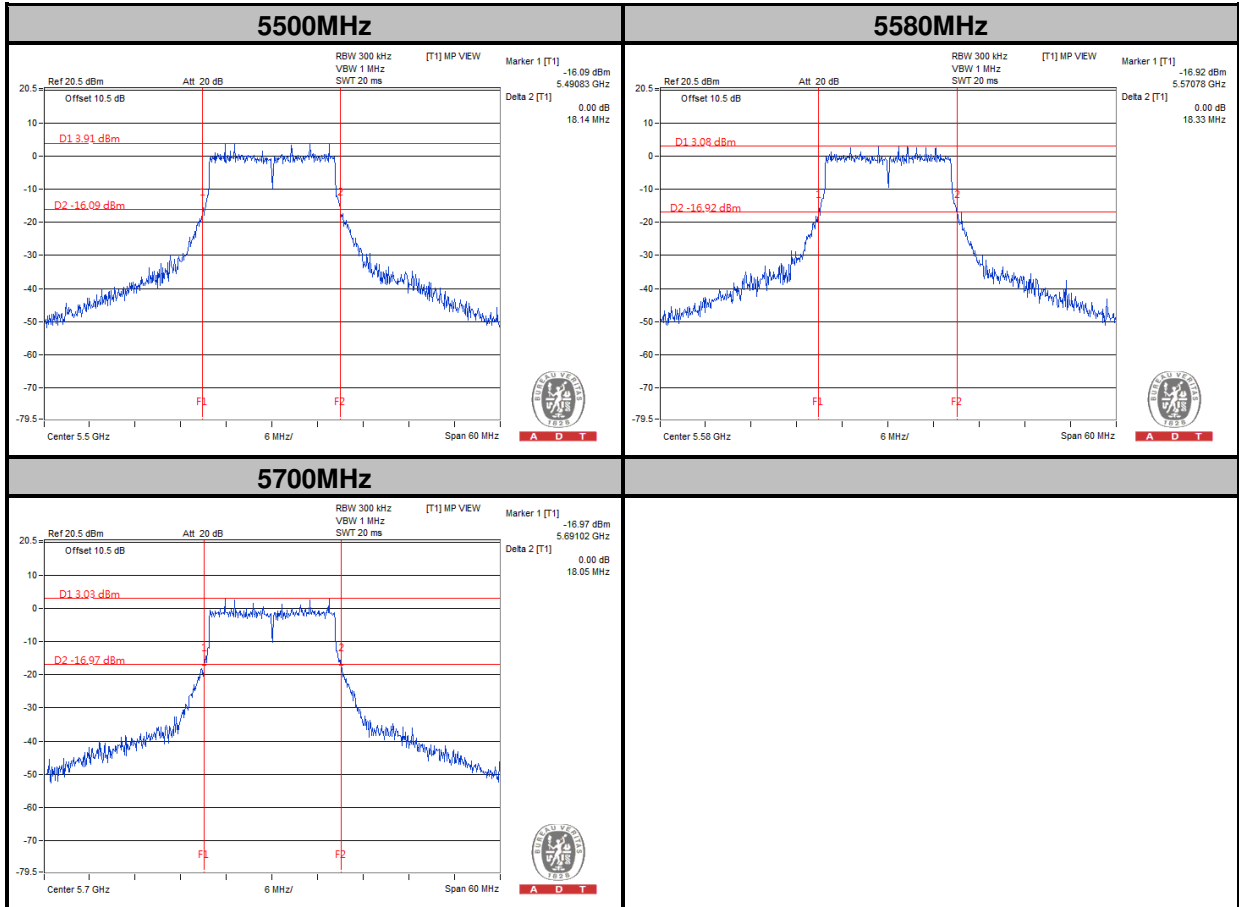



A D T

### 802.11n (20MHz)

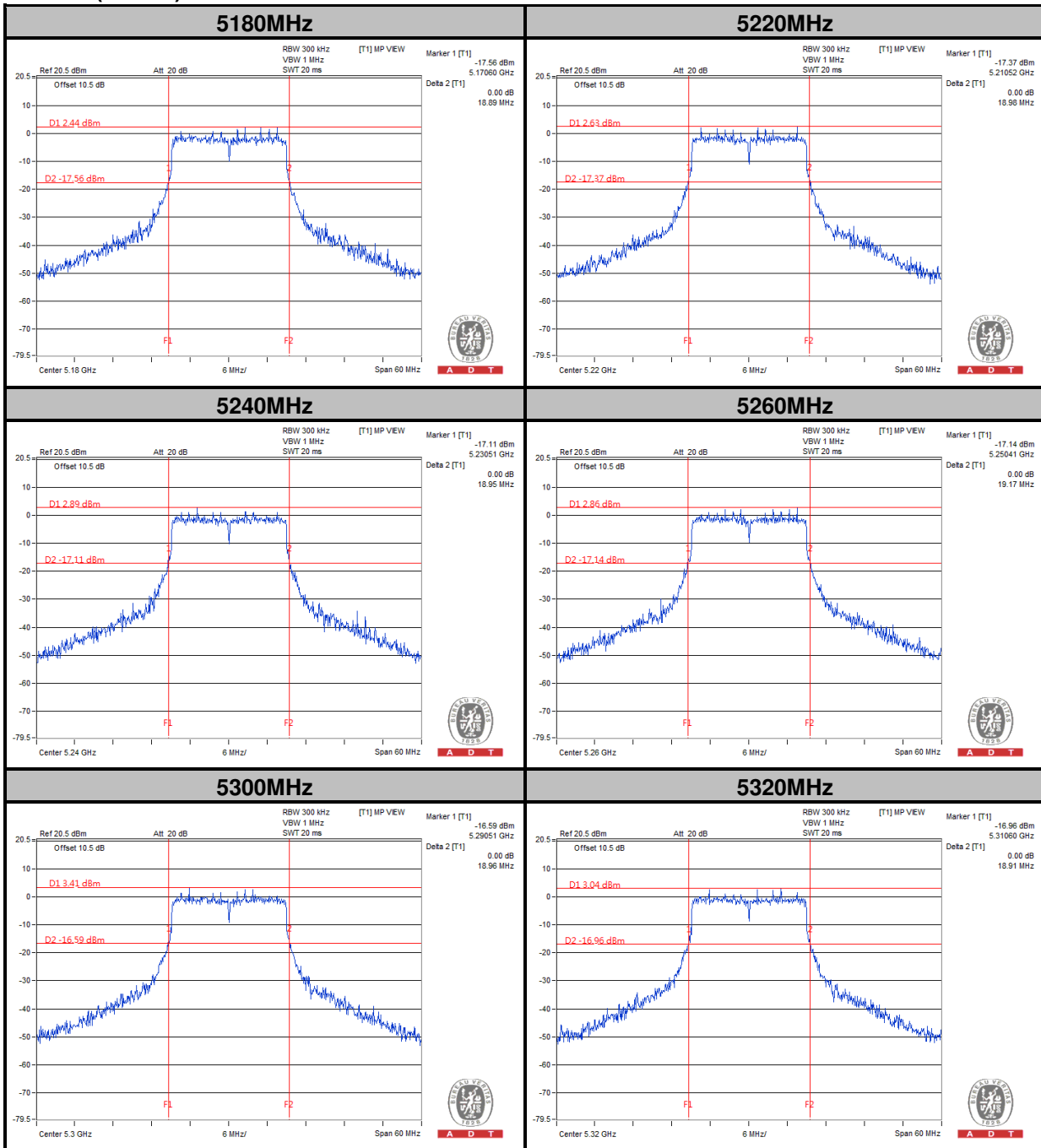



A D T

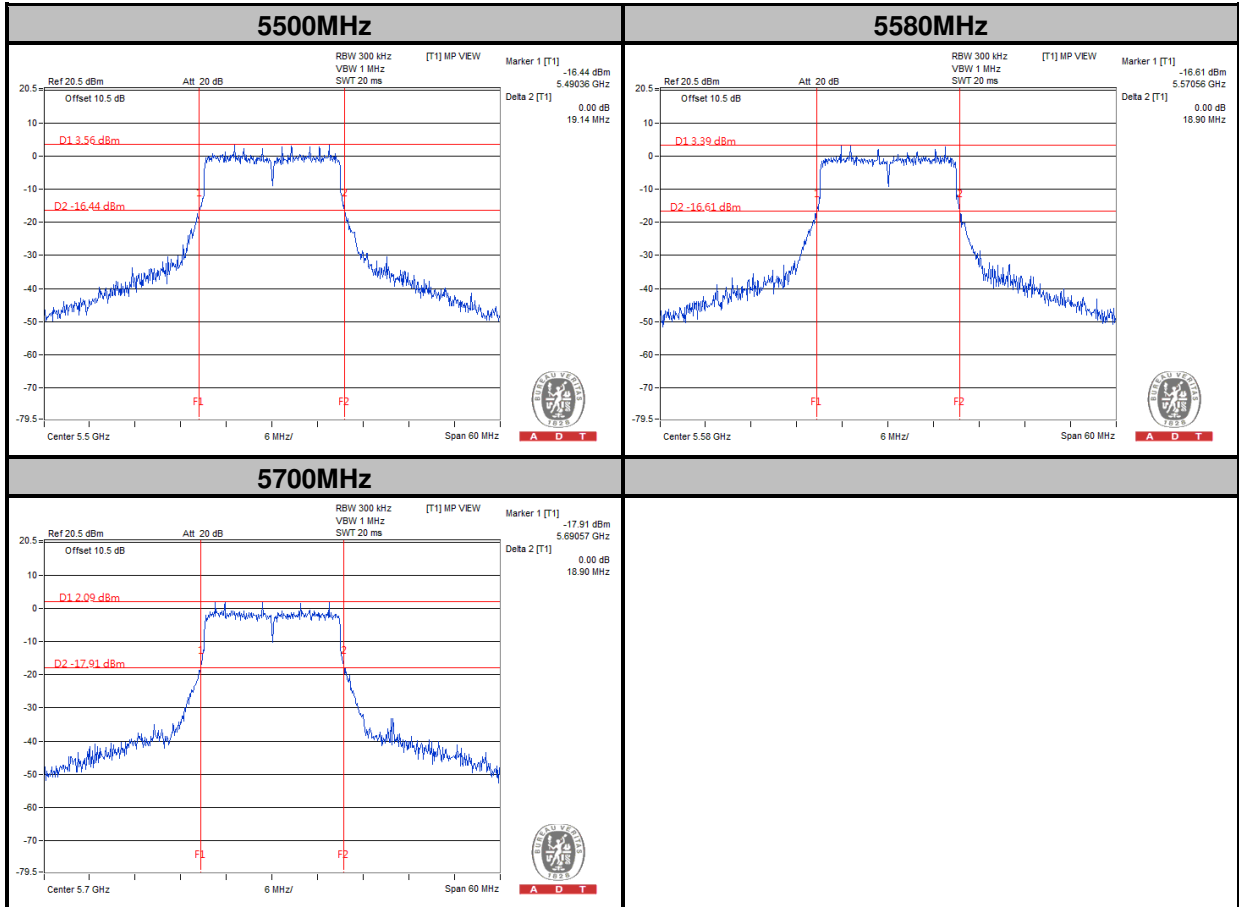



A D T

### 802.11n (40MHz)

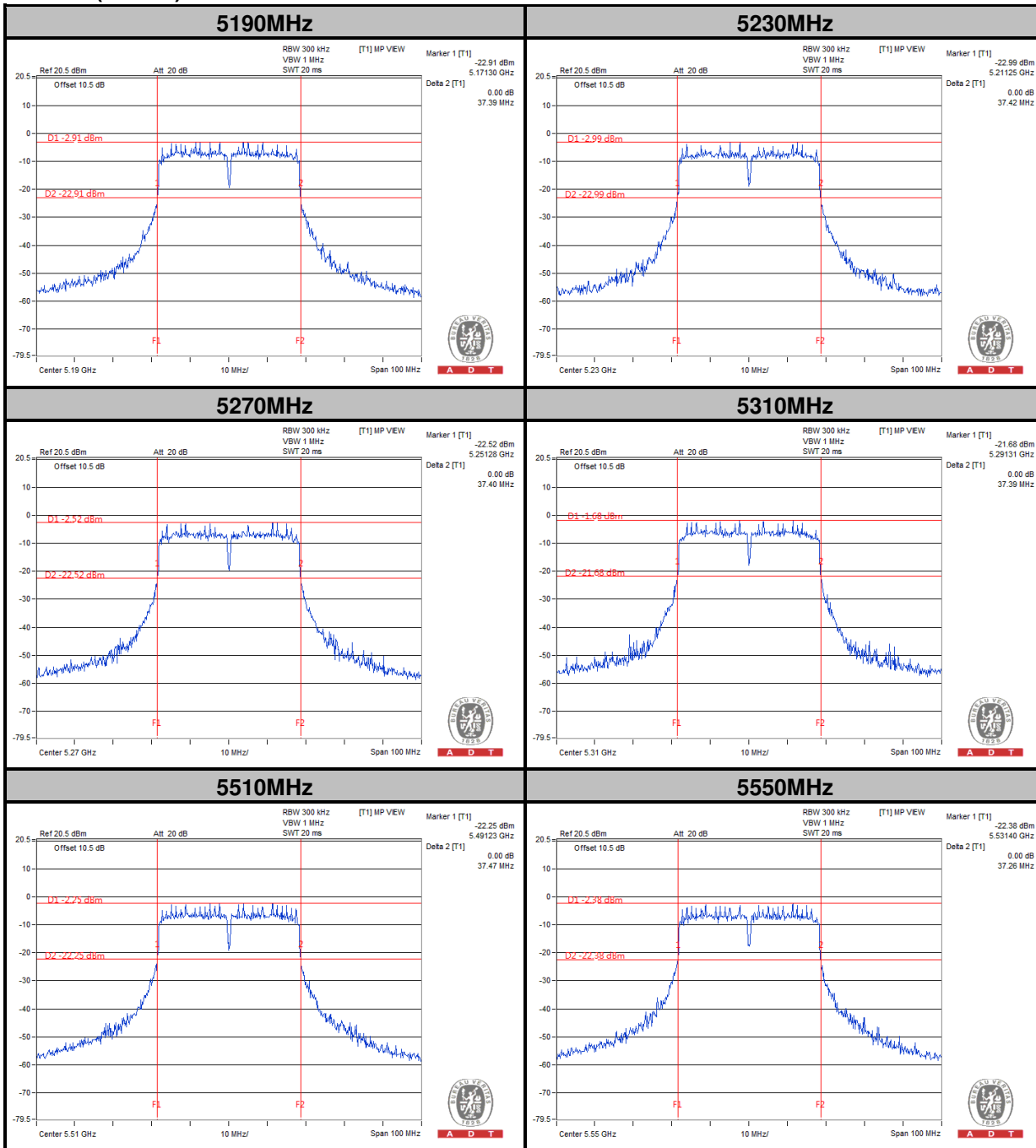





A D T

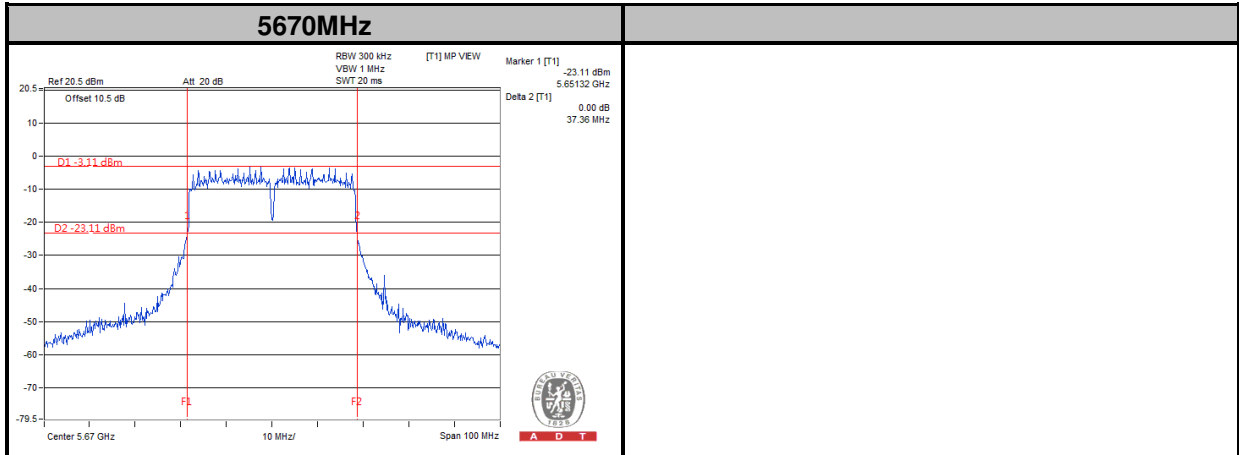



A D T

## 5. PHOTOGRAPHS OF THE TEST CONFIGURATION

Please refer to the attached file (Test Setup Photo).



## 6. INFORMATION ON THE TESTING LABORATORIES

We, Bureau Veritas Consumer Products Services (H.K.) Ltd., Taoyuan Branch, were founded in 1988 to provide our best service in EMC, Radio, Telecom and Safety consultation. Our laboratories are accredited and approved according to ISO/IEC 17025.

If you have any comments, please feel free to contact us at the following:

**Linko EMC/RF Lab:**

Tel: 886-2-26052180

Fax: 886-2-26051924

**Hsin Chu EMC/RF Lab:**

Tel: 886-3-5935343

Fax: 886-3-5935342

**Hwa Ya EMC/RF/Safety Telecom Lab:**

Tel: 886-3-3183232

Fax: 886-3-3270892

**Email:** [service.adt@tw.bureauveritas.com](mailto:service.adt@tw.bureauveritas.com)

**Web Site:** [www.bureauveritas-adt.com](http://www.bureauveritas-adt.com)

The address and road map of all our labs can be found in our web site also.



A D T

## 7. APPENDIX A - MODIFICATIONS RECORDERS FOR ENGINEERING CHANGES TO THE EUT BY THE LAB

No any modifications are made to the EUT by the lab during the test.

---END---