



FCC RF Test Report

Applicant : HTC Corporation
EQUIPMENT : Smartphone
MODEL NAME : 0P90300
FCC ID : NM80P90300
STANDARD : FCC 47 CFR Part 2, 22(H), 24(E)
CLASSIFICATION : PCS Licensed Transmitter Held to Ear (PCE)

The product was received on Jun. 05, 2014 and testing was completed on Jul. 12, 2014. We, SPORTON INTERNATIONAL INC., would like to declare that the tested sample has been evaluated in accordance with the test procedures given in ANSI / TIA / EIA-603-C-2004 and has been in compliance with the applicable technical standards.

The test results in this report apply exclusively to the tested model / sample. Without written approval of SPORTON INTERNATIONAL INC., the test report shall not be reproduced except in full.

Reviewed by: Joseph Lin / Supervisor

Approved by: Jones Tsai / Manager



SPORTON INTERNATIONAL INC.

No. 52, Hwa Ya 1st Rd., Hwa Ya Technology Park, Kwei-Shan Hsiang, Tao Yuan Hsien, Taiwan, R.O.C.

SPORTON INTERNATIONAL INC.

TEL : 886-3-327-3456

FAX : 886-3-328-4978

FCC ID : NM80P90300

Page Number : 1 of 47

Report Issued Date : Jul. 25, 2014

Report Version : Rev. 01

Report Template No.: BU5-FG22/24 Version 1.1



TABLE OF CONTENTS

REVISION HISTORY..... 3

SUMMARY OF TEST RESULT 4

1 GENERAL DESCRIPTION 5

 1.1 Applicant..... 5

 1.2 Manufacturer 5

 1.3 Product Feature of Equipment Under Test 5

 1.4 Product Specification subjective to this standard 6

 1.5 Modification of EUT 6

 1.6 Maximum ERP/EIRP Power, Frequency Tolerance, and Emission Designator 6

 1.7 Testing Location 7

 1.8 Applicable Standards 7

2 TEST CONFIGURATION OF EQUIPMENT UNDER TEST 8

 2.1 Test Mode..... 8

 2.2 Connection Diagram of Test System 9

 2.3 Support Unit used in test configuration 9

 2.4 Measurement Results Explanation Example 9

3 TEST RESULT 10

 3.1 Conducted Output Power Measurement..... 10

 3.2 Peak-to-Average Ratio 12

 3.3 Effective Radiated Power and Effective Isotropic Radiated Power Measurement 18

 3.4 99% Occupied Bandwidth and 26dB Bandwidth Measurement..... 21

 3.5 Band Edge Measurement..... 29

 3.6 Conducted Spurious Emission Measurement 32

 3.7 Field Strength of Spurious Radiation Measurement 38

 3.8 Frequency Stability Measurement..... 42

4 LIST OF MEASURING EQUIPMENT 46

5 UNCERTAINTY OF EVALUATION 47



SUMMARY OF TEST RESULT

Report Section	FCC Rule	IC Rule	Description	Limit	Result	Remark
3.1	§2.1046	RSS-132 (5.4) RSS-133 (6.4)	Conducted Output Power	N/A	PASS	-
3.2	§24.232(d)	RSS-132 (5.4) RSS-133(6.4)	Peak-to-Average Ratio	<13 dB	PASS	-
3.3	§22.913(a)(2)	RSS-132(5.4) SRSP-503(5.1.3)	Effective Radiated Power	< 7 Watts	PASS	-
3.3	§24.232(c)	RSS-133 (6.4) SRSP-510(5.1.2)	Equivalent Isotropic Radiated Power	< 2 Watts	PASS	-
3.4	§2.1049 §22.917(b) §24.238(b)	RSS-GEN(4.6.1) RSS-133(2.3)	Occupied Bandwidth	N/A	PASS	-
3.5	§2.1051 §22.917(a) §24.238(a)	RSS-132 (5.5) RSS-133 (6.5)	Band Edge Measurement	< 43+10log ₁₀ (P[Watts])	PASS	-
3.6	§2.1051 §22.917(a) §24.238(a)	RSS-132 (5.5) RSS-133 (6.5)	Conducted Spurious Emission	< 43+10log ₁₀ (P[Watts])	PASS	-
3.7	§2.1053 §22.917(a) §24.238(a)	RSS-132 (5.5) RSS-133 (6.5)	Field Strength of Spurious Radiation	< 43+10log ₁₀ (P[Watts])	PASS	Under limit 20.62 dB at 13160.000 MHz
3.8	§2.1055 §22.355 §24.235	RSS-132(5.3) RSS-133(6.3)	Frequency Stability for Temperature & Voltage	< 2.5 ppm	PASS	-



1 General Description

1.1 Applicant

HTC Corporation

No. 23, Xinghua Rd., Taoyuan City, Taoyuan County 330, Taiwan.

1.2 Manufacturer

HTC Corporation

No. 23, Xinghua Rd., Taoyuan City, Taoyuan County 330, Taiwan.

1.3 Product Feature of Equipment Under Test

Product Feature	
Equipment	Smartphone
Model Name	0P9O300
Sample 1	EUT with LCM, Camera Front, Camera Back, and Battery 1
Sample 2	EUT with LCM, Camera Front, Camera Back, and Battery 2
FCC ID	NM80P9O300
EUT supports Radios application	CDMA/EV-DO/LTE/NFC WLAN 11b/g/n HT20 Bluetooth v4.0 EDR/LE
EUT Stage	Identical Prototype

Remark:

1. The above EUT's information was declared by manufacturer. Please refer to the specifications or user's manual for more detailed description.
2. All the tests were performance with Sample 1.



1.4 Product Specification subjective to this standard

Product Specification subjective to this standard	
Tx Frequency	CDMA2000 BC0: 824.70 MHz ~ 848.31 MHz CDMA2000 BC1: 1851.25 MHz ~ 1908.75 MHz
Rx Frequency	CDMA2000 BC0: 869.70 MHz ~ 893.31 MHz CDMA2000 BC1: 1931.25 MHz ~ 1988.75 MHz
Maximum Output Power to Antenna	CDMA2000 BC0 : 23.98 dBm CDMA2000 BC1 : 23.99 dBm
Antenna Type	Fixed Internal Antenna
Antenna Gain	CDMA2000 BC0: -1.90 dBi CDMA2000 BC1: -0.40 dBi
Type of Modulation	CDMA2000 : QPSK CDMA2000 1xEV-DO : QPSK/8PSK

1.5 Modification of EUT

No modifications are made to the EUT during all test items.

1.6 Maximum ERP/EIRP Power, Frequency Tolerance, and Emission Designator

FCC Rule	System	Type of Modulation	Maximum ERP/EIRP (W)	Frequency Tolerance (ppm)	Emission Designator
Part 22	CDMA2000 BC0 1xEV-DO Rev. 0	QPSK	0.06	0.0347 ppm	1M28F9W
Part 24	CDMA2000 BC1 1xEV-DO Rev. 0	QPSK	0.10	0.0096 ppm	1M29F9W



1.7 Testing Location

Sporton Lab is accredited to ISO 17025 by Taiwan Accreditation Foundation (TAF code : 1190) and the FCC designation No. TW1022 under the FCC 2.948(e) by Mutual Recognition Agreement (MRA) in FCC Test.

Test Site	SPORTON INTERNATIONAL INC.	
Test Site Location	No. 52, Hwa Ya 1 st Rd., Hwa Ya Technology Park, Kwei-Shan Hsiang, Tao Yuan Hsien, Taiwan, R.O.C. TEL: +886-3-327-3456 FAX: +886-3-328-4978	
Test Site No.	Sporton Site No.	
	TH02-HY	03CH07-HY

1.8 Applicable Standards

According to the specifications of the manufacturer, the EUT must comply with the requirements of the following standards:

- ♦ FCC 47 CFR Part 2, 22(H), 24(E)
- ♦ ANSI / TIA / EIA-603-C-2004
- ♦ FCC KDB 971168 D01 Power Meas. License Digital Systems v02r01

Remark:

1. All test items were verified and recorded according to the standards and without any deviation during the test.
2. This EUT has also been tested and complied with the requirements of FCC Part 15, Subpart B, recorded in a separate test report.



2 Test Configuration of Equipment Under Test

2.1 Test Mode

Antenna port conducted and radiated test items were performed according to KDB 971168 D01 Power Meas. License Digital Systems v02r01 with maximum output power.

Radiated measurements were performed with rotating EUT in different three orthogonal test planes to find the maximum emission.

Radiated emissions were investigated as following frequency range:

1. 30 MHz to 9000 MHz for CDMA2000 BC0.
2. 30 MHz to 19000 MHz for CDMA2000 BC1.

Test Modes		
Band	Radiated TCs	Conducted TCs
CDMA2000 BC0	■ 1xEV-DO Rev. 0 Link Mode	■ 1xEV-DO Rev. 0 Link Mode
CDMA2000 BC1	■ 1xEV-DO Rev. 0 Link Mode	■ 1xEV-DO Rev. 0 Link Mode

Note: The maximum power levels are chosen to test as the worst case configuration as follows:

1xEV-DO Rev. 0 RTAP 153.6K mode for CDMA2000 BC0,

1xEV-DO Rev. 0 RTAP 153.6K mode for CDMA2000 BC1, only these modes were used for all tests.

Conducted Power Measurement Results:

Conducted Power (*Unit: dBm)						
Band	CDMA2000 BC0			CDMA2000 BC1		
Channel	1013	384	777	25	600	1175
Frequency	824.7	836.52	848.31	1851.25	1880	1908.75
1xRTT RC1 SO55	23.85	23.95	23.88	23.96	23.81	23.98
1xRTT RC3 SO55	23.79	23.89	23.81	23.90	23.85	23.95
1xRTT RC3 SO32(+ F-SCH)	23.79	23.91	23.80	23.89	23.73	23.92
1xRTT RC3 SO32(+SCH)	23.76	23.87	23.78	23.87	23.74	23.96
1xEV-DO RTAP 153.6kbps	23.90	23.98	23.91	23.98	23.92	23.99
1xEV-DO RETAP 4096Bits	23.89	23.97	23.90	23.97	23.90	23.98

2.2 Connection Diagram of Test System

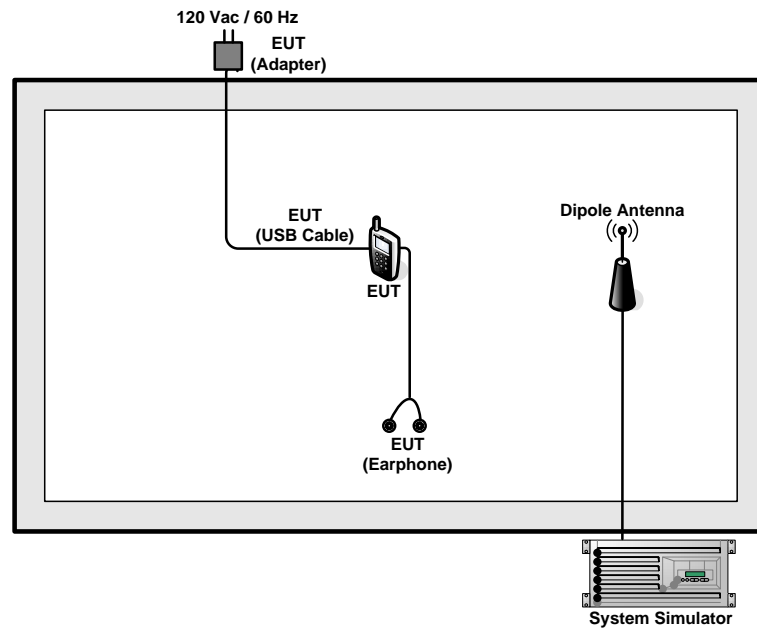

2.3 Support Unit used in test configuration

Item	Equipment	Trade Name	Model No.	FCC ID	Data Cable	Power Cord
1.	System Simulator	R&S	CMU 200	N/A	N/A	Unshielded, 1.8 m

2.4 Measurement Results Explanation Example

For all conducted test items:

The offset level is set in the spectrum analyzer to compensate the RF cable loss and attenuator factor between RF conducted output port and spectrum analyzer. With the offset compensation, the spectrum analyzer reading level will be exactly the RF output level.

The spectrum analyzer offset is derived from RF cable loss and attenuator factor.

Offset = RF cable loss + attenuator factor.

The following shows an offset computation example with RF cable loss 4.2 dB and a 10dB attenuator.

Example :

$$\begin{aligned} \text{Offset(dB)} &= \text{RF cable loss(dB)} + \text{attenuator factor(dB)} \\ &= 4.2 + 10 = 14.2 \text{ (dB)} \end{aligned}$$

3 Test Result

3.1 Conducted Output Power Measurement

3.1.1 Description of the Conducted Output Power Measurement

A system simulator was used to establish communication with the EUT. Its parameters were set to enforce EUT transmitting at the maximum power. The measured power in the radio frequency on the transmitter output terminals shall be reported.

3.1.2 Measuring Instruments

The measuring equipment is listed in the section 4 of this test report.

3.1.3 Test Procedures

1. The transmitter output port was connected to the system simulator.
2. Set EUT at maximum power through system simulator.
3. Select lowest, middle, and highest channels for each band and different modulation.
4. Measure the maximum burst average power for GSM and maximum average power for other modulation signal.

3.1.4 Test Setup

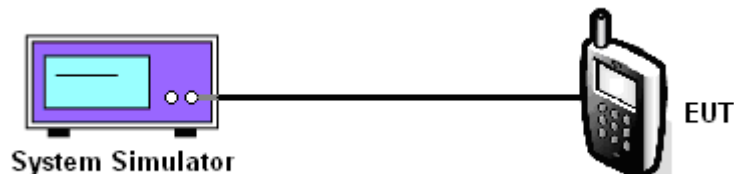



3.1.5 Test Result of Conducted Output Power

CDMA2000 BC0			
Test Mode	CDMA 2000 1xEV-DO Rev. 0		
Test Status	RTAP 153.6K		
Channel	1013 (Low)	384 (Mid)	777 (High)
Frequency (MHz)	824.70	836.52	848.31
Conducted Power (dBm)	23.90	23.98	23.91

CDMA2000 BC1			
Test Mode	CDMA 2000 1xEV-DO Rev. 0		
Test Status	RTAP 153.6K		
Channel	25 (Low)	600 (Mid)	1175 (High)
Frequency (MHz)	1851.25	1880.00	1908.75
Conducted Power (dBm)	23.98	23.92	23.99

Note: maximum average power for CDMA2000.

3.2 Peak-to-Average Ratio

3.2.1 Description of the PAR Measurement

The peak-to-average ratio (PAR) of the transmission may not exceed 13 dB.

3.2.2 Measuring Instruments

The measuring equipment is listed in the section 4 of this test report.

3.2.3 Test Procedures

1. The EUT was connected to the spectrum analyzer and system simulator via a power divider.
2. Set the CCDF (Complementary Cumulative Distribution Function) option on the spectrum analyzer.
3. The highest RF powers were measured and recorded the maximum PAPR level associated with a probability of 0.1 %.
4. Record the deviation as Peak to Average Ratio.

3.2.4 Test Setup

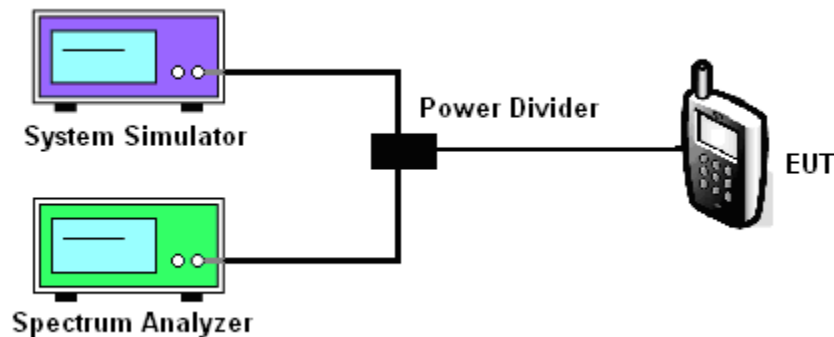



3.2.5 Test Result of Peak-to-Average Ratio

CDMA2000 BC0			
Modes	CDMA 2000 1xEV-DO Rev. 0		
Test Status	RTAP 153.6K		
Channel	1013 (Low)	384 (Mid)	777 (High)
Frequency (MHz)	824.70	836.52	848.31
Peak-to-Average Ratio (dB)	4.20	4.36	4.60

CDMA2000 BC1			
Modes	CDMA 2000 1xEV-DO Rev. 0		
Test Status	RTAP 153.6K		
Channel	25 (Low)	600 (Mid)	1175 (High)
Frequency (MHz)	1851.25	1880.00	1908.75
Peak-to-Average Ratio (dB)	3.60	4.28	4.00



3.2.6 Test Result (Plots) of Peak-to-Average Ratio

Band :	CDMA2000 BC0	Test Mode :	1xRTT Link (QPSK)
--------	--------------	-------------	-------------------

Peak-to-Average Ratio on Channel 1013 (824.70 MHz)

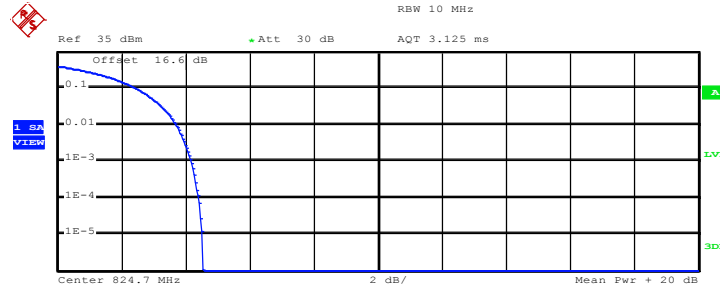

Complementary Cumulative Distribution Function (100000 samples)

Trace 1

Mean	23.52 dBm
Peak	28.06 dBm
Crest	4.54 dB
10 %	2.48 dB
1 %	3.72 dB
.1 %	4.20 dB
.01 %	4.40 dB

Date: 23.JUN.2014 13:39:14

Peak-to-Average Ratio on Channel 384 (836.52 MHz)

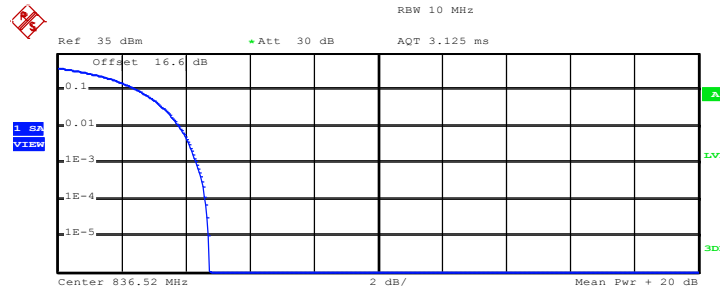

Complementary Cumulative Distribution Function (100000 samples)

Trace 1

Mean	23.61 dBm
Peak	28.34 dBm
Crest	4.73 dB
10 %	2.52 dB
1 %	3.80 dB
.1 %	4.36 dB
.01 %	4.64 dB

Date: 23.JUN.2014 13:39:53



Peak-to-Average Ratio on Channel 777 (848.31 MHz)

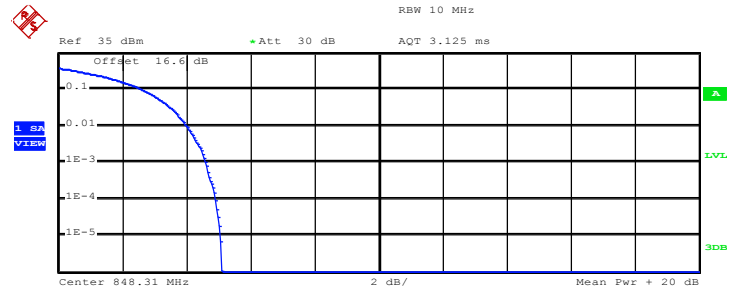

Complementary Cumulative Distribution Function (100000 samples)

Trace 1

Mean	23.60 dBm
Peak	28.69 dBm
Crest	5.09 dB
10 %	2.68 dB
1 %	4.00 dB
.1 %	4.60 dB
.01 %	4.92 dB

Date: 23.JUN.2014 13:40:16



Band :	CDMA2000 BC1	Test Mode :	1xRTT Link (QPSK)
---------------	--------------	--------------------	-------------------

Peak-to-Average Ratio on Channel 25 (1851.25 MHz)

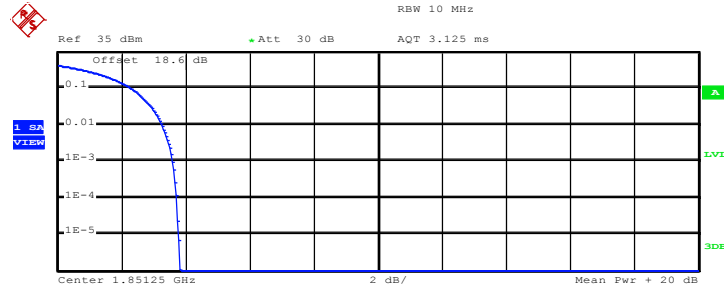

Complementary Cumulative Distribution Function (100000 samples)

Trace 1

Mean	24.74 dBm
Peak	28.55 dBm
Crest	3.81 dB
10 %	2.32 dB
1 %	3.28 dB
.1 %	3.60 dB
.01 %	3.72 dB

Date: 23.JUN.2014 14:19:34

Peak-to-Average Ratio on Channel 600 (1880 MHz)

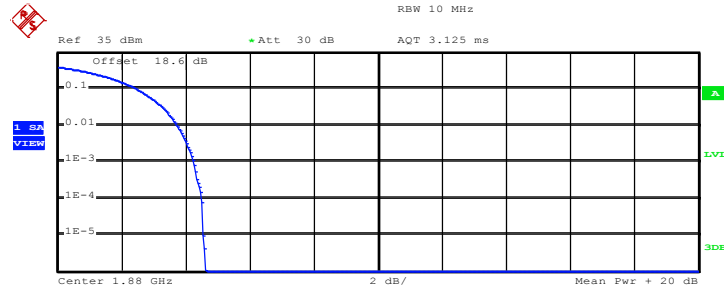

Complementary Cumulative Distribution Function (100000 samples)

Trace 1

Mean	24.21 dBm
Peak	28.83 dBm
Crest	4.62 dB
10 %	2.52 dB
1 %	3.76 dB
.1 %	4.28 dB
.01 %	4.52 dB

Date: 23.JUN.2014 14:20:20



Peak-to-Average Ratio on Channel 1175 (1908.75 MHz)

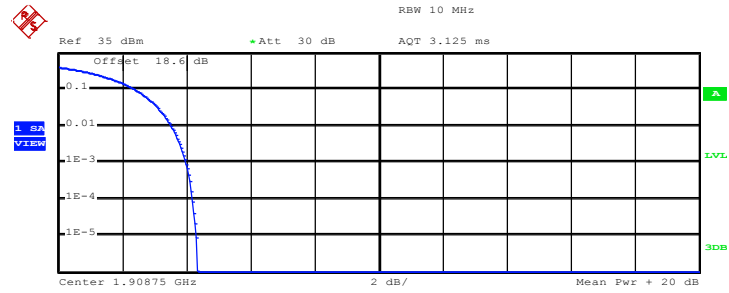

Complementary Cumulative Distribution Function (100000 samples)

Trace 1

Mean	24.27 dBm
Peak	28.62 dBm
Crest	4.35 dB
10 %	2.44 dB
1 %	3.52 dB
.1 %	4.00 dB
.01 %	4.20 dB

Date: 23.JUN.2014 14:21:34



3.3 Effective Radiated Power and Effective Isotropic Radiated Power Measurement

3.3.1 Description of the ERP/EIRP Measurement

The substitution method, in ANSI / TIA / EIA-603-C-2004, was used for ERP/EIRP measurement, and the spectrum analyzer configuration follows KDB 971168 D01 Power Meas. License Digital Systems v02r01. The ERP of mobile transmitters must not exceed 7 Watts and the EIRP of mobile transmitters are limited to 2 Watts.

3.3.2 Measuring Instruments

The measuring equipment is listed in the section 4 of this test report.

3.3.3 Test Procedures

1. The EUT was placed on a turntable 1.5 meters high in a fully anechoic chamber.
2. The EUT was placed 3 meters from the receiving antenna, which was mounted on the antenna tower.
3. Set RBW= 100 kHz, VBW= 300 kHz, RMS detector over frame, and use channel power option with bandwidth=5MHz, per KDB 971168 D01.
4. The table was rotated 360 degrees to determine the position of the highest radiated power.
5. The height of the receiving antenna is adjusted to look for the maximum ERP/EIRP.
6. Taking the record of maximum ERP/EIRP.
7. A dipole antenna was substituted in place of the EUT and was driven by a signal generator.
8. The conducted power at the terminal of the dipole antenna is measured.
9. Repeat step 3 to step 5 to get the maximum ERP/EIRP of the substitution antenna.
10. $ERP/EIRP = P_s + E_t - E_s + G_s = P_s + R_t - R_s + G_s$

P_s (dBm) : Input power to substitution antenna.

G_s (dBi or dBd) : Substitution antenna Gain.

$E_t = R_t + AF$

$E_s = R_s + AF$

AF (dB/m) : Receive antenna factor

R_t : The highest received signal in spectrum analyzer for EUT.

R_s : The highest received signal in spectrum analyzer for substitution antenna.

3.3.4 Test Setup

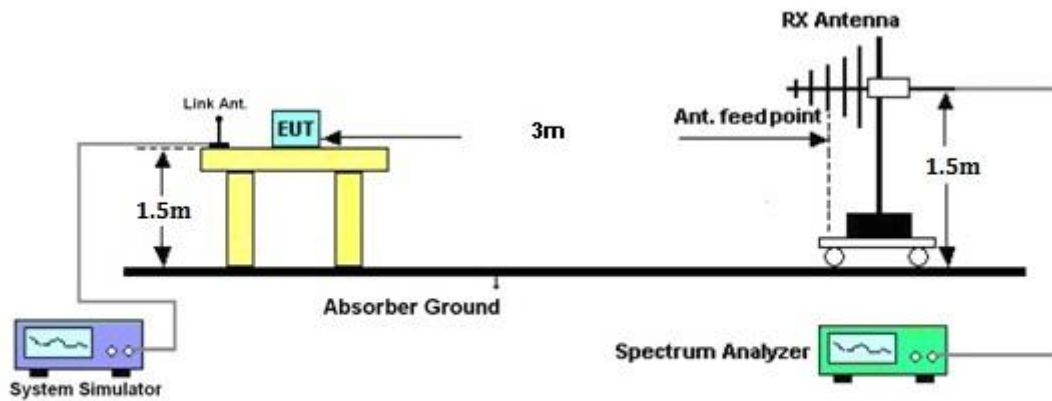



3.3.5 Test Result of ERP

CDMA2000 BC0 1xEV-DO Rev. 0_RTAP 153.6K Radiated Power ERP						
Horizontal Polarization						
Frequency (MHz)	Rt (dBm)	Rs (dBm)	Ps (dBm)	Gs (dBd)	ERP (dBm)	ERP (W)
824.70	-30.16	-48.12	0.00	-1.08	16.88	0.05
836.52	-31.40	-48.28	0.00	-0.93	15.95	0.04
848.31	-29.61	-48.35	0.00	-0.76	17.98	0.06
Vertical Polarization						
Frequency (MHz)	Rt (dBm)	Rs (dBm)	Ps (dBm)	Gs (dBd)	ERP (dBm)	ERP (W)
824.70	-39.38	-47.97	0.00	-1.08	7.51	0.01
836.52	-39.55	-48.01	0.00	-0.93	7.53	0.01
848.31	-39.25	-48.05	0.00	-0.76	8.04	0.01

3.3.6 Test Result of EIRP

CDMA2000 BC1 1xEV-DO Rev. 0_RTAP 153.6K Radiated Power EIRP						
Horizontal Polarization						
Frequency (MHz)	Rt (dBm)	Rs (dBm)	Ps (dBm)	Gs (dBi)	EIRP (dBm)	EIRP (W)
1851.25	-33.70	-51.88	0.00	1.96	20.14	0.10
1880.00	-34.90	-52.99	0.00	2.00	20.09	0.10
1908.75	-36.19	-54.28	0.00	1.98	20.07	0.10
Vertical Polarization						
Frequency (MHz)	Rt (dBm)	Rs (dBm)	Ps (dBm)	Gs (dBi)	EIRP (dBm)	EIRP (W)
1851.25	-35.35	-52.13	0.00	1.96	18.74	0.07
1880.00	-36.70	-53.17	0.00	2.00	18.47	0.07
1908.75	-38.00	-54.13	0.00	1.98	18.11	0.06

3.4 99% Occupied Bandwidth and 26dB Bandwidth Measurement

3.4.1 Description of 99% Occupied Bandwidth and 26dB Bandwidth Measurement

The 99% occupied bandwidth is the width of a frequency band such that, below the lower and above the upper frequency limits, the mean powers emitted are each equal to a specified percentage 0.5% of the total mean transmitted power.

The emission bandwidth is defined as the width of the signal between two points, located at the 2 sides of the carrier frequency, outside of which all emissions are attenuated at least 26 dB below the transmitter power.

3.4.2 Measuring Instruments

The measuring equipment is listed in the section 4 of this test report.

3.4.3 Test Procedures

1. The EUT was connected to the spectrum analyzer and system simulator via a power divider.
2. The RF output of the EUT was connected to the spectrum analyzer by RF cable and attenuator. The path loss was compensated to the results for each measurement.
3. The 99% occupied bandwidth were measured, set RBW= 1% of span, VBW= 3*RBW, sample detector, trace maximum hold.
4. The 26dB bandwidth were measured, set RBW= 1% of EBW, VBW= 3*RBW, peak detector, trace maximum hold.

3.4.4 Test Setup

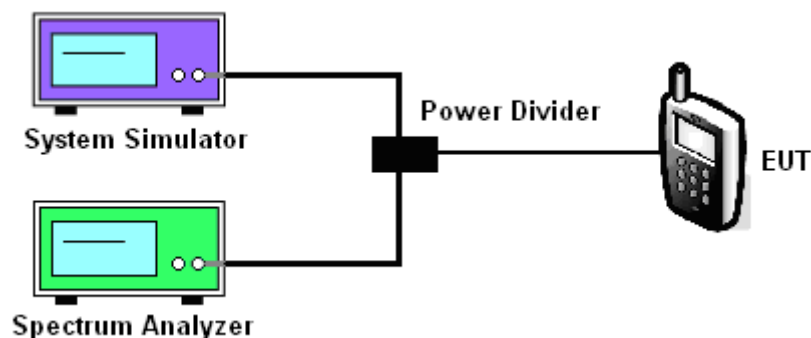



3.4.5 Test Result of Occupied Bandwidth and 26dB Bandwidth

CDMA2000 BC0			
Test Mode	CDMA 2000 1xEV-DO Rev. 0		
Test Status	RTAP 153.6K		
Channel	1013 (Low)	384 (Mid)	777 (High)
Frequency (MHz)	824.70	836.52	848.31
99% OBW (MHz)	1.28	1.28	1.28
26dB BW (MHz)	1.42	1.42	1.41

CDMA2000 BC1			
Test Mode	CDMA 2000 1xEV-DO Rev. 0		
Test Status	RTAP 153.6K		
Channel	25 (Low)	600 (Mid)	1175 (High)
Frequency (MHz)	1851.25	1880.00	1908.75
99% OBW (MHz)	1.28	1.28	1.29
26dB BW (MHz)	1.42	1.44	1.53



3.4.6 Test Result (Plots) of Occupied Bandwidth and 26dB Bandwidth

Band :	CDMA2000 BC0	Test Mode :	1xEV-DO Rev. 0_RTAP 153.6K (QPSK)
--------	--------------	-------------	-----------------------------------

99% Occupied Bandwidth Plot on Channel 1013 (824.7 MHz)

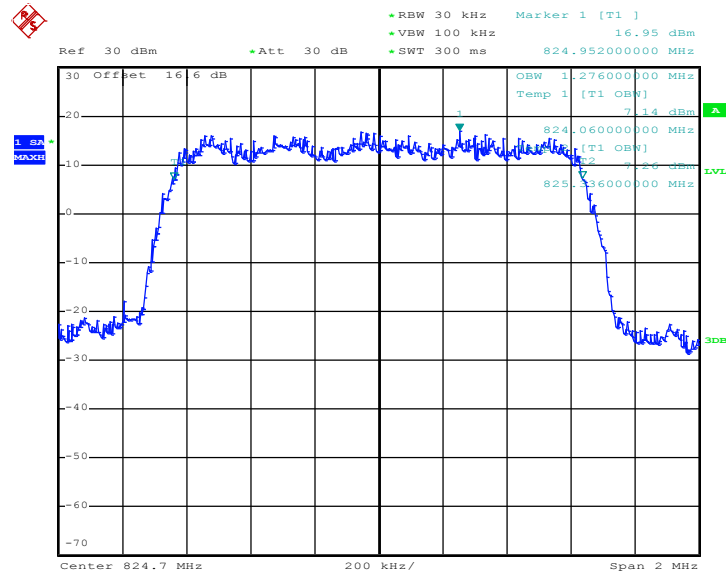

Date: 23.JUN.2014 13:53:26

26dB Bandwidth Plot on Channel 1013 (824.7 MHz)

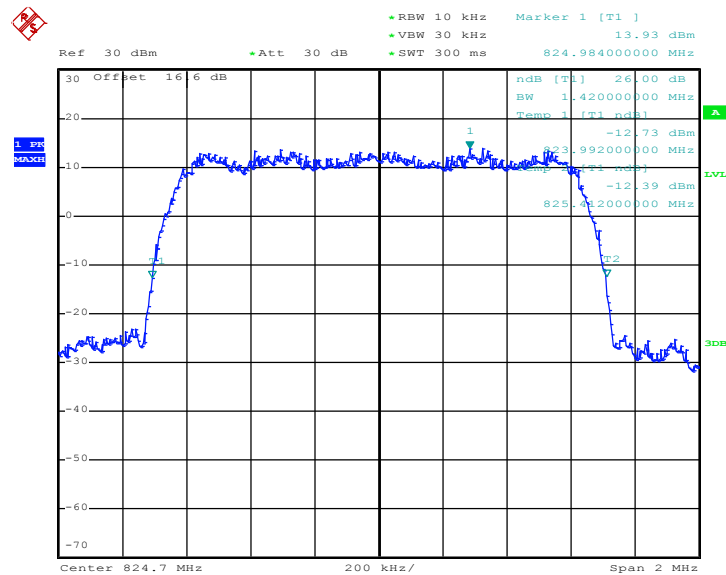

Date: 23.JUN.2014 13:50:42



99% Occupied Bandwidth Plot on Channel 384 (836.52 MHz)

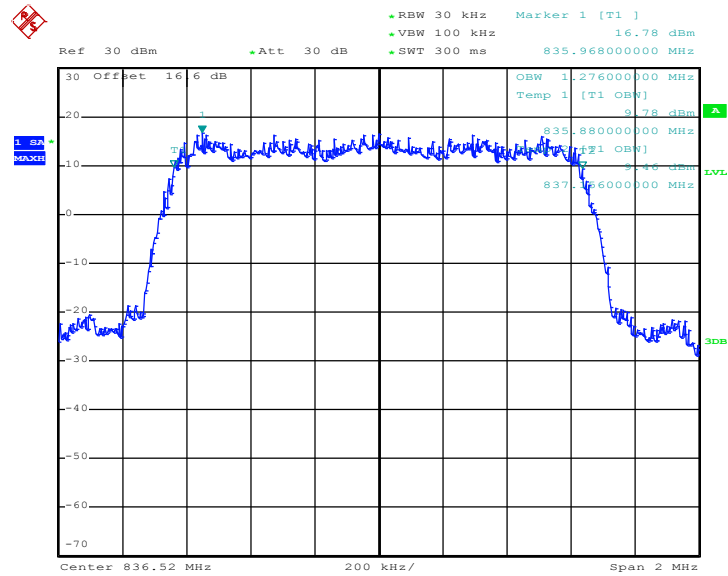

Date: 23.JUN.2014 13:53:55

26dB Bandwidth Plot on Channel 384 (836.52 MHz)

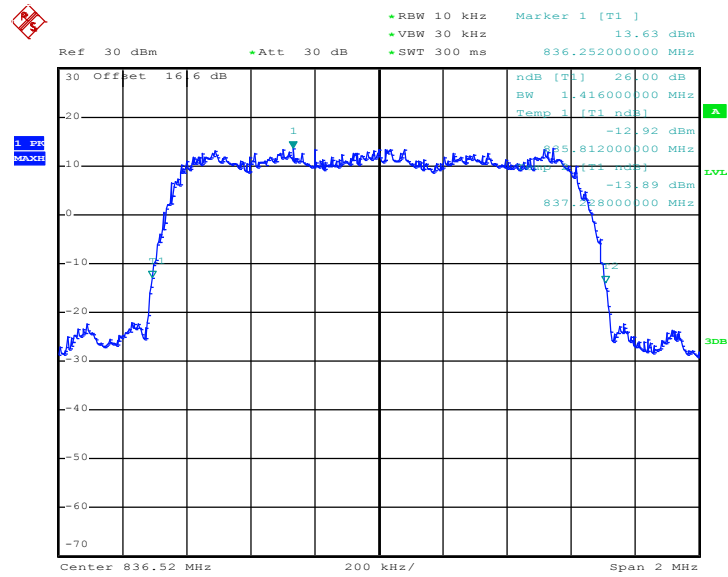

Date: 23.JUN.2014 13:51:10



99% Occupied Bandwidth Plot on Channel 777 (848.31 MHz)

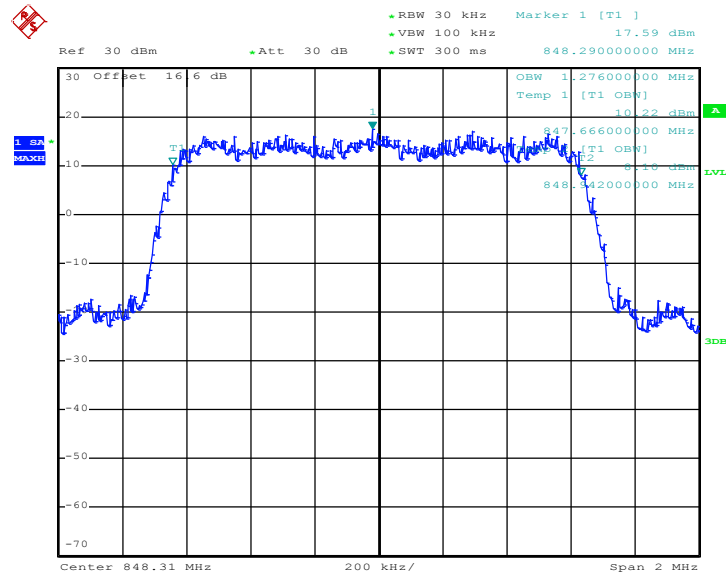

Date: 23.JUN.2014 13:54:24

26dB Bandwidth Plot on Channel 777 (848.31 MHz)

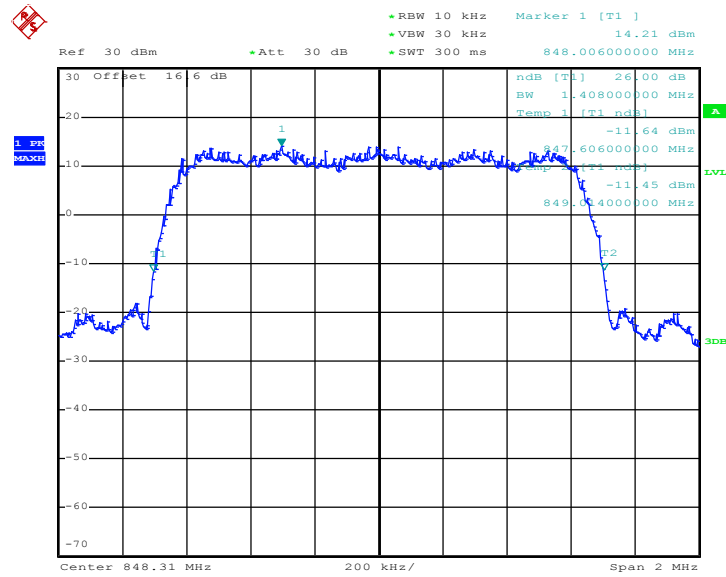

Date: 23.JUN.2014 13:51:39



Band :	CDMA2000 BC1	Test Mode :	1xEV-DO Rev. 0_RTAP 153.6K (QPSK)
---------------	--------------	--------------------	-----------------------------------

99% Occupied Bandwidth Plot on Channel 25 (1851.25 MHz)

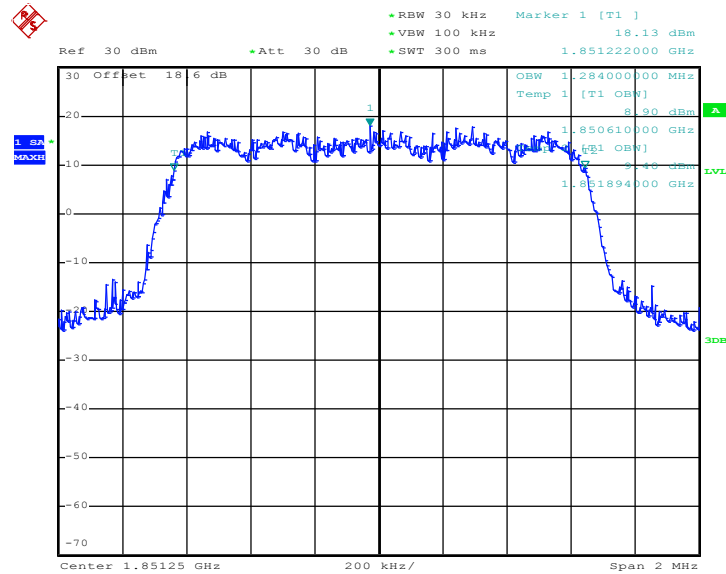

Date: 23.JUN.2014 14:36:47

26dB Bandwidth Plot on Channel 25 (1851.25 MHz)

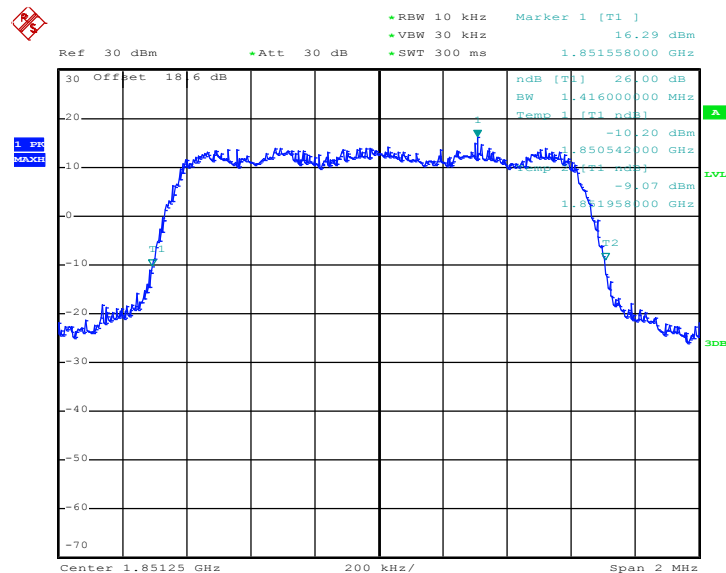

Date: 23.JUN.2014 14:34:57



99% Occupied Bandwidth Plot on Channel 600 (1880.0 MHz)

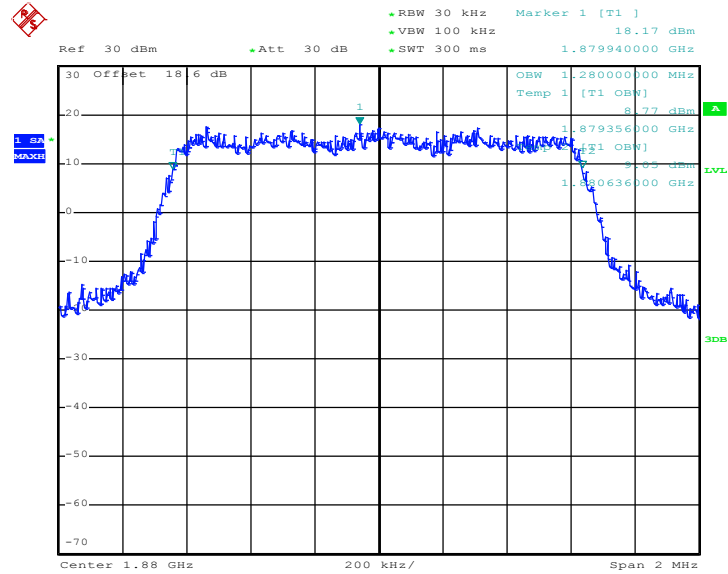

Date: 23.JUN.2014 14:37:16

26dB Bandwidth Plot on Channel 600 (1880.0 MHz)

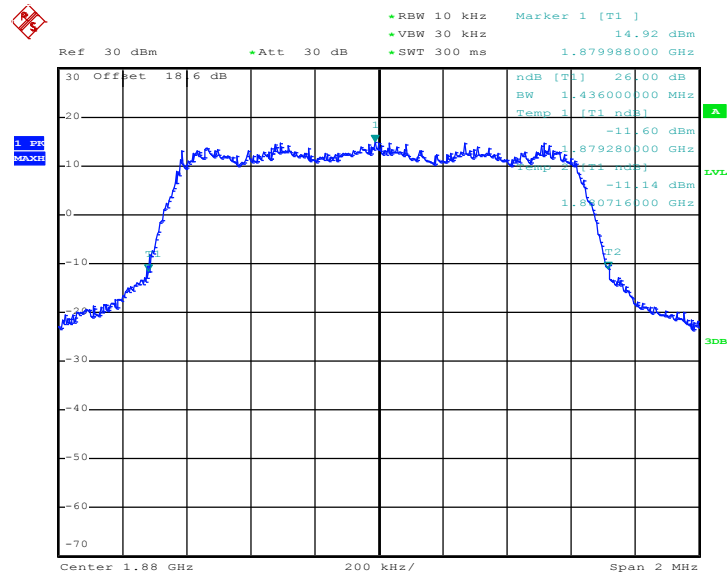

Date: 23.JUN.2014 14:35:26



99% Occupied Bandwidth Plot on Channel 1175 (1908.75 MHz)

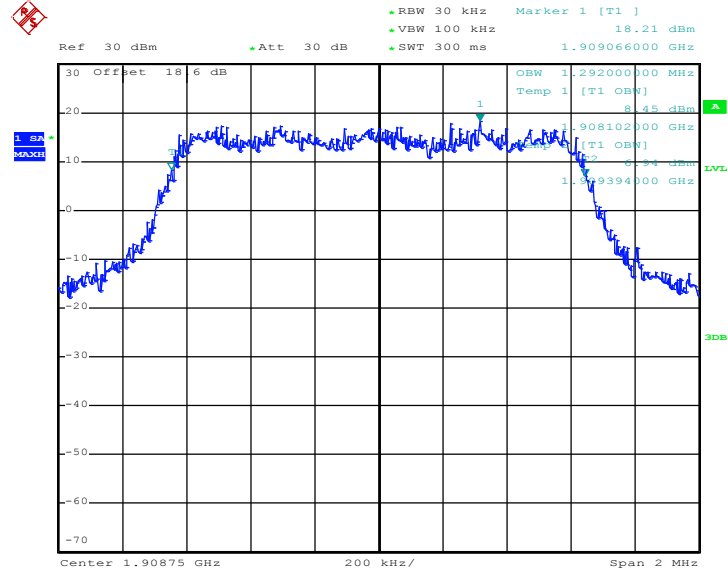

Date: 23.JUN.2014 14:37:44

26dB Bandwidth Plot on Channel 1175 (1908.75 MHz)

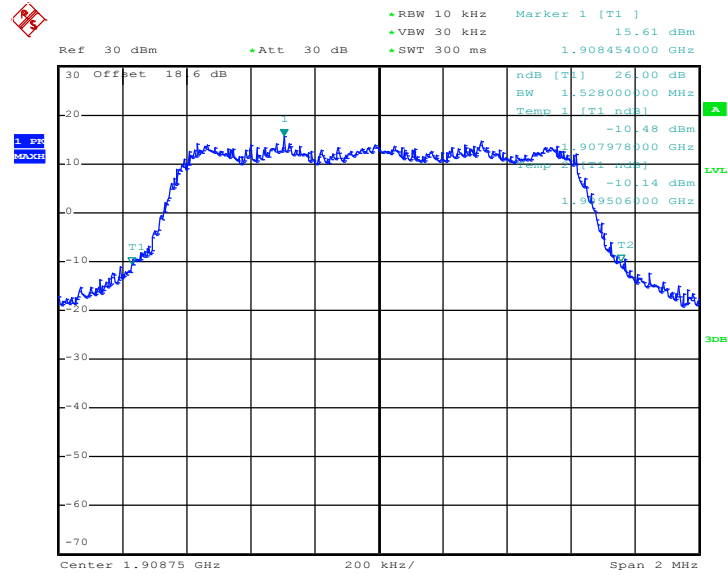

Date: 23.JUN.2014 14:35:55

3.5 Band Edge Measurement

3.5.1 Description of Band Edge Measurement

The power of any emission outside of the authorized operating frequency ranges must be lower than the transmitter power (P) by a factor of at least $43 + 10 \log (P)$ dB.

3.5.2 Measuring Instruments

The measuring equipment is listed in the section 4 of this test report.

3.5.3 Test Procedures

1. The EUT was connected to the spectrum analyzer and system simulator via a power divider.
2. The RF output of EUT was connected to the spectrum analyzer by an RF cable and attenuator. The path loss was compensated to the results for each measurement.
3. The band edges of low and high channels for the highest RF powers were measured.
4. The RBW was replaced by 10 kHz, slightly smaller than the value in (2), due to the spectrum analyzer limitation to set the exact value. A worst case correction factor of $10 \cdot \log (1\% \text{ emission-BW}/\text{measurement RBW})$ was compensated.
5. The RF fundamental frequency should be excluded against the limit line in the operating frequency band.
6. The limit line is derived from $43 + 10 \log (P)$ dB below the transmitter power P(Watts)
 $= P(W) - [43 + 10 \log (P)] \text{ (dB)}$
 $= [30 + 10 \log (P)] \text{ (dBm)} - [43 + 10 \log (P)] \text{ (dB)}$
 $= -13 \text{ dBm.}$

3.5.4 Test Setup

<Conducted Band Edge >

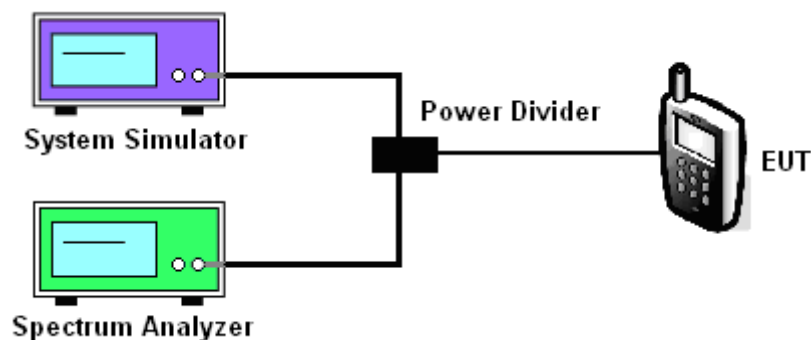



3.5.5 Test Result (Plots) of Conducted Band Edge

Band :	CDMA2000 BC0	Test Mode :	1xEV-DO Rev. 0_RTAP 153.6K (QPSK)
--------	--------------	-------------	-----------------------------------

Lower Band Edge Plot on Channel 1013 (824.7 MHz)

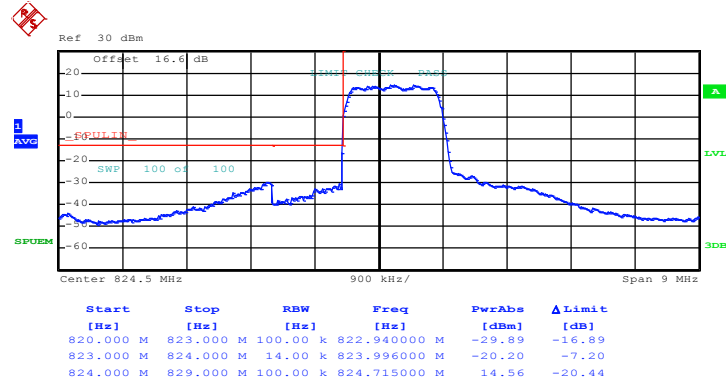

Date: 23.JUN.2014 13:47:22

Higher Band Edge Plot on Channel 777 (848.31 MHz)

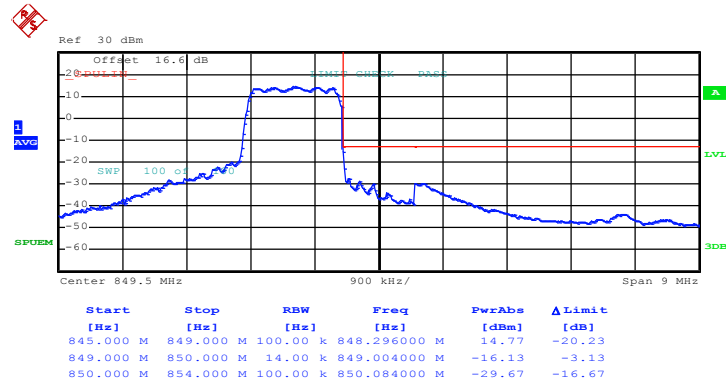

Date: 23.JUN.2014 13:43:45



Band :	CDMA2000 BC1	Test Mode :	1xEV-DO Rev. 0_RTAP 153.6K (QPSK)
---------------	--------------	--------------------	-----------------------------------

Lower Band Edge Plot on Channel 25 (1851.25 MHz)

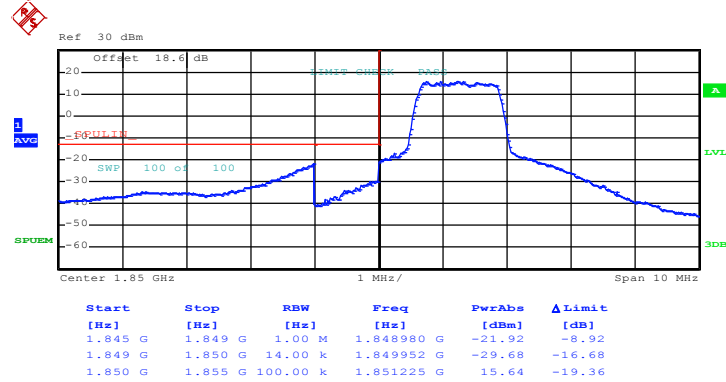

Date: 23.JUN.2014 14:28:54

Higher Band Edge Plot on Channel 1175 (1908.75 MHz)

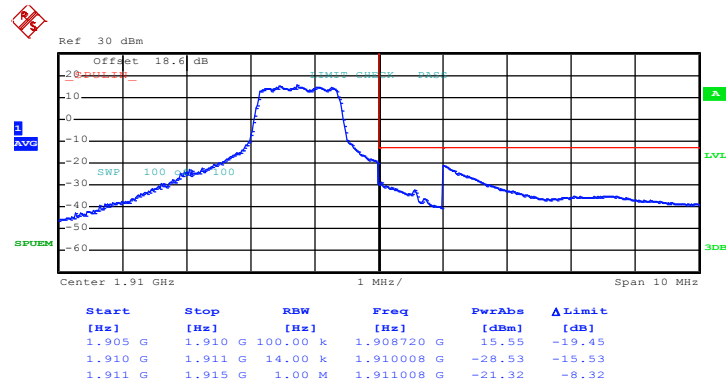

Date: 23.JUN.2014 14:25:36

3.6 Conducted Spurious Emission Measurement

3.6.1 Description of Conducted Spurious Emission Measurement

The power of any emission outside of the authorized operating frequency ranges must be lower than the transmitter power (P) by a factor of at least $43 + 10 \log (P)$ dB.

It is measured by means of a calibrated spectrum analyzer and scanned from 30 MHz up to a frequency including its 10th harmonic.

3.6.2 Measuring Instruments

The measuring equipment is listed in the section 4 of this test report.

3.6.3 Test Procedures

1. The EUT was connected to the spectrum analyzer and system simulator via a power divider.
2. The RF output of EUT was connected to the spectrum analyzer by an RF cable and attenuator. The path loss was compensated to the results for each measurement.
3. The middle channel for the highest RF power within the transmitting frequency was measured.
4. The conducted spurious emission for the whole frequency range was taken.
5. The RF fundamental frequency should be excluded against the limit line in the operating frequency band.
6. The limit line is derived from $43 + 10\log(P)$ dB below the transmitter power P(Watts)
 $= P(W) - [43 + 10\log(P)]$ (dB)
 $= [30 + 10\log(P)]$ (dBm) - $[43 + 10\log(P)]$ (dB)
 $= -13\text{dBm}$.

3.6.4 Test Setup

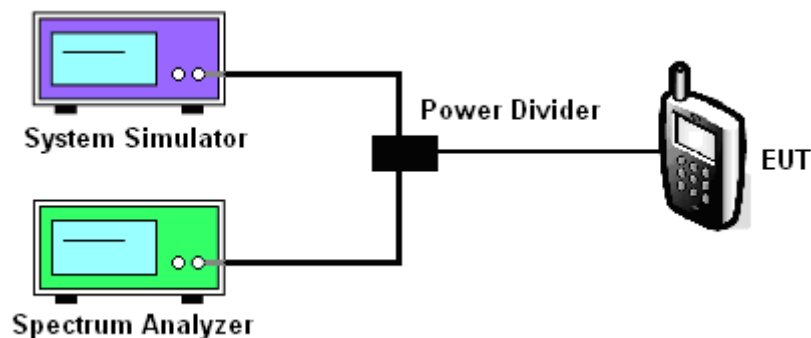



3.6.5 Test Result (Plots) of Conducted Spurious Emission

Band :	CDMA2000 BC0	Channel :	CH384
Test Mode :	1xEV-DO Rev. 0_RTAP 153.6K (QPSK)	Frequency :	836.52 MHz

Conducted Spurious Emission Plot between 30MHz ~ 1GHz

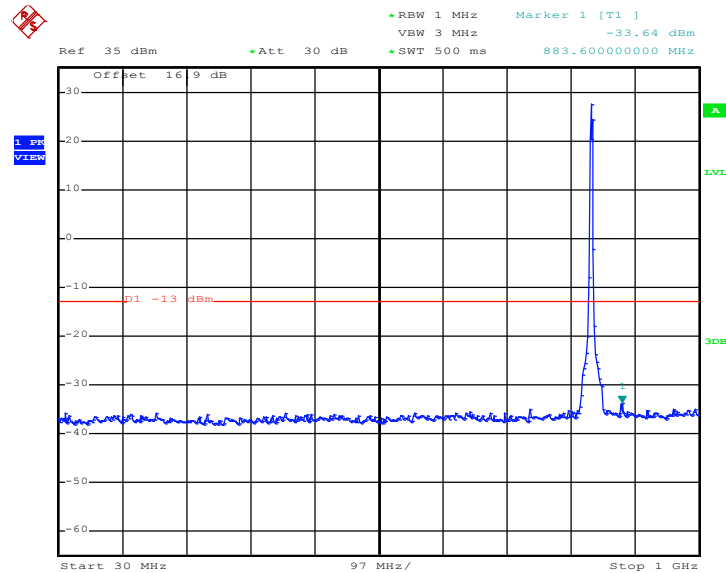

Date: 23.JUN.2014 13:55:18

Conducted Spurious Emission Plot between 1GHz ~ 3GHz

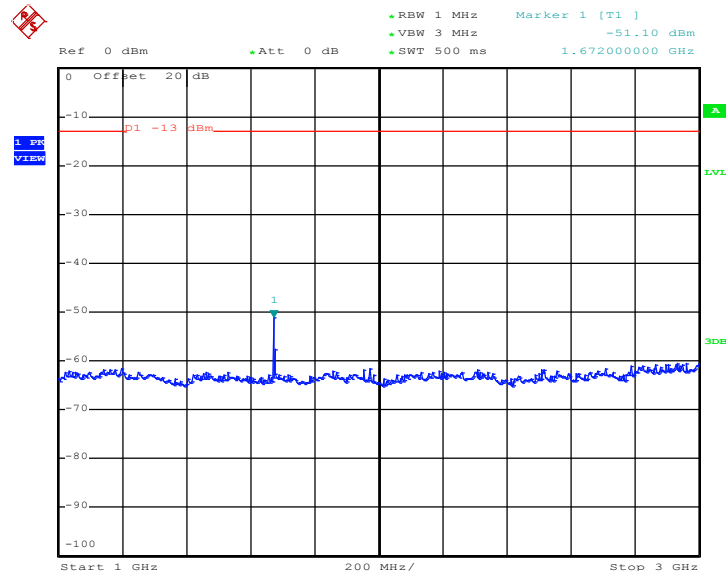

Date: 23.JUN.2014 13:55:33



Conducted Spurious Emission Plot between 3GHz ~ 7GHz

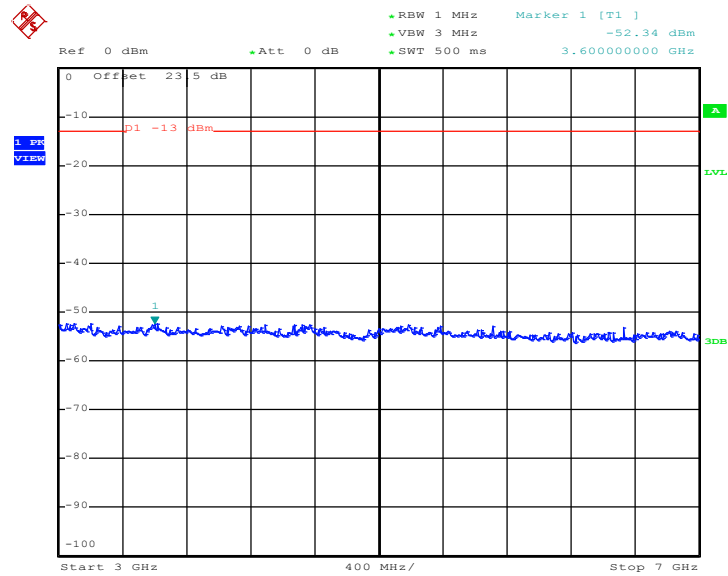

Date: 23.JUN.2014 13:55:42

Conducted Spurious Emission Plot between 7GHz ~ 9GHz

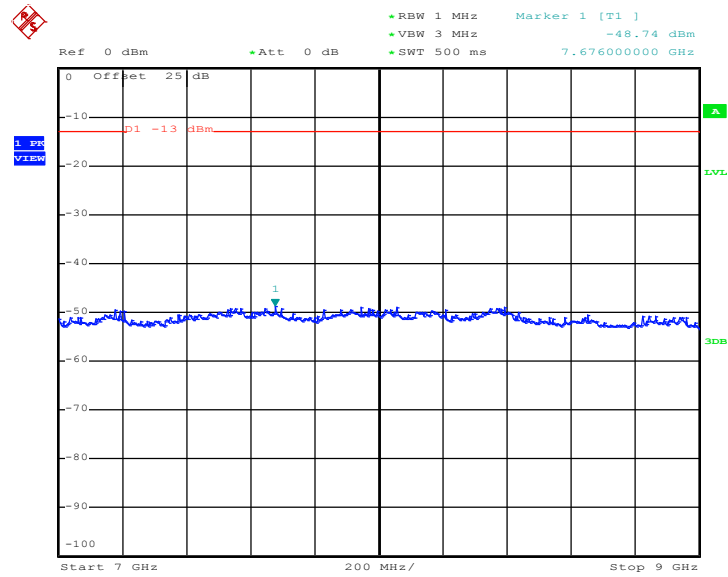

Date: 23.JUN.2014 13:55:50



Band :	CDMA2000 BC1	Channel :	CH600
Test Mode :	1xEV-DO Rev. 0_RTAP 153.6K (QPSK)	Frequency :	1880.0 MHz

Conducted Spurious Emission Plot between 30MHz ~ 1GHz

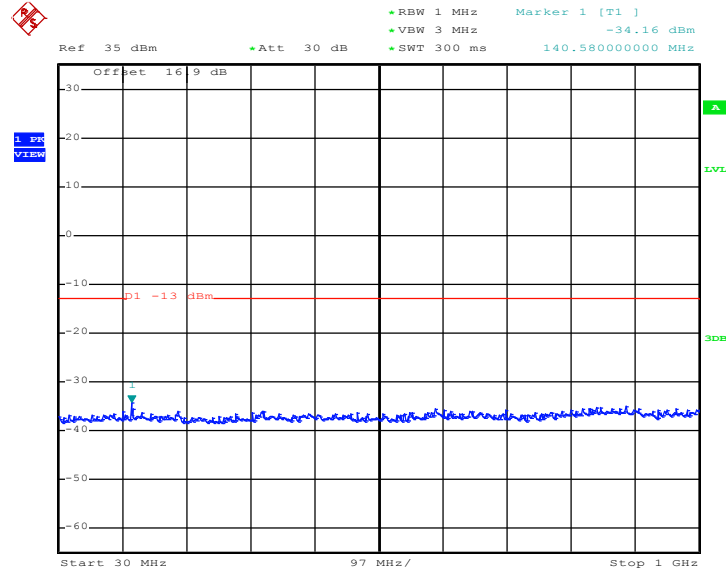

Date: 23.JUN.2014 14:38:20

Conducted Spurious Emission Plot between 1GHz ~ 3GHz

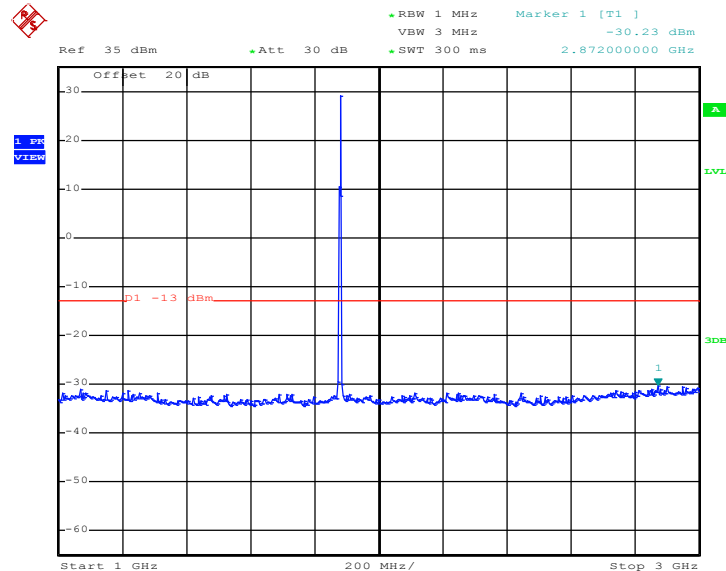

Date: 23.JUN.2014 14:38:33



Conducted Spurious Emission Plot between 3GHz ~ 7GHz

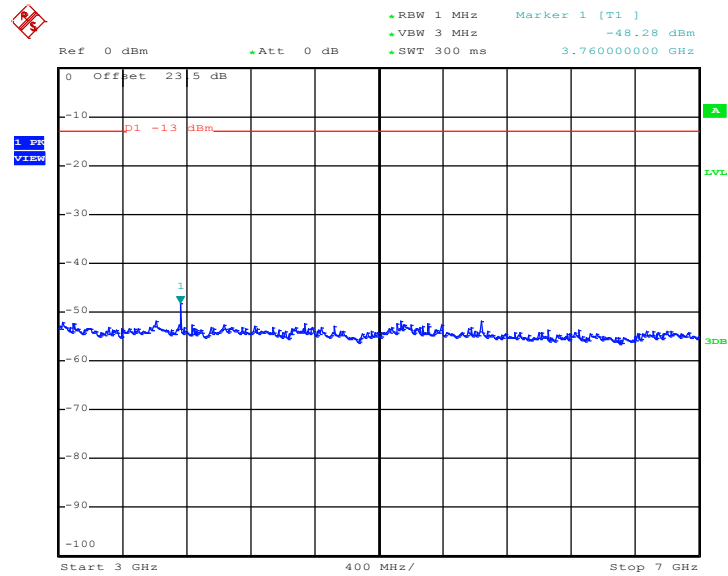

Date: 23.JUN.2014 14:38:40

Conducted Spurious Emission Plot between 7GHz ~ 13.6GHz

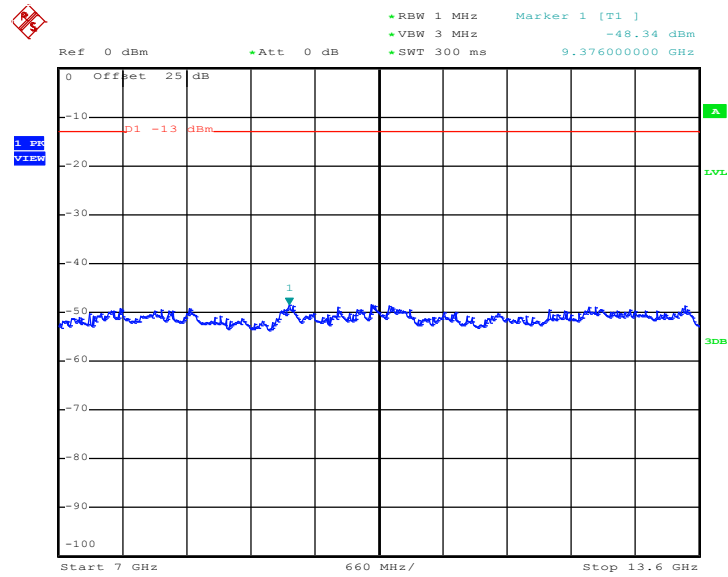

Date: 23.JUN.2014 14:38:48



Conducted Spurious Emission Plot between 13.6GHz ~ 19.1GHz

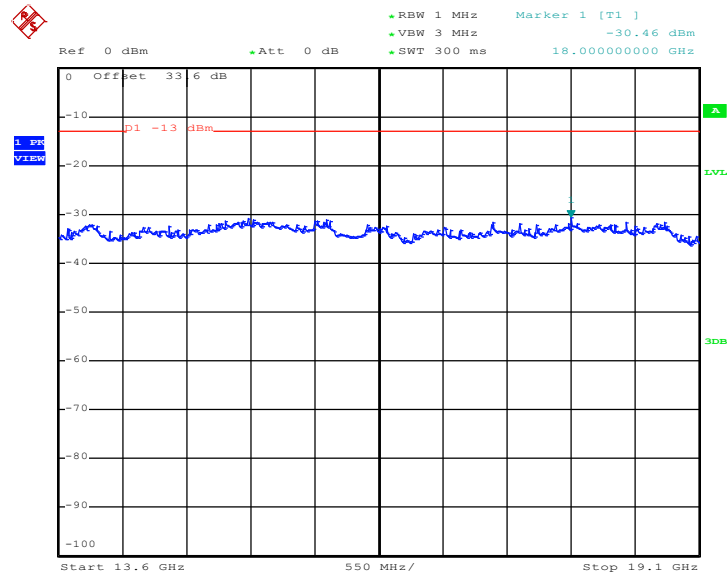

Date: 23.JUN.2014 14:38:57



3.7 Field Strength of Spurious Radiation Measurement

3.7.1 Description of Field Strength of Spurious Radiated Measurement

The power of any emission outside of the authorized operating frequency ranges must be attenuated below the transmitter power (P) by a factor of at least $43 + 10 \log (P)$ dB. The spectrum is scanned from 30 MHz up to a frequency including its 10th harmonic.

3.7.2 Measuring Instruments

The measuring equipment is listed in the section 4 of this test report.

3.7.3 Test Procedures

1. The EUT was placed on a rotatable wooden table 0.8 meters above the ground.
2. The EUT was set 3 meters from the receiving antenna, which was mounted on the antenna tower.
3. The table was rotated 360 degrees to determine the position of the highest spurious emission.
4. The height of the receiving antenna is varied between one meter and four meters to search for the maximum spurious emission for both horizontal and vertical polarizations.
5. Make the measurement with the spectrum analyzer's RBW = 1MHz, VBW = 3MHz, taking record of maximum spurious emission.
6. A horn antenna was substituted in place of the EUT and was driven by a signal generator.
7. Tune the output power of signal generator to the same emission level with EUT maximum spurious emission.
8. Taking the record of output power at antenna port.
9. Repeat step 7 to step 8 for another polarization.
10. $EIRP \text{ (dBm)} = S.G. \text{ Power} - Tx \text{ Cable Loss} + Tx \text{ Antenna Gain}$
11. $ERP \text{ (dBm)} = EIRP - 2.15$
12. The RF fundamental frequency should be excluded against the limit line in the operating frequency band.
13. The limit line is derived from $43 + 10\log(P)$ dB below the transmitter power P(Watts)
 $= P(W) - [43 + 10\log(P)] \text{ (dB)}$
 $= [30 + 10\log(P)] \text{ (dBm)} - [43 + 10\log(P)] \text{ (dB)}$
 $= -13\text{dBm}.$

3.7.4 Test Setup

For radiated emissions from 30MHz to 1GHz

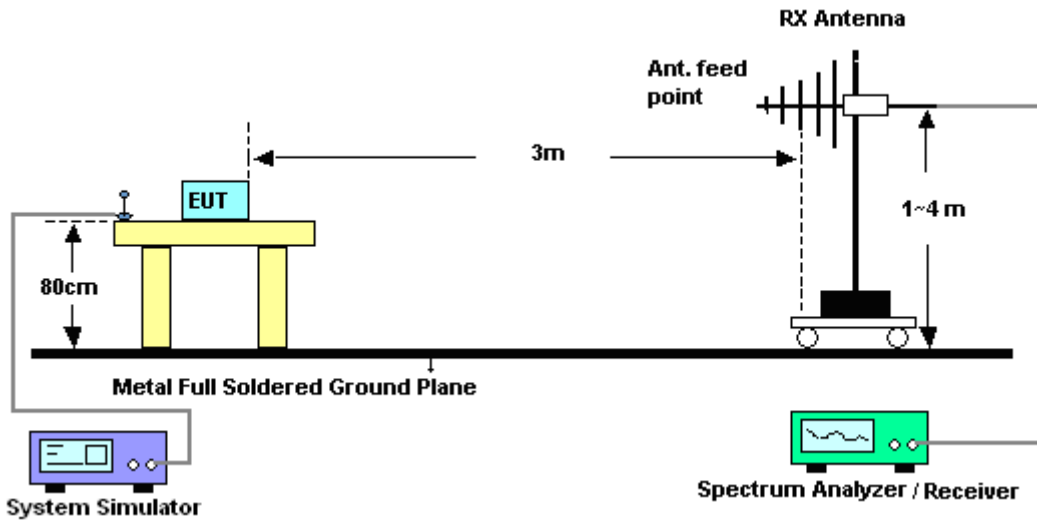

For radiated emissions above 1GHz

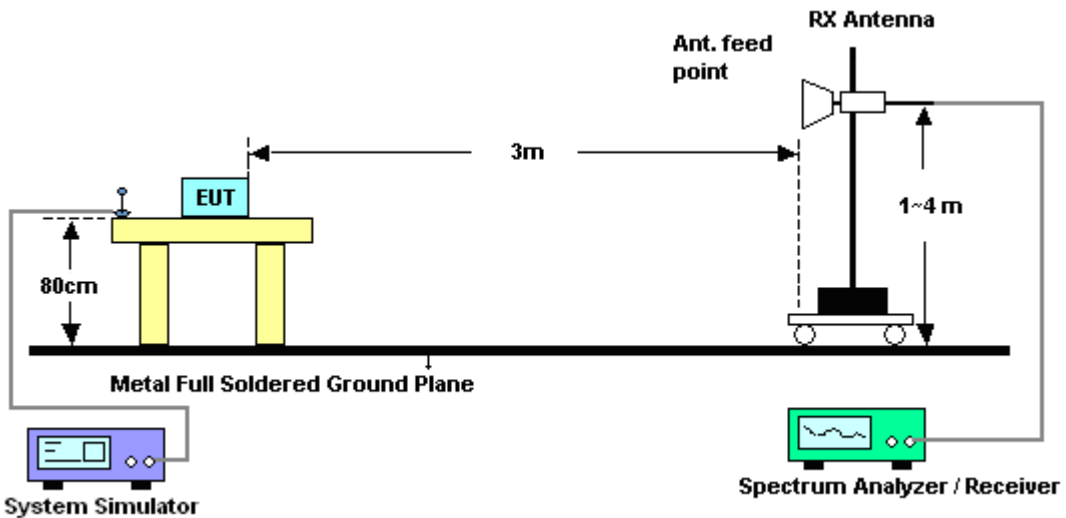



3.7.5 Test Result of Field Strength of Spurious Radiated

Band :	CDMA2000 BC0						Temperature :	23~25°C	
Test Mode :	1xEV-DO Rev. 0_RTAP 153.6K (QPSK)						Relative Humidity :	44~48%	
Test Engineer :	Eric Shih						Polarization :	Horizontal	
Remark :	Spurious emissions within 30-1000MHz were found more than 20dB below limit line.								
Frequency (MHz)	ERP (dBm)	Limit (dBm)	Over Limit (dB)	SPA Reading (dBm)	S.G. Power (dBm)	TX Cable loss (dB)	TX Antenna Gain (dBi)	Polarization (H/V)	Result
1672	-53.09	-13	-40.09	-62.35	-56.96	1.62	5.49	H	Pass
2509	-45.74	-13	-32.74	-58.73	-49.86	2.1	6.22	H	Pass
3345	-53.95	-13	-40.95	-69.05	-58.99	3.03	8.07	H	Pass

Band :	CDMA2000 BC0						Temperature :	23~25°C	
Test Mode :	1xEV-DO Rev. 0_RTAP 153.6K (QPSK)						Relative Humidity :	44~48%	
Test Engineer :	Eric Shih						Polarization :	Vertical	
Remark :	Spurious emissions within 30-1000MHz were found more than 20dB below limit line.								
Frequency (MHz)	ERP (dBm)	Limit (dBm)	Over Limit (dB)	SPA Reading (dBm)	S.G. Power (dBm)	TX Cable loss (dB)	TX Antenna Gain (dBi)	Polarization (H/V)	Result
1672	-52.76	-13	-39.76	-63.8	-56.63	1.62	5.49	V	Pass
2509	-49.23	-13	-36.23	-63.21	-53.35	2.1	6.22	V	Pass
3345	-52.37	-13	-39.37	-68.2	-57.41	3.03	8.07	V	Pass



Band :	CDMA2000 BC1	Temperature :	23~25°C						
Test Mode :	1xEV-DO Rev. 0_RTAP 153.6K (QPSK)	Relative Humidity :	44~48%						
Test Engineer :	Eric Shih	Polarization :	Horizontal						
Remark :	Spurious emissions within 30-1000MHz were found more than 20dB below limit line.								
Frequency (MHz)	EIRP (dBm)	Limit (dBm)	Over Limit (dB)	SPA Reading (dBm)	S.G. Power (dBm)	TX Cable loss (dB)	TX Antenna Gain (dBi)	Polarization (H/V)	Result
3760	-47.73	-13	-34.73	-62.72	-54.03	2.51	8.81	H	Pass
5640	-47.35	-13	-34.35	-68.33	-55.06	2.99	10.70	H	Pass
13160	-33.62	-13	-20.62	-66.54	-43.14	4.27	13.79	H	Pass

Band :	CDMA2000 BC1	Temperature :	23~25°C						
Test Mode :	1xEV-DO Rev. 0_RTAP 153.6K (QPSK)	Relative Humidity :	44~48%						
Test Engineer :	Eric Shih	Polarization :	Vertical						
Remark :	Spurious emissions within 30-1000MHz were found more than 20dB below limit line.								
Frequency (MHz)	EIRP (dBm)	Limit (dBm)	Over Limit (dB)	SPA Reading (dBm)	S.G. Power (dBm)	TX Cable loss (dB)	TX Antenna Gain (dBi)	Polarization (H/V)	Result
3760	-47.62	-13	-34.62	-63.56	-53.92	2.51	8.81	V	Pass
5640	-46.61	-13	-33.61	-68.25	-54.32	2.99	10.70	V	Pass
13160	-38.37	-13	-25.37	-70.04	-47.89	4.27	13.79	V	Pass



3.8 Frequency Stability Measurement

3.8.1 Description of Frequency Stability Measurement

The frequency stability shall be measured by variation of ambient temperature and variation of primary supply voltage to ensure that the fundamental emission stays within the authorized frequency block. The frequency stability of the transmitter shall be maintained within $\pm 0.00025\%$ ($\pm 2.5\text{ppm}$) of the center frequency.

3.8.2 Measuring Instruments

The measuring equipment is listed in the section 4 of this test report.

3.8.3 Test Procedures for Temperature Variation

1. The EUT was set up in the thermal chamber and connected with the system simulator.
2. With power OFF, the temperature was decreased to -30°C and the EUT was stabilized before testing. Power was applied and the maximum change in frequency was recorded within one minute.
3. With power OFF, the temperature was raised in 10°C steps up to 50°C . The EUT was stabilized at each step for at least half an hour. Power was applied and the maximum frequency change was recorded within one minute.

3.8.4 Test Procedures for Voltage Variation

1. The EUT was placed in a temperature chamber at $25\pm 5^{\circ}\text{C}$ and connected with the system simulator.
2. The power supply voltage to the EUT was varied from BEP to 115% of the nominal value measured at the input to the EUT.
3. The variation in frequency was measured for the worst case.

3.8.5 Test Setup

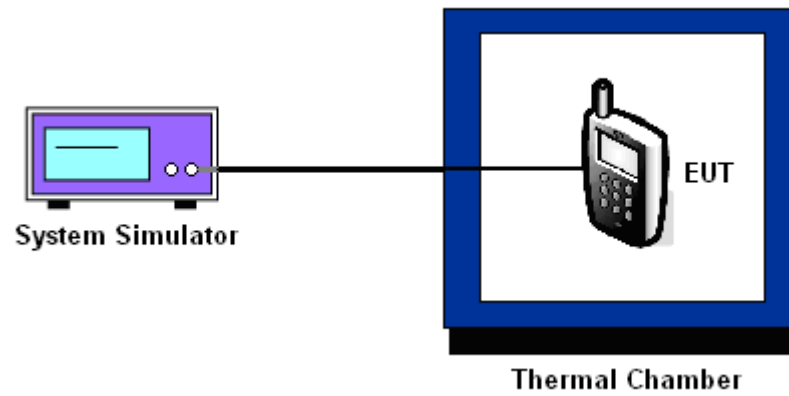



3.8.6 Test Result of Temperature Variation

Band :	CDMA2000 BC0 1xEV-DO Rev. 0_RTAP 153.6K	Channel :	384
Limit (ppm) :	2.5	Frequency :	836.52 MHz

Temperature (°C)	Deviation (ppm)	Result
50	0.0347	PASS
40	0.0323	
30	0.0024	
20(Ref.)	0.0000	
10	0.0024	
0	0.0036	
-10	0.0012	
-20	0.0012	
-30	0.0048	

Band :	CDMA2000 BC1 1xEV-DO Rev. 0_RTAP 153.6K	Channel :	600
Limit (ppm) :	2.5	Frequency :	1880.0 MHz

Temperature (°C)	Deviation (ppm)	Result
50	0.0027	PASS
40	0.0011	
30	0.0016	
20(Ref.)	0.0000	
10	0.0096	
0	0.0005	
-10	0.0005	
-20	0.0016	
-30	0.0021	



3.8.7 Test Result of Voltage Variation

Band & Channel	Mode	Voltage (Volt)	Deviation (ppm)	Limit (ppm)	Result
CDMA2000 BC0 CH384	1xEV-DO Rev. 0 RTAP 153.6K	4.35	0.0263	2.5	Pass
		3.80	0.0000		
		BEP	0.0012		
CDMA2000 BC1 CH600	1xEV-DO Rev. 0 RTAP 153.6K	4.35	0.0016		
		3.80	0.0011		
		BEP	0.0043		

Note:

- 1. Normal Voltage = 3.80V.
- 2. Battery End Point (BEP) = 3.60 V.



4 List of Measuring Equipment

Instrument	Manufacturer	Model No.	Serial No.	Characteristics	Calibration Date	Test Date	Due Date	Remark
System Simulator	Rohde & Schwarz	CMU200	117995	N/A	Aug. 01, 2013	Jun. 23, 2014	Jul. 31, 2014	Conducted (TH02-HY)
Spectrum Analyzer	Rohde & Schwarz	FSP40	100055	9kHz~40GHz	Jun. 09, 2014	Jun. 23, 2014	Jun. 08, 2015	Conducted (TH02-HY)
Thermal Chamber	Ten Billion	TTH-D3SP	TBN-930701	N/A	Jul. 19, 2013	Jun. 23, 2014	Jul. 18, 2014	Conducted (TH02-HY)
Spectrum Analyzer	Rohde & Schwarz	FSV30	101749	10Hz ~ 30GHz	Feb. 10, 2014	Jul. 12, 2014	Feb. 09, 2015	Radiation (03CH07-HY)
Bilog Antenna	Schaffner	CBL6111C	2726	30MHz ~ 1GHz	Oct. 10, 2013	Jul. 12, 2014	Oct. 09, 2014	Radiation (03CH07-HY)
Double Ridge Horn Antenna	ESCO	3117	75962	1GHz~18GHz	Aug. 22, 2013	Jul. 12, 2014	Aug. 21, 2014	Radiation (03CH07-HY)
Preamplifier	COM-POWER	PA-103A	161241	10 MHz ~ 1000MHz	Mar. 17, 2014	Jul. 12, 2014	Mar. 16, 2015	Radiation (03CH07-HY)
Preamplifier	Agilent	8449B	3008A02362	1 GHz~26.5 GHz	Nov. 29, 2013	Jul. 12, 2014	Nov. 28, 2014	Radiation (03CH07-HY)
Turn Table	ChainTek	ChainTek 3000	N/A	0 ~ 360 degree	N/A	Jul. 12, 2014	N/A	Radiation (03CH07-HY)
Antenna Mast	ChainTek	M-400-0	114/8000604/L	N/A	N/A	Jul. 12, 2014	N/A	Radiation (03CH07-HY)
SHF-EHF Horn Antenna	SCHWARZBECK	BBHA 9170	BBHA9170251	15GHz- 40GHz	Oct. 03, 2013	Jul. 12, 2014	Oct. 02, 2014	Radiation (03CH07-HY)



5 Uncertainty of Evaluation

Uncertainty of Radiated Emission Measurement (30 MHz ~ 1000 MHz)

Measuring Uncertainty for a Level of Confidence of 95% ($U = 2Uc(y)$)	4.50
---	------