



FCC RF Test Report

APPLICANT : HTC Corporation
EQUIPMENT : Smartphone
MODEL NAME : 0P9O110
FCC ID : NM80P9O110
STANDARD : FCC 47 CFR Part 2, 22(H), 24(E)
CLASSIFICATION : PCS Licensed Transmitter Held to Ear (PCE)

The product was received on Feb. 11, 2014 and testing was completed on Feb. 22, 2014. We, SPORTON INTERNATIONAL INC., would like to declare that the tested sample has been evaluated in accordance with the procedures given in ANSI / TIA / EIA-603-C-2004 and shown to be compliant with the applicable technical standards.

The test results in this report apply exclusively to the tested model / sample. Without written approval of SPORTON INTERNATIONAL INC., the test report shall not be reproduced except in full.

Reviewed by: Joseph Lin / Supervisor

Approved by: Jones Tsai / Manager



SPORTON INTERNATIONAL INC.

No. 52, Hwa Ya 1st Rd., Hwa Ya Technology Park, Kwei-Shan Hsiang, Tao Yuan Hsien, Taiwan, R.O.C.

SPORTON INTERNATIONAL INC.
TEL : 886-3-327-3456
FAX : 886-3-328-4978
FCC ID : NM80P9O110

Page Number : 1 of 94
Report Issued Date : Apr. 21, 2014
Report Version : Rev. 01



TABLE OF CONTENTS

REVISION HISTORY..... 3

SUMMARY OF TEST RESULT 4

1 GENERAL DESCRIPTION 5

 1.1 Applicant..... 5

 1.2 Manufacturer 5

 1.3 Feature of Equipment Under Test..... 5

 1.4 Product Specification of Equipment Under Test 6

 1.5 Modification of EUT 6

 1.6 Maximum ERP/EIRP Power, Frequency Tolerance, and Emission Designator 6

 1.7 Testing Site..... 7

 1.8 Applied Standards 7

2 TEST CONFIGURATION OF EQUIPMENT UNDER TEST 8

 2.1 Test Mode..... 8

 2.2 Connection Diagram of Test System 10

 2.3 Support Unit used in test configuration and system 10

 2.4 Measurement Results Explanation Example 10

3 TEST RESULT 11

 3.1 Conducted Output Power Measurement 11

 3.2 Peak-to-Average Ratio 13

 3.3 Effective Radiated Power and Effective Isotropic Radiated Power Measurement 27

 3.4 99% Occupied Bandwidth and 26dB Bandwidth Measurement..... 32

 3.5 Band Edge Measurement..... 52

 3.6 Conducted Spurious Emission Measurement 59

 3.7 Field Strength of Spurious Radiation Measurement 75

 3.8 Frequency Stability Measurement..... 89

4 LIST OF MEASURING EQUIPMENT 93

5 UNCERTAINTY OF EVALUATION 94



SUMMARY OF TEST RESULT

Report Section	FCC Rule	IC Rule	Description	Limit	Result	Remark
3.1	§2.1046	RSS-132 (5.4) RSS-133 (6.4)	Conducted Output Power	N/A	PASS	-
3.2	§24.232(d)	RSS-132 (5.4) RSS-133(6.4)	Peak-to-Average Ratio	< 13 dB	PASS	-
3.3	§22.913(a)(2)	RSS-132(5.4) SRSP-503(5.1.3)	Effective Radiated Power	< 7 Watts	PASS	-
3.3	§24.232(c)	RSS-133 (6.4) SRSP-510(5.1.2)	Equivalent Isotropic Radiated Power	< 2 Watts	PASS	-
3.4	§2.1049 §22.917(b) §24.238(b)	RSS-GEN(4.6.1) RSS-133(2.3)	Occupied Bandwidth	N/A	PASS	-
3.5	§2.1051 §22.917(a) §24.238(a)	RSS-132 (5.5) RSS-133 (6.5)	Band Edge Measurement	< 43+10log ₁₀ (P[Watts])	PASS	-
3.6	§2.1051 §22.917(a) §24.238(a)	RSS-132 (5.5) RSS-133 (6.5)	Conducted Spurious Emission	< 43+10log ₁₀ (P[Watts])	PASS	-
3.7	§2.1053 §22.917(a) §24.238(a)	RSS-132 (5.5) RSS-133 (6.5)	Field Strength of Spurious Radiation	< 43+10log ₁₀ (P[Watts])	PASS	Under limit 25.49 dB at 5640.000 MHz
3.8	§2.1055 §22.355 §24.235	RSS-132(5.3) RSS-133(6.3)	Frequency Stability for Temperature & Voltage	< 2.5 ppm	PASS	-



1 General Description

1.1 Applicant

HTC Corporation

No. 23, Xinghua Rd., Taoyuan City, Taoyuan County 330, Taiwan.

1.2 Manufacturer

HTC Corporation

No. 23, Xinghua Rd., Taoyuan City, Taoyuan County 330, Taiwan.

1.3 Feature of Equipment Under Test

Product Feature	
Equipment	Smartphone
Model Name	0P9O110
FCC ID	NM80P9O110
Sample 1	EUT with LCM1, Camera Front, Camera Back, Battery 1
Sample 2	EUT with LCM2, Camera Front, Camera Back, Battery 2
EUT supports Radios application	GSM/EGPRS/WCDMA/HSPA/LTE WLAN 11b/g/n(HT20) Bluetooth v3.0+HS/ v4.0-LE
EUT Stage	Identical Prototype

Remark:

1. The above EUT's information was declared by manufacturer. Please refer to the specifications or user's manual for more detailed description.
2. All tests were performed with sample 1.

1.4 Product Specification of Equipment Under Test

Product Specification subjective to this standard	
Tx Frequency	GSM850: 824.2 MHz ~ 848.8 MHz GSM1900: 1850.2 MHz ~ 1909.8MHz WCDMA Band V: 826.4 MHz ~ 846.6 MHz WCDMA Band II: 1852.4 MHz ~ 1907.6 MHz
Rx Frequency	GSM850: 869.2 MHz ~ 893.8 MHz GSM1900: 1930.2 MHz ~ 1989.8 MHz WCDMA Band V: 871.4 MHz ~ 891.6 MHz WCDMA Band II: 1932.4 MHz ~ 1987.6 MHz
Maximum Output Power to Antenna	GSM850 : 33.64 dBm GSM1900 : 30.23 dBm WCDMA Band V : 23.71 dBm WCDMA Band II : 23.92 dBm
Antenna Type	PIFA Antenna
Type of Modulation	GSM: GMSK GPRS: GMSK EDGE: GMSK / 8PSK WCDMA: QPSK (Uplink) HSDPA: QPSK (Uplink) HSUPA: QPSK (Uplink)

1.5 Modification of EUT

No modifications are made to the EUT during all test items.

1.6 Maximum ERP/EIRP Power, Frequency Tolerance, and Emission Designator

FCC Rule	System	Type of Modulation	Maximum ERP/EIRP (W)	Frequency Tolerance (ppm)	Emission Designator
Part 22	GSM850 GPRS class 8	GMSK	0.75	0.0478 ppm	246KGXW
Part 22	GSM850 EDGE class 8	8PSK	0.19	0.0359 ppm	244KG7W
Part 22	WCDMA Band V RMC 12.2Kbps	QPSK	0.09	0.0132 ppm	4M16F9W
Part 24	GSM1900 GPRS class 8	GMSK	0.74	0.0356 ppm	246KGXW
Part 24	GSM1900 EDGE class 8	8PSK	0.28	0.0399 ppm	246KG7W
Part 24	WCDMA Band II RMC 12.2Kbps	QPSK	0.17	0.0074 ppm	4M16F9W



1.7 Testing Site

Test Site	SPORTON INTERNATIONAL INC.		
Test Site Location	No. 52, Hwa Ya 1 st Rd., Hwa Ya Technology Park, Kwei-Shan Hsiang, Tao Yuan Hsien, Taiwan, R.O.C. TEL: +886-3-327-3456 FAX: +886-3-328-4978		
Test Site No.	Sporton Site No.		FCC/IC Registration No.
	TH02-HY	03CH07-HY	722060/4086B-1

1.8 Applied Standards

According to the specifications of the manufacturer, the EUT must comply with the requirements of the following standards:

- ♦ FCC 47 CFR Part 2, 22(H), 24(E)
- ♦ ANSI / TIA / EIA-603-C-2004
- ♦ FCC KDB 971168 D01 Power Meas. License Digital Systems v02r01

Remark:

1. All test items were verified and recorded according to the standards and without any deviation during the test.
2. This EUT has also been tested and complied with the requirements of FCC Part 15, Subpart B, recorded in a separate test report.

2 Test Configuration of Equipment Under Test

2.1 Test Mode

During all testing, EUT is in link mode with base station emulator at maximum power level. The spurious emission measurements were carried out in semi-anechoic chamber with 3-meter test range.

Frequency range investigated for radiated emission is as follows:

1. 30 MHz to 9000 MHz for GSM850 and WCDMA Band V.
2. 30 MHz to 19000 MHz for GSM1900 and WCDMA Band II.

Test Modes		
Band	Radiated TCs	Conducted TCs
GSM 850	<ul style="list-style-type: none"> ■ GPRS class 8 Link ■ EDGE class 8 Link 	<ul style="list-style-type: none"> ■ GPRS class 8 Link ■ EDGE class 8 Link
GSM 1900	<ul style="list-style-type: none"> ■ GPRS class 8 Link ■ EDGE class 8 Link 	<ul style="list-style-type: none"> ■ GPRS class 8 Link ■ EDGE class 8 Link
WCDMA Band V	<ul style="list-style-type: none"> ■ RMC 12.2Kbps Link 	<ul style="list-style-type: none"> ■ RMC 12.2Kbps Link
WCDMA Band II	<ul style="list-style-type: none"> ■ RMC 12.2Kbps Link 	<ul style="list-style-type: none"> ■ RMC 12.2Kbps Link

Note:

1. The maximum power levels are GSM or GPRS multi-slot class 8 mode for GMSK link, EDGE multi-slot class 8 mode for 8PSK link, RMC 12.2Kbps mode for WCDMA band V, and RMC 12.2Kbps mode for WCDMA band II, only these modes were used for all tests.
2. Because there are individual antennas for each WWAN, WLAN, and Bluetooth, the co-location test modes are not required.
3. For Radiated TCs, the tests were performed with earphone 1, USB cable 1, and adapter 1.



The conducted power tables are as follows:

Conducted Power (*Unit: dBm)						
Band	GSM850			GSM1900		
Channel	128	189	251	512	661	810
Frequency	824.2	836.4	848.8	1850.2	1880.0	1909.8
GSM	33.52	33.50	33.45	29.91	29.95	30.06
GPRS class 8	33.64	33.61	33.51	30.08	30.15	30.23
GPRS class 10	30.94	30.92	30.74	28.14	28.22	28.30
EGPRS class 8	27.35	27.32	27.30	25.78	25.84	25.93
EGPRS class 10	26.35	26.34	26.28	24.81	24.86	24.95

Conducted Power (*Unit: dBm)						
Band	WCDMA Band V			WCDMA Band II		
Channel	4132	4182	4233	9262	9400	9538
Frequency	826.4	836.4	846.6	1852.4	1880.0	1907.6
RMC 12.2K	23.26	23.71	23.62	23.92	23.18	23.63
HSDPA Subtest-1	22.36	22.73	22.70	22.90	22.24	22.70
HSDPA Subtest-2	22.33	22.72	22.71	22.89	22.27	22.64
HSDPA Subtest-3	21.89	22.26	22.16	22.49	21.81	22.28
HSDPA Subtest-4	21.88	22.31	22.14	22.46	21.76	22.18
HSUPA Subtest-1	22.07	22.18	22.09	22.66	22.13	22.58
HSUPA Subtest-2	21.44	21.70	21.58	21.62	21.22	21.50
HSUPA Subtest-3	21.46	21.66	21.54	21.57	21.12	21.34
HSUPA Subtest-4	21.67	21.83	21.76	21.71	21.44	21.62
HSUPA Subtest-5	22.40	22.78	22.70	22.99	22.24	22.74

2.2 Connection Diagram of Test System

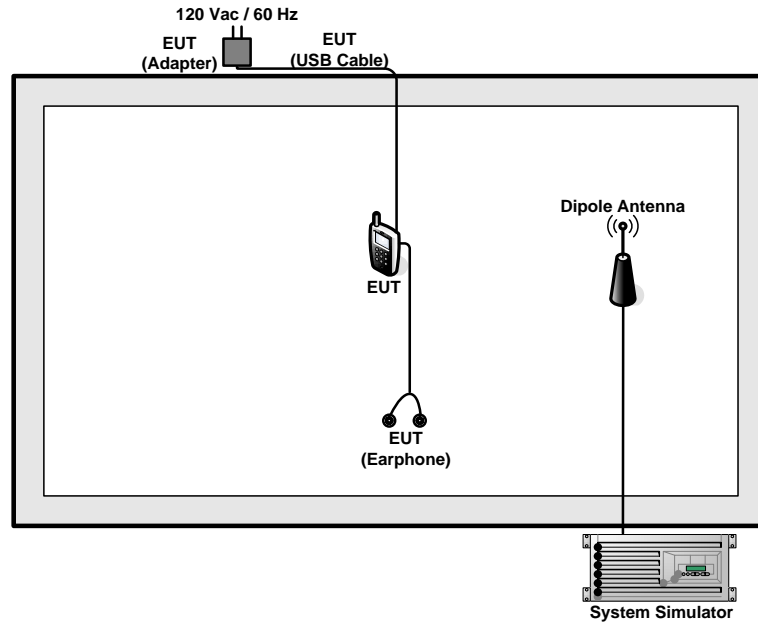

2.3 Support Unit used in test configuration and system

Item	Equipment	Trade Name	Model No.	FCC ID	Data Cable	Power Cord
1.	System Simulator	R&S	CMU 200	N/A	N/A	Unshielded, 1.8 m

2.4 Measurement Results Explanation Example

For all conducted test items:

The offset level is set in the spectrum analyzer to compensate the RF cable loss and attenuator factor between EUT conducted output port and spectrum analyzer. With the offset compensation, the spectrum analyzer reading level is exactly the EUT RF output level.

The spectrum analyzer offset is derived from RF cable loss and attenuator factor.

Offset = RF cable loss + attenuator factor.

Following shows an offset computation example with cable loss 4.2 dB and 10dB attenuator.

Example :

$$\begin{aligned} \text{Offset(dB)} &= \text{RF cable loss(dB)} + \text{attenuator factor(dB)}. \\ &= 4.2 + 10 = 14.2 \text{ (dB)} \end{aligned}$$

3 Test Result

3.1 Conducted Output Power Measurement

3.1.1 Description of the Conducted Output Power Measurement

A base station simulator was used to establish communication with the EUT. Its parameters were set to transmit the maximum power on the EUT. The measured power in the radio frequency on the transmitter output terminals shall be reported.

3.1.2 Measuring Instruments

The measuring equipment is listed in the section 4 of this test report.

3.1.3 Test Procedures

1. The transmitter output port was connected to base station.
2. Set EUT at maximum power through base station.
3. Select lowest, middle, and highest channels for each band and different modulation.
4. Measure the maximum burst average power for GSM and maximum average power for other modulation signal.

3.1.4 Test Setup

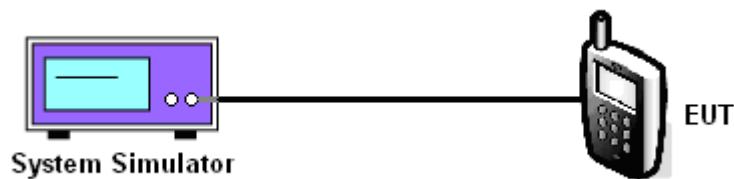



3.1.5 Test Result of Conducted Output Power

Cellular Band									
Modes	GSM850 (GPRS class 8)			GSM850 (EDGE class 8)			WCDMA Band V (RMC 12.2Kbps)		
Channel	128 (Low)	189 (Mid)	251 (High)	128 (Low)	189 (Mid)	251 (High)	4132 (Low)	4182 (Mid)	4233 (High)
Frequency (MHz)	824.2	836.4	848.8	824.2	836.4	848.8	826.4	836.4	846.6
Conducted Power (dBm)	33.64	33.61	33.51	27.35	27.32	27.30	23.26	23.71	23.62
Conducted Power (Watts)	2.31	2.30	2.24	0.54	0.54	0.54	0.21	0.23	0.23

PCS Band									
Modes	GSM1900 (GPRS class 8)			GSM1900 (EDGE class 8)			WCDMA Band II (RMC 12.2Kbps)		
Channel	512 (Low)	661 (Mid)	810 (High)	512 (Low)	661 (Mid)	810 (High)	9262 (Low)	9400 (Mid)	9538 (High)
Frequency (MHz)	1850.2	1880	1909.8	1850.2	1880	1909.8	1852.4	1880	1907.6
Conducted Power (dBm)	30.08	30.15	30.23	25.78	25.84	25.93	23.92	23.18	23.63
Conducted Power (Watts)	1.02	1.04	1.05	0.38	0.38	0.39	0.25	0.21	0.23

Note: maximum burst average power for GPRS, and maximum average power for WCDMA.

3.2 Peak-to-Average Ratio

3.2.1 Description of the PAR Measurement

The peak-to-average ratio (PAR) of the transmission may not exceed 13 dB.

3.2.2 Measuring Instruments

The measuring equipment is listed in the section 4 of this test report.

3.2.3 Test Procedures

1. The EUT was connected to Spectrum Analyzer and System Simulator via power divider.
2. For GSM/EGPRS operating modes:
 - a. Set EUT in maximum power output.
 - b. Set the RBW = 1MHz, VBW = 3MHz, Peak detector in spectrum analyzer for first trace.
 - c. Set the RBW = 1MHz, VBW = 3MHz, RMS detector in spectrum analyzer for second trace.
 - d. The wanted burst signal is triggered by spectrum analyzer, and measured respectively the peak level and Mean level without burst-off time, after system simulator synchronized with the spectrum analyzer.
3. For UMTS operating modes:
 - a. Set the CCDF (Complementary Cumulative Distribution Function) option in spectrum analyzer.
 - b. The highest RF powers were measured and recorded the maximum PAPR level associated with a probability of 0.1 %.
4. Record the deviation as Peak to Average Ratio.

3.2.4 Test Setup

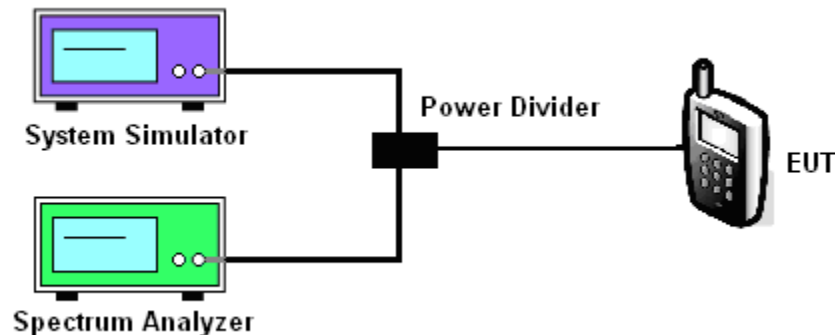



3.2.5 Test Result of Peak-to-Average Ratio

Cellular Band									
Modes	GSM850 (GPRS class 8)			GSM850 (EDGE class 8)			WCDMA Band V (RMC 12.2Kbps)		
Channel	128 (Low)	189 (Mid)	251 (High)	128 (Low)	189 (Mid)	251 (High)	4132 (Low)	4182 (Mid)	4233 (High)
Frequency (MHz)	824.2	836.4	848.8	824.2	836.4	848.8	826.4	836.4	846.6
Peak-to-Average Ratio (dB)	0.24	0.28	0.33	2.75	2.65	2.74	3.24	3.32	3.32

PCS Band									
Modes	GSM1900 (GPRS class 8)			GSM1900 (EDGE class 8)			WCDMA Band II (RMC 12.2Kbps)		
Channel	512 (Low)	661 (Mid)	810 (High)	512 (Low)	661 (Mid)	810 (High)	9262 (Low)	9400 (Mid)	9538 (High)
Frequency (MHz)	1850.2	1880	1909.8	1850.2	1880	1909.8	1852.4	1880	1907.6
Peak-to-Average Ratio (dB)	0.31	0.38	0.35	2.74	2.86	2.77	3.12	3.32	3.20



3.2.6 Test Result (Plots) of Peak-to-Average Ratio

Band :	GSM 850	Test Mode :	GPRS class 8 Link (GMSK)
--------	---------	-------------	--------------------------

Peak-to-Average Ratio on Channel 128 (824.2 MHz)

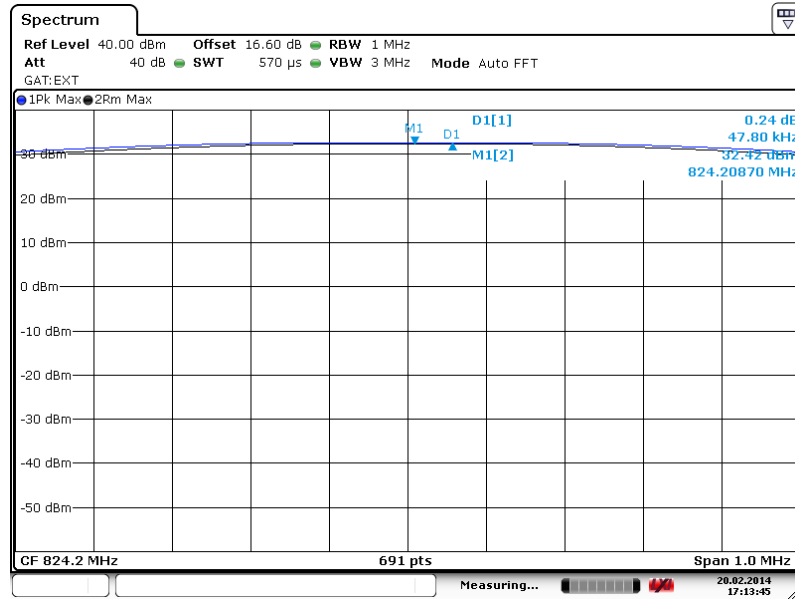

Date: 20.FEB.2014 17:13:45

Peak-to-Average Ratio on Channel 189 (836.4 MHz)

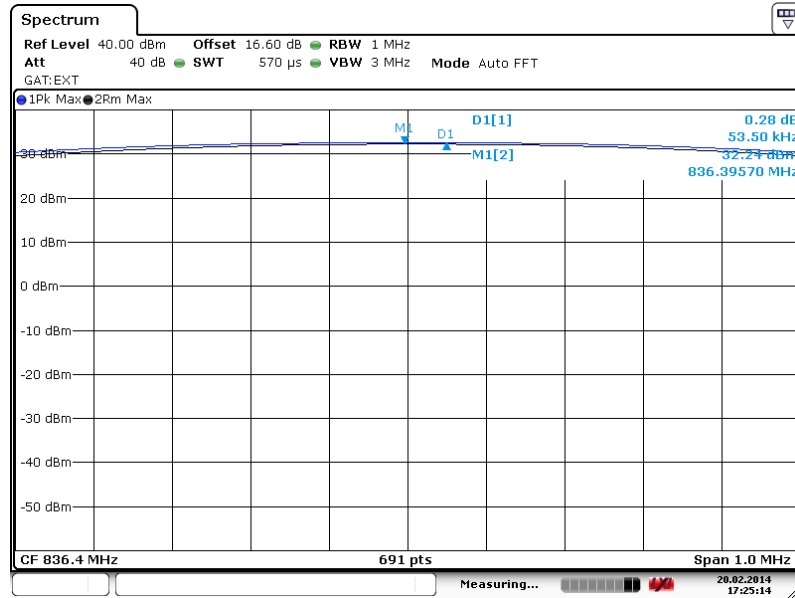

Date: 20.FEB.2014 17:25:14



Peak-to-Average Ratio on Channel 251 (848.8 MHz)

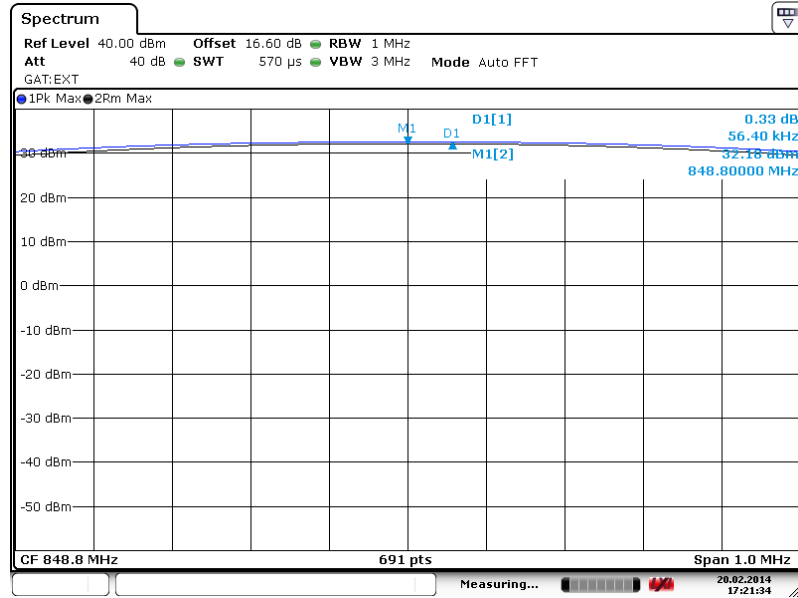

Date: 20.FEB.2014 17:21:35



Band :	GSM 850	Test Mode :	EDGE class 8 Link (8PSK)
--------	---------	-------------	--------------------------

Peak-to-Average Ratio on Channel 128 (824.2 MHz)

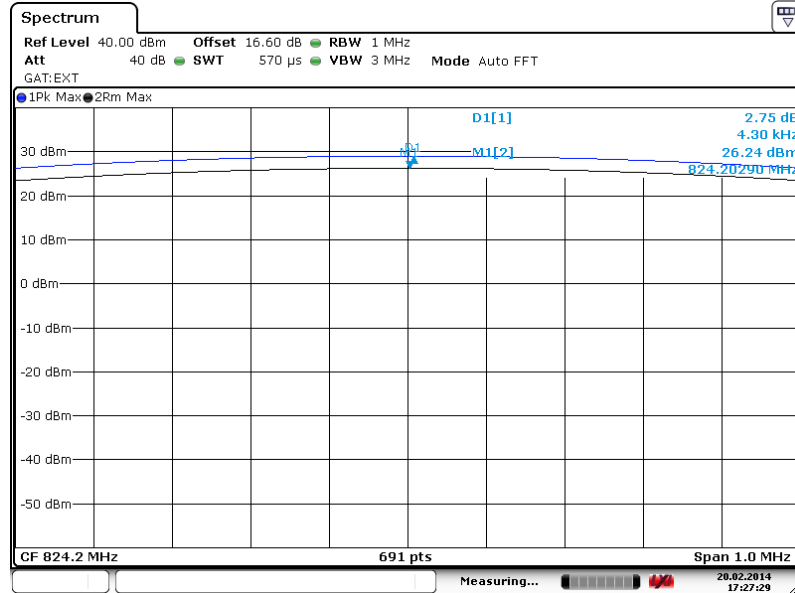

Date: 20.FEB.2014 17:27:30

Peak-to-Average Ratio on Channel 189 (836.4 MHz)

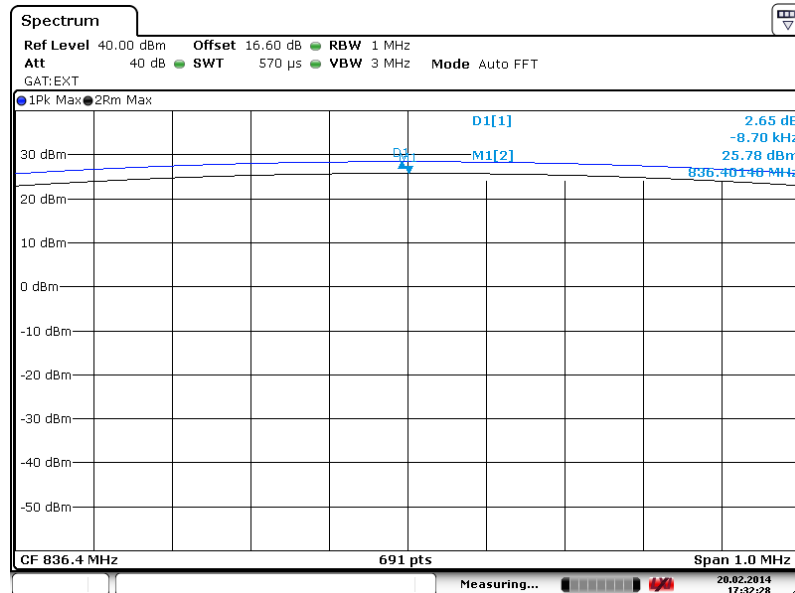

Date: 20.FEB.2014 17:32:29



Peak-to-Average Ratio on Channel 251 (848.8 MHz)

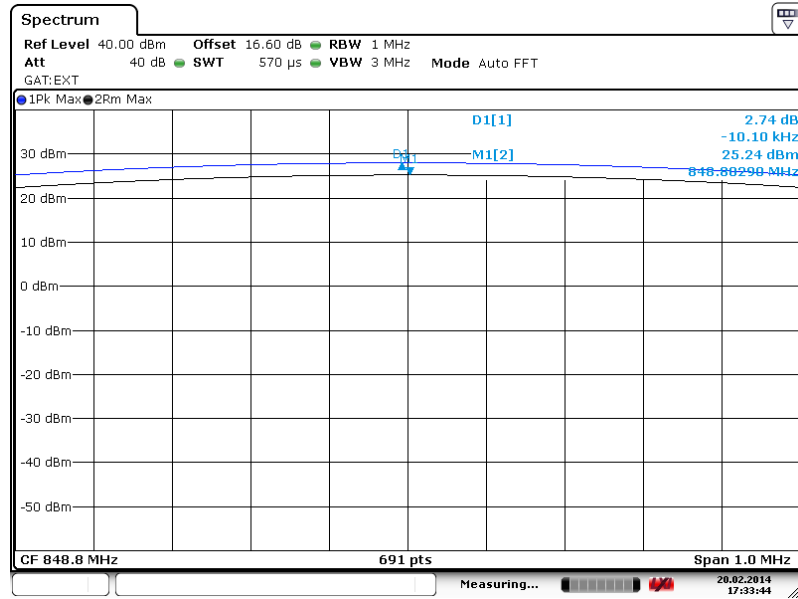

Date: 20.FEB.2014 17:33:45



Band :	GSM 1900	Test Mode :	GPRS class 8 Link (GMSK)
--------	----------	-------------	--------------------------

Peak-to-Average Ratio on Channel 512 (1850.2 MHz)

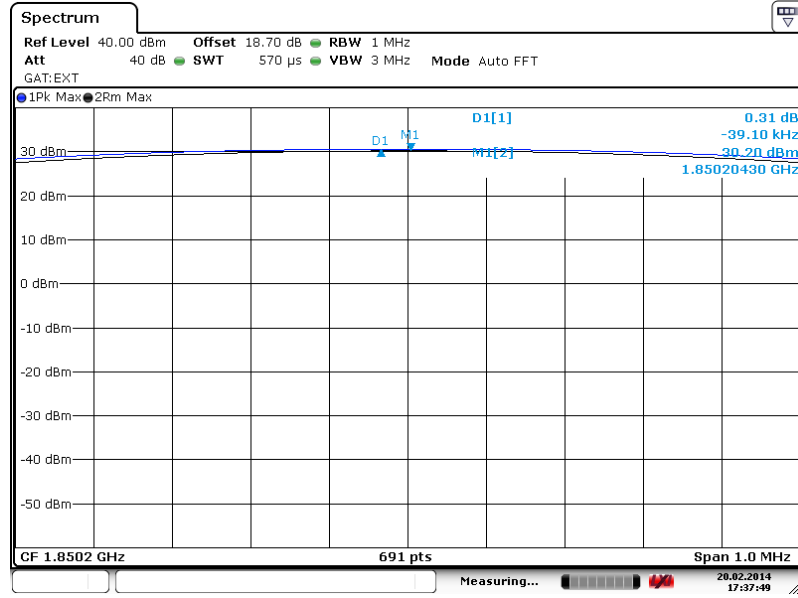

Date: 20.FEB.2014 17:37:49

Peak-to-Average Ratio on Channel 661 (1880.0 MHz)

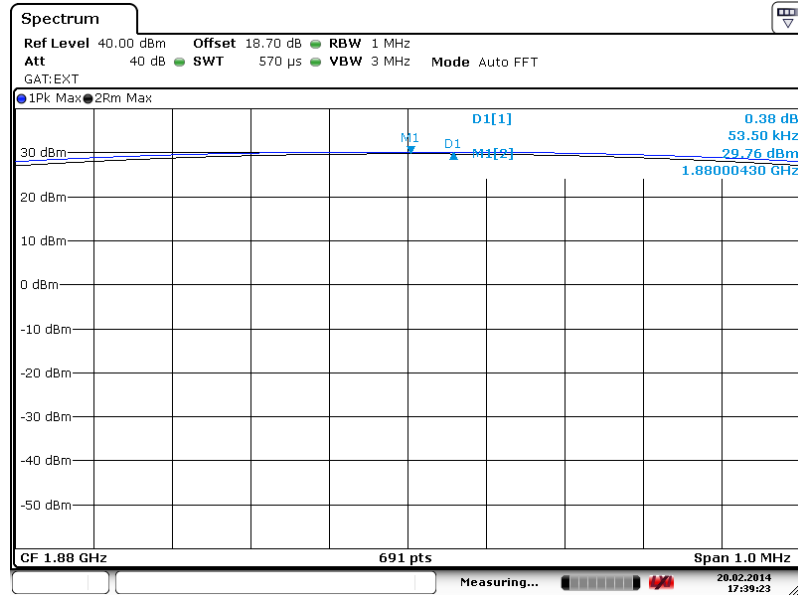

Date: 20.FEB.2014 17:39:23



Peak-to-Average Ratio on Channel 810 (1909.8 MHz)

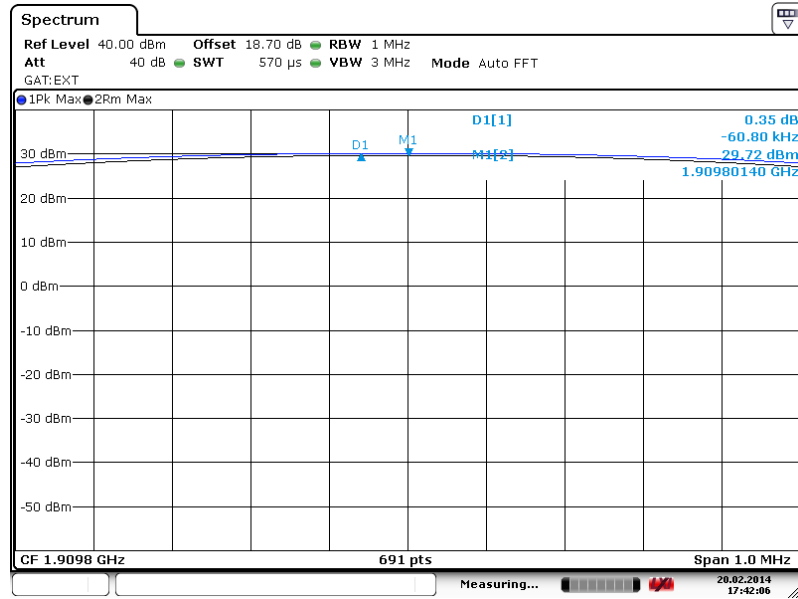

Date: 20.FEB.2014 17:42:06



Band :	GSM 1900	Test Mode :	EDGE class 8 Link (8PSK)
---------------	----------	--------------------	--------------------------

Peak-to-Average Ratio on Channel 512 (1850.2 MHz)

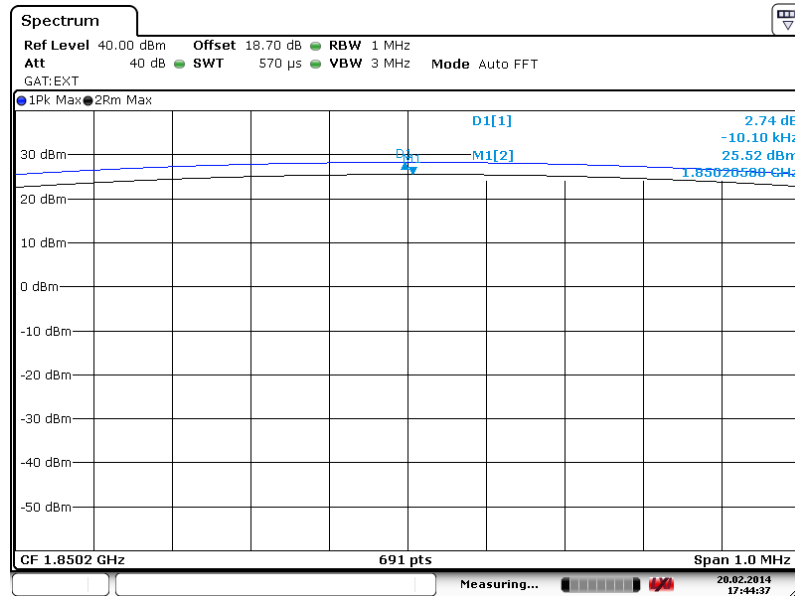

Peak-to-Average Ratio on Channel 661 (1880.0 MHz)

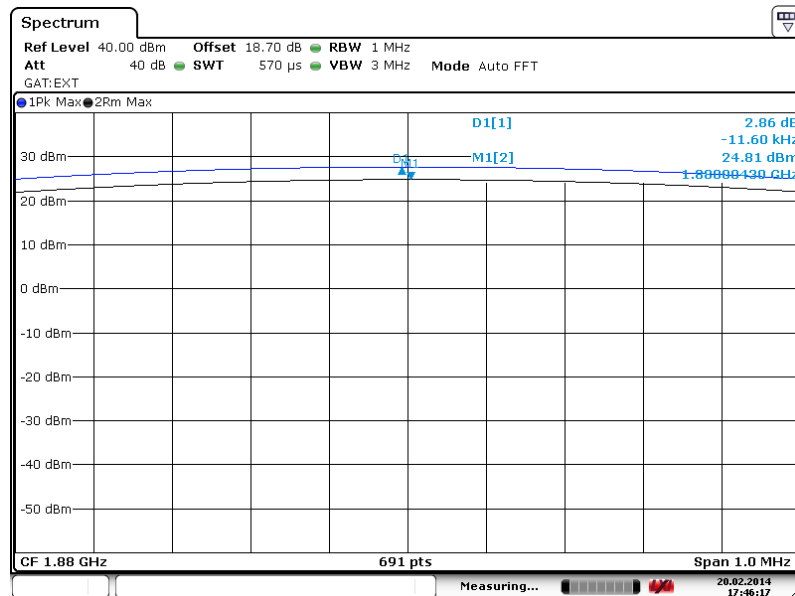



Band :	WCDMA Band V	Test Mode :	RMC 12.2Kbps Link (QPSK)
---------------	--------------	--------------------	--------------------------

Peak-to-Average Ratio on Channel 4132 (826.4 MHz)

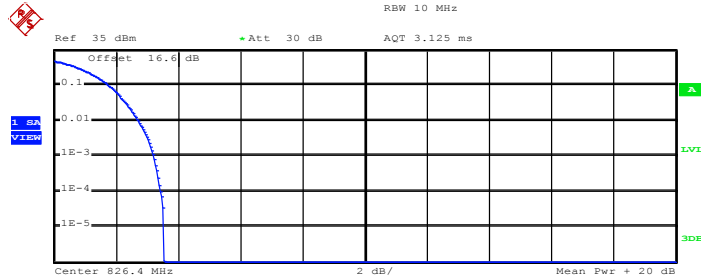

Complementary Cumulative Distribution Function (100000 samples)

Trace 1
Mean 20.56 dBm
Peak 24.10 dBm
Crest 3.55 dB

10 %	1.80 dB
1 %	2.72 dB
.1 %	3.24 dB
.01 %	3.44 dB

Date: 20.FEB.2014 14:45:40

Peak-to-Average Ratio on Channel 4182 (836.4 MHz)

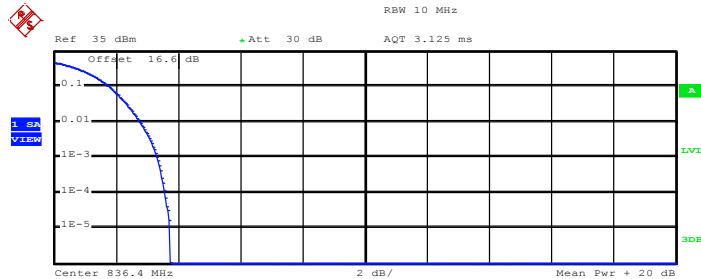

Complementary Cumulative Distribution Function (100000 samples)

Trace 1
Mean 20.14 dBm
Peak 23.89 dBm
Crest 3.75 dB

10 %	1.80 dB
1 %	2.76 dB
.1 %	3.32 dB
.01 %	3.60 dB

Date: 20.FEB.2014 14:46:29



Peak-to-Average Ratio on Channel 4233 (846.6 MHz)

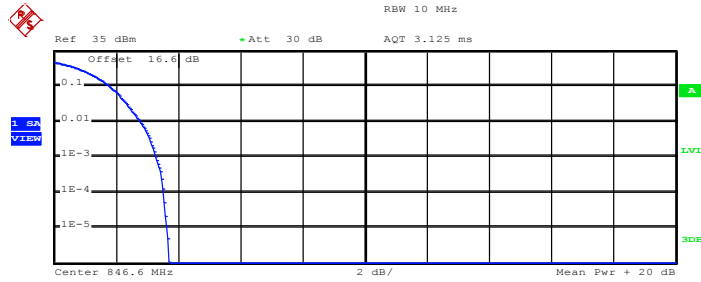

Complementary Cumulative Distribution Function (100000 samples)

Trace 1
 Mean 20.04 dBm
 Peak 23.75 dBm
 Crest 3.71 dB

10 %	1.80 dB
1 %	2.80 dB
.1 %	3.32 dB
.01 %	3.52 dB

Date: 20.FEB.2014 14:47:03



Band :	WCDMA Band II	Test Mode :	RMC 12.2Kbps Link (QPSK)
---------------	---------------	--------------------	--------------------------

Peak-to-Average Ratio on Channel 9262 (1852.4 MHz)

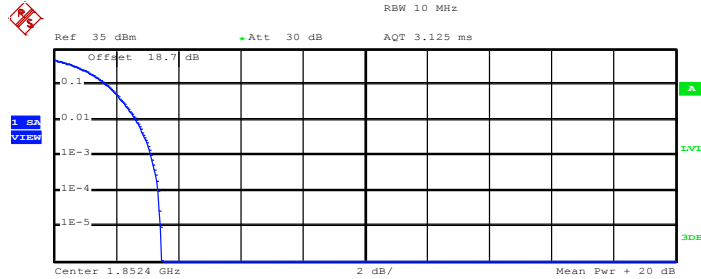

Complementary Cumulative Distribution Function (100000 samples)

Trace 1
 Mean 24.02 dBm
 Peak 27.49 dBm
 Crest 3.47 dB

10 %	1.72 dB
1 %	2.64 dB
.1 %	3.12 dB
.01 %	3.36 dB

Date: 20.FEB.2014 13:43:04

Peak-to-Average Ratio on Channel 9400 (1880.0 MHz)

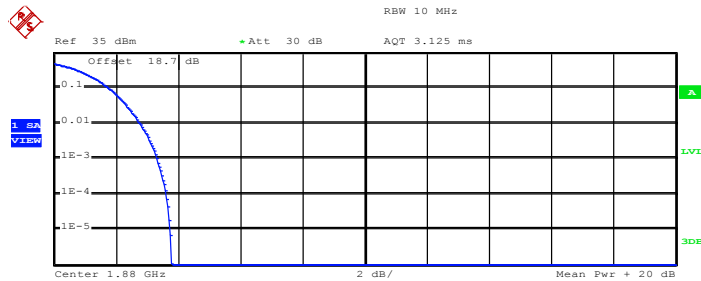

Complementary Cumulative Distribution Function (100000 samples)

Trace 1
 Mean 23.71 dBm
 Peak 27.49 dBm
 Crest 3.78 dB

10 %	1.76 dB
1 %	2.76 dB
.1 %	3.32 dB
.01 %	3.64 dB

Date: 20.FEB.2014 13:43:49



Peak-to-Average Ratio on Channel 9538 (1907.6 MHz)

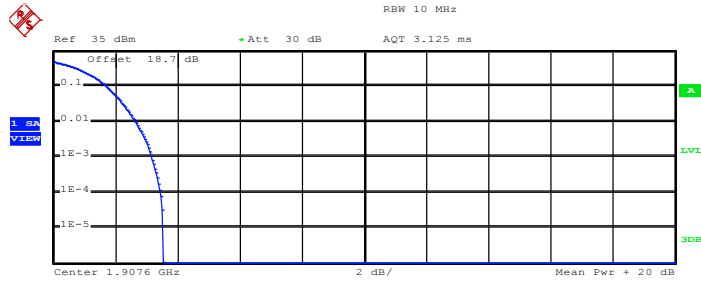

Complementary Cumulative Distribution Function (100000 samples)

Trace 1
 Mean 23.59 dBm
 Peak 27.14 dBm
 Crest 3.54 dB

10 % 1.72 dB
 1 % 2.64 dB
 .1 % 3.20 dB
 .01 % 3.48 dB

Date: 20.FEB.2014 13:44:33



3.3 Effective Radiated Power and Effective Isotropic Radiated Power Measurement

3.3.1 Description of the ERP/EIRP Measurement

The substitution method, in ANSI / TIA / EIA-603-C-2004, was used for ERP/EIRP measurement, and the spectrum analyzer configuration follows KDB 971168 D01 Power Meas. License Digital Systems v02r01. The ERP of mobile transmitters must not exceed 7 Watts and the EIRP of mobile transmitters are limited to 2 Watts.

3.3.2 Measuring Instruments

The measuring equipment is listed in the section 4 of this test report.

3.3.3 Test Procedures

1. The EUT was placed on a turntable with 1.5 meter height in a fully anechoic chamber.
2. The EUT was set at 3 meters from the receiving antenna, which was mounted on the antenna tower.
3. GSM operating modes: Set RBW= 1MHz, VBW= 3MHz, RMS detector over burst;
UMTS operating modes: Set RBW= 100 kHz, VBW= 300 kHz, RMS detector over frame, and use channel power option with bandwidth=5MHz, per KDB 971168 D01.
4. The table was rotated 360 degrees to determine the position of the highest radiated power.
5. The height of the receiving antenna is adjusted to look for the maximum ERP/EIRP.
6. Taking the record of maximum ERP/EIRP.
7. A dipole antenna was substituted in place of the EUT and was driven by a signal generator.
8. The conducted power at the terminal of the dipole antenna is measured.
9. Repeat step 3 to step 5 to get the maximum ERP/EIRP of the substitution antenna.
10. $ERP/EIRP = P_s + E_t - E_s + G_s = P_s + R_t - R_s + G_s$

P_s (dBm) : Input power to substitution antenna.

G_s (dBi or dBd) : Substitution antenna Gain.

$E_t = R_t + AF$

$E_s = R_s + AF$

AF (dB/m) : Receive antenna factor

R_t : The highest received signal in spectrum analyzer for EUT.

R_s : The highest received signal in spectrum analyzer for substitution antenna.

3.3.4 Test Setup

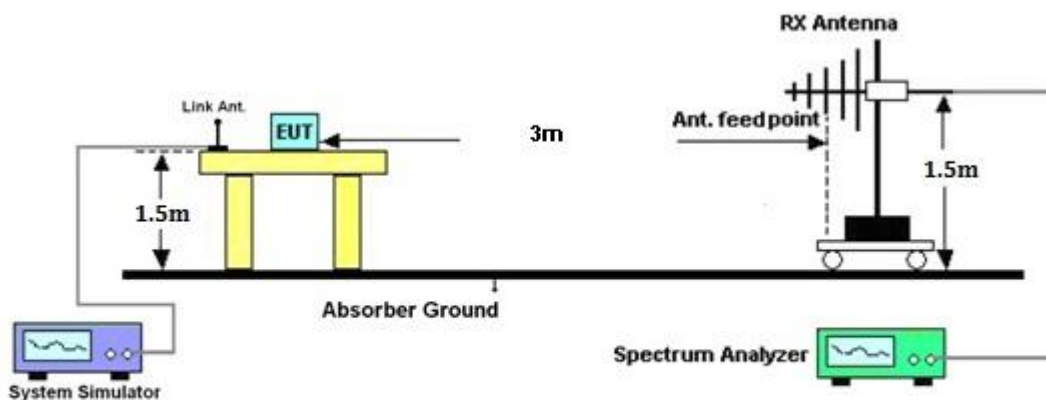

3.3.5 Test Result of ERP

GSM850 (GPRS class 8) Radiated Power ERP						
Horizontal Polarization						
Frequency (MHz)	Rt (dBm)	Rs (dBm)	Ps (dBm)	Gs (dBd)	ERP (dBm)	ERP (W)
824.20	-18.66	-48.12	0.00	-1.08	28.38	0.69
836.40	-18.63	-48.28	0.00	-0.93	28.72	0.75
848.80	-18.88	-48.35	0.00	-0.76	28.71	0.74
Vertical Polarization						
Frequency (MHz)	Rt (dBm)	Rs (dBm)	Ps (dBm)	Gs (dBd)	ERP (dBm)	ERP (W)
824.20	-28.49	-47.97	0.00	-1.08	18.40	0.07
836.40	-27.52	-48.01	0.00	-0.93	19.56	0.09
848.80	-27.87	-48.05	0.00	-0.76	19.42	0.09



GSM850 (EDGE class 8) Radiated Power ERP						
Horizontal Polarization						
Frequency (MHz)	Rt (dBm)	Rs (dBm)	Ps (dBm)	Gs (dBd)	ERP (dBm)	ERP (W)
824.20	-25.31	-48.12	0.00	-1.08	21.73	0.15
836.40	-24.80	-48.28	0.00	-0.93	22.55	0.18
848.80	-24.82	-48.35	0.00	-0.76	22.77	0.19
Vertical Polarization						
Frequency (MHz)	Rt (dBm)	Rs (dBm)	Ps (dBm)	Gs (dBd)	ERP (dBm)	ERP (W)
824.20	-34.93	-47.97	0.00	-1.08	11.96	0.02
836.40	-33.49	-48.01	0.00	-0.93	13.59	0.02
848.80	-33.76	-48.05	0.00	-0.76	13.53	0.02

WCDMA Band V (RMC 12.2Kbps) Radiated Power ERP						
Horizontal Polarization						
Frequency (MHz)	Rt (dBm)	Rs (dBm)	Ps (dBm)	Gs (dBd)	ERP (dBm)	ERP (W)
826.40	-28.61	-48.12	0.00	-1.08	18.43	0.07
836.40	-28.25	-48.28	0.00	-0.93	19.10	0.08
846.60	-28.02	-48.35	0.00	-0.76	19.57	0.09
Vertical Polarization						
Frequency (MHz)	Rt (dBm)	Rs (dBm)	Ps (dBm)	Gs (dBd)	ERP (dBm)	ERP (W)
826.40	-38.20	-47.97	0.00	-1.08	8.69	0.01
836.40	-36.75	-48.01	0.00	-0.93	10.33	0.01
846.60	-36.40	-48.05	0.00	-0.76	10.89	0.01



3.3.6 Test Result of EIRP

GSM1900 (GPRS class 8) Radiated Power EIRP						
Horizontal Polarization						
Frequency (MHz)	Rt (dBm)	Rs (dBm)	Ps (dBm)	Gs (dBi)	EIRP (dBm)	EIRP (W)
1850.20	-27.41	-51.88	0.00	1.96	26.43	0.44
1880.00	-28.98	-52.99	0.00	2.00	26.01	0.40
1909.80	-30.06	-54.28	0.00	1.98	26.20	0.42
Vertical Polarization						
Frequency (MHz)	Rt (dBm)	Rs (dBm)	Ps (dBm)	Gs (dBi)	EIRP (dBm)	EIRP (W)
1850.20	-25.42	-52.13	0.00	1.96	28.67	0.74
1880.00	-26.64	-53.17	0.00	2.00	28.53	0.71
1909.80	-27.95	-54.13	0.00	1.98	28.16	0.65

GSM1900 (EDGE class 8) Radiated Power EIRP						
Horizontal Polarization						
Frequency (MHz)	Rt (dBm)	Rs (dBm)	Ps (dBm)	Gs (dBi)	EIRP (dBm)	EIRP (W)
1850.20	-31.72	-51.88	0.00	1.96	22.12	0.16
1880.00	-33.20	-52.99	0.00	2.00	21.79	0.15
1909.80	-34.71	-54.28	0.00	1.98	21.55	0.14
Vertical Polarization						
Frequency (MHz)	Rt (dBm)	Rs (dBm)	Ps (dBm)	Gs (dBi)	EIRP (dBm)	EIRP (W)
1850.20	-29.61	-52.13	0.00	1.96	24.48	0.28
1880.00	-30.89	-53.17	0.00	2.00	24.28	0.27
1909.80	-32.27	-54.13	0.00	1.98	23.84	0.24



WCDMA Band II (RMC 12.2Kbps) Radiated Power EIRP						
Horizontal Polarization						
Frequency (MHz)	Rt (dBm)	Rs (dBm)	Ps (dBm)	Gs (dBi)	EIRP (dBm)	EIRP (W)
1852.40	-34.08	-51.88	0.00	1.96	19.76	0.09
1880.00	-35.66	-52.99	0.00	2.00	19.33	0.09
1907.60	-36.68	-54.28	0.00	1.98	19.58	0.09
Vertical Polarization						
Frequency (MHz)	Rt (dBm)	Rs (dBm)	Ps (dBm)	Gs (dBi)	EIRP (dBm)	EIRP (W)
1852.40	-31.80	-52.13	0.00	1.96	22.29	0.17
1880.00	-33.22	-53.17	0.00	2.00	21.95	0.16
1907.60	-34.38	-54.13	0.00	1.98	21.73	0.15

3.4 99% Occupied Bandwidth and 26dB Bandwidth Measurement

3.4.1 Description of 99% Occupied Bandwidth and 26dB Bandwidth Measurement

The 99% occupied bandwidth is the width of a frequency band such that, below the lower and above the upper frequency limits, the mean powers emitted are each equal to a specified percentage 0.5% of the total mean transmitted power.

The emission bandwidth is defined as the width of the signal between two points, located at the 2 sides of the carrier frequency, outside of which all emissions are attenuated at least 26 dB below the transmitter power.

3.4.2 Measuring Instruments

The measuring equipment is listed in the section 4 of this test report.

3.4.3 Test Procedures

1. The EUT was connected to Spectrum Analyzer and Base Station via power divider.
2. The RF output of EUT was connected to the spectrum analyzer by RF cable and attenuator. The path loss was compensated to the results for each measurement.
3. The 99% occupied bandwidth were measured, set RBW= 1% of span, VBW= 3*RBW, sample detector, trace maximum hold.
4. The 26dB bandwidth were measured, set RBW= 1% of EBW, VBW= 3*RBW, peak detector, trace maximum hold.

3.4.4 Test Setup

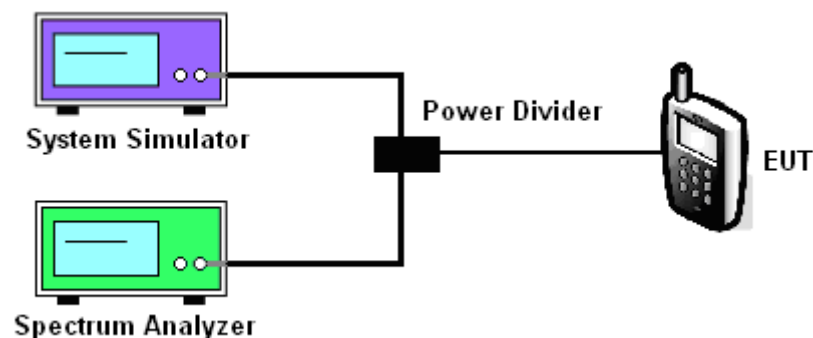



3.4.5 Test Result of Occupied Bandwidth and 26dB Bandwidth

Cellular Band						
Modes	GSM850 (GPRS class 8)			GSM850 (EDGE class 8)		
Channel	128 (Low)	189 (Mid)	251 (High)	128 (Low)	189 (Mid)	251 (High)
Frequency (MHz)	824.2	836.4	848.8	824.2	836.4	848.8
99% OBW (kHz)	244.00	244.00	246.00	242.00	244.00	242.00
26dB BW (kHz)	308.00	316.00	320.00	286.00	306.00	306.00

PCS Band						
Modes	GSM1900 (GPRS class 8)			GSM1900 (EDGE class 8)		
Channel	512 (Low)	661 (Mid)	810 (High)	512 (Low)	661 (Mid)	810 (High)
Frequency (MHz)	1850.2	1880	1909.8	1850.2	1880	1909.8
99% OBW (kHz)	246.00	246.00	246.00	246.00	242.00	242.00
26dB BW (kHz)	312.00	312.00	312.00	314.00	300.00	308.00

Cellular Band			
Modes	WCDMA Band V (RMC 12.2Kbps)		
Channel	4132 (Low)	4182 (Mid)	4233 (High)
Frequency (MHz)	826.4	836.4	846.6
99% OBW (MHz)	4.14	4.16	4.16
26dB BW (MHz)	4.68	4.68	4.68

PCS Band			
Modes	WCDMA Band II (RMC 12.2Kbps)		
Channel	9262 (Low)	9400 (Mid)	9538 (High)
Frequency (MHz)	1852.4	1880	1907.6
99% OBW (MHz)	4.14	4.14	4.16
26dB BW (MHz)	4.68	4.68	4.66



3.4.6 Test Result (Plots) of Occupied Bandwidth and 26dB Bandwidth

Band :	GSM 850	Test Mode :	GPRS class 8 Link (GMSK)
--------	---------	-------------	--------------------------

99% Occupied Bandwidth Plot on Channel 128 (824.2 MHz)

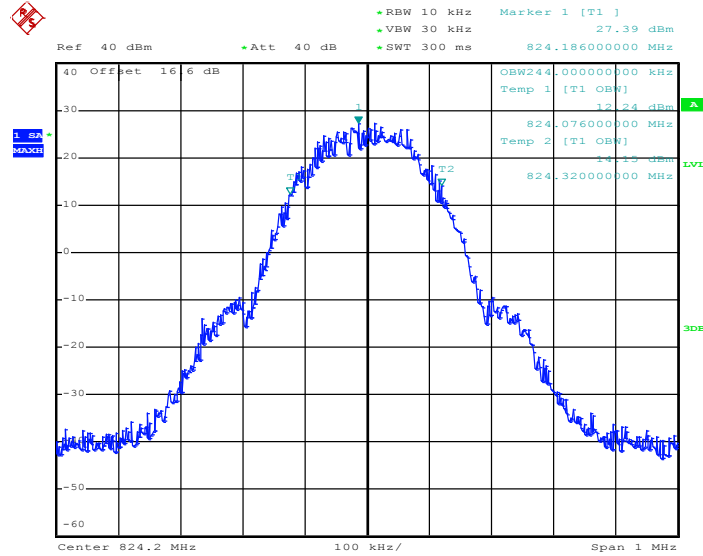

Date: 20.FEB.2014 09:48:47

26dB Bandwidth Plot on Channel 128 (824.2 MHz)

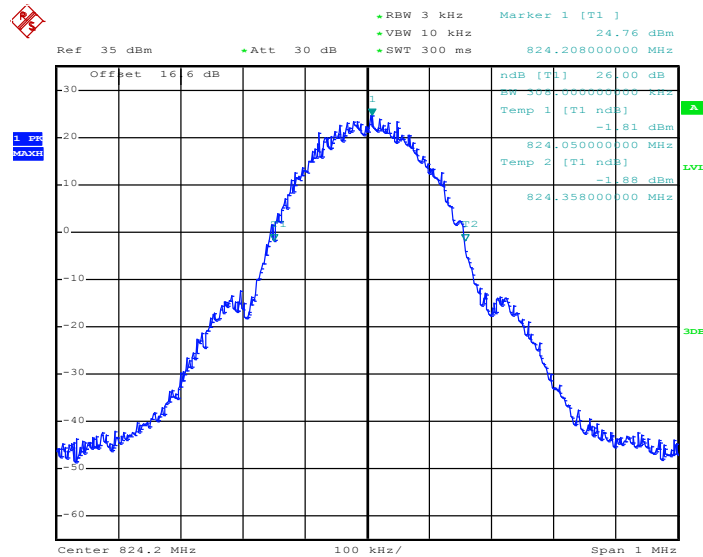

Date: 20.FEB.2014 09:45:35



99% Occupied Bandwidth Plot on Channel 189 (836.4 MHz)

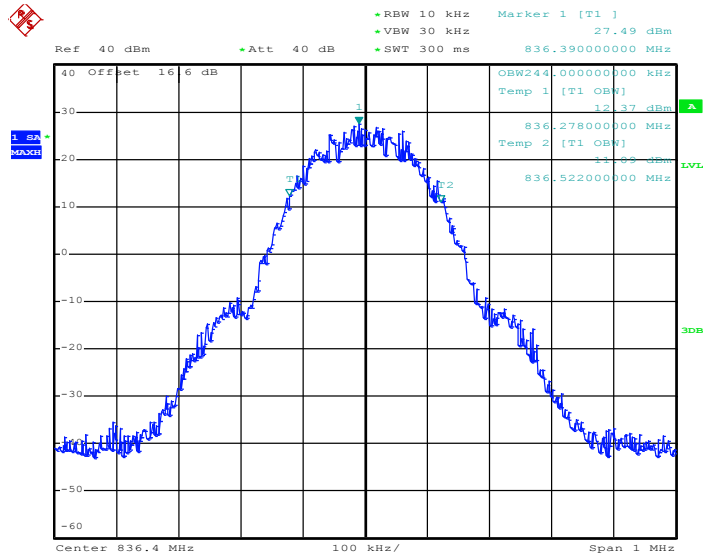

Date: 20.FEB.2014 09:49:16

26dB Bandwidth Plot on Channel 189 (836.4 MHz)

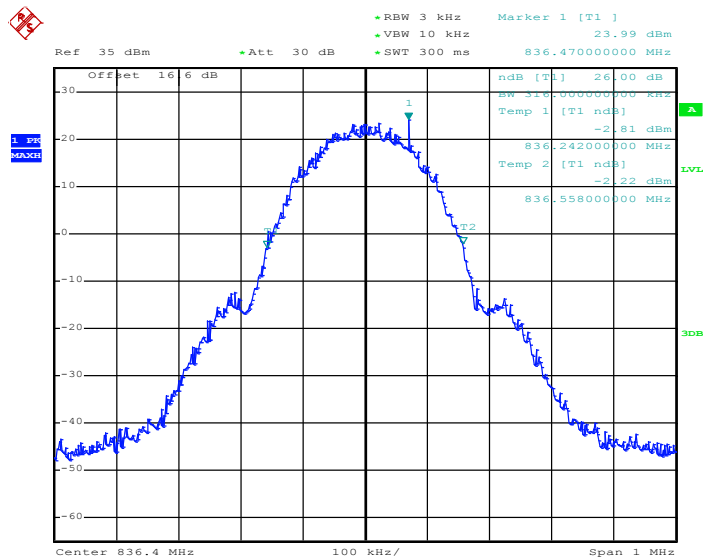

Date: 20.FEB.2014 09:46:04



99% Occupied Bandwidth Plot on Channel 251 (848.8 MHz)

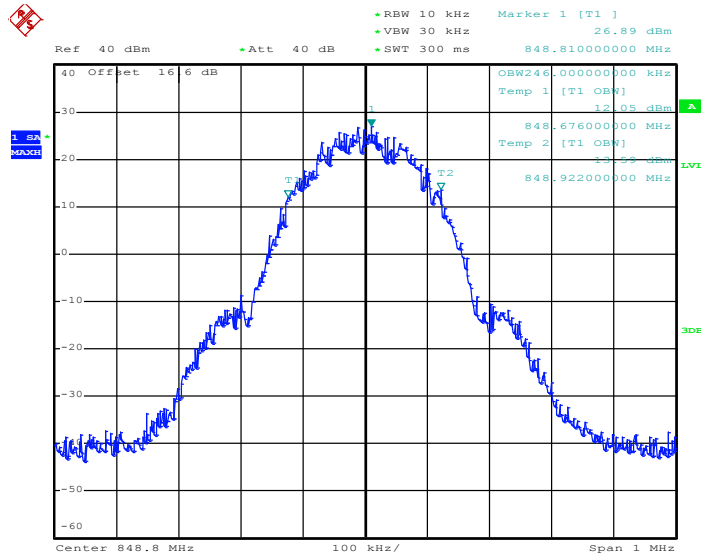

Date: 20.FEB.2014 09:49:44

26dB Bandwidth Plot on Channel 251 (848.8 MHz)

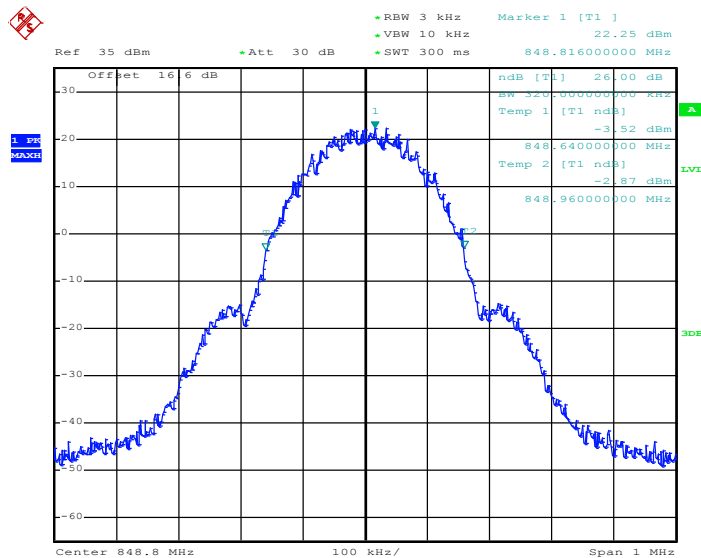

Date: 20.FEB.2014 09:46:32



Band :	GSM 850	Test Mode :	EDGE class 8 Link (8PSK)
---------------	---------	--------------------	--------------------------

99% Occupied Bandwidth Plot on Channel 128 (824.2 MHz)

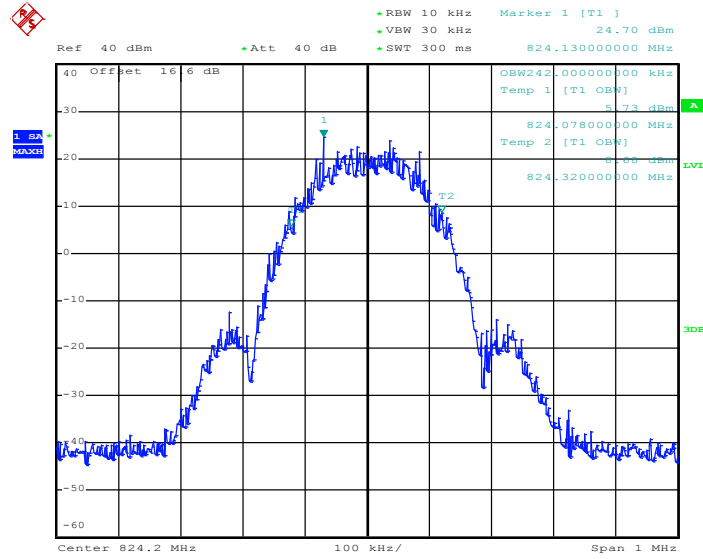

Date: 20.FEB.2014 11:04:44

26dB Bandwidth Plot on Channel 128 (824.2 MHz)

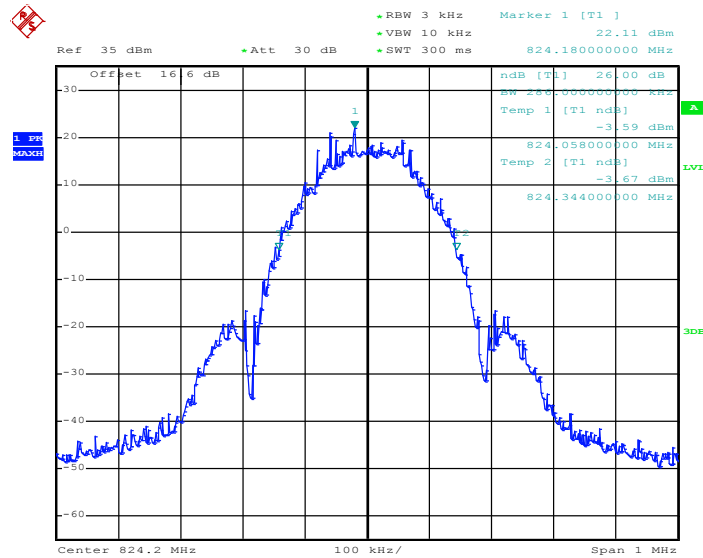

Date: 20.FEB.2014 11:02:20



99% Occupied Bandwidth Plot on Channel 189 (836.4 MHz)

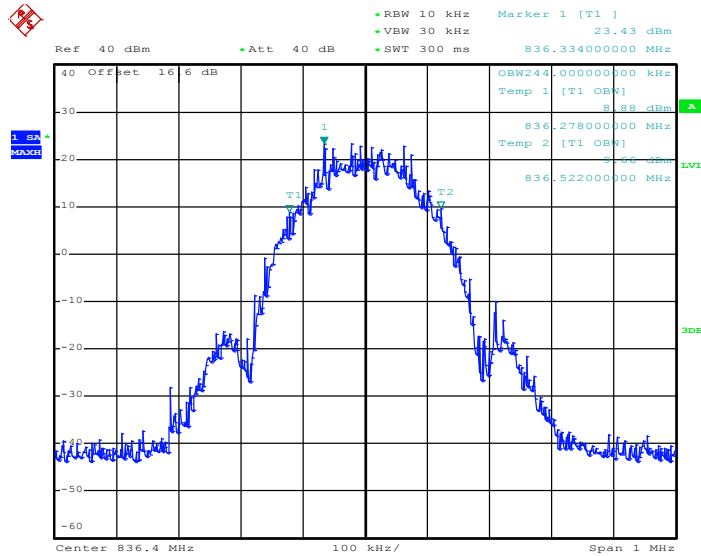

Date: 20.FEB.2014 11:05:13

26dB Bandwidth Plot on Channel 189 (836.4 MHz)

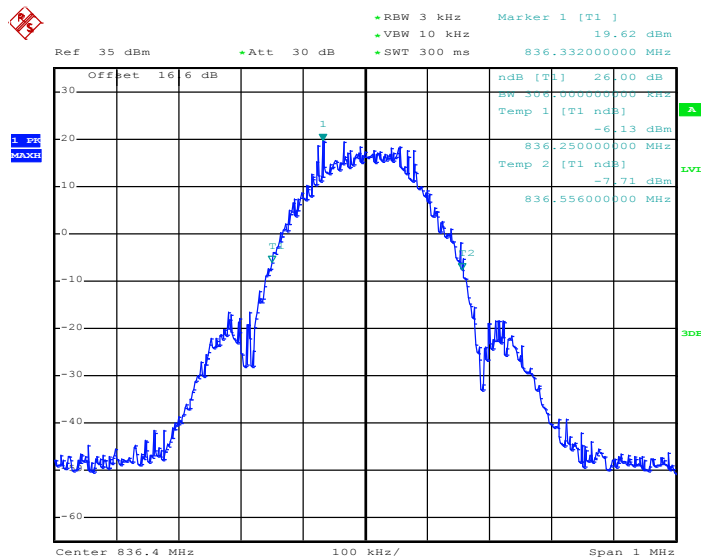

Date: 20.FEB.2014 11:02:49



99% Occupied Bandwidth Plot on Channel 251 (848.8 MHz)

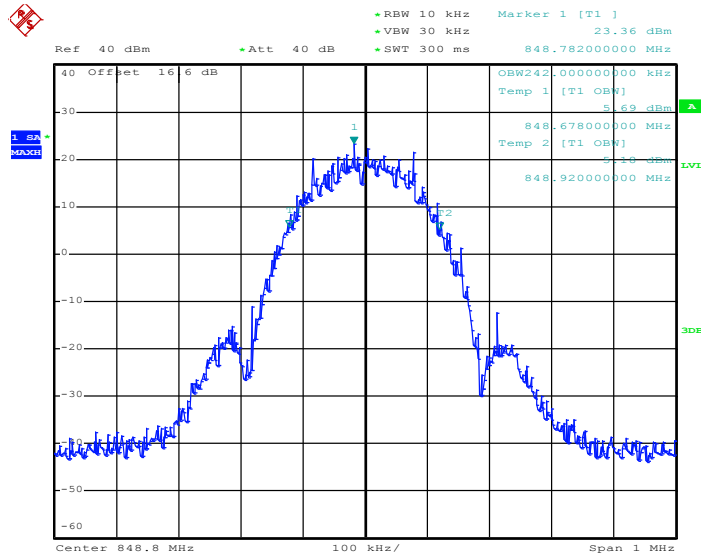

Date: 20.FEB.2014 11:05:41

26dB Bandwidth Plot on Channel 251 (848.8 MHz)

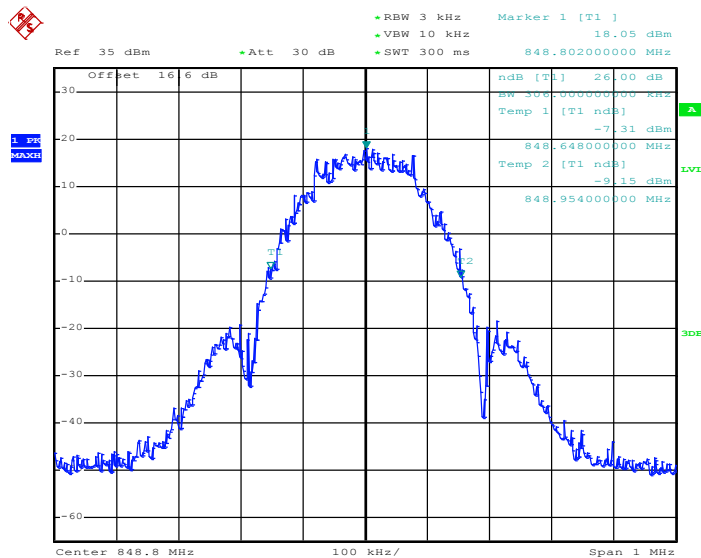

Date: 20.FEB.2014 11:03:18



Band :	GSM 1900	Test Mode :	GPRS class 8 Link (GMSK)
---------------	----------	--------------------	--------------------------

99% Occupied Bandwidth Plot on Channel 512 (1850.2 MHz)

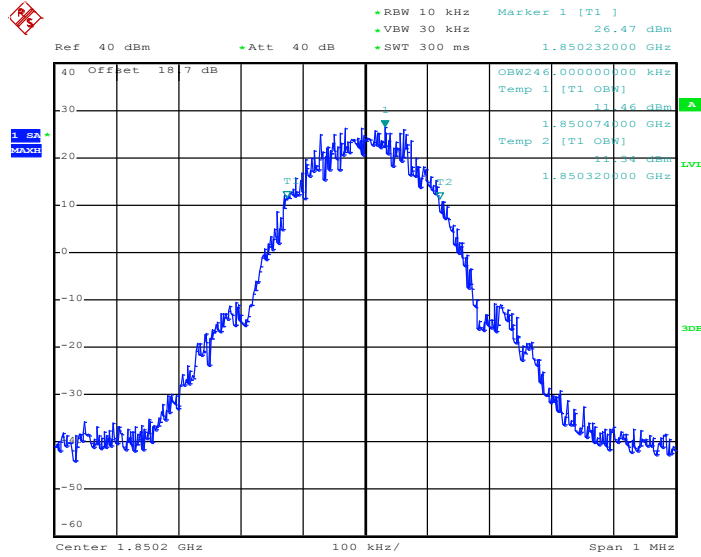

Date: 20.FEB.2014 11:31:58

26dB Bandwidth Plot on Channel 512 (1850.2 MHz)

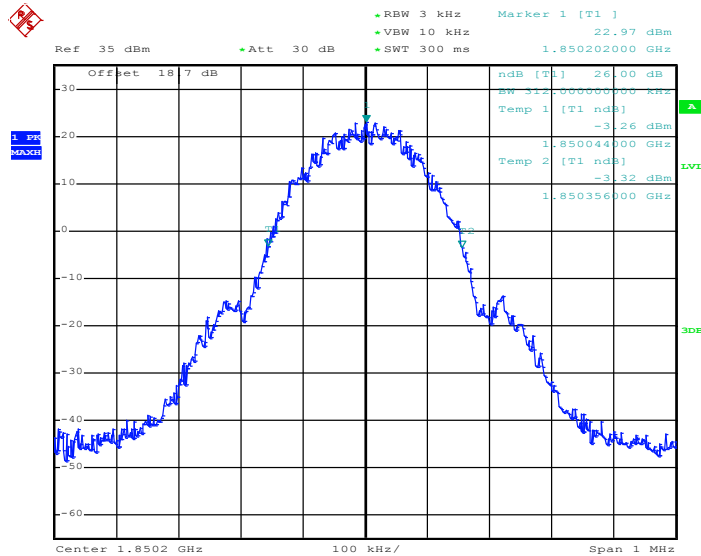

Date: 20.FEB.2014 11:28:12



99% Occupied Bandwidth Plot on Channel 661 (1880.0 MHz)

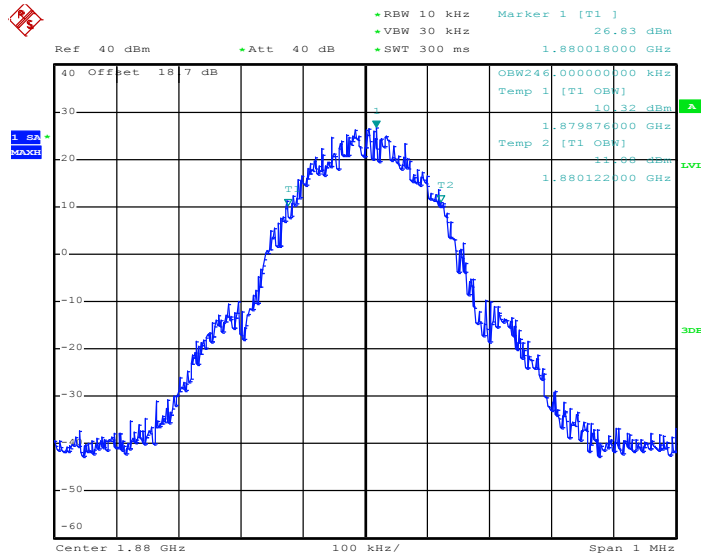

Date: 20.FEB.2014 11:32:27

26dB Bandwidth Plot on Channel 661 (1880.0 MHz)

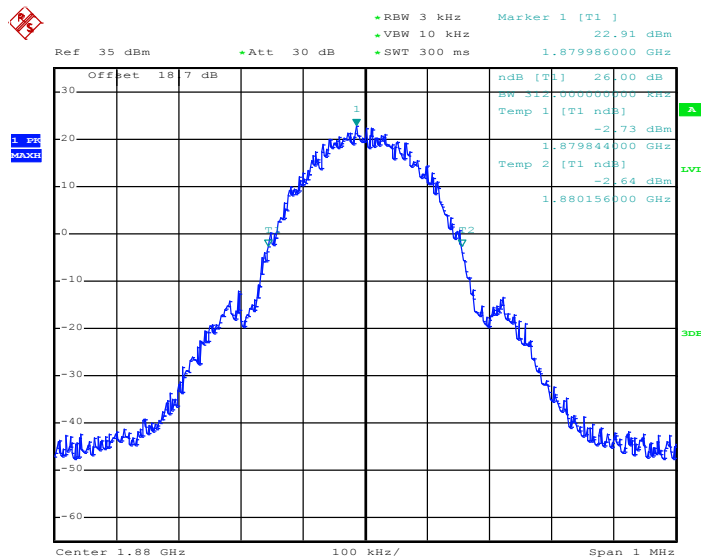

Date: 20.FEB.2014 11:28:40



99% Occupied Bandwidth Plot on Channel 810 (1909.8 MHz)

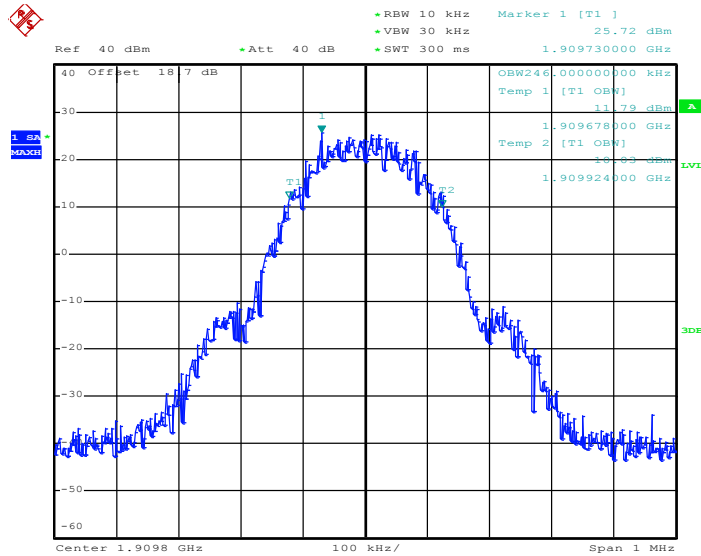

Date: 20.FEB.2014 11:32:55

26dB Bandwidth Plot on Channel 810 (1909.8 MHz)

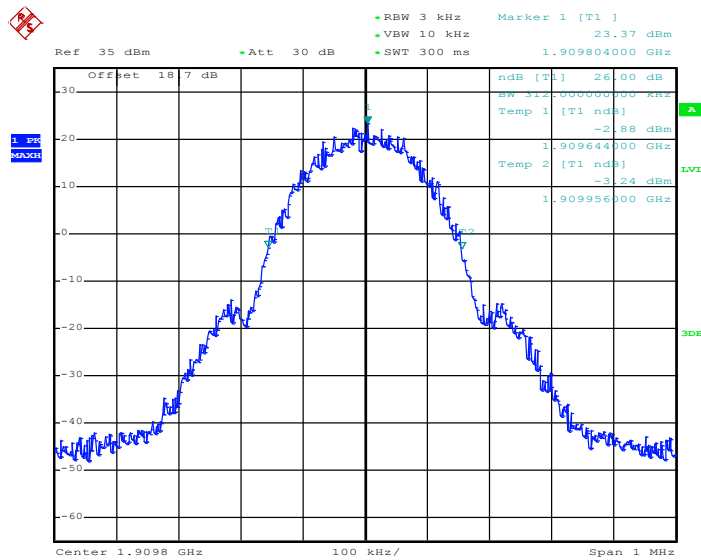

Date: 20.FEB.2014 11:29:09



Band :	GSM 1900	Test Mode :	EDGE class 8 Link (8PSK)
---------------	----------	--------------------	--------------------------

99% Occupied Bandwidth Plot on Channel 512 (1850.2 MHz)

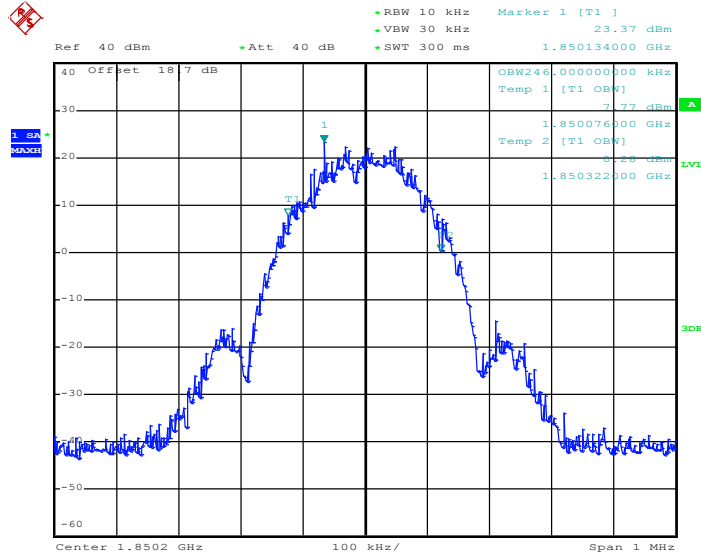

Date: 20.FEB.2014 11:57:41

26dB Bandwidth Plot on Channel 512 (1850.2 MHz)

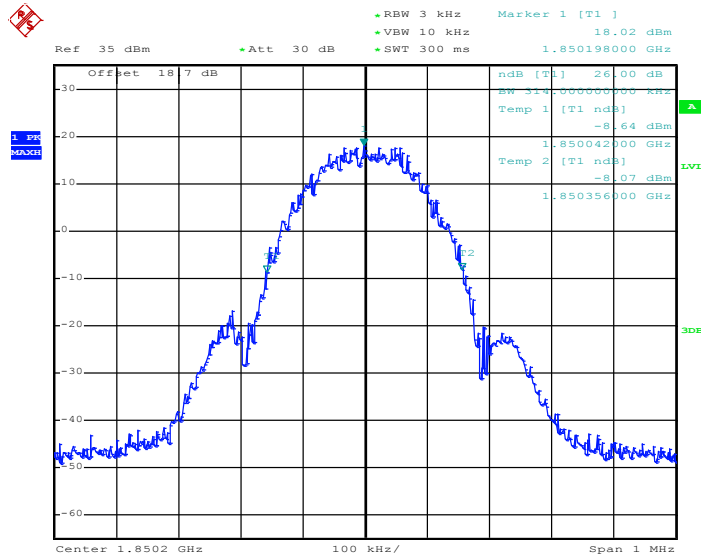

Date: 20.FEB.2014 11:55:50



99% Occupied Bandwidth Plot on Channel 661 (1880.0 MHz)

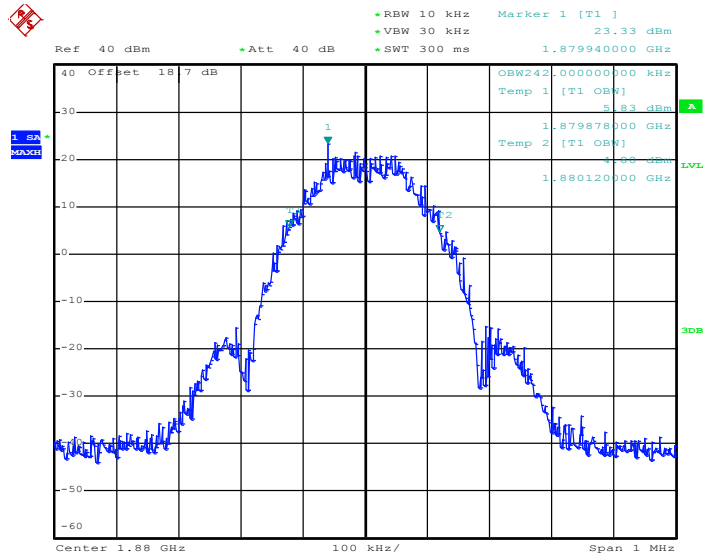

Date: 20.FEB.2014 11:58:10

26dB Bandwidth Plot on Channel 661 (1880.0 MHz)

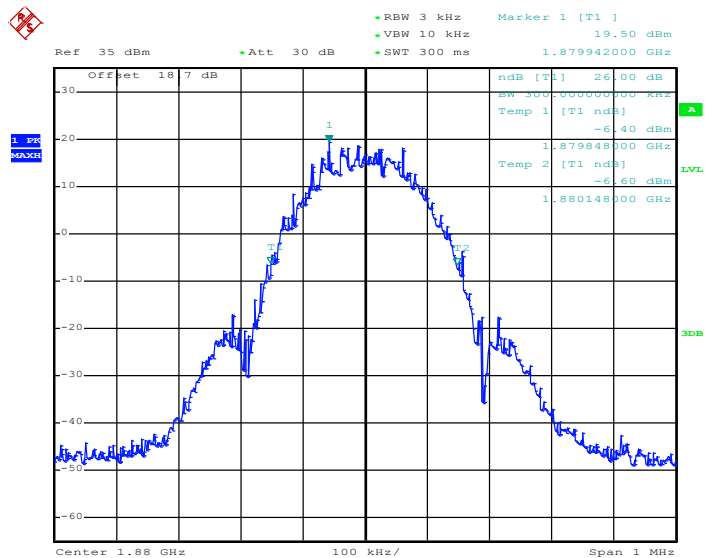

Date: 20.FEB.2014 11:56:18



99% Occupied Bandwidth Plot on Channel 810 (1909.8 MHz)

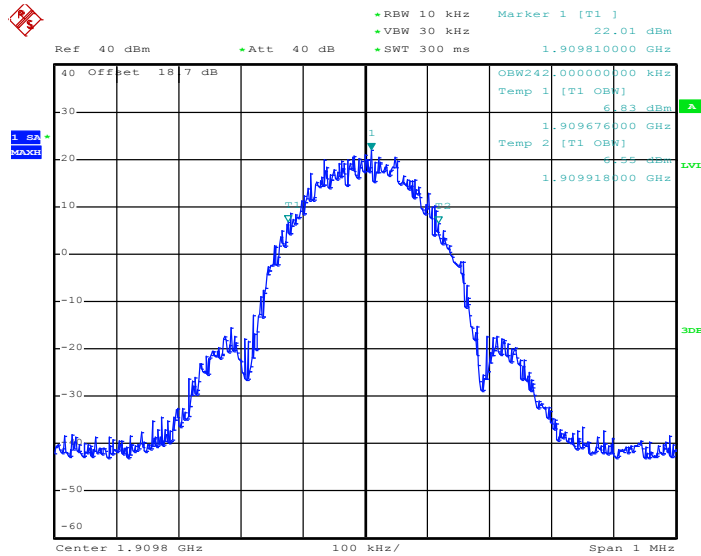

Date: 20.FEB.2014 11:58:38

26dB Bandwidth Plot on Channel 810 (1909.8 MHz)

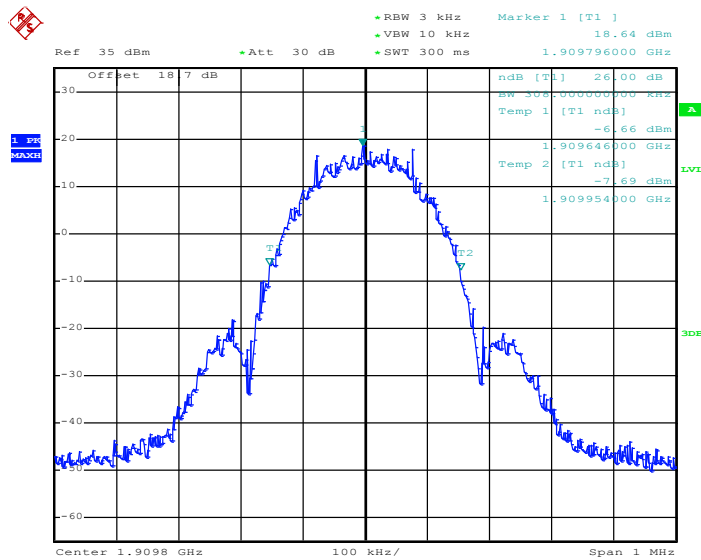

Date: 20.FEB.2014 11:56:47



Band :	WCDMA Band V	Test Mode :	RMC 12.2Kbps Link (QPSK)
---------------	--------------	--------------------	--------------------------

99% Occupied Bandwidth Plot on Channel 4132 (826.4 MHz)

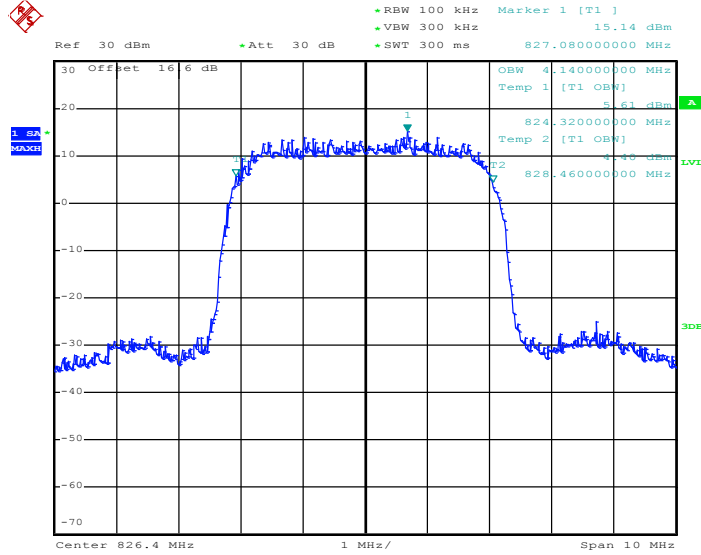

Date: 20.FEB.2014 14:03:20

26dB Bandwidth Plot on Channel 4132 (826.4 MHz)

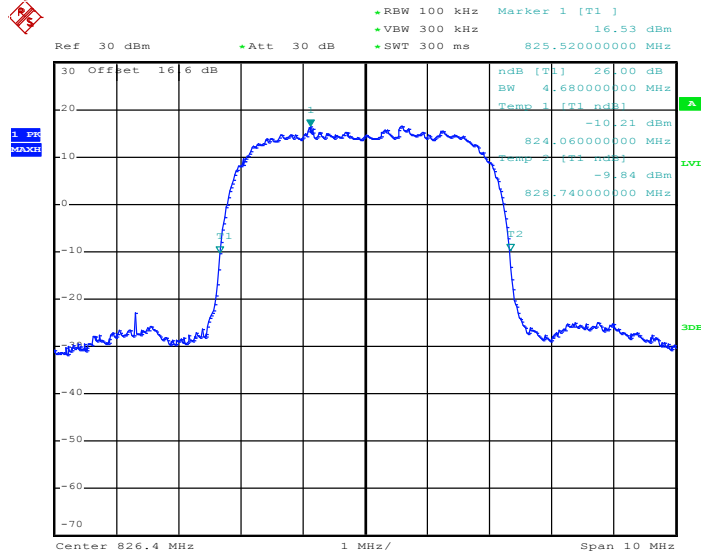

Date: 20.FEB.2014 14:00:51



99% Occupied Bandwidth Plot on Channel 4182 (836.4 MHz)

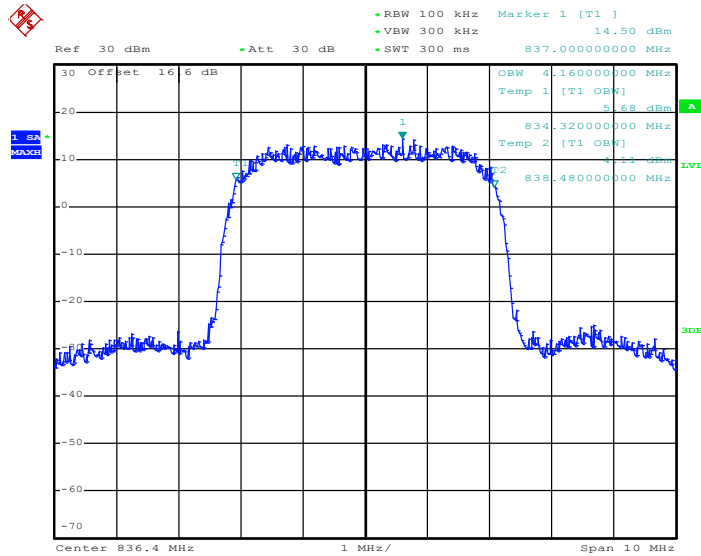

Date: 20.FEB.2014 14:03:48

26dB Bandwidth Plot on Channel 4182 (836.4 MHz)

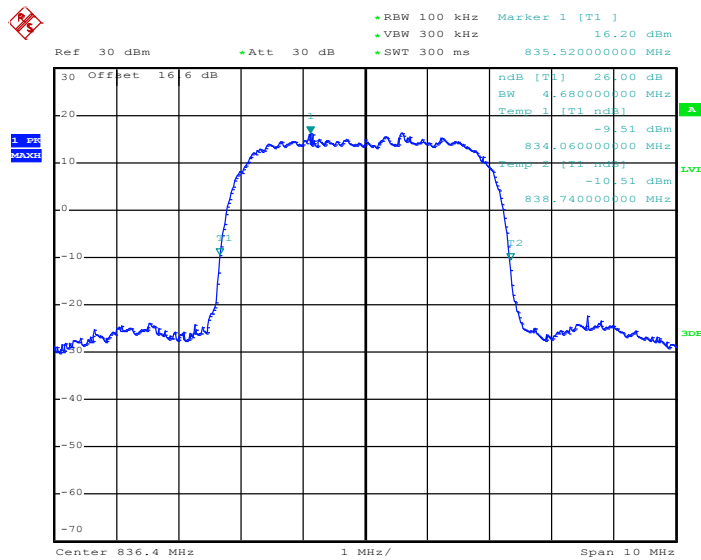

Date: 20.FEB.2014 13:59:08



99% Occupied Bandwidth Plot on Channel 4233 (846.6 MHz)

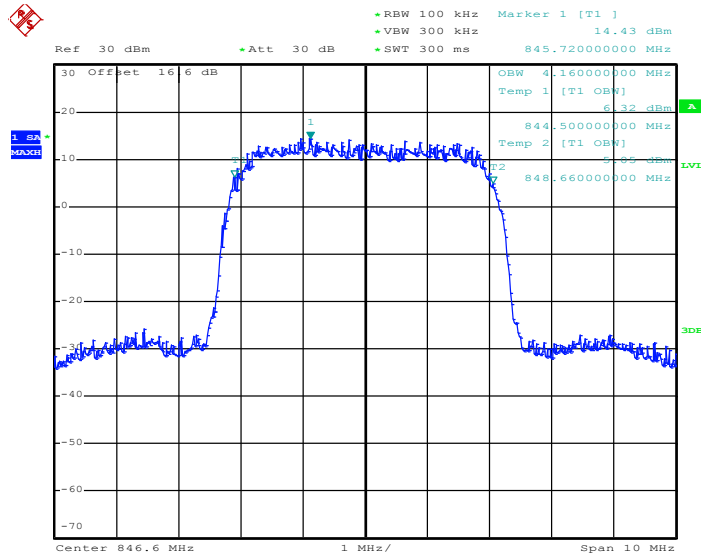

Date: 20.FEB.2014 14:04:17

26dB Bandwidth Plot on Channel 4233 (846.6 MHz)

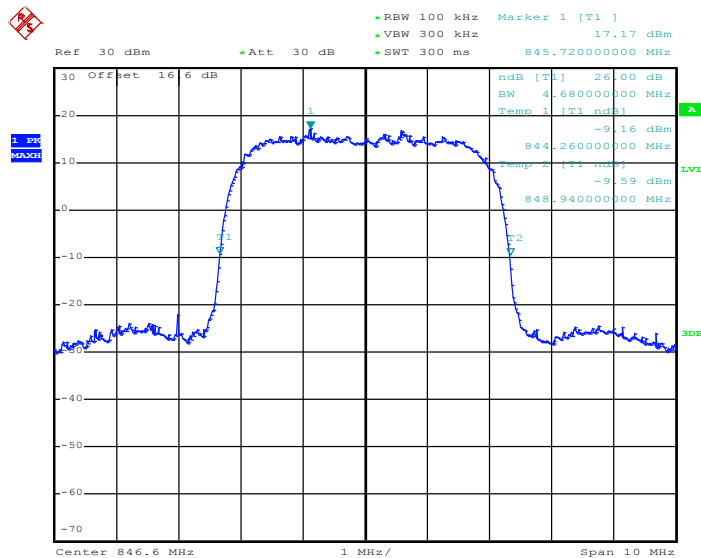

Date: 20.FEB.2014 14:01:49



Band :	WCDMA Band II	Test Mode :	RMC 12.2Kbps Link (QPSK)
---------------	---------------	--------------------	--------------------------

99% Occupied Bandwidth Plot on Channel 9262 (1852.4 MHz)

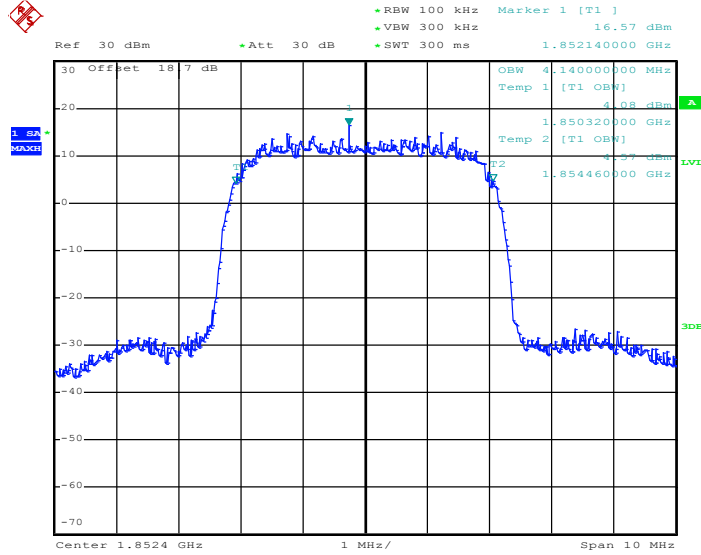

Date: 20.FEB.2014 13:31:02

26dB Bandwidth Plot on Channel 9262 (1852.4 MHz)

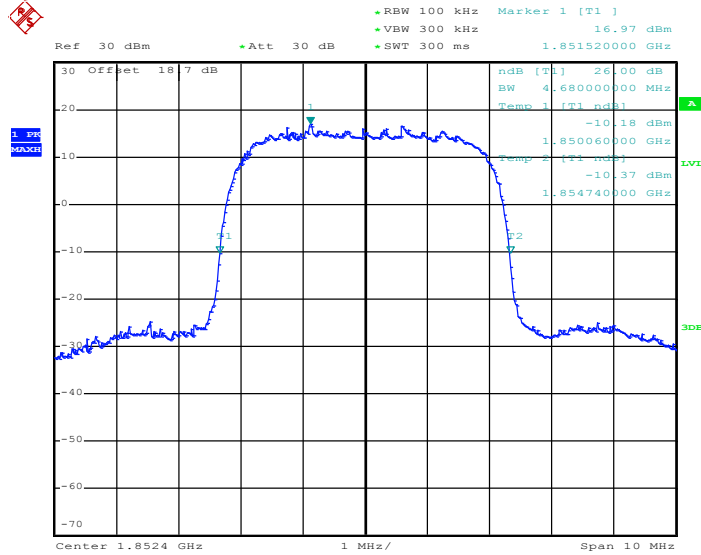

Date: 20.FEB.2014 13:27:24



99% Occupied Bandwidth Plot on Channel 9400 (1880.0 MHz)

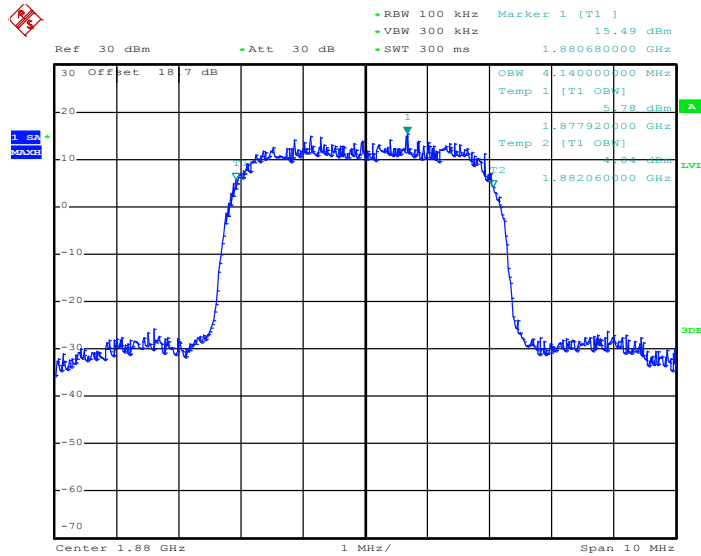

Date: 20.FEB.2014 13:31:31

26dB Bandwidth Plot on Channel 9400 (1880.0 MHz)

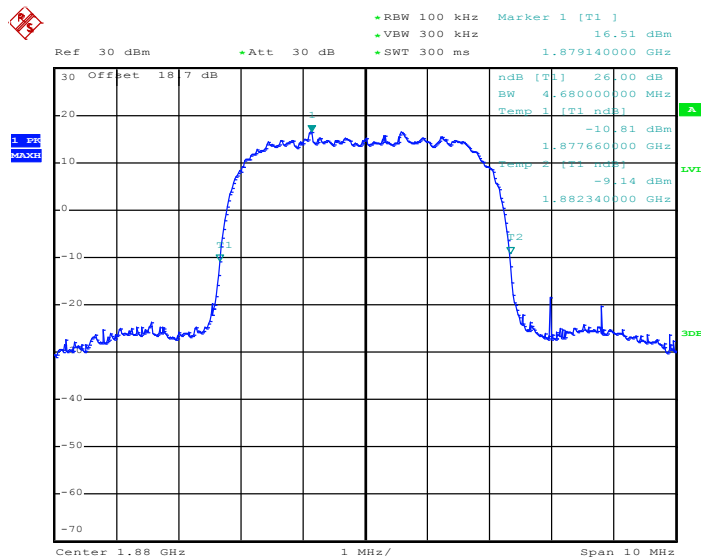

Date: 20.FEB.2014 13:29:38



99% Occupied Bandwidth Plot on Channel 9538 (1907.6 MHz)

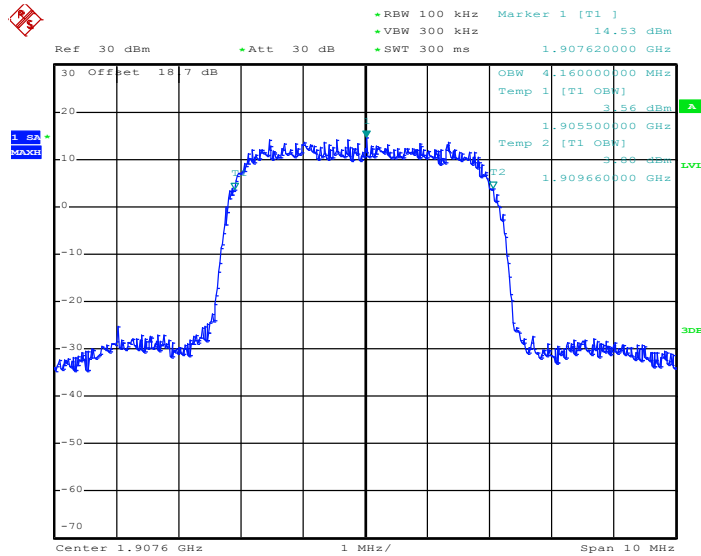

Date: 20.FEB.2014 13:31:59

26dB Bandwidth Plot on Channel 9538 (1907.6 MHz)

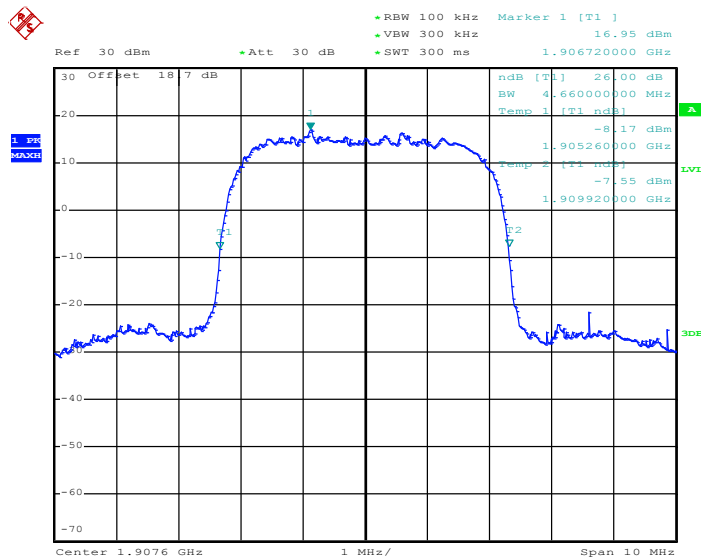

Date: 20.FEB.2014 13:28:21

3.5 Band Edge Measurement

3.5.1 Description of Band Edge Measurement

The power of any emission outside of the authorized operating frequency ranges must be lower than the transmitter power (P) by a factor of at least $43 + 10 \log (P)$ dB.

3.5.2 Measuring Instruments

The measuring equipment is listed in the section 4 of this test report.

3.5.3 Test Procedures

1. The EUT was connected to Spectrum Analyzer and Base Station via power divider.
2. The RF output of EUT was connected to the spectrum analyzer by RF cable and attenuator. The path loss was compensated to the results for each measurement.
3. The band edges of low and high channels for the highest RF powers were measured. Setting RBW as roughly $BW/100$.
4. The RF fundamental frequency should be excluded against the limit line in the operating frequency band.
5. The limit line is derived from $43 + 10\log(P)$ dB below the transmitter power P(Watts)
 $= P(W) - [43 + 10\log(P)]$ (dB)
 $= [30 + 10\log(P)]$ (dBm) - $[43 + 10\log(P)]$ (dB)
 $= -13\text{dBm}$.

3.5.4 Test Setup

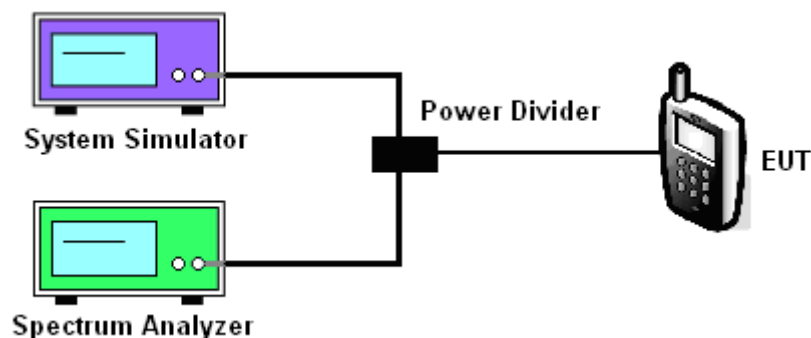



3.5.5 Test Result (Plots) of Conducted Band Edge

Band :	GSM850	Test Mode :	GPRS class 8 Link (GMSK)
--------	--------	-------------	--------------------------

Lower Band Edge Plot on Channel 128 (824.2 MHz)

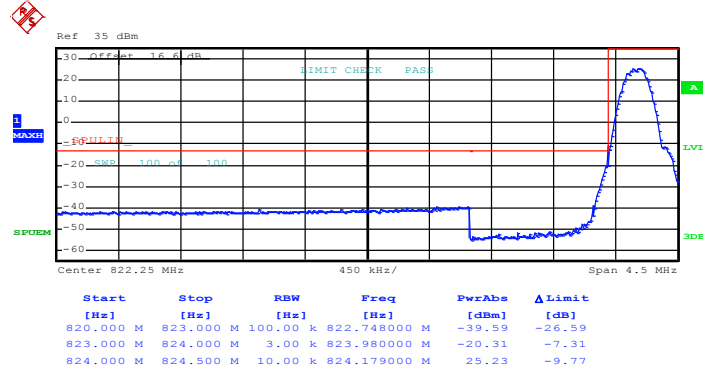

Date: 20.FEB.2014 10:10:53

Higher Band Edge Plot on Channel 251 (848.8 MHz)

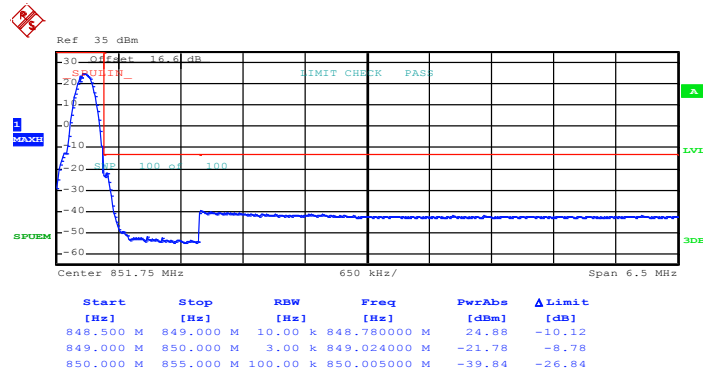

Date: 20.FEB.2014 10:04:40



Band :	GSM850	Test Mode :	EDGE class 8 Link (8PSK)
--------	--------	-------------	--------------------------

Lower Band Edge Plot on Channel 128 (824.2 MHz)

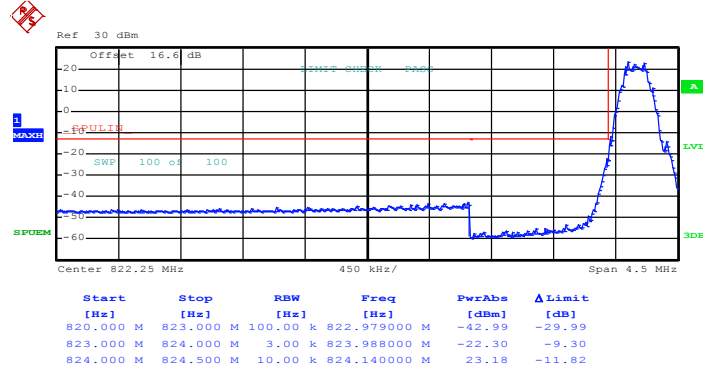

Date: 20.FEB.2014 11:16:15

Higher Band Edge Plot on Channel 251 (848.8 MHz)

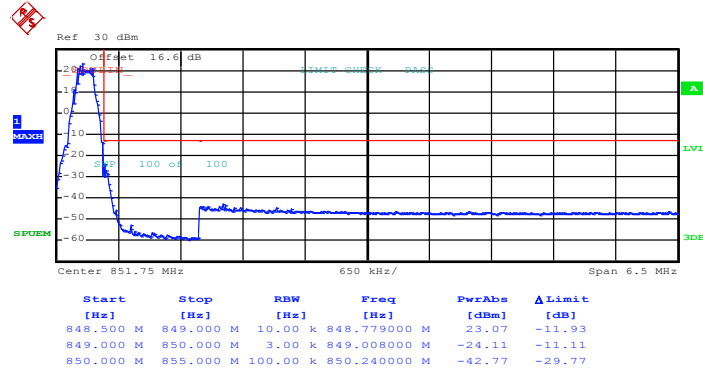

Date: 20.FEB.2014 11:13:38



Band :	GSM1900	Test Mode :	GPRS class 8 Link (GMSK)
--------	---------	-------------	--------------------------

Lower Band Edge Plot on Channel 512 (1850.2 MHz)

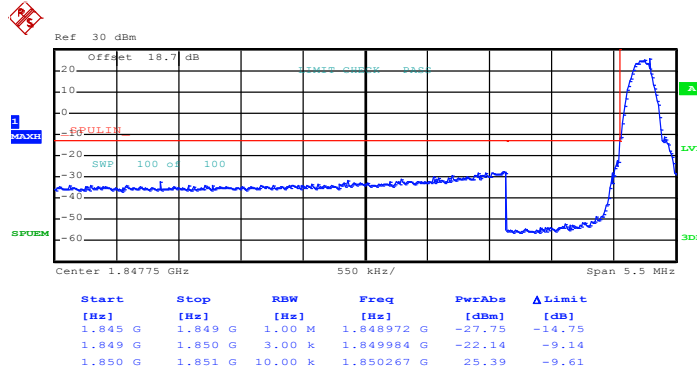

Date: 20.FEB.2014 11:49:47

Higher Band Edge Plot on Channel 810 (1909.8 MHz)

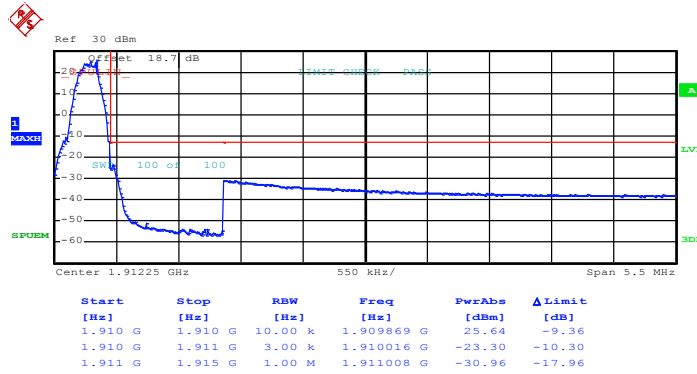

Date: 20.FEB.2014 11:45:03



Band :	GSM1900	Test Mode :	EDGE class 8 Link (8PSK)
--------	---------	-------------	--------------------------

Lower Band Edge Plot on Channel 512 (1850.2 MHz)

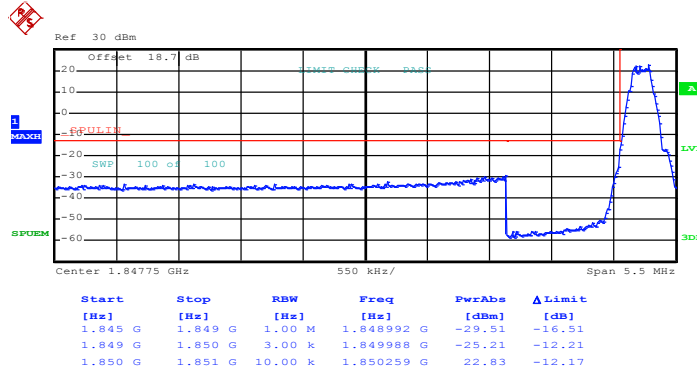

Date: 20.FEB.2014 12:32:41

Higher Band Edge Plot on Channel 810 (1909.8 MHz)

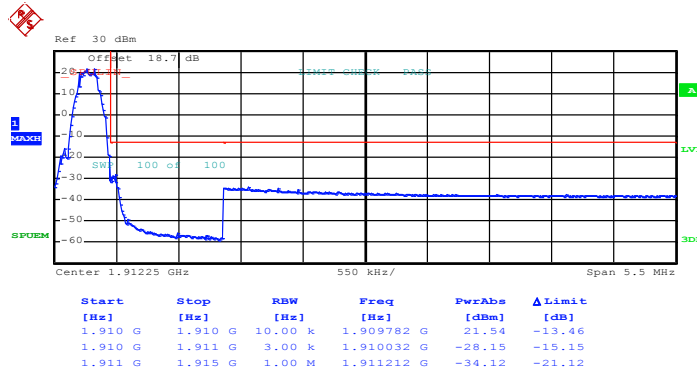

Date: 20.FEB.2014 12:28:15



Band :	WCDMA Band V	Test Mode :	RMC 12.2Kbps Link (QPSK)
--------	--------------	-------------	--------------------------

Lower Band Edge Plot on Channel 4132 (826.4 MHz)

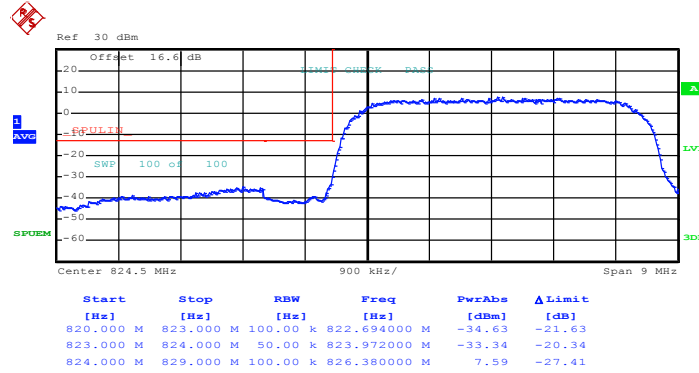

Date: 20.FEB.2014 14:39:18

Higher Band Edge Plot on Channel 4233 (846.6 MHz)

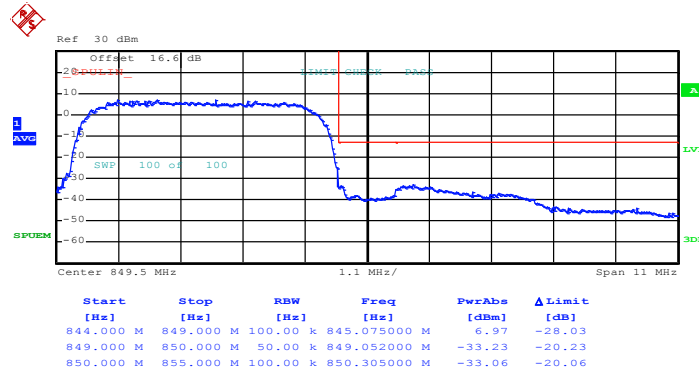

Date: 20.FEB.2014 14:34:13



Band :	WCDMA Band II	Test Mode :	RMC 12.2Kbps Link (QPSK)
--------	---------------	-------------	--------------------------

Lower Band Edge Plot on Channel 9262 (1852.4 MHz)

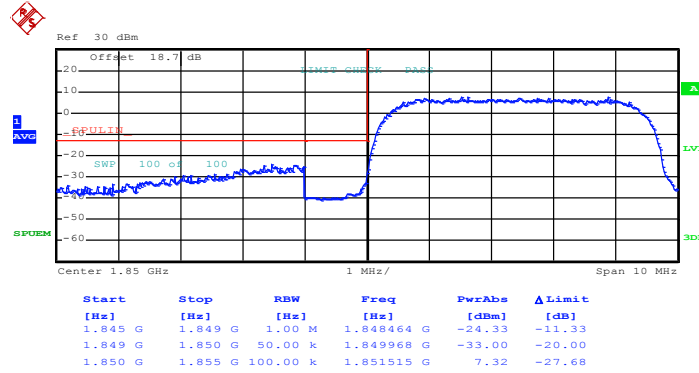

Date: 20.FEB.2014 13:38:33

Higher Band Edge Plot on Channel 9538 (1907.6 MHz)

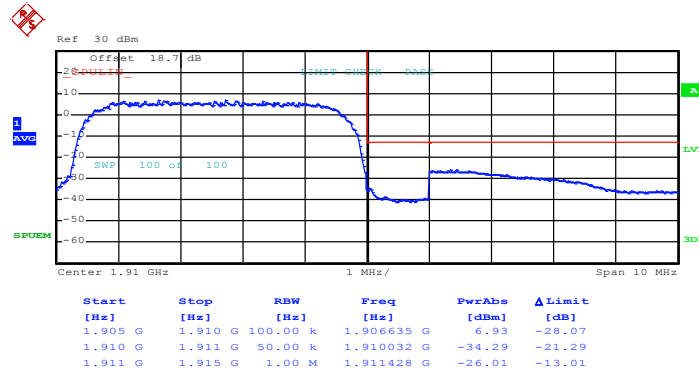

Date: 20.FEB.2014 13:35:47

3.6 Conducted Spurious Emission Measurement

3.6.1 Description of Conducted Spurious Emission Measurement

The power of any emission outside of the authorized operating frequency ranges must be lower than the transmitter power (P) by a factor of at least $43 + 10 \log (P)$ dB.

It is measured by means of a calibrated spectrum analyzer and scanned from 30 MHz up to a frequency including its 10th harmonic.

3.6.2 Measuring Instruments

The measuring equipment is listed in the section 4 of this test report.

3.6.3 Test Procedures

1. The EUT was connected to spectrum analyzer and base station via power divider.
2. The RF output of EUT was connected to the spectrum analyzer by RF cable and attenuator. The path loss was compensated to the results for each measurement.
3. The middle channel for the highest RF power within the transmitting frequency was measured.
4. The conducted spurious emission for the whole frequency range was taken.
5. The RF fundamental frequency should be excluded against the limit line in the operating frequency band.
6. The limit line is derived from $43 + 10\log(P)$ dB below the transmitter power P(Watts)

$$= P(W) - [43 + 10\log(P)] \text{ (dB)}$$

$$= [30 + 10\log(P)] \text{ (dBm)} - [43 + 10\log(P)] \text{ (dB)}$$

$$= -13\text{dBm}$$

3.6.4 Test Setup

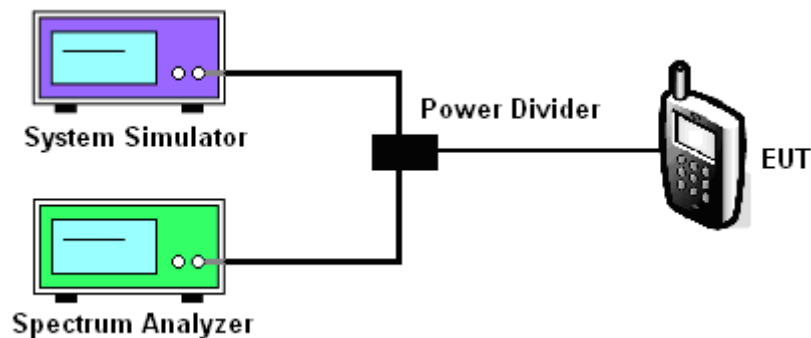



3.6.5 Test Result (Plots) of Conducted Spurious Emission

Band :	GSM850	Channel :	CH189
Test Mode :	GPRS class 8 Link (GMSK)	Frequency :	836.4 MHz

Conducted Spurious Emission Plot between 30MHz ~ 1GHz

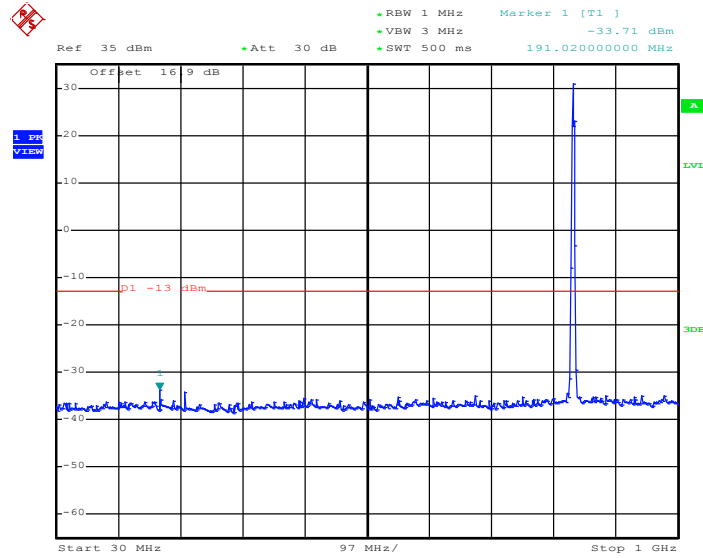

Date: 20.FEB.2014 09:51:03

Conducted Spurious Emission Plot between 1GHz ~ 3GHz

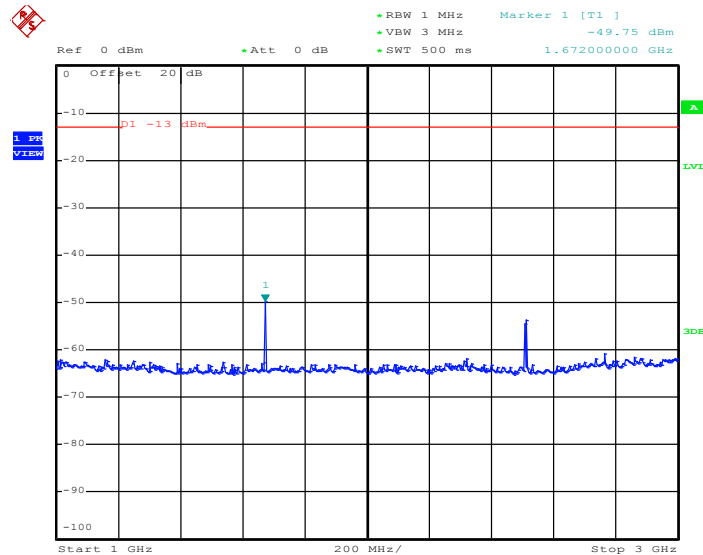

Date: 20.FEB.2014 09:51:17



Conducted Spurious Emission Plot between 3GHz ~ 7GHz

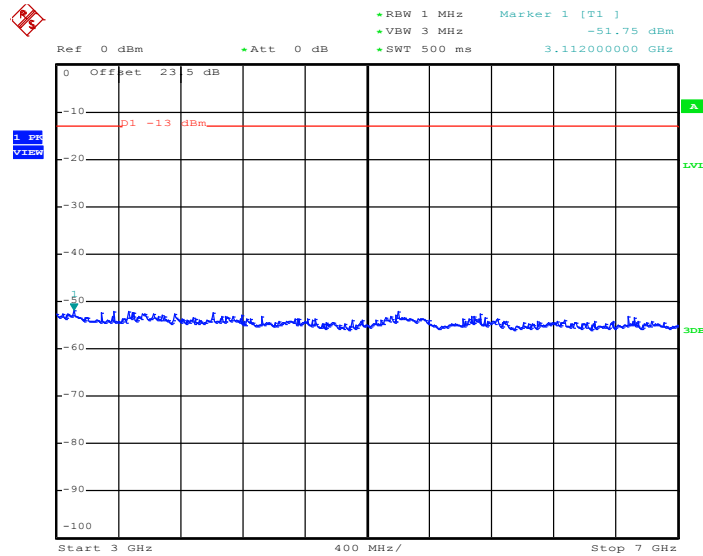

Date: 20.FEB.2014 09:51:25

Conducted Spurious Emission Plot between 7GHz ~ 9GHz

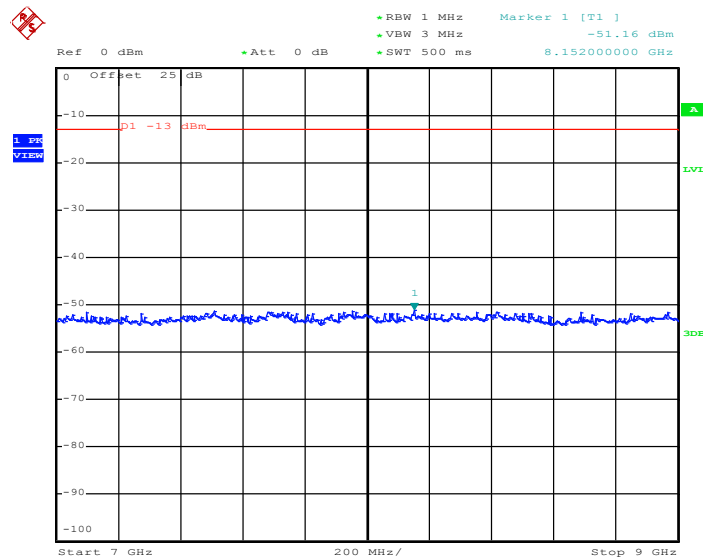

Date: 20.FEB.2014 09:51:33



Band :	GSM850	Channel :	CH189
Test Mode :	EDGE class 8 Link (8PSK)	Frequency :	836.4 MHz

Conducted Spurious Emission Plot between 30MHz ~ 1GHz

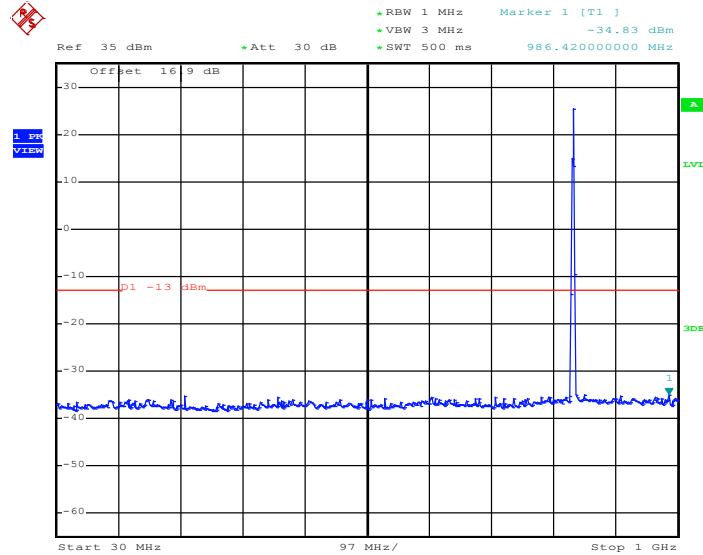

Date: 20.FEB.2014 11:06:57

Conducted Spurious Emission Plot between 1GHz ~ 3GHz

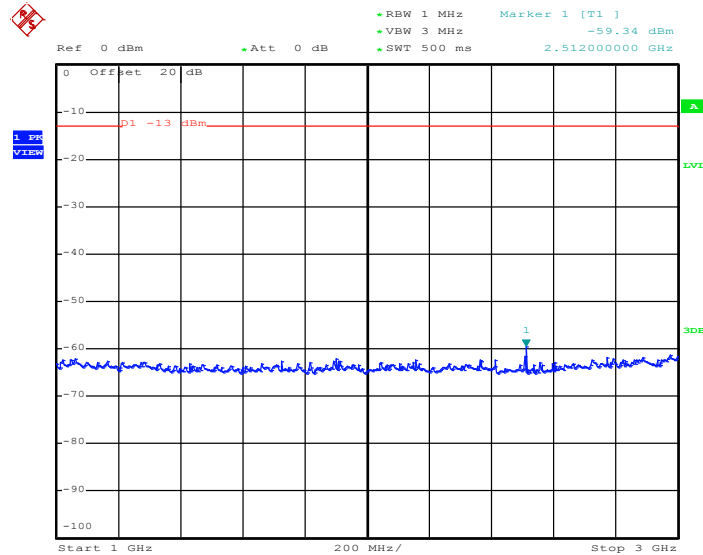

Date: 20.FEB.2014 11:07:09



Conducted Spurious Emission Plot between 3GHz ~ 7GHz

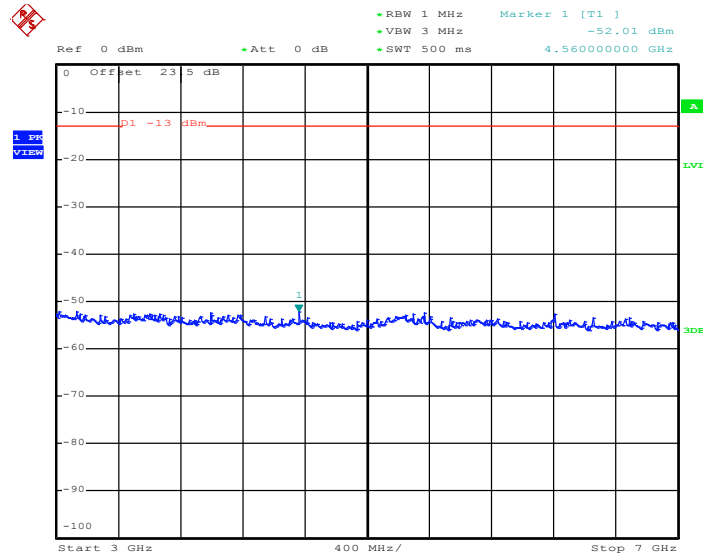

Date: 20.FEB.2014 11:07:18

Conducted Spurious Emission Plot between 7GHz ~ 9GHz

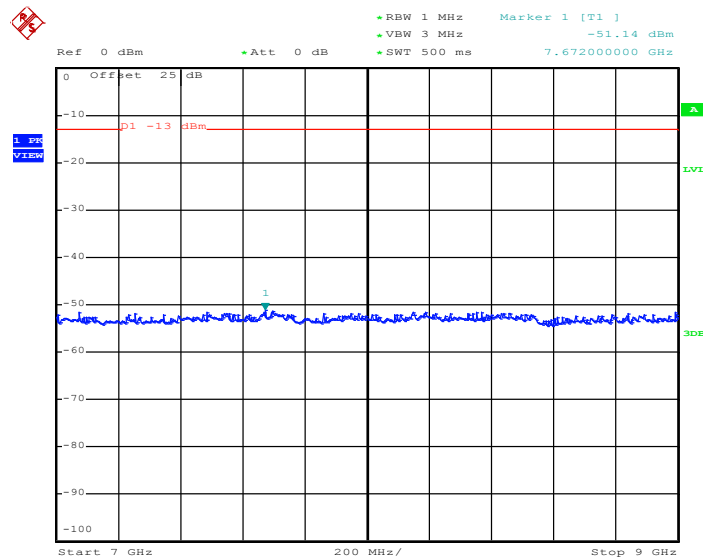

Date: 20.FEB.2014 11:07:26



Band :	GSM1900	Channel :	CH661
Test Mode :	GPRS class 8 Link (GMSK)	Frequency :	1880.0 MHz

Conducted Spurious Emission Plot between 30MHz ~ 1GHz

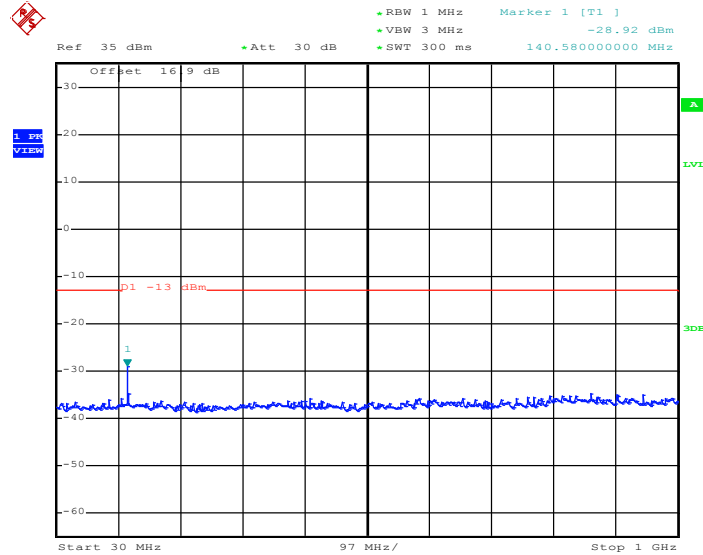

Date: 20.FEB.2014 11:34:21

Conducted Spurious Emission Plot between 1GHz ~ 3GHz

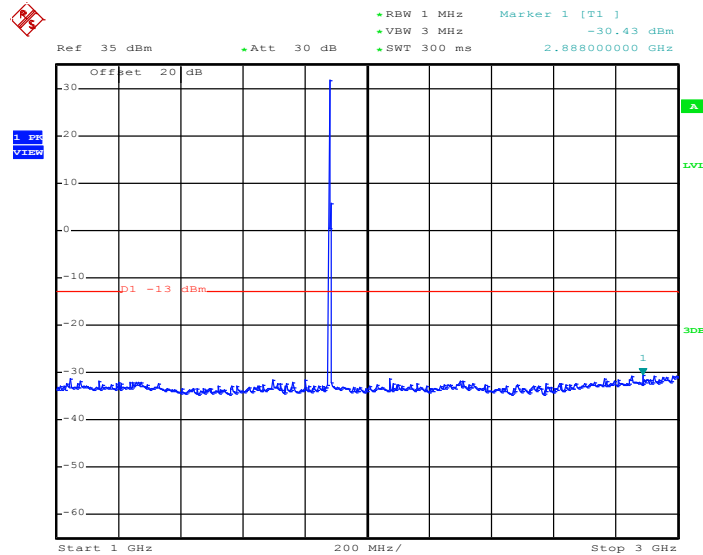

Date: 20.FEB.2014 11:34:30



Conducted Spurious Emission Plot between 3GHz ~ 7GHz

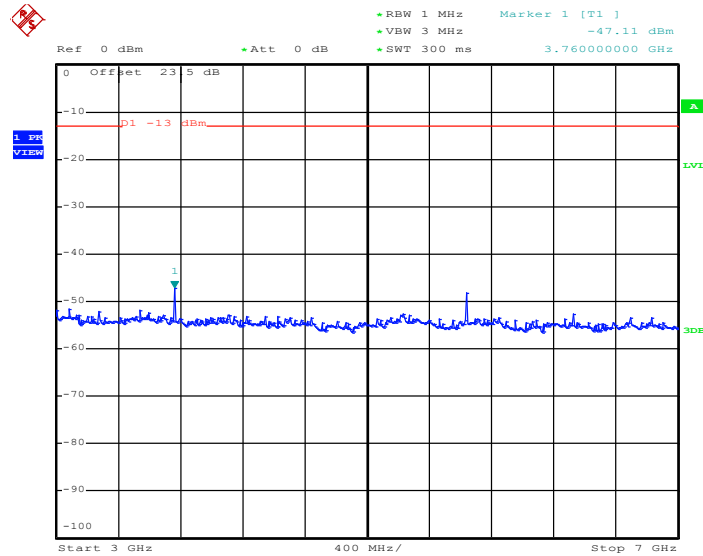

Date: 20.FEB.2014 11:34:45

Conducted Emission Plot between 7GHz ~ 13.6GHz

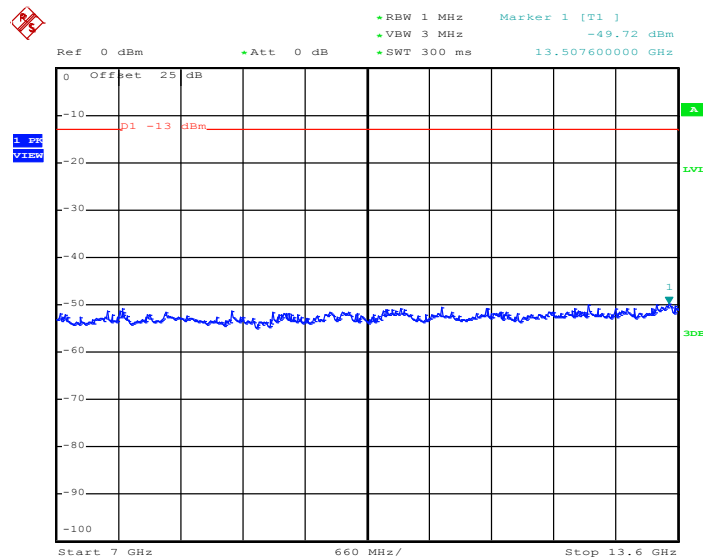

Date: 20.FEB.2014 11:34:53



Conducted Spurious Emission Plot between 13.6GHz ~ 19.1GHz

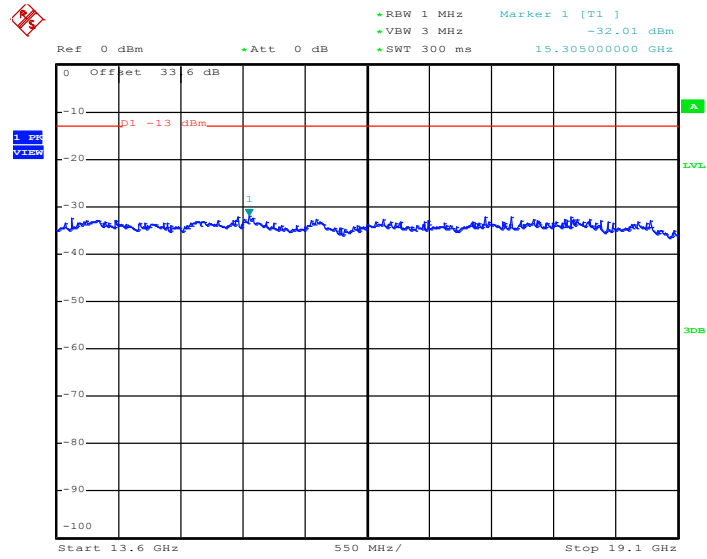

Date: 20.FEB.2014 11:35:01



Band :	GSM1900	Channel :	CH661
Test Mode :	EDGE class 8 Link (8PSK)	Frequency :	1880.0 MHz

Conducted Spurious Emission Plot between 30MHz ~ 1GHz

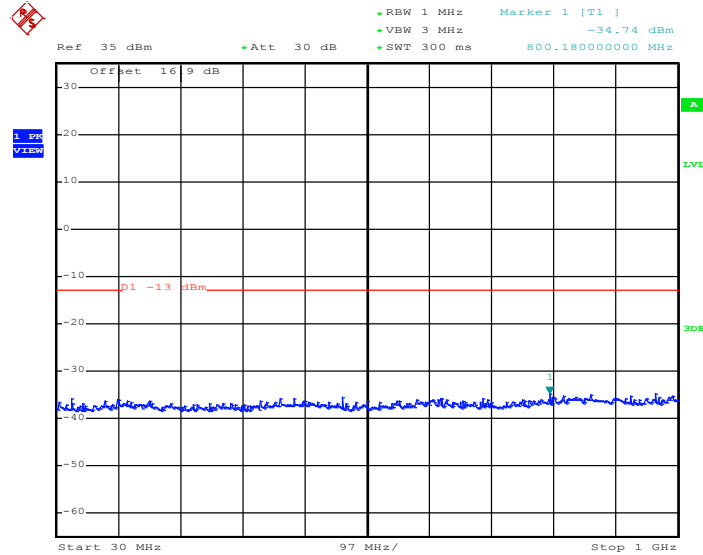

Date: 20.FEB.2014 12:39:54

Conducted Spurious Emission Plot between 1GHz ~ 3GHz

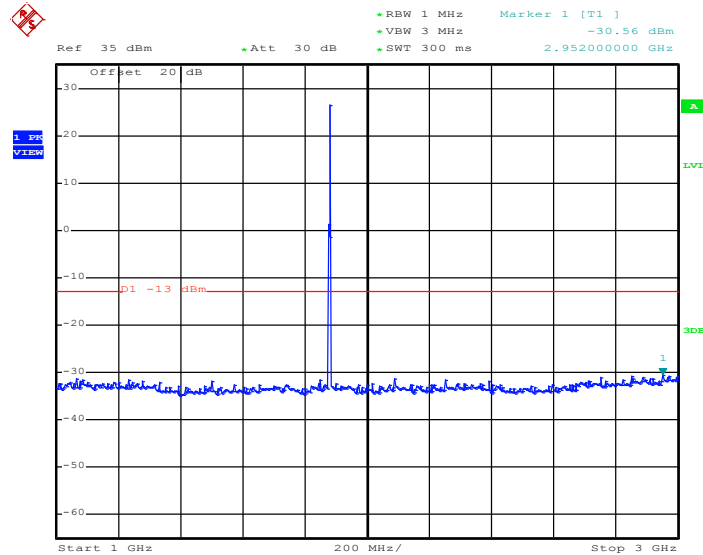

Date: 20.FEB.2014 12:40:02



Conducted Spurious Emission Plot between 3GHz ~ 7GHz

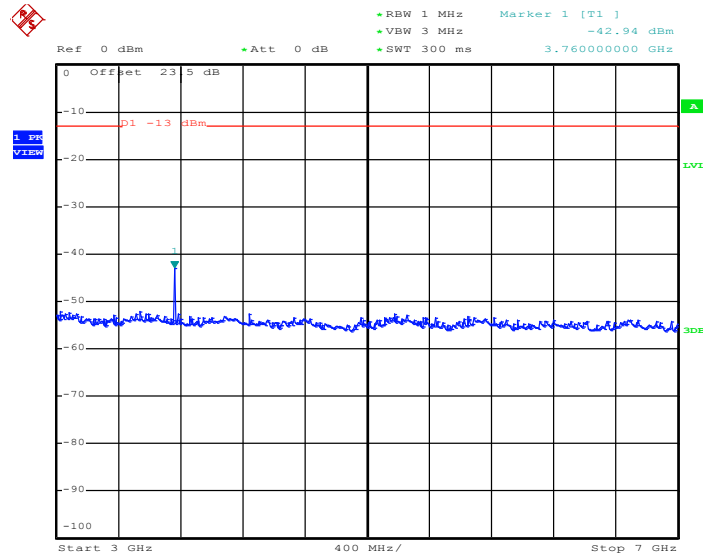

Date: 20.FEB.2014 12:40:14

Conducted Emission Plot between 7GHz ~ 13.6GHz

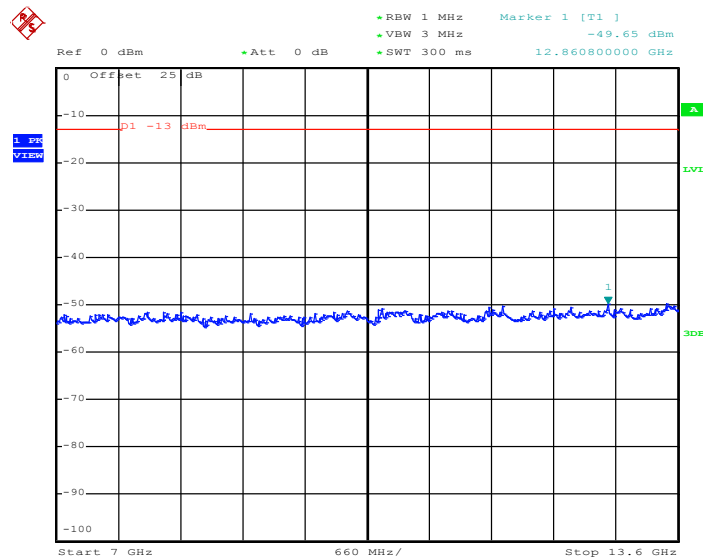

Date: 20.FEB.2014 12:40:22



Conducted Spurious Emission Plot between 13.6GHz ~ 19.1GHz

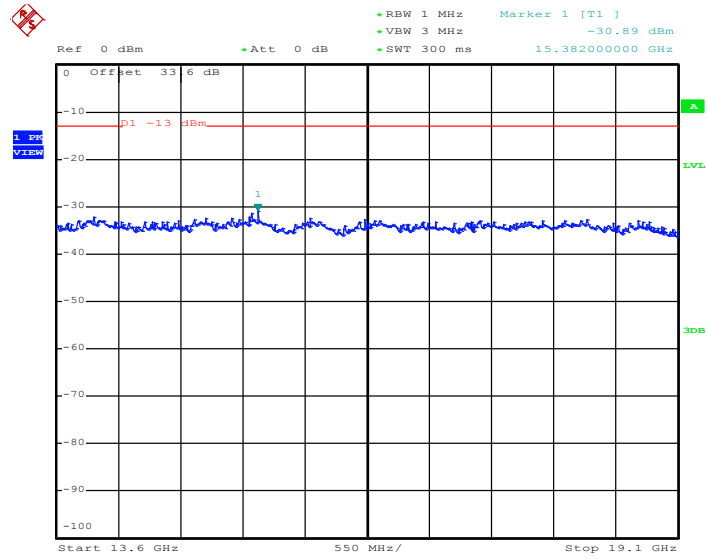

Date: 20.FEB.2014 12:40:31



Band :	WCDMA Band V	Channel :	CH4182
Test Mode :	RMC 12.2Kbps Link (QPSK)	Frequency :	836.4 MHz

Conducted Spurious Emission Plot between 30MHz ~ 1GHz

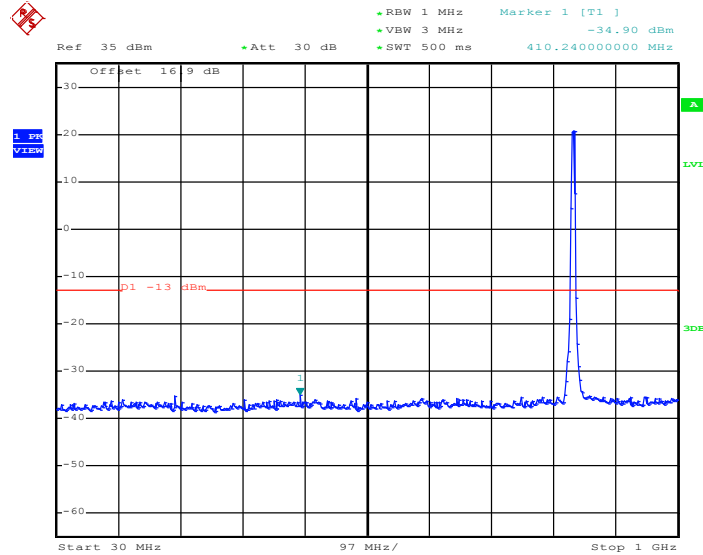

Date: 20.FEB.2014 14:07:21

Conducted Spurious Emission Plot between 1GHz ~ 3GHz

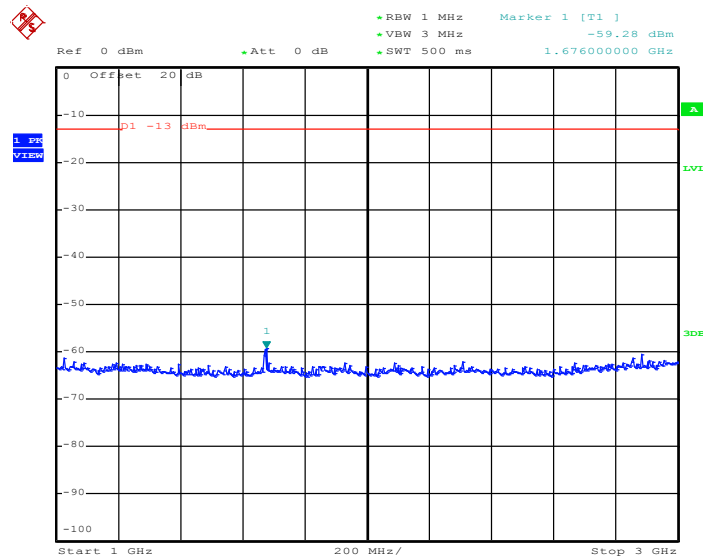

Date: 20.FEB.2014 14:07:34



Conducted Spurious Emission Plot between 3GHz ~ 7GHz

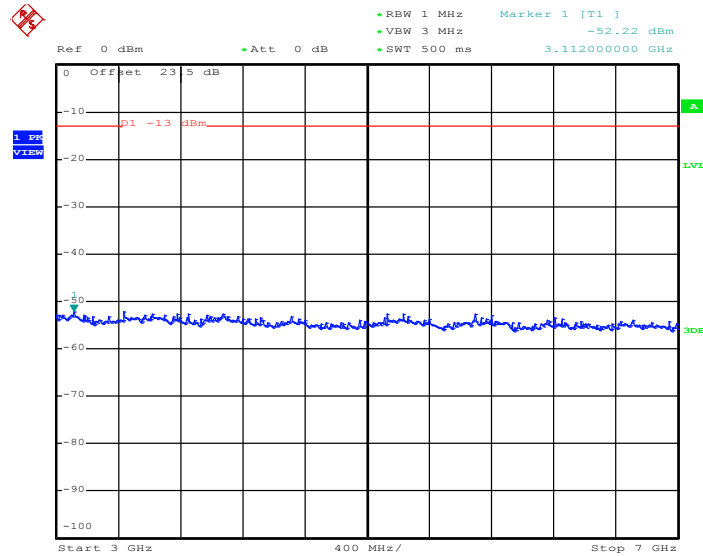

Date: 20.FEB.2014 14:07:42

Conducted Spurious Emission Plot between 7GHz ~ 9GHz

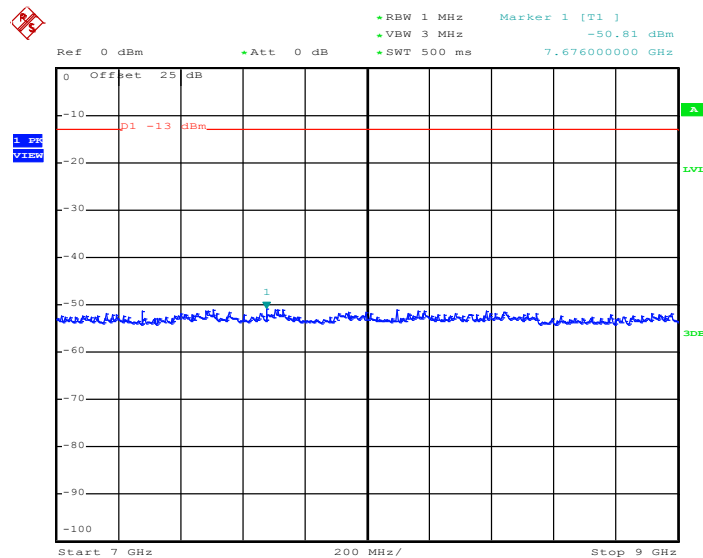

Date: 20.FEB.2014 14:07:50



Band :	WCDMA Band II	Channel :	CH9400
Test Mode :	RMC 12.2Kbps Link (QPSK)	Frequency :	1880.0 MHz

Conducted Spurious Emission Plot between 30MHz ~ 1GHz

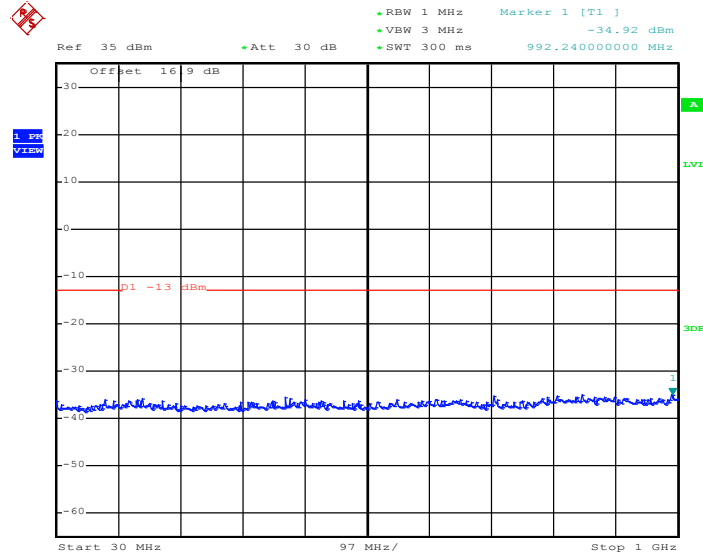

Date: 20.FEB.2014 13:46:02

Conducted Spurious Emission Plot between 1GHz ~ 3GHz

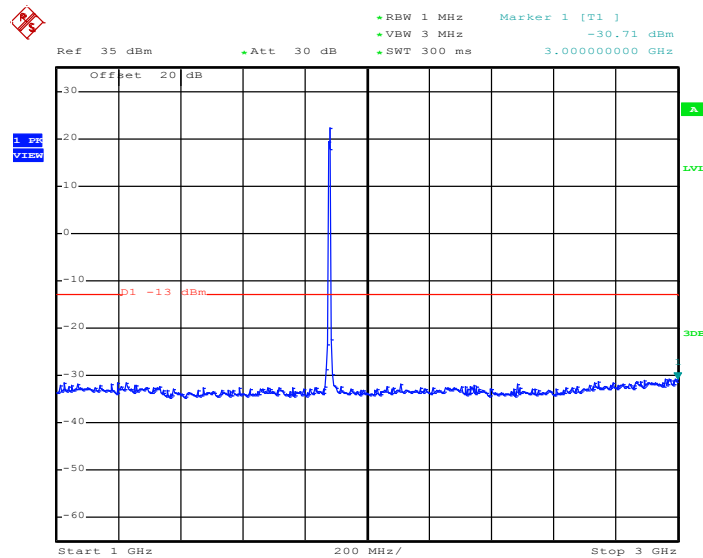

Date: 20.FEB.2014 13:46:10



Conducted Spurious Emission Plot between 13.6GHz ~ 19.1GHz

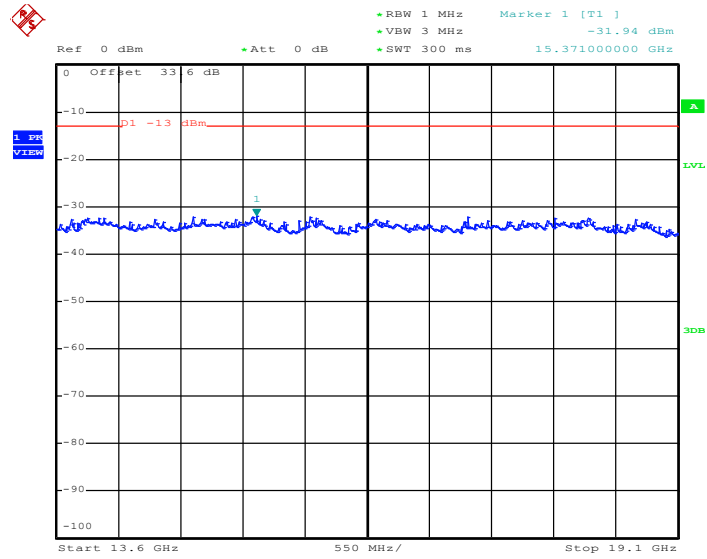

Date: 20.FEB.2014 13:46:40



3.7 Field Strength of Spurious Radiation Measurement

3.7.1 Description of Field Strength of Spurious Radiated Measurement

The power of any emission outside of the authorized operating frequency ranges must be attenuated below the transmitter power (P) by a factor of at least $43 + 10 \log (P)$ dB. The spectrum is scanned from 30 MHz up to a frequency including its 10th harmonic.

3.7.2 Measuring Instruments

The measuring equipment is listed in the section 4 of this test report.

3.7.3 Test Procedures

1. The EUT was placed on a rotatable wooden table with 0.8 meter above ground.
2. The EUT was set 3 meters from the receiving antenna, which was mounted on the antenna tower.
3. The table was rotated 360 degrees to determine the position of the highest spurious emission.
4. The height of the receiving antenna is varied between one meter and four meters to search the maximum spurious emission for both horizontal and vertical polarizations.
5. Make the measurement with the spectrum analyzer's RBW = 1MHz, VBW = 3MHz, taking the record of maximum spurious emission.
6. A horn antenna was substituted in place of the EUT and was driven by a signal generator.
7. Tune the output power of signal generator to the same emission level with EUT maximum spurious emission.
8. Taking the record of output power at antenna port.
9. Repeat step 7 to step 8 for another polarization.
10. The RF fundamental frequency should be excluded against the limit line in the operating frequency band.
11. The limit line is derived from $43 + 10\log(P)$ dB below the transmitter power P(Watts)
= $P(W) - [43 + 10\log(P)]$ (dB)
= $[30 + 10\log(P)]$ (dBm) - $[43 + 10\log(P)]$ (dB)
= -13dBm.
12. EIRP (dBm) = S.G. Power – Tx Cable Loss + Tx Antenna Gain
13. ERP (dBm) = EIRP - 2.15

3.7.4 Test Setup

For radiated emissions from 30MHz to 1GHz

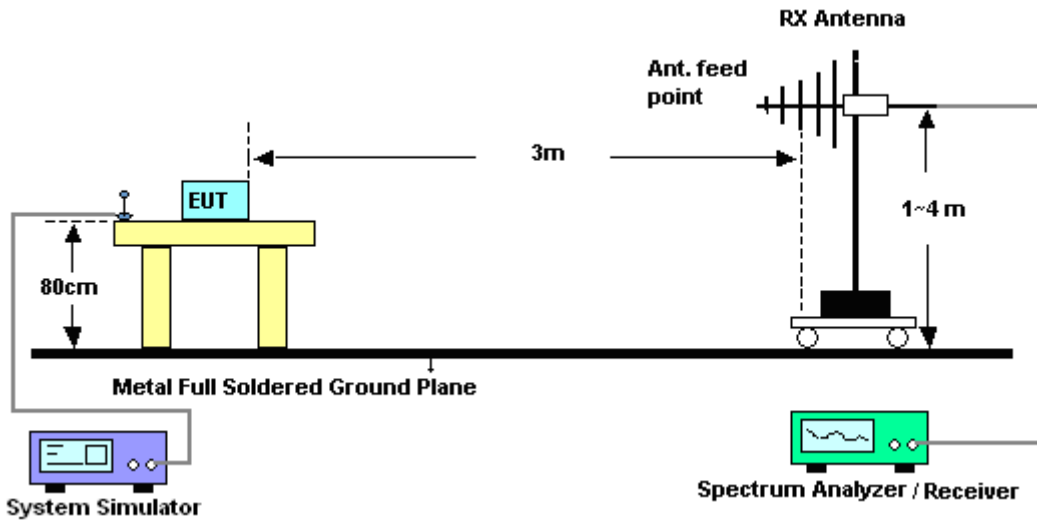

For radiated emissions above 1GHz

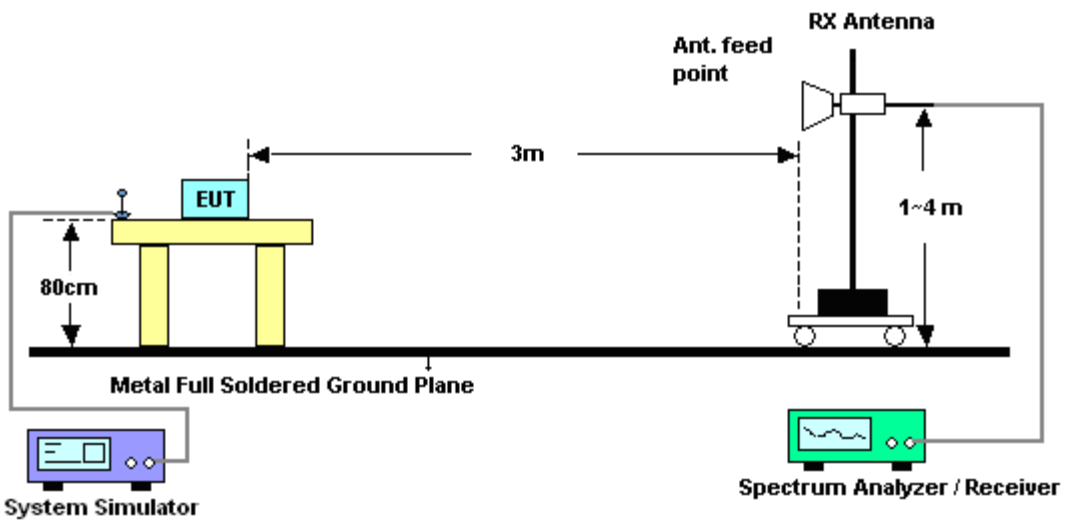



3.7.5 Test Result of Field Strength of Spurious Radiated

Band :	GSM850	Temperature :	20~22°C
Test Mode :	GPRS class 8 Link (GMSK)	Relative Humidity :	43~45%
Test Engineer :	Eric Shih	Polarization :	Horizontal
Remark :	Spurious emissions within 30-1000MHz were found more than 20dB below limit line.		

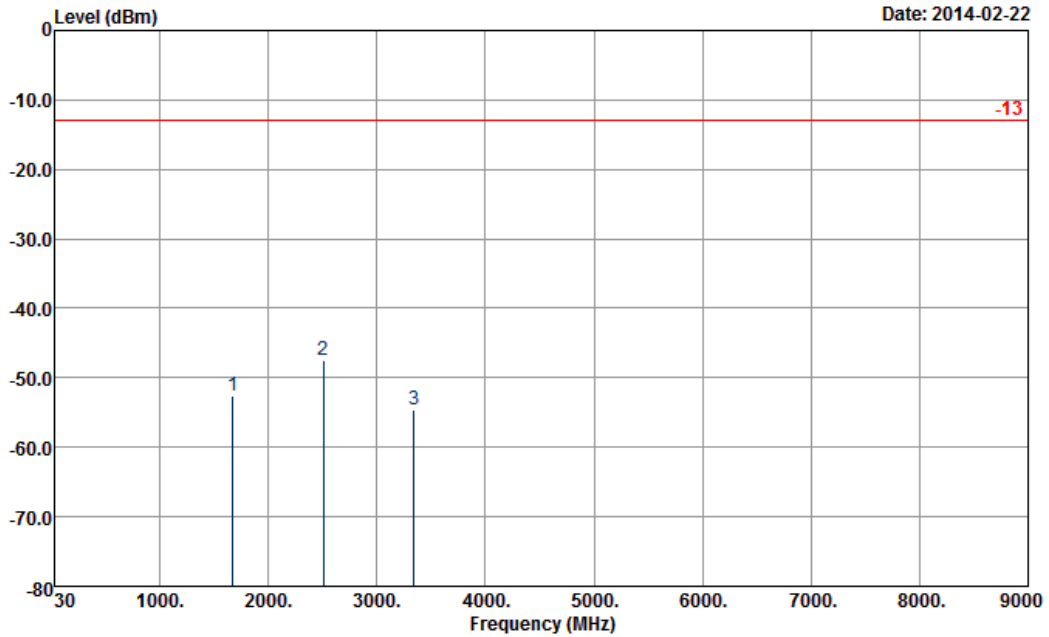

Site : 03CH07-HY
 Condition : -13 HF-EIRP(080306) HORIZONTAL

Frequency (MHz)	ERP (dBm)	Limit (dBm)	Over Limit (dB)	SPA Reading (dBm)	S.G. Power (dBm)	TX Cable loss (dB)	TX Antenna Gain (dBi)	Polarization (H/V)	Result
1672	-52.63	-13	-39.63	-61.98	-56.5	1.62	5.49	H	Pass
2509	-47.38	-13	-34.38	-61.06	-51.5	2.1	6.22	H	Pass
3345	-54.56	-13	-41.56	-68.44	-59.6	3.03	8.07	H	Pass



Band :	GSM850	Temperature :	20~22°C
Test Mode :	GPRS class 8 Link (GMSK)	Relative Humidity :	43~45%
Test Engineer :	Eric Shih	Polarization :	Vertical
Remark :	Spurious emissions within 30-1000MHz were found more than 20dB below limit line.		

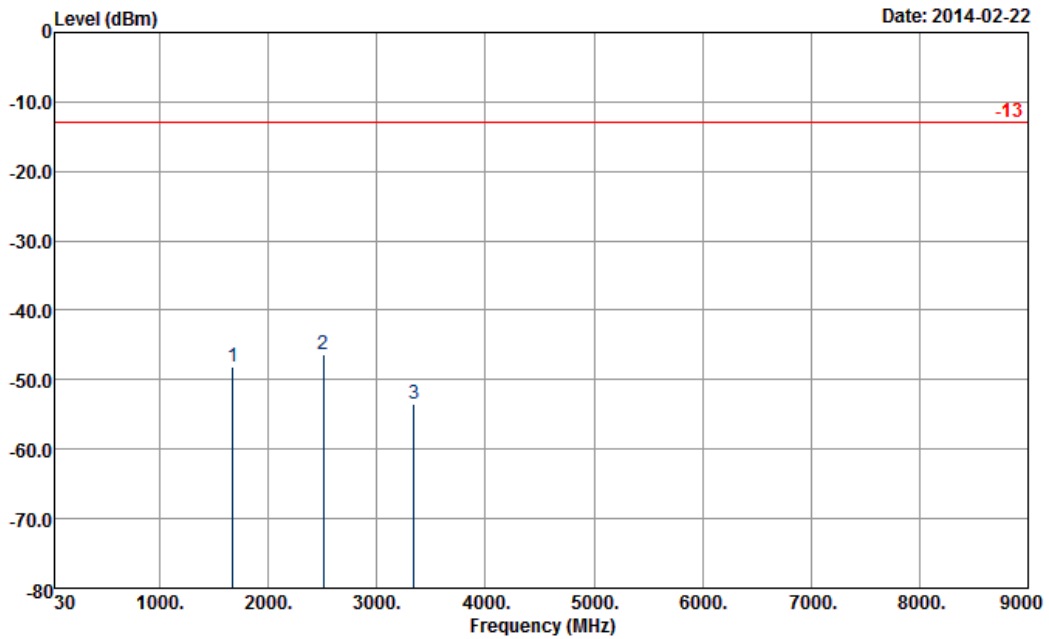

Site : 03CH07-HY
 Condition : -13 HF-EIRP(080306) VERTICAL

Frequency (MHz)	ERP (dBm)	Limit (dBm)	Over Limit (dB)	SPA Reading (dBm)	S.G. Power (dBm)	TX Cable loss (dB)	TX Antenna Gain (dBi)	Polarization (H/V)	Result
1672	-48.13	-13	-35.13	-59.19	-52	1.62	5.49	V	Pass
2509	-46.28	-13	-33.28	-60.27	-50.4	2.1	6.22	V	Pass
3345	-53.46	-13	-40.46	-69.33	-58.5	3.03	8.07	V	Pass



Band :	GSM850	Temperature :	20~22°C
Test Mode :	EDGE class 8 Link (8PSK)	Relative Humidity :	43~45%
Test Engineer :	Eric Shih	Polarization :	Horizontal
Remark :	Spurious emissions within 30-1000MHz were found more than 20dB below limit line.		

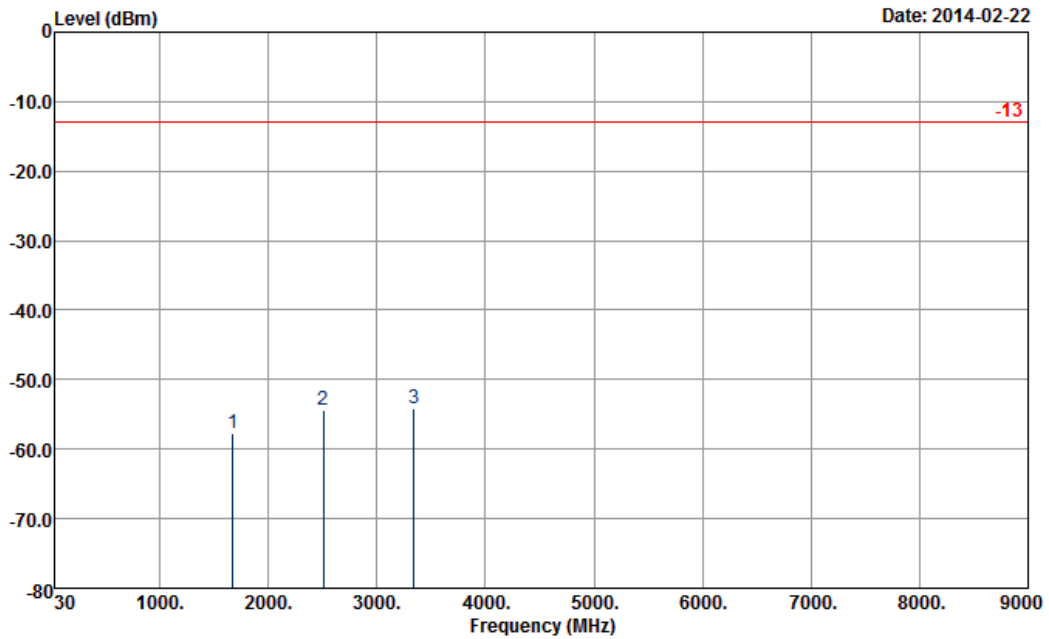

Site : 03CH07-HY
 Condition : -13 HF-EIRP(080306) HORIZONTAL

Frequency (MHz)	ERP (dBm)	Limit (dBm)	Over Limit (dB)	SPA Reading (dBm)	S.G. Power (dBm)	TX Cable loss (dB)	TX Antenna Gain (dBi)	Polarization (H/V)	Result
1672	-57.63	-13	-44.63	-66.8	-61.5	1.62	5.49	H	Pass
2509	-54.28	-13	-41.28	-67.75	-58.4	2.1	6.22	H	Pass
3345	-54.26	-13	-41.26	-69.07	-59.3	3.03	8.07	H	Pass



Band :	GSM850	Temperature :	20~22°C
Test Mode :	EDGE class 8 Link (8PSK)	Relative Humidity :	43~45%
Test Engineer :	Eric Shih	Polarization :	Vertical
Remark :	Spurious emissions within 30-1000MHz were found more than 20dB below limit line.		

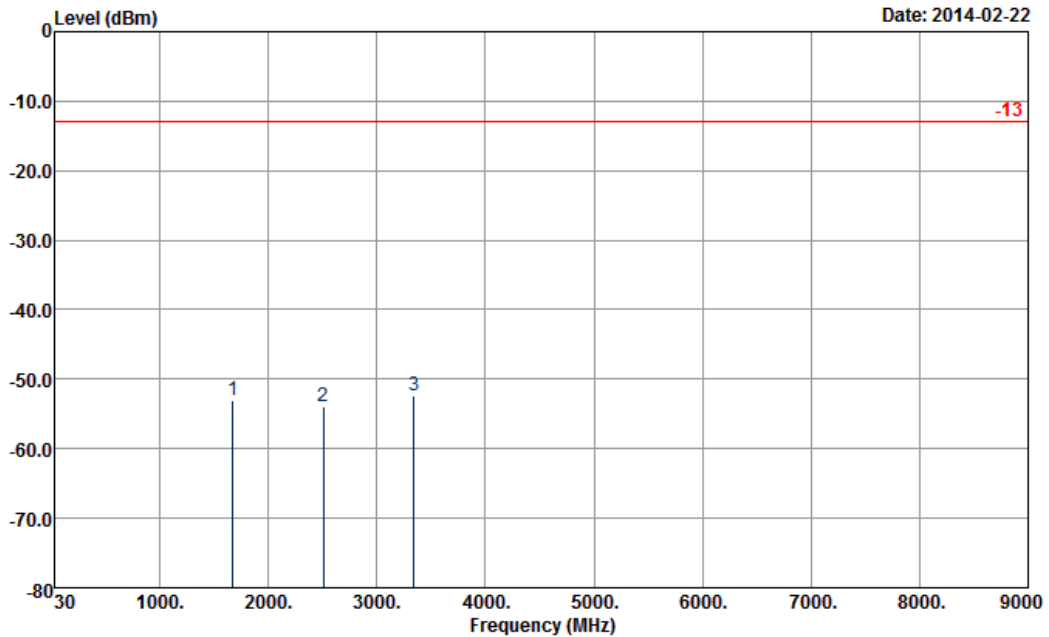

Site : 03CH07-HY
 Condition : -13 HF-EIRP(080306) VERTICAL

Frequency (MHz)	ERP (dBm)	Limit (dBm)	Over Limit (dB)	SPA Reading (dBm)	S.G. Power (dBm)	TX Cable loss (dB)	TX Antenna Gain (dBi)	Polarization (H/V)	Result
1672	-53.03	-13	-40.03	-64.93	-56.9	1.62	5.49	V	Pass
2509	-53.98	-13	-40.98	-67.7	-58.1	2.1	6.22	V	Pass
3345	-52.46	-13	-39.46	-68.12	-57.5	3.03	8.07	V	Pass



Band :	GSM1900	Temperature :	20~22°C
Test Mode :	GPRS class 8 Link (GMSK)	Relative Humidity :	43~45%
Test Engineer :	Eric Shih	Polarization :	Horizontal
Remark :	Spurious emissions within 30-1000MHz were found more than 20dB below limit line.		

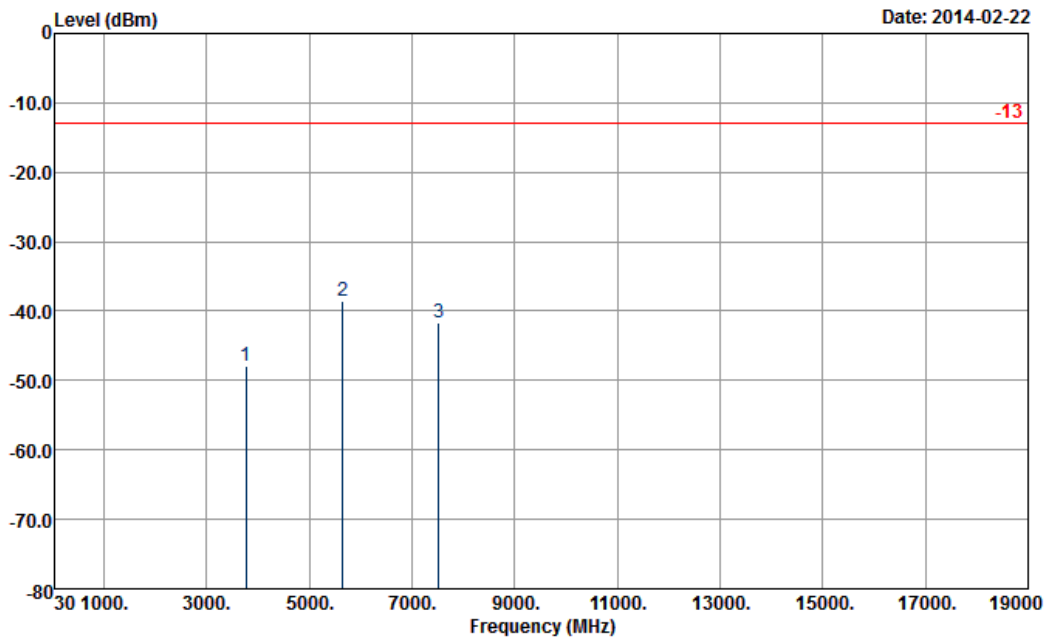

Site : 03CH07-HY
 Condition : -13 HF-EIRP(080306) HORIZONTAL

Frequency (MHz)	EIRP (dBm)	Limit (dBm)	Over Limit (dB)	SPA Reading (dBm)	S.G. Power (dBm)	TX Cable loss (dB)	TX Antenna Gain (dBi)	Polarization (H/V)	Result
3760	-47.90	-13	-34.90	-63.36	-54.2	2.51	8.81	H	Pass
5640	-38.49	-13	-25.49	-59.33	-46.2	2.99	10.70	H	Pass
7520	-41.67	-13	-28.67	-69.18	-50.2	3.59	12.12	H	Pass



Band :	GSM1900	Temperature :	20~22°C
Test Mode :	GPRS class 8 Link (GMSK)	Relative Humidity :	43~45%
Test Engineer :	Eric Shih	Polarization :	Vertical
Remark :	Spurious emissions within 30-1000MHz were found more than 20dB below limit line.		

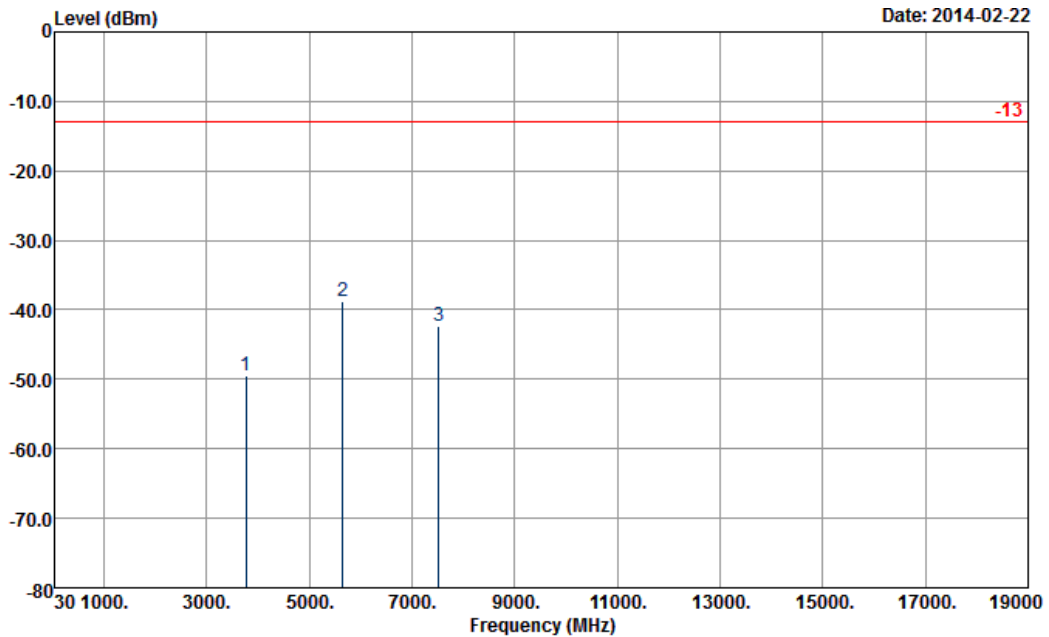

Site : 03CH07-HY
 Condition : -13 HF-EIRP(080306) VERTICAL

Frequency (MHz)	EIRP (dBm)	Limit (dBm)	Over Limit (dB)	SPA Reading (dBm)	S.G. Power (dBm)	TX Cable loss (dB)	TX Antenna Gain (dBi)	Polarization (H/V)	Result
3760	-49.50	-13	-36.50	-65.94	-55.8	2.51	8.81	V	Pass
5640	-38.79	-13	-25.79	-59.93	-46.5	2.99	10.70	V	Pass
7520	-42.27	-13	-29.27	-69.36	-50.8	3.59	12.12	V	Pass



Band :	GSM1900	Temperature :	20~22°C
Test Mode :	EDGE class 8 Link (8PSK)	Relative Humidity :	43~45%
Test Engineer :	Eric Shih	Polarization :	Horizontal
Remark :	Spurious emissions within 30-1000MHz were found more than 20dB below limit line.		

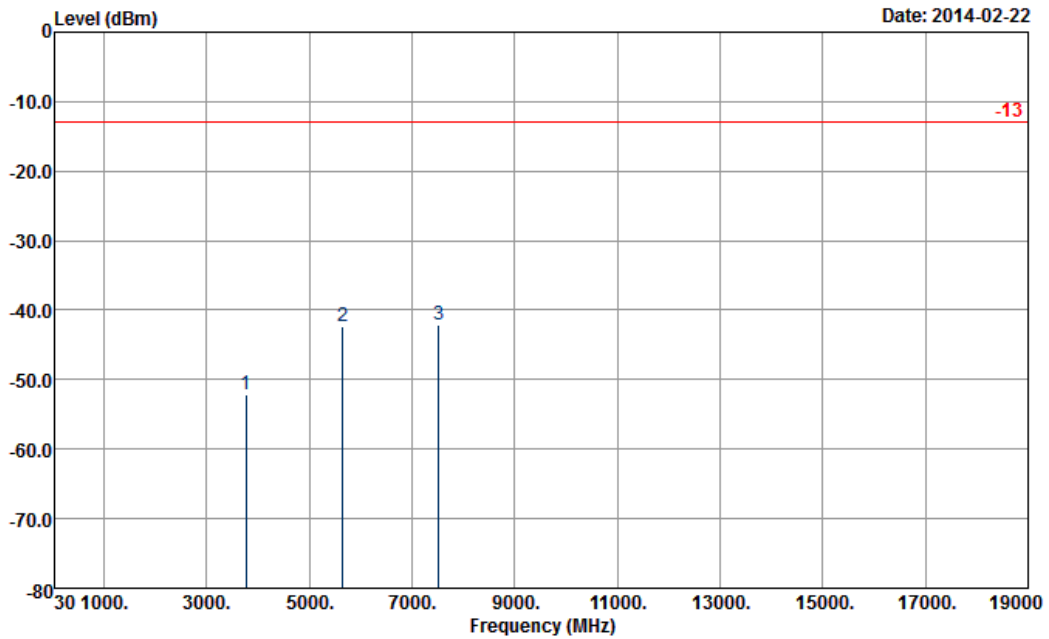

Site : 03CH07-HY
 Condition : -13 HF-EIRP(080306) HORIZONTAL

Frequency (MHz)	EIRP (dBm)	Limit (dBm)	Over Limit (dB)	SPA Reading (dBm)	S.G. Power (dBm)	TX Cable loss (dB)	TX Antenna Gain (dBi)	Polarization (H/V)	Result
3760	-52.20	-13	-39.20	-67.65	-58.5	2.51	8.81	H	Pass
5640	-42.29	-13	-29.29	-63.09	-50	2.99	10.70	H	Pass
7520	-42.07	-13	-29.07	-69.72	-50.6	3.59	12.12	H	Pass



Band :	GSM1900	Temperature :	20~22°C
Test Mode :	EDGE class 8 Link (8PSK)	Relative Humidity :	43~45%
Test Engineer :	Eric Shih	Polarization :	Vertical
Remark :	Spurious emissions within 30-1000MHz were found more than 20dB below limit line.		

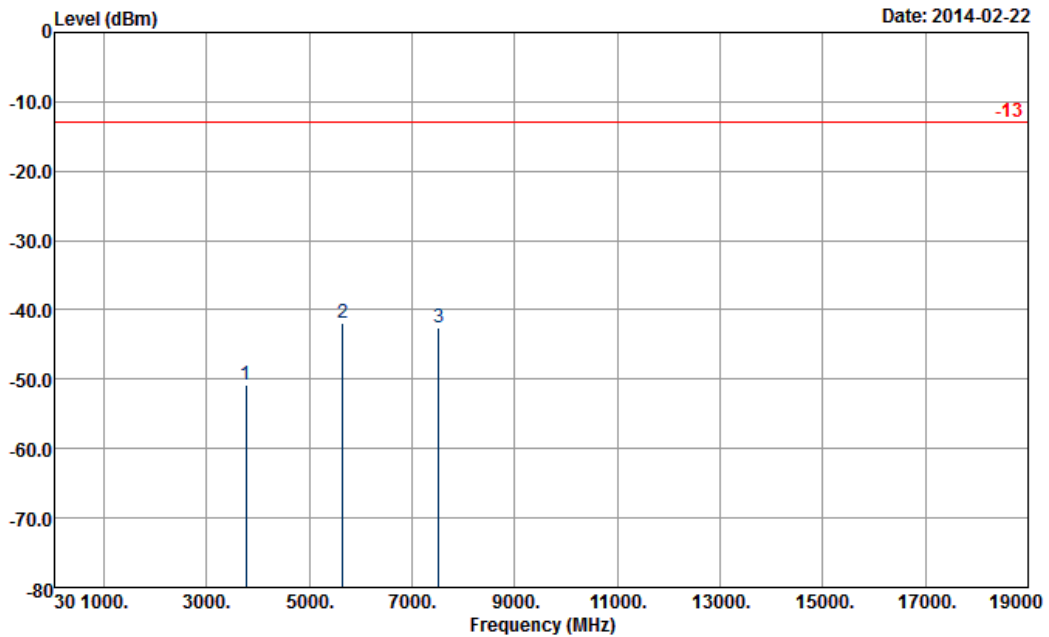

Site : 03CH07-HY
 Condition : -13 HF-EIRP(080306) VERTICAL

Frequency (MHz)	EIRP (dBm)	Limit (dBm)	Over Limit (dB)	SPA Reading (dBm)	S.G. Power (dBm)	TX Cable loss (dB)	TX Antenna Gain (dBi)	Polarization (H/V)	Result
3760	-50.90	-13	-37.90	-67.32	-57.2	2.51	8.81	V	Pass
5640	-41.99	-13	-28.99	-62.56	-49.7	2.99	10.70	V	Pass
7520	-42.57	-13	-29.57	-69.77	-51.1	3.59	12.12	V	Pass



Band :	WCDMA Band V	Temperature :	20~22°C
Test Mode :	RMC 12.2Kbps Link (QPSK)	Relative Humidity :	43~45%
Test Engineer :	Eric Shih	Polarization :	Horizontal
Remark :	Spurious emissions within 30-1000MHz were found more than 20dB below limit line.		

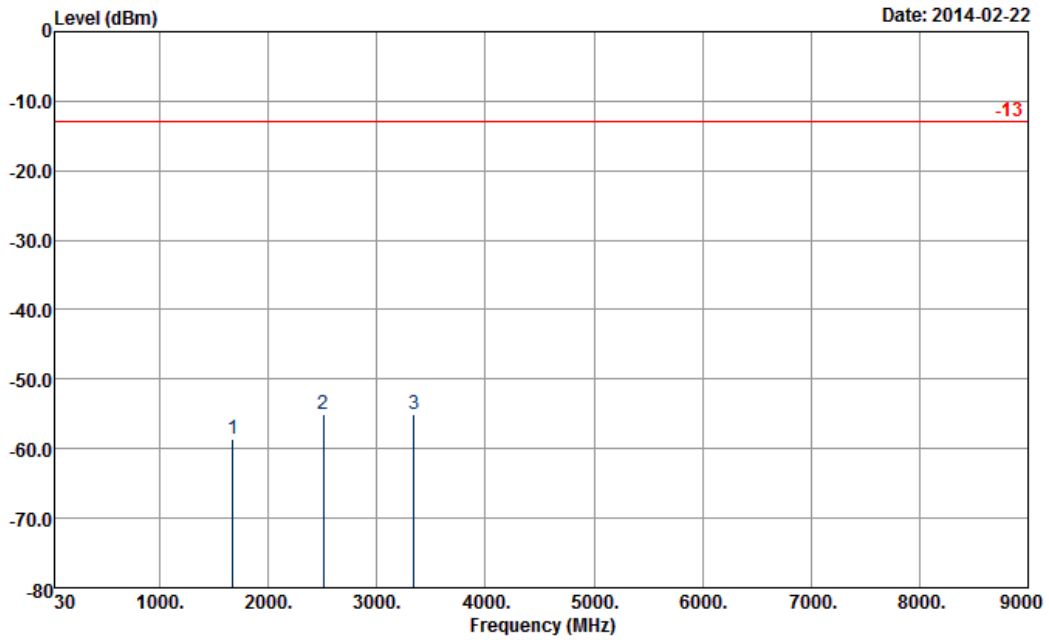

Site : 03CH07-HY
 Condition : -13 HF-EIRP(080306) HORIZONTAL

Frequency (MHz)	ERP (dBm)	Limit (dBm)	Over Limit (dB)	SPA Reading (dBm)	S.G. Power (dBm)	TX Cable loss (dB)	TX Antenna Gain (dBi)	Polarization (H/V)	Result
1672	-58.63	-13	-45.63	-67.78	-62.5	1.62	5.49	H	Pass
2509	-55.08	-13	-42.08	-68.31	-59.2	2.1	6.22	H	Pass
3345	-55.06	-13	-42.06	-69.13	-60.1	3.03	8.07	H	Pass



Band :	WCDMA Band V	Temperature :	20~22°C
Test Mode :	RMC 12.2Kbps Link (QPSK)	Relative Humidity :	43~45%
Test Engineer :	Eric Shih	Polarization :	Vertical
Remark :	Spurious emissions within 30-1000MHz were found more than 20dB below limit line.		

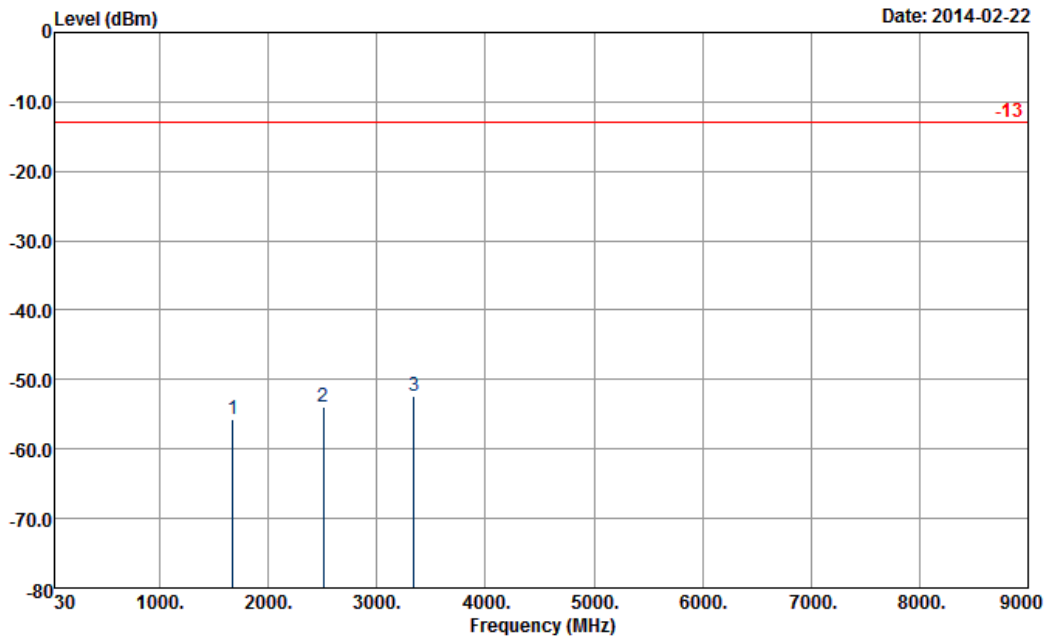

Site : 03CH07-HY
 Condition : -13 HF-EIRP(080306) VERTICAL

Frequency (MHz)	ERP (dBm)	Limit (dBm)	Over Limit (dB)	SPA Reading (dBm)	S.G. Power (dBm)	TX Cable loss (dB)	TX Antenna Gain (dBi)	Polarization (H/V)	Result
1672	-55.63	-13	-42.63	-67.12	-59.5	1.62	5.49	V	Pass
2509	-53.88	-13	-40.88	-67.87	-58	2.1	6.22	V	Pass
3345	-52.46	-13	-39.46	-68.72	-57.5	3.03	8.07	V	Pass



Band :	WCDMA Band II	Temperature :	20~22°C
Test Mode :	RMC 12.2Kbps Link (QPSK)	Relative Humidity :	43~45%
Test Engineer :	Eric Shih	Polarization :	Horizontal
Remark :	Spurious emissions within 30-1000MHz were found more than 20dB below limit line.		

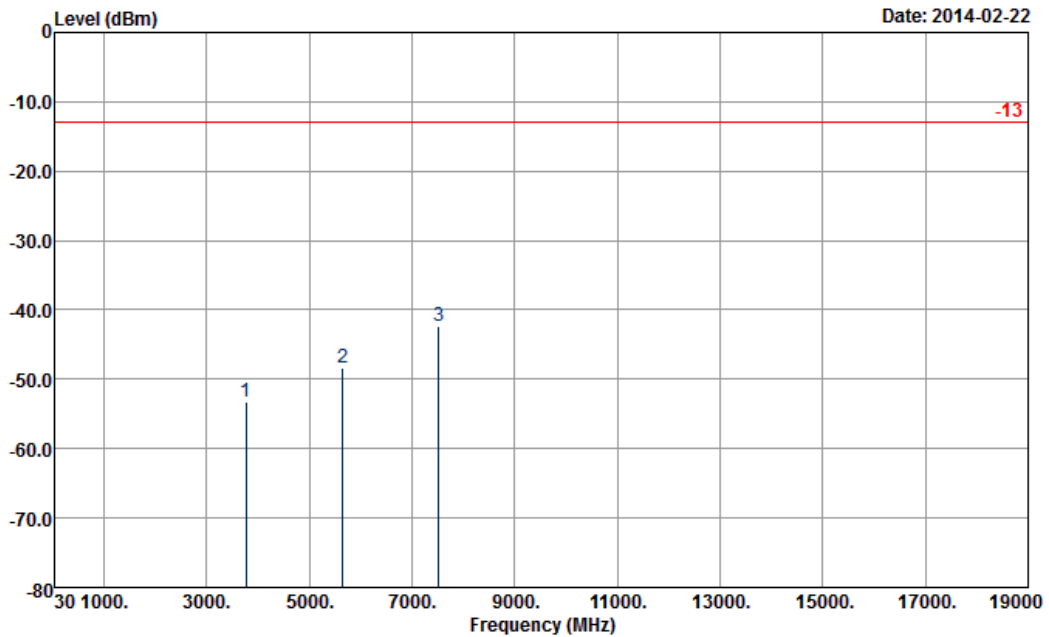

Site : 03CH07-HY
 Condition : -13 HF-EIRP(080306) HORIZONTAL

Frequency (MHz)	EIRP (dBm)	Limit (dBm)	Over Limit (dB)	SPA Reading (dBm)	S.G. Power (dBm)	TX Cable loss (dB)	TX Antenna Gain (dBi)	Polarization (H/V)	Result
3760	-53.20	-13	-40.20	-68.85	-59.5	2.51	8.81	H	Pass
5640	-48.39	-13	-35.39	-68.95	-56.1	2.99	10.70	H	Pass
7520	-42.27	-13	-29.27	-70.04	-50.8	3.59	12.12	H	Pass



Band :	WCDMA Band II	Temperature :	20~22°C
Test Mode :	RMC 12.2Kbps Link (QPSK)	Relative Humidity :	43~45%
Test Engineer :	Eric Shih	Polarization :	Vertical
Remark :	Spurious emissions within 30-1000MHz were found more than 20dB below limit line.		

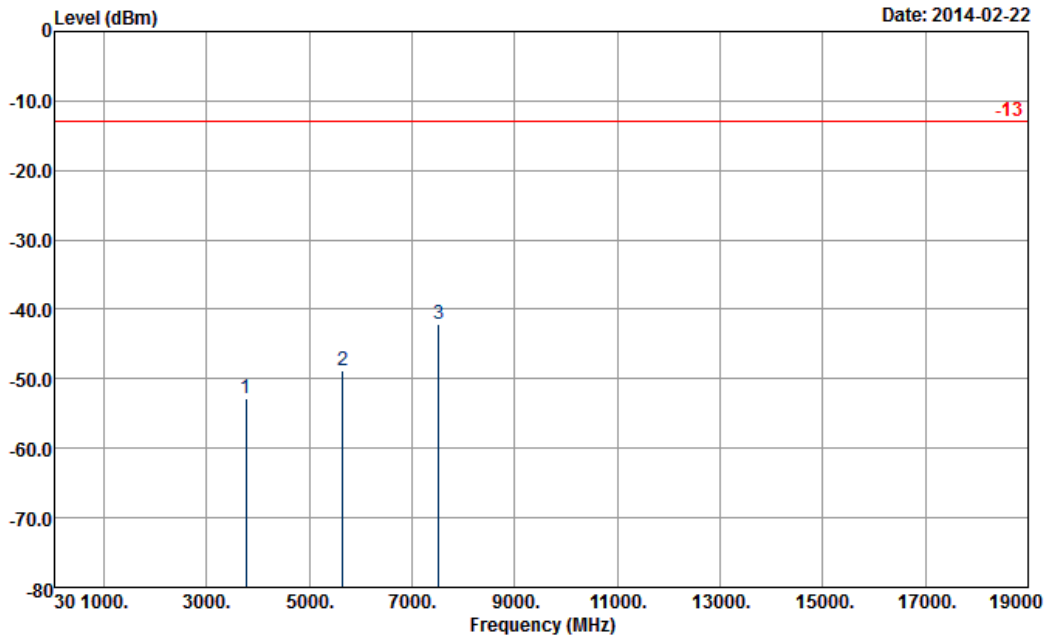

Site : 03CH07-HY
 Condition : -13 HF-EIRP(080306) VERTICAL

Frequency (MHz)	EIRP (dBm)	Limit (dBm)	Over Limit (dB)	SPA Reading (dBm)	S.G. Power (dBm)	TX Cable loss (dB)	TX Antenna Gain (dBi)	Polarization (H/V)	Result
3760	-52.90	-13	-39.90	-69.24	-59.2	2.51	8.81	V	Pass
5640	-48.79	-13	-35.79	-69.57	-56.5	2.99	10.70	V	Pass
7520	-42.07	-13	-29.07	-68.91	-50.6	3.59	12.12	V	Pass

3.8 Frequency Stability Measurement

3.8.1 Description of Frequency Stability Measurement

The frequency stability shall be measured by variation of ambient temperature and variation of primary supply voltage to ensure that the fundamental emission stays within the authorized frequency block. The frequency stability of the transmitter shall be maintained within $\pm 0.00025\%$ ($\pm 2.5\text{ppm}$) of the center frequency.

3.8.2 Measuring Instruments

The measuring equipment is listed in the section 4 of this test report.

3.8.3 Test Procedures for Temperature Variation

1. The EUT was set up in the thermal chamber and connected with the base station.
2. With power OFF, the temperature was decreased to -30°C and the EUT was stabilized before testing. Power was applied and the maximum change in frequency was recorded within one minute.
3. With power OFF, the temperature was raised in 10°C step up to 50°C . The EUT was stabilized at each step for at least half an hour. Power was applied and the maximum frequency change was recorded within one minute.

3.8.4 Test Procedures for Voltage Variation

1. The EUT was placed in a temperature chamber at $25\pm 5^{\circ}\text{C}$ and connected with the base station.
2. The power supply voltage to the EUT was varied from BEP to 115% of the nominal value measured at the input to the EUT.
3. The variation in frequency was measured for the worst case.

3.8.5 Test Setup

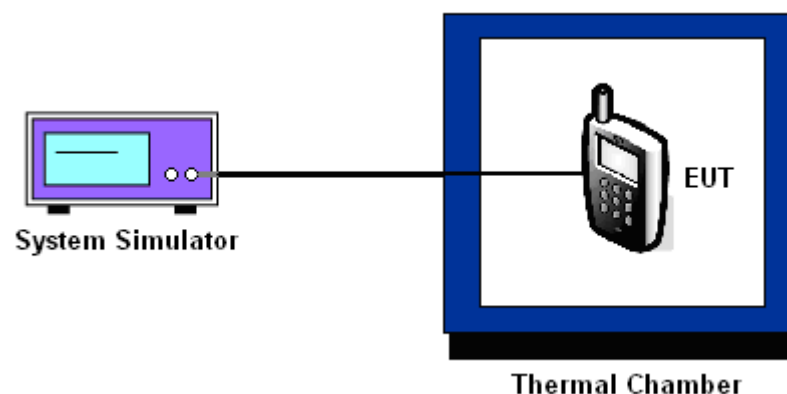



3.8.6 Test Result of Temperature Variation

Band :	GSM 850	Channel :	189
Limit (ppm) :	2.5	Frequency :	836.4 MHz

Temperature (°C)	GPRS class 8	EDGE class 8	Result
	Deviation (ppm)	Deviation (ppm)	
50	0.0478	0.0359	PASS
40	0.0442	0.0311	
30	0.0466	0.0323	
20	0.0418	0.0299	
10	0.0395	0.0275	
0	0.0454	0.0299	
-10	0.0442	0.0263	
-20	0.0478	0.0287	
-30	0.0466	0.0323	

Band :	GSM 1900	Channel :	661
Limit (ppm) :	2.5	Frequency :	1880.0 MHz

Temperature (°C)	GPRS class 8	EDGE class 8	Result
	Deviation (ppm)	Deviation (ppm)	
50	0.0356	0.0394	PASS
40	0.0340	0.0378	
30	0.0330	0.0351	
20	0.0303	0.0372	
10	0.0309	0.0367	
0	0.0319	0.0399	
-10	0.0330	0.0388	
-20	0.0324	0.0383	
-30	0.0346	0.0399	



Band :	WCDMA Band V	Channel :	4182
Limit (ppm) :	2.5	Frequency :	836.4 MHz

Temperature (°C)	RMC 12.2Kbps	Result
	Deviation (ppm)	
50	0.0132	PASS
40	0.0084	
30	0.0072	
20	0.0060	
10	0.0060	
0	0.0072	
-10	0.0096	
-20	0.0096	
-30	0.0120	

Band :	WCDMA Band II	Channel :	9400
Limit (ppm) :	2.5	Frequency :	1880.0 MHz

Temperature (°C)	RMC 12.2Kbps	Result
	Deviation (ppm)	
50	0.0053	PASS
40	0.0048	
30	0.0032	
20	0.0037	
10	0.0053	
0	0.0043	
-10	0.0048	
-20	0.0059	
-30	0.0074	



3.8.7 Test Result of Voltage Variation

Band & Channel	Mode	Voltage (Volt)	Deviation (ppm)	Limit (ppm)	Result
GSM 850 CH189	GPRS class 8	4.35	0.0418	2.5	PASS
		3.80	0.0371		
		BEP	0.0442		
	EDGE class 8	4.35	0.0287		
		3.80	0.0275		
		BEP	0.0311		
GSM 1900 CH661	GPRS class 8	4.35	0.0324		
		3.80	0.0319		
		BEP	0.0309		
	EDGE class 8	4.35	0.0372		
		3.80	0.0362		
		BEP	0.0378		
WCDMA Band V CH4182	RMC 12.2Kbps	4.35	0.0060		
		3.80	0.0060		
		BEP	0.0048		
WCDMA Band II CH9400	RMC 12.2Kbps	4.35	0.0037		
		3.80	0.0037		
		BEP	0.0048		

Note:

1. Normal Voltage = 3.80V.
2. Battery End Point (BEP) = 3.60 V.



4 List of Measuring Equipment

Instrument	Manufacturer	Model No.	Serial No.	Characteristics	Calibration Date	Test Date	Due Date	Remark
System Simulator	Rohde & Schwarz	CMU200	117995	N/A	Aug. 01, 2013	Feb. 20, 2014	Jul. 31, 2014	Conducted (TH02-HY)
Spectrum Analyzer	Rohde & Schwarz	FSP40	100055	9kHz~40GHz	Jun. 07, 2013	Feb. 20, 2014	Jun. 06, 2014	Conducted (TH02-HY)
Thermal Chamber	Ten Billion	TTH-D3SP	TBN-930701	N/A	Jul. 19, 2013	Feb. 20, 2014	Jul. 18, 2014	Conducted (TH02-HY)
Spectrum Analyzer	Rohde & Schwarz	FSP30	101067	9kHz ~ 30GHz	Nov. 20, 2013	Feb. 22, 2014	Nov. 19, 2014	Radiation (03CH07-HY)
Bilog Antenna	Schaffner	CBL6111C	2726	30MHz ~ 1GHz	Oct. 10, 2013	Feb. 22, 2014	Oct. 09, 2014	Radiation (03CH07-HY)
Double Ridge Horn Antenna	ESCO	3117	75962	1GHz~18GHz	Aug. 22, 2013	Feb. 22, 2014	Aug. 21, 2014	Radiation (03CH07-HY)
Preamplifier	SONOMA	310N	187231	9kHz~1GHz	May 15, 2013	Feb. 22, 2014	May 14, 2014	Radiation (03CH07-HY)
Preamplifier	Agilent	8449B	3008A02362	1 GHz~26.5 GHz	Nov. 29, 2013	Feb. 22, 2014	Nov. 28, 2014	Radiation (03CH07-HY)
SHF-EHF Horn Antenna	SCHWARZBECK	BBHA 9170	BBHA917025 1	15GHz- 40GHz	Oct. 03, 2013	Feb. 22, 2014	Oct. 02, 2014	Radiation (03CH07-HY)
Turn Table	ChainTek	ChainTek 3000	N/A	0 ~ 360 degree	N/A	Feb. 22, 2014	N/A	Radiation (03CH07-HY)
Antenna Mast	ChainTek	M-400-0	114/8000604/ L	N/A	N/A	Feb. 22, 2014	N/A	Radiation (03CH07-HY)



5 Uncertainty of Evaluation

Uncertainty of Radiated Emission Measurement (30 MHz ~ 1000 MHz)

Measuring Uncertainty for a Level of Confidence of 95% ($U = 2Uc(y)$)	4.50
---	------