



A D T

# FCC TEST REPORT (PART 90S)

**REPORT NO.:** RF140123C02-3  
**MODEL NO.:** 0P9C300  
**FCC ID:** NM80P9C300  
**RECEIVED:** Jan. 23, 2014  
**TESTED:** Feb. 06, 2014 ~ Mar. 11, 2014  
**ISSUED:** Mar. 28, 2014

**APPLICANT:** HTC Corporation

**ADDRESS:** No. 23, Xinghua Rd., Taoyuan City, Taiwan

**ISSUED BY:** Bureau Veritas Consumer Products Services  
(H.K.) Ltd., Taoyuan Branch

**LAB ADDRESS:** No. 47, 14th Ling, Chia Pau Vil., Lin Kou Dist., New  
Taipei City, Taiwan ( R.O.C. )

**TEST LOCATION:** No. 19, Hwa Ya 2nd Rd, Wen Hwa Tsuen, Kwei  
Shan Hsiang, Taoyuan Hsien 333, Taiwan, R.O.C.

This report should not be used by the client to claim product certification, approval, or endorsement by TAF or any government agencies.



This report is for your exclusive use. Any copying or replication of this report to or for any other person or entity, or use of our name or trademark, is permitted only with our prior written permission. This report sets forth our findings solely with respect to the test samples identified herein. The results set forth in this report are not indicative or representative of the quality or characteristics of the lot from which a test sample was taken or any similar or identical product unless specifically and expressly noted. Our report includes all of the tests requested by you and the results thereof based upon the information that you provided to us. You have 60 days from date of issuance of this report to notify us of any material error or omission caused by our negligence, provided, however, that such notice shall be in writing and shall specifically address the issue you wish to raise. A failure to raise such issue within the prescribed time shall constitute your unqualified acceptance of the completeness of this report, the tests conducted and the correctness of the report contents. Unless specific mention, the uncertainty of measurement has been explicitly taken into account to declare the compliance or non-compliance to the specification

## TABLE OF CONTENTS

RELEASE CONTROL RECORD .....	3
1 CERTIFICATION .....	4
2 SUMMARY OF TEST RESULTS.....	5
2.1 MEASUREMENT UNCERTAINTY .....	5
2.2 TEST SITE AND INSTRUMENTS .....	6
3 GENERAL INFORMATION .....	7
3.1 GENERAL DESCRIPTION OF EUT.....	7
3.2 CONFIGURATION OF SYSTEM UNDER TEST .....	8
3.3 DESCRIPTION OF SUPPORT UNITS.....	8
3.4 TEST ITEM AND TEST CONFIGURATION .....	9
3.5 EUT OPERATING CONDITIONS.....	11
3.6 GENERAL DESCRIPTION OF APPLIED STANDARDS .....	11
4 TEST TYPES AND RESULTS.....	12
4.1 OUTPUT POWER MEASUREMENT .....	12
4.1.1 LIMITS OF OUTPUT POWER MEASUREMENT .....	12
4.1.2 TEST PROCEDURES .....	12
4.1.3 TEST SETUP .....	13
4.1.4 TEST RESULTS .....	14
4.2 FREQUENCY STABILITY MEASUREMENT .....	19
4.2.1 LIMITS OF FREQUENCY STABILITY MEASUREMENT .....	19
4.2.2 TEST PROCEDURE .....	19
4.2.3 TEST SETUP .....	19
4.2.4 TEST RESULTS .....	20
4.3 OCCUPIED BANDWIDTH MEASUREMENT.....	21
4.3.1 TEST PROCEDURES.....	21
4.3.2 TEST SETUP .....	21
4.3.3 TEST RESULTS .....	22
4.4 EMISSION MASK MEASUREMENT .....	25
4.4.1 LIMITS OF BAND EDGE MEASUREMENT .....	25
4.4.2 TEST SETUP .....	25
4.4.3 TEST PROCEDURES .....	25
4.4.4 TEST RESULTS .....	26
4.5 CONDUCTED SPURIOUS EMISSIONS.....	34
4.5.1 LIMITS OF CONDUCTED SPURIOUS EMISSIONS MEASUREMENT.....	34
4.5.2 TEST PROCEDURE .....	34
4.5.3 TEST SETUP .....	34
4.5.4 TEST RESULTS .....	35
4.6 RADIATED EMISSION MEASUREMENT .....	37
4.6.1 LIMITS OF RADIATED EMISSION MEASUREMENT .....	37
4.6.2 TEST PROCEDURES.....	37
4.6.3 DEVIATION FROM TEST STANDARD .....	37
4.6.4 TEST SETUP .....	38
4.6.5 TEST RESULTS .....	39
5 PHOTOGRAPHS OF THE TEST CONFIGURATION .....	51
6 INFORMATION ON THE TESTING LABORATORIES .....	52
7 APPENDIX A – MODIFICATIONS RECORDERS FOR ENGINEERING CHANGES TO THE EUT BY THE LAB.....	53



## RELEASE CONTROL RECORD

ISSUE NO.	REASON FOR CHANGE	DATE ISSUED
RF140123C02-3	Original release	Mar. 28, 2014



# 1 CERTIFICATION

**PRODUCT:** Smartphone  
**MODEL:** 0P9C300  
**BRAND:** HTC  
**APPLICANT:** HTC Corporation  
**TESTED:** Feb. 06, 2014 ~ Mar. 11, 2014  
**TEST SAMPLE:** Production Unit  
**STANDARDS:** **FCC PART 90, Subpart S**

The above equipment (model: 0P9C300) has been tested by **Bureau Veritas Consumer Products Services (H.K.) Ltd., Taoyuan Branch**, and found compliance with the requirement of the above standards. The test record, data evaluation & Equipment Under Test (EUT) configurations represented herein are true and accurate accounts of the measurements of the sample's EMC characteristics under the conditions specified in this report.

**PREPARED BY** : Ivonne Wu , **DATE** : Mar. 28, 2014  
Ivonne Wu / Supervisor

**APPROVED BY** : Sam Chen , **DATE** : Mar. 28, 2014  
Sam Chen / Senior Project Engineer

## 2 SUMMARY OF TEST RESULTS

The EUT has been tested according to the following specifications:

APPLIED STANDARD: FCC Part 90 & Part 2			
STANDARD SECTION	TEST TYPE	RESULT	REMARK
2.1046 90.635 (b)	Effective Radiated Power	PASS	Meet the requirement of limit.
2.1055 90.213	Frequency Stability	PASS	Meet the requirement of limit.
2.1049 90.209	Occupied Bandwidth (*)	PASS	Meet the requirement of limit.
2.1051 90.209	Emission Masks	PASS	Meet the requirement of limit.
2.1051 90.691	Conducted Spurious Emissions	PASS	Meet the requirement of limit.
2.1053 90.691	Radiated Spurious Emissions	PASS	Meet the requirement of limit. Minimum passing margin is -28.76dB at 32.70MHz.

### 2.1 MEASUREMENT UNCERTAINTY

Where relevant, the following measurement uncertainty levels have been estimated for tests performed on the EUT as specified in CISPR 16-4-2:

MEASUREMENT	FREQUENCY	UNCERTAINTY
Conducted emissions	150kHz~30MHz	2.44 dB
Radiated emissions	30MHz ~ 200MHz	2.93 dB
	200MHz ~1000MHz	2.95 dB
	1GHz ~ 18GHz	2.26 dB
	18GHz ~ 40GHz	1.94 dB

This uncertainty represents an expanded uncertainty expressed at approximately the 95% confidence level using a coverage factor of k=2.

## 2.2 TEST SITE AND INSTRUMENTS

DESCRIPTION & MANUFACTURER	MODEL NO.	SERIAL NO.	DATE OF CALIBRATION	DUE DATE OF CALIBRATION
Test Receiver ROHDE & SCHWARZ	ESCI	100744	Apr. 15, 2013	Apr. 14, 2014
Spectrum Analyzer ROHDE & SCHWARZ	FSU43	101261	Dec. 21, 2013	Dec. 20, 2014
BILOG Antenna SCHWARZBECK	VULB9168	9168-472	Mar. 25, 2013	Mar. 24, 2014
HORN Antenna SCHWARZBECK	BBHA 9120 D	9120D-783	Sep. 26, 2013	Sep. 25, 2014
HORN Antenna SCHWARZBECK	BBHA 9170	9170-480	Dec. 18, 2013	Dec. 17, 2014
Loop Antenna	EM-6879	264	Dec. 10, 2012	Dec. 09, 2014
Preamplifier EMCI	EMC 012645	980115	Dec. 26, 2013	Dec. 25, 2014
Preamplifier EMCI	EMC 184045	980116	Jan. 13, 2014	Jan. 12, 2015
Preamplifier EMCI	EMC 330H	980112	Dec. 27, 2013	Dec. 26, 2014
RF signal cable HUBER+SUHNNER	SUCOFLEX 104	309219/4 2950114	Oct. 18, 2013	Oct. 17, 2014
RF signal cable HUBER+SUHNNER	SUCOFLEX 104	250130/4	Oct. 18, 2013	Oct. 17, 2014
RF signal cable Worken	RG-213	NA	Nov. 07, 2013	Nov. 06, 2014
Software BV ADT	E3 6.120103	NA	NA	NA
Antenna Tower MF	MFA-440H	NA	NA	NA
Turn Table MF	MFT-201SS	NA	NA	NA
Antenna Tower & Turn Table Controller MF	MF-7802	NA	NA	NA
Mini-Circuits Power Splitter	ZN2PD-9G	NA	Jul. 18, 2013	Jul. 17, 2014
JFW 20dB attenuation	50HF-020-SMA	NA	NA	NA
Communications Tester-Wireless	E5515C	MY52102544	Sep. 05, 2012	Sep. 04, 2014
Radio Communication Analyzer	MT8820C	6201300640	Aug. 01, 2013	Jul. 31, 2014

- NOTE:**
1. The calibration interval of the above test instruments is 12 months and the calibrations are traceable to NML/ROC and NIST/USA.
  2. The test was performed in HwaYa Chamber 10.
  3. The horn antenna and HP preamplifier (model: 8449B) are used only for the measurement of emission frequency above 1GHz if tested.
  4. The FCC Site Registration No. is 690701.
  5. The IC Site Registration No. is IC 7450F-10.

### 3 GENERAL INFORMATION

#### 3.1 GENERAL DESCRIPTION OF EUT

<b>EUT</b>	Smartphone	
<b>MODEL NO.</b>	0P9C300	
<b>POWER SUPPLY</b>	5.0Vdc (adapter or host equipment) 3.8Vdc (battery)	
<b>MODULATION TYPE</b>	<b>CDMA BC10</b>	QPSK, OQPSK, HPSK
	<b>LTE Band 26</b>	QPSK, 16QAM
<b>FREQUENCY RANGE</b>	<b>CDMA BC10</b>	817.9MHz ~ 823.1MHz
	<b>LTE Band 26 (Channel Bandwidth: 1.4MHz)</b>	814.7MHz ~ 823.3MHz
	<b>LTE Band 26 (Channel Bandwidth: 3MHz)</b>	815.5MHz ~ 822.5MHz
	<b>LTE Band 26 (Channel Bandwidth: 5MHz)</b>	816.5MHz ~ 821.5MHz
	<b>LTE Band 26 (Channel Bandwidth: 10MHz)</b>	819MHz
<b>MAX. ERP POWER</b>	<b>CDMA BC10</b>	52.84mW
	<b>LTE Band 26 (Channel Bandwidth: 1.4MHz)</b>	39.08mW
	<b>LTE Band 26 (Channel Bandwidth: 3MHz)</b>	36.06mW
	<b>LTE Band 26 (Channel Bandwidth: 5MHz)</b>	38.64mW
	<b>LTE Band 26 (Channel Bandwidth: 10MHz)</b>	39.81mW
<b>EMISSION DESIGNATOR</b>	<b>CDMA BC10</b>	1M28F9W
	<b>LTE Band 26 (Channel Bandwidth: 1.4MHz)</b>	1M09G7D
	<b>LTE Band 26 (Channel Bandwidth: 3MHz)</b>	2M69G7D
	<b>LTE Band 26 (Channel Bandwidth: 5MHz)</b>	4M50G7D
	<b>LTE Band 26 (Channel Bandwidth: 10MHz)</b>	8M94G7D
<b>ANTENNA TYPE</b>	Fixed Internal antenna	
<b>I/O PORTS</b>	Refer to users' manual	
<b>DATA CABLE</b>	Refer to NOTE as below	
<b>ACCESSORY DEVICES</b>	Refer to NOTE as below	

#### NOTE:

- The EUT's accessories list refers to EUT photo.
- There're 2 configurations for the EUT listed as below.  
 Main sample (A): Phone + Battery 1  
 2<sup>nd</sup> sample (B): Phone + Battery 2  
 ✧ Only the worst test data was presented in the report.
- The above EUT information was declared by manufacturer and for more detailed features description, please refer to the manufacturer's specifications or User's Manual.

### 3.2 CONFIGURATION OF SYSTEM UNDER TEST

#### FOR RADIATION EMISSION TEST

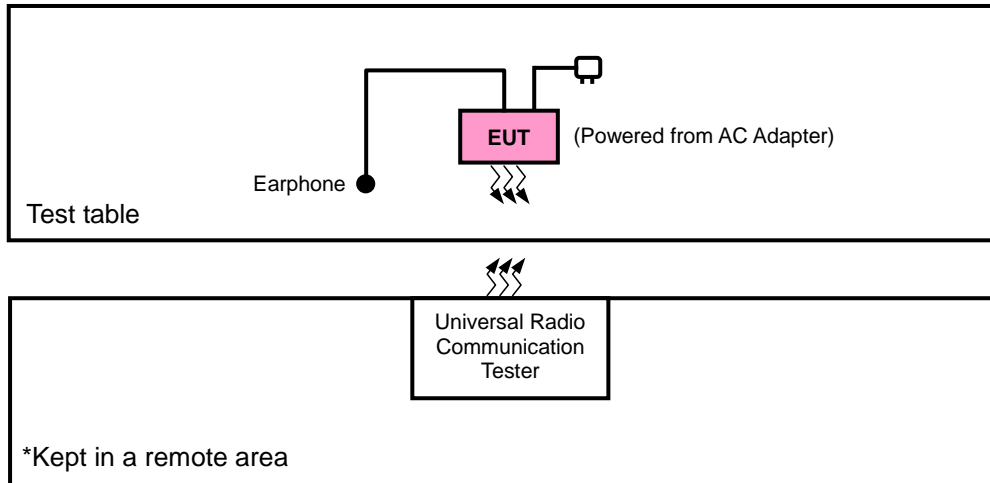

#### FOR E.R.P. TEST

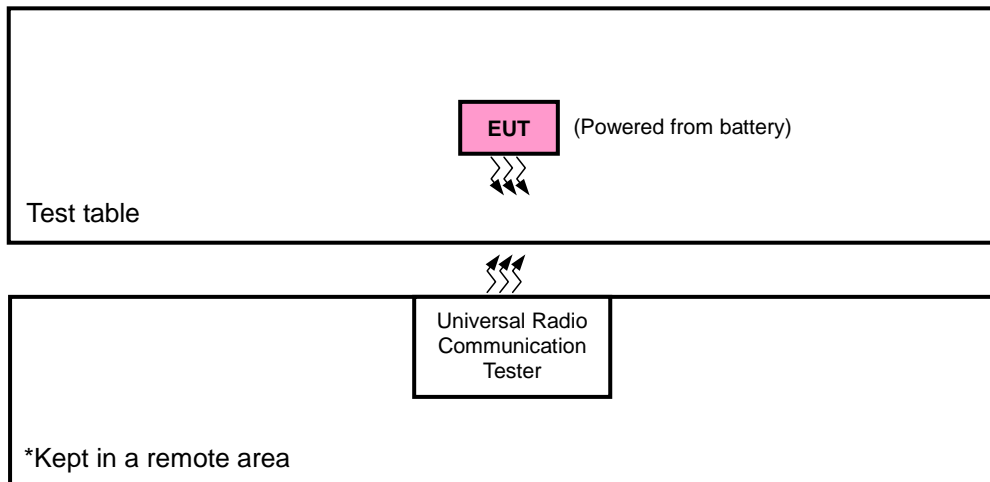

### 3.3 DESCRIPTION OF SUPPORT UNITS

The EUT has been tested as an independent unit together with other necessary accessories or support units.



### 3.4 TEST ITEM AND TEST CONFIGURATION

Pre-Scan has been conducted to determine the worst-case mode from all possible combinations between available modulations, data rates, XYZ axis and antenna ports. The worst case was found as listed below. Following channel(s) was (were) selected for the final test as listed below:

EUT CONFIGURE MODE	DESCRIPTION
A	Main sample
B	2 <sup>nd</sup> sample

EUT CONFIGURE MODE	EIRP	RADIATED EMISSION
A	Y-plane	CDMA: Y-axis LTE: Z-axis
B	Y-plane	X-axis

#### CDMA MODE

EUT CONFIGURE MODE	TEST ITEM	AVAILABLE CHANNEL	TESTED CHANNEL	MODE
A, B	ERP	476 to 684	476, 580, 684	1xRTT
A	FREQUENCY STABILITY	476 to 684	580	1xRTT
A	OCCUPIED BANDWIDTH	476 to 684	476, 580, 684	1xRTT
A	EMISSION MASK	476 to 684	476, 580, 684	1xRTT
A	CONDCUDED EMISSION	476 to 684	580	1xRTT
A, B	RADIATED EMISSION	476 to 684	580	1xRTT



**LTE BAND 26 MODE**

EUT CONFIGURE MODE	TEST ITEM	AVAILABLE CHANNEL	TESTED CHANNEL	CHANNEL BANDWIDTH	MODULATION	MODE		
A	ERP	26697 to 26783	26697, 26740, 26783	1.4MHz	QPSK, 16QAM	1 RB / 2 RB Offset		
		26705 to 26775	26705, 26740, 26775	3MHz	QPSK, 16QAM	1 RB / 7 RB Offset		
		26715 to 26765	26715, 26740, 26765	5MHz	QPSK, 16QAM	1 RB / 12 RB Offset		
		26740	26740	10MHz	QPSK, 16QAM	1 RB / 24 RB Offset		
A	FREQUENCY STABILITY	26697 to 26783	26740	1.4MHz	QPSK	1 RB / 2 RB Offset		
		26705 to 26775	26740	3MHz	QPSK	1 RB / 7 RB Offset		
		26715 to 26765	26740	5MHz	QPSK	1 RB / 12 RB Offset		
		26740	26740	10MHZ	QPSK	1 RB / 24 RB Offset		
A	OCCUPIED BANDWIDTH	26697 to 26783	26697, 26740, 26783	1.4MHz	QPSK, 16QAM	6 RB / 0 RB Offset		
		26705 to 26775	26705, 26740, 26775	3MHz	QPSK, 16QAM	15 RB / 0 RB Offset		
		26715 to 26765	26715, 26740, 26765	5MHz	QPSK, 16QAM	25 RB / 0 RB Offset		
		26740	26740	10MHz	QPSK, 16QAM	50 RB / 0 RB Offset		
A	EMISSION MASK	26697 to 26783	26697	1.4MHz	QPSK, 16QAM	6 RB / 0 RB Offset		
			26740	1.4MHz	QPSK, 16QAM	6 RB / 0 RB Offset		
			26783	1.4MHz	QPSK, 16QAM	1 RB / 0 RB Offset		
						6 RB / 0 RB Offset		
		26705 to 26775	26705	3MHz	QPSK, 16QAM	1 RB / 0 RB Offset		
			26740	3MHz	QPSK, 16QAM	15 RB / 0 RB Offset		
			26775	3MHz	QPSK, 16QAM	1 RB / 0 RB Offset		
		26715 to 26765	26715	5MHz	QPSK, 16QAM	1 RB / 0 RB Offset		
			26740	5MHz	QPSK, 16QAM	25 RB / 0 RB Offset		
			26775	5MHz	QPSK, 16QAM	1 RB / 0 RB Offset		
						25 RB / 0 RB Offset		
		26740	26740	10MHz	QPSK, 16QAM	1 RB / 0 RB Offset		
						1 RB / 49 RB Offset		
						50 RB / 0 RB Offset		
		A	CONDCUDED EMISSION	26697 to 26783	26740	1.4MHz	QPSK	1 RB / 2 RB Offset
				26705 to 26775	26740	3MHz	QPSK	1 RB / 7 RB Offset
26715 to 26765	26740			5MHz	QPSK	1 RB / 12 RB Offset		
26740	26740			10MHZ	QPSK	1 RB / 24 RB Offset		
A	RADIATED EMISSION	26697 to 26783	26740	1.4MHz	QPSK	1 RB / 2 RB Offset		
		26705 to 26775	26740	3MHz	QPSK	1 RB / 7 RB Offset		
		26715 to 26765	26740	5MHz	QPSK	1 RB / 12 RB Offset		
		26740	26740	10MHZ	QPSK	1 RB / 24 RB Offset		

**Note:** This device was tested under all bandwidths, RB configurations and modulations. The worst case was found in QPSK modulation.

**TEST CONDITION:**

TEST ITEM	ENVIRONMENTAL CONDITIONS	INPUT POWER	TESTED BY
ERP	26deg. C, 58%RH	3.8Vdc	Howard Kao
FREQUENCY STABILITY	26deg. C, 58%RH	3.8Vdc	Howard Kao
OCCUPIED BANDWIDTH	26deg. C, 58%RH	3.8Vdc	Howard Kao
BAND EDGE	26deg. C, 58%RH	3.8Vdc	Howard Kao
CONDCUDED EMISSION	26deg. C, 58%RH	3.8Vdc	Howard Kao
RADIATED EMISSION	25deg. C, 65%RH	120Vac, 60Hz	Johnson Liao

### 3.5 EUT OPERATING CONDITIONS

The EUT makes a call to the communication simulator. The communication simulator station system controlled a EUT to export maximum output power under transmission mode and specific channel frequency.

### 3.6 GENERAL DESCRIPTION OF APPLIED STANDARDS

The EUT is a RF product. According to the specifications of the manufacturer, it must comply with the requirements of the following standards:

**FCC 47 CFR Part 2**

**FCC 47 CFR Part 90**

**ANSI/TIA/EIA-603-C 2004**

**NOTE:** All test items have been performed and recorded as per the above standards.

## 4 TEST TYPES AND RESULTS

### 4.1 OUTPUT POWER MEASUREMENT

#### 4.1.1 LIMITS OF OUTPUT POWER MEASUREMENT

Mobile / Portable station are limited to 100 watts e.r.p.

#### 4.1.2 TEST PROCEDURES

##### EIRP MEASUREMENT:

- a. All measurements were done at low, middle and high operational frequency range. RBW and VBW is 5MHz for CDMA and 10MHz for LTE mode.
- b. Substitution method is used for E.I.R.P measurement. In the semi-anechoic chamber, EUT placed on the 0.8m height of Turn Table, rotated the table around 360 degrees to search the maximum radiation power and receiver antenna shall be rotated vertical and horizontal polarization and moved height from 1m to 4m to find the maximum polar radiated power. The “Read Value” is the spectrum reading the maximum power value.
- c. The substitution horn antenna is substituted for EUT at the same position and signals generator export the CW signal to the substitution antenna via a tx cable. Rotated the Turn Table and moved receiving antenna to find the maximum radiation power. Adjust output power level of S.G to get a Value of spectrum reading equal to “Read Value” of step b. Record the power level of S.G
- d.  $EIRP = \text{Output power level of S.G} - \text{TX cable loss} + \text{Antenna gain of substitution horn}.$

##### CONDUCTED POWER MEASUREMENT:

The EUT was set up for the maximum power with CDMA & LTE link data modulation and link up with simulator. Set the EUT to transmit under low, middle and high channel and record the power level shown on simulator.

### 4.1.3 TEST SETUP

#### EIRP / ERP MEASUREMENT:

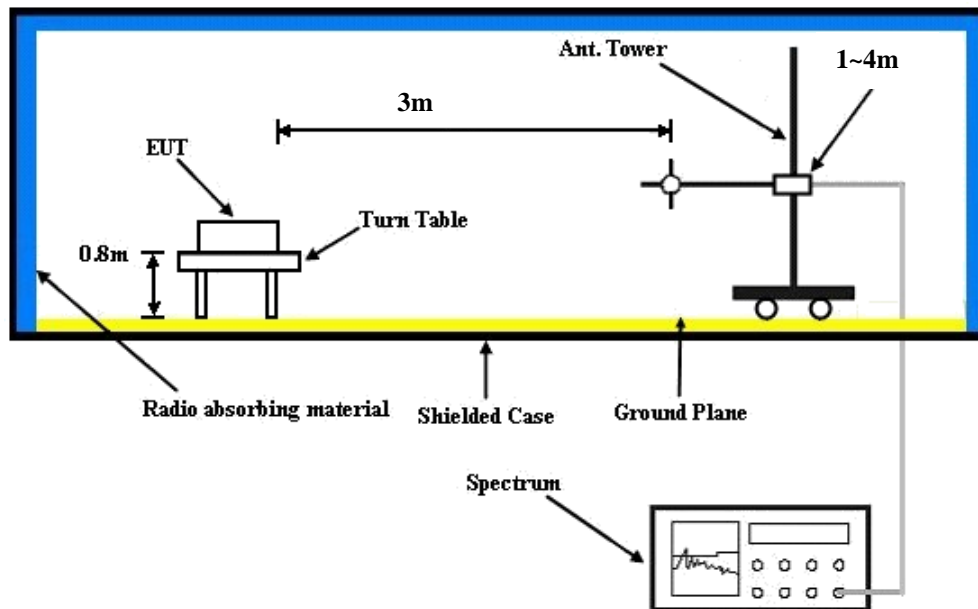

#### CONDUCTED POWER MEASUREMENT:

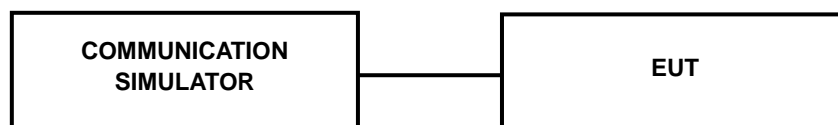

#### 4.1.4 TEST RESULTS

##### CONDUCTED OUTPUT POWER (dBm)

Band	CDMA		
Channel	476	580	684
Frequency (MHz)	817.9	820.5	823.1
RC1+SO55	24.15	24.22	24.18
RC3+SO55	24.24	<b>24.31</b>	24.27
RC3+SO32(+ F-SCH)	24.17	24.24	24.20
RC3+SO32(+SCH)	24.14	24.21	24.17
RTAP 153.6	24.21	24.28	24.24
RETAP 4096	24.19	24.26	24.22

Band / BW	Modulation	RB Size	RB Offset	Low CH	Mid CH	High CH	3PGG MPR (dB)
				26697	26740	26783	
				Frequency	Frequency	Frequency	
				814.7 MHz	819.0 MHz	823.3 MHz	
26 / 1.4M	QPSK	1	0	22.47	22.55	22.59	0
		1	2	22.52	22.69	22.78	0
		1	5	22.53	22.63	22.68	0
		3	0	22.12	22.24	22.29	0
		3	1	22.14	22.24	22.25	0
		3	3	22.15	22.25	22.28	0
		6	0	21.14	21.22	21.24	1
	16QAM	1	0	21.95	21.96	21.97	1
		1	2	22.00	22.07	22.16	1
		1	5	22.01	22.01	22.06	1
		3	0	21.11	21.12	21.17	1
		3	1	21.11	21.12	21.13	1
		3	3	21.11	21.13	21.16	1
		6	0	21.06	21.10	21.12	2

Band / BW	Modulation	RB Size	RB Offset	Low CH	Mid CH	High CH	3PGG MPR (dB)
				26705	26740	26775	
				Frequency	Frequency	Frequency	
				815.5 MHz	819.0 MHz	822.5 MHz	
26 / 3M	QPSK	1	0	22.14	22.17	22.21	0
		1	7	22.14	22.31	22.40	0
		1	14	22.15	22.25	22.30	0
		8	0	21.17	21.36	21.41	1
		8	3	21.18	21.36	21.37	1
		8	7	21.22	21.37	21.40	1
		15	0	21.20	21.34	21.36	1
	16QAM	1	0	21.12	21.14	21.20	1
		1	7	21.12	21.19	21.28	1
		1	14	21.13	21.13	21.18	1
		8	0	20.15	20.24	20.29	2
		8	3	20.16	20.24	20.25	2
		8	7	20.20	20.25	20.28	2
		15	0	20.18	20.22	20.24	2



A D T

Band / BW	Modulation	RB Size	RB Offset	Low CH 26715	Mid CH 26740	High CH 26765	3PGG MPR (dB)
				Frequency 816.5 MHz	Frequency 819.0 MHz	Frequency 821.5 MHz	
26 / 5M	QPSK	1	0	22.71	22.79	22.83	0
		1	12	22.76	22.93	23.02	0
		1	24	22.77	22.87	22.92	0
		12	0	21.79	21.98	22.03	1
		12	6	21.80	21.98	21.99	1
		12	13	21.84	21.99	22.02	1
	16QAM	25	0	21.82	21.96	21.98	1
		1	0	21.69	21.70	21.71	1
		1	12	21.74	21.81	21.90	1
		1	24	21.75	21.75	21.80	1
		12	0	20.77	20.86	20.91	2
		12	6	20.78	20.86	20.87	2
		12	13	20.82	20.87	20.90	2
		25	0	20.80	20.84	20.86	2

Band / BW	Modulation	RB Size	RB Offset	Mid CH 26740	3PGG MPR (dB)
				Frequency 819.0 MHz	
26 / 10M	QPSK	1	0	22.84	0
		1	24	22.99	0
		1	49	22.89	0
		25	0	22.05	1
		25	12	21.97	1
		25	25	21.95	1
		50	0	21.90	1
	16QAM	1	0	21.83	1
		1	24	21.98	1
		1	49	21.88	1
		25	0	21.04	2
		25	12	20.96	2
		25	25	20.94	2
		50	0	20.89	2

**ERP POWER (dBm)**

**MODE A**

CDMA							
Plane	Channel	Frequency (MHz)	LVL (dBm)	Correction Factor(dB)	ERP(dBm)	ERP(mW)	Polarization (H/V)
Y	476	817.9	-13.24	32.62	17.23	52.84	H
	580	820.5	-13.46	32.52	16.91	49.09	H
	684	823.1	-13.29	32.65	17.21	52.60	H
	476	817.9	-16.36	32.76	14.25	26.61	V
	580	820.5	-16.60	32.39	13.64	23.12	V
	684	823.1	-16.45	32.54	13.94	24.77	V

LTE Band 26							
Channel Bandwidth: 1.4MHz / QPSK							
Plane	Channel	Frequency (MHz)	LVL (dBm)	Correction Factor(dB)	ERP(dBm)	ERP(mW)	Polarization (H/V)
Y	26697	814.7	-14.66	32.01	15.20	33.11	H
	26740	819.0	-14.44	32.11	15.52	35.65	H
	26783	823.3	-14.25	32.32	15.92	39.08	H
	26697	814.7	-17.24	32.54	13.15	20.65	V
	26740	819.0	-17.19	32.51	13.17	20.75	V
	26783	823.3	-16.97	32.51	13.39	21.83	V

LTE Band 26							
Channel Bandwidth: 1.4MHz / 16QAM							
Plane	Channel	Frequency (MHz)	LVL (dBm)	Correction Factor(dB)	ERP(dBm)	ERP(mW)	Polarization (H/V)
Y	26697	814.7	-14.40	32.01	15.46	35.16	H
	26740	819.0	-14.96	32.11	15.00	31.62	H
	26783	823.3	-14.60	32.32	15.57	36.06	H
	26697	814.7	-18.03	32.54	12.36	17.22	V
	26740	819.0	-17.78	32.51	12.58	18.11	V
	26783	823.3	-17.64	32.51	12.72	18.71	V



LTE Band 26							
Channel Bandwidth: 3MHz / QPSK							
Plane	Channel	Frequency (MHz)	LVL (dBm)	Correction Factor(dB)	ERP(dBm)	ERP(mW)	Polarization (H/V)
Y	26705	815.5	-14.78	32.02	15.09	32.28	H
	26740	819.0	-14.55	32.11	15.41	34.75	H
	26775	822.5	-14.46	32.18	15.57	36.06	H
	26705	815.5	-17.37	32.5	12.98	19.86	V
	26740	819.0	-17.43	32.51	12.93	19.63	V
	26775	822.5	-17.45	32.47	12.87	19.36	V

LTE Band 26							
Channel Bandwidth: 3MHz / 16QAM							
Plane	Channel	Frequency (MHz)	LVL (dBm)	Correction Factor(dB)	ERP(dBm)	ERP(mW)	Polarization (H/V)
Y	26705	815.5	-14.35	32.02	15.52	35.65	H
	26740	819.0	-14.94	32.11	15.02	31.77	H
	26775	822.5	-14.61	32.18	15.42	34.83	H
	26705	815.5	-17.95	32.5	12.40	17.38	V
	26740	819.0	-17.76	32.51	12.60	18.20	V
	26775	822.5	-17.58	32.47	12.74	18.79	V

LTE Band 26							
Channel Bandwidth: 5MHz / QPSK							
Plane	Channel	Frequency (MHz)	LVL (dBm)	Correction Factor(dB)	ERP(dBm)	ERP(mW)	Polarization (H/V)
Y	26715	816.5	-14.28	32.04	15.61	36.39	H
	26740	819.0	-14.09	32.11	15.87	38.64	H
	26765	821.5	-14.06	31.79	15.58	36.14	H
	26715	816.5	-17.15	32.52	13.22	20.99	V
	26740	819.0	-17.93	32.51	12.43	17.50	V
	26765	821.5	-17.92	32.17	12.10	16.22	V



A D T

LTE Band 26							
Channel Bandwidth: 5MHz / 16QAM							
Plane	Channel	Frequency (MHz)	LVL (dBm)	Correction Factor(dB)	ERP(dBm)	ERP(mW)	Polarization (H/V)
Y	26715	816.5	-15.30	32.04	14.59	28.77	H
	26740	819.0	-14.91	32.11	15.05	31.99	H
	26765	821.5	-14.77	31.79	14.87	30.69	H
	26715	816.5	-17.65	32.52	12.72	18.71	V
	26740	819.0	-17.81	32.51	12.55	17.99	V
	26765	821.5	-17.72	32.17	12.30	16.98	V

LTE Band 26							
Channel Bandwidth: 10MHz / QPSK							
Plane	Channel	Frequency (MHz)	LVL (dBm)	Correction Factor(dB)	ERP(dBm)	ERP(mW)	Polarization (H/V)
Y	26740	819.0	-13.96	32.11	16.00	39.81	H
	26740	819.0	-17.97	32.51	12.39	17.34	V

LTE Band 26							
Channel Bandwidth: 10MHz / 16QAM							
Plane	Channel	Frequency (MHz)	LVL (dBm)	Correction Factor(dB)	ERP(dBm)	ERP(mW)	Polarization (H/V)
Y	26740	819.0	-14.88	32.11	15.08	32.21	H
	26740	819.0	-17.83	32.51	12.53	17.91	V

### MODE B

CDMA							
Plane	Channel	Frequency (MHz)	LVL (dBm)	Correction Factor(dB)	ERP(dBm)	ERP(mW)	Polarization (H/V)
Y	476	817.9	-13.85	32.62	16.62	45.92	H
	580	820.5	-13.98	32.52	16.39	43.55	H
	684	823.1	-14.12	32.65	16.38	43.45	H
	476	817.9	-17.56	32.76	13.05	20.18	V
	580	820.5	-17.34	32.39	12.90	19.50	V
	684	823.1	-17.41	32.54	12.98	19.86	V

## 4.2 FREQUENCY STABILITY MEASUREMENT

### 4.2.1 LIMITS OF FREQUENCY STABILITY MEASUREMENT

1.5 ppm is for base and fixed station. 2.5 ppm is for mobile station.

### 4.2.2 TEST PROCEDURE

- Device is placed at the oven room. The oven room could control the temperatures and humidity. Power warm up is at least 15 min and power applied should perform before recording frequency error.
- EUT is connected the external power supply to control the DC input power. The test voltage range is from minimum to maximum working voltage. Each step shall be record the frequency error rate.
- The temperature range step is 10 degrees in this test items. All temperature levels shall be hold the  $\pm 0.5^{\circ}\text{C}$  during the measurement testing. The each temperature step shall be at least 0.5 hours, consider the EUT could be test under the stability condition.

**NOTE:** The frequency error was recorded frequency error from the communication simulator.

### 4.2.3 TEST SETUP

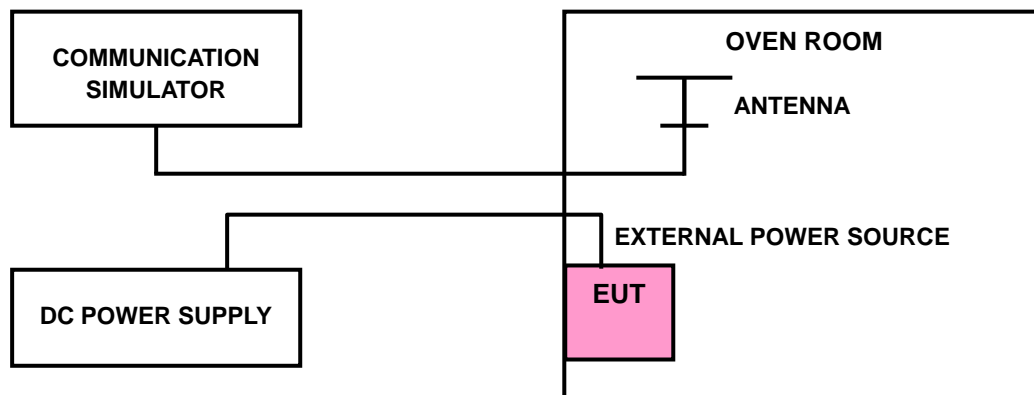

#### 4.2.4 TEST RESULTS

##### FREQUENCY ERROR vs. VOLTAGE

VOLTAGE (Volts)	FREQUENCY ERROR (ppm)					LIMIT (ppm)
	CDMA	LTE Band 26				
		1.4MHz	3MHz	5MHz	10MHz	
3.8	-0.002	0.003	0.004	-0.002	-0.002	2.5
3.55	-0.001	0.002	-0.002	-0.004	-0.002	2.5
4.35	-0.002	0.002	-0.007	-0.003	-0.009	2.5

**NOTE:** The applicant defined the normal working voltage of the battery is from 3.6Vdc to 4.35Vdc.

##### FREQUENCY ERROR vs. TEMPERATURE

TEMP. (°C)	FREQUENCY ERROR (ppm)					LIMIT (ppm)
	CDMA	LTE Band 26				
		1.4MHz	3MHz	5MHz	10MHz	
-30	-0.0012	-0.0032	-0.0099	-0.0009	-0.0033	2.5
-20	-0.0017	-0.0027	0.0051	0.0002	-0.0063	2.5
-10	-0.0014	-0.0057	-0.0056	0.0010	-0.0013	2.5
0	-0.0013	-0.0042	-0.0055	-0.0034	-0.0038	2.5
10	-0.0017	0.0015	-0.0037	-0.0029	-0.0035	2.5
20	-0.0007	-0.0066	-0.0039	-0.0012	-0.0038	2.5
30	-0.0017	0.0054	-0.0074	-0.0004	-0.0009	2.5
40	-0.0010	-0.0054	-0.0053	-0.0021	-0.0050	2.5
50	-0.0012	-0.0062	-0.0016	-0.0048	-0.0050	2.5

## 4.3 OCCUPIED BANDWIDTH MEASUREMENT

### 4.3.1 TEST PROCEDURES

The EUT makes a call to the communication simulator. All measurements were done at low, middle and high operational frequency range. The communication simulator station system controlled a EUT to export maximum output power under transmission mode and specific channel frequency. Use OBW measurement function of Spectrum analyzer to measure 99 % occupied bandwidth.

### 4.3.2 TEST SETUP

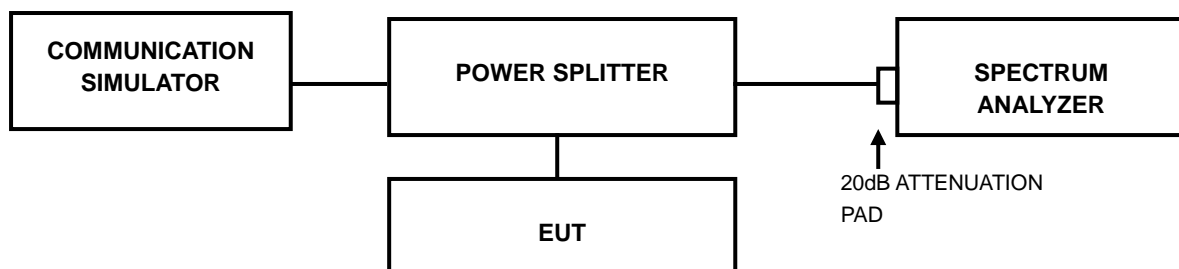



A D T

### 4.3.3 TEST RESULTS

CHANNEL	FREQUENCY (MHz)	99% OCCUPIED BANDWIDTH (MHz)
		CDMA
476	817.9	1.278
580	820.5	1.275
684	823.1	1.272

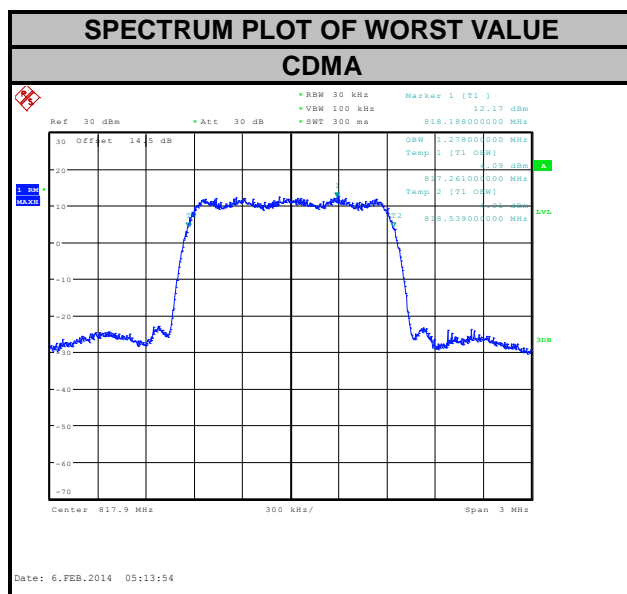



A D T

LTE BAND 26							
CHANNEL BANDWIDTH: 1.4MHz				CHANNEL BANDWIDTH: 3MHz			
CHANNEL	FREQUENCY (MHz)	99% OCCUPIED BANDWIDTH (MHz)		CHANNEL	FREQUENCY (MHz)	99% OCCUPIED BANDWIDTH (MHz)	
		QPSK	16QAM			QPSK	16QAM
26697	814.7	1.086	1.095	26705	815.5	2.688	2.682
26740	819.0	1.095	1.092	26740	819.0	2.682	2.688
26783	823.3	1.095	1.092	26775	822.5	2.682	2.688

**SPECTRUM PLOT OF WORST VALUE**

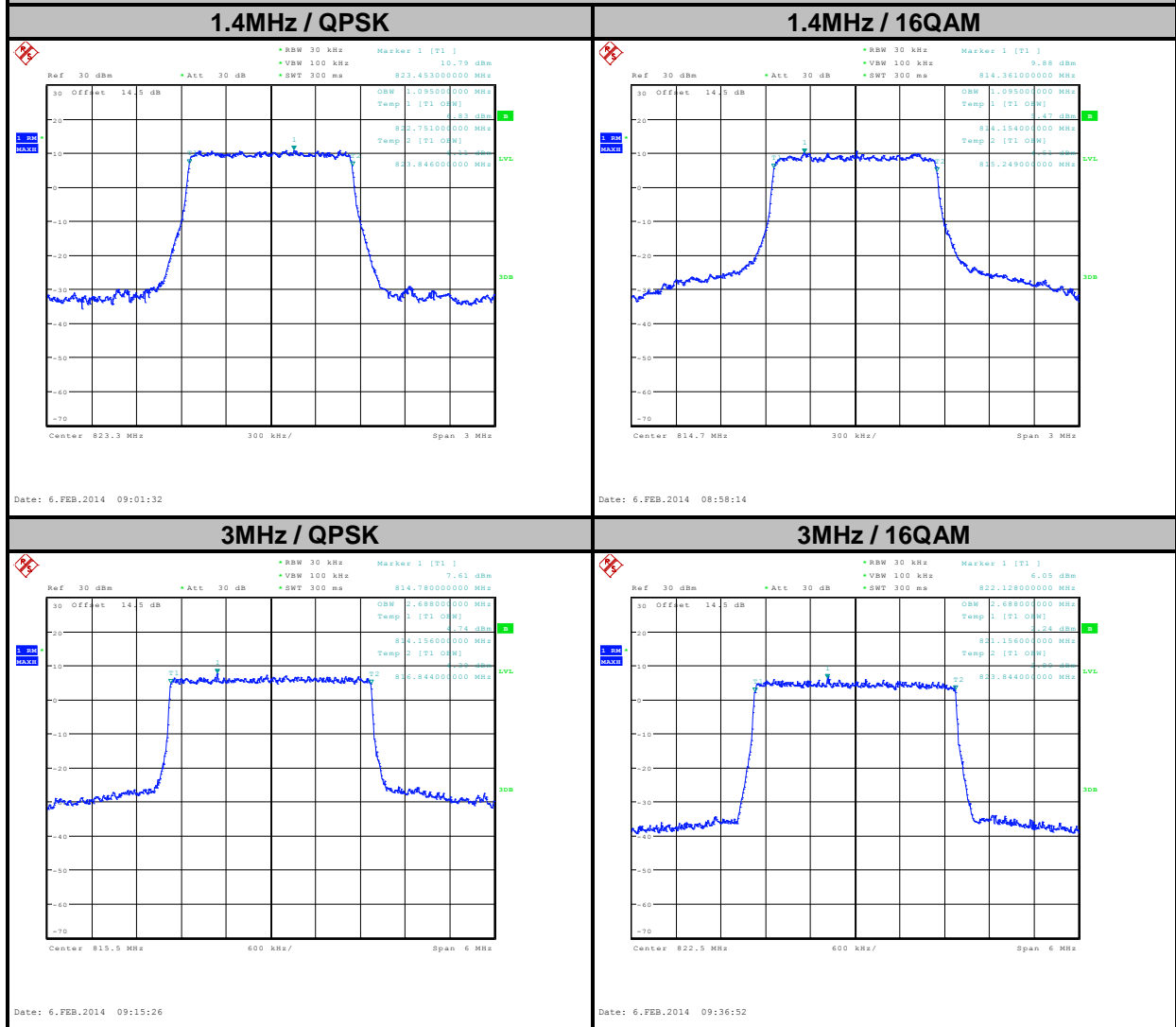





## 4.4 EMISSION MASK MEASUREMENT

### 4.4.1 LIMITS OF BAND EDGE MEASUREMENT

According to FCC part 90.691 shall be tested the emission mask. For any frequency removed from the EA licensee's frequency block by up to and including 37.5 kHz, the power of any emission shall be attenuated below the transmitter power (P) in watts by at least  $116 \text{ Log}_{10}(f/6.1)$  decibels or  $50+10\text{Log}_{10}(P)$  decibels or 80 decibels, whichever is the lesser attenuation, where f is the frequency removed from the center of the outer channel in the block in kilohertz and where f is greater than 12.5 kHz.

### 4.4.2 TEST SETUP

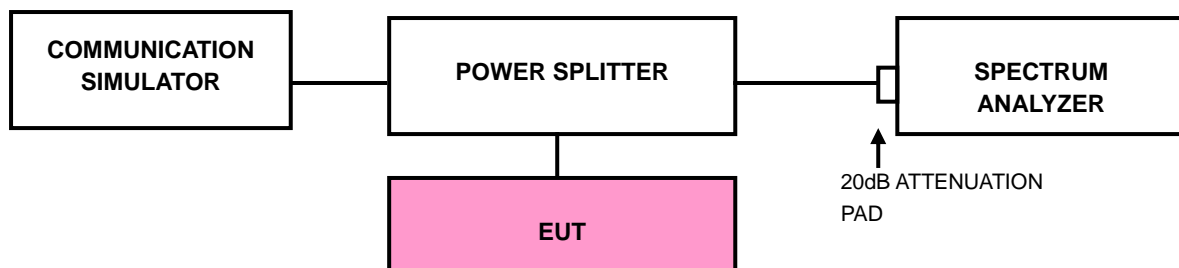

### 4.4.3 TEST PROCEDURES

- a. The measurement used the power splitter via EUT RF power connector between simulation base station and spectrum analyzer.
- b. Record the test plot.



A D T

### 4.4.4 TEST RESULTS

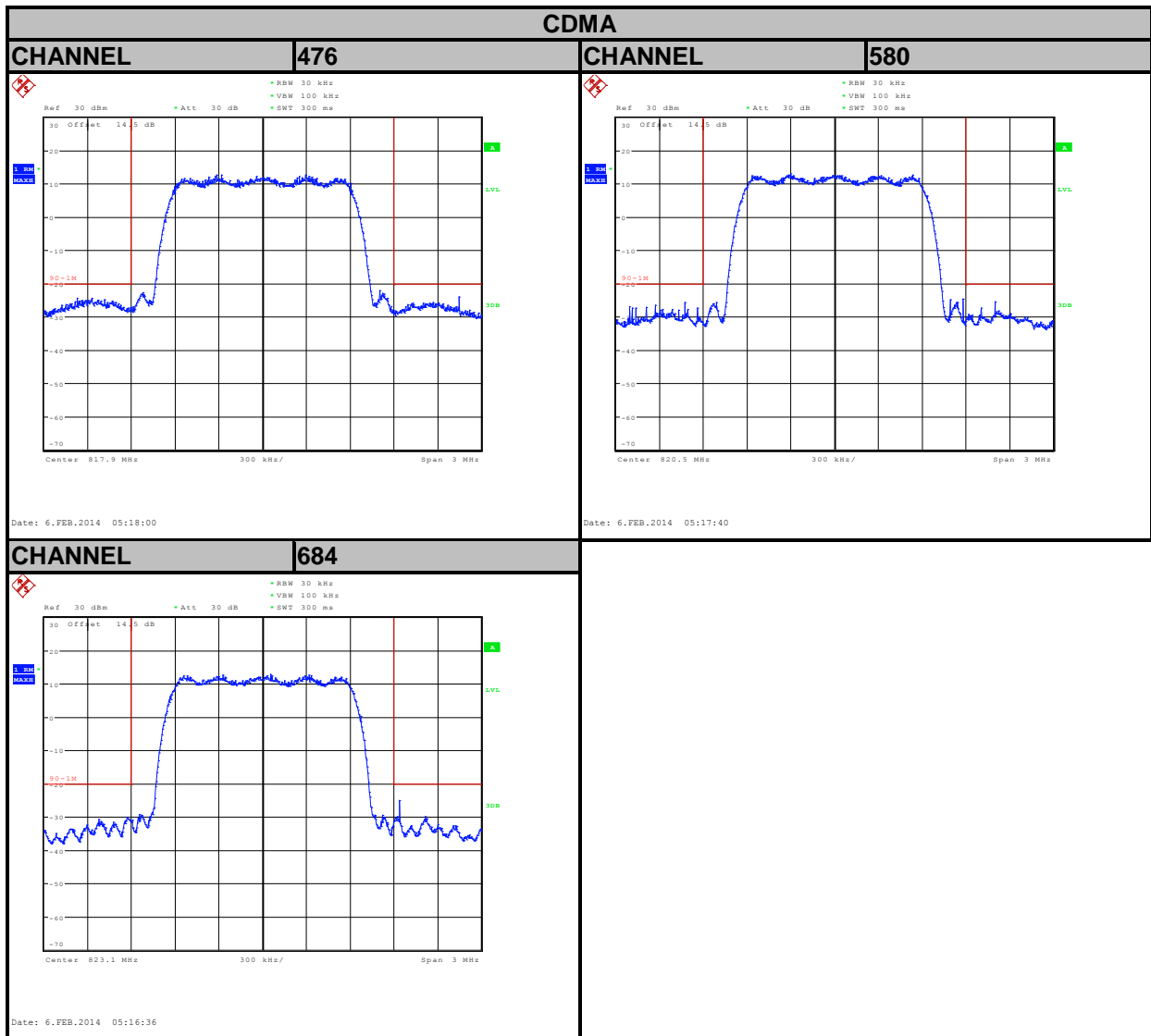



A D T

### LTE Band 26

Channel Bandwidth: 1.4MHz / QPSK

**CHANNEL 26697 6 RB**      **CHANNEL 26740 6 RB**

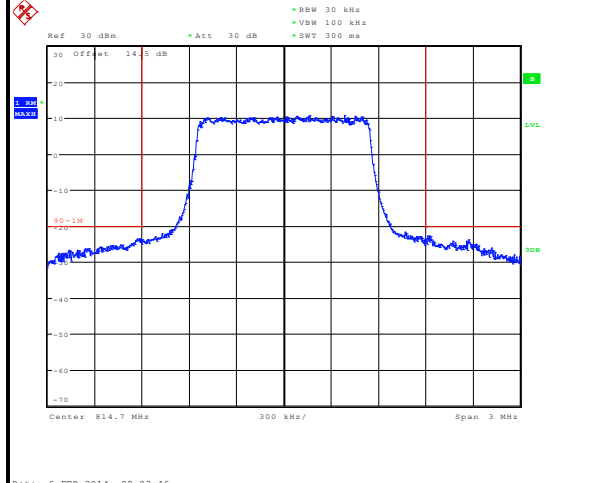

Date: 6.FEB.2014 09:03:46

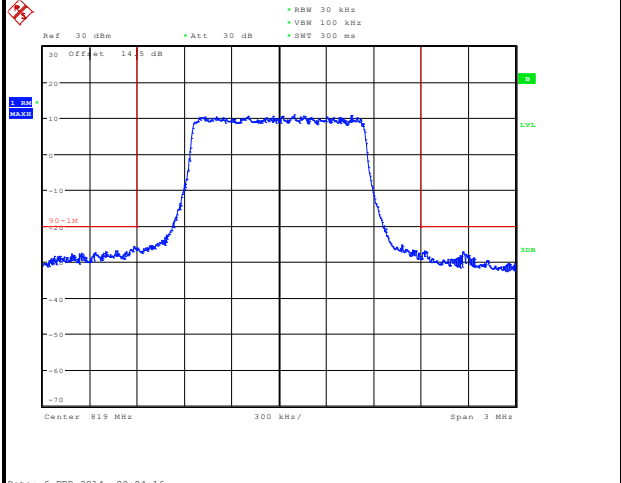

Date: 6.FEB.2014 09:04:16

**CHANNEL 26783 6 RB**

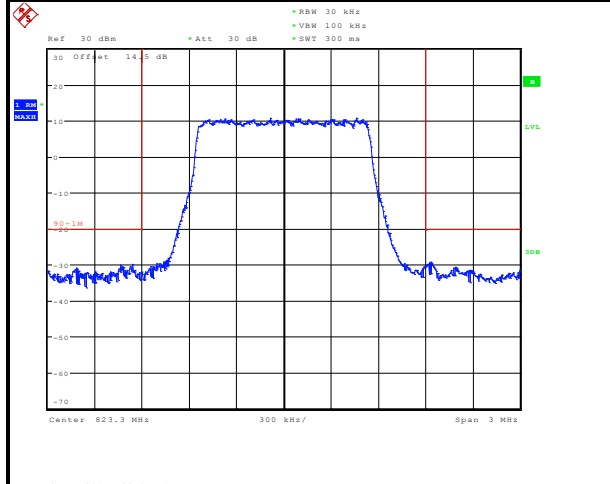

Date: 6.FEB.2014 09:05:41



A D T

### LTE Band 26

#### Channel Bandwidth: 1.4MHz / 16QAM

**CHANNEL 26697 6 RB**      **CHANNEL 26740 6 RB**

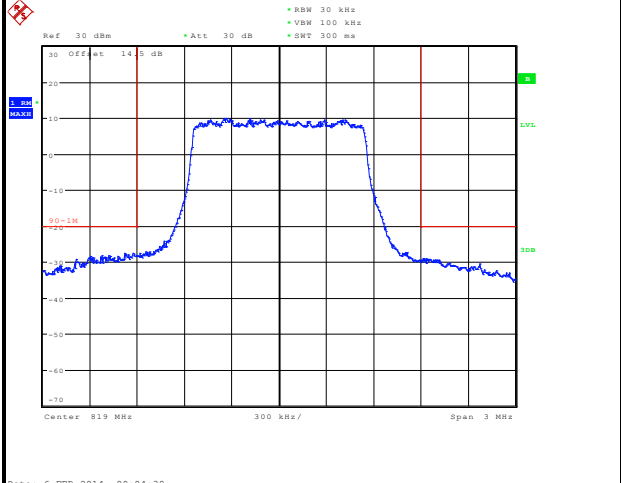
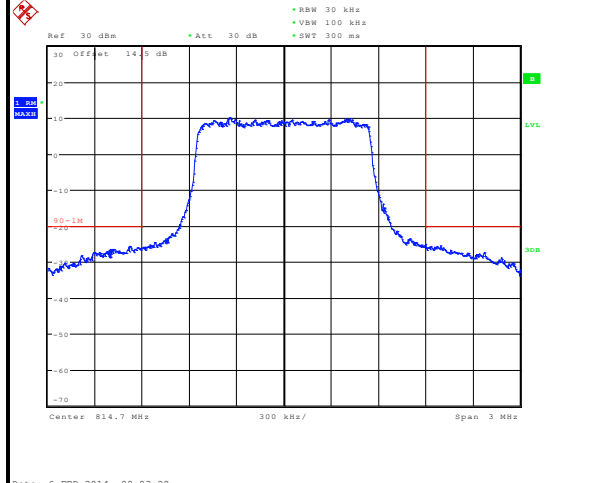

**CHANNEL 26783 6 RB**

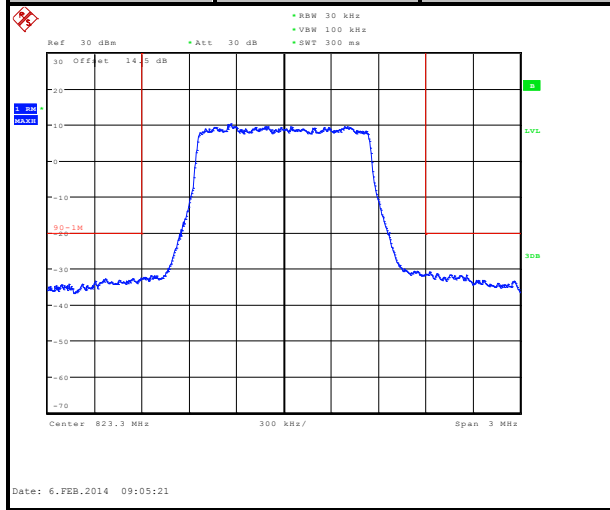



A D T

### LTE Band 26

Channel Bandwidth: 3MHz / QPSK

<b>CHANNEL</b>	<b>26705</b>	<b>15 RB</b>	<b>CHANNEL</b>	<b>26740</b>	<b>15 RB</b>
----------------	--------------	--------------	----------------	--------------	--------------

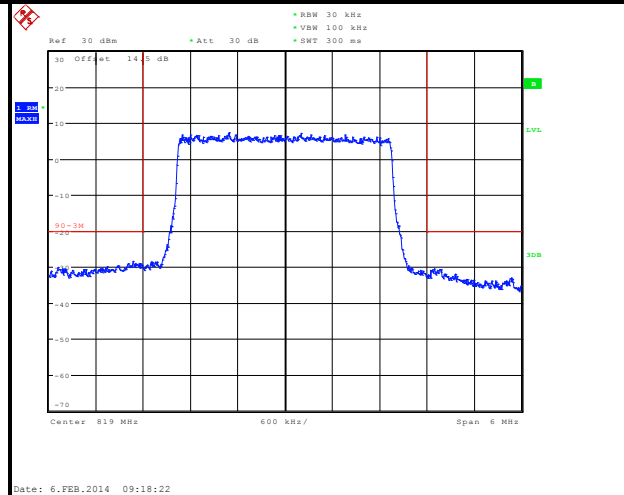
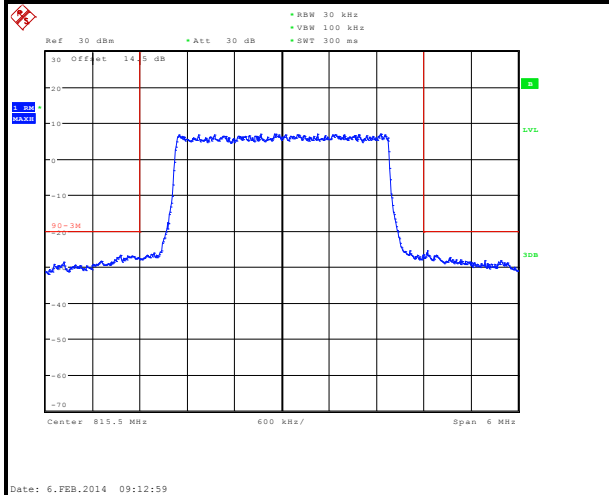

<b>CHANNEL</b>	<b>26775</b>	<b>15 RB</b>
----------------	--------------	--------------

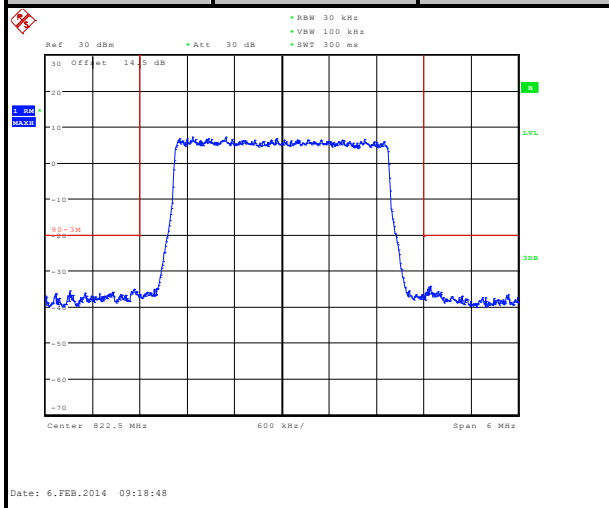



A D T

### LTE Band 26

#### Channel Bandwidth: 3MHz / 16QAM

<b>CHANNEL</b>	<b>26705</b>	<b>15 RB</b>	<b>CHANNEL</b>	<b>26740</b>	<b>15 RB</b>
----------------	--------------	--------------	----------------	--------------	--------------

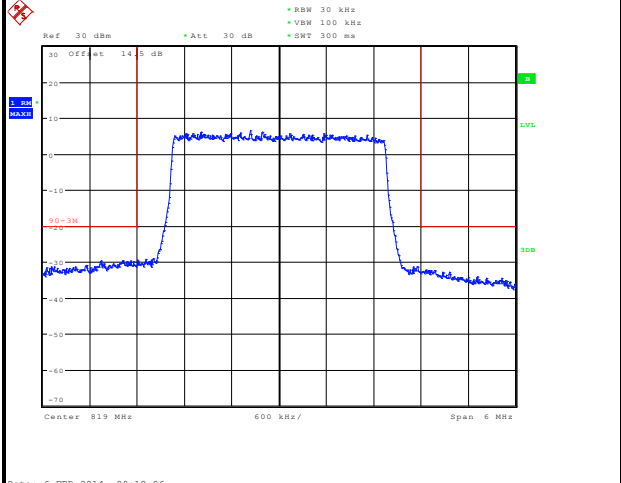
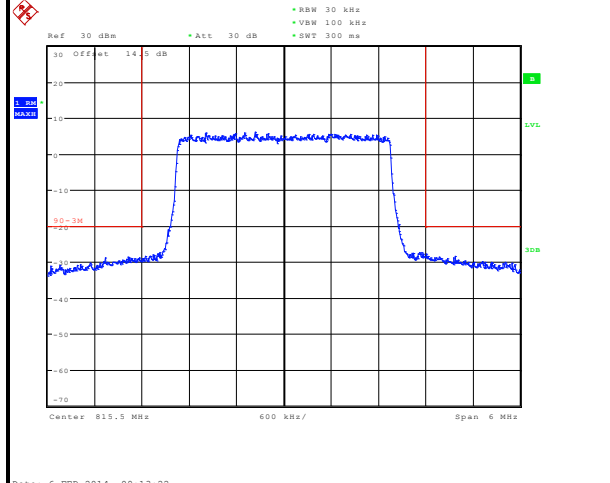

<b>CHANNEL</b>	<b>26775</b>	<b>15 RB</b>
----------------	--------------	--------------

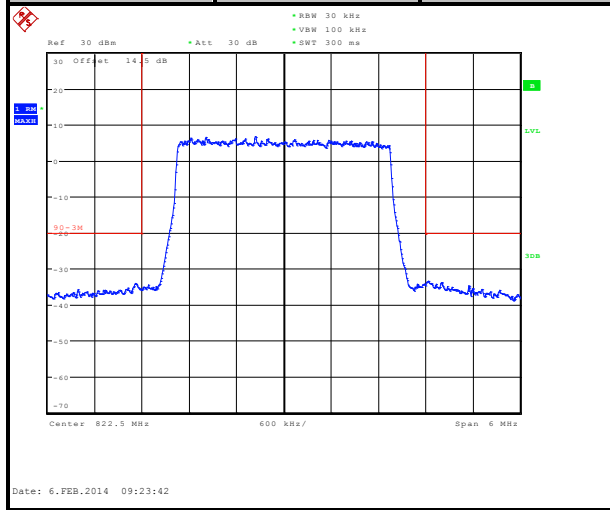



A D T

### LTE Band 26

Channel Bandwidth: 5MHz / QPSK

CHANNEL	26715	25 RB	CHANNEL	26740	25 RB
---------	-------	-------	---------	-------	-------

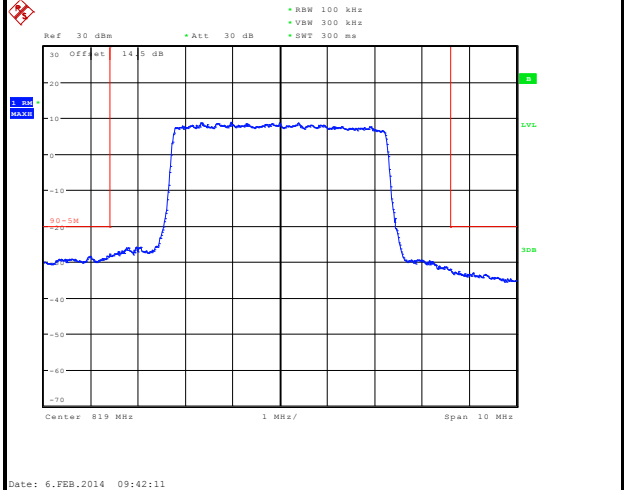
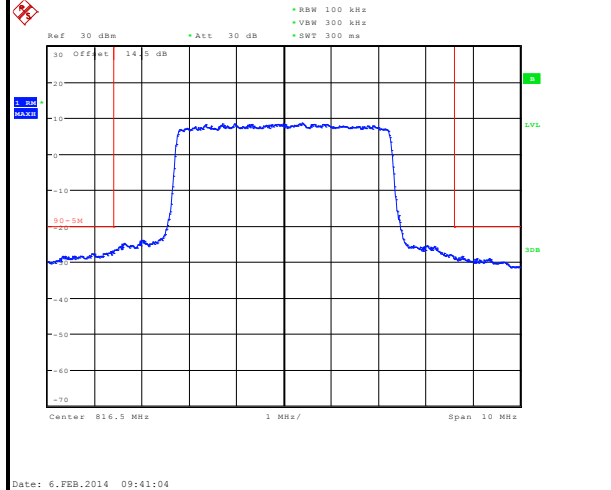

CHANNEL	26765	25 RB
---------	-------	-------

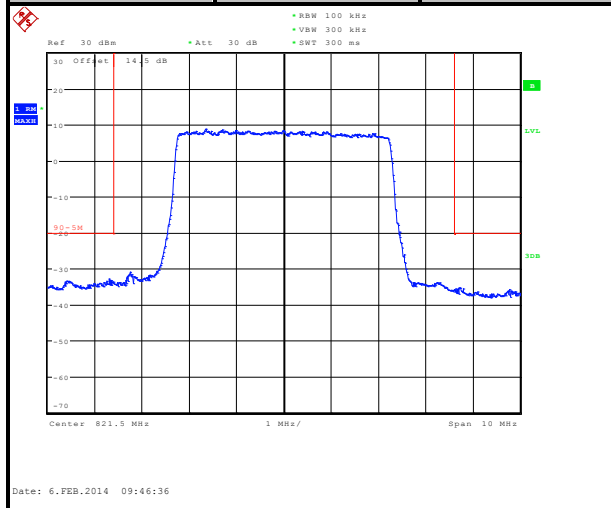



A D T

### LTE Band 26

#### Channel Bandwidth: 5MHz / 16QAM

<b>CHANNEL</b>	<b>26715</b>	<b>25 RB</b>	<b>CHANNEL</b>	<b>26740</b>	<b>25 RB</b>
----------------	--------------	--------------	----------------	--------------	--------------

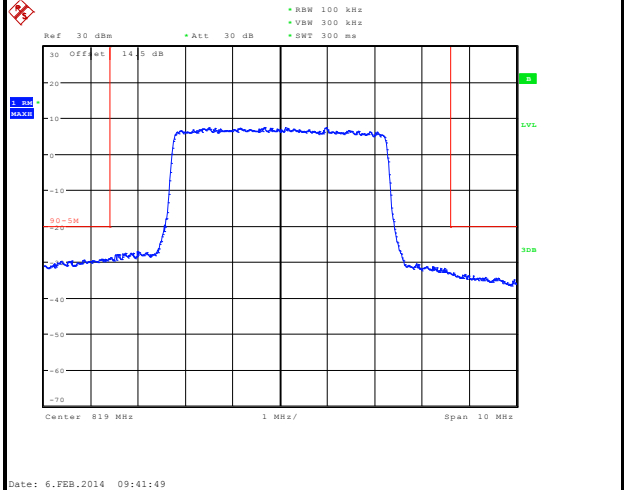
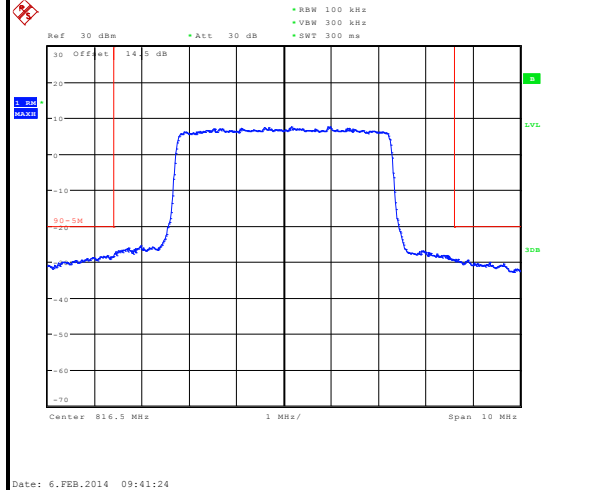

<b>CHANNEL</b>	<b>26765</b>	<b>25 RB</b>
----------------	--------------	--------------

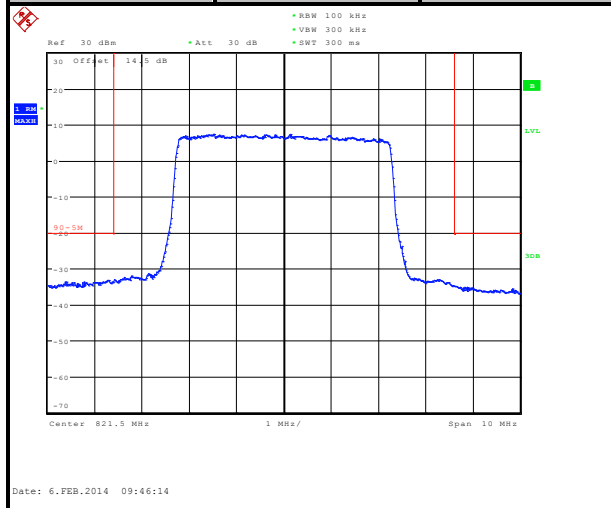





A D T

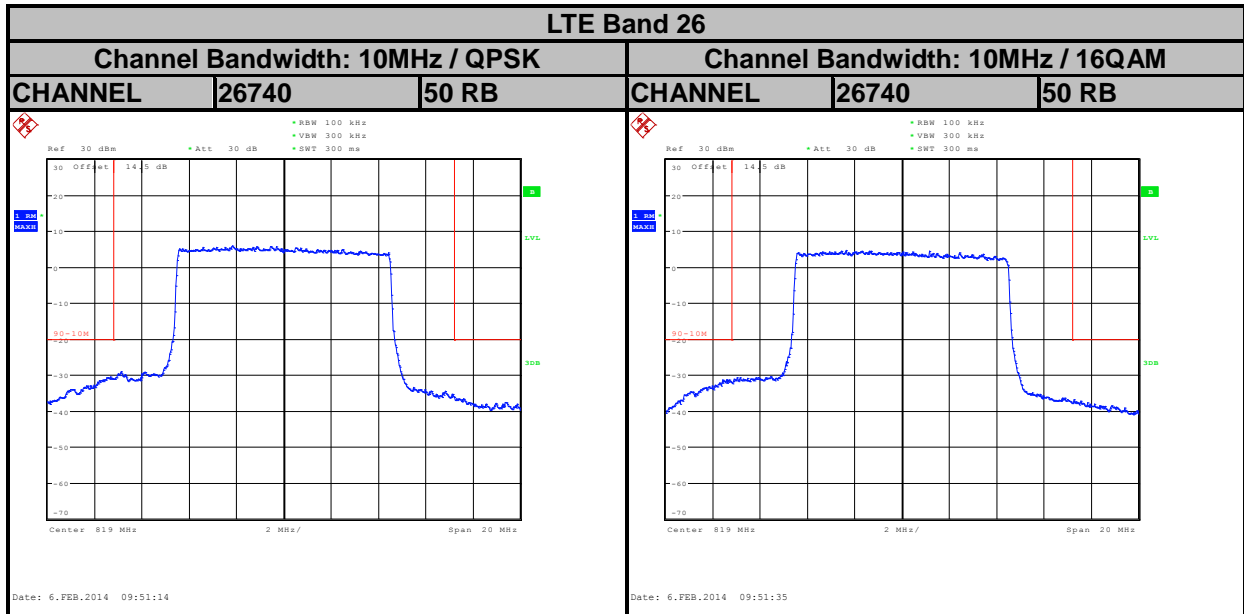

## 4.5 CONDUCTED SPURIOUS EMISSIONS

### 4.5.1 LIMITS OF CONDUCTED SPURIOUS EMISSIONS MEASUREMENT

The power of any emission outside of the authorized operating frequency ranges must be attenuated below the transmitting power (P) by a factor of at least  $43 + 10 \log(P)$  dB. The emission limit is equal to -13dBm.

### 4.5.2 TEST PROCEDURE

- The EUT makes a phone call to the communication simulator. All measurements were done at low, middle and high operational frequency range.
- Measuring frequency range is from 30 MHz to 9GHz. 10dB attenuation pad is connected with spectrum. RBW=1MHz and VBW=3MHz is used for conducted emission measurement.

### 4.5.3 TEST SETUP

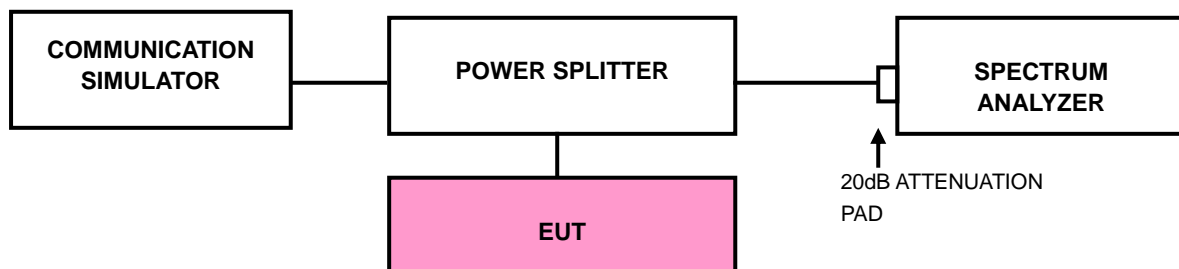



A D T

#### 4.5.4 TEST RESULTS

FREQUENCY RANGE: 30MHz~9GHz

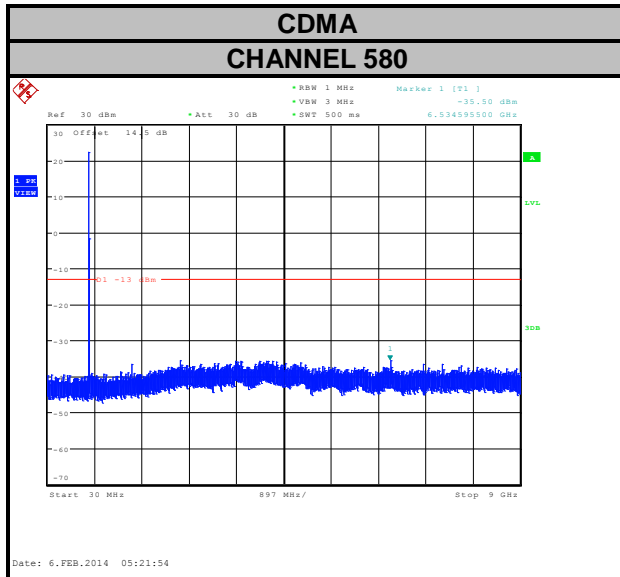



A D T

LTE BAND 26  
CHANNEL 26740

Channel Bandwidth: 1.4MHz

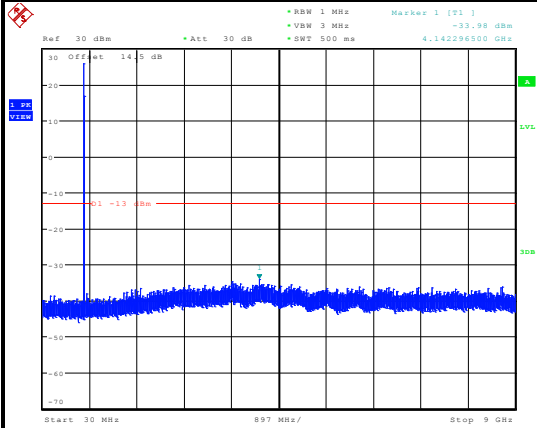

Date: 6.FEB.2014 09:09:56

Channel Bandwidth: 3MHz

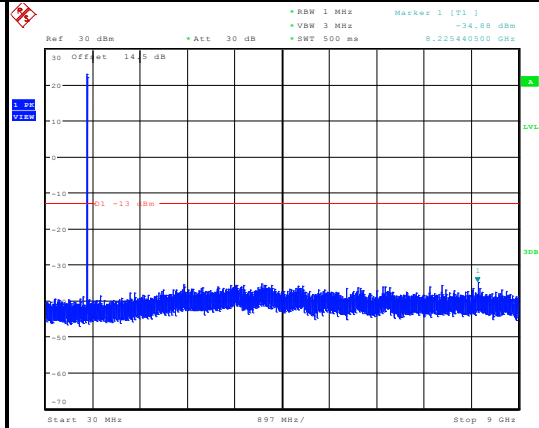

Date: 6.FEB.2014 09:33:33

Channel Bandwidth: 5MHz

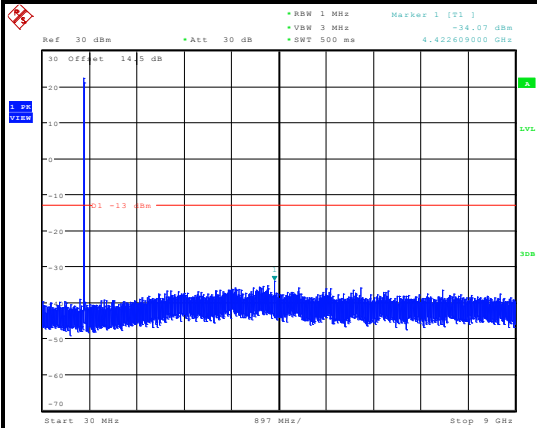

Date: 6.FEB.2014 09:48:16

Channel Bandwidth: 10MHz

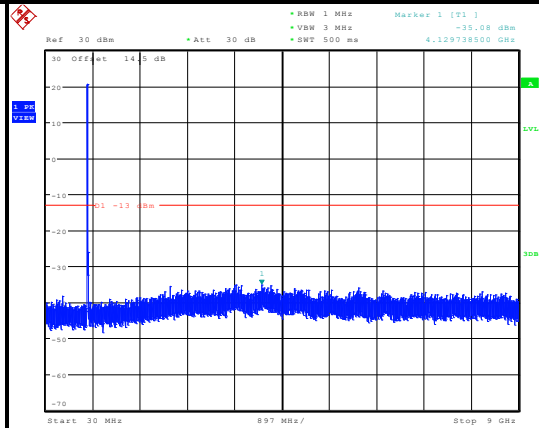

Date: 6.FEB.2014 09:50:07

## 4.6 RADIATED EMISSION MEASUREMENT

### 4.6.1 LIMITS OF RADIATED EMISSION MEASUREMENT

The power of any emission outside of the authorized operating frequency ranges must be attenuated below the transmitting power (P) by a factor of at least  $43 + 10 \log(P)$  dB. The emission limit is equal to -13dBm.

### 4.6.2 TEST PROCEDURES

- a. Substitution method is used for E.I.R.P measurement. In the semi-anechoic chamber, EUT placed on the 0.8m height of Turn Table, rotated the table around 360 degrees to search the maximum radiation power and receiver antenna shall be rotated vertical and horizontal polarization and moved height from 1m to 4m to find the maximum polar radiated power. The "Read Value" is the spectrum reading the maximum power value.
- b. The substitution horn antenna is substituted for EUT at the same position and signals generator export the CW signal to the substitution antenna via a TX cable. Rotated the Turn Table and moved receiving antenna to find the maximum radiation power. Adjust output power level of S.G to get a Value of spectrum reading equal to "Read Value" of step a. Record the power level of S.G
- c.  $EIRP = \text{Output power level of S.G} - \text{TX cable loss} + \text{Antenna gain of substitution horn}$ .
- d. E.R.P power can be calculated form E.I.R.P power by subtracting the gain of dipole,  $E.R.P \text{ power} = E.I.R.P \text{ power} - 2.15\text{dBi}$ .

**NOTE:** The resolution bandwidth and video bandwidth of test receiver/spectrum analyzer is 1MHz/3MHz.

### 4.6.3 DEVIATION FROM TEST STANDARD

No deviation

#### 4.6.4 TEST SETUP

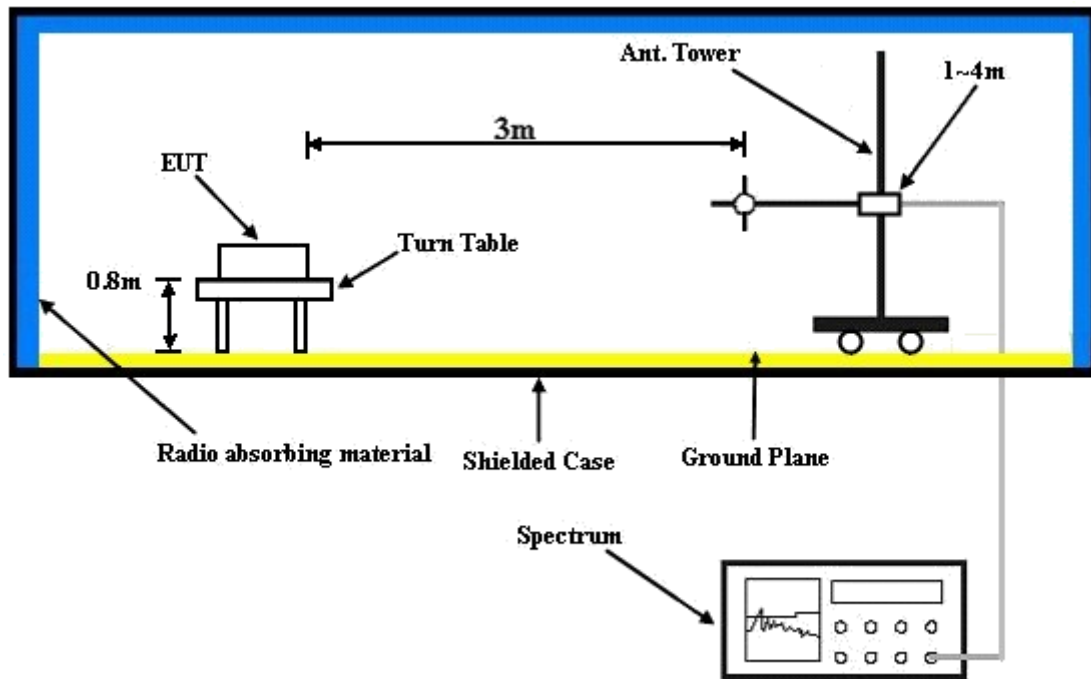

For the actual test configuration, please refer to the attached file (Test Setup Photo).

### 4.6.5 TEST RESULTS

MODE A

CDMA:



Bureau Veritas Consumer Products Services Ltd., Taoyuan Branch

A D T

Data: 9

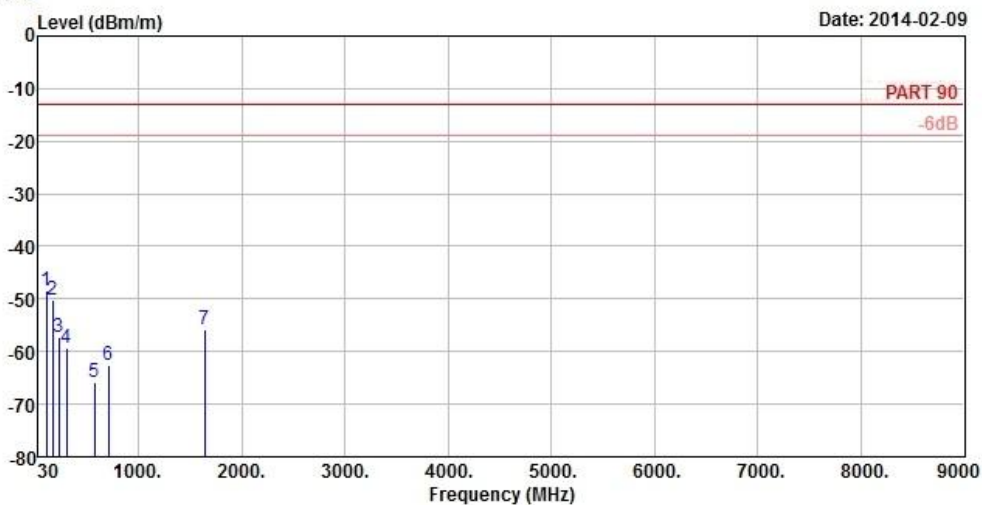

Site : 966 Chamber 5  
 Condition : PART 90 3m HORIZONTAL  
 Brand/Model: 0P9C300  
 Remark : 1xRTT800 Link  
 Tested by : Johnson Liao  
 Temperature : 25°C  
 Humidity : 65%  
 Plane : Y

	Read	Limit	Over				
Freq	Level	Level	Line	Limit	Factor	Remark	
MHz	dBm/m	dBm	dBm/m	dB	dB/m		
1 pp	109.92	-48.51	-37.90	-13.00	-35.51	-10.61	Peak
2	170.13	-50.28	-43.58	-13.00	-37.28	-6.70	Peak
3	224.13	-57.36	-50.50	-13.00	-44.36	-6.86	Peak
4	306.30	-59.39	-53.06	-13.00	-46.39	-6.33	Peak
5	571.60	-65.75	-64.60	-13.00	-52.75	-1.15	Peak
6	710.20	-62.61	-64.13	-13.00	-49.61	1.52	Peak
7	1641.00	-55.88	-42.03	-13.00	-42.88	-13.85	Peak



A D T

Data: 10

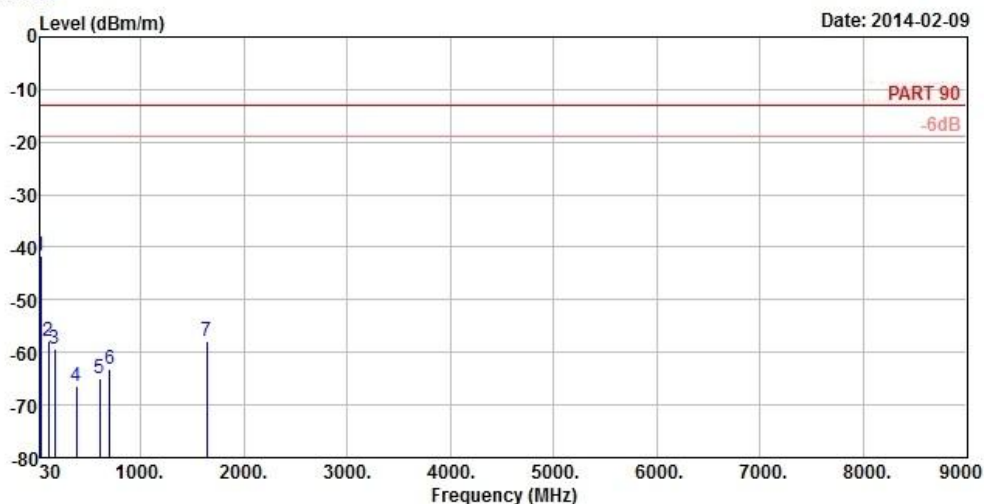

Site : 966 Chamber 5  
 Condition : PART 90 3m VERTICAL  
 Brand/Model: 0P9C300  
 Remark : 1xRTT800 Link  
 Tested by : Johnson Liao  
 Temperature : 25°C  
 Humidity : 65%  
 Plane : Y

	Freq	Level	Read Level	Limit Line	Over Limit	Factor	Remark
	MHz	dBm/m	dBm	dBm/m	dB	dB/m	
1	pp	32.70	-41.76	-40.65	-13.00	-28.76	-1.11 Peak
2		109.65	-57.97	-47.36	-13.00	-44.97	-10.61 Peak
3		167.16	-59.27	-52.63	-13.00	-46.27	-6.64 Peak
4		377.00	-66.54	-60.73	-13.00	-53.54	-5.81 Peak
5		601.70	-64.82	-64.49	-13.00	-51.82	-0.33 Peak
6		697.60	-63.13	-64.53	-13.00	-50.13	1.40 Peak
7		1641.00	-57.76	-43.91	-13.00	-44.76	-13.85 Peak



**LTE Band 26**  
**CHANNEL BANDWIDTH: 1.4MHz / QPSK**



Bureau Veritas Consumer Products Services Ltd., Taoyuan Branch

A D T

Data: 9

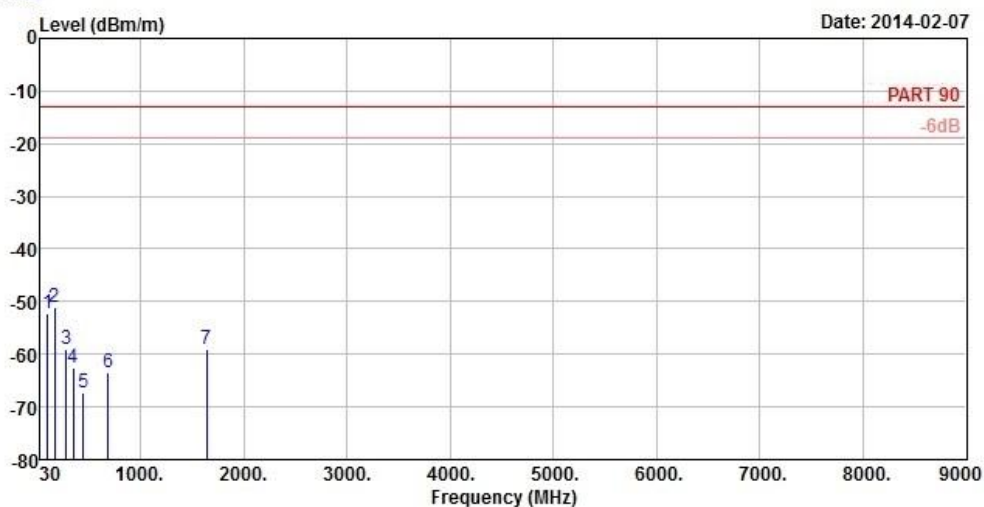

Site : 966 Chamber 5  
 Condition : PART 90 3m HORIZONTAL  
 Brand/Model: 0P9C300  
 Remark : LTE Band 26\_1.4M\_QPSK(1,2) Link  
 Tested by : Johnson Liao  
 Temperature : 25°C  
 Humidity : 65%  
 Plane : Z

	Freq	Level	Read Level	Limit Line	Over Limit	Factor	Remark
	MHz	dBm/m	dBm	dBm/m	dB	dB/m	
1	101.01	-52.10	-41.68	-13.00	-39.10	-10.42	Peak
2	163.92	-51.17	-44.59	-13.00	-38.17	-6.58	Peak
3	280.02	-59.10	-52.99	-13.00	-46.10	-6.11	Peak
4	350.40	-62.50	-56.49	-13.00	-49.50	-6.01	Peak
5	442.80	-67.20	-62.66	-13.00	-54.20	-4.54	Peak
6	684.30	-63.33	-64.50	-13.00	-50.33	1.17	Peak
7	1638.00	-59.15	-45.28	-13.00	-46.15	-13.87	Peak



A D T



# Bureau Veritas Consumer Products Services Ltd., Taoyuan Branch

A D T

Data: 10

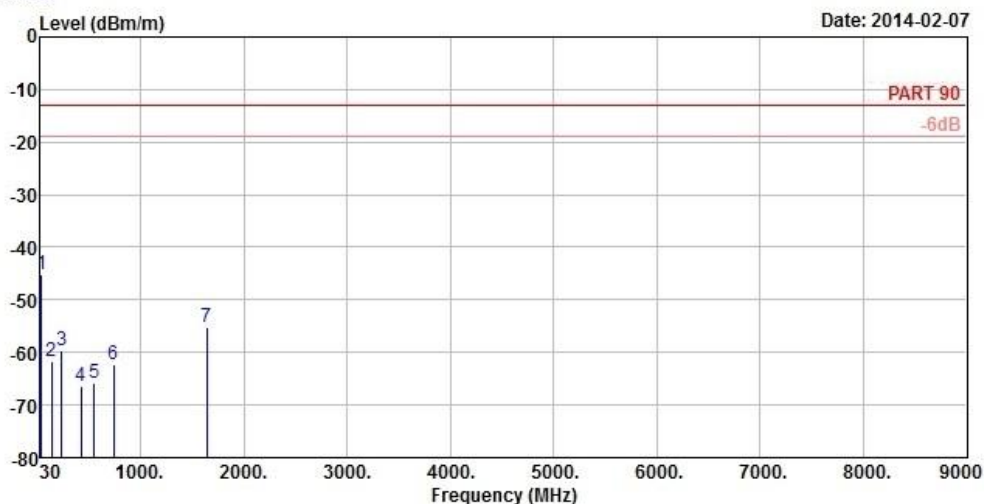

Site : 966 Chamber 5  
 Condition : PART 90 3m VERTICAL  
 Brand/Model: 0P9C300  
 Remark : LTE Band 26\_1.4M\_QPSK(1,2) Link  
 Tested by : Johnson Liao  
 Temperature : 25°C  
 Humidity : 65%  
 Plane : Z

	Freq	Level	Read Level	Limit Line	Over Limit	Factor	Remark
	MHz	dBm/m	dBm	dBm/m	dB	dB/m	
1	pp	40.26	-45.12	-43.66	-13.00	-32.12	-1.46 Peak
2		137.19	-61.76	-55.57	-13.00	-48.76	-6.19 Peak
3		236.28	-59.69	-53.40	-13.00	-46.69	-6.29 Peak
4		426.00	-66.36	-61.38	-13.00	-53.36	-4.98 Peak
5		553.40	-65.97	-64.34	-13.00	-52.97	-1.63 Peak
6		735.40	-62.38	-64.07	-13.00	-49.38	1.69 Peak
7		1638.00	-55.27	-41.40	-13.00	-42.27	-13.87 Peak

**LTE Band 26**  
**CHANNEL BANDWIDTH: 3MHz / QPSK**



Bureau Veritas Consumer Products Services Ltd., Taoyuan Branch

A D T

Data: 5

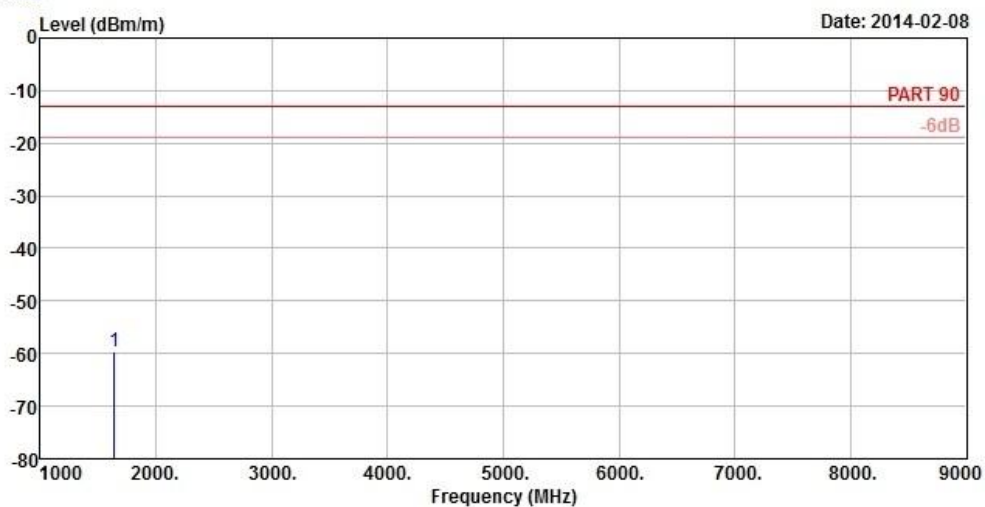

Site : 966 Chamber 5  
 Condition : PART 90 3m HORIZONTAL  
 Brand/Model: 0P9C300  
 Remark : LTE Band 26\_3M\_QPSK(1,7) Link  
 Tested by : Johnson Liao  
 Temperature : 25°C  
 Humidity : 65%  
 Plane : Z

	Read	Limit	Over			
Freq	Level	Level	Line	Limit	Factor	Remark
MHz	dBm/m	dBm	dBm/m	dB	dB/m	
1 pp 1638.00	-59.56	-45.69	-13.00	-46.56	-13.87	Peak



A D T

Data: 6

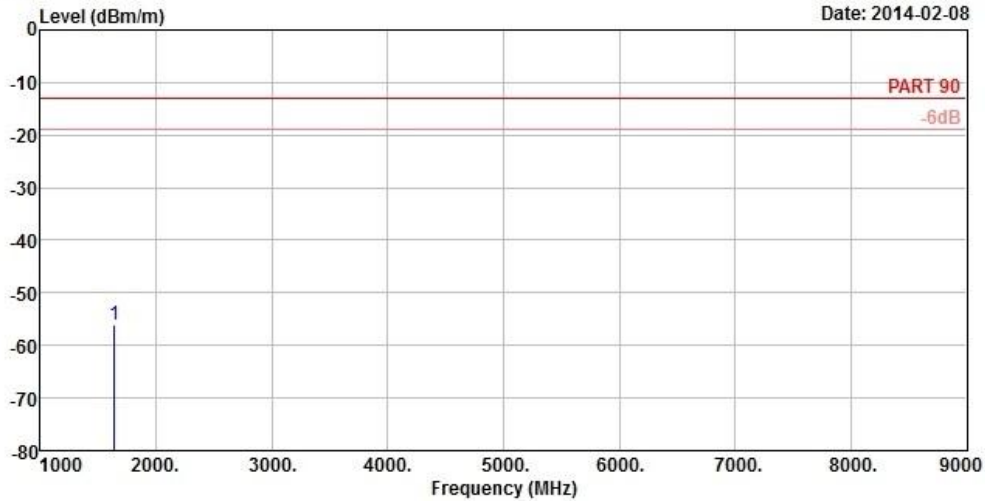

Site : 966 Chamber 5  
 Condition : PART 90 3m VERTICAL  
 Brand/Model: 0P9C300  
 Remark : LTE Band 26\_3M\_QPSK(1,7) Link  
 Tested by : Johnson Liao  
 Temperature : 25°C  
 Humidity : 65%  
 Plane : Z

Freq	Level	Read Level	Limit Line	Over Limit	Factor	Remark
MHz	dBm/m	dBm	dBm/m	dB	dB/m	
1 pp 1638.00	-56.11	-42.24	-13.00	-43.11	-13.87	Peak

**LTE Band 26**  
**CHANNEL BANDWIDTH: 5MHz / QPSK**



Bureau Veritas Consumer Products Services Ltd., Taoyuan Branch

A D T

Data: 5

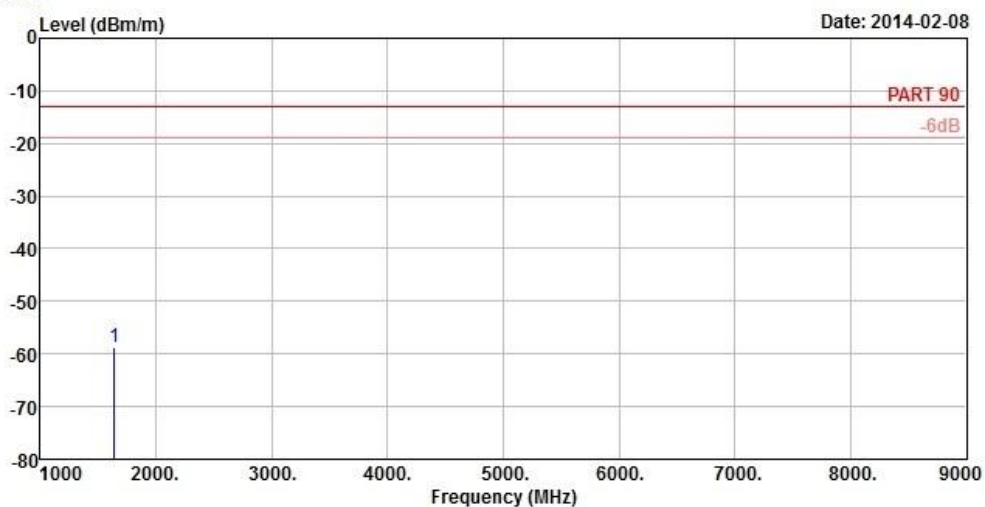

Site : 966 Chamber 5  
 Condition : PART 90 3m HORIZONTAL  
 Brand/Model: 0P9C300  
 Remark : LTE Band 26\_5M\_QPSK(1,12) Link  
 Tested by : Johnson Liao  
 Temperature : 25°C  
 Humidity : 65%  
 Plane : Z

	Read	Limit	Over			
Freq	Level	Level	Line	Limit	Factor	Remark
MHz	dBm/m	dBm	dBm/m	dB	dB/m	
1 pp 1638.00	-58.63	-44.76	-13.00	-45.63	-13.87	Peak



A D T

Data: 6

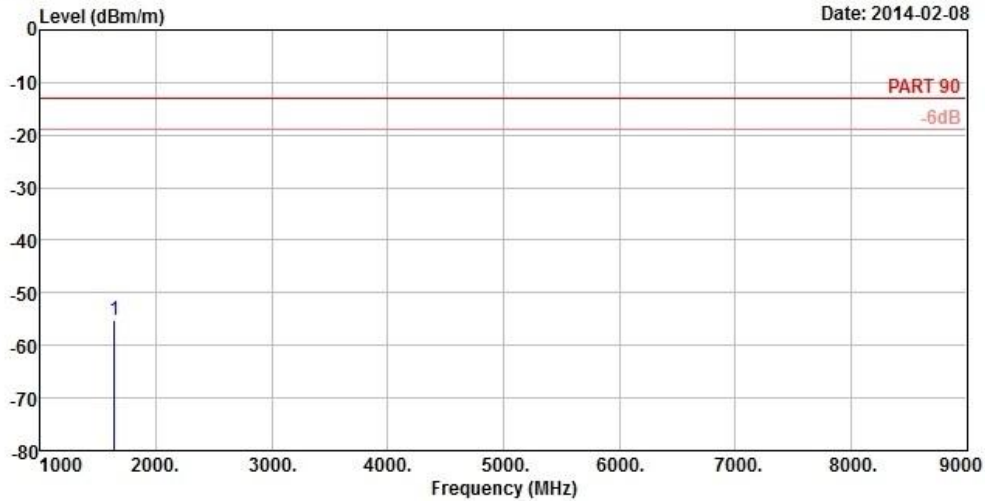

Site : 966 Chamber 5  
 Condition : PART 90 3m VERTICAL  
 Brand/Model: 0P9C300  
 Remark : LTE Band 26\_5M\_QPSK(1,12) Link  
 Tested by : Johnson Liao  
 Temperature : 25°C  
 Humidity : 65%  
 Plane : Z

	Read	Limit	Over			
Freq	Level	Level	Line	Limit	Factor	Remark
MHz	dBm/m	dBm	dBm/m	dB	dB/m	
1 pp 1638.00	-55.21	-41.34	-13.00	-42.21	-13.87	Peak

**LTE Band 26**  
**CHANNEL BANDWIDTH: 10MHz / QPSK**



Bureau Veritas Consumer Products Services Ltd., Taoyuan Branch

A D T

Data: 5

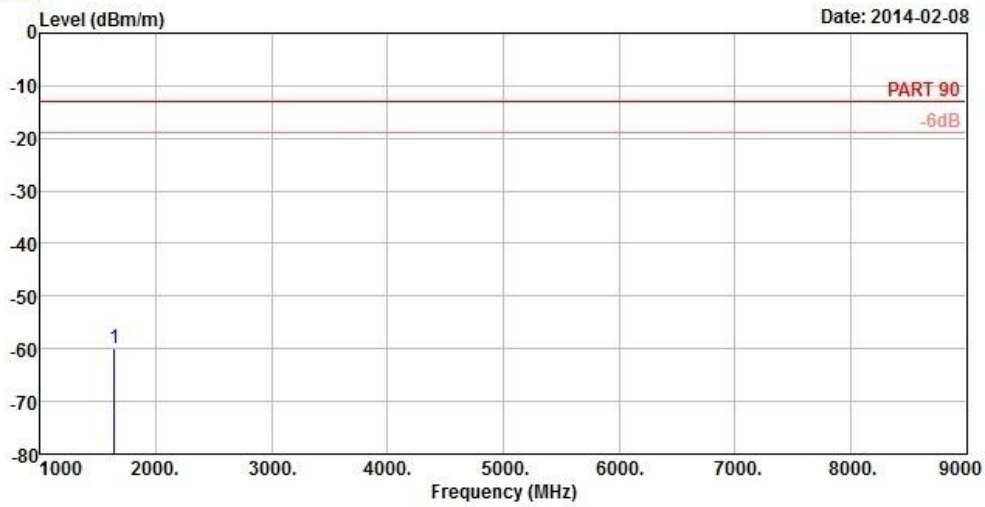

Site : 966 Chamber 5  
 Condition : PART 90 3m HORIZONTAL  
 Brand/Model: 0P9C300  
 Remark : LTE Band 26\_10M\_QPSK(1,24) Link  
 Tested by : Johnson Liao  
 Temperature : 25°C  
 Humidity : 65%  
 Plane : Z

	Read	Limit	Over			
Freq	Level	Level	Line	Limit	Factor	Remark
MHz	dBm/m	dBm	dBm/m	dB	dB/m	
1 pp 1638.00	-59.91	-46.04	-13.00	-46.91	-13.87	Peak



Bureau Veritas Consumer Products Services Ltd., Taoyuan Branch

A D T

Data: 6

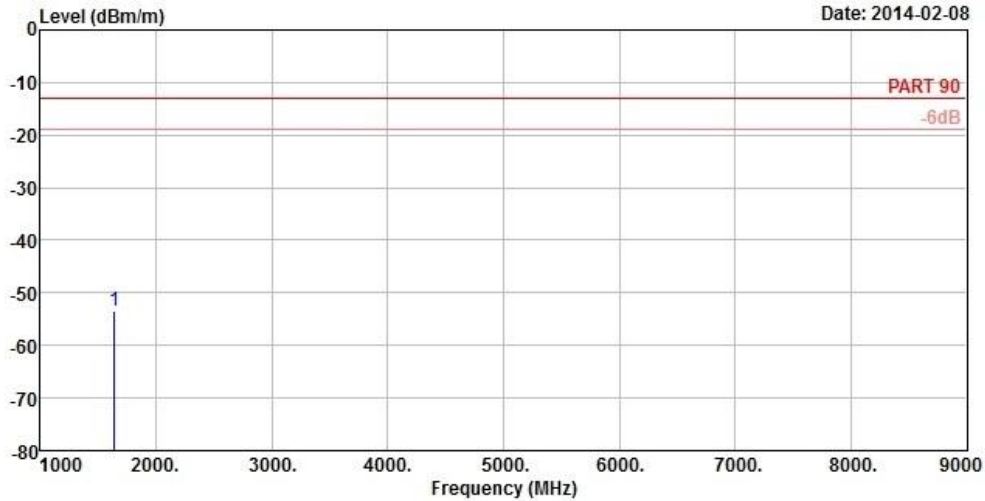

Site : 966 Chamber 5  
 Condition : PART 90 3m VERTICAL  
 Brand/Model: 0P9C300  
 Remark : LTE Band 26\_10M\_QPSK(1,24) Link  
 Tested by : Johnson Liao  
 Temperature : 25°C  
 Humidity : 65%  
 Plane : Z

Freq	Level	Read Level	Limit Line	Over Limit	Factor	Remark
MHz	dBm/m	dBm	dBm/m	dB	dB/m	
1 pp 1638.00	-53.46	-39.59	-13.00	-40.46	-13.87	Peak



**MODE B**  
**CDMA:**



Bureau Veritas Consumer Products Services Ltd., Taoyuan Branch

A D T

Data: 9

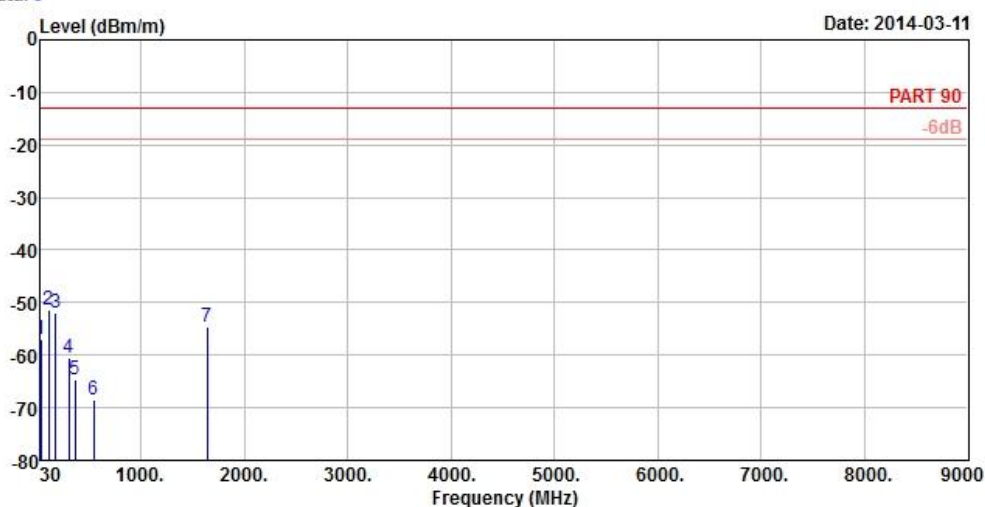

Site : 966 Chamber 5  
 Condition : PART 90 3m HORIZONTAL  
 Brand/Model: 0P9C300  
 Remark : 1xRTT800 Link  
 Tested by : David Huang  
 Temperature : 25°C  
 Humidity : 65%  
 Plane : X

	Freq	Level	Read Level	Limit Line	Over Limit	Factor	Remark
	MHz	dBm/m	dBm	dBm/m	dB	dB/m	
1	34.59	-56.85	-54.28	-13.00	-43.85	-2.57	Peak
2 pp	105.60	-51.23	-40.70	-13.00	-38.23	-10.53	Peak
3	176.61	-51.91	-45.49	-13.00	-38.91	-6.42	Peak
4	301.40	-60.49	-54.12	-13.00	-47.49	-6.37	Peak
5	362.30	-64.66	-58.75	-13.00	-51.66	-5.91	Peak
6	544.30	-68.46	-66.57	-13.00	-55.46	-1.89	Peak
7	1641.00	-54.53	-40.68	-13.00	-41.53	-13.85	Peak



A D T

Data: 10

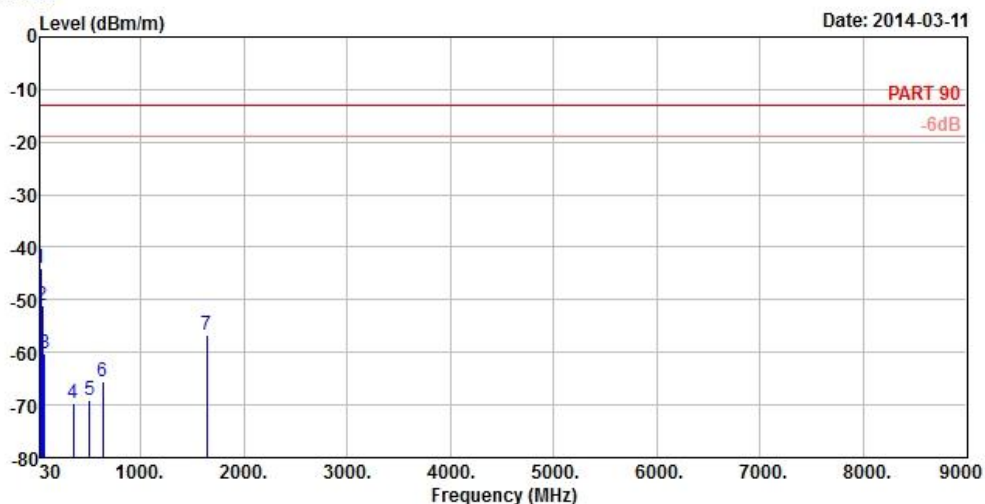

Site : 966 Chamber 5  
 Condition : PART 90 3m VERTICAL  
 Brand/Model: 0P9C300  
 Remark : 1xRTT800 Link  
 Tested by : David Huang  
 Temperature : 25°C  
 Humidity : 65%  
 Plane : X

	Freq	Level	Read Level	Limit Line	Over Limit	Factor	Remark
	MHz	dBm/m	dBm	dBm/m	dB	dB/m	
1 pp	31.08	-43.99	-44.33	-13.00	-30.99	0.34	Peak
2	44.04	-51.12	-49.86	-13.00	-38.12	-1.26	Peak
3	68.34	-60.34	-51.32	-13.00	-47.34	-9.02	Peak
4	344.80	-69.64	-63.60	-13.00	-56.64	-6.04	Peak
5	505.80	-69.05	-66.12	-13.00	-56.05	-2.93	Peak
6	631.80	-65.53	-65.74	-13.00	-52.53	0.21	Peak
7	1641.00	-56.71	-42.86	-13.00	-43.71	-13.85	Peak



A D T

## 5 PHOTOGRAPHS OF THE TEST CONFIGURATION

Please refer to the attached file (Test Setup Photo).



## 6 INFORMATION ON THE TESTING LABORATORIES

We, Bureau Veritas Consumer Products Services (H.K.) Ltd., Taoyuan Branch, were founded in 1988 to provide our best service in EMC, Radio, Telecom and Safety consultation. Our laboratories are accredited and approved according to ISO/IEC 17025.

If you have any comments, please feel free to contact us at the following:

**Linko EMC/RF Lab:**

Tel: 886-2-26052180  
Fax: 886-2-26051924

**Hsin Chu EMC/RF Lab:**

Tel: 886-3-5935343  
Fax: 886-3-5935342

**Hwa Ya EMC/RF/Safety/Telecom Lab:**

Tel: 886-3-3183232  
Fax: 886-3-3270892

**Email:** [service.adt@tw.bureauveritas.com](mailto:service.adt@tw.bureauveritas.com)

**Web Site:** [www.bureauveritas-adt.com](http://www.bureauveritas-adt.com)

The address and road map of all our labs can be found in our web site also.



A D T

## **7 APPENDIX A – MODIFICATIONS RECORDERS FOR ENGINEERING CHANGES TO THE EUT BY THE LAB**

No any modifications were made to the EUT by the lab during the test.

**---END---**