



A D T

FCC TEST REPORT (PART 24)

REPORT NO.: RF140123C02-1
MODEL NO.: 0P9C300
FCC ID: NM80P9C300
RECEIVED: Jan. 23, 2014
TESTED: Feb. 07, 2014 ~ Mar. 11, 2014
ISSUED: Mar. 28, 2014

APPLICANT: HTC Corporation

ADDRESS: No. 23, Xinghua Rd., Taoyuan City, Taiwan

ISSUED BY: Bureau Veritas Consumer Products Services
(H.K.) Ltd., Taoyuan Branch

LAB ADDRESS: No. 47, 14th Ling, Chia Pau Vil., Lin Kou Dist., New
Taipei City, Taiwan (R.O.C.)

TEST LOCATION: No. 19, Hwa Ya 2nd Rd, Wen Hwa Tsuen, Kwei
Shan Hsiang, Taoyuan Hsien 333, Taiwan, R.O.C.

This report should not be used by the client to claim
product certification, approval, or endorsement by TAF or
any government agencies.



This report is for your exclusive use. Any copying or replication of this report to or for any other person or entity, or use of our name or trademark, is permitted only with our prior written permission. This report sets forth our findings solely with respect to the test samples identified herein. The results set forth in this report are not indicative or representative of the quality or characteristics of the lot from which a test sample was taken or any similar or identical product unless specifically and expressly noted. Our report includes all of the tests requested by you and the results thereof based upon the information that you provided to us. You have 60 days from date of issuance of this report to notify us of any material error or omission caused by our negligence, provided, however, that such notice shall be in writing and shall specifically address the issue you wish to raise. A failure to raise such issue within the prescribed time shall constitute your unqualified acceptance of the completeness of this report, the tests conducted and the correctness of the report contents. Unless specific mention, the uncertainty of measurement has been explicitly taken into account to declare the compliance or non-compliance to the specification



TABLE OF CONTENTS

RELEASE CONTROL RECORD	3
1 CERTIFICATION	4
2 SUMMARY OF TEST RESULTS.....	5
2.1 MEASUREMENT UNCERTAINTY	5
2.2 TEST SITE AND INSTRUMENTS	6
3 GENERAL INFORMATION	7
3.1 GENERAL DESCRIPTION OF EUT.....	7
3.2 CONFIGURATION OF SYSTEM UNDER TEST	9
3.3 DESCRIPTION OF SUPPORT UNITS.....	9
3.4 TEST ITEM AND TEST CONFIGURATION	10
3.5 EUT OPERATING CONDITIONS.....	13
3.6 GENERAL DESCRIPTION OF APPLIED STANDARDS	13
4 TEST TYPES AND RESULTS.....	14
4.1 OUTPUT POWER MEASUREMENT	14
4.1.1 LIMITS OF OUTPUT POWER MEASUREMENT	14
4.1.2 TEST PROCEDURES	14
4.1.3 TEST SETUP	15
4.1.4 TEST RESULTS	16
4.2 FREQUENCY STABILITY MEASUREMENT	24
4.2.1 LIMITS OF FREQUENCY STABILITY MEASUREMENT	24
4.2.2 TEST PROCEDURE	24
4.2.3 TEST SETUP	24
4.2.4 TEST RESULTS	25
4.3 OCCUPIED BANDWIDTH MEASUREMENT	26
4.3.1 TEST PROCEDURES	26
4.3.2 TEST SETUP	26
4.3.3 TEST RESULTS	27
4.4 PEAK TO AVERAGE RATIO.....	31
4.4.1 LIMITS OF PEAK TO AVERAGE RATIO MEASUREMENT	31
4.4.2 TEST SETUP	31
4.4.3 TEST PROCEDURES	31
4.4.4 TEST RESULTS	32
4.5 BAND EDGE MEASUREMENT	36
4.5.1 LIMITS OF BAND EDGE MEASUREMENT	36
4.5.2 TEST SETUP	36
4.5.3 TEST PROCEDURES	36
4.5.4 TEST RESULTS	37
4.6 CONDUCTED SPURIOUS EMISSIONS.....	43
4.6.1 LIMITS OF CONDUCTED SPURIOUS EMISSIONS MEASUREMENT.....	43
4.6.2 TEST PROCEDURE	43
4.6.3 TEST SETUP	43
4.6.4 TEST RESULTS	44
4.7 RADIATED EMISSION MEASUREMENT	46
4.7.1 LIMITS OF RADIATED EMISSION MEASUREMENT	46
4.7.2 TEST PROCEDURES.....	46
4.7.3 DEVIATION FROM TEST STANDARD.....	46
4.7.4 TEST SETUP	47
4.7.5 TEST RESULTS	48
5 PHOTOGRAPHS OF THE TEST CONFIGURATION	64
6 INFORMATION ON THE TESTING LABORATORIES	65
7 APPENDIX A – MODIFICATIONS RECORDERS FOR ENGINEERING CHANGES TO THE EUT BY THE LAB.....	66



A D T

RELEASE CONTROL RECORD

ISSUE NO.	REASON FOR CHANGE	DATE ISSUED
RF140123C02-1	Original release	Mar. 28, 2014



1 CERTIFICATION

PRODUCT: Smartphone

MODEL: 0P9C300

BRAND: HTC

APPLICANT: HTC Corporation

TESTED: Feb. 07, 2014 ~ Mar. 11, 2014

TEST SAMPLE: Production Unit

STANDARDS: FCC Part 24, Subpart E

The above equipment (model: 0P9C300) has been tested by **Bureau Veritas Consumer Products Services (H.K.) Ltd., Taoyuan Branch**, and found compliance with the requirement of the above standards. The test record, data evaluation & Equipment Under Test (EUT) configurations represented herein are true and accurate accounts of the measurements of the sample's EMC characteristics under the conditions specified in this report.

PREPARED BY : Ivonne Wu , **DATE** : Mar. 28, 2014
Ivonne Wu / Supervisor

APPROVED BY : Sam Chen , **DATE** : Mar. 28, 2014
Sam Chen / Senior Project Engineer

2 SUMMARY OF TEST RESULTS

The EUT has been tested according to the following specifications:

APPLIED STANDARD: FCC Part 24 & Part 2			
STANDARD SECTION	TEST TYPE	RESULT	REMARK
2.1046 24.232	Equivalent Isotropically Radiated Power	PASS	Meet the requirement of limit.
2.1055 24.235	Frequency Stability	PASS	Meet the requirement of limit.
2.1049 24.238(b)	Occupied Bandwidth	PASS	Meet the requirement of limit.
24.232(d)	Peak to average ratio	PASS	Meet the requirement of limit.
24.238(b)	Band Edge Measurements	PASS	Meet the requirement of limit.
2.1051 24.238	Conducted Spurious Emissions	PASS	Meet the requirement of limit.
2.1053 24.238	Radiated Spurious Emissions	PASS	Meet the requirement of limit. Minimum passing margin is -22.56dB at 7530.00MHz.

2.1 MEASUREMENT UNCERTAINTY

Where relevant, the following measurement uncertainty levels have been estimated for tests performed on the EUT as specified in CISPR 16-4-2:

MEASUREMENT	FREQUENCY	UNCERTAINTY
Conducted emissions	150kHz~30MHz	2.44 dB
Radiated emissions	30MHz ~ 200MHz	2.93 dB
	200MHz ~1000MHz	2.95 dB
	1GHz ~ 18GHz	2.26 dB
	18GHz ~ 40GHz	1.94 dB

This uncertainty represents an expanded uncertainty expressed at approximately the 95% confidence level using a coverage factor of k=2.



2.2 TEST SITE AND INSTRUMENTS

DESCRIPTION & MANUFACTURER	MODEL NO.	SERIAL NO.	DATE OF CALIBRATION	DUE DATE OF CALIBRATION
Test Receiver ROHDE & SCHWARZ	ESCI	100744	Apr. 15, 2013	Apr. 14, 2014
Spectrum Analyzer ROHDE & SCHWARZ	FSU43	101261	Dec. 21, 2013	Dec. 20, 2014
BILOG Antenna SCHWARZBECK	VULB9168	9168-472	Mar. 25, 2013	Mar. 24, 2014
HORN Antenna SCHWARZBECK	BBHA 9120 D	9120D-783	Sep. 26, 2013	Sep. 25, 2014
HORN Antenna SCHWARZBECK	BBHA 9170	9170-480	Dec. 18, 2013	Dec. 17, 2014
Loop Antenna	EM-6879	264	Dec. 10, 2012	Dec. 09, 2014
Preamplifier EMCI	EMC 012645	980115	Dec. 26, 2013	Dec. 25, 2014
Preamplifier EMCI	EMC 184045	980116	Jan. 13, 2014	Jan. 12, 2015
Preamplifier EMCI	EMC 330H	980112	Dec. 27, 2013	Dec. 26, 2014
RF signal cable HUBER+SUHNNER	SUCOFLEX 104	309219/4 2950114	Oct. 18, 2013	Oct. 17, 2014
RF signal cable HUBER+SUHNNER	SUCOFLEX 104	250130/4	Oct. 18, 2013	Oct. 17, 2014
RF signal cable Worken	RG-213	NA	Nov. 07, 2013	Nov. 06, 2014
Software BV ADT	E3 6.120103	NA	NA	NA
Antenna Tower MF	MFA-440H	NA	NA	NA
Turn Table MF	MFT-201SS	NA	NA	NA
Antenna Tower & Turn Table Controller MF	MF-7802	NA	NA	NA
Mini-Circuits Power Splitter	ZN2PD-9G	NA	Jul. 18, 2013	Jul. 17, 2014
JFW 20dB attenuation	50HF-020-SMA	NA	NA	NA
Communications Tester-Wireless	E5515C	MY52102544	Sep. 05, 2012	Sep. 04, 2014
Radio Communication Analyzer	MT8820C	6201300640	Aug. 01, 2013	Jul. 31, 2014

NOTE: 1. The calibration interval of the above test instruments is 12 months and the calibrations are traceable to NML/ROC and NIST/USA.

2. The test was performed in HwaYa Chamber 10.

3. The horn antenna and HP preamplifier (model: 8449B) are used only for the measurement of emission frequency above 1GHz if tested.

4. The FCC Site Registration No. is 690701.

5. The IC Site Registration No. is IC 7450F-10.

3 GENERAL INFORMATION

3.1 GENERAL DESCRIPTION OF EUT

EUT	Smartphone	
MODEL NO.	0P9C300	
POWER SUPPLY	5.0Vdc (adapter or host equipment) 3.8Vdc (battery)	
MODULATION TYPE	CDMA	QPSK, OQPSK, HPSK
	LTE Band 25	QPSK, 16QAM
FREQUENCY RANGE	CDMA	1851.3MHz ~ 1908.8MHz
	LTE Band 25 (Channel Bandwidth: 1.4MHz)	1850.7MHz ~ 1914.3MHz
	LTE Band 25 (Channel Bandwidth: 3MHz)	1851.5MHz ~ 1913.5MHz
	LTE Band 25 (Channel Bandwidth: 5MHz)	1852.5MHz ~ 1912.5MHz
	LTE Band 25 (Channel Bandwidth: 10MHz)	1855MHz ~ 1910MHz
	LTE Band 25 (Channel Bandwidth: 15MHz)	1857.5MHz ~ 1907.5MHz
	LTE Band 25 (Channel Bandwidth: 20MHz)	1860.0MHz ~ 1905.0MHz
MAX. EIRP POWER	CDMA	140.73mW
	LTE Band 25 (Channel Bandwidth: 1.4MHz)	157.76mW
	LTE Band 25 (Channel Bandwidth: 3MHz)	148.59mW
	LTE Band 25 (Channel Bandwidth: 5MHz)	153.89mW
	LTE Band 25 (Channel Bandwidth: 10MHz)	164.44mW
	LTE Band 25 (Channel Bandwidth: 15MHz)	170.61mW
	LTE Band 25 (Channel Bandwidth: 20MHz)	169.98mW
EMISSION DESIGNATOR	CDMA	1M27F9W
	LTE Band 25 (Channel Bandwidth: 1.4MHz)	1M08G7D
	LTE Band 25 (Channel Bandwidth: 3MHz)	2M68G7D
	LTE Band 25 (Channel Bandwidth: 5MHz)	4M49G7D
	LTE Band 25 (Channel Bandwidth: 10MHz)	8M92G7D
	LTE Band 25 (Channel Bandwidth: 15MHz)	13M4G7D
	LTE Band 25 (Channel Bandwidth: 20MHz)	17M8W7D
ANTENNA TYPE	Fixed Internal Antenna	
I/O PORTS	Refer to users' manual	
DATA CABLE	Refer to NOTE as below	
ACCESSORY DEVICES	Refer to NOTE as below	

NOTE:

1. The EUT's accessories list refers to Ext. Pho.
2. There're 2 configurations for the EUT listed as below.
Main sample (A): Phone + Battery 1
2nd sample (B): Phone + Battery 2
✧ Only the worst test data was presented in the report.
3. The above EUT information was declared by manufacturer and for more detailed features description, please refer to the manufacturer's specifications or User's Manual.

3.2 CONFIGURATION OF SYSTEM UNDER TEST

FOR RADIATION EMISSION TEST

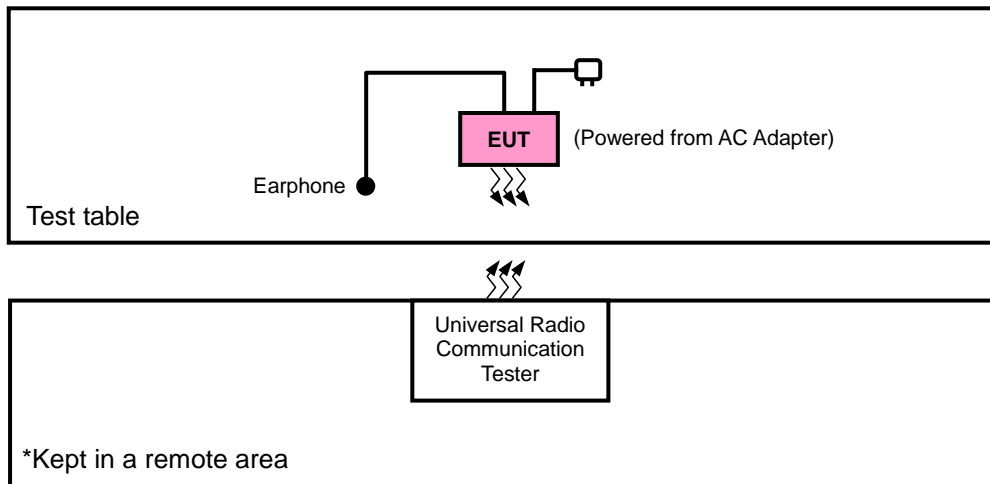

FOR E.I.R.P. TEST

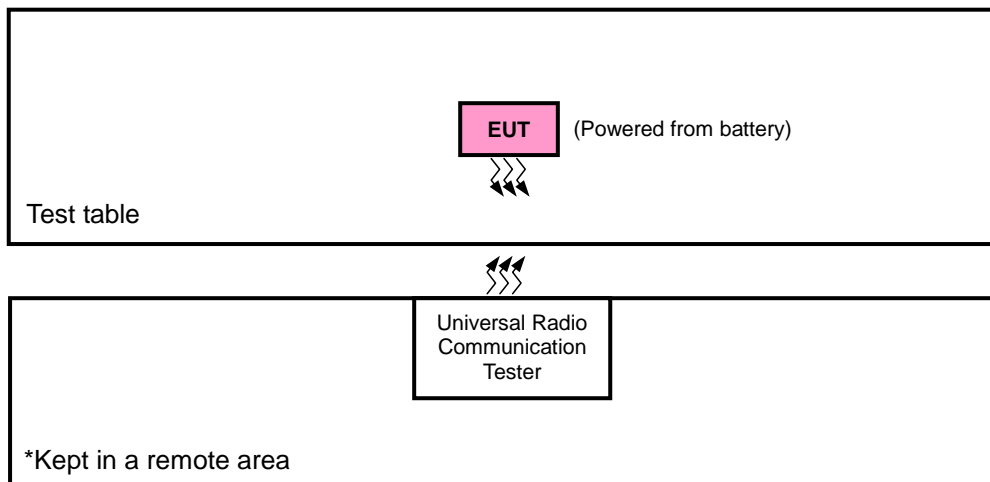

3.3 DESCRIPTION OF SUPPORT UNITS

The EUT has been tested as an independent unit together with other necessary accessories or support units.

3.4 TEST ITEM AND TEST CONFIGURATION

Pre-Scan has been conducted to determine the worst-case mode from all possible combinations between available modulations, data rates, XYZ axis and antenna ports. The worst case was found as listed below. Following channel(s) was (were) selected for the final test as listed below:

EUT CONFIGURE MODE	DESCRIPTION
A	Main sample
B	2 nd sample

EUT CONFIGURE MODE	EIRP	RADIATED EMISSION
A	CDMA: X-plane LTE: Y-plane	Y-axis
B	Y-plane	X-axis

CDMA MODE

EUT CONFIGURE MODE	TEST ITEM	AVAILABLE CHANNEL	TESTED CHANNEL	MODE
A	EIRP	25 to 1175	25, 600, 1175	1xRTT
A	FREQUENCY STABILITY	25 to 1175	600	1xRTT
A	OCCUPIED BANDWIDTH	25 to 1175	25, 600, 1175	1xRTT
A	PEAK TO AVERAGE RATIO	25 to 1175	25, 600, 1175	1xRTT
A	BAND EDGE	25 to 1175	25, 1175	1xRTT
A	CONDCUDED EMISSION	25 to 1175	600	1xRTT
A	RADIATED EMISSION	25 to 1175	600	1xRTT



A D T

LTE BAND 25 MODE

EUT CONFIGURE MODE	TEST ITEM	AVAILABLE CHANNEL	TESTED CHANNEL	CHANNEL BANDWIDTH	MODULATION	MODE
A	EIRP	26047 to 26683	26047, 26365, 26683	1.4MHz	QPSK / 16QAM	1 RB / 2 RB Offset
		26055 to 26675	26055, 26365, 26675	3MHz	QPSK / 16QAM	1 RB / 7 RB Offset
		26065 to 26665	26065, 26365, 26665	5MHz	QPSK / 16QAM	1 RB / 12 RB Offset
		26090 to 26640	26090, 26365, 26640	10MHz	QPSK / 16QAM	1 RB / 24 RB Offset
		26115 to 26615	26115, 26365, 26615	15MHz	QPSK / 16QAM	1 RB / 37 RB Offset
		26140 to 26590	26140, 26365, 26590	20MHz	QPSK / 16QAM	1 RB / 50 RB Offset
B	EIRP	26115 to 26615	26115, 26365, 26615	15MHz	QPSK	1 RB / 37 RB Offset
A	FREQUENCY STABILITY	26047 to 26683	26365	1.4MHz	QPSK	1 RB / 2 RB Offset
		26055 to 26675	26365	3MHz	QPSK	1 RB / 7 RB Offset
		26065 to 26665	26365	5MHz	QPSK	1 RB / 12 RB Offset
		26090 to 26640	26365	10MHz	QPSK	1 RB / 24 RB Offset
		26115 to 26615	26365	15MHz	QPSK	1 RB / 37 RB Offset
		26140 to 26590	26365	20MHz	QPSK	1 RB / 50 RB Offset
A	OCCUPIED BANDWIDTH	26047 to 26683	26047, 26365, 26683	1.4MHz	QPSK / 16QAM	6 RB / 0 RB Offset
		26055 to 26675	26055, 26365, 26675	3MHz	QPSK / 16QAM	15 RB / 0 RB Offset
		26065 to 26665	26065, 26365, 26665	5MHz	QPSK / 16QAM	25 RB / 0 RB Offset
		26090 to 26640	26090, 26365, 26640	10MHz	QPSK / 16QAM	50 RB / 0 RB Offset
		26115 to 26615	26115, 26365, 26615	15MHz	QPSK / 16QAM	75 RB / 0 RB Offset
		26140 to 26590	26140, 26365, 26590	20MHz	QPSK / 16QAM	100 RB / 0 RB Offset
A	PEAK TO AVERAGE RATIO	26047 to 26683	26047, 26365, 26683	1.4MHz	QPSK / 16QAM	1 RB / 0 RB Offset
		26055 to 26675	26055, 26365, 26675	3MHz	QPSK / 16QAM	1 RB / 7 RB Offset
		26065 to 26665	26065, 26365, 26665	5MHz	QPSK / 16QAM	1 RB / 12 RB Offset
		26090 to 26640	26090, 26365, 26640	10MHz	QPSK / 16QAM	1 RB / 24 RB Offset
		26115 to 26615	26115, 26365, 26615	15MHz	QPSK / 16QAM	75 RB / 0 RB Offset
		26140 to 26590	26140, 26365, 26590	20MHz	QPSK / 16QAM	100 RB / 0 RB Offset



A D T

EUT CONFIGURE MODE	TEST ITEM	AVAILABLE CHANNEL	TESTED CHANNEL	CHANNEL BANDWIDTH	MODULATION	MODE		
A	BAND EDGE	26047 to 26683	26047	1.4MHz	QPSK	1 RB / 0 RB Offset 6 RB / 0 RB Offset		
			26683	1.4MHz	QPSK	1 RB / 5 RB Offset 6 RB / 0 RB Offset		
		26055 to 26675	26055	3MHz	QPSK	1 RB / 0 RB Offset 15 RB / 0 RB Offset		
			26675	3MHz	QPSK	1 RB / 14 RB Offset 15 RB / 0 RB Offset		
		26065 to 26665	26065	5MHz	QPSK	1 RB / 0 RB Offset 25 RB / 0 RB Offset		
			26665	5MHz	QPSK	1 RB / 24 RB Offset 25 RB / 0 RB Offset		
		26090 to 26640	26090	10MHz	QPSK	1 RB / 0 RB Offset 50 RB / 0 RB Offset		
			26640	10MHz	QPSK	1 RB / 49 RB Offset 50 RB / 0 RB Offset		
		26115 to 26615	26115	15MHz	QPSK	1 RB / 0 RB Offset 75 RB / 0 RB Offset		
			26615	15MHz	QPSK	1 RB / 74 RB Offset 75 RB / 0 RB Offset		
		26140 to 26590	26140	20MHz	QPSK	1 RB / 0 RB Offset 100 RB / 0 RB Offset		
			26590	20MHz	QPSK	1 RB / 99 RB Offset 100 RB / 0 RB Offset		
		A	CONDCUETED EMISSION	26047 to 26683	26365	1.4MHz	QPSK	1 RB / 5 RB Offset
				26055 to 26675	26365	3MHz	QPSK	1 RB / 7 RB Offset
				26065 to 26665	26365	5MHz	QPSK	1 RB / 12 RB Offset
				26090 to 26640	26365	10MHz	QPSK	1 RB / 24 RB Offset
26115 to 26615	26365			15MHz	QPSK	1 RB / 0 RB Offset		
26140 to 26590	26365			20MHz	QPSK	1 RB / 0 RB Offset		
A	RADIATED EMISSION	26047 to 26683	26365	1.4MHz	QPSK	1 RB / 2 RB Offset		
		26055 to 26675	26365	3MHz	QPSK	1 RB / 7 RB Offset		
		26065 to 26665	26365	5MHz	QPSK	1 RB / 12 RB Offset		
		26090 to 26640	26365	10MHz	QPSK	1 RB / 24 RB Offset		
		26115 to 26615	26365	15MHz	QPSK	1 RB / 37 RB Offset		
		26140 to 26590	26365	20MHz	QPSK	1 RB / 50 RB Offset		
B	RADIATED EMISSION	26115 to 26615	26365	15MHz	QPSK	1 RB / 37 RB Offset		

Note: This device was tested under all bandwidths, RB configurations and modulations. The worst case was found in QPSK modulation.



TEST CONDITION:

TEST ITEM	ENVIRONMENTAL CONDITIONS	INPUT POWER	TESTED BY
EIRP	26deg. C, 58%RH	3.8Vdc	Howard Kao
FREQUENCY STABILITY	26deg. C, 58%RH	3.8Vdc	Howard Kao
OCCUPIED BANDWIDTH	26deg. C, 58%RH	3.8Vdc	Howard Kao
PEAK TO AVERAGE RATIO	26deg. C, 58%RH	3.8Vdc	Howard Kao
BAND EDGE	26deg. C, 58%RH	3.8Vdc	Howard Kao
CONDCUDED EMISSION	26deg. C, 58%RH	3.8Vdc	Howard Kao
RADIATED EMISSION	25deg. C, 65%RH	120Vac, 60Hz	Johnson Liao

3.5 EUT OPERATING CONDITIONS

The EUT makes a call to the communication simulator. The communication simulator station system controlled a EUT to export maximum output power under transmission mode and specific channel frequency.

3.6 GENERAL DESCRIPTION OF APPLIED STANDARDS

The EUT is a RF product. According to the specifications of the manufacturer, it must comply with the requirements of the following standards:

FCC 47 CFR Part 2

FCC 47 CFR Part 24

ANSI/TIA/EIA-603-C 2004

NOTE: All test items have been performed and recorded as per the above standards.

4 TEST TYPES AND RESULTS

4.1 OUTPUT POWER MEASUREMENT

4.1.1 LIMITS OF OUTPUT POWER MEASUREMENT

Mobile and portable stations are limited to 2 watts EIRP.

4.1.2 TEST PROCEDURES

EIRP MEASUREMENT:

- a. All measurements were done at low, middle and high operational frequency range. RBW and VBW is 5MHz for CDMA, and 10MHz for LTE mode.
- b. Substitution method is used for E.I.R.P measurement. In the semi-anechoic chamber, EUT placed on the 0.8m height of Turn Table, rotated the table around 360 degrees to search the maximum radiation power and receiver antenna shall be rotated vertical and horizontal polarization and moved height from 1m to 4m to find the maximum polar radiated power. The “Read Value” is the spectrum reading the maximum power value.
- c. The substitution horn antenna is substituted for EUT at the same position and signals generator export the CW signal to the substitution antenna via a tx cable. Rotated the Turn Table and moved receiving antenna to find the maximum radiation power. Adjust output power level of S.G to get a Value of spectrum reading equal to “Read Value” of step b. Record the power level of S.G
- d. $EIRP = \text{Output power level of S.G} - \text{TX cable loss} + \text{Antenna gain of substitution horn}.$

CONDUCTED POWER MEASUREMENT:

The EUT was set up for the maximum power with CDMA & LTE link data modulation and link up with simulator. Set the EUT to transmit under low, middle and high channel and record the power level shown on simulator.

4.1.3 TEST SETUP

EIRP / ERP MEASUREMENT:

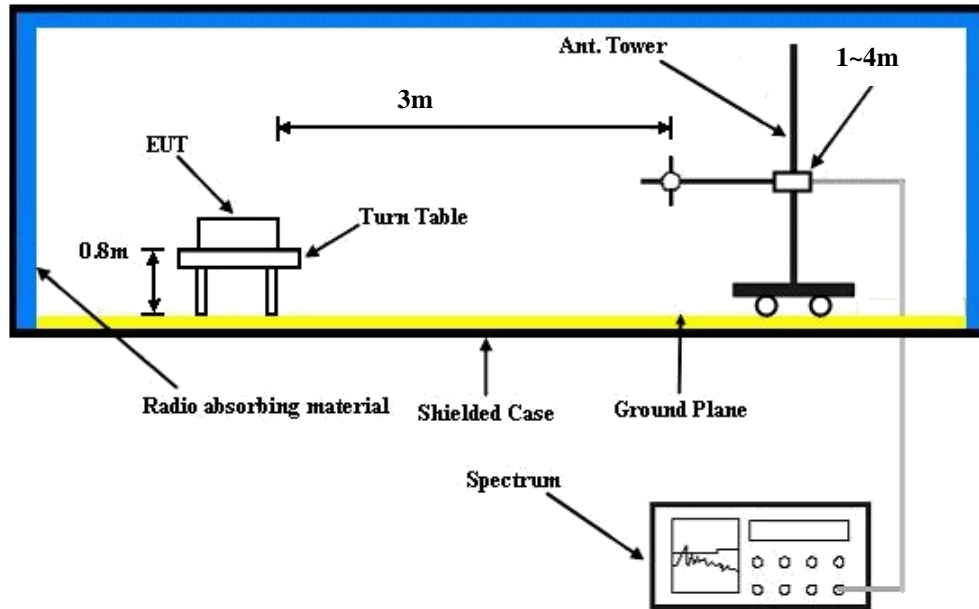

CONDUCTED POWER MEASUREMENT:

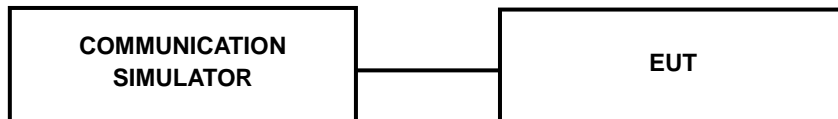



A D T

4.1.4 TEST RESULTS

CONDUCTED OUTPUT POWER (dBm)

Band	CDMA		
Channel	25	600	1175
Frequency (MHz)	1851.25	1880	1908.75
RC1+SO55	23.97	23.98	24.01
RC3+SO55	24.02	24.03	24.06
RC3+SO32(+ F-SCH)	24.00	24.01	24.04
RC3+SO32(+SCH)	23.98	23.99	24.02
RTAP 153.6	24.01	24.02	24.05
RETAP 4096	24.00	24.01	24.04

Band / BW	Modulation	RB Size	RB Offset	Low CH	Mid CH	High CH	3PGG MPR (dB)
				26047	26365	26683	
				Frequency	Frequency	Frequency	
				1850.7 MHz	1882.5 MHz	1914.3 MHz	
25 / 1.4M	QPSK	1	0	22.54	22.42	22.48	0
		1	2	22.69	22.46	22.56	0
		1	5	22.38	22.27	22.32	0
		3	0	22.63	22.57	22.64	0
		3	1	22.59	22.51	22.58	0
		3	3	22.51	22.42	22.47	0
		6	0	21.65	21.55	21.60	1
	16QAM	1	0	21.51	21.39	21.45	1
		1	2	21.60	21.43	21.53	1
		1	5	21.35	21.24	21.29	1
		3	0	21.66	21.54	21.61	1
		3	1	21.56	21.48	21.55	1
		3	3	21.48	21.39	21.44	1
		6	0	20.62	20.52	20.57	2

Band / BW	Modulation	RB Size	RB Offset	Low CH	Mid CH	High CH	3PGG MPR (dB)
				26055	26365	26675	
				Frequency	Frequency	Frequency	
				1851.5 MHz	1882.5 MHz	1913.5 MHz	
25 / 3M	QPSK	1	0	22.59	22.47	22.53	0
		1	7	22.68	22.51	22.61	0
		1	14	22.43	22.32	22.37	0
		8	0	21.74	21.62	21.69	1
		8	3	21.64	21.56	21.63	1
		8	7	21.56	21.47	21.52	1
		15	0	21.70	21.60	21.65	1
	16QAM	1	0	21.56	21.44	21.50	1
		1	7	21.65	21.48	21.58	1
		1	14	21.40	21.29	21.34	1
		8	0	20.71	20.59	20.66	2
		8	3	20.61	20.53	20.60	2
		8	7	20.53	20.44	20.49	2
		15	0	20.67	20.57	20.62	2



A D T

Band / BW	Modulation	RB Size	RB Offset	Low CH 26065	Mid CH 26365	High CH 26665	3PGG MPR (dB)
				Frequency 1852.5 MHz	Frequency 1882.5 MHz	Frequency 1912.5 MHz	
25 / 5M	QPSK	1	0	22.63	22.51	22.57	0
		1	12	22.72	22.55	22.65	0
		1	24	22.47	22.36	22.41	0
		12	0	21.78	21.66	21.73	1
		12	6	21.68	21.60	21.67	1
		12	13	21.60	21.51	21.56	1
		25	0	21.74	21.64	21.69	1
	16QAM	1	0	21.60	21.48	21.54	1
		1	12	21.69	21.52	21.62	1
		1	24	21.44	21.33	21.38	1
		12	0	20.75	20.63	20.70	2
		12	6	20.65	20.57	20.64	2
		12	13	20.57	20.48	20.53	2
		25	0	20.71	20.61	20.66	2

Band / BW	Modulation	RB Size	RB Offset	Low CH 26090	Mid CH 26365	High CH 26640	3PGG MPR (dB)
				Frequency 1855.0 MHz	Frequency 1882.5 MHz	Frequency 1910.0 MHz	
25 / 10M	QPSK	1	0	22.73	22.61	22.67	0
		1	24	22.82	22.65	22.75	0
		1	49	22.57	22.46	22.51	0
		25	0	21.88	21.76	21.83	1
		25	12	21.78	21.70	21.77	1
		25	25	21.70	21.61	21.66	1
		50	0	21.84	21.74	21.79	1
	16QAM	1	0	21.70	21.58	21.64	1
		1	24	21.79	21.62	21.72	1
		1	49	21.54	21.43	21.48	1
		25	0	20.85	20.73	20.80	2
		25	12	20.75	20.67	20.74	2
		25	25	20.67	20.58	20.63	2
		50	0	20.81	20.71	20.76	2

Band / BW	Modulation	RB Size	RB Offset	Low CH 26115	Mid CH 26365	High CH 26615	3PGG MPR (dB)
				Frequency 1857.5 MHz	Frequency 1882.5 MHz	Frequency 1907.5 MHz	
25 / 15M	QPSK	1	0	22.80	22.68	22.74	0
		1	37	22.89	22.72	22.82	0
		1	74	22.64	22.53	22.58	0
		36	0	21.95	21.83	21.90	1
		36	19	21.85	21.77	21.84	1
		36	39	21.77	21.68	21.73	1
		75	0	21.91	21.81	21.86	1
	16QAM	1	0	21.77	21.65	21.71	1
		1	37	21.86	21.69	21.79	1
		1	74	21.61	21.50	21.55	1
		36	0	20.92	20.80	20.87	2
		36	19	20.82	20.74	20.81	2
		36	39	20.74	20.65	20.70	2
		75	0	20.88	20.78	20.83	2



A D T

Band / BW	Modulation	RB Size	RB Offset	Low CH 26140	Mid CH 26365	High CH 26590	3PGG MPR (dB)
				Frequency 1860.0 MHz	Frequency 1882.5 MHz	Frequency 1905.0 MHz	
25 / 20M	QPSK	1	0	22.88	22.76	22.82	0
		1	50	22.97	22.80	22.90	0
		1	99	22.72	22.61	22.66	0
		50	0	21.99	21.91	21.98	1
		50	25	21.93	21.85	21.92	1
		50	50	21.85	21.76	21.81	1
		100	0	21.99	21.89	21.94	1
	16QAM	1	0	21.85	21.73	21.79	1
		1	50	21.94	21.77	21.87	1
		1	99	21.69	21.58	21.63	1
		50	0	21.00	20.88	20.95	2
		50	25	20.90	20.82	20.89	2
		50	50	20.82	20.73	20.78	2
		100	0	20.96	20.86	20.91	2



A D T

EIRP POWER (dBm)

MODE A

CDMA							
Plane	Channel	Frequency (MHz)	LVL (dBm)	Correction Factor(dB)	EIRP(dBm)	EIRP(mW)	Polarization (H/V)
X	25	1851.25	-15.23	36.57	21.34	136.21	H
	600	1880.00	-15.74	37.22	21.48	140.73	H
	1175	1908.75	-16.06	37.18	21.12	129.48	H
	25	1851.25	-21.61	37.65	16.04	40.19	V
	600	1880.00	-21.03	37.58	16.55	45.22	V
	1175	1908.75	-21.21	37.48	16.27	42.36	V

LTE Band 25							
Channel Bandwidth: 1.4MHz / QPSK							
Plane	Channel	Frequency (MHz)	LVL (dBm)	Correction Factor(dB)	EIRP(dBm)	EIRP(mW)	Polarization (H/V)
Y	26047	1850.7	-14.69	36.57	21.88	154.24	H
	26365	1882.5	-15.27	37.22	21.95	156.82	H
	26683	1914.3	-17.11	39.09	21.98	157.76	H
	26047	1850.7	-17.65	37.65	20.00	100.02	V
	26365	1882.5	-17.79	37.58	19.79	95.35	V
	26683	1914.3	-17.44	37.92	20.48	111.69	V

LTE Band 25							
Channel Bandwidth: 1.4MHz / 16QAM							
Plane	Channel	Frequency (MHz)	LVL (dBm)	Correction Factor(dB)	EIRP(dBm)	EIRP(mW)	Polarization (H/V)
Y	26047	1850.7	-15.60	36.57	20.97	125.08	H
	26365	1882.5	-16.12	37.22	21.10	128.94	H
	26683	1914.3	-18.03	39.09	21.06	127.64	H
	26047	1850.7	-17.61	37.65	20.04	100.95	V
	26365	1882.5	-17.82	37.58	19.76	94.69	V
	26683	1914.3	-17.69	37.92	20.23	105.44	V



A D T

LTE Band 25							
Channel Bandwidth: 3MHz / QPSK							
Plane	Channel	Frequency (MHz)	LVL (dBm)	Correction Factor(dB)	EIRP(dBm)	EIRP(mW)	Polarization (H/V)
Y	26055	1851.5	-14.88	36.57	21.69	147.64	H
	26365	1882.5	-15.61	37.22	21.61	145.01	H
	26675	1913.5	-17.39	39.11	21.72	148.59	H
	26055	1851.5	-17.62	37.65	20.03	100.72	V
	26365	1882.5	-17.39	37.58	20.19	104.54	V
	26675	1913.5	-17.22	37.93	20.71	117.76	V

LTE Band 25							
Channel Bandwidth: 3MHz / 16QAM							
Plane	Channel	Frequency (MHz)	LVL (dBm)	Correction Factor(dB)	EIRP(dBm)	EIRP(mW)	Polarization (H/V)
Y	26055	1851.5	-15.61	36.57	20.96	124.80	H
	26365	1882.5	-16.11	37.22	21.11	129.24	H
	26675	1913.5	-18.04	39.11	21.07	127.94	H
	26055	1851.5	-17.78	37.65	19.87	97.07	V
	26365	1882.5	-17.86	37.58	19.72	93.82	V
	26675	1913.5	-17.98	37.93	19.95	98.86	V



A D T

LTE Band 25							
Channel Bandwidth: 5MHz / QPSK							
Plane	Channel	Frequency (MHz)	LVL (dBm)	Correction Factor(dB)	EIRP(dBm)	EIRP(mW)	Polarization (H/V)
Y	26065	1852.5	-14.70	36.57	21.87	153.89	H
	26365	1882.5	-15.38	37.22	21.84	152.90	H
	26665	1912.5	-17.36	39.11	21.75	149.62	H
	26065	1852.5	-17.54	37.65	20.11	102.59	V
	26365	1882.5	-17.50	37.58	20.08	101.93	V
	26665	1912.5	-17.45	37.96	20.51	112.46	V

LTE Band 25							
Channel Bandwidth: 5MHz / 16QAM							
Plane	Channel	Frequency (MHz)	LVL (dBm)	Correction Factor(dB)	EIRP(dBm)	EIRP(mW)	Polarization (H/V)
Y	26065	1852.5	-15.43	36.57	21.14	130.08	H
	26365	1882.5	-16.10	37.22	21.12	129.54	H
	26665	1912.5	-17.94	39.11	21.17	130.92	H
	26065	1852.5	-17.47	37.65	20.18	104.26	V
	26365	1882.5	-17.76	37.58	19.82	96.01	V
	26665	1912.5	-17.80	37.96	20.16	103.75	V

LTE Band 25							
Channel Bandwidth: 10MHz / QPSK							
Plane	Channel	Frequency (MHz)	LVL (dBm)	Correction Factor(dB)	EIRP(dBm)	EIRP(mW)	Polarization (H/V)
Y	26090	1855	-14.55	36.57	22.02	159.29	H
	26365	1882.5	-15.14	37.22	22.08	161.58	H
	26640	1910	-17.03	39.19	22.16	164.44	H
	26090	1855	-17.47	37.65	20.18	104.26	V
	26365	1882.5	-17.87	37.58	19.71	93.61	V
	26640	1910	-18.58	38.15	19.57	90.57	V



A D T

LTE Band 25							
Channel Bandwidth: 10MHz / 16QAM							
Plane	Channel	Frequency (MHz)	LVL (dBm)	Correction Factor(dB)	EIRP(dBm)	EIRP(mW)	Polarization (H/V)
Y	26090	1855	-15.51	36.57	21.06	127.70	H
	26365	1882.5	-16.05	37.22	21.17	131.04	H
	26640	1910	-18.06	39.19	21.13	129.72	H
	26090	1855	-17.61	37.65	20.04	100.95	V
	26365	1882.5	-17.88	37.58	19.70	93.39	V
	26640	1910	-18.22	38.15	19.93	98.40	V

LTE Band 25							
Channel Bandwidth: 15MHz / QPSK							
Plane	Channel	Frequency (MHz)	LVL (dBm)	Correction Factor(dB)	EIRP(dBm)	EIRP(mW)	Polarization (H/V)
Y	26115	1857.5	-14.44	36.57	22.13	163.38	H
	26365	1882.5	-15.02	37.22	22.20	166.11	H
	26615	1907.5	-16.91	39.23	22.32	170.61	H
	26115	1857.5	-17.48	37.65	20.17	104.02	V
	26365	1882.5	-17.80	37.58	19.78	95.13	V
	26615	1907.5	-18.35	38.22	19.87	97.05	V

LTE Band 25							
Channel Bandwidth: 15MHz / 16QAM							
Plane	Channel	Frequency (MHz)	LVL (dBm)	Correction Factor(dB)	EIRP(dBm)	EIRP(mW)	Polarization (H/V)
Y	26115	1857.5	-15.41	36.57	21.16	130.68	H
	26365	1882.5	-15.94	37.22	21.28	134.40	H
	26615	1907.5	-18.02	39.23	21.21	132.13	H
	26115	1857.5	-17.98	37.65	19.67	92.70	V
	26365	1882.5	-17.74	37.58	19.84	96.45	V
	26615	1907.5	-18.40	38.22	19.82	95.94	V



A D T

LTE Band 25							
Channel Bandwidth: 20MHz / QPSK							
Plane	Channel	Frequency (MHz)	LVL (dBm)	Correction Factor(dB)	EIRP(dBm)	EIRP(mW)	Polarization (H/V)
Y	26140	1860	-14.34	36.57	22.23	167.19	H
	26365	1882.5	-14.92	37.22	22.30	169.98	H
	26590	1905	-16.48	38.72	22.24	167.49	H
	26140	1860	-17.66	37.65	19.99	99.79	V
	26365	1882.5	-17.80	37.58	19.78	95.13	V
	26590	1905	-17.43	37.56	20.13	103.04	V

LTE Band 25							
Channel Bandwidth: 20MHz / 16QAM							
Plane	Channel	Frequency (MHz)	LVL (dBm)	Correction Factor(dB)	EIRP(dBm)	EIRP(mW)	Polarization (H/V)
Y	26140	1860	-15.48	36.57	21.09	128.59	H
	26365	1882.5	-16.00	37.22	21.22	132.56	H
	26590	1905	-17.52	38.72	21.20	131.83	H
	26140	1860	-17.78	37.65	19.87	97.07	V
	26365	1882.5	-17.76	37.58	19.82	96.01	V
	26590	1905	-17.94	37.56	19.62	91.62	V

MODE B

LTE Band 25							
Channel Bandwidth: 15MHz / QPSK							
Plane	Channel	Frequency (MHz)	LVL (dBm)	Correction Factor(dB)	EIRP(dBm)	EIRP(mW)	Polarization (H/V)
Y	26115	1857.5	-15.23	36.57	21.34	136.21	H
	26365	1882.5	-15.73	37.22	21.49	141.06	H
	26615	1907.5	-17.10	39.23	22.13	163.31	H
	26115	1857.5	-18.53	37.65	19.12	81.68	V
	26365	1882.5	-18.64	37.58	18.94	78.40	V
	26615	1907.5	-19.11	38.22	19.11	81.47	V

4.2 FREQUENCY STABILITY MEASUREMENT

4.2.1 LIMITS OF FREQUENCY STABILITY MEASUREMENT

The frequency stability shall be sufficient to ensure that the fundamental emission stays within the authorized frequency block.

4.2.2 TEST PROCEDURE

- Device is placed at the oven room. The oven room could control the temperatures and humidity. Power warm up is at least 15 min and power applied should perform before recording frequency error.
- EUT is connected the external power supply to control the DC input power. The test voltage range is from minimum to maximum working voltage. Each step shall be record the frequency error rate.
- The temperature range step is 10 degrees in this test items. All temperature levels shall be hold the $\pm 0.5^{\circ}\text{C}$ during the measurement testing. The each temperature step shall be at least 0.5 hours, consider the EUT could be test under the stability condition.

NOTE: The frequency error was recorded frequency error from the communication simulator.

4.2.3 TEST SETUP

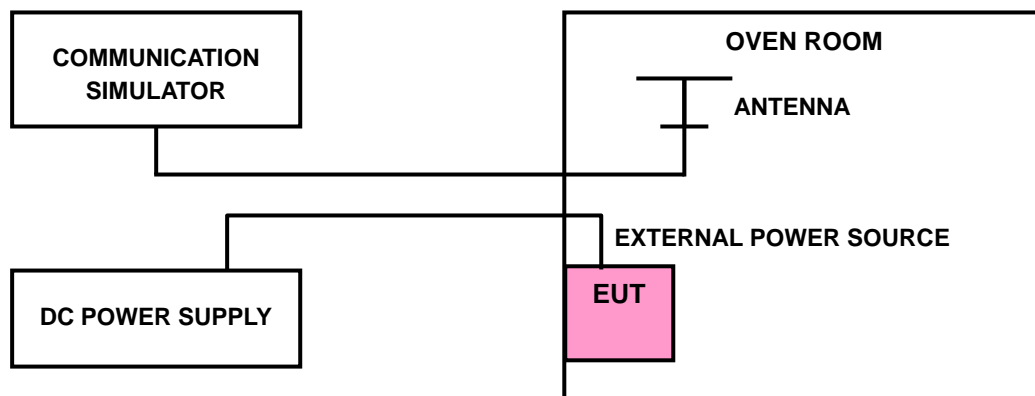

4.2.4 TEST RESULTS

FREQUENCY ERROR vs. VOLTAGE

VOLTAGE (Volts)	FREQUENCY ERROR (ppm)							LIMIT (ppm)
	CDMA	LTE Band 25						
		1.4MHz	3MHz	5MHz	10MHz	15MHz	20MHz	
3.8	0.003	-0.003	-0.001	-0.003	-0.001	0.001	-0.002	2.5
3.6	0.003	0.001	0.000	0.001	-0.001	-0.003	-0.003	2.5
4.35	0.003	-0.001	-0.003	-0.003	-0.001	0.003	-0.003	2.5

NOTE: The applicant defined the normal working voltage of the battery is from 3.6Vdc to 4.35Vdc.

FREQUENCY ERROR vs. TEMPERATURE

TEMP. (°C)	FREQUENCY ERROR (ppm)							LIMIT (ppm)
	CDMA	LTE Band 25						
		1.4MHz	3MHz	5MHz	10MHz	15MHz	20MHz	
-30	0.003	0.0017	0.0005	-0.0015	-0.0021	-0.0018	-0.0039	2.5
-20	0.003	0.0012	-0.0007	-0.0015	-0.0011	-0.0016	0.0006	2.5
-10	0.004	0.0012	-0.0021	-0.0022	-0.0017	-0.0036	-0.0006	2.5
0	0.003	-0.0013	0.0019	0.0007	-0.0009	-0.0015	0.0021	2.5
10	0.004	0.0011	-0.0018	-0.0013	0.0016	-0.0011	0.0027	2.5
20	0.003	-0.0006	-0.0035	-0.0006	-0.0027	0.0019	-0.0007	2.5
30	0.003	0.0013	-0.0033	0.0038	-0.0014	-0.0015	-0.0031	2.5
40	0.003	-0.0016	-0.0016	0.0013	-0.0016	-0.0009	-0.0021	2.5
50	0.004	0.0039	0.0015	-0.0014	-0.0024	-0.0015	-0.0028	2.5

4.3 OCCUPIED BANDWIDTH MEASUREMENT

4.3.1 TEST PROCEDURES

The EUT makes a call to the communication simulator. All measurements were done at low, middle and high operational frequency range. The communication simulator station system controlled a EUT to export maximum output power under transmission mode and specific channel frequency. Use OBW measurement function of Spectrum analyzer to measure 99 % occupied bandwidth.

4.3.2 TEST SETUP

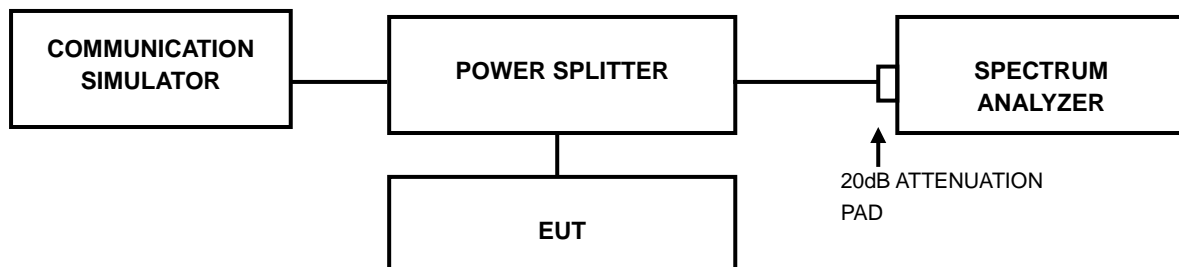



A D T

4.3.3 TEST RESULTS

CHANNEL	FREQUENCY	99% OCCUPIED BANDWIDTH (MHz)
		CDMA
25	1851.25	1.2713
600	1880.00	1.2656
1175	1908.75	1.2654

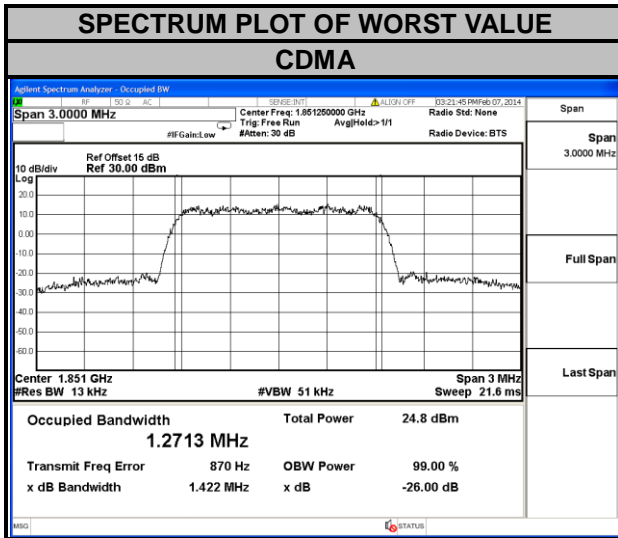



LTE BAND 25							
CHANNEL BANDWIDTH: 1.4MHz				CHANNEL BANDWIDTH: 3MHz			
CHANNEL	FREQUENCY	99% OCCUPIED BANDWIDTH (MHz)		CHANNEL	FREQUENCY	99% OCCUPIED BANDWIDTH (MHz)	
		QPSK	16QAM			QPSK	16QAM
26047	1850.7	1.0797	1.0763	26055	1851.5	2.6824	2.6798
26365	1882.5	1.0780	1.0761	26365	1882.5	2.6803	2.6813
26683	1914.3	1.0795	1.0764	26675	1913.5	2.6797	2.6800

SPECTRUM PLOT OF WORST VALUE

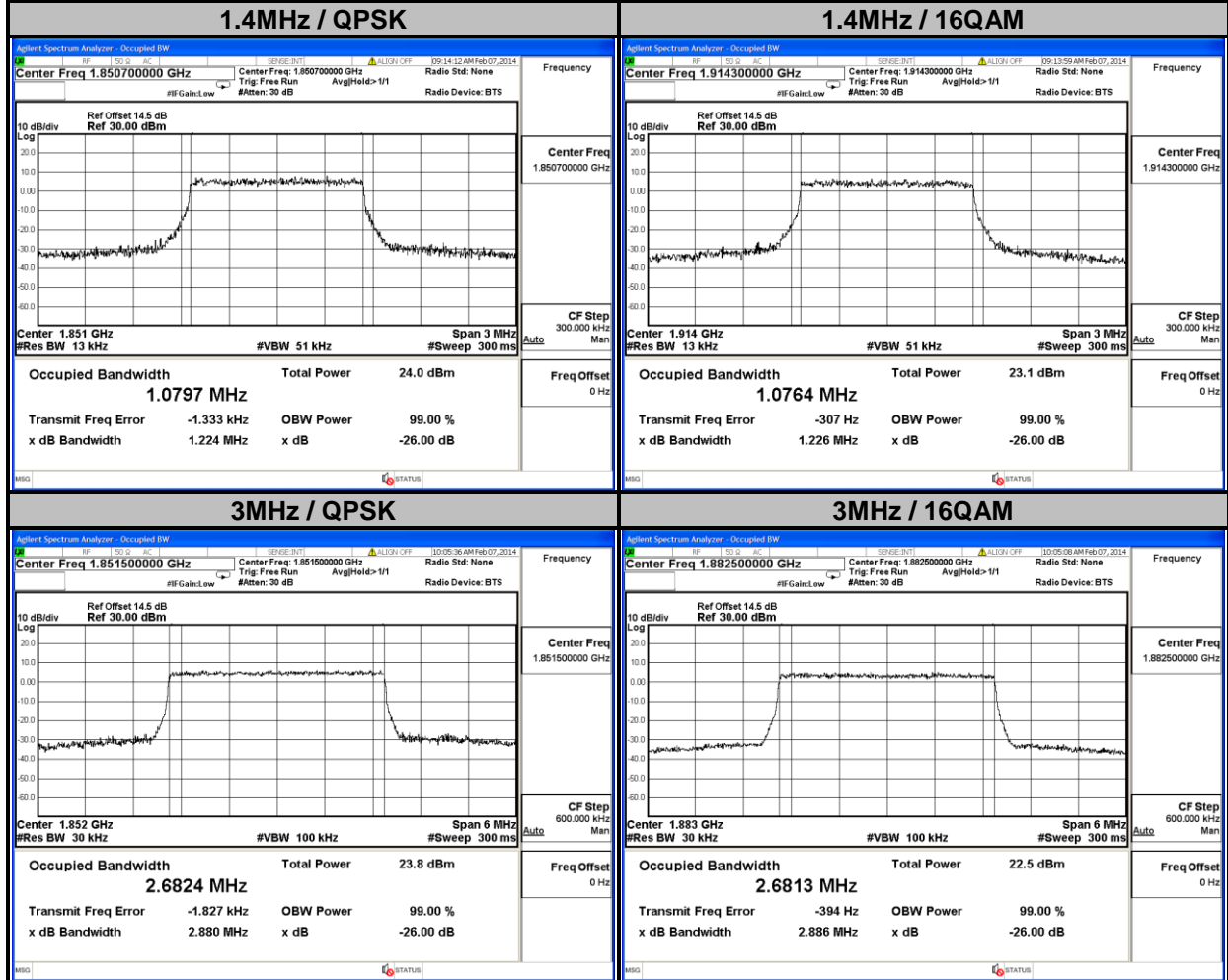



LTE BAND 25							
CHANNEL BANDWIDTH: 5MHz				CHANNEL BANDWIDTH: 10MHz			
CHANNEL	FREQUENCY	99% OCCUPIED BANDWIDTH (MHz)		CHANNEL	FREQUENCY	99% OCCUPIED BANDWIDTH (MHz)	
		QPSK	16QAM			QPSK	16QAM
26065	1852.5	4.4882	4.4863	26090	1855.0	8.9112	8.9087
26365	1882.5	4.4904	4.4864	26365	1882.5	8.9170	8.9141
26665	1912.5	4.4885	4.4846	26640	1910.0	8.9122	8.9130

SPECTRUM PLOT OF WORST VALUE

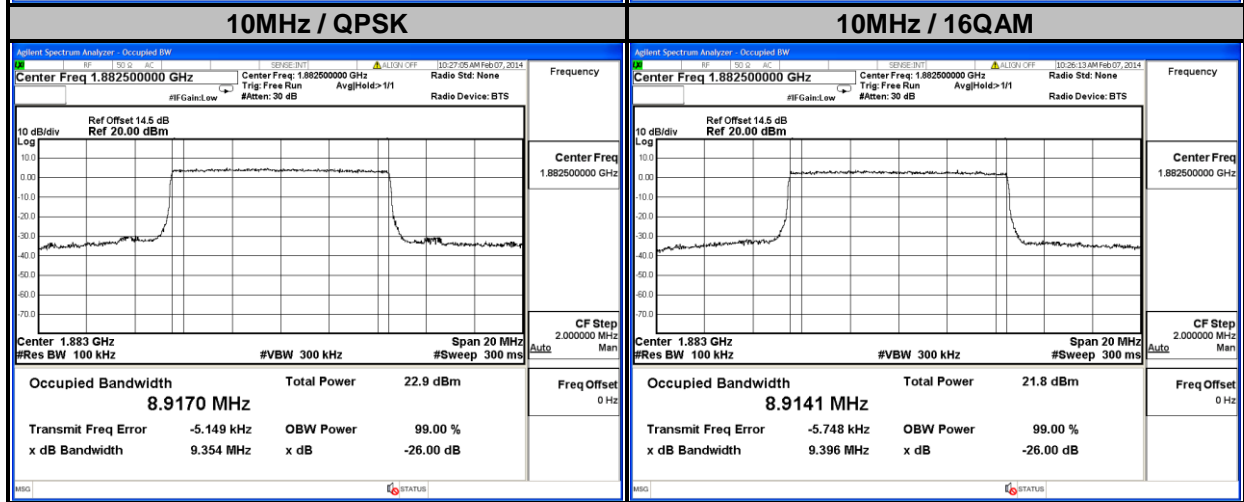
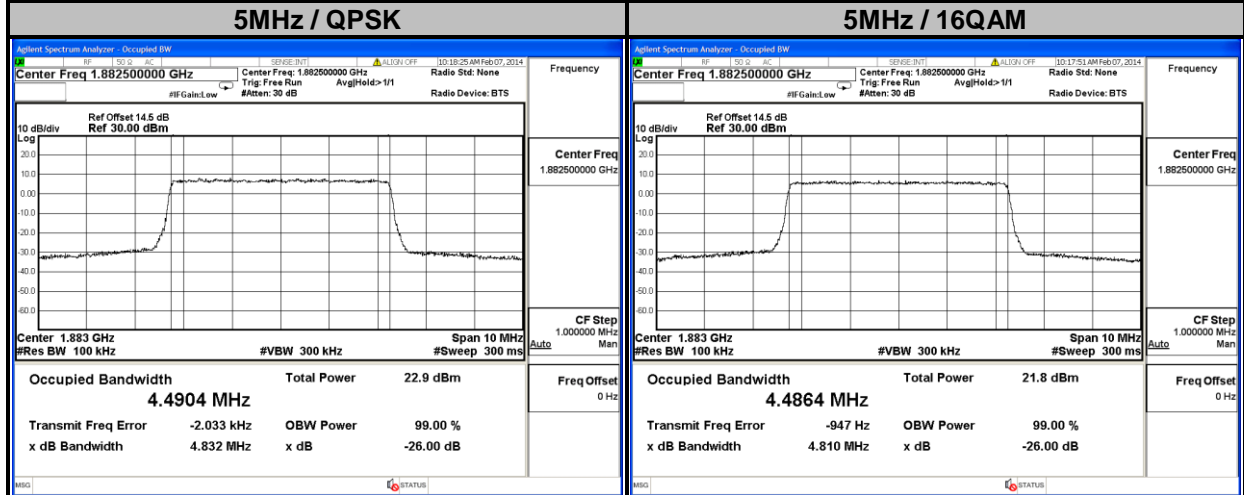



A D T

LTE BAND 25							
CHANNEL BANDWIDTH: 15MHz				CHANNEL BANDWIDTH: 20MHz			
CHANNEL	FREQUENCY	99% OCCUPIED BANDWIDTH (MHz)		CHANNEL	FREQUENCY	99% OCCUPIED BANDWIDTH (MHz)	
		QPSK	16QAM			QPSK	16QAM
26115	1857.5	13.367	13.362	26140	1860	17.806	17.807
26365	1882.5	13.362	13.369	26365	1882.5	17.814	17.822
26615	1907.5	13.369	13.369	26590	1905	17.791	17.803

SPECTRUM PLOT OF WORST VALUE

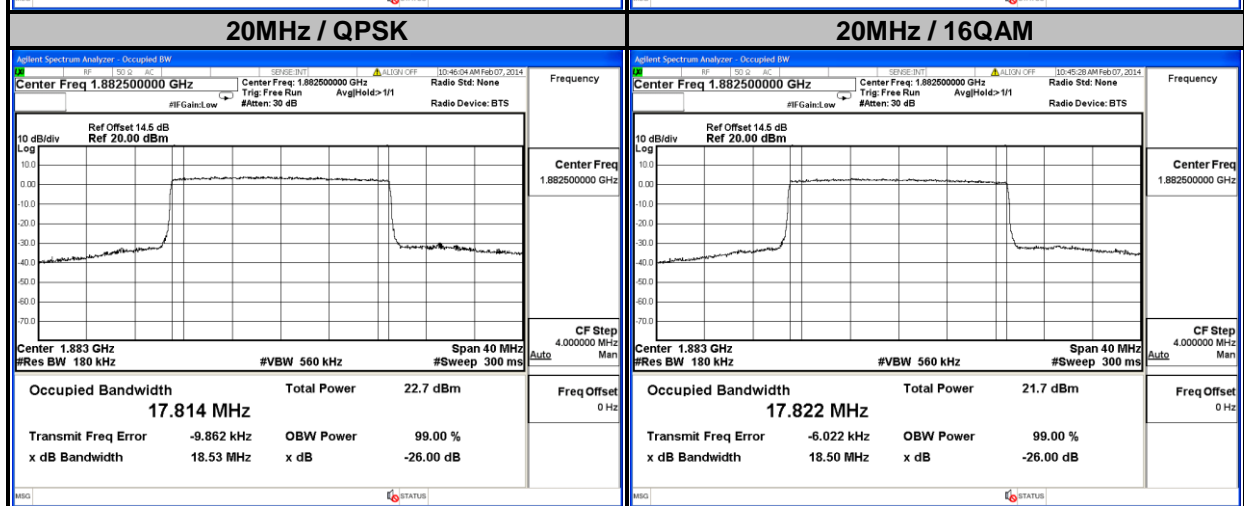
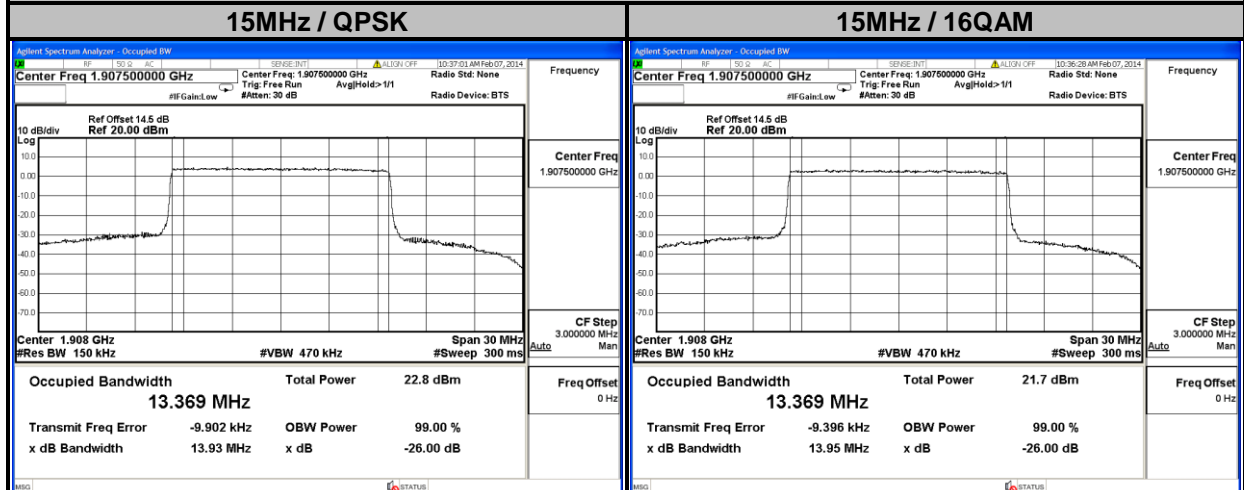

4.4 PEAK TO AVERAGE RATIO

4.4.1 LIMITS OF PEAK TO AVERAGE RATIO MEASUREMENT

In measuring transmissions in this band using an average power technique, the peak to-average ratio (PAR) of the transmission may not exceed 13 dB.

4.4.2 TEST SETUP

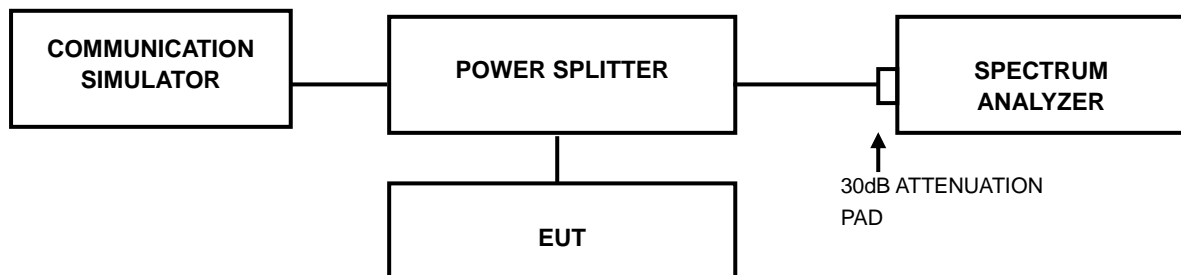

4.4.3 TEST PROCEDURES

1. Set resolution/measurement bandwidth \geq signal's occupied bandwidth;
2. Set the number of counts to a value that stabilizes the measured CCDF curve;
3. Record the maximum PAPR level associated with a probability of 0.1%.



A D T

4.4.4 TEST RESULTS

CHANNEL	FREQUENCY (MHz)	PEAK TO AVERAGE RATIO (dB)
		CDMA
25	1851.25	2.88
600	1880.00	3.15
1175	1908.75	3.34

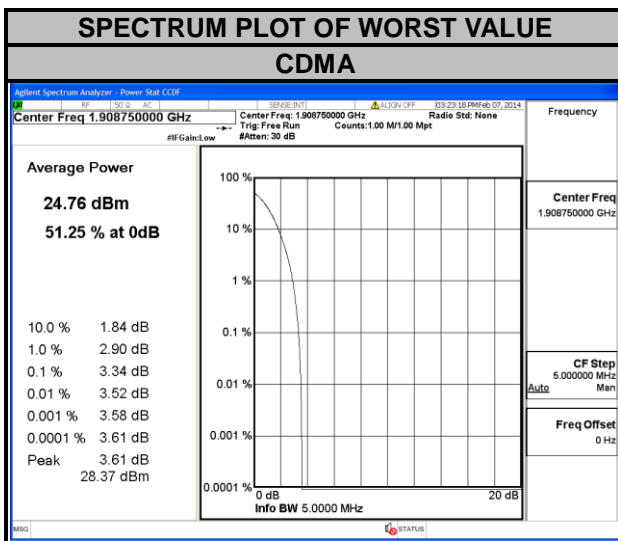



A D T

LTE BAND 25							
CHANNEL BANDWIDTH: 1.4MHz				CHANNEL BANDWIDTH: 3MHz			
CHANNEL	FREQUENCY (MHz)	PEAK TO AVERAGE RATIO (dB)		CHANNEL	FREQUENCY (MHz)	PEAK TO AVERAGE RATIO (dB)	
		QPSK	16QAM			QPSK	16QAM
26047	1850.7	4.79	5.79	26055	1851.5	4.85	5.78
26365	1882.5	5.10	6.04	26365	1882.5	5.16	6.01
26683	1914.3	4.54	5.55	26675	1913.5	4.68	5.61

SPECTRUM PLOT OF WORST VALUE

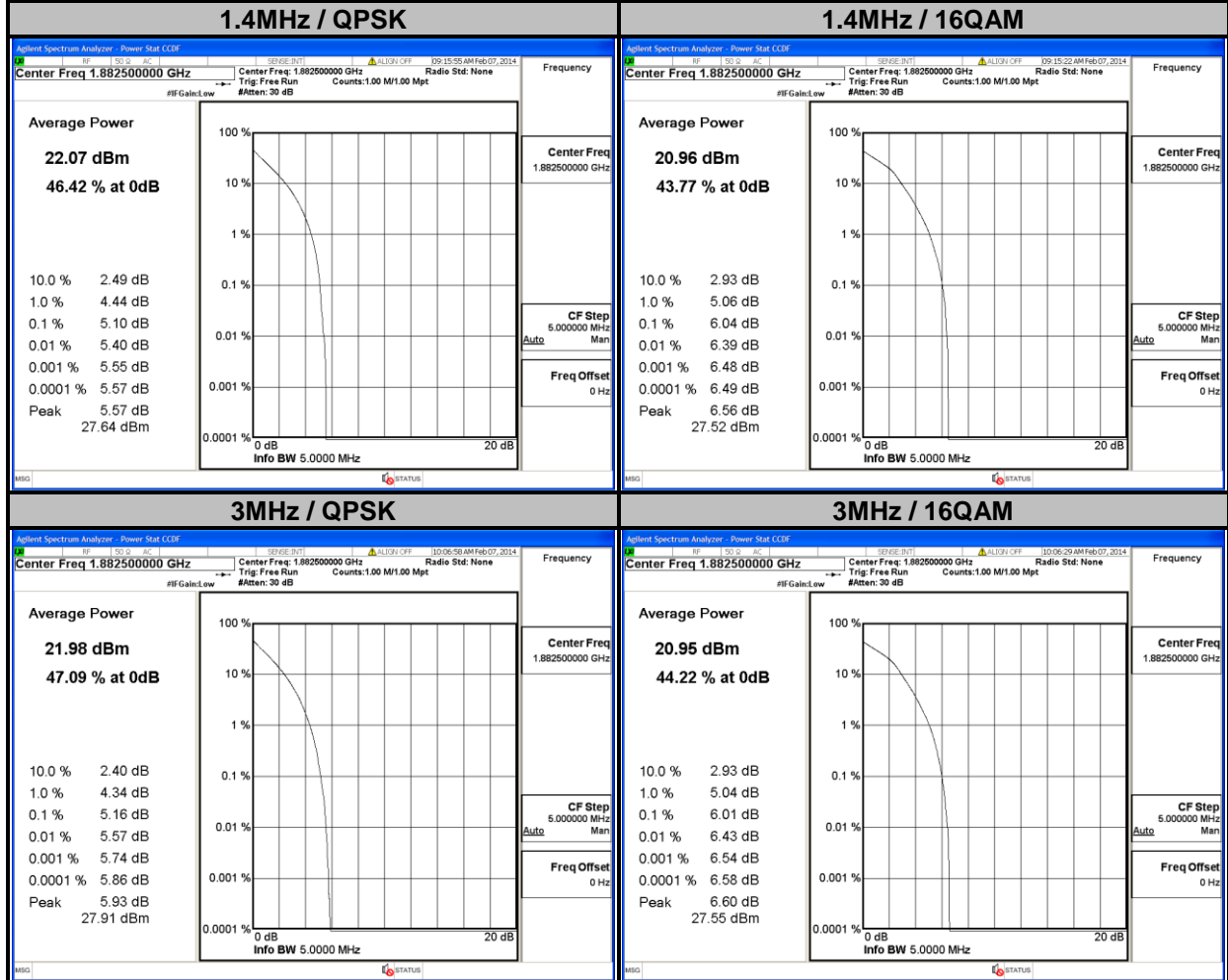



A D T

LTE BAND 25							
CHANNEL BANDWIDTH: 5MHz				CHANNEL BANDWIDTH: 10MHz			
CHANNEL	FREQUENCY (MHz)	PEAK TO AVERAGE RATIO (dB)		CHANNEL	FREQUENCY (MHz)	PEAK TO AVERAGE RATIO (dB)	
		QPSK	16QAM			QPSK	16QAM
26065	1852.5	3.85	5.04	26090	1855.0	3.89	5.13
26365	1882.5	4.28	5.47	26365	1882.5	4.24	5.43
26665	1912.5	4.14	5.38	26640	1910.0	4.36	5.58

SPECTRUM PLOT OF WORST VALUE

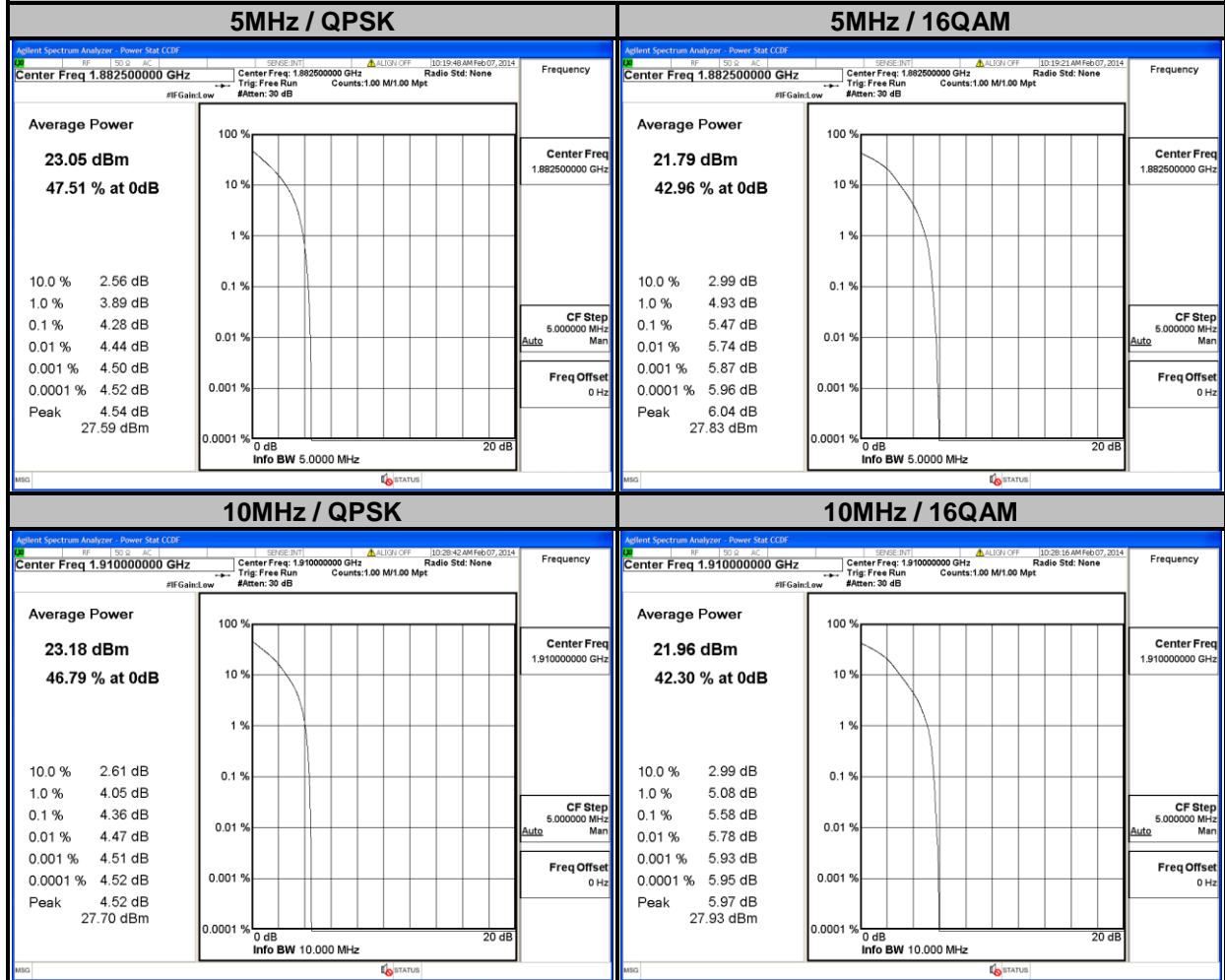



A D T

LTE BAND 25							
CHANNEL BANDWIDTH: 15MHz				CHANNEL BANDWIDTH: 20MHz			
CHANNEL	FREQUENCY (MHz)	PEAK TO AVERAGE RATIO (dB)		CHANNEL	FREQUENCY (MHz)	PEAK TO AVERAGE RATIO (dB)	
		QPSK	16QAM			QPSK	16QAM
26115	1857.5	3.87	5.04	26140	1860.0	3.93	5.05
26365	1882.5	4.23	5.33	26365	1882.5	4.31	5.43
26615	1907.5	4.07	5.23	26590	1905.0	4.44	5.55

SPECTRUM PLOT OF WORST VALUE

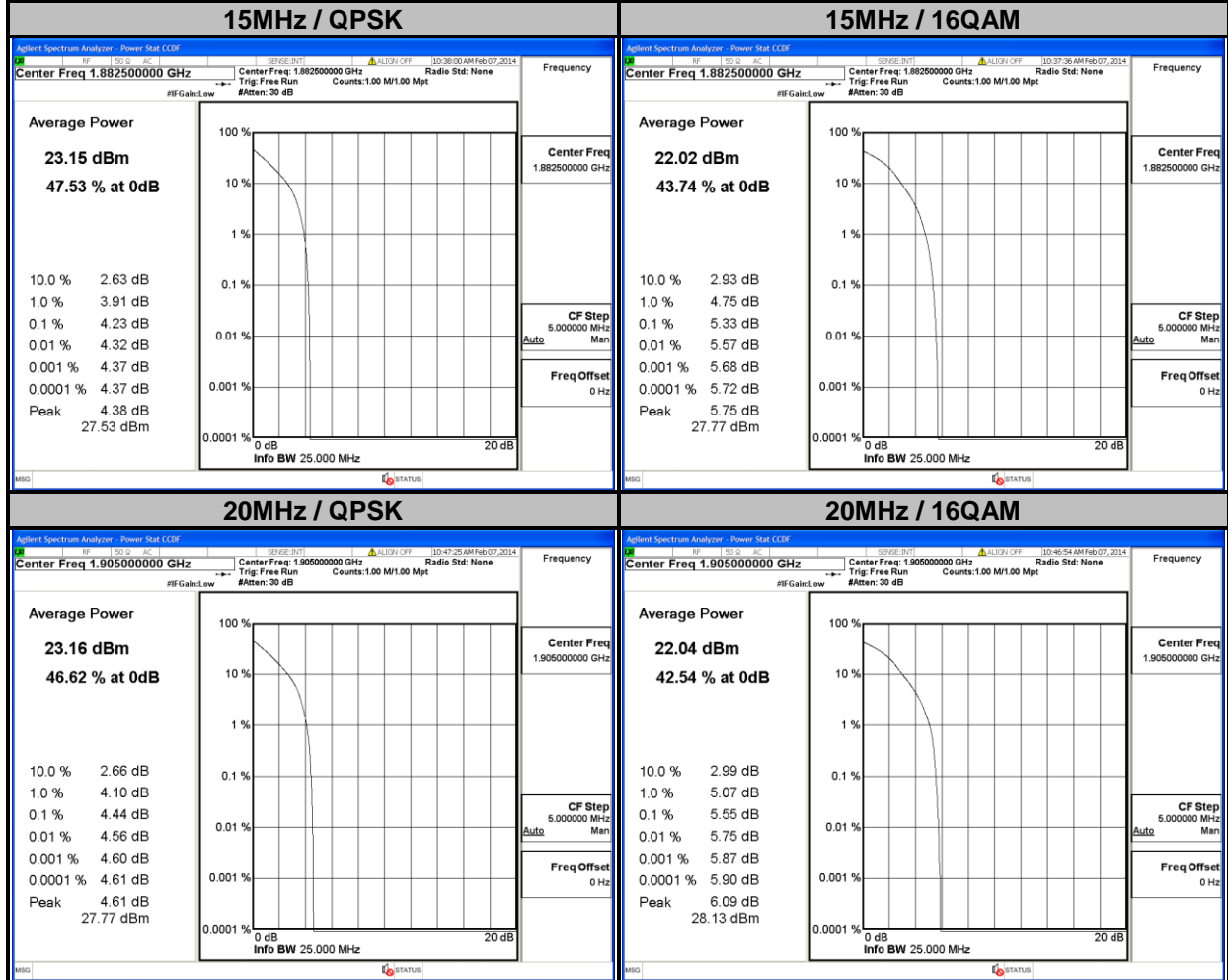

4.5 BAND EDGE MEASUREMENT

4.5.1 LIMITS OF BAND EDGE MEASUREMENT

Power of any emission outside of the authorized operating frequency ranges must be attenuated below the transmitting power (P) by a factor of at least $43 + 10 \log(P)$ dB. In the 1 MHz bands immediately outside and adjacent to the frequency block a resolution bandwidth of at least one percent of the emission bandwidth of the fundamental emission of the transmitter may be employed.

4.5.2 TEST SETUP

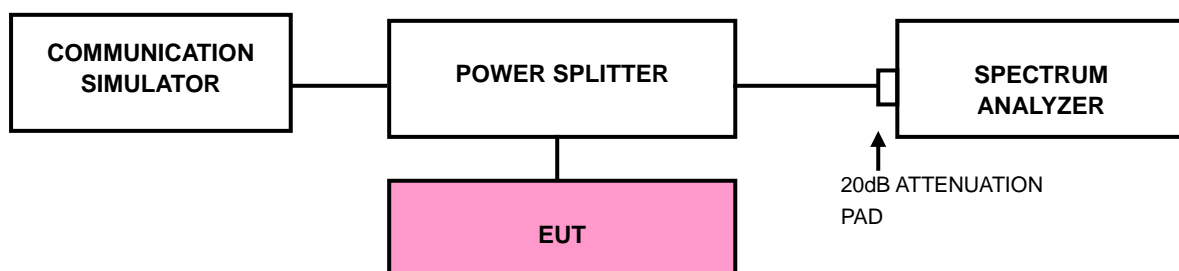

4.5.3 TEST PROCEDURES

- All measurements were done at low and high operational frequency range.
- The center frequency of spectrum is the band edge frequency and span is 1MHz. RB of the spectrum is 13kHz and VB of the spectrum is 51kHz (CDMA / LTE Channel Bandwidth 1.4MHz).
- The center frequency of spectrum is the band edge frequency and span is 1MHz. RB of the spectrum is 30kHz and VB of the spectrum is 100kHz (LTE Channel Bandwidth 3MHz).
- The center frequency of spectrum is the band edge frequency and span is 1MHz. RB of the spectrum is 100kHz and VB of the spectrum is 300kHz (LTE Channel Bandwidth 5MHz / 10MHz).
- The center frequency of spectrum is the band edge frequency and span is 1MHz. RB of the spectrum is 150kHz and VB of the spectrum is 470kHz (LTE Channel Bandwidth 15MHz).
- The center frequency of spectrum is the band edge frequency and span is 1MHz. RB of the spectrum is 180kHz and VB of the spectrum is 560kHz (LTE Channel Bandwidth 20MHz).
- Record the max trace plot into the test report.



A D T

4.5.4 TEST RESULTS

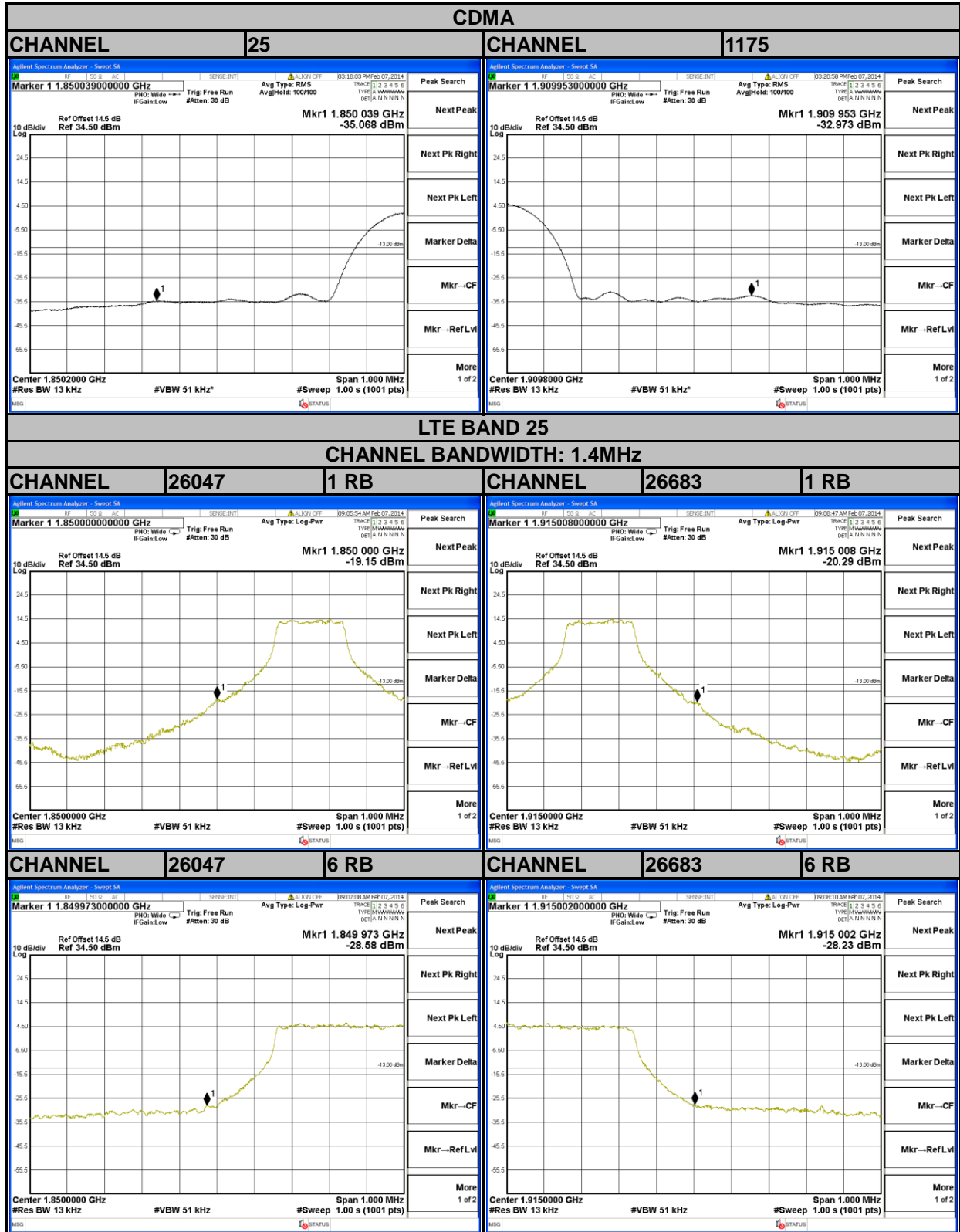



A D T

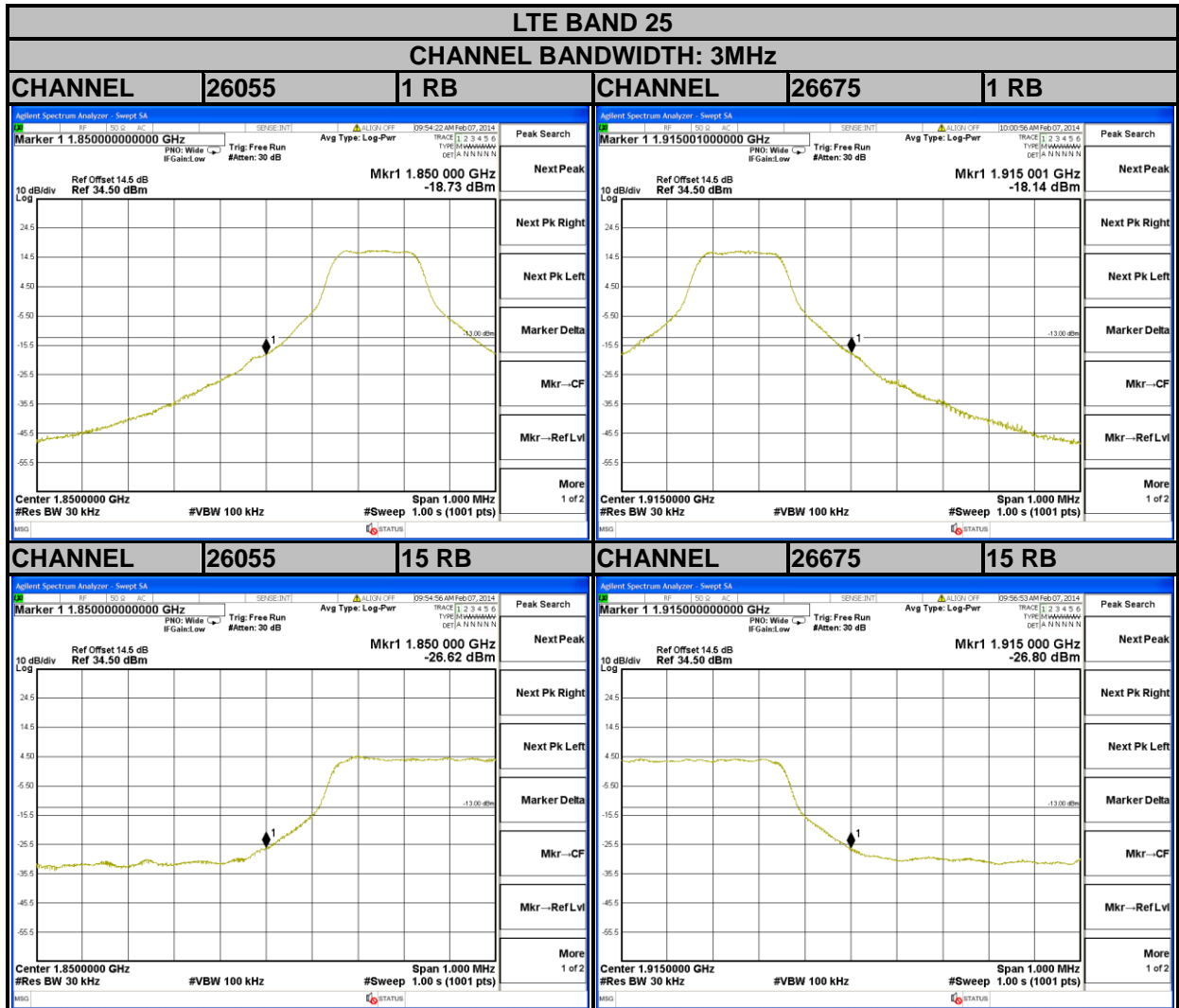



A D T

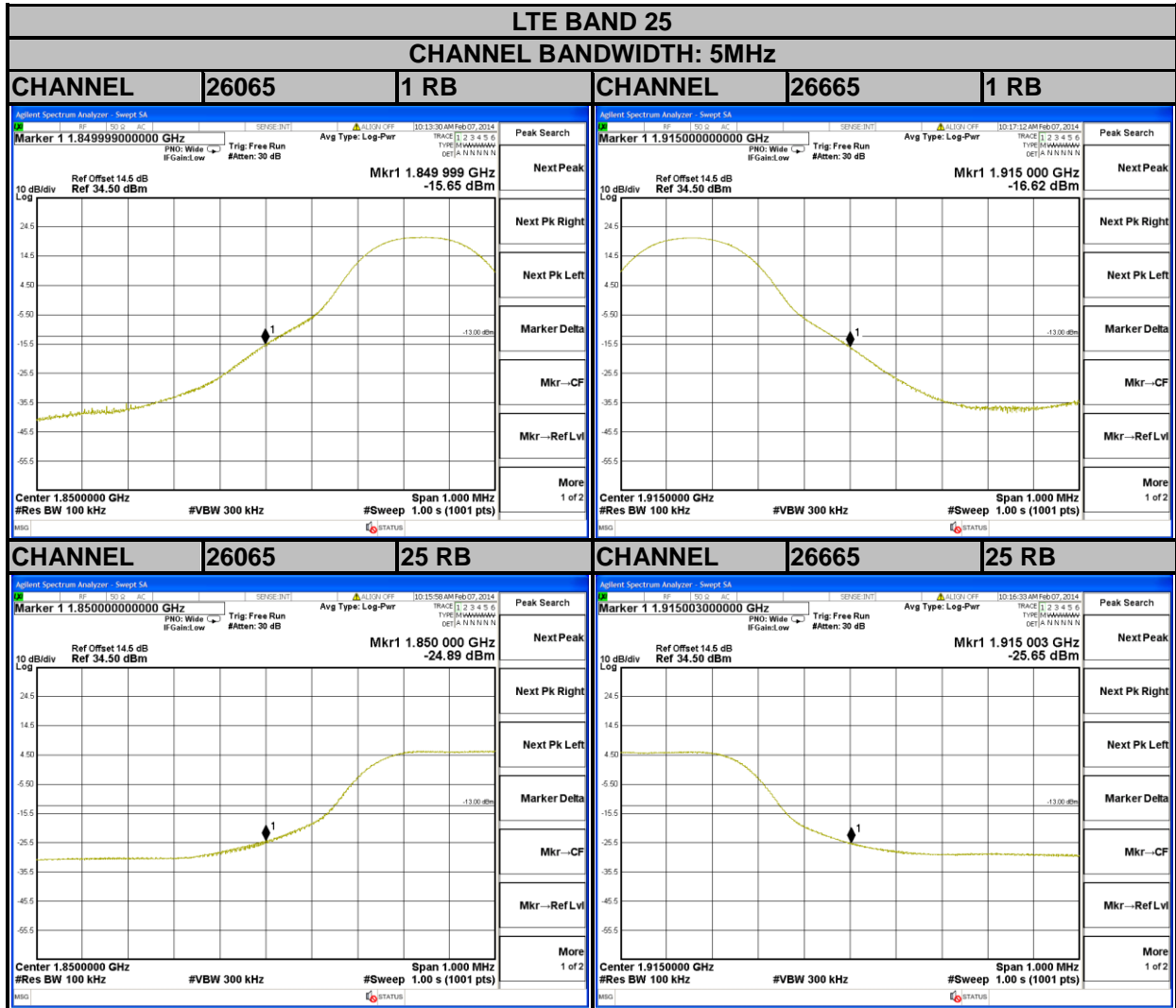



A D T

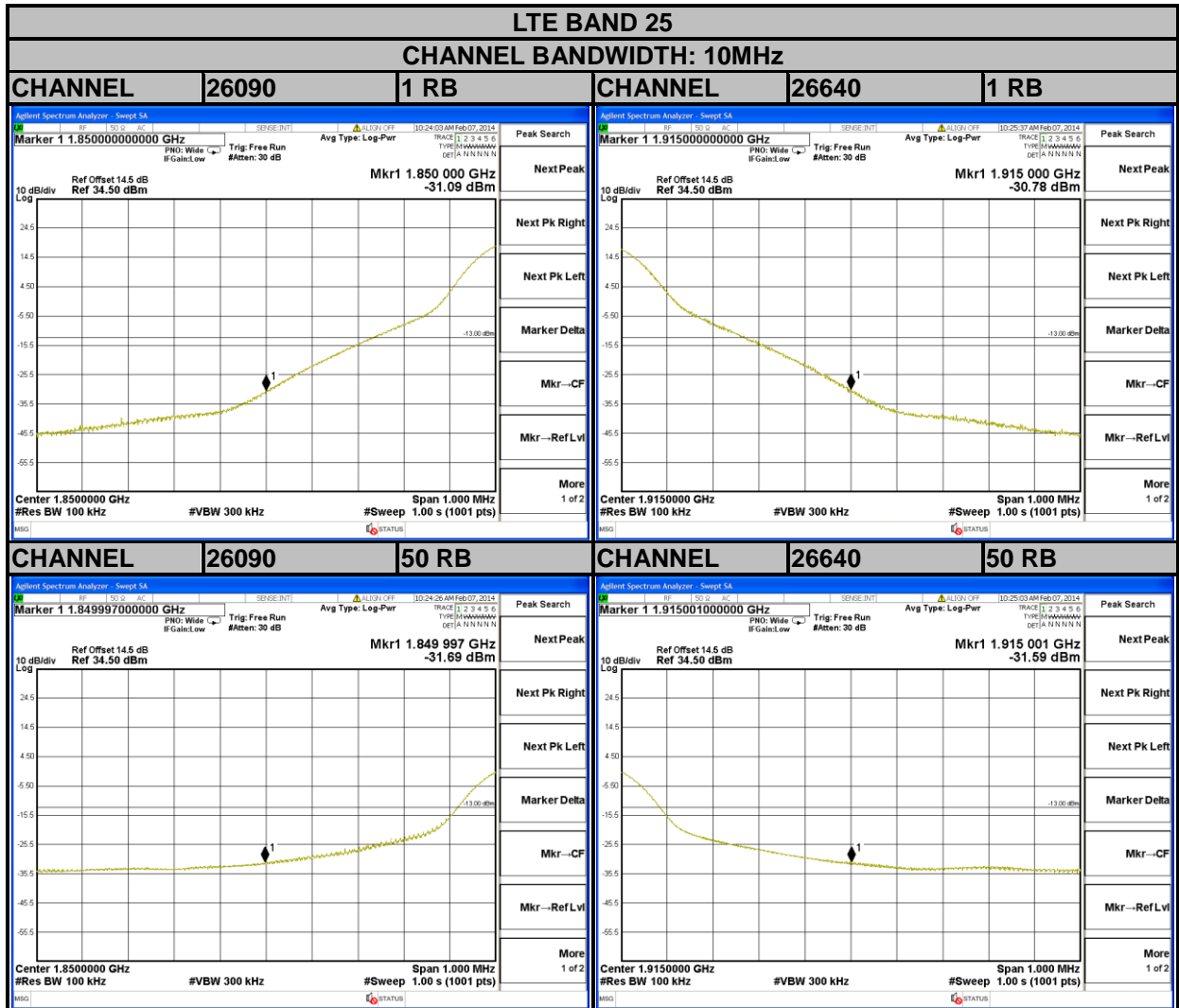



A D T

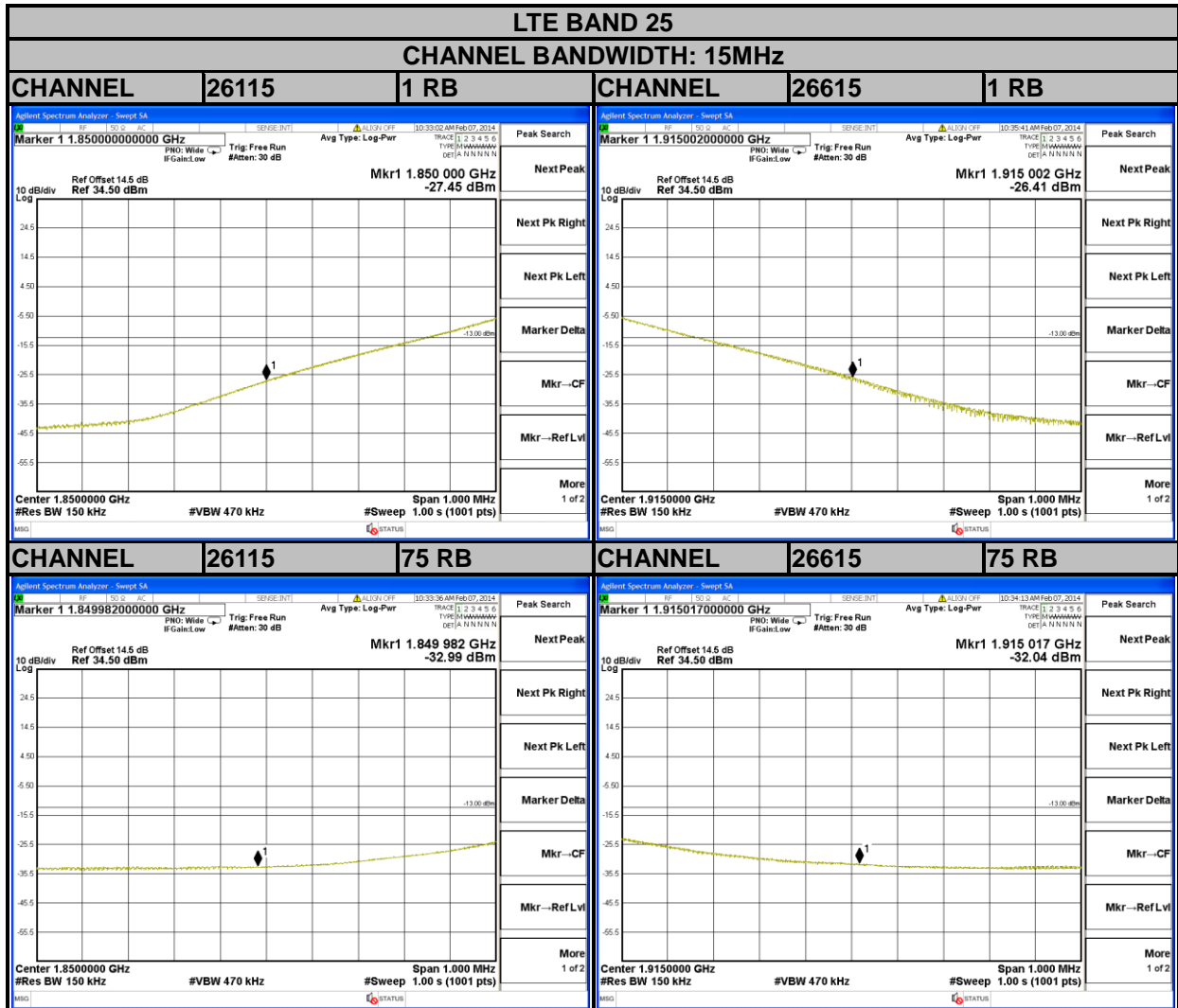



A D T

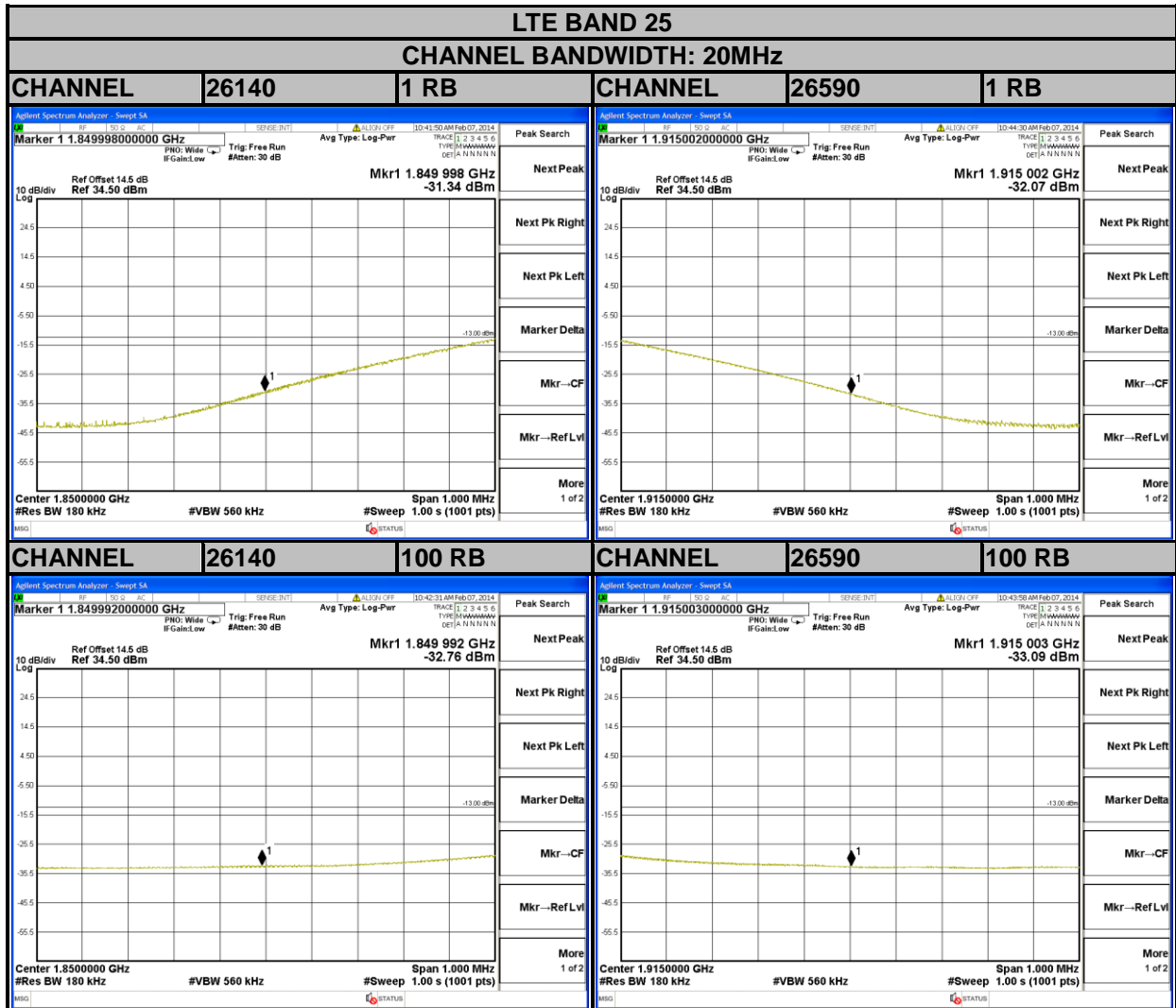

4.6 CONDUCTED SPURIOUS EMISSIONS

4.6.1 LIMITS OF CONDUCTED SPURIOUS EMISSIONS MEASUREMENT

The power of any emission outside of the authorized operating frequency ranges must be attenuated below the transmitting power (P) by a factor of at least $43 + 10 \log(P)$ dB. The emission limit is equal to -13dBm.

4.6.2 TEST PROCEDURE

- The EUT makes a phone call to the communication simulator. All measurements were done at low, middle and high operational frequency range.
- Measuring frequency range is from 30 MHz to 19.1GHz. 10dB attenuation pad is connected with spectrum. RBW=1MHz and VBW=3MHz is used for conducted emission measurement.

4.6.3 TEST SETUP

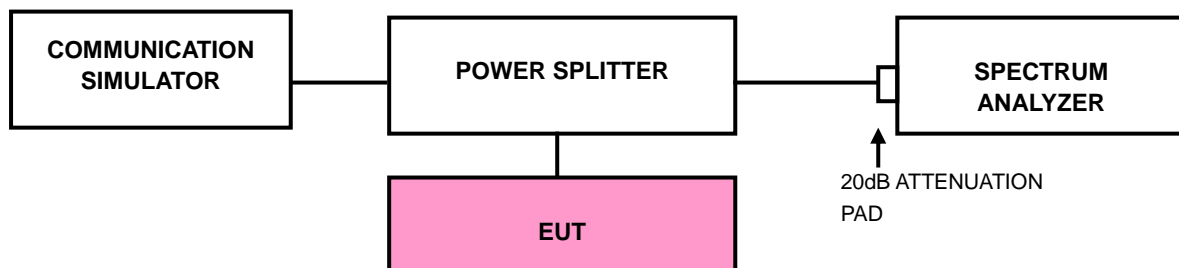



A D T

4.6.4 TEST RESULTS

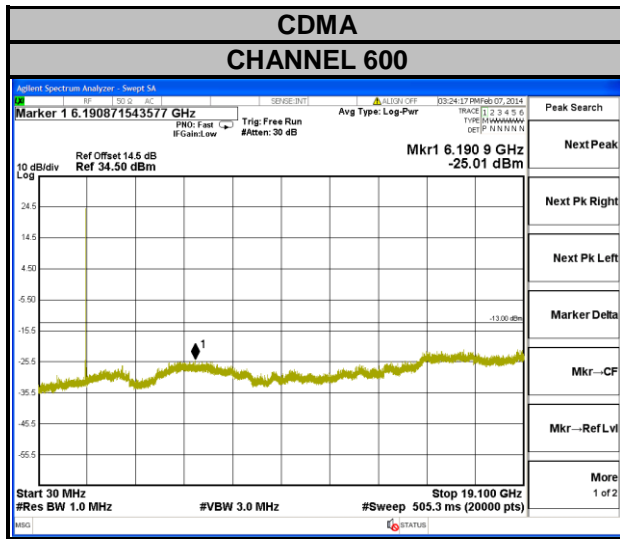



A D T

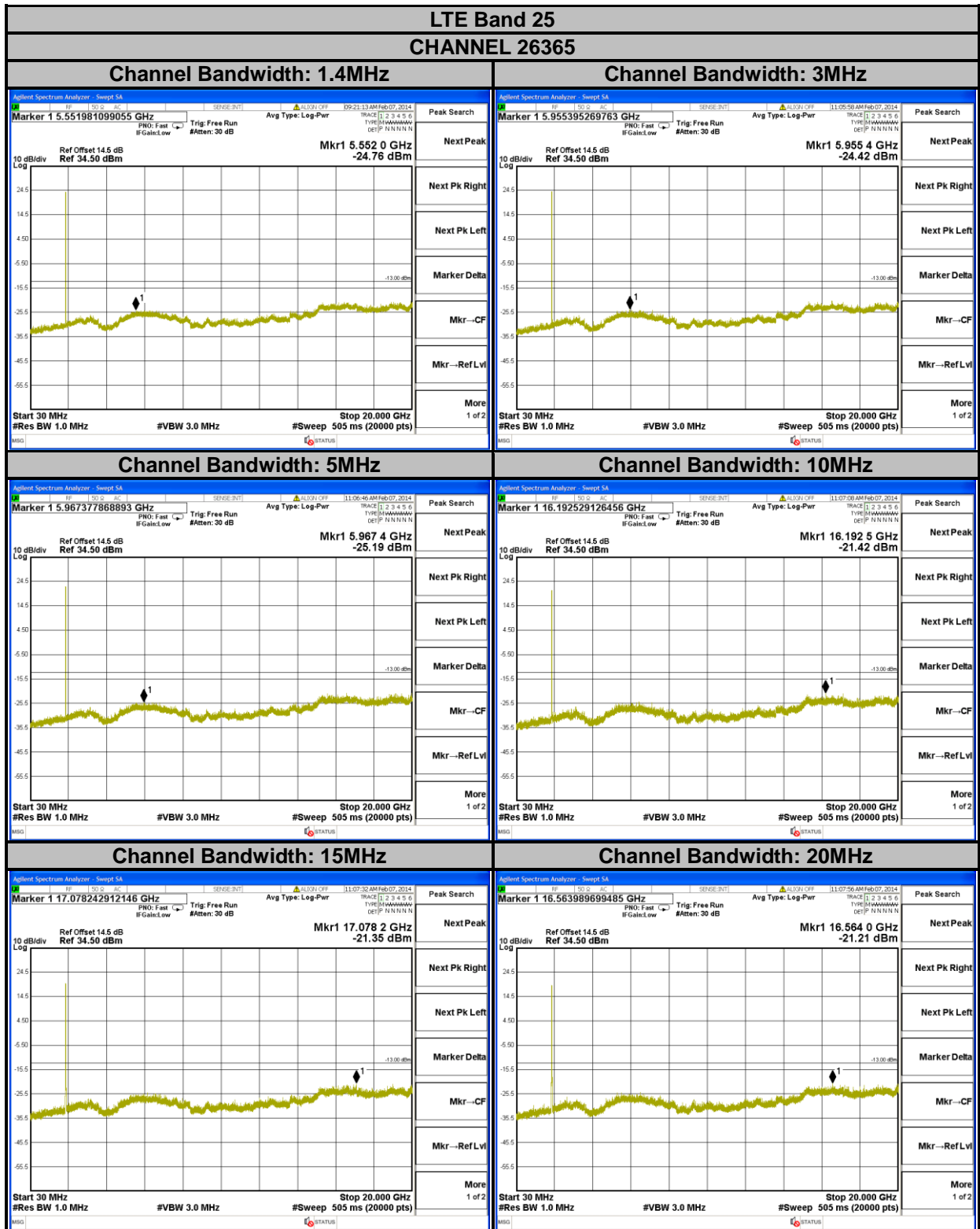

4.7 RADIATED EMISSION MEASUREMENT

4.7.1 LIMITS OF RADIATED EMISSION MEASUREMENT

The power of any emission outside of the authorized operating frequency ranges must be attenuated below the transmitting power (P) by a factor of at least $43 + 10 \log(P)$ dB. The emission limit is equal to -13dBm.

4.7.2 TEST PROCEDURES

- a. Substitution method is used for E.I.R.P measurement. In the semi-anechoic chamber, EUT placed on the 0.8m height of Turn Table, rotated the table around 360 degrees to search the maximum radiation power and receiver antenna shall be rotated vertical and horizontal polarization and moved height from 1m to 4m to find the maximum polar radiated power. The "Read Value" is the spectrum reading the maximum power value.
- b. The substitution horn antenna is substituted for EUT at the same position and signals generator export the CW signal to the substitution antenna via a TX cable. Rotated the Turn Table and moved receiving antenna to find the maximum radiation power. Adjust output power level of S.G to get a Value of spectrum reading equal to "Read Value" of step a. Record the power level of S.G
- c. $EIRP = \text{Output power level of S.G} - \text{TX cable loss} + \text{Antenna gain of substitution horn}$.
- d. E.R.P power can be calculated form E.I.R.P power by subtracting the gain of dipole, $E.R.P \text{ power} = E.I.R.P \text{ power} - 2.15\text{dBi}$.

NOTE: The resolution bandwidth and video bandwidth of test receiver/spectrum analyzer is 1MHz/3MHz.

4.7.3 DEVIATION FROM TEST STANDARD

No deviation

4.7.4 TEST SETUP

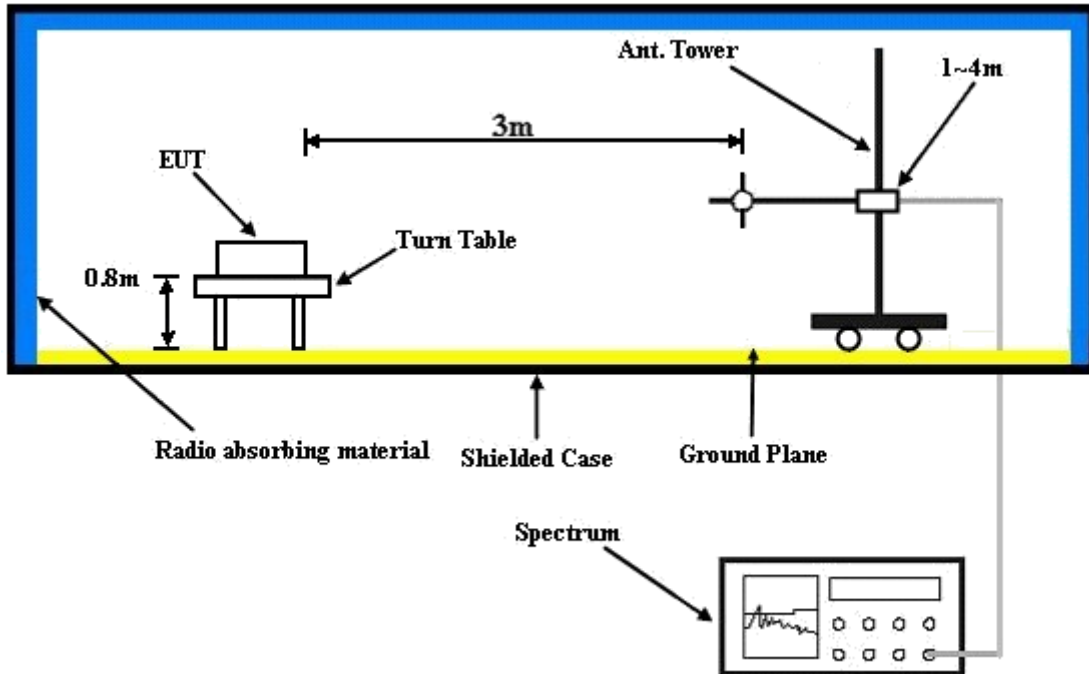

For the actual test configuration, please refer to the attached file (Test Setup Photo).



A D T

4.7.5 TEST RESULTS

MODE A

CDMA:



Bureau Veritas Consumer Products Services Ltd., Taoyuan Branch

A D T

Data: 15

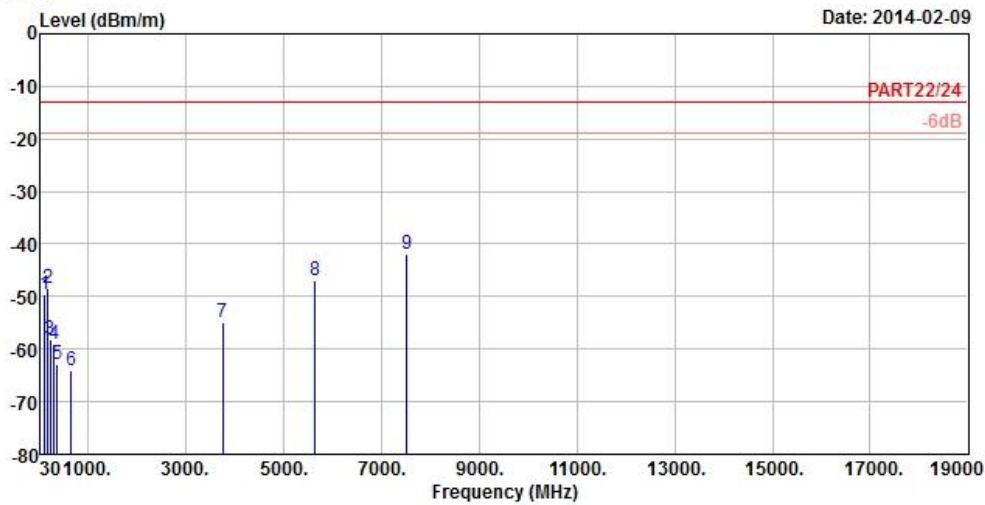

Site : 966 Chamber 5
 Condition : PART22/24 3m HORIZONTAL
 Brand/Model: 0P9C300
 Remark : 1xRTT1900 Link
 Tested by : Johnson Liao
 Temperature : 25°C
 Humidity : 65%
 Plane : Y

	Freq	Level	Read Level	Limit Line	Over Limit	Factor	Remark
	MHz	dBm/m	dBm	dBm/m	dB	dB/m	
1	111.54	-49.73	-39.08	-13.00	-36.73	-10.65	Peak
2	173.10	-48.31	-41.54	-13.00	-35.31	-6.77	Peak
3	222.78	-58.08	-51.18	-13.00	-45.08	-6.90	Peak
4	305.60	-59.12	-52.78	-13.00	-46.12	-6.34	Peak
5	371.40	-63.02	-57.17	-13.00	-50.02	-5.85	Peak
6	654.90	-64.19	-64.82	-13.00	-51.19	0.63	Peak
7	3760.00	-55.01	-46.71	-13.00	-42.01	-8.30	Peak
8	5640.00	-46.99	-45.09	-13.00	-33.99	-1.90	Peak
9 pp	7520.00	-41.99	-45.94	-13.00	-28.99	3.95	Peak



A D T



Bureau Veritas Consumer Products Services Ltd., Taoyuan Branch

A D T

Data: 16

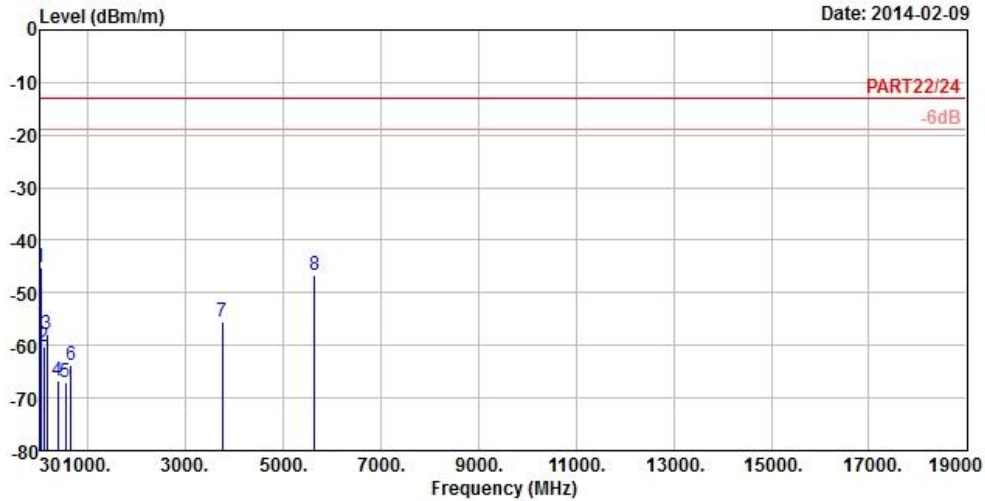

Site : 966 Chamber 5
 Condition : PART22/24 3m VERTICAL
 Brand/Model: 0P9C300
 Remark : 1xRTT1900 Link
 Tested by : Johnson Liao
 Temperature : 25°C
 Humidity : 65%
 Plane : Y

	Freq	Level	Read Level	Limit Line	Over Limit	Factor	Remark
	MHz	dBm/m	dBm	dBm/m	dB	dB/m	
1	pp	33.24	-45.26	-44.15	-13.00	-32.26	-1.11 Peak
2		102.63	-60.22	-49.76	-13.00	-47.22	-10.46 Peak
3		168.78	-57.78	-51.10	-13.00	-44.78	-6.68 Peak
4		384.00	-66.59	-60.84	-13.00	-53.59	-5.75 Peak
5		547.80	-66.92	-65.13	-13.00	-53.92	-1.79 Peak
6		662.60	-63.87	-64.64	-13.00	-50.87	0.77 Peak
7		3760.00	-55.53	-47.23	-13.00	-42.53	-8.30 Peak
8		5640.00	-46.72	-44.82	-13.00	-33.72	-1.90 Peak



A D T

LTE BAND 25
CHANNEL BANDWIDTH: 1.4MHz / QPSK



Bureau Veritas Consumer Products Services Ltd., Taoyuan Branch

A D T

Data: 15

Date: 2014-02-07

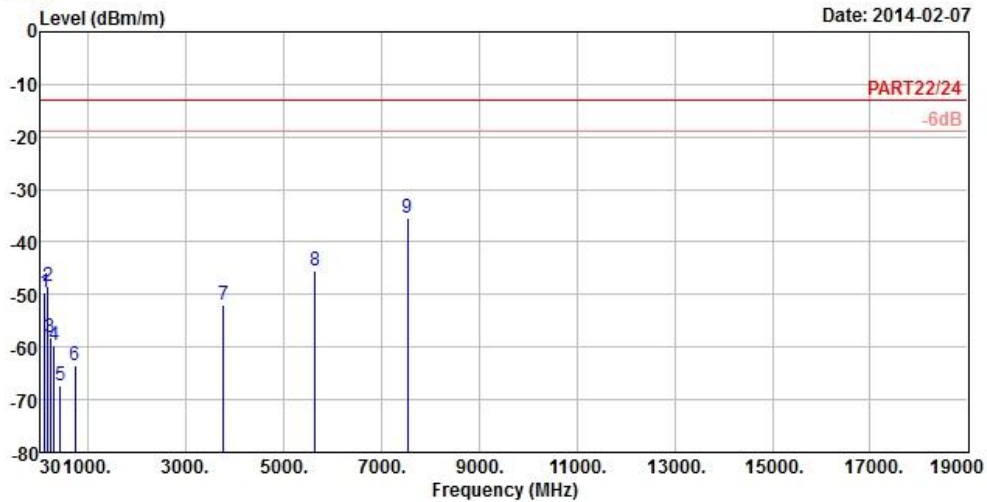

Site : 966 Chamber 5
 Condition : PART22/24 3m HORIZONTAL
 Brand/Model: 0P9C300
 Remark : LTE Band 25_1.4M_QPSK(1,2) Link
 Tested by : Johnson Liao
 Temperature : 25°C
 Humidity : 65%
 Plane : Y

	Read	Limit	Over			
Freq	Level	Level	Line	Limit	Factor	Remark
MHz	dBm/m	dBm	dBm/m	dB	dB/m	
1	112.08	-49.57	-38.90	-13.00	-36.57	-10.67 Peak
2	172.02	-48.48	-41.75	-13.00	-35.48	-6.73 Peak
3	225.48	-58.09	-51.32	-13.00	-45.09	-6.77 Peak
4	304.90	-59.55	-53.21	-13.00	-46.55	-6.34 Peak
5	428.10	-67.36	-62.43	-13.00	-54.36	-4.93 Peak
6	736.80	-63.39	-65.09	-13.00	-50.39	1.70 Peak
7	3765.00	-52.06	-43.82	-13.00	-39.06	-8.24 Peak
8	5647.50	-45.60	-43.70	-13.00	-32.60	-1.90 Peak
9 pp	7530.00	-35.56	-39.49	-13.00	-22.56	3.93 Peak



A D T



Bureau Veritas Consumer Products Services Ltd., Taoyuan Branch

A D T

Data: 16

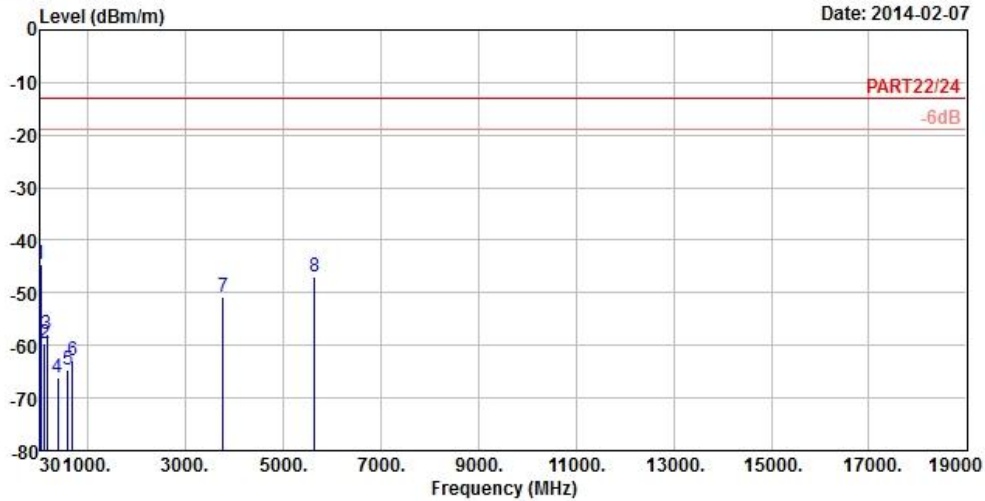

Site : 966 Chamber 5
 Condition : PART22/24 3m VERTICAL
 Brand/Model: 0P9C300
 Remark : LTE Band 25_1.4M_QPSK(1,2) Link
 Tested by : Johnson Liao
 Temperature : 25°C
 Humidity : 65%
 Plane : Y

	Freq	Level	Read Level	Limit Line	Over Limit	Factor	Remark
	MHz	dBm/m	dBm	dBm/m	dB	dB/m	
1	pp	32.97	-44.53	-43.42	-13.00	-31.53	-1.11 Peak
2		111.54	-59.75	-49.10	-13.00	-46.75	-10.65 Peak
3		167.70	-57.88	-51.22	-13.00	-44.88	-6.66 Peak
4		381.90	-66.07	-60.30	-13.00	-53.07	-5.77 Peak
5		584.90	-64.58	-63.80	-13.00	-51.58	-0.78 Peak
6		680.80	-63.01	-64.11	-13.00	-50.01	1.10 Peak
7		3765.00	-50.76	-42.52	-13.00	-37.76	-8.24 Peak
8		5647.50	-46.86	-44.96	-13.00	-33.86	-1.90 Peak



A D T

CHANNEL BANDWIDTH: 3MHz / QPSK



Bureau Veritas Consumer Products Services Ltd., Taoyuan Branch

A D T

Data: 11

Date: 2014-02-07

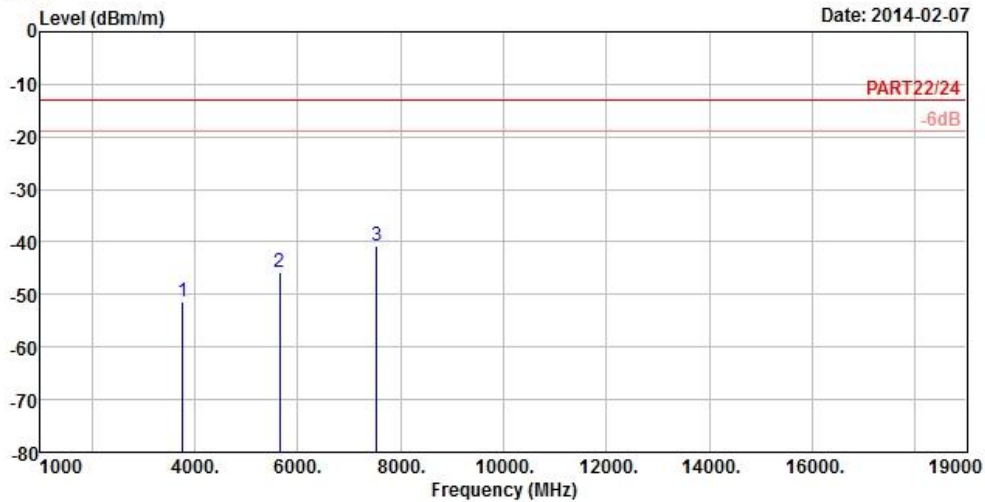

Site : 966 Chamber 5
 Condition : PART22/24 3m HORIZONTAL
 Brand/Model: 0P9C300
 Remark : LTE Band 25_3M_QPSK(1,7) Link
 Tested by : Johnson Liao
 Temperature : 25°C
 Humidity : 65%
 Plane : Y

	Freq	Level	Read Level	Limit Line	Over Limit	Factor	Remark
	MHz	dBm/m	dBm	dBm/m	dB	dB/m	
1	3765.00	-51.39	-43.15	-13.00	-38.39	-8.24	Peak
2	5647.50	-45.77	-43.87	-13.00	-32.77	-1.90	Peak
3 pp	7530.00	-40.68	-44.61	-13.00	-27.68	3.93	Peak



A D T



Bureau Veritas Consumer Products Services Ltd., Taoyuan Branch

A D T

Data: 12

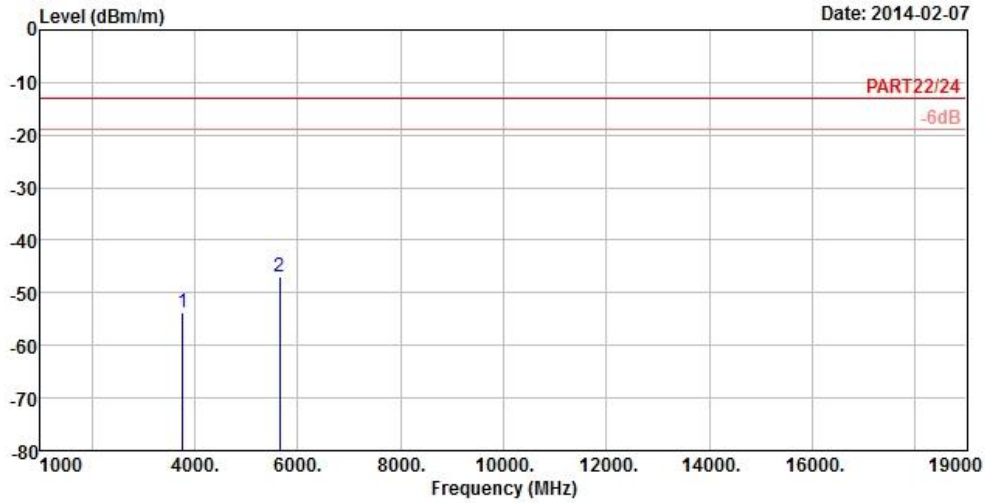

Site : 966 Chamber 5
 Condition : PART22/24 3m VERTICAL
 Brand/Model: 0P9C300
 Remark : LTE Band 25_3M_QPSK(1,7) Link
 Tested by : Johnson Liao
 Temperature : 25°C
 Humidity : 65%
 Plane : Y

	Freq	Level	Read Level	Limit Line	Over Limit	Factor	Remark
	MHz	dBm/m	dBm	dBm/m	dB	dB/m	
1	3765.00	-53.69	-45.45	-13.00	-40.69	-8.24	Peak
2 pp	5647.50	-47.01	-45.11	-13.00	-34.01	-1.90	Peak



A D T

CHANNEL BANDWIDTH: 5MHz / QPSK



Bureau Veritas Consumer Products Services Ltd., Taoyuan Branch

A D T

Data: 11

Date: 2014-02-07

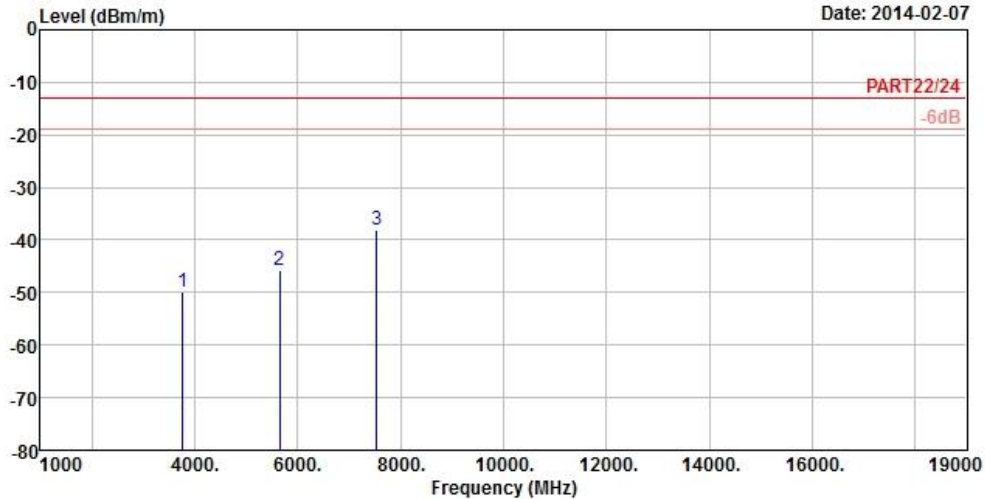

Site : 966 Chamber 5
 Condition : PART22/24 3m HORIZONTAL
 Brand/Model: 0P9C300
 Remark : LTE Band 25_5M_QPSK(1,12) Link
 Tested by : Johnson Liao
 Temperature : 25°C
 Humidity : 65%
 Plane : Y

	Read	Limit	Over			
Freq	Level	Level	Line	Limit	Factor	Remark
MHz	dBm/m	dBm	dBm/m	dB	dB/m	
1	3765.00	-49.96	-41.72	-13.00	-36.96	-8.24 Peak
2	5647.50	-45.61	-43.71	-13.00	-32.61	-1.90 Peak
3 pp	7530.00	-38.18	-42.11	-13.00	-25.18	3.93 Peak



A D T



Bureau Veritas Consumer Products Services Ltd., Taoyuan Branch

A D T

Data: 12

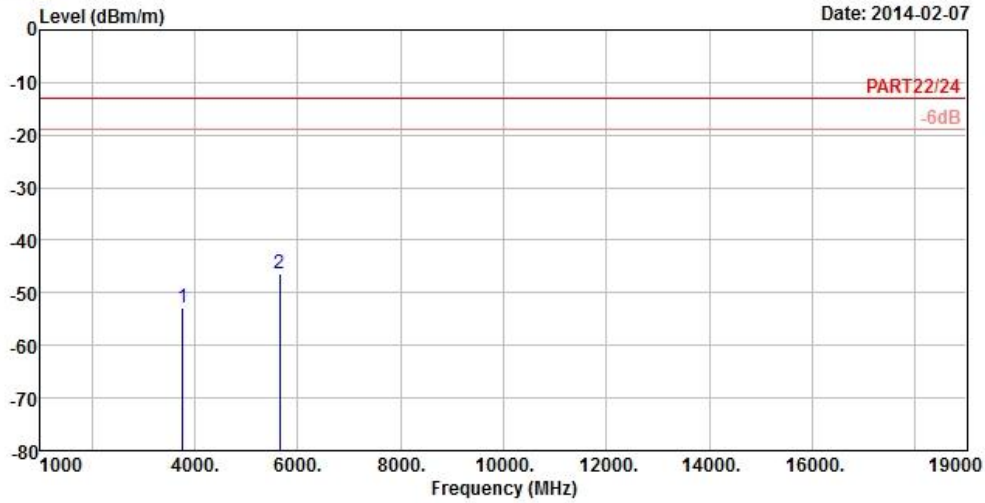

Site : 966 Chamber 5
 Condition : PART22/24 3m VERTICAL
 Brand/Model: 0P9C300
 Remark : LTE Band 25_5M_QPSK(1,12) Link
 Tested by : Johnson Liao
 Temperature : 25°C
 Humidity : 65%
 Plane : Y

	Freq	Level	Read Level	Limit Line	Over Limit	Factor	Remark
	MHz	dBm/m	dBm	dBm/m	dB	dB/m	
1	3765.00	-52.97	-44.73	-13.00	-39.97	-8.24	Peak
2 pp	5647.50	-46.20	-44.30	-13.00	-33.20	-1.90	Peak



A D T

CHANNEL BANDWIDTH: 10MHz / QPSK



Bureau Veritas Consumer Products Services Ltd., Taoyuan Branch

A D T

Data: 11

Date: 2014-02-07

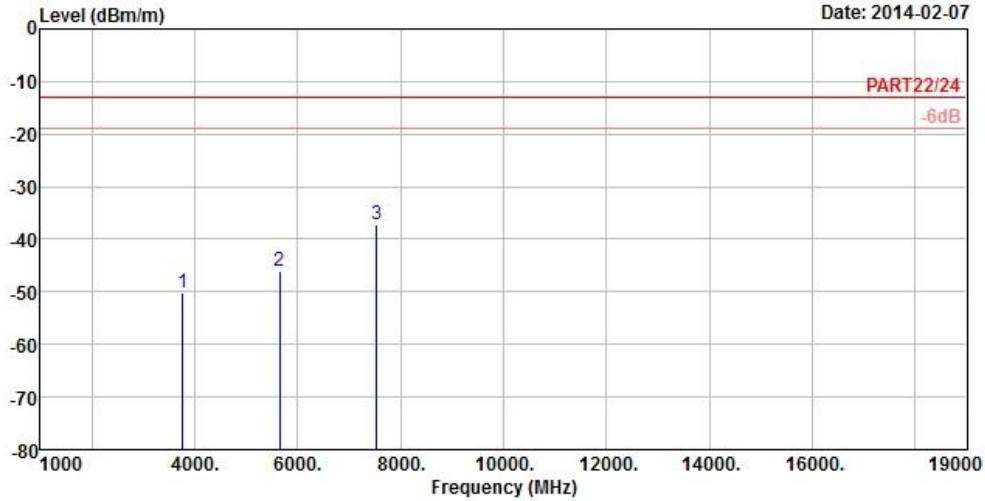

Site : 966 Chamber 5
 Condition : PART22/24 3m HORIZONTAL
 Brand/Model: 0P9C300
 Remark : LTE Band 25_10M_QPSK(1,24) Link
 Tested by : Johnson Liao
 Temperature : 25°C
 Humidity : 65%
 Plane : Y

	Freq	Level	Read Level	Limit Line	Over Limit	Factor	Remark
	MHz	dBm/m	dBm	dBm/m	dB	dB/m	
1	3765.00	-50.33	-42.09	-13.00	-37.33	-8.24	Peak
2	5647.50	-46.16	-44.26	-13.00	-33.16	-1.90	Peak
3 pp	7530.00	-37.28	-41.21	-13.00	-24.28	3.93	Peak



A D T



Bureau Veritas Consumer Products Services Ltd., Taoyuan Branch

A D T

Data: 12

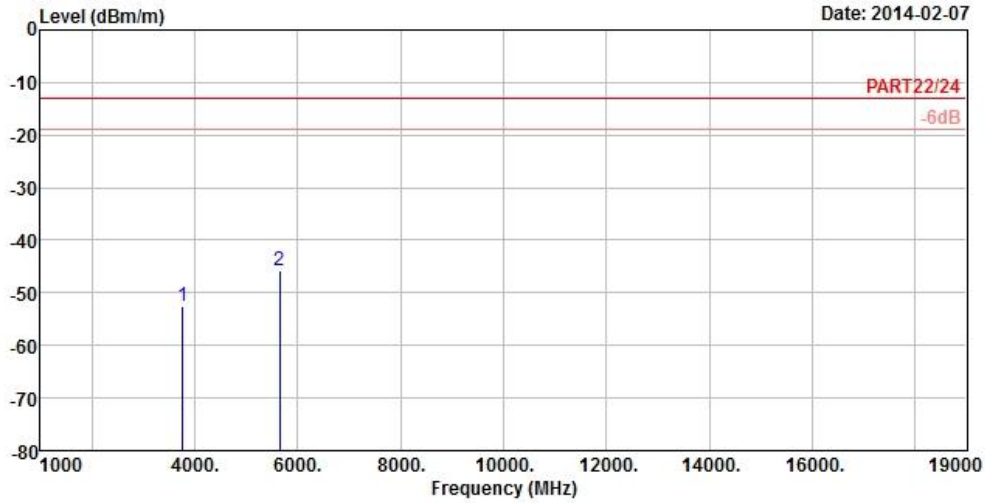

Site : 966 Chamber 5
 Condition : PART22/24 3m VERTICAL
 Brand/Model: 0P9C300
 Remark : LTE Band 25_10M_QPSK(1,24) Link
 Tested by : Johnson Liao
 Temperature : 25°C
 Humidity : 65%
 Plane : Y

	Freq	Level	Read Level	Limit Line	Over Limit	Factor	Remark
	MHz	dBm/m	dBm	dBm/m	dB	dB/m	
1	3765.00	-52.50	-44.26	-13.00	-39.50	-8.24	Peak
2 pp	5647.50	-45.73	-43.83	-13.00	-32.73	-1.90	Peak



A D T

CHANNEL BANDWIDTH: 15MHz / QPSK



Bureau Veritas Consumer Products Services Ltd., Taoyuan Branch

A D T

Data: 11

Date: 2014-02-07

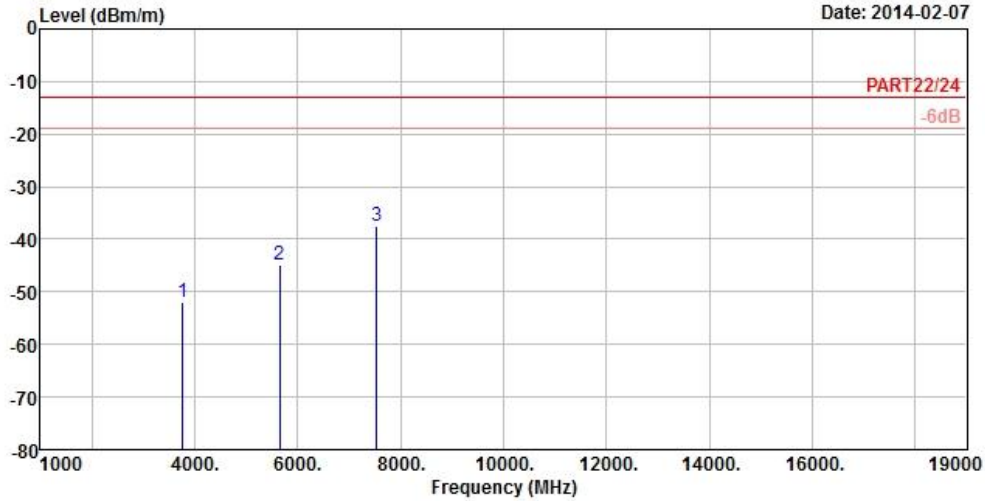

Site : 966 Chamber 5
 Condition : PART22/24 3m HORIZONTAL
 Brand/Model: 0P9C300
 Remark : LTE Band 25_15M_QPSK(1,37) Link
 Tested by : Johnson Liao
 Temperature : 25°C
 Humidity : 65%
 Plane : Y

	Freq	Level	Read Level	Limit Line	Over Limit	Factor	Remark
	MHz	dBm/m	dBm	dBm/m	dB	dB/m	
1	3765.00	-52.02	-43.78	-13.00	-39.02	-8.24	Peak
2	5647.50	-44.79	-42.89	-13.00	-31.79	-1.90	Peak
3 pp	7530.00	-37.59	-41.52	-13.00	-24.59	3.93	Peak



A D T



Bureau Veritas Consumer Products Services Ltd., Taoyuan Branch

A D T

Data: 12

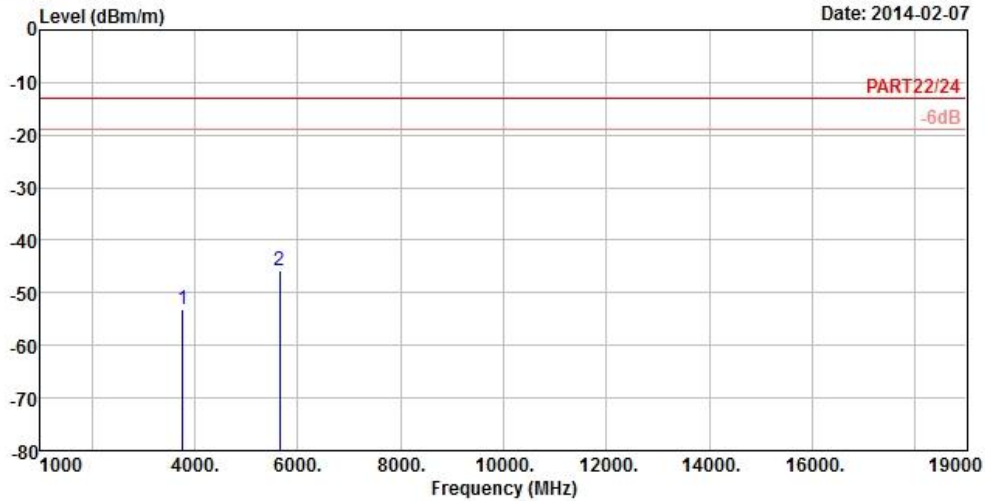

Site : 966 Chamber 5
 Condition : PART22/24 3m VERTICAL
 Brand/Model: 0P9C300
 Remark : LTE Band 25_15M_QPSK(1,37) Link
 Tested by : Johnson Liao
 Temperature : 25°C
 Humidity : 65%
 Plane : Y

	Freq	Level	Read Level	Limit Line	Over Limit	Factor	Remark
	MHz	dBm/m	dBm	dBm/m	dB	dB/m	
1	3765.00	-53.09	-44.85	-13.00	-40.09	-8.24	Peak
2 pp	5647.50	-45.74	-43.84	-13.00	-32.74	-1.90	Peak



A D T

CHANNEL BANDWIDTH: 15MHz / QPSK



Bureau Veritas Consumer Products Services Ltd., Taoyuan Branch

A D T

Data: 11

Date: 2014-02-07

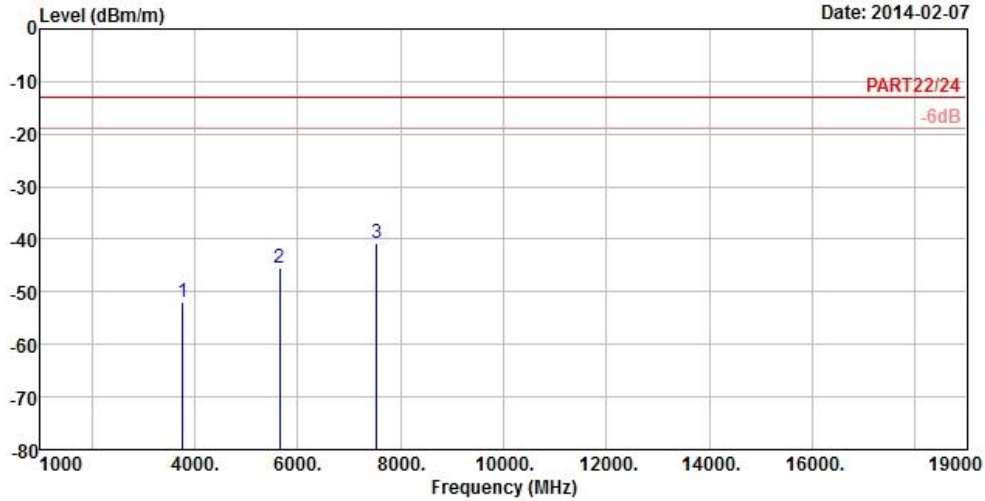

Site : 966 Chamber 5
 Condition : PART22/24 3m HORIZONTAL
 Brand/Model: 0P9C300
 Remark : LTE Band 25_20M_QPSK(1,50) Link
 Tested by : Johnson Liao
 Temperature : 25°C
 Humidity : 65%
 Plane : Y

	Freq	Level	Read Level	Limit Line	Over Limit	Factor	Remark
	MHz	dBm/m	dBm	dBm/m	dB	dB/m	
1	3765.00	-52.08	-43.84	-13.00	-39.08	-8.24	Peak
2	5647.50	-45.58	-43.68	-13.00	-32.58	-1.90	Peak
3 pp	7530.00	-40.73	-44.66	-13.00	-27.73	3.93	Peak



A D T



Bureau Veritas Consumer Products Services Ltd., Taoyuan Branch

A D T

Data: 12

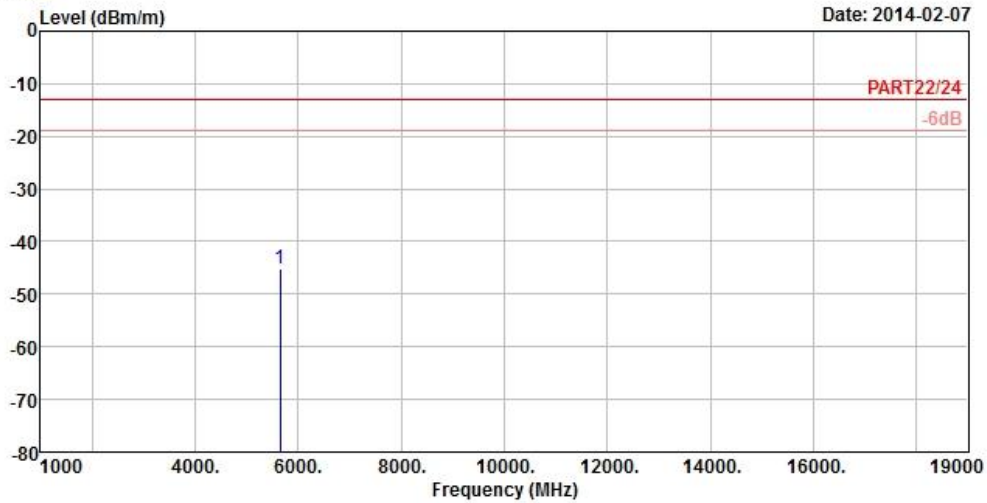

Site : 966 Chamber 5
 Condition : PART22/24 3m VERTICAL
 Brand/Model: 0P9C300
 Remark : LTE Band 25_20M_QPSK(1,50) Link
 Tested by : Johnson Liao
 Temperature : 25°C
 Humidity : 65%
 Plane : Y

	Read	Limit	Over			
Freq	Level	Level	Line	Limit	Factor	Remark
MHz	dBm/m	dBm	dBm/m	dB	dB/m	
1 pp 5647.50	-45.09	-43.19	-13.00	-32.09	-1.90	Peak



A D T

MODE B
LTE BAND 25
CHANNEL BANDWIDTH: 1.4MHz / QPSK



Bureau Veritas Consumer Products Services Ltd., Taoyuan Branch

A D T

Data: 15

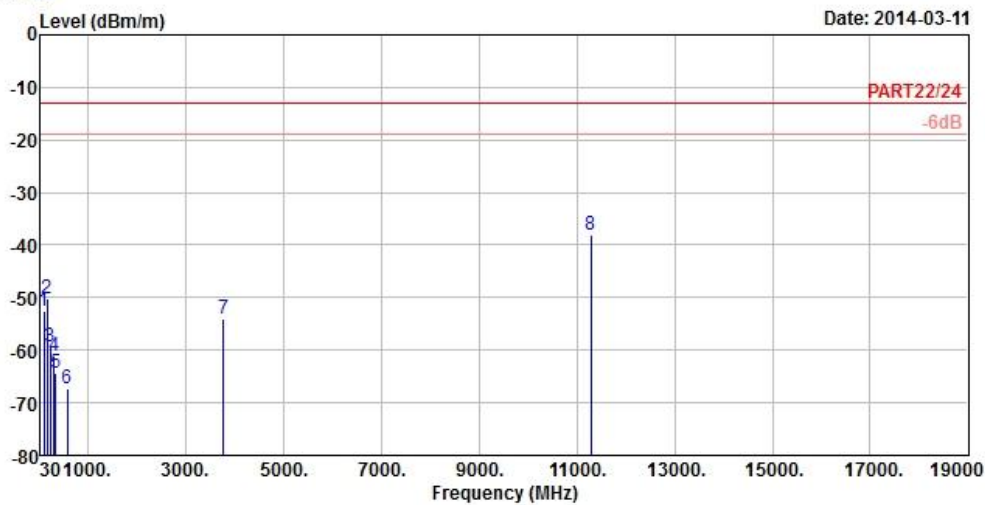

Site : 966 Chamber 5
 Condition : PART22/24 3m HORIZONTAL
 Brand/Model: 0P9C300
 Remark : LTE Band 25_15M_QPSK(1,37) Link
 Tested by : David Huang
 Temperature : 25°C
 Humidity : 65%
 Plane : X

	Read	Limit	Over			
Freq	Level	Level	Line	Limit	Factor	Remark
MHz	dBm/m	dBm	dBm/m	dB	dB/m	
1	98.85	-52.52	-42.10	-13.00	-39.52	-10.42 Peak
2	169.05	-50.21	-43.53	-13.00	-37.21	-6.68 Peak
3	221.97	-59.29	-52.34	-13.00	-46.29	-6.95 Peak
4	308.40	-61.05	-54.73	-13.00	-48.05	-6.32 Peak
5	337.10	-64.45	-58.35	-13.00	-51.45	-6.10 Peak
6	569.50	-67.21	-66.01	-13.00	-54.21	-1.20 Peak
7	3765.00	-54.11	-45.87	-13.00	-41.11	-8.24 Peak
8	pp 11280.00	-37.99	-46.13	-13.00	-24.99	8.14 Peak



A D T



Bureau Veritas Consumer Products Services Ltd., Taoyuan Branch

A D T

Data: 16

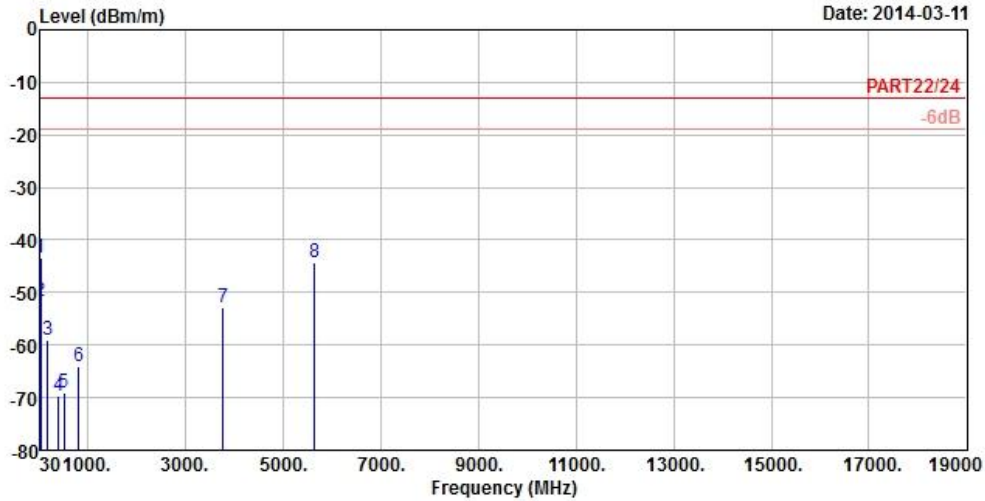

Site : 966 Chamber 5
 Condition : PART22/24 3m VERTICAL
 Brand/Model: 0P9C300
 Remark : LTE Band 25_15M_QPSK(1,37) Link
 Tested by : David Huang
 Temperature : 25°C
 Humidity : 65%
 Plane : X

	Freq	Level	Read Level	Limit Line	Over Limit	Factor	Remark
	MHz	dBm/m	dBm	dBm/m	dB	dB/m	
1 pp	31.08	-43.50	-43.84	-13.00	-30.50	0.34	Peak
2	39.45	-51.62	-50.09	-13.00	-38.62	-1.53	Peak
3	170.13	-59.01	-52.31	-13.00	-46.01	-6.70	Peak
4	406.40	-69.67	-64.20	-13.00	-56.67	-5.47	Peak
5	507.90	-69.19	-66.31	-13.00	-56.19	-2.88	Peak
6	817.30	-64.20	-66.43	-13.00	-51.20	2.23	Peak
7	3765.00	-52.87	-44.63	-13.00	-39.87	-8.24	Peak
8	5647.50	-44.40	-42.50	-13.00	-31.40	-1.90	Peak



5 PHOTOGRAPHS OF THE TEST CONFIGURATION

Please refer to the attached file (Test Setup Photo).



6 INFORMATION ON THE TESTING LABORATORIES

We, Bureau Veritas Consumer Products Services (H.K.) Ltd., Taoyuan Branch, were founded in 1988 to provide our best service in EMC, Radio, Telecom and Safety consultation. Our laboratories are accredited and approved according to ISO/IEC 17025.

If you have any comments, please feel free to contact us at the following:

Linko EMC/RF Lab:

Tel: 886-2-26052180

Fax: 886-2-26051924

Hsin Chu EMC/RF Lab:

Tel: 886-3-5935343

Fax: 886-3-5935342

Hwa Ya EMC/RF/Safety/Telecom Lab:

Tel: 886-3-3183232

Fax: 886-3-3270892

Email: service.adt@tw.bureauveritas.com

Web Site: www.bureauveritas-adt.com

The address and road map of all our labs can be found in our web site also.



A D T

7 APPENDIX A – MODIFICATIONS RECORDERS FOR ENGINEERING CHANGES TO THE EUT BY THE LAB

No any modifications were made to the EUT by the lab during the test.

---END---