



FCC TEST REPORT (PART 27)

REPORT NO.: RF140306C19-7

MODEL NO.: 0P8B200

FCC ID: NM80P8B200

RECEIVED: Mar. 03, 2014

TESTED: Mar. 25, 2014 ~ Apr. 08, 2014

ISSUED: Apr. 15, 2014

APPLICANT: HTC Corporation

ADDRESS: 1F, 6-3 Baoqiang Road, Xindian District, New Taipei City, Taiwan 231

ISSUED BY: Bureau Veritas Consumer Products Services (H.K.) Ltd., Taoyuan Branch

LAB ADDRESS: No. 47, 14th Ling, Chia Pau Vil., Lin Kou Dist., New Taipei City, Taiwan, R.O.C.

TEST LOCATION: No. 19, Hwa Ya 2nd Rd, Wen Hwa Tsuen, Kwei Shan Hsiang, Taoyuan Hsien 333, Taiwan, R.O.C.

This report should not be used by the client to claim product certification, approval, or endorsement by TAF or any government agencies.



This report is for your exclusive use. Any copying or replication of this report to or for any other person or entity, or use of our name or trademark, is permitted only with our prior written permission. This report sets forth our findings solely with respect to the test samples identified herein. The results set forth in this report are not indicative or representative of the quality or characteristics of the lot from which a test sample was taken or any similar or identical product unless specifically and expressly noted. Our report includes all of the tests requested by you and the results thereof based upon the information that you provided to us. You have 60 days from date of issuance of this report to notify us of any material error or omission caused by our negligence, provided, however, that such notice shall be in writing and shall specifically address the issue you wish to raise. A failure to raise such issue within the prescribed time shall constitute your unqualified acceptance of the completeness of this report, the tests conducted and the correctness of the report contents. Unless specifically mentioned, the uncertainty of measurement has been explicitly taken into account to declare the compliance or non-compliance to the specification.

TABLE OF CONTENTS

RELEASE CONTROL RECORD.....	3
1 CERTIFICATION	4
2 SUMMARY OF TEST RESULTS.....	5
2.1 MEASUREMENT UNCERTAINTY	5
2.2 TEST SITE AND INSTRUMENTS	6
3 GENERAL INFORMATION	7
3.1 GENERAL DESCRIPTION OF EUT.....	7
3.2 CONFIGURATION OF SYSTEM UNDER TEST	8
3.3 DESCRIPTION OF SUPPORT UNITS.....	8
3.4 DESCRIPTION OF TEST MODES.....	9
3.5 GENERAL DESCRIPTION OF APPLIED STANDARDS	11
4 TEST TYPES AND RESULTS.....	12
4.1 OUTPUT POWER MEASUREMENT	12
4.1.1 LIMITS OF OUTPUT POWER MEASUREMENT	12
4.1.2 TEST PROCEDURES.....	12
4.1.3 TEST SETUP	13
4.1.4 TEST RESULTS	14
4.2 FREQUENCY STABILITY MEASUREMENT	19
4.2.1 LIMITS OF FREQUENCY STABILITY MEASUREMENT	19
4.2.2 TEST PROCEDURE	19
4.2.3 TEST SETUP	19
4.2.4 TEST RESULTS	20
4.3 OCCUPIED BANDWIDTH MEASUREMENT.....	21
4.3.1 LIMITS OF OCCUPIED BANDWIDTH MEASUREMENT.....	21
4.3.2 TEST SETUP	21
4.3.3 TEST PROCEDURES.....	21
4.3.4 TEST RESULTS	22
4.4 PEAK TO AVERAGE RATIO.....	24
4.4.1 LIMITS OF PEAK TO AVERAGE RATIO MEASUREMENT	24
4.4.2 TEST SETUP	24
4.4.3 TEST PROCEDURES.....	24
4.4.4 TEST RESULTS	25
4.5 BAND EDGE MEASUREMENT	27
4.5.1 LIMITS OF BAND EDGE MEASUREMENT	27
4.5.2 TEST SETUP	27
4.5.3 TEST PROCEDURES.....	28
4.5.4 TEST RESULTS	29
4.6 CONDUCTED SPURIOUS EMISSIONS.....	37
4.6.1 LIMITS OF CONDUCTED SPURIOUS EMISSIONS MEASUREMENT.....	37
4.6.2 TEST PROCEDURE	37
4.6.3 TEST SETUP	37
4.6.4 TEST RESULTS	38
4.7 RADIATED EMISSION MEASUREMENT	40
4.7.1 LIMITS OF RADIATED EMISSION MEASUREMENT	40
4.7.2 TEST PROCEDURES.....	40
4.7.3 DEVIATION FROM TEST STANDARD.....	40
4.7.4 TEST SETUP	41
4.7.5 TEST RESULTS	42
5 INFORMATION ON THE TESTING LABORATORIES	50
6 APPENDIX A – MODIFICATIONS RECORDERS FOR ENGINEERING CHANGES TO THE EUT BY THE LAB.....	51



A D T

RELEASE CONTROL RECORD

ISSUE NO.	REASON FOR CHANGE	DATE ISSUED
RF140306C19-7	Original release	Apr. 15, 2014

1 CERTIFICATION

PRODUCT: Smartphone
MODEL NO.: 0P8B200
BRAND: HTC
APPLICANT: HTC Corporation
TESTED: Mar. 25, 2014 ~ Apr. 08, 2014
TEST SAMPLE: Production Unit
TEST STANDARDS: **FCC Part 27, Subpart C, M**
FCC Part 2
ANSI C63.4-2003

The above equipment (model: 0P8B200) has been tested by **Bureau Veritas Consumer Products Services (H.K.) Ltd., Taoyuan Branch**, and found compliance with the requirement of the above standards. The test record, data evaluation & Equipment Under Test (EUT) configurations represented herein are true and accurate accounts of the measurements of the sample's EMC characteristics under the conditions specified in this report.

PREPARED BY : Ivonne Wu , **DATE:** Apr. 15, 2014
Ivonne Wu / Supervisor

APPROVED BY : Sam Chen , **DATE:** Apr. 15, 2014
Sam Chen / Senior Project Engineer

2 SUMMARY OF TEST RESULTS

The EUT has been tested according to the following specifications:

STANDARD SECTION	TEST TYPE AND LIMIT	RESULT	REMARK
2.1046 27.50(h)	Equivalent Isotropically Radiated Power	PASS	Meet the requirement of limit.
2.1055 27.54	Frequency Stability	PASS	Meet the requirement of limit.
2.1049	Occupied Bandwidth	PASS	Meet the requirement of limit.
	Peak to average ratio	PASS	Meet the requirement of limit.
2.1051 27.53(l)	Band Edge Measurements	PASS	Meet the requirement of limit.
2.1051 27.53(l)	Conducted Spurious Emissions	PASS	Meet the requirement of limit.
2.1053 27.53(l)	Radiated Spurious Emissions	PASS	Meet the requirement of limit. Minimum passing margin is -8.84dB at 12686.00MHz.

2.1 MEASUREMENT UNCERTAINTY

Where relevant, the following measurement uncertainty levels have been estimated for tests performed on the EUT as specified in CISPR 16-4-2:

MEASUREMENT	FREQUENCY	UNCERTAINTY
Conducted emissions	150kHz~30MHz	2.44 dB
Radiated emissions	30MHz ~ 200MHz	2.93 dB
	200MHz ~1000MHz	2.95 dB
	1GHz ~ 18GHz	2.26 dB
	18GHz ~ 40GHz	1.94 dB

This uncertainty represents an expanded uncertainty expressed at approximately the 95% confidence level using a coverage factor of k=2.

2.2 TEST SITE AND INSTRUMENTS

DESCRIPTION & MANUFACTURER	MODEL NO.	SERIAL NO.	DATE OF CALIBRATION	DUE DATE OF CALIBRATION
Test Receiver ROHDE & SCHWARZ	ESCI	100744	Apr. 15, 2013	Apr. 14, 2014
Spectrum Analyzer ROHDE & SCHWARZ	FSU43	101261	Dec. 21, 2013	Dec. 20, 2014
BILOG Antenna SCHWARZBECK	VULB9168	9168-472	Feb. 27, 2014	Feb. 26, 2015
HORN Antenna SCHWARZBECK	BBHA 9120 D	9120D-969	Feb. 19, 2014	Feb. 18, 2015
HORN Antenna SCHWARZBECK	BBHA 9170	9170-480	Dec. 18, 2013	Dec. 17, 2014
Preamplifier EMCI	EMC 012645	980115	Dec. 26, 2013	Dec. 25, 2014
Preamplifier EMCI	EMC 184045	980116	Jan. 13, 2014	Jan. 12, 2015
Preamplifier EMCI	EMC 330H	980112	Dec. 27, 2013	Dec. 26, 2014
RF signal cable HUBER+SUHNNER	SUCOFLEX 104	309219/4 2950114	Oct. 18, 2013	Oct. 17, 2014
RF signal cable HUBER+SUHNNER	SUCOFLEX 104	250130/4	Oct. 18, 2013	Oct. 17, 2014
RF signal cable Worken	RG-213	NA	Nov. 07, 2013	Nov. 06, 2014
Software BV ADT	E3 6.120103	NA	NA	NA
Antenna Tower MF	MFA-440H	NA	NA	NA
Turn Table MF	MFT-201SS	NA	NA	NA
Antenna Tower & Turn Table Controller MF	MF-7802	NA	NA	NA
Mini-Circuits Power Splitter	ZN2PD-9G	NA	Jul. 18, 2013	Jul. 17, 2014
JFW 20dB attenuation	50HF-020-SMA	NA	NA	NA
Communications Tester-Wireless	E5515C	MY52102544	Sep. 05, 2012	Sep. 04, 2014
Radio Communication Analyzer	MT8820C	6201300640	Aug. 01, 2013	Jul. 31, 2014

- NOTE:** 1. The calibration interval of the above test instruments is 12 months and the calibrations are traceable to NML/ROC and NIST/USA.
2. The test was performed in HwaYa Chamber 10.
3. The horn antenna and HP preamplifier (model: 8449B) are used only for the measurement of emission frequency above 1GHz if tested.
4. The FCC Site Registration No. is 690701.
5. The IC Site Registration No. is IC 7450F-10.

3 GENERAL INFORMATION

3.1 GENERAL DESCRIPTION OF EUT

PRODUCT	Smartphone	
MODEL NO.	0P8B200	
POWER SUPPLY	5Vdc (adapter or host equipment) 3.8Vdc (battery)	
MODULATION TECHNOLOGY	LTE Band 7	QPSK, 16QAM
FREQUENCY RANGE	LTE Band 7 Channel Bandwidth: 5MHz	2502.5MHz ~ 2567.5MHz
	LTE Band 7 Channel Bandwidth: 10MHz	2505MHz ~ 2565MHz
	LTE Band 7 Channel Bandwidth: 15MHz	2507.5MHz ~ 2562.5MHz
	LTE Band 7 Channel Bandwidth: 20MHz	2510MHz ~ 2560MHz
EMISSION DESIGNATOR	LTE Band 7 Channel Bandwidth: 5MHz	4M50G7D
	LTE Band 7 Channel Bandwidth: 10MHz	8M92G7D
	LTE Band 7 Channel Bandwidth: 15MHz	13M4G7D
	LTE Band 7 Channel Bandwidth: 20MHz	17M8W7D
MAX. EIRP POWER	LTE Band 7 Channel Bandwidth: 5MHz	118.80mW
	LTE Band 7 Channel Bandwidth: 10MHz	122.69mW
	LTE Band 7 Channel Bandwidth: 15MHz	129.09mW
	LTE Band 7 Channel Bandwidth: 20MHz	129.09mW
ANTENNA TYPE	Fixed Internal Antenna	
DATA CABLE	Refer to Note as below	
I/O PORTS	Refer to users' manual	
ACCESSORY DEVICES	Refer to Note as below	

NOTE:

1. The EUT's accessories list refers to Ext. Pho.
2. The above EUT information is declared by manufacturer and for more detailed features description, please refer to the manufacturer's specifications or User's Manual.

3.2 CONFIGURATION OF SYSTEM UNDER TEST FOR RADIATION EMISSION TEST

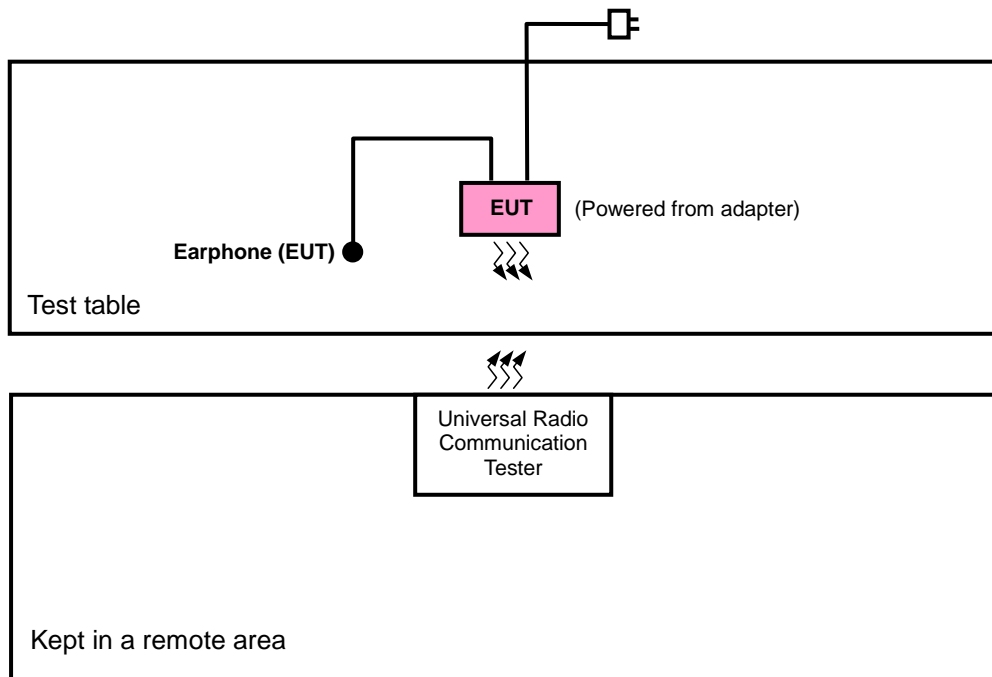

FOR E.I.R.P. TEST

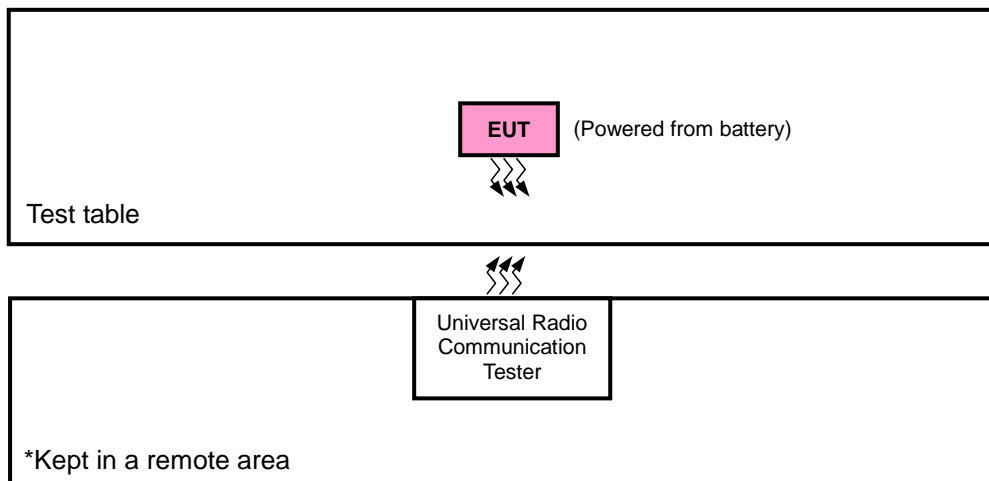

3.3 DESCRIPTION OF SUPPORT UNITS

The EUT has been tested as an independent unit together with other necessary accessories or support units.

3.4 DESCRIPTION OF TEST MODES

Pre-Scan has been conducted to determine the worst-case mode from all possible combinations between available modulations, data rates, XYZ axis and antenna ports. The worst case was found when positioned on X-plane for EIRP and Y-axis for radiated emission. Following channel(s) was (were) selected for the final test as listed below:

LTE BAND 7

EUT CONFIGURE MODE	TEST ITEM	AVAILABLE CHANNEL	TESTED CHANNEL	CHANNEL BANDWIDTH	MODULATION	MODE
-	EIRP	20775 to 21425	20775, 21100, 21425	5MHz	QPSK, 16QAM	1 RB / 24 RB Offset
		20800 to 21400	20800, 21100, 21400	10MHz	QPSK, 16QAM	1 RB / 49 RB Offset
		20825 to 21375	20825, 21100, 21375	15MHz	QPSK, 16QAM	1 RB / 74 RB Offset
		20850 to 21350	20850, 21100 21350	20MHz	QPSK, 16QAM	1 RB / 99 RB Offset
-	FREQUENCY STABILITY	20775 to 21425	21100	5MHz	QPSK	1 RB / 24 RB Offset
		20800 to 21400	21100	10MHz	QPSK	1 RB / 49 RB Offset
		20825 to 21375	21100	15MHz	QPSK	1 RB / 74 RB Offset
		20850 to 21350	21100	20MHz	QPSK	1 RB / 99 RB Offset
-	OCCUPIED BANDWIDTH	20775 to 21425	20775, 21100, 21425	5MHz	QPSK, 16QAM	25 RB / 0 RB Offset
		20800 to 21400	20800, 21100, 21400	10MHz	QPSK, 16QAM	50 RB / 0 RB Offset
		20825 to 21375	20825, 21100, 21375	15MHz	QPSK, 16QAM	75 RB / 0 RB Offset
		20850 to 21350	20850, 21100 21350	20MHz	QPSK, 16QAM	100 RB / 0 RB Offset
-	PEAK TO AVERAGE RATIO	20775 to 21425	20775, 21100, 21425	5MHz	QPSK, 16QAM	1 RB / 24 RB Offset
		20800 to 21400	20800, 21100, 21400	10MHz	QPSK, 16QAM	1 RB / 49 RB Offset
		20825 to 21375	20825, 21100, 21375	15MHz	QPSK, 16QAM	1 RB / 74 RB Offset
		20850 to 21350	20850, 21100 21350	20MHz	QPSK, 16QAM	1 RB / 99 RB Offset
-	BAND EDGE	20775 to 21425	20775, 21425	5MHz	QPSK, 16QAM	25 RB / 0 RB Offset
		20800 to 21400	20800, 21400	10MHz	QPSK, 16QAM	50 RB / 0 RB Offset
		20825 to 21375	20825, 21375	15MHz	QPSK, 16QAM	75 RB / 0 RB Offset
		20850 to 21350	20850, 21350	20MHz	QPSK, 16QAM	100 RB / 0 RB Offset
-	CONDCUDETED EMISSION	20775 to 21425	21100	5MHz	QPSK	1 RB / 24 RB Offset
		20800 to 21400	21100	10MHz	QPSK	1 RB / 49 RB Offset
		20825 to 21375	21100	15MHz	QPSK	1 RB / 74 RB Offset
		20850 to 21350	21100	20MHz	QPSK	1 RB / 99 RB Offset
-	RADIATED EMISSION	20775 to 21425	21100	5MHz	QPSK	1 RB / 24 RB Offset
		20800 to 21400	21100	10MHz	QPSK	1 RB / 49 RB Offset
		20825 to 21375	21100	15MHz	QPSK	1 RB / 74 RB Offset
		20850 to 21350	21100	20MHz	QPSK	1 RB / 99 RB Offset

Note: This device was tested under all bandwidths, RB configurations and modulations. The worst case was found in QPSK modulation.



A D T

TEST CONDITION:

TEST ITEM	ENVIRONMENTAL CONDITIONS	INPUT POWER	TESTED BY
ERP/EIRP	26deg. C, 58%RH	3.8Vdc	Howard Kao
FREQUENCY STABILITY	26deg. C, 58%RH	3.8Vdc	Howard Kao
OCCUPIED BANDWIDTH	26deg. C, 58%RH	3.8Vdc	Howard Kao
PEAK TO AVERAGE RATIO	26deg. C, 58%RH	3.8Vdc	Howard Kao
BAND EDGE	26deg. C, 58%RH	3.8Vdc	Howard Kao
CONDCUDED EMISSION	26deg. C, 58%RH	3.8Vdc	Howard Kao
RADIATED EMISSION	25deg. C, 65%RH	120Vac, 60Hz	Anson Lin

3.5 GENERAL DESCRIPTION OF APPLIED STANDARDS

The EUT is a RF product. According to the specifications of the manufacturer, it must comply with the requirements of the following standards:

FCC 47 CFR Part 2

FCC 47 CFR Part 27

ANSI C63.4-2003

ANSI/TIA/EIA-603-C 2004

NOTE: All test items have been performed and recorded as per the above standards.

4 TEST TYPES AND RESULTS

4.1 OUTPUT POWER MEASUREMENT

4.1.1 LIMITS OF OUTPUT POWER MEASUREMENT

The radiated peak output power shall be according to the specific rule Part 27.50(h)(2) that “User stations are limited to 2 watts” and 27.50(i) specific that “Peak transmit power must be measure over any interval of continuous transmission using instrumentation calibration in terms of rms-equivalent voltage.”

4.1.2 TEST PROCEDURES

EIRP MEASUREMENT:

- a. All measurements were done at low, middle and high operational frequency range. RBW and VBW is 10MHz for LTE mode.
- b. Substitution method is used for E.I.R.P measurement. In the semi-anechoic chamber, EUT placed on the 0.8m height of Turn Table, rotated the table around 360 degrees to search the maximum radiation power and receiver antenna shall be rotated vertical and horizontal polarization and moved height from 1m to 4m to find the maximum polar radiated power. The “Read Value” is the spectrum reading the maximum power value.
- c. The substitution horn antenna is substituted for EUT at the same position and signals generator export the CW signal to the substitution antenna via a tx cable. Rotated the Turn Table and moved receiving antenna to find the maximum radiation power. Adjust output power level of S.G to get a Value of spectrum reading equal to “Read Value” of step b. Record the power level of S.G.
- d. $EIRP = \text{Output power level of S.G} - \text{TX cable loss} + \text{Antenna gain of substitution horn}.$

CONDUCTED POWER MEASUREMENT:

- a. The EUT was set up for the maximum power with LTE link data modulation and link up with simulator.
- b. Set the EUT to transmit under low, middle and high channel and record the power level shown on simulator.

4.1.3 TEST SETUP

EIRP / ERP MEASUREMENT:

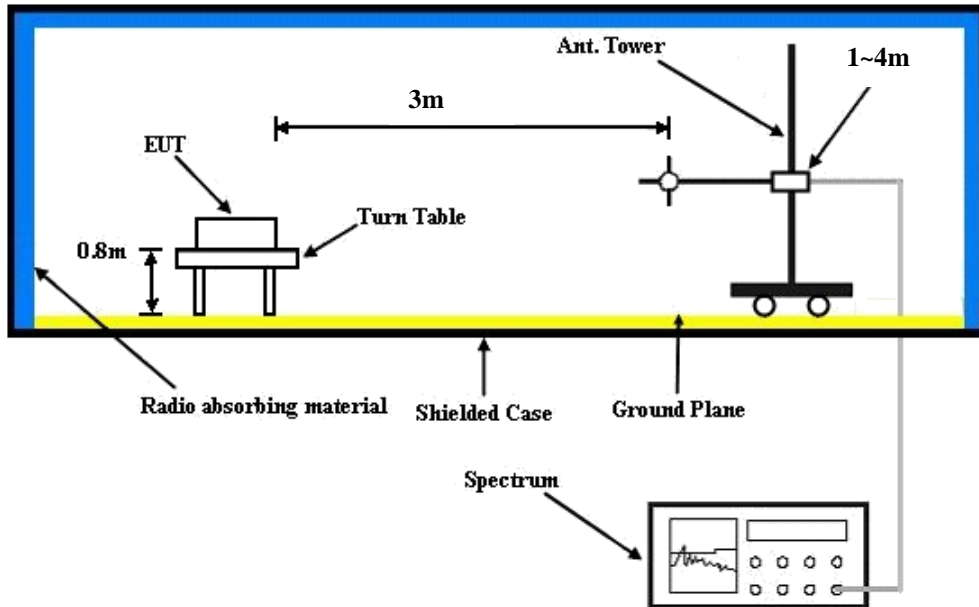

CONDUCTED POWER MEASUREMENT:

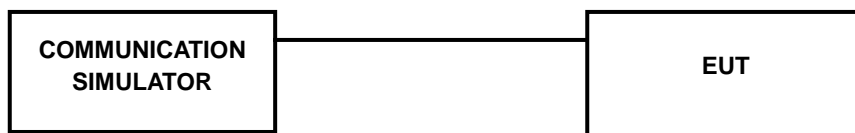



4.1.4 TEST RESULTS

AVERAGE CONDUCTED OUTPUT POWER (dBm)

Band / BW	Modulation	RB Size	RB Offset	Low CH 20775	Mid CH 21100	High CH 21425	3PGG MPR (dB)
				Frequency 2502.5 MHz	Frequency 2535 MHz	Frequency 2567.5 MHz	
7 / 5M	QPSK	1	0	22.03	21.74	21.68	0
		1	12	21.98	21.92	21.62	0
		1	24	22.12	21.87	21.63	0
		12	0	21.06	20.94	20.80	1
		12	6	21.04	21.01	20.68	1
		12	13	21.06	21.02	20.66	1
		25	0	21.03	21.01	20.71	1
	16QAM	1	0	21.02	20.73	20.67	1
		1	12	20.97	20.91	20.61	1
		1	24	21.11	20.86	20.62	1
		12	0	20.05	19.93	19.79	2
		12	6	20.03	20.00	19.67	2
		12	13	20.05	20.01	19.65	2
		25	0	20.02	20.00	19.70	2

Band / BW	Modulation	RB Size	RB Offset	Low CH 20800	Mid CH 21100	High CH 21400	3PGG MPR (dB)
				Frequency 2505 MHz	Frequency 2535 MHz	Frequency 2565 MHz	
7 / 10M	QPSK	1	0	22.15	21.86	21.80	0
		1	24	22.10	22.04	21.74	0
		1	49	22.24	21.99	21.75	0
		25	0	21.18	21.06	20.92	1
		25	12	21.16	21.13	20.80	1
		25	25	21.18	21.14	20.78	1
		50	0	21.15	21.13	20.83	1
	16QAM	1	0	21.14	20.85	20.79	1
		1	24	21.09	21.03	20.73	1
		1	49	21.23	20.98	20.74	1
		25	0	20.17	20.05	19.91	2
		25	12	20.15	20.12	19.79	2
		25	25	20.17	20.13	19.77	2
		50	0	20.14	20.12	19.82	2



A D T

Band / BW	Modulation	RB Size	RB Offset	Low CH 20825	Mid CH 21100	High CH 21375	3PGG MPR (dB)
				Frequency 2507.5 MHz	Frequency 2535 MHz	Frequency 2562.5 MHz	
7 / 15M	QPSK	1	0	22.27	21.98	21.92	0
		1	37	22.22	22.16	21.86	0
		1	74	22.36	22.11	21.87	0
		36	0	21.30	21.18	21.04	1
		36	19	21.28	21.25	20.92	1
		36	39	21.30	21.26	20.90	1
		75	0	21.27	21.25	20.95	1
	16QAM	1	0	21.26	20.97	20.91	1
		1	37	21.21	21.15	20.85	1
		1	74	21.35	21.10	20.86	1
		36	0	20.29	20.17	20.03	2
		36	19	20.27	20.24	19.91	2
		36	39	20.29	20.25	19.89	2
		75	0	20.26	20.24	19.94	2

Band / BW	Modulation	RB Size	RB Offset	Low CH 20850	Mid CH 21100	High CH 21350	3PGG MPR (dB)
				Frequency 2510 MHz	Frequency 2535 MHz	Frequency 2560 MHz	
7 / 20M	QPSK	1	0	22.38	22.09	22.03	0
		1	50	22.33	22.27	21.97	0
		1	99	22.47	22.22	21.98	0
		50	0	21.41	21.29	21.15	1
		50	25	21.39	21.36	21.03	1
		50	50	21.40	21.37	21.01	1
		100	0	21.38	21.36	21.06	1
	16QAM	1	0	21.37	21.08	21.02	1
		1	50	21.32	21.26	20.96	1
		1	99	21.46	21.21	20.97	1
		50	0	20.40	20.28	20.14	2
		50	25	20.38	20.35	20.02	2
		50	50	20.40	20.36	20.00	2
		100	0	20.37	20.35	20.05	2



A D T

AVERAGE EIRP (dBm)

LTE Band 7							
Channel Bandwidth: 5MHz / QPSK							
Plane	Channel	Frequency (MHz)	LVL (dBm)	Correction Factor(dB)	EIRP(dBm)	EIRP(mW)	Polarization (H/V)
X	20775	2502.5	-17.77	38.52	20.75	118.80	H
	21100	2535.0	-17.73	38.36	20.63	115.64	
	21425	2567.5	-17.89	38.58	20.69	117.30	
	20775	2502.5	-25.55	38.92	13.37	21.75	V
	21100	2535.0	-25.30	39.26	13.96	24.89	
	21425	2567.5	-25.91	39.22	13.31	21.41	

LTE Band 7							
Channel Bandwidth: 5MHz / 16QAM							
Plane	Channel	Frequency (MHz)	LVL (dBm)	Correction Factor(dB)	EIRP(dBm)	EIRP(mW)	Polarization (H/V)
X	20775	2502.5	-18.92	38.52	19.60	91.16	H
	21100	2535.0	-18.72	38.36	19.64	92.07	
	21425	2567.5	-19.15	38.58	19.43	87.76	
	20775	2502.5	-25.74	38.92	13.18	20.82	V
	21100	2535.0	-25.41	39.26	13.85	24.27	
	21425	2567.5	-25.89	39.22	13.33	21.51	

LTE Band 7							
Channel Bandwidth: 10MHz / QPSK							
Plane	Channel	Frequency (MHz)	LVL (dBm)	Correction Factor(dB)	EIRP(dBm)	EIRP(mW)	Polarization (H/V)
X	20800	2505.0	-17.79	38.65	20.86	121.87	H
	21100	2535.0	-17.48	38.36	20.88	122.46	
	21400	2565.0	-17.60	38.49	20.89	122.69	
	20800	2505.0	-25.59	38.84	13.25	21.14	V
	21100	2535.0	-25.61	39.26	13.65	23.19	
	21400	2565.0	-25.95	39.10	13.15	20.65	



A D T

LTE Band 7							
Channel Bandwidth: 10MHz / 16QAM							
Plane	Channel	Frequency (MHz)	LVL (dBm)	Correction Factor(dB)	EIRP(dBm)	EIRP(mW)	Polarization (H/V)
X	20800	2505.0	-19.19	38.65	19.46	88.29	H
	21100	2535.0	-18.75	38.36	19.61	91.41	
	21400	2565.0	-18.92	38.49	19.57	90.53	
	20800	2505.0	-25.48	38.84	13.36	21.68	V
	21100	2535.0	-25.46	39.26	13.80	24.00	
	21400	2565.0	-26.09	39.10	13.01	20.00	

LTE Band 7							
Channel Bandwidth: 15MHz / QPSK							
Plane	Channel	Frequency (MHz)	LVL (dBm)	Correction Factor(dB)	EIRP(dBm)	EIRP(mW)	Polarization (H/V)
X	20825	2507.5	-17.54	38.65	21.11	129.09	H
	21100	2535.0	-17.27	38.36	21.09	128.53	
	21375	2562.5	-17.55	38.49	20.94	124.11	
	20825	2507.5	-25.79	38.84	13.05	20.19	V
	21100	2535.0	-26.05	39.26	13.21	20.96	
	21375	2562.5	-25.97	39.10	13.13	20.56	

LTE Band 7							
Channel Bandwidth: 15MHz / 16QAM							
Plane	Channel	Frequency (MHz)	LVL (dBm)	Correction Factor(dB)	EIRP(dBm)	EIRP(mW)	Polarization (H/V)
X	20825	2507.5	-17.62	38.65	21.03	126.74	H
	21100	2535.0	-17.36	38.36	21.00	125.89	
	21375	2562.5	-17.51	38.49	20.98	125.26	
	20825	2507.5	-25.65	38.84	13.19	20.85	V
	21100	2535.0	-25.94	39.26	13.32	21.49	
	21375	2562.5	-25.78	39.10	13.32	21.48	



A D T

LTE Band 7							
Channel Bandwidth: 20MHz / QPSK							
Plane	Channel	Frequency (MHz)	LVL (dBm)	Correction Factor(dB)	EIRP(dBm)	EIRP(mW)	Polarization (H/V)
X	20850.0	2510.0	-17.54	38.65	21.11	129.09	H
	21100.0	2535.0	-17.28	38.36	21.08	128.23	
	21350.0	2560.0	-17.31	38.49	21.18	131.16	
	20850.0	2510.0	-26.50	38.84	12.34	17.14	V
	21100.0	2535.0	-26.53	39.26	12.73	18.76	
	21350.0	2560.0	-26.19	39.10	12.91	19.54	

LTE Band 7							
Channel Bandwidth: 20MHz / 16QAM							
Plane	Channel	Frequency (MHz)	LVL (dBm)	Correction Factor(dB)	EIRP(dBm)	EIRP(mW)	Polarization (H/V)
X	20850.0	2510.0	-18.57	38.65	20.08	101.84	H
	21100.0	2535.0	-18.29	38.36	20.07	101.62	
	21350.0	2560.0	-18.44	38.49	20.05	101.11	
	20850.0	2510.0	-26.19	38.84	12.65	18.41	V
	21100.0	2535.0	-26.40	39.26	12.86	19.33	
	21350.0	2560.0	-26.10	39.10	13.00	19.95	

4.2 FREQUENCY STABILITY MEASUREMENT

4.2.1 LIMITS OF FREQUENCY STABILITY MEASUREMENT

The frequency stability shall be sufficient to ensure that the fundamental emissions stay within the authorized bands of operation.

4.2.2 TEST PROCEDURE

- Device is placed at the oven room. The oven room could control the temperatures and humidity. Power warm up is at least 15 min and power applied should perform before recording frequency error.
- EUT is connected the external power supply to control the DC input power. The test voltage range is from minimum to maximum working voltage. Each step shall be record the frequency error rate.
- The temperature range step is 10 degrees in this test items. All temperature levels shall be hold the $\pm 0.5^{\circ}\text{C}$ during the measurement testing. The each temperature step shall be at least 0.5 hours, consider the EUT could be test under the stability condition.

NOTE: The frequency error was recorded frequency error from the communication simulator.

4.2.3 TEST SETUP

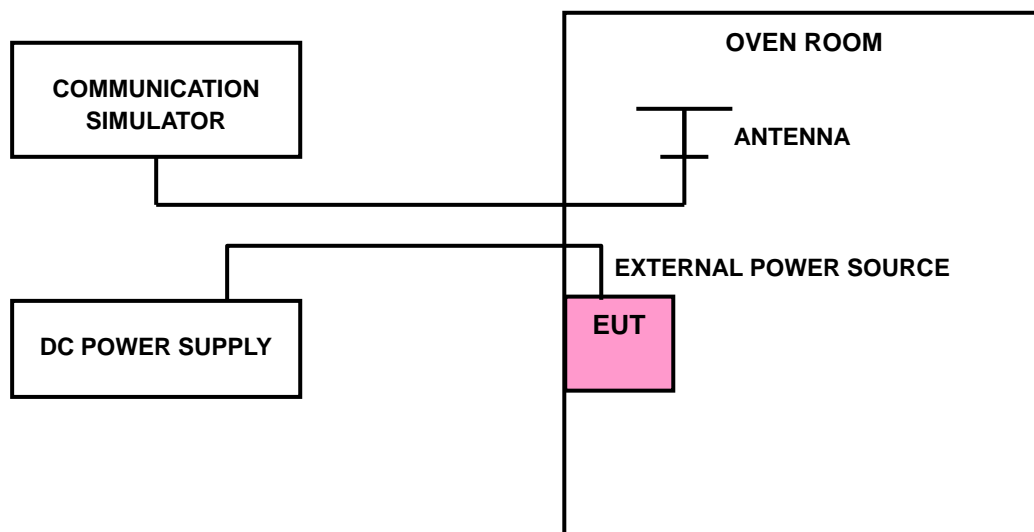

4.2.4 TEST RESULTS

FREQUENCY ERROR vs. VOLTAGE

VOLTAGE (Volts)	FREQUENCY ERROR (ppm)				LIMIT (ppm)
	LTE BAND 7				
	5MHz	10MHz	15MHz	20MHz	
3.8	0.0028	0.0038	-0.0029	-0.0045	2.5
3.6	-0.0005	0.0014	-0.0008	-0.0030	2.5
4.35	0.0068	-0.0025	-0.0014	0.0006	2.5

NOTE: The applicant defined the normal working voltage of the battery is from 3.6Vdc to 4.35Vdc.

FREQUENCY ERROR vs. TEMPERATURE

TEMP. (°C)	FREQUENCY ERROR (ppm)				LIMIT (ppm)
	LTE BAND 7				
	5MHz	10MHz	15MHz	20MHz	
-30	-0.0019	0.0037	0.0038	0.0015	2.5
-20	-0.0055	0.0050	0.0013	0.0005	2.5
-10	0.0021	-0.0050	-0.0065	-0.0014	2.5
0	0.0014	-0.0005	-0.0050	-0.0009	2.5
10	-0.0029	0.0034	-0.0016	0.0007	2.5
20	-0.0013	-0.0016	-0.0010	0.0009	2.5
30	-0.0011	0.0026	-0.0005	0.0021	2.5
40	0.0011	0.0011	0.0041	0.0014	2.5
50	-0.0017	-0.0029	0.0039	-0.0007	2.5
60	0.0019	-0.0059	-0.0017	-0.0002	2.5

4.3 OCCUPIED BANDWIDTH MEASUREMENT

4.3.1 LIMITS OF OCCUPIED BANDWIDTH MEASUREMENT

The width of a frequency band such that, below the lower and above the upper frequency limits, the mean powers emitted are each equal to a specified percentage 0.5 %of the total mean power of a given emission.

4.3.2 TEST SETUP

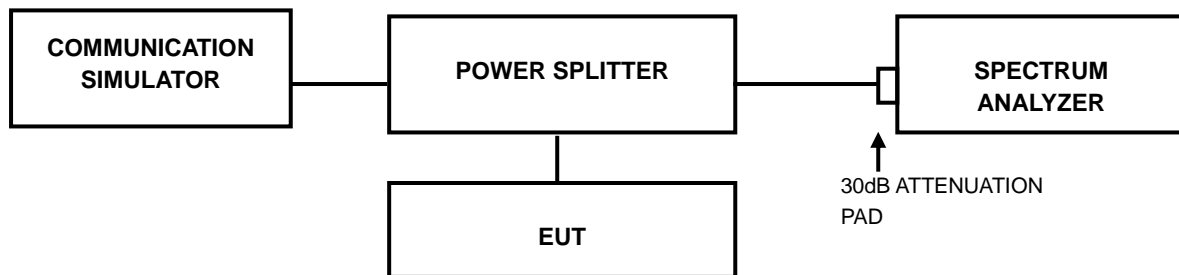

4.3.3 TEST PROCEDURES

- The conducted occupied bandwidth used the power splitter via EUT RF power connector between simulation base station and spectrum analyzer.
- Use OBW measurement function of Spectrum analyzer to measure 99 % occupied bandwidth.



A D T

4.3.4 TEST RESULTS

LTE BAND 7							
CHANNEL BANDWIDTH: 5MHz				CHANNEL BANDWIDTH: 10MHz			
CHANNEL	FREQUENCY (MHz)	99% OCCUPIED BANDWIDTH (MHz)		CHANNEL	FREQUENCY (MHz)	99% OCCUPIED BANDWIDTH (MHz)	
		QPSK	16QAM			QPSK	16QAM
20775	2502.5	4.4954	4.4920	20800	2505.0	8.9166	8.9136
21100	2535.0	4.4933	4.4915	21100	2535.0	8.9182	8.9156
21425	2567.5	4.4951	4.4899	21400	2565.0	8.9175	8.9100

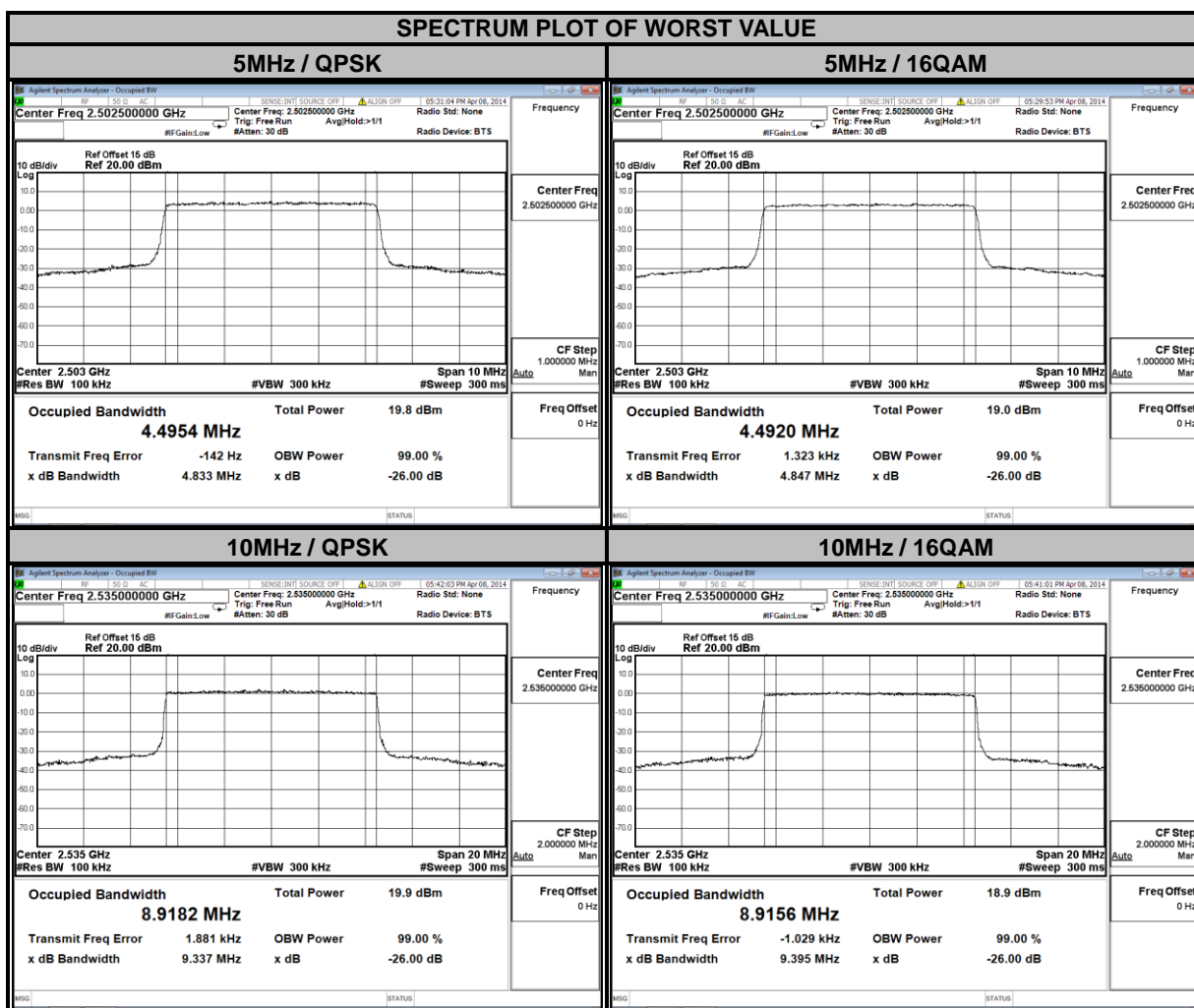



A D T

LTE BAND 7							
CHANNEL BANDWIDTH: 15MHz				CHANNEL BANDWIDTH: 20MHz			
CHANNEL	FREQUENCY (MHz)	99% OCCUPIED BANDWIDTH (MHz)		CHANNEL	FREQUENCY (MHz)	99% OCCUPIED BANDWIDTH (MHz)	
		QPSK	16QAM			QPSK	16QAM
20825	2507.5	13.384	13.379	20850	2510.0	17.802	17.817
21100	2535.0	13.365	13.368	21100	2535.0	17.815	17.808
21375	2562.5	13.366	13.365	21350	2560.0	17.801	17.804

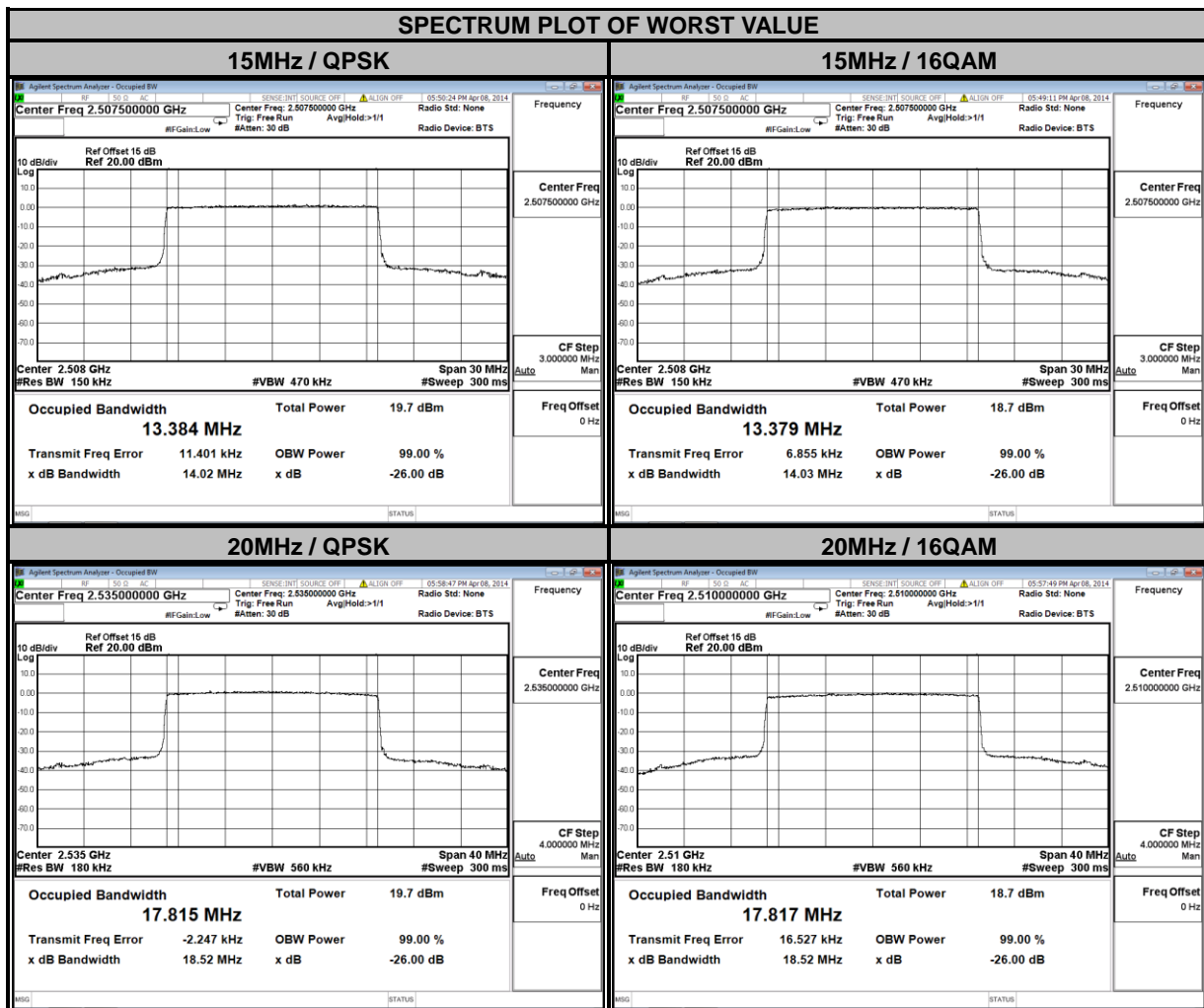

4.4 PEAK TO AVERAGE RATIO

4.4.1 LIMITS OF PEAK TO AVERAGE RATIO MEASUREMENT

In measuring transmissions in this band using an average power technique, the peak to-average ratio (PAR) of the transmission may not exceed 13 dB.

4.4.2 TEST SETUP

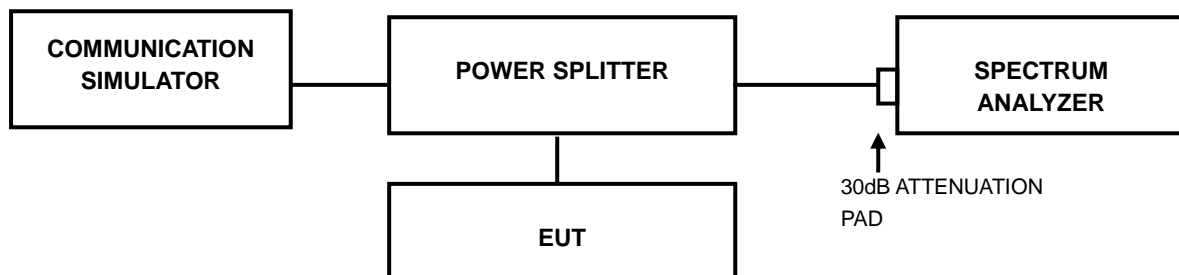

4.4.3 TEST PROCEDURES

1. Set resolution/measurement bandwidth \geq signal's occupied bandwidth;
2. Set the number of counts to a value that stabilizes the measured CCDF curve;
3. Record the maximum PAPR level associated with a probability of 0.1%.



A D T

4.4.4 TEST RESULTS

LTE BAND 7							
CHANNEL BANDWIDTH: 5MHz				CHANNEL BANDWIDTH: 10MHz			
CHANNEL	FREQUENCY (MHz)	PEAK TO AVERAGE RATIO (dB)		CHANNEL	FREQUENCY (MHz)	PEAK TO AVERAGE RATIO (dB)	
		QPSK	16QAM			QPSK	16QAM
20775	2502.5	5.32	6.49	20800	2505.0	5.54	6.65
21100	2535.0	5.50	6.49	21100	2535.0	5.49	6.63
21425	2567.5	5.47	6.60	21400	2565.0	5.56	6.76

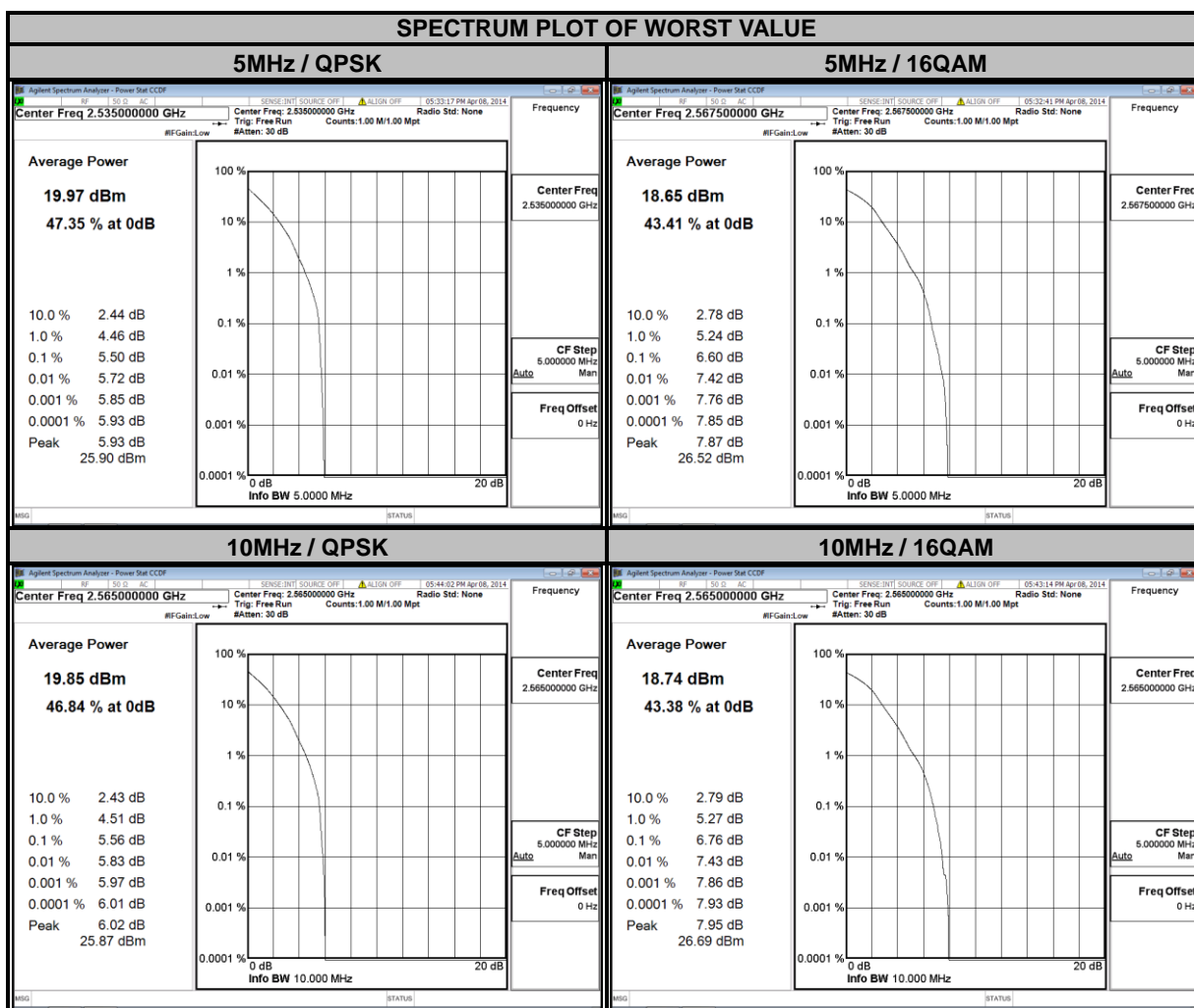



A D T

LTE BAND 7							
CHANNEL BANDWIDTH: 15MHz				CHANNEL BANDWIDTH: 20MHz			
CHANNEL	FREQUENCY (MHz)	PEAK TO AVERAGE RATIO (dB)		CHANNEL	FREQUENCY (MHz)	PEAK TO AVERAGE RATIO (dB)	
		QPSK	16QAM			QPSK	16QAM
20825	2507.5	5.50	6.51	20850	2510.0	5.55	6.60
21100	2535.0	5.49	6.40	21100	2535.0	5.51	6.64
21375	2562.5	5.63	7.12	21350	2560.0	5.83	6.91

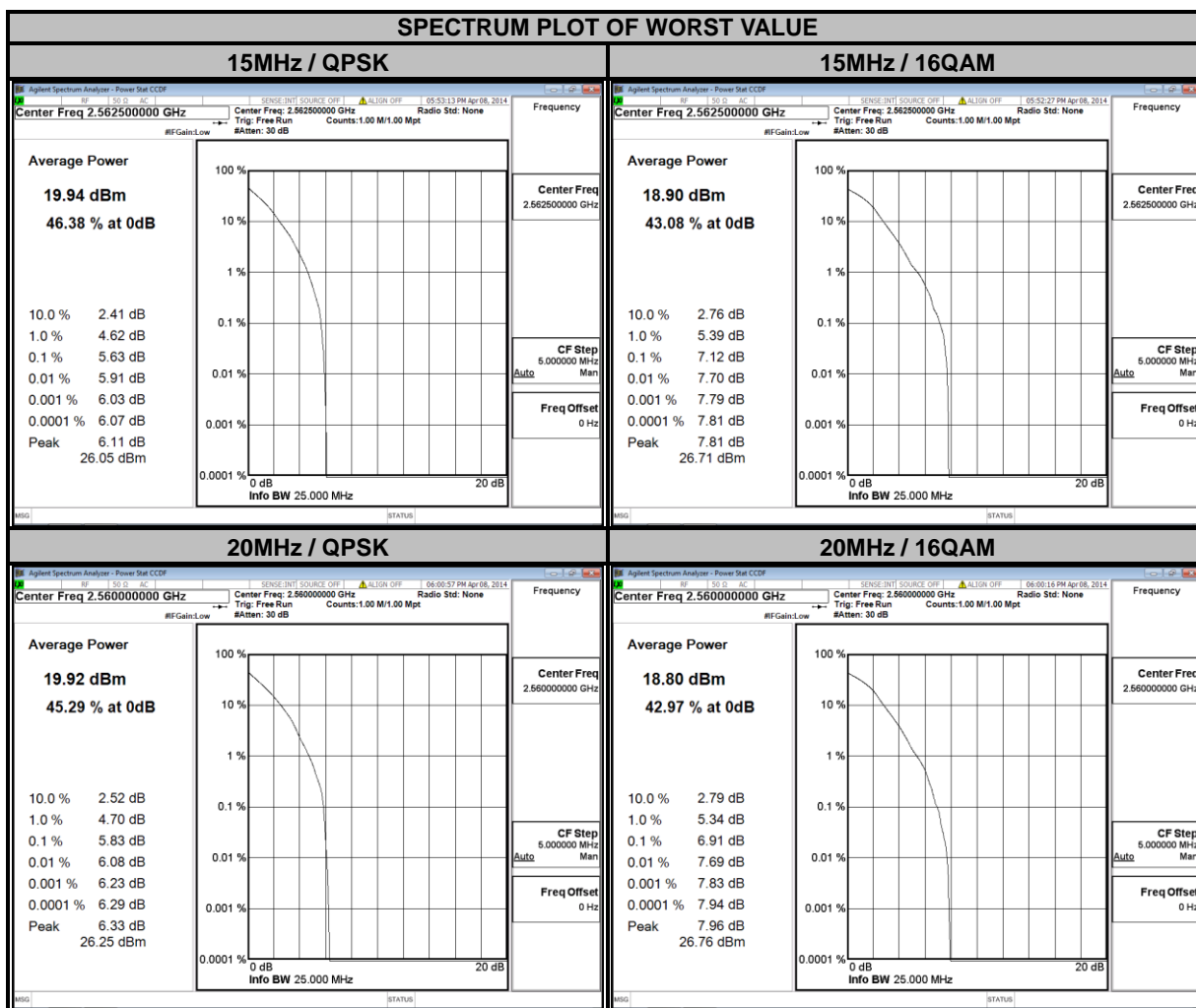

4.5 BAND EDGE MEASUREMENT

4.5.1 LIMITS OF BAND EDGE MEASUREMENT

According to FCC 27.53(l)(4) specified that power of any emission outside of the channel edge must be attenuated below the transmitting power (P) by a factor shall be not less than $43 + 10 \log (P)$ dB at the channel edge, the limit of emission is equal to -13dBm . And $55 + 10 \log (P)$ dB at 5.5 MHz from the channel edges, the limit of emission is equal to -25dBm . In the 1MHz bands immediately outside and adjacent to the frequency block a resolution bandwidth of at least one percent of the emission bandwidth of the fundamental emission of the transmitter may be employed.

4.5.2 TEST SETUP

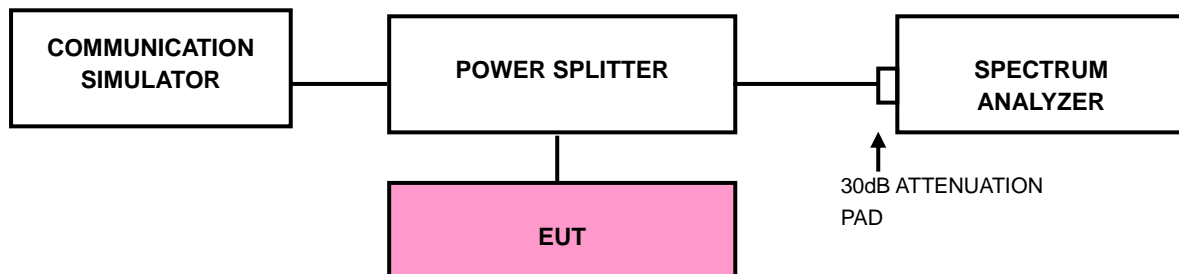

4.5.3 TEST PROCEDURES

- a. The EUT was set up for the maximum peak power with LTE link data modulation. The power was measured with R&S Spectrum Analyzer. All measurements were done at 2 channels (low and high operational frequency range.).
- b. The band edge measurement used the power splitter via EUT RF power connector between simulation base station and spectrum analyzer.
- c. The center frequency of spectrum is the band edge frequency and span is 20MHz. RB of the spectrum is 50kHz and VB of the spectrum is 200kHz (Channel bandwidth 7MHz).
- d. The center frequency of spectrum is the band edge frequency and span is 15MHz. RB of the spectrum is 100kHz and VB of the spectrum is 300kHz (Channel bandwidth 10MHz).
- e. The center frequency of spectrum is the band edge frequency and span is 20MHz. RB of the spectrum is 200kHz and VB of the spectrum is 1MHz (Channel bandwidth 15MHz).
- f. The center frequency of spectrum is the band edge frequency and span is 30MHz. RB of the spectrum is 200kHz and VB of the spectrum is 1MHz (Channel bandwidth 20MHz).
- g. Record the max trace plot into the test report.



A D T

4.5.4 TEST RESULTS

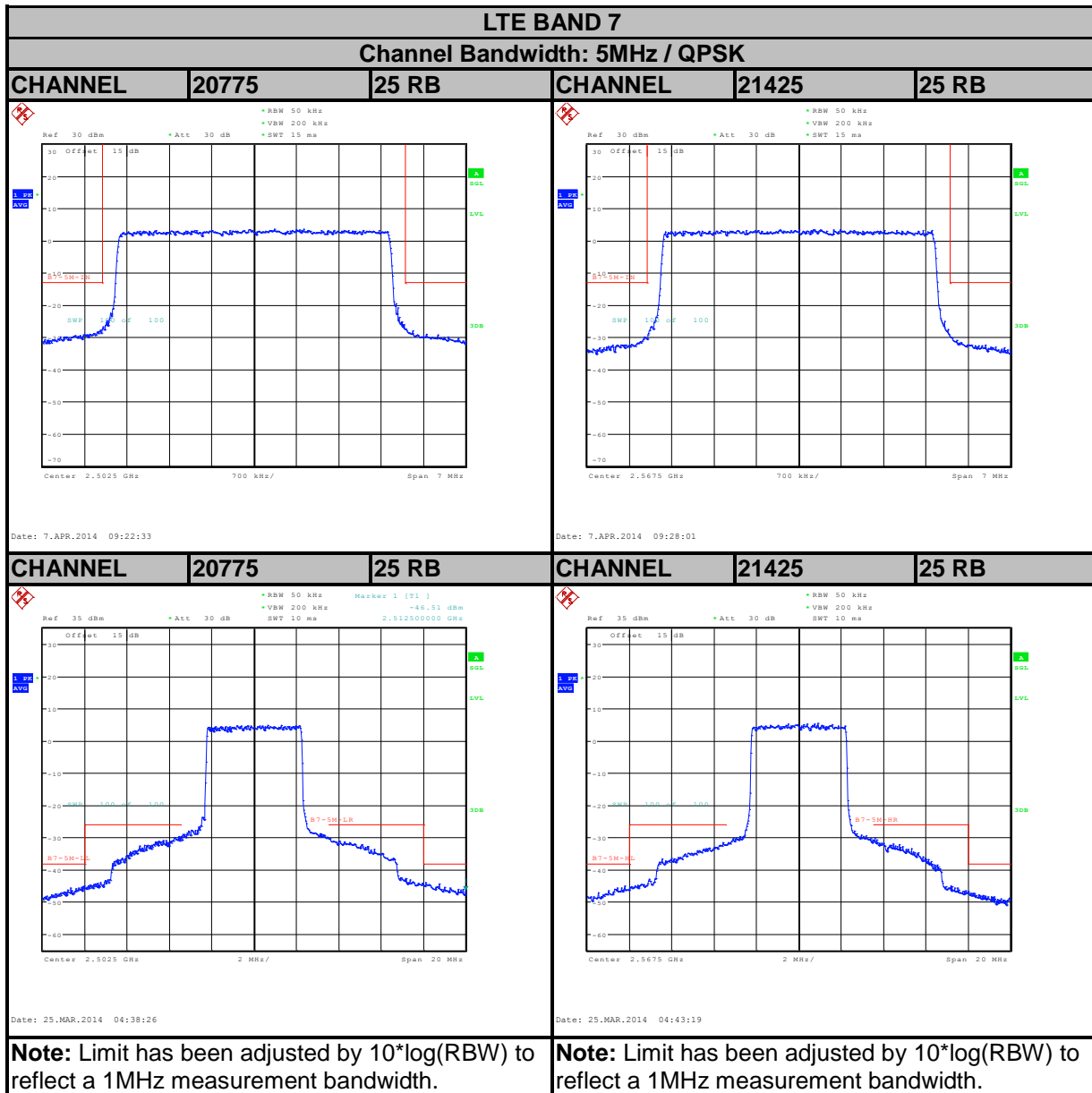



A D T

LTE BAND 7

Channel Bandwidth: 5MHz / 16QAM

CHANNEL	20775	25 RB	CHANNEL	21425	25 RB
----------------	--------------	--------------	----------------	--------------	--------------

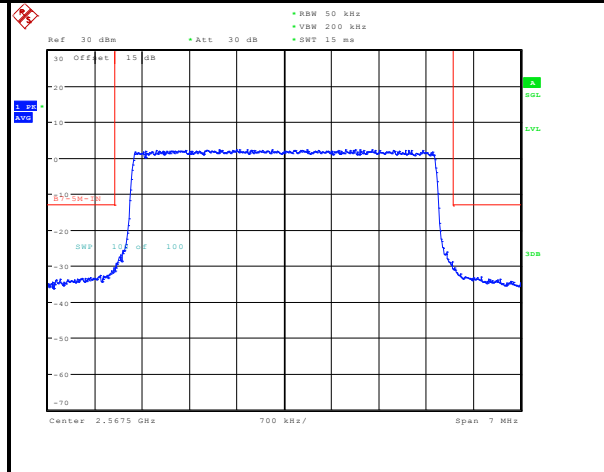
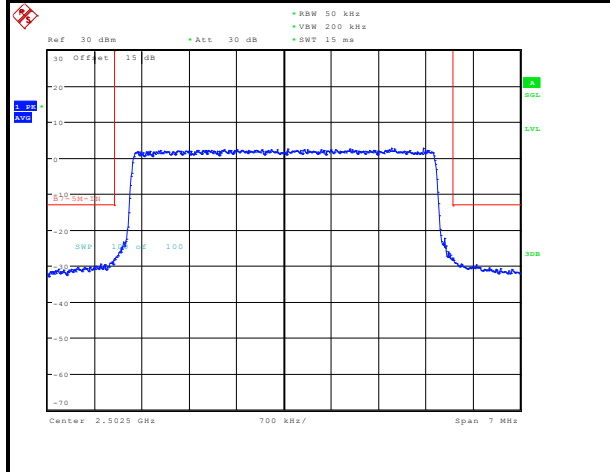

Date: 7.APR.2014 09:15:52

Date: 7.APR.2014 09:28:19

CHANNEL	20775	25 RB
----------------	--------------	--------------

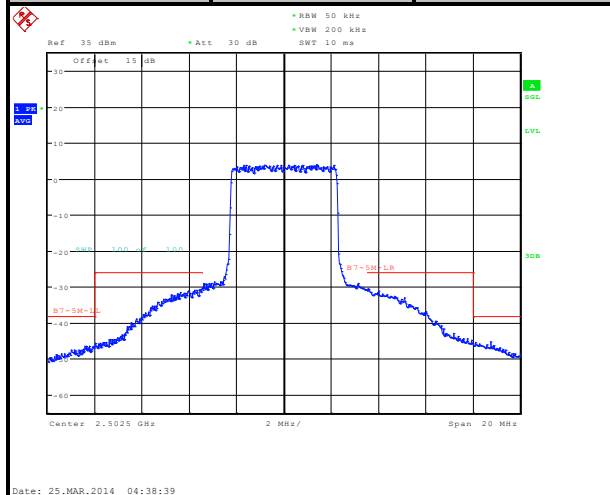

CHANNEL	21425	25 RB
----------------	--------------	--------------

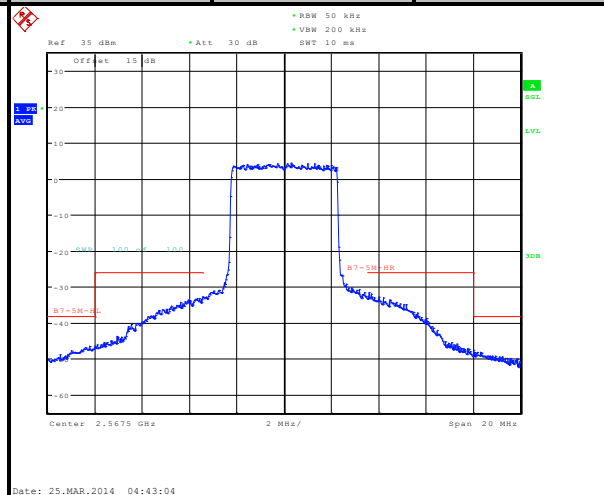

Date: 25.MAR.2014 04:38:39

Date: 25.MAR.2014 04:43:04

Note: Limit has been adjusted by $10 \cdot \log(\text{RBW})$ to reflect a 1MHz measurement bandwidth.

Note: Limit has been adjusted by $10 \cdot \log(\text{RBW})$ to reflect a 1MHz measurement bandwidth.



A D T

LTE BAND 7

Channel Bandwidth: 10MHz / QPSK

CHANNEL	20800	50 RB	CHANNEL	21400	50 RB
---------	-------	-------	---------	-------	-------

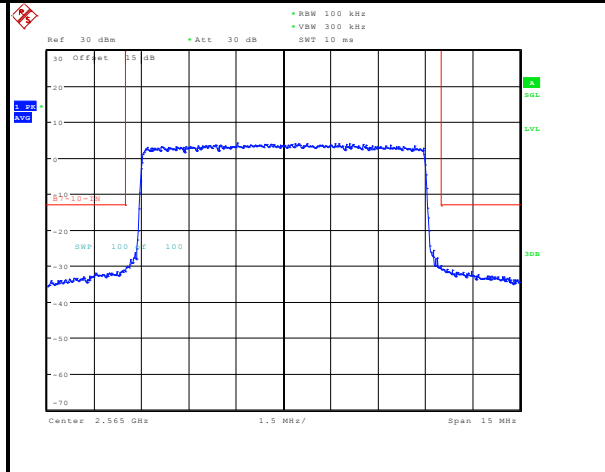
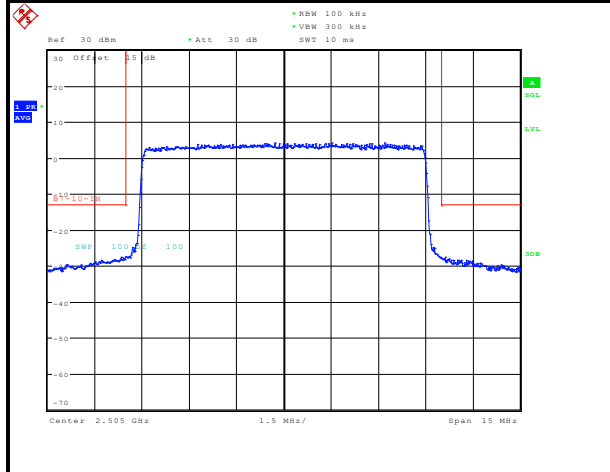

Date: 7.APR.2014 09:06:12

Date: 7.APR.2014 09:06:44

CHANNEL	20800	50 RB	CHANNEL	21400	50 RB
---------	-------	-------	---------	-------	-------

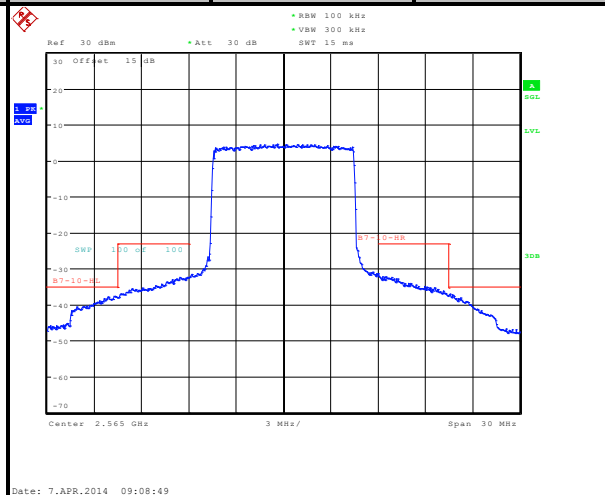
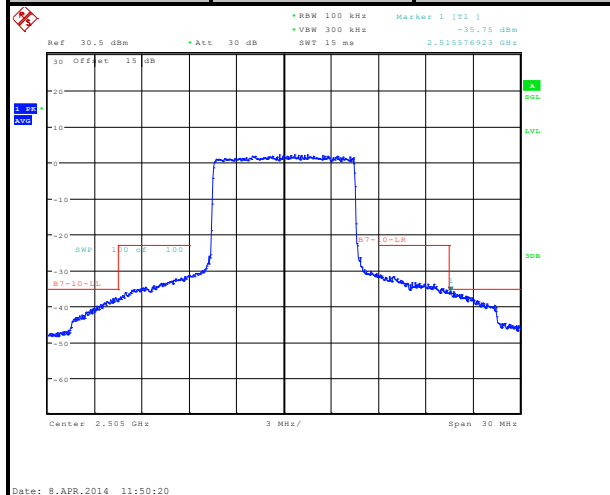

Date: 8.APR.2014 11:50:20

Date: 7.APR.2014 09:08:49

Note: Limit has been adjusted by $10 \cdot \log(\text{RBW})$ to reflect a 1MHz measurement bandwidth.

Note: Limit has been adjusted by $10 \cdot \log(\text{RBW})$ to reflect a 1MHz measurement bandwidth.



A D T

LTE BAND 7

Channel Bandwidth: 10MHz / 16QAM

CHANNEL	20800	50 RB	CHANNEL	21400	50 RB
---------	-------	-------	---------	-------	-------

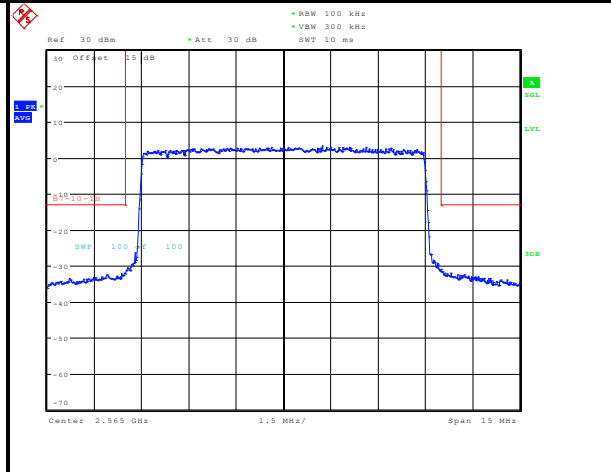
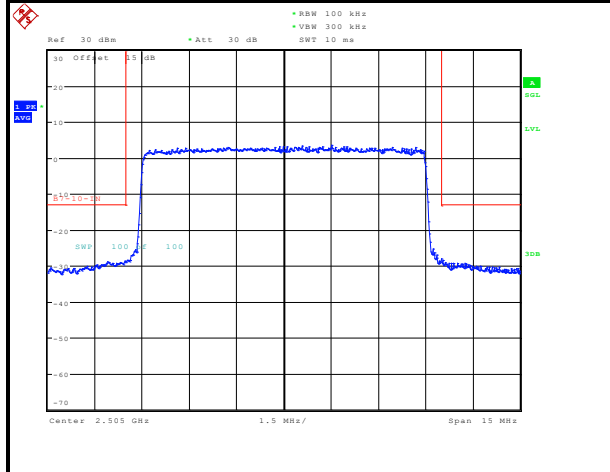

Date: 7.APR.2014 09:05:59

Date: 7.APR.2014 09:08:13

CHANNEL	20800	50 RB	CHANNEL	21400	50 RB
---------	-------	-------	---------	-------	-------

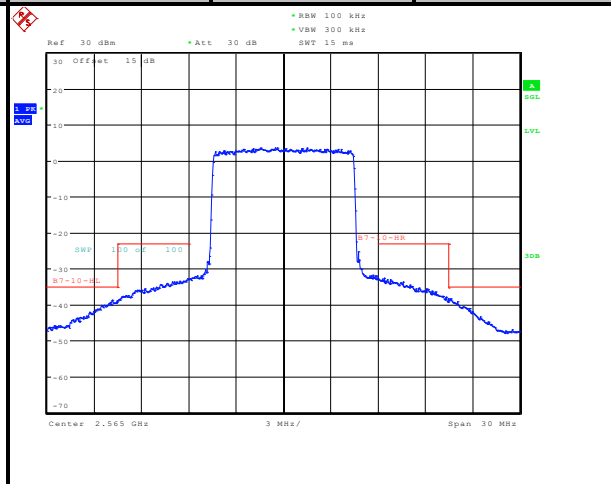
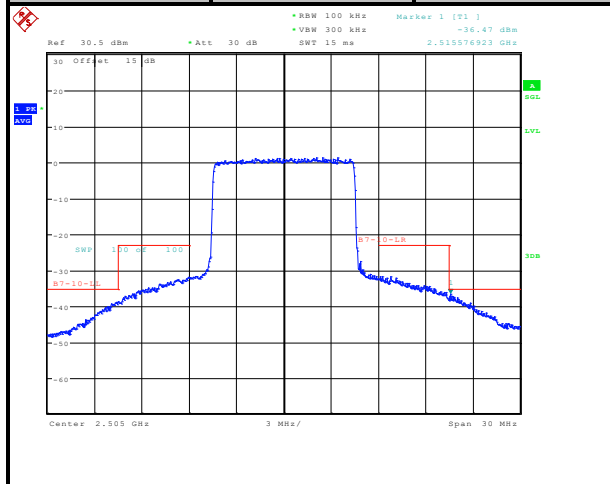

Date: 8.APR.2014 11:51:03

Date: 7.APR.2014 09:09:21

Note: Limit has been adjusted by $10 \cdot \log(\text{RBW})$ to reflect a 1MHz measurement bandwidth.

Note: Limit has been adjusted by $10 \cdot \log(\text{RBW})$ to reflect a 1MHz measurement bandwidth.



A D T

LTE BAND 7
Channel Bandwidth: 15MHz / 16QAM

CHANNEL	20825	75 RB	CHANNEL	21375	75 RB
----------------	--------------	--------------	----------------	--------------	--------------

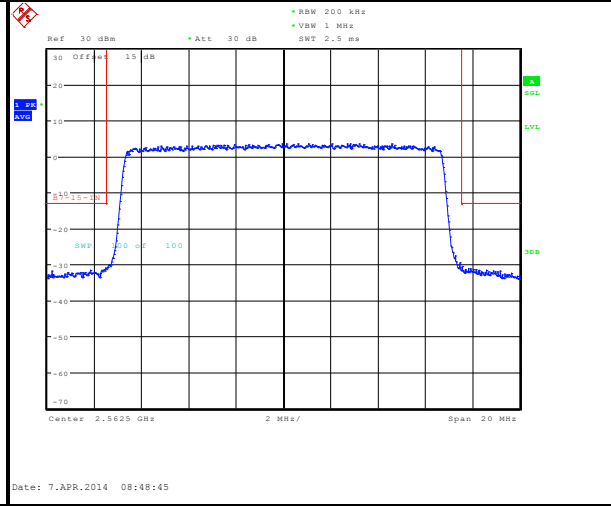
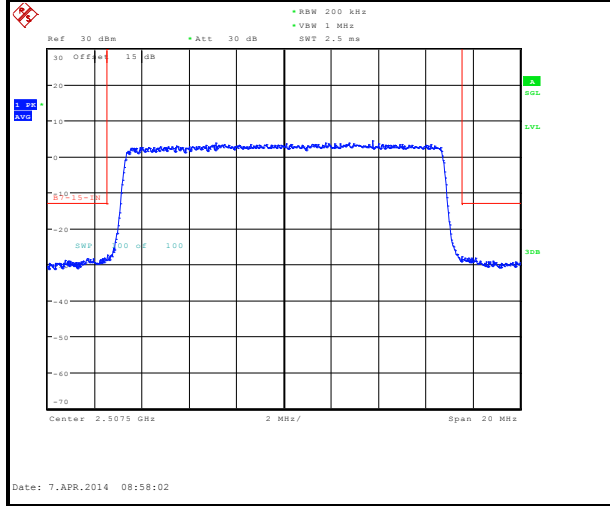

CHANNEL	20825	75 RB	CHANNEL	21375	75 RB
----------------	--------------	--------------	----------------	--------------	--------------

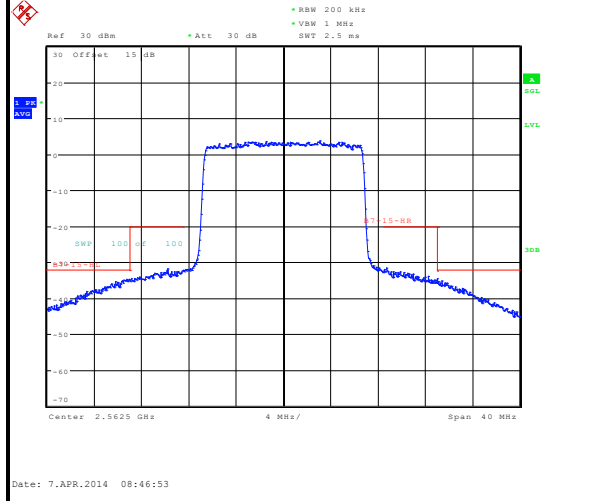
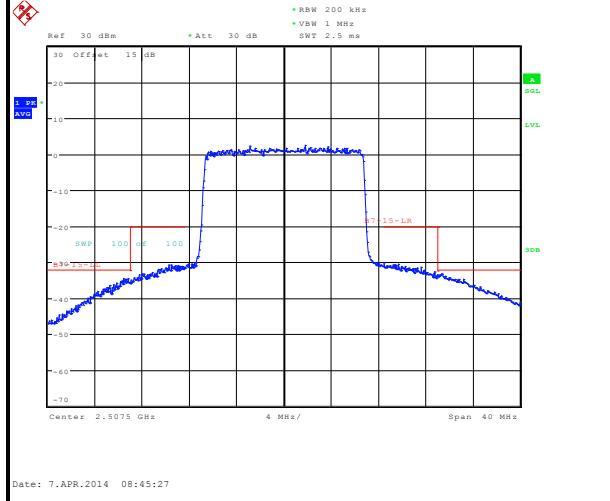

Note: Limit has been adjusted by $10 \cdot \log(\text{RBW})$ to reflect a 1MHz measurement bandwidth.

Note: Limit has been adjusted by $10 \cdot \log(\text{RBW})$ to reflect a 1MHz measurement bandwidth.



A D T

LTE BAND 7

Channel Bandwidth: 20MHz / QPSK

CHANNEL	20850	100 RB	CHANNEL	21350	100 RB
----------------	--------------	---------------	----------------	--------------	---------------

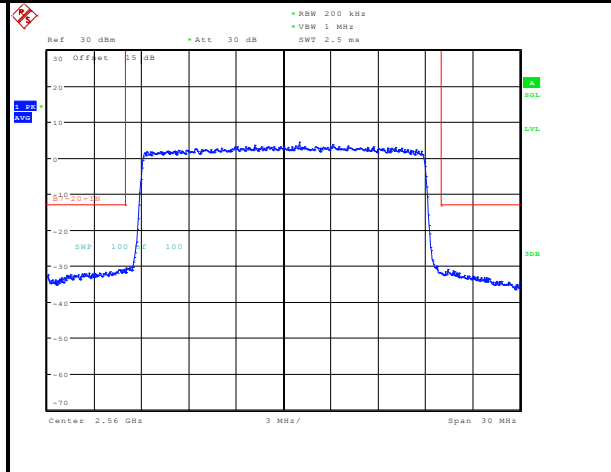
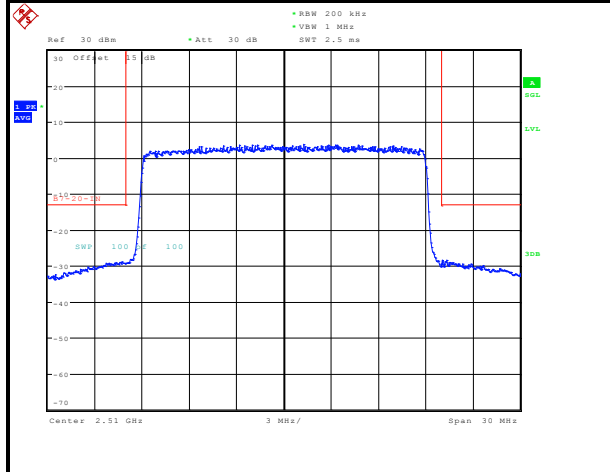

Date: 7.APR.2014 08:39:06

Date: 7.APR.2014 08:37:52

CHANNEL	20850	100 RB	CHANNEL	21350	100 RB
----------------	--------------	---------------	----------------	--------------	---------------

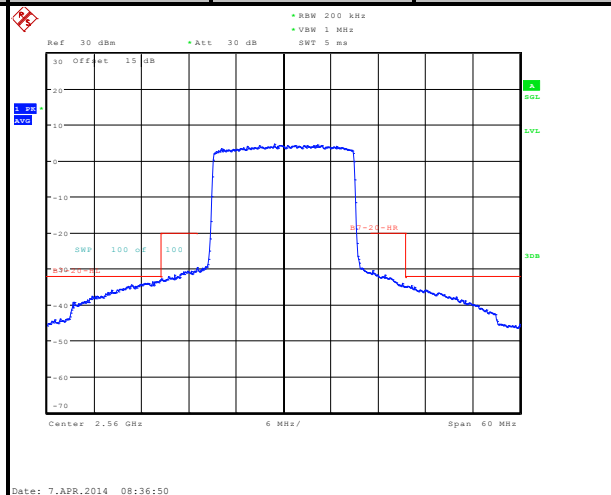
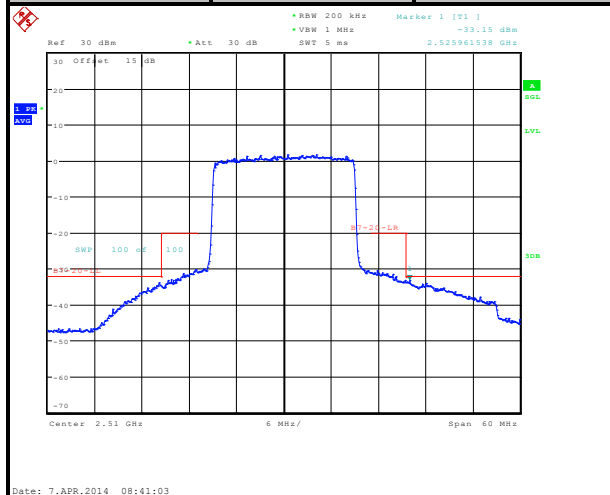

Date: 7.APR.2014 08:41:03

Date: 7.APR.2014 08:36:50

Note: Limit has been adjusted by $10 \cdot \log(\text{RBW})$ to reflect a 1MHz measurement bandwidth.

Note: Limit has been adjusted by $10 \cdot \log(\text{RBW})$ to reflect a 1MHz measurement bandwidth.



A D T

LTE BAND 7

Channel Bandwidth: 20MHz / 16QAM

CHANNEL | 20850 | 100 RB

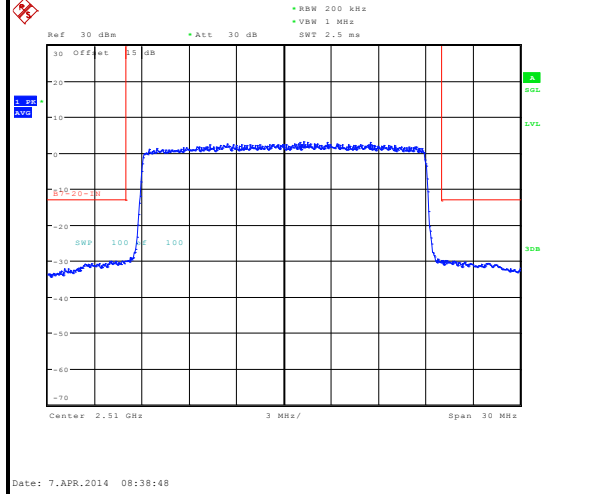

CHANNEL | 21350 | 100 RB

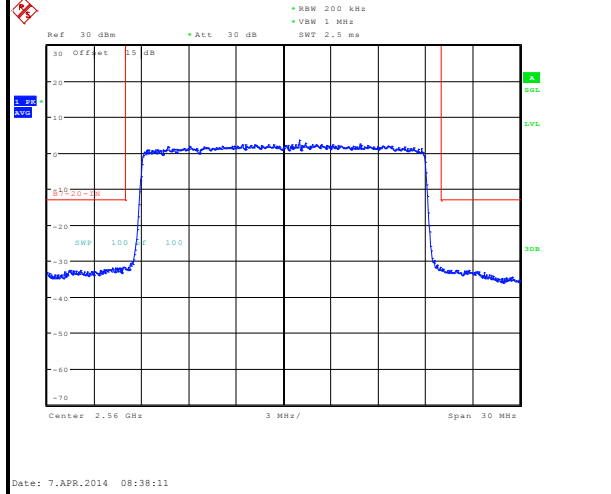

CHANNEL | 20850 | 100 RB

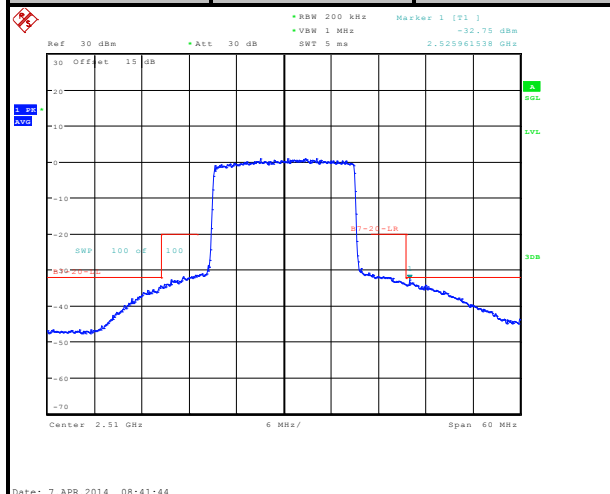

CHANNEL | 21350 | 100 RB

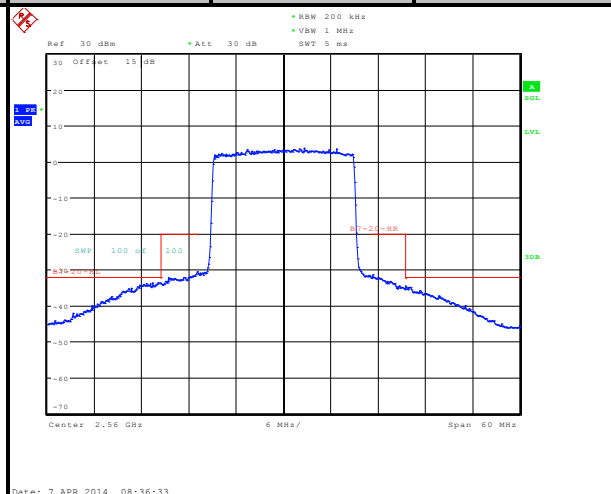

Note: Limit has been adjusted by $10 \cdot \log(\text{RBW})$ to reflect a 1MHz measurement bandwidth.

Note: Limit has been adjusted by $10 \cdot \log(\text{RBW})$ to reflect a 1MHz measurement bandwidth.

4.6 CONDUCTED SPURIOUS EMISSIONS

4.6.1 LIMITS OF CONDUCTED SPURIOUS EMISSIONS MEASUREMENT

The power of any emission outside a licensee's frequency block shall be attenuated below the transmitter power (P) by at least $55 + 10 \log_{10}(P)$ dB. The limit of emission is equal to -25dBm.

4.6.2 TEST PROCEDURE

- a. The EUT makes a phone call to the communication simulator. All measurements were done at low, middle and high operational frequency range.
- b. Measuring frequency range is from 30MHz to 26GHz for LTE Band 7. 10dB attenuation pad is connected with spectrum. RBW=1MHz and VBW=3MHz are used for conducted emission measurement.

4.6.3 TEST SETUP

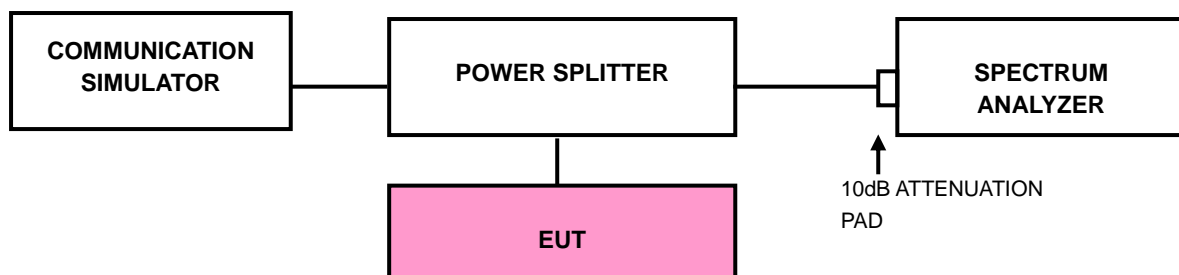



A D T

4.6.4 TEST RESULTS

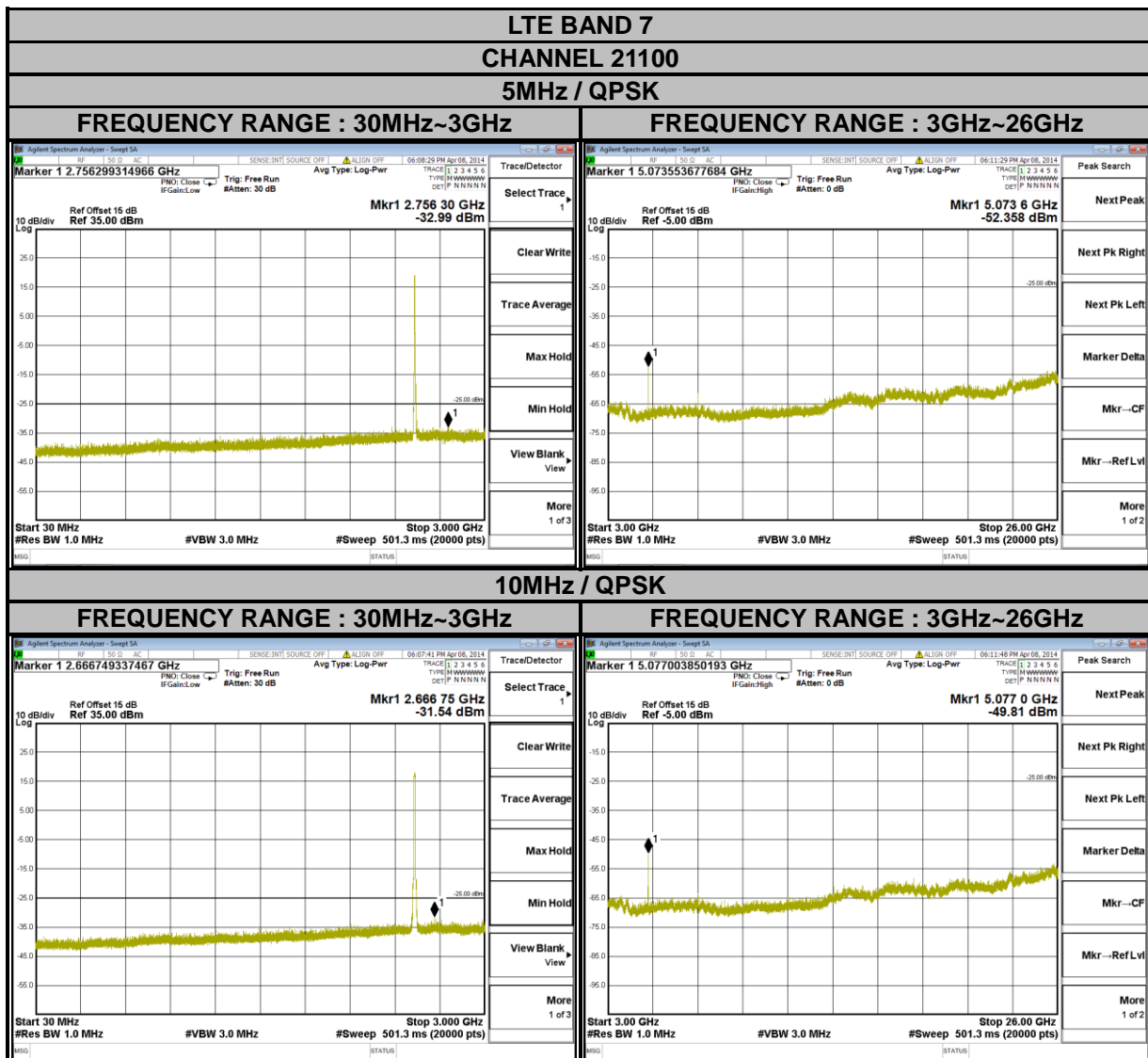



A D T

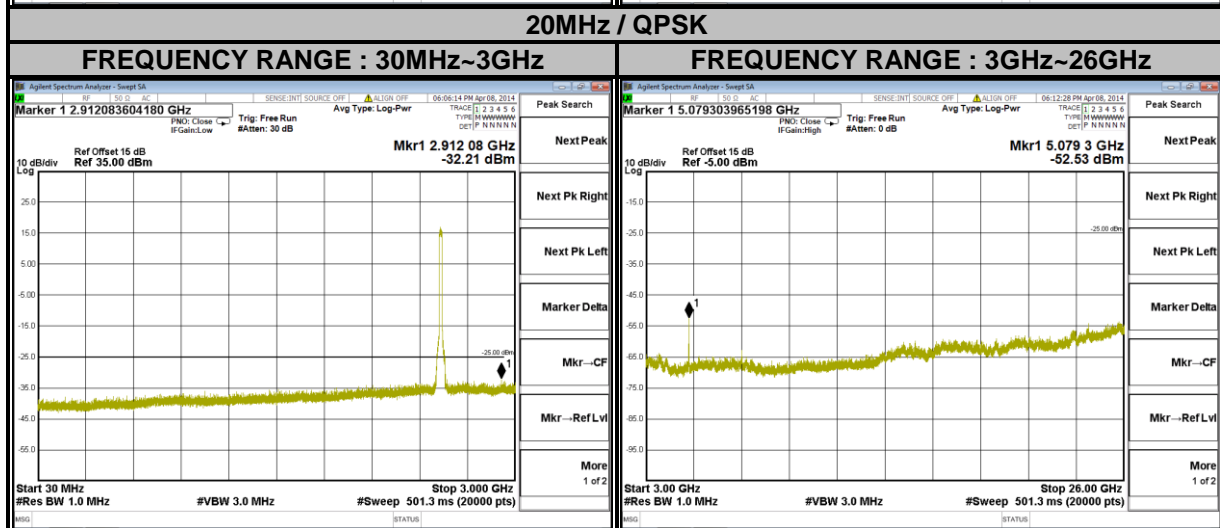
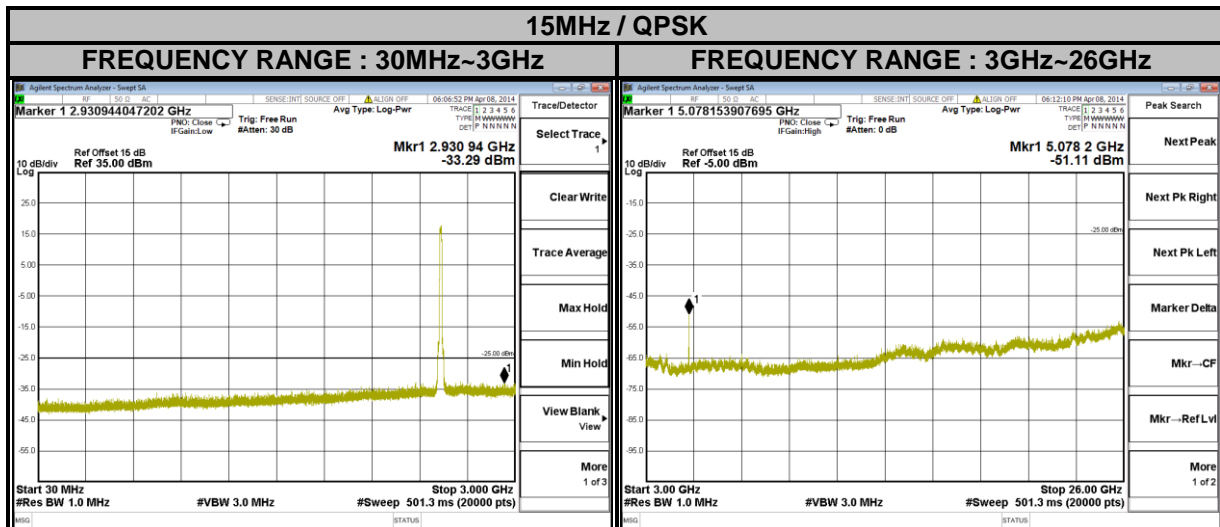

4.7 RADIATED EMISSION MEASUREMENT

4.7.1 LIMITS OF RADIATED EMISSION MEASUREMENT

The power of any emission outside a licensee's frequency block shall be attenuated below the transmitter power (P) by at least $55 + 10 \log_{10}(P)$ dB. The limit of emission is equal to -25dBm.

4.7.2 TEST PROCEDURES

- a. Substitution method is used for E.I.R.P measurement. In the semi-anechoic chamber, EUT placed on the 0.8m height of Turn Table, rotated the table around 360 degrees to search the maximum radiation power and receiver antenna shall be rotated vertical and horizontal polarization and moved height from 1m to 4m to find the maximum polar radiated power. The "Read Value" is the spectrum reading the maximum power value.
- b. The substitution horn antenna is substituted for EUT at the same position and signals generator export the CW signal to the substitution antenna via a TX cable. Rotated the Turn Table and moved receiving antenna to find the maximum radiation power. Adjust output power level of S.G to get a Value of spectrum reading equal to "Read Value " of step a. Record the power level of S.G.
- c. $EIRP = \text{Output power level of S.G} - \text{TX cable loss} + \text{Antenna gain of substitution horn}$.
- d. E.R.P power can be calculated form E.I.R.P power by subtracting the gain of dipole, $E.R.P \text{ power} = E.I.P.R \text{ power} - 2.15dBi$.

NOTE: The resolution bandwidth of spectrum analyzer is 1 MHz and the video bandwidth is 3 MHz.

4.7.3 DEVIATION FROM TEST STANDARD

No deviation

4.7.4 TEST SETUP

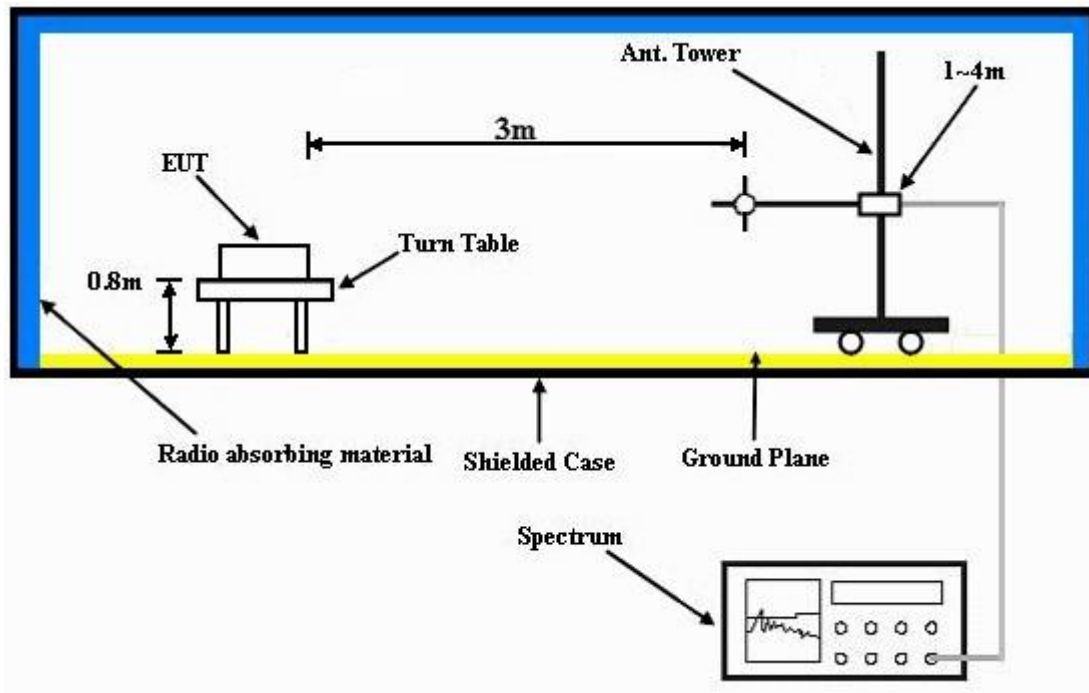

For the actual test configuration, please refer to the attached file (Test Setup Photo).

4.7.5 TEST RESULTS

LTE BAND 7

CHANNEL BANDWIDTH: 5MHz / QPSK



Bureau Veritas Consumer Products Services Ltd., Taoyuan Branch

A D T

Data: 13

Date: 2014-03-25

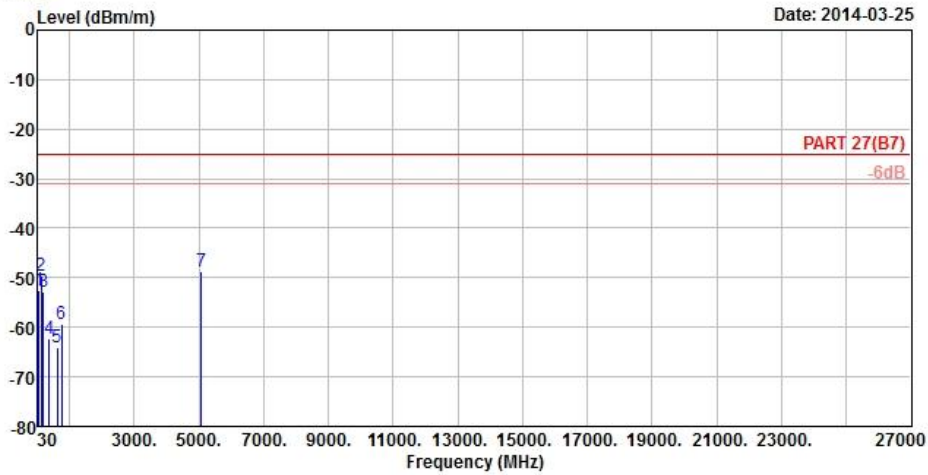

Site : 966 Chamber 5
 Condition : PART 27(B7) 3m HORIZONTAL
 Brand/Model: 0P8B200
 Remark : LTE Band 7_5M_QPSK(1,24) Link
 Tested by : Johnson Liao
 Plane : Y

	Freq	Level	Read Level	Limit	Over	Factor	Remark
	MHz	dBm/m	dBm	dBm/m	dB	dB/m	
1	57.27	-52.69	-47.04	-25.00	-27.69	-5.65	Peak
2	138.54	-49.62	-43.69	-25.00	-24.62	-5.93	Peak
3	193.35	-52.92	-45.77	-25.00	-27.92	-7.15	Peak
4	371.40	-62.24	-56.39	-25.00	-37.24	-5.85	Peak
5	631.80	-64.07	-64.28	-25.00	-39.07	0.21	Peak
6	771.10	-59.48	-61.41	-25.00	-34.48	1.93	Peak
7 pp	5074.40	-48.78	-45.48	-25.00	-23.78	-3.30	Peak



A D T



Bureau Veritas Consumer Products Services Ltd., Taoyuan Branch

A D T

Data: 14

Date: 2014-03-25

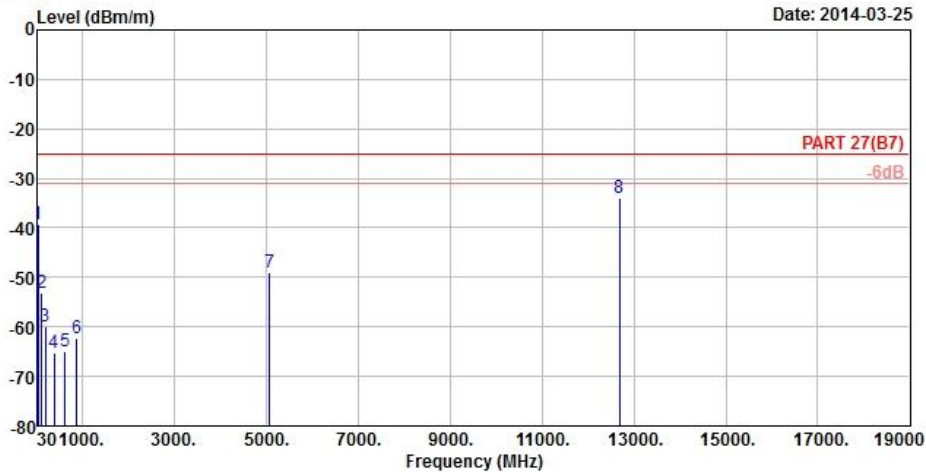

Site : 966 Chamber 5
 Condition : PART 27(B7) 3m VERTICAL
 Brand/Model: 0P8B200
 Remark : LTE Band 7_5M_QPSK(1,24) Link
 Tested by : Johnson Liao
 Plane : Y

	Freq	Level	Read Level	Limit	Over	Factor	Remark
	MHz	dBm/m	dBm	dBm/m	dB	dB/m	
1	40.53	-39.12	-37.66	-25.00	-14.12	-1.46	Peak
2	112.35	-53.12	-42.45	-25.00	-28.12	-10.67	Peak
3	187.41	-60.01	-53.54	-25.00	-35.01	-6.47	Peak
4	379.10	-65.24	-59.45	-25.00	-40.24	-5.79	Peak
5	626.20	-64.81	-64.93	-25.00	-39.81	0.12	Peak
6	873.30	-62.35	-64.90	-25.00	-37.35	2.55	Peak
7	5074.40	-48.91	-45.61	-25.00	-23.91	-3.30	Peak
8	12686.00	-33.84	-43.41	-25.00	-8.84	9.57	Peak



A D T

CHANNEL BANDWIDTH: 10MHZ / QPSK



Bureau Veritas Consumer Products Services Ltd., Taoyuan Branch

A D T

Data: 9

Date: 2014-03-25

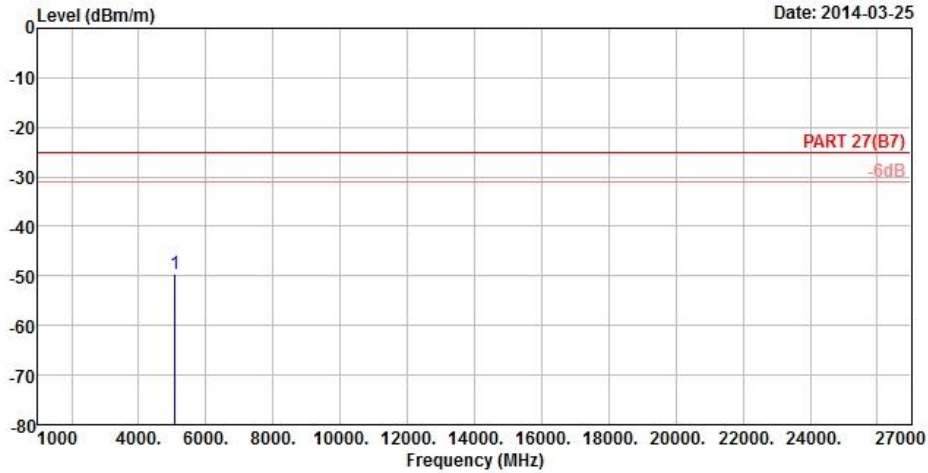

Site : 966 Chamber 5
 Condition : PART 27(B7) 3m HORIZONTAL
 Brand/Model: 0P8B200
 Remark : LTE Band 7_10M_QPSK(1,49) Link
 Tested by : Anson Lin
 Plane : Y

	Read	Limit	Over			
Freq	Level	Level	Line	Limit	Factor	Remark
MHz	dBm/m	dBm	dBm/m	dB	dB/m	
1 pp 5078.80	-49.51	-46.11	-25.00	-24.51	-3.40	Peak



A D T



Bureau Veritas Consumer Products Services Ltd., Taoyuan Branch

A D T

Data: 10

Date: 2014-03-25

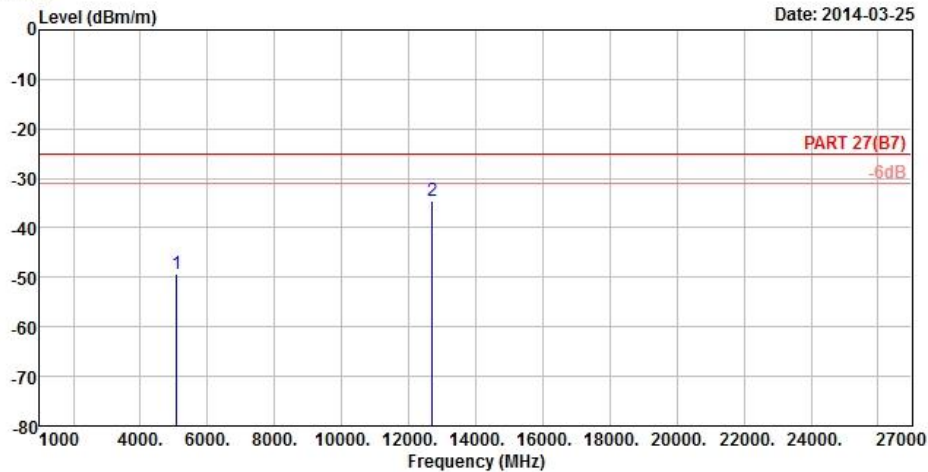

Site : 966 Chamber 5
 Condition : PART 27(B7) 3m VERTICAL
 Brand/Model: 0P8B200
 Remark : LTE Band 7_10M_QPSK(1,49) Link
 Tested by : Anson Lin
 Plane : Y

	Freq	Level	Read Level	Limit Line	Over Limit	Factor	Remark
	MHz	dBm/m	dBm	dBm/m	dB	dB/m	
1	5078.80	-49.40	-46.00	-25.00	-24.40	-3.40	Peak
2 pp	12697.00	-34.45	-44.06	-25.00	-9.45	9.61	Peak



A D T

CHANNEL BANDWIDTH: 15MHZ / QPSK



Bureau Veritas Consumer Products Services Ltd., Taoyuan Branch

A D T

Data: 9

Date: 2014-03-25

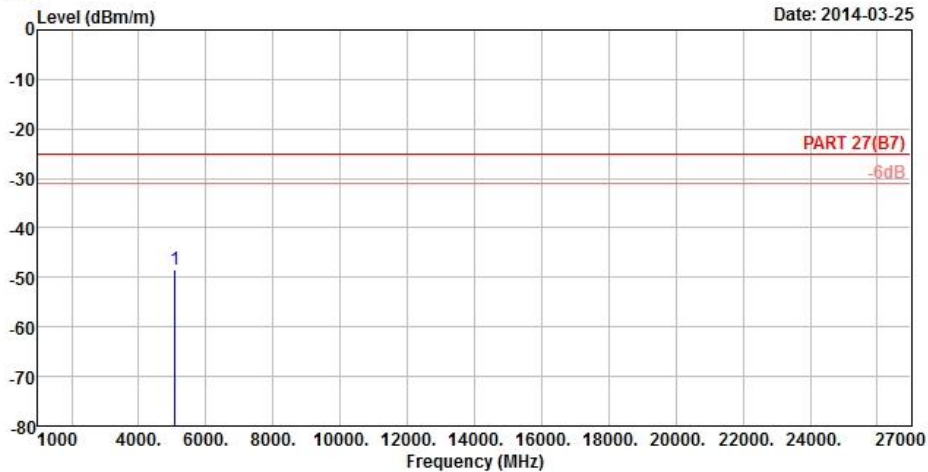

Site : 966 Chamber 5
 Condition : PART 27(B7) 3m HORIZONTAL
 Brand/Model: 0P8B200
 Remark : LTE Band 7_15M_QPSK(1,74) Link
 Tested by : Anson Lin
 Plane : Y

	Read	Limit	Over			
Freq	Level	Level	Line	Limit	Factor	Remark
MHz	dBm/m	dBm	dBm/m	dB	dB/m	
1 pp 5083.20	-48.37	-44.97	-25.00	-23.37	-3.40	Peak



A D T



Bureau Veritas Consumer Products Services Ltd., Taoyuan Branch

A D T

Data: 10

Date: 2014-03-25

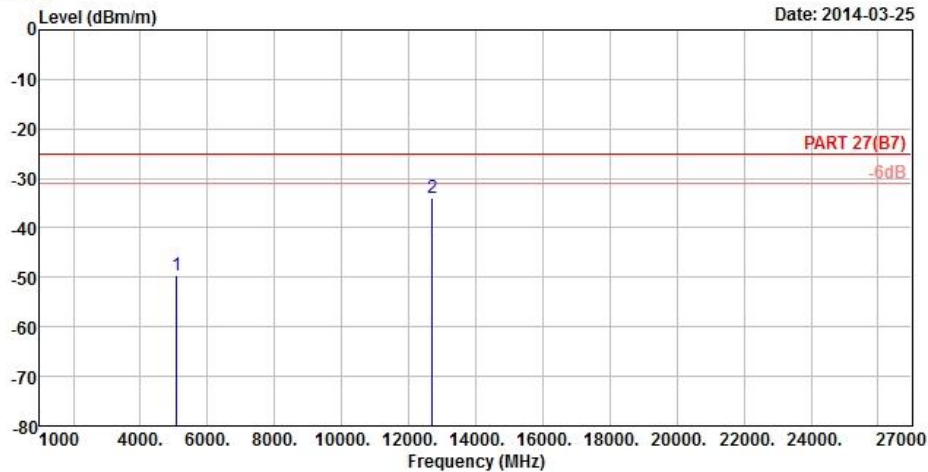

Site : 966 Chamber 5
 Condition : PART 27(B7) 3m VERTICAL
 Brand/Model: 0P8B200
 Remark : LTE Band 7_15M_QPSK(1,74) Link
 Tested by : Anson Lin
 Plane : Y

	Freq	Level	Read Level	Limit Line	Over Limit	Factor	Remark
	MHz	dBm/m	dBm	dBm/m	dB	dB/m	
1	5083.20	-49.68	-46.28	-25.00	-24.68	-3.40	Peak
2	pp 12708.00	-33.97	-43.58	-25.00	-8.97	9.61	Peak



A D T

CHANNEL BANDWIDTH: 20MHZ / QPSK



Bureau Veritas Consumer Products Services Ltd., Taoyuan Branch

A D T

Data: 9

Date: 2014-03-25

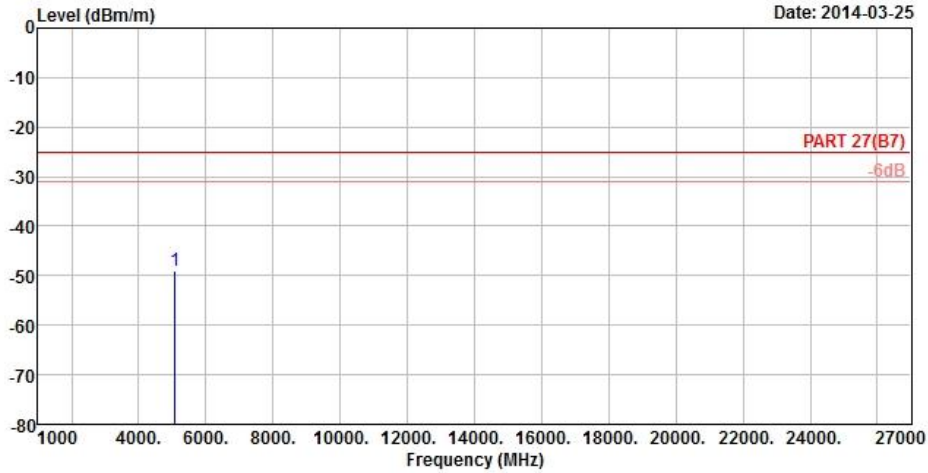

Site : 966 Chamber 5
 Condition : PART 27(B7) 3m HORIZONTAL
 Brand/Model: 0P8B200
 Remark : LTE Band 7_20M_QPSK(1,99) Link
 Tested by : Anson Lin
 Plane : Y

	Read	Limit	Over			
Freq	Level	Level	Line	Limit	Factor	Remark
MHz	dBm/m	dBm	dBm/m	dB	dB/m	
1 pp 5087.60	-49.11	-45.71	-25.00	-24.11	-3.40	Peak



A D T



Bureau Veritas Consumer Products Services Ltd., Taoyuan Branch

A D T

Data: 10

Date: 2014-03-25

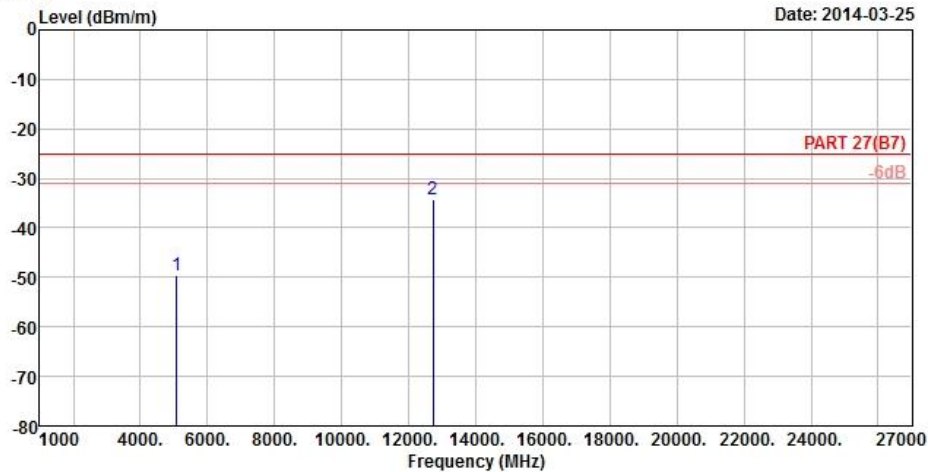

Site : 966 Chamber 5
 Condition : PART 27(B7) 3m VERTICAL
 Brand/Model: 0P8B200
 Remark : LTE Band 7_20M_QPSK(1,99) Link
 Tested by : Anson Lin
 Plane : Y

	Freq	Level	Read Level	Limit Line	Over Limit	Factor	Remark
	MHz	dBm/m	dBm	dBm/m	dB	dB/m	
1	5087.60	-49.48	-46.08	-25.00	-24.48	-3.40	Peak
2 pp	12719.00	-34.20	-43.85	-25.00	-9.20	9.65	Peak



5 INFORMATION ON THE TESTING LABORATORIES

We, Bureau Veritas Consumer Products Services (H.K.) Ltd., Taoyuan Branch, were founded in 1988 to provide our best service in EMC, Radio, Telecom and Safety consultation. Our laboratories are accredited and approved according to ISO/IEC 17025.

If you have any comments, please feel free to contact us at the following:

Linko EMC/RF Lab:

Tel: 886-2-26052180

Fax: 886-2-26051924

Hsin Chu EMC/RF Lab:

Tel: 886-3-5935343

Fax: 886-3-5935342

Hwa Ya EMC/RF/Safety/Telecom Lab:

Tel: 886-3-3183232

Fax: 886-3-3270892

Email: service.adt@tw.bureauveritas.com

Web Site: www.adt.com.tw

The address and road map of all our labs can be found in our web site also.



A D T

6 APPENDIX A – MODIFICATIONS RECORDERS FOR ENGINEERING CHANGES TO THE EUT BY THE LAB

No modifications were made to the EUT by the lab during the test.

---END---