



FCC TEST REPORT (PART 27)

REPORT NO.: RF140303C07-8

MODEL NO.: 0P8B100

FCC ID: NM80P8B100

RECEIVED: Mar. 03, 2014

TESTED: Mar. 17, 2014 ~ Apr. 07, 2014

ISSUED: Apr. 15, 2014

APPLICANT: HTC Corporation

ADDRESS: 1F, 6-3 Baoqiang Road, Xindian District, New Taipei City, Taiwan 231

ISSUED BY: Bureau Veritas Consumer Products Services (H.K.) Ltd., Taoyuan Branch

LAB ADDRESS: No. 47, 14th Ling, Chia Pau Vil., Lin Kou Dist., New Taipei City, Taiwan, R.O.C.

TEST LOCATION: No. 19, Hwa Ya 2nd Rd, Wen Hwa Tsuen, Kwei Shan Hsiang, Taoyuan Hsien 333, Taiwan, R.O.C.

This report should not be used by the client to claim product certification, approval, or endorsement by TAF or any government agencies.



This report is for your exclusive use. Any copying or replication of this report to or for any other person or entity, or use of our name or trademark, is permitted only with our prior written permission. This report sets forth our findings solely with respect to the test samples identified herein. The results set forth in this report are not indicative or representative of the quality or characteristics of the lot from which a test sample was taken or any similar or identical product unless specifically and expressly noted. Our report includes all of the tests requested by you and the results thereof based upon the information that you provided to us. You have 60 days from date of issuance of this report to notify us of any material error or omission caused by our negligence, provided, however, that such notice shall be in writing and shall specifically address the issue you wish to raise. A failure to raise such issue within the prescribed time shall constitute your unqualified acceptance of the completeness of this report, the tests conducted and the correctness of the report contents. Unless specifically mentioned, the uncertainty of measurement has been explicitly taken into account to declare the compliance or non-compliance to the specification.

TABLE OF CONTENTS

| | |
|--|----|
| RELEASE CONTROL RECORD..... | 3 |
| 1 CERTIFICATION | 4 |
| 2 SUMMARY OF TEST RESULTS..... | 5 |
| 2.1 MEASUREMENT UNCERTAINTY | 5 |
| 2.2 TEST SITE AND INSTRUMENTS | 6 |
| 3 GENERAL INFORMATION | 7 |
| 3.1 GENERAL DESCRIPTION OF EUT..... | 7 |
| 3.2 CONFIGURATION OF SYSTEM UNDER TEST | 8 |
| 3.3 DESCRIPTION OF SUPPORT UNITS..... | 8 |
| 3.4 DESCRIPTION OF TEST MODES..... | 9 |
| 3.5 GENERAL DESCRIPTION OF APPLIED STANDARDS | 11 |
| 4 TEST TYPES AND RESULTS..... | 12 |
| 4.1 OUTPUT POWER MEASUREMENT | 12 |
| 4.1.1 LIMITS OF OUTPUT POWER MEASUREMENT | 12 |
| 4.1.2 TEST PROCEDURES | 12 |
| 4.1.3 TEST SETUP | 13 |
| 4.1.4 TEST RESULTS | 14 |
| 4.2 FREQUENCY STABILITY MEASUREMENT | 19 |
| 4.2.1 LIMITS OF FREQUENCY STABILITY MEASUREMENT | 19 |
| 4.2.2 TEST PROCEDURE | 19 |
| 4.2.3 TEST SETUP | 19 |
| 4.2.4 TEST RESULTS | 20 |
| 4.3 OCCUPIED BANDWIDTH MEASUREMENT..... | 21 |
| 4.3.1 LIMITS OF OCCUPIED BANDWIDTH MEASUREMENT..... | 21 |
| 4.3.2 TEST SETUP | 21 |
| 4.3.3 TEST PROCEDURES | 21 |
| 4.3.4 TEST RESULTS | 22 |
| 4.4 PEAK TO AVERAGE RATIO..... | 24 |
| 4.4.1 LIMITS OF PEAK TO AVERAGE RATIO MEASUREMENT | 24 |
| 4.4.2 TEST SETUP | 24 |
| 4.4.3 TEST PROCEDURES..... | 24 |
| 4.4.4 TEST RESULTS | 25 |
| 4.5 BAND EDGE MEASUREMENT | 27 |
| 4.5.1 LIMITS OF BAND EDGE MEASUREMENT | 27 |
| 4.5.2 TEST SETUP | 27 |
| 4.5.3 TEST PROCEDURES..... | 28 |
| 4.5.4 TEST RESULTS | 29 |
| 4.6 CONDUCTED SPURIOUS EMISSIONS..... | 37 |
| 4.6.1 LIMITS OF CONDUCTED SPURIOUS EMISSIONS MEASUREMENT..... | 37 |
| 4.6.2 TEST PROCEDURE | 37 |
| 4.6.3 TEST SETUP | 37 |
| 4.6.4 TEST RESULTS | 38 |
| 4.7 RADIATED EMISSION MEASUREMENT | 40 |
| 4.7.1 LIMITS OF RADIATED EMISSION MEASUREMENT | 40 |
| 4.7.2 TEST PROCEDURES..... | 40 |
| 4.7.3 DEVIATION FROM TEST STANDARD..... | 40 |
| 4.7.4 TEST SETUP | 41 |
| 4.7.5 TEST RESULTS | 42 |
| 5 INFORMATION ON THE TESTING LABORATORIES | 50 |
| 6 APPENDIX A – MODIFICATIONS RECORDERS FOR ENGINEERING CHANGES TO THE EUT BY THE LAB..... | 51 |



A D T

RELEASE CONTROL RECORD

| ISSUE NO. | REASON FOR CHANGE | DATE ISSUED |
|---------------|-------------------|---------------|
| RF140303C07-8 | Original release | Apr. 15, 2014 |



1 CERTIFICATION

PRODUCT: Smartphone
MODEL NO.: 0P8B100
BRAND: HTC
APPLICANT: HTC Corporation
TESTED: Mar. 17, 2014 ~ Apr. 07, 2014
TEST SAMPLE: Production Unit
TEST STANDARDS: **FCC Part 27, Subpart C, M**
FCC Part 2
ANSI C63.4-2003

The above equipment (model: 0P8B100) has been tested by **Bureau Veritas Consumer Products Services (H.K.) Ltd., Taoyuan Branch**, and found compliance with the requirement of the above standards. The test record, data evaluation & Equipment Under Test (EUT) configurations represented herein are true and accurate accounts of the measurements of the sample's EMC characteristics under the conditions specified in this report.

PREPARED BY : Ivonne Wu , **DATE:** Apr. 15, 2014
Ivonne Wu / Supervisor

APPROVED BY : Sam Chen , **DATE:** Apr. 15, 2014
Sam Chen / Senior Project Engineer

2 SUMMARY OF TEST RESULTS

The EUT has been tested according to the following specifications:

| STANDARD SECTION | TEST TYPE AND LIMIT | RESULT | REMARK |
|--------------------|---|--------|--|
| 2.1046 27.50(h) | Equivalent Isotropically Radiated Power | PASS | Meet the requirement of limit. |
| 2.1055 27.54 | Frequency Stability | PASS | Meet the requirement of limit. |
| 2.1049 | Occupied Bandwidth | PASS | Meet the requirement of limit. |
| | Peak to average ratio | PASS | Meet the requirement of limit. |
| 2.1051 27.53(l) | Band Edge Measurements | PASS | Meet the requirement of limit. |
| 2.1051 27.53(l) | Conducted Spurious Emissions | PASS | Meet the requirement of limit. |
| 2.1053 27.53(l) | Radiated Spurious Emissions | PASS | Meet the requirement of limit. Minimum passing margin is -9.18dB at 5078.80MHz. |

2.1 MEASUREMENT UNCERTAINTY

Where relevant, the following measurement uncertainty levels have been estimated for tests performed on the EUT as specified in CISPR 16-4-2:

| MEASUREMENT | FREQUENCY | UNCERTAINTY |
|---------------------|-----------------|-------------|
| Conducted emissions | 150kHz~30MHz | 2.44 dB |
| Radiated emissions | 30MHz ~ 200MHz | 2.93 dB |
| | 200MHz ~1000MHz | 2.95 dB |
| | 1GHz ~ 18GHz | 2.26 dB |
| | 18GHz ~ 40GHz | 1.94 dB |

This uncertainty represents an expanded uncertainty expressed at approximately the 95% confidence level using a coverage factor of k=2.

2.2 TEST SITE AND INSTRUMENTS

| DESCRIPTION & MANUFACTURER | MODEL NO. | SERIAL NO. | DATE OF CALIBRATION | DUE DATE OF CALIBRATION |
|--|----------------|---------------------|---------------------|-------------------------|
| Test Receiver ROHDE & SCHWARZ | ESCI | 100744 | Apr. 15, 2013 | Apr. 14, 2014 |
| Spectrum Analyzer ROHDE & SCHWARZ | FSU43 | 101261 | Dec. 21, 2013 | Dec. 20, 2014 |
| BILOG Antenna SCHWARZBECK | VULB9168 | 9168-472 | Feb. 27, 2014 | Feb. 26, 2015 |
| HORN Antenna SCHWARZBECK | BBHA 9120 D | 9120D-969 | Feb. 19, 2014 | Feb. 18, 2015 |
| HORN Antenna SCHWARZBECK | BBHA 9170 | 9170-480 | Dec. 18, 2013 | Dec. 17, 2014 |
| Preamplifier EMCI | EMC 012645 | 980115 | Dec. 26, 2013 | Dec. 25, 2014 |
| Preamplifier EMCI | EMC 184045 | 980116 | Jan. 13, 2014 | Jan. 12, 2015 |
| Preamplifier EMCI | EMC 330H | 980112 | Dec. 27, 2013 | Dec. 26, 2014 |
| RF signal cable HUBER+SUHNNER | SUCOFLEX 104 | 309219/4 2950114 | Oct. 18, 2013 | Oct. 17, 2014 |
| RF signal cable HUBER+SUHNNER | SUCOFLEX 104 | 250130/4 | Oct. 18, 2013 | Oct. 17, 2014 |
| RF signal cable Worken | RG-213 | NA | Nov. 07, 2013 | Nov. 06, 2014 |
| Software BV ADT | E3 6.120103 | NA | NA | NA |
| Antenna Tower MF | MFA-440H | NA | NA | NA |
| Turn Table MF | MFT-201SS | NA | NA | NA |
| Antenna Tower & Turn Table Controller MF | MF-7802 | NA | NA | NA |
| Mini-Circuits Power Splitter | ZN2PD-9G | NA | Jul. 18, 2013 | Jul. 17, 2014 |
| JFW 20dB attenuation | 50HF-020-SMA | NA | NA | NA |
| Communications Tester-Wireless | E5515C | MY52102544 | Sep. 05, 2012 | Sep. 04, 2014 |
| Radio Communication Analyzer | MT8820C | 6201300640 | Aug. 01, 2013 | Jul. 31, 2014 |

- NOTE:** 1. The calibration interval of the above test instruments is 12 months and the calibrations are traceable to NML/ROC and NIST/USA.
2. The test was performed in HwaYa Chamber 10.
3. The horn antenna and HP preamplifier (model: 8449B) are used only for the measurement of emission frequency above 1GHz if tested.
4. The FCC Site Registration No. is 690701.
5. The IC Site Registration No. is IC 7450F-10.

3 GENERAL INFORMATION

3.1 GENERAL DESCRIPTION OF EUT

| | | |
|------------------------------|--|-----------------------|
| PRODUCT | Smartphone | |
| MODEL NO. | 0P8B100 | |
| POWER SUPPLY | 5Vdc (adapter or host equipment) 3.8Vdc (battery) | |
| MODULATION TECHNOLOGY | LTE Band 7 | QPSK, 16QAM |
| FREQUENCY RANGE | LTE Band 7 Channel Bandwidth: 5MHz | 2502.5MHz ~ 2567.5MHz |
| | LTE Band 7 Channel Bandwidth: 10MHz | 2505MHz ~ 2565MHz |
| | LTE Band 7 Channel Bandwidth: 15MHz | 2507.5MHz ~ 2562.5MHz |
| | LTE Band 7 Channel Bandwidth: 20MHz | 2510MHz ~ 2560MHz |
| EMISSION DESIGNATOR | LTE Band 7 Channel Bandwidth: 5MHz | 4M50G7D |
| | LTE Band 7 Channel Bandwidth: 10MHz | 8M92G7D |
| | LTE Band 7 Channel Bandwidth: 15MHz | 13M4G7D |
| | LTE Band 7 Channel Bandwidth: 20MHz | 17M8G7D |
| MAX. EIRP POWER | LTE Band 7 Channel Bandwidth: 5MHz | 141.81mW |
| | LTE Band 7 Channel Bandwidth: 10MHz | 129.03mW |
| | LTE Band 7 Channel Bandwidth: 15MHz | 143.78mW |
| | LTE Band 7 Channel Bandwidth: 20MHz | 134.90mW |
| ANTENNA TYPE | Fixed Internal Antenna | |
| DATA CABLE | Refer to Note as below | |
| I/O PORTS | Refer to users' manual | |
| ACCESSORY DEVICES | Refer to Note as below | |

NOTE:

1. The EUT's accessories list refers to Ext. Pho.
2. The above EUT information is declared by manufacturer and for more detailed features description, please refer to the manufacturer's specifications or User's Manual.

3.2 CONFIGURATION OF SYSTEM UNDER TEST FOR RADIATION EMISSION TEST

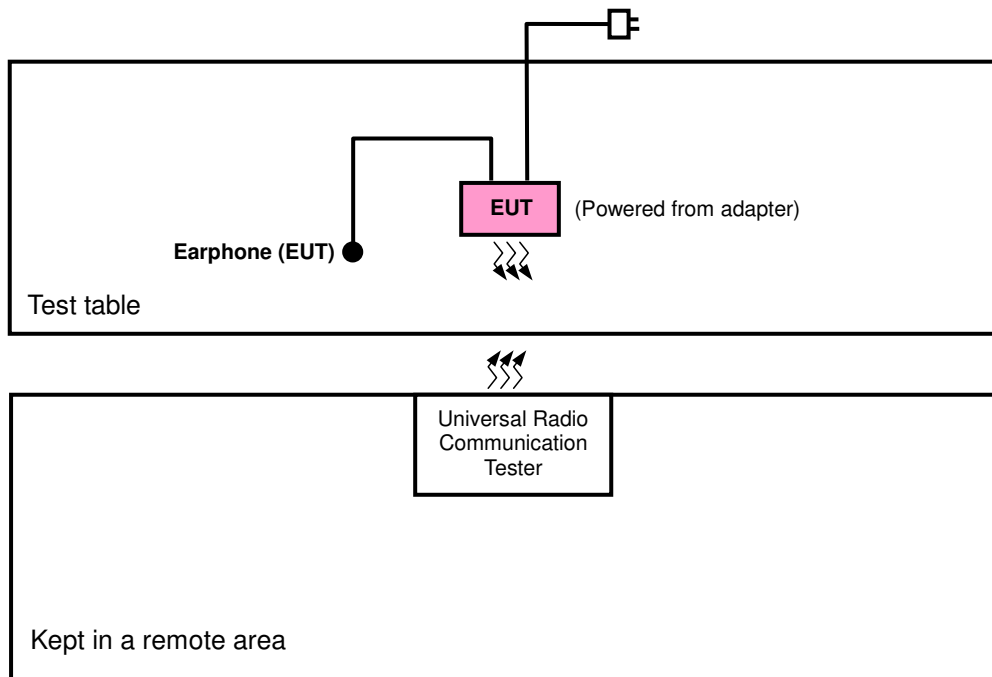

FOR E.I.R.P. TEST

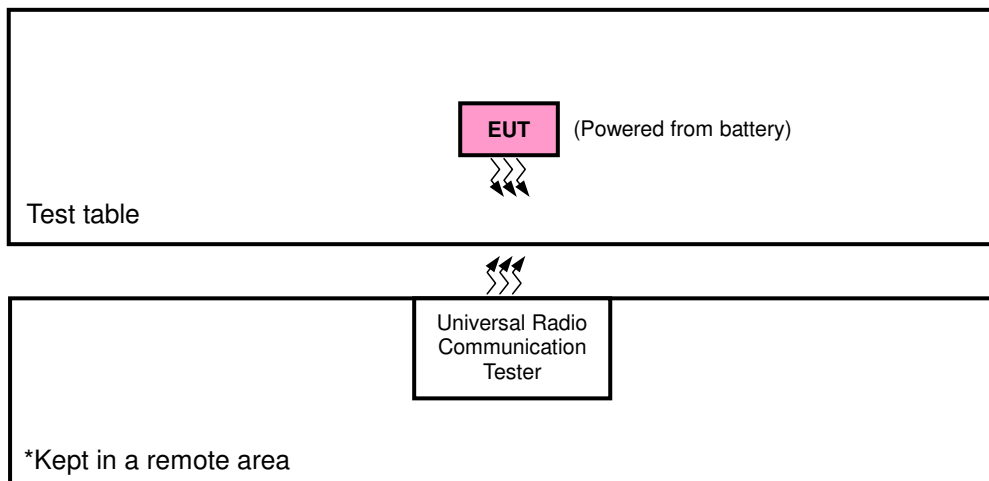

3.3 DESCRIPTION OF SUPPORT UNITS

The EUT has been tested as an independent unit together with other necessary accessories or support units.

3.4 DESCRIPTION OF TEST MODES

Pre-Scan has been conducted to determine the worst-case mode from all possible combinations between available modulations, data rates, XYZ axis and antenna ports. The worst case was found when positioned on X-plane for EIRP and Y-axis for radiated emission. Following channel(s) was (were) selected for the final test as listed below:

LTE BAND 7

| EUT CONFIGURE MODE | TEST ITEM | AVAILABLE CHANNEL | TESTED CHANNEL | CHANNEL BANDWIDTH | MODULATION | MODE |
|--------------------|-----------------------|-------------------|---------------------|-------------------|-------------|----------------------|
| - | EIRP | 20775 to 21425 | 20775, 21100, 21425 | 5MHz | QPSK, 16QAM | 1 RB / 24 RB Offset |
| | | 20800 to 21400 | 20800, 21100, 21400 | 10MHz | QPSK, 16QAM | 1 RB / 49 RB Offset |
| | | 20825 to 21375 | 20825, 21100, 21375 | 15MHz | QPSK, 16QAM | 1 RB / 49 RB Offset |
| | | 20850 to 21350 | 20850, 21100 21350 | 20MHz | QPSK, 16QAM | 1 RB / 49 RB Offset |
| - | FREQUENCY STABILITY | 20775 to 21425 | 21100 | 5MHz | QPSK | 1 RB / 24 RB Offset |
| | | 20800 to 21400 | 21100 | 10MHz | QPSK | 1 RB / 49 RB Offset |
| | | 20825 to 21375 | 21100 | 15MHz | QPSK | 1 RB / 49 RB Offset |
| | | 20850 to 21350 | 21100 | 20MHz | QPSK | 1 RB / 49 RB Offset |
| - | OCCUPIED BANDWIDTH | 20775 to 21425 | 20775, 21100, 21425 | 5MHz | QPSK, 16QAM | 25 RB / 0 RB Offset |
| | | 20800 to 21400 | 20800, 21100, 21400 | 10MHz | QPSK, 16QAM | 50 RB / 0 RB Offset |
| | | 20825 to 21375 | 20825, 21100, 21375 | 15MHz | QPSK, 16QAM | 75 RB / 0 RB Offset |
| | | 20850 to 21350 | 20850, 21100 21350 | 20MHz | QPSK, 16QAM | 100 RB / 0 RB Offset |
| - | PEAK TO AVERAGE RATIO | 20775 to 21425 | 20775, 21100, 21425 | 5MHz | QPSK, 16QAM | 1 RB / 24 RB Offset |
| | | 20800 to 21400 | 20800, 21100, 21400 | 10MHz | QPSK, 16QAM | 1 RB / 49 RB Offset |
| | | 20825 to 21375 | 20825, 21100, 21375 | 15MHz | QPSK, 16QAM | 1 RB / 74 RB Offset |
| | | 20850 to 21350 | 20850, 21100 21350 | 20MHz | QPSK, 16QAM | 1 RB / 99 RB Offset |
| - | BAND EDGE | 20775 to 21425 | 20775, 21425 | 5MHz | QPSK, 16QAM | 25 RB / 0 RB Offset |
| | | 20800 to 21400 | 20800, 21400 | 10MHz | QPSK, 16QAM | 50 RB / 0 RB Offset |
| | | 20825 to 21375 | 20825, 21375 | 15MHz | QPSK, 16QAM | 75 RB / 0 RB Offset |
| | | 20850 to 21350 | 20850, 21350 | 20MHz | QPSK, 16QAM | 100 RB / 0 RB Offset |
| - | CONDCUETED EMISSION | 20775 to 21425 | 21100 | 5MHz | QPSK | 1 RB / 24 RB Offset |
| | | 20800 to 21400 | 21100 | 10MHz | QPSK | 1 RB / 49 RB Offset |
| | | 20825 to 21375 | 21100 | 15MHz | QPSK | 1 RB / 74 RB Offset |
| | | 20850 to 21350 | 21100 | 20MHz | QPSK | 1 RB / 99 RB Offset |
| - | RADIATED EMISSION | 20775 to 21425 | 21100 | 5MHz | QPSK | 1 RB / 24 RB Offset |
| | | 20800 to 21400 | 21100 | 10MHz | QPSK | 1 RB / 49 RB Offset |
| | | 20825 to 21375 | 21100 | 15MHz | QPSK | 1 RB / 74 RB Offset |
| | | 20850 to 21350 | 21100 | 20MHz | QPSK | 1 RB / 99 RB Offset |

Note: This device was tested under all bandwidths, RB configurations and modulations. The worst case was found in QPSK modulation.



A D T

TEST CONDITION:

| TEST ITEM | ENVIRONMENTAL CONDITIONS | INPUT POWER | TESTED BY |
|-----------------------|--------------------------|--------------|--------------|
| ERP/EIRP | 26deg. C, 58%RH | 3.8Vdc | Howard Kao |
| FREQUENCY STABILITY | 26deg. C, 58%RH | 3.8Vdc | Howard Kao |
| OCCUPIED BANDWIDTH | 26deg. C, 58%RH | 3.8Vdc | Howard Kao |
| PEAK TO AVERAGE RATIO | 26deg. C, 58%RH | 3.8Vdc | Howard Kao |
| BAND EDGE | 26deg. C, 58%RH | 3.8Vdc | Howard Kao |
| CONDCUDED EMISSION | 26deg. C, 58%RH | 3.8Vdc | Howard Kao |
| RADIATED EMISSION | 25deg. C, 65%RH | 120Vac, 60Hz | Johnson Liao |



3.5 GENERAL DESCRIPTION OF APPLIED STANDARDS

The EUT is a RF product. According to the specifications of the manufacturer, it must comply with the requirements of the following standards:

FCC 47 CFR Part 2

FCC 47 CFR Part 27

ANSI C63.4-2003

ANSI/TIA/EIA-603-C 2004

NOTE: All test items have been performed and recorded as per the above standards.

4 TEST TYPES AND RESULTS

4.1 OUTPUT POWER MEASUREMENT

4.1.1 LIMITS OF OUTPUT POWER MEASUREMENT

The radiated peak output power shall be according to the specific rule Part 27.50(h)(2) that “User stations are limited to 2 watts” and 27.50(i) specific that “Peak transmit power must be measure over any interval of continuous transmission using instrumentation calibration in terms of rms-equivalent voltage.”

4.1.2 TEST PROCEDURES

EIRP MEASUREMENT:

- a. All measurements were done at low, middle and high operational frequency range. RBW and VBW is 10MHz for LTE mode.
- b. Substitution method is used for E.I.R.P measurement. In the semi-anechoic chamber, EUT placed on the 0.8m height of Turn Table, rotated the table around 360 degrees to search the maximum radiation power and receiver antenna shall be rotated vertical and horizontal polarization and moved height from 1m to 4m to find the maximum polar radiated power. The “Read Value” is the spectrum reading the maximum power value.
- c. The substitution horn antenna is substituted for EUT at the same position and signals generator export the CW signal to the substitution antenna via a tx cable. Rotated the Turn Table and moved receiving antenna to find the maximum radiation power. Adjust output power level of S.G to get a Value of spectrum reading equal to “Read Value” of step b. Record the power level of S.G.
- d. $EIRP = \text{Output power level of S.G} - \text{TX cable loss} + \text{Antenna gain of substitution horn}.$

CONDUCTED POWER MEASUREMENT:

- a. The EUT was set up for the maximum power with LTE link data modulation and link up with simulator.
- b. Set the EUT to transmit under low, middle and high channel and record the power level shown on simulator.

4.1.3 TEST SETUP

EIRP / ERP MEASUREMENT:

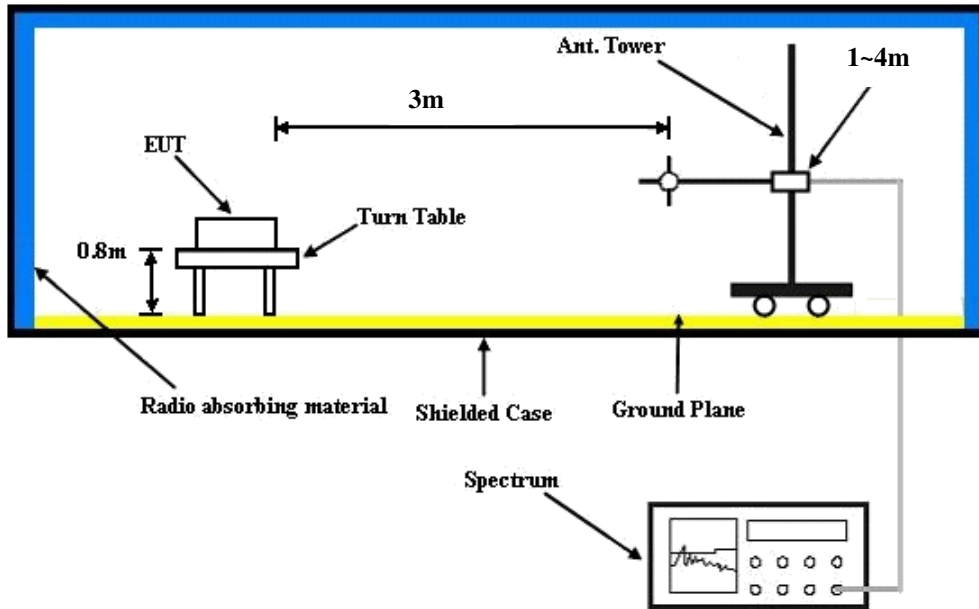

CONDUCTED POWER MEASUREMENT:

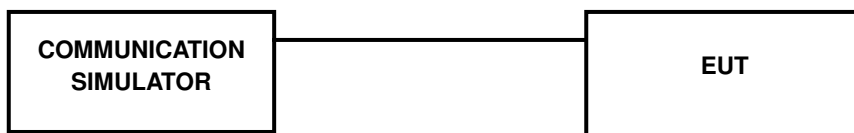

4.1.4 TEST RESULTS

AVERAGE CONDUCTED OUTPUT POWER (dBm)

| Band / BW | Modulation | RB Size | RB Offset | Low CH | Mid CH | High CH | 3PGG MPR (dB) |
|-----------|------------|---------|-----------|------------|-----------|------------|---------------|
| | | | | 20775 | 21100 | 21425 | |
| | | | | Frequency | Frequency | Frequency | |
| | | | | 2502.5 MHz | 2535 MHz | 2567.5 MHz | |
| 7 / 5M | QPSK | 1 | 0 | 22.47 | 22.55 | 22.22 | 0 |
| | | 1 | 12 | 22.55 | 22.73 | 22.39 | 0 |
| | | 1 | 24 | 22.63 | 22.76 | 22.40 | 0 |
| | | 12 | 0 | 21.56 | 21.75 | 21.34 | 1 |
| | | 12 | 6 | 21.57 | 21.80 | 21.49 | 1 |
| | | 12 | 13 | 21.64 | 21.79 | 21.55 | 1 |
| | | 25 | 0 | 21.57 | 21.80 | 21.47 | 1 |
| | 16QAM | 1 | 0 | 21.46 | 21.54 | 21.21 | 1 |
| | | 1 | 12 | 21.54 | 21.72 | 21.38 | 1 |
| | | 1 | 24 | 21.62 | 21.75 | 21.39 | 1 |
| | | 12 | 0 | 20.55 | 20.74 | 20.33 | 2 |
| | | 12 | 6 | 20.56 | 20.79 | 20.48 | 2 |
| | | 12 | 13 | 20.63 | 20.78 | 20.54 | 2 |
| | | 25 | 0 | 20.56 | 20.79 | 20.46 | 2 |

| Band / BW | Modulation | RB Size | RB Offset | Low CH | Mid CH | High CH | 3PGG MPR (dB) |
|-----------|------------|---------|-----------|-----------|-----------|-----------|---------------|
| | | | | 20800 | 21100 | 21140 | |
| | | | | Frequency | Frequency | Frequency | |
| | | | | 2505 MHz | 2535 MHz | 2565 MHz | |
| 7 / 10M | QPSK | 1 | 0 | 22.58 | 22.66 | 22.31 | 0 |
| | | 1 | 24 | 22.66 | 22.84 | 22.50 | 0 |
| | | 1 | 49 | 22.74 | 22.87 | 22.51 | 0 |
| | | 25 | 0 | 21.67 | 21.86 | 21.45 | 1 |
| | | 25 | 12 | 21.68 | 21.91 | 21.60 | 1 |
| | | 25 | 25 | 21.75 | 21.90 | 21.66 | 1 |
| | | 50 | 0 | 21.68 | 21.91 | 21.58 | 1 |
| | 16QAM | 1 | 0 | 21.57 | 21.65 | 21.30 | 1 |
| | | 1 | 24 | 21.65 | 21.83 | 21.49 | 1 |
| | | 1 | 49 | 21.73 | 21.86 | 21.50 | 1 |
| | | 25 | 0 | 20.66 | 20.85 | 20.44 | 2 |
| | | 25 | 12 | 20.67 | 20.90 | 20.59 | 2 |
| | | 25 | 25 | 20.74 | 20.89 | 20.65 | 2 |
| | | 50 | 0 | 20.67 | 20.90 | 20.57 | 2 |



A D T

| Band / BW | Modulation | RB Size | RB Offset | Low CH 20825 | Mid CH 21100 | High CH 21375 | 3PGG MPR (dB) |
|-----------|------------|---------|-----------|-------------------------|-----------------------|-------------------------|---------------------|
| | | | | Frequency 2507.5 MHz | Frequency 2535 MHz | Frequency 2562.5 MHz | |
| 7 / 15M | QPSK | 1 | 0 | 22.70 | 22.78 | 22.43 | 0 |
| | | 1 | 37 | 22.78 | 22.96 | 22.62 | 0 |
| | | 1 | 74 | 22.86 | 22.99 | 22.63 | 0 |
| | | 36 | 0 | 21.79 | 21.98 | 21.57 | 1 |
| | | 36 | 19 | 21.80 | 22.03 | 21.72 | 1 |
| | | 36 | 39 | 21.87 | 22.02 | 21.78 | 1 |
| | | 75 | 0 | 21.80 | 22.03 | 21.70 | 1 |
| | 16QAM | 1 | 0 | 21.69 | 21.77 | 21.42 | 1 |
| | | 1 | 37 | 21.77 | 21.95 | 21.61 | 1 |
| | | 1 | 74 | 21.85 | 21.98 | 21.62 | 1 |
| | | 36 | 0 | 20.78 | 20.97 | 20.56 | 2 |
| | | 36 | 19 | 20.79 | 21.02 | 20.71 | 2 |
| | | 36 | 39 | 20.86 | 21.01 | 20.77 | 2 |
| | | 75 | 0 | 20.79 | 21.02 | 20.69 | 2 |

| Band / BW | Modulation | RB Size | RB Offset | Low CH 20850 | Mid CH 21100 | High CH 21350 | 3PGG MPR (dB) |
|-----------|------------|---------|-----------|-----------------------|-----------------------|-----------------------|---------------------|
| | | | | Frequency 2510 MHz | Frequency 2535 MHz | Frequency 2560 MHz | |
| 7 / 20M | QPSK | 1 | 0 | 22.81 | 22.89 | 22.54 | 0 |
| | | 1 | 50 | 22.89 | 23.07 | 22.73 | 0 |
| | | 1 | 99 | 22.97 | 23.10 | 22.74 | 0 |
| | | 50 | 0 | 21.90 | 22.09 | 21.68 | 1 |
| | | 50 | 25 | 21.91 | 22.14 | 21.83 | 1 |
| | | 50 | 50 | 21.98 | 22.13 | 21.89 | 1 |
| | | 100 | 0 | 21.91 | 22.14 | 21.81 | 1 |
| | 16QAM | 1 | 0 | 21.80 | 21.88 | 21.53 | 1 |
| | | 1 | 50 | 21.88 | 22.06 | 21.72 | 1 |
| | | 1 | 99 | 21.96 | 22.09 | 21.73 | 1 |
| | | 50 | 0 | 20.89 | 21.08 | 20.67 | 2 |
| | | 50 | 25 | 20.90 | 21.13 | 20.82 | 2 |
| | | 50 | 50 | 20.97 | 21.12 | 20.88 | 2 |
| | | 100 | 0 | 20.90 | 21.13 | 20.80 | 2 |

AVERAGE EIRP (dBm)

| LTE Band 7 | | | | | | | |
|--------------------------------|---------|-----------------|-----------|-----------------------|-----------|----------|--------------------|
| Channel Bandwidth: 5MHz / QPSK | | | | | | | |
| Plane | Channel | Frequency (MHz) | LVL (dBm) | Correction Factor(dB) | EIRP(dBm) | EIRP(mW) | Polarization (H/V) |
| X | 20775 | 2502.5 | -23.07 | 44.24 | 21.17 | 130.86 | H |
| | 21100 | 2535.0 | -22.68 | 44.20 | 21.52 | 141.81 | |
| | 21425 | 2567.5 | -23.77 | 44.80 | 21.03 | 126.79 | |
| | 20775 | 2502.5 | -27.36 | 44.19 | 16.83 | 48.21 | V |
| | 21100 | 2535.0 | -27.83 | 44.09 | 16.26 | 42.25 | |
| | 21425 | 2567.5 | -27.67 | 44.50 | 16.83 | 48.18 | |

| LTE Band 7 | | | | | | | |
|---------------------------------|---------|-----------------|-----------|-----------------------|-----------|----------|--------------------|
| Channel Bandwidth: 5MHz / 16QAM | | | | | | | |
| Plane | Channel | Frequency (MHz) | LVL (dBm) | Correction Factor(dB) | EIRP(dBm) | EIRP(mW) | Polarization (H/V) |
| X | 20775 | 2502.5 | -24.15 | 44.24 | 20.09 | 102.05 | H |
| | 21100 | 2535.0 | -24.30 | 44.20 | 19.90 | 97.66 | |
| | 21425 | 2567.5 | -25.38 | 44.80 | 19.42 | 87.52 | |
| | 20775 | 2502.5 | -28.68 | 44.19 | 15.51 | 35.57 | V |
| | 21100 | 2535.0 | -28.22 | 44.09 | 15.87 | 38.62 | |
| | 21425 | 2567.5 | -29.39 | 44.50 | 15.11 | 32.43 | |

| LTE Band 7 | | | | | | | |
|---------------------------------|---------|-----------------|-----------|-----------------------|-----------|----------|--------------------|
| Channel Bandwidth: 10MHz / QPSK | | | | | | | |
| Plane | Channel | Frequency (MHz) | LVL (dBm) | Correction Factor(dB) | EIRP(dBm) | EIRP(mW) | Polarization (H/V) |
| X | 20800 | 2505.0 | -23.35 | 44.34 | 20.99 | 125.63 | H |
| | 21100 | 2535.0 | -23.09 | 44.20 | 21.11 | 129.03 | |
| | 21400 | 2565.0 | -23.88 | 44.72 | 20.84 | 121.42 | |
| | 20800 | 2505.0 | -27.55 | 44.23 | 16.68 | 46.52 | V |
| | 21100 | 2535.0 | -27.26 | 44.09 | 16.83 | 48.17 | |
| | 21400 | 2565.0 | -27.79 | 44.41 | 16.62 | 45.88 | |



A D T

| LTE Band 7 | | | | | | | |
|----------------------------------|---------|-----------------|-----------|-----------------------|-----------|----------|--------------------|
| Channel Bandwidth: 10MHz / 16QAM | | | | | | | |
| Plane | Channel | Frequency (MHz) | LVL (dBm) | Correction Factor(dB) | EIRP(dBm) | EIRP(mW) | Polarization (H/V) |
| X | 20800 | 2505.0 | -24.77 | 44.34 | 19.57 | 90.59 | H |
| | 21100 | 2535.0 | -24.61 | 44.20 | 19.59 | 90.93 | |
| | 21400 | 2565.0 | -25.51 | 44.72 | 19.21 | 83.43 | |
| | 20800 | 2505.0 | -28.73 | 44.23 | 15.50 | 35.45 | V |
| | 21100 | 2535.0 | -28.20 | 44.09 | 15.89 | 38.80 | |
| | 21400 | 2565.0 | -29.55 | 44.41 | 14.86 | 30.59 | |

| LTE Band 7 | | | | | | | |
|---------------------------------|---------|-----------------|-----------|-----------------------|-----------|----------|--------------------|
| Channel Bandwidth: 15MHz / QPSK | | | | | | | |
| Plane | Channel | Frequency (MHz) | LVL (dBm) | Correction Factor(dB) | EIRP(dBm) | EIRP(mW) | Polarization (H/V) |
| X | 20825 | 2507.5 | -22.97 | 44.32 | 21.35 | 136.40 | H |
| | 21100 | 2535.0 | -22.77 | 44.20 | 21.43 | 138.90 | |
| | 21375 | 2562.5 | -23.74 | 44.85 | 21.11 | 129.06 | |
| | 20825 | 2507.5 | -26.97 | 43.99 | 17.02 | 50.37 | V |
| | 21100 | 2535.0 | -26.65 | 44.09 | 17.44 | 55.44 | |
| | 21375 | 2562.5 | -27.89 | 44.51 | 16.62 | 45.92 | |

| LTE Band 7 | | | | | | | |
|----------------------------------|---------|-----------------|-----------|-----------------------|-----------|----------|--------------------|
| Channel Bandwidth: 15MHz / 16QAM | | | | | | | |
| Plane | Channel | Frequency (MHz) | LVL (dBm) | Correction Factor(dB) | EIRP(dBm) | EIRP(mW) | Polarization (H/V) |
| X | 20825 | 2507.5 | -23.57 | 44.32 | 20.75 | 118.80 | H |
| | 21100 | 2535.0 | -22.62 | 44.20 | 21.58 | 143.78 | |
| | 21375 | 2562.5 | -24.35 | 44.85 | 20.50 | 112.15 | |
| | 20825 | 2507.5 | -27.34 | 43.99 | 16.65 | 46.26 | V |
| | 21100 | 2535.0 | -27.01 | 44.09 | 17.08 | 51.03 | |
| | 21375 | 2562.5 | -28.47 | 44.51 | 16.04 | 40.18 | |

| LTE Band 7 | | | | | | | |
|---------------------------------|---------|-----------------|-----------|-----------------------|-----------|----------|--------------------|
| Channel Bandwidth: 20MHz / QPSK | | | | | | | |
| Plane | Channel | Frequency (MHz) | LVL (dBm) | Correction Factor(dB) | EIRP(dBm) | EIRP(mW) | Polarization (H/V) |
| X | 20850.0 | 2510.0 | -22.86 | 44.16 | 21.30 | 134.90 | H |
| | 21100.0 | 2535.0 | -23.01 | 44.20 | 21.19 | 131.43 | |
| | 21350.0 | 2560.0 | -24.02 | 44.81 | 20.79 | 119.87 | |
| | 20850.0 | 2510.0 | -27.63 | 44.78 | 17.15 | 51.88 | V |
| | 21100.0 | 2535.0 | -26.98 | 44.09 | 17.11 | 51.38 | |
| | 21350.0 | 2560.0 | -28.04 | 44.72 | 16.68 | 46.56 | |

| LTE Band 7 | | | | | | | |
|----------------------------------|---------|-----------------|-----------|-----------------------|-----------|----------|--------------------|
| Channel Bandwidth: 20MHz / 16QAM | | | | | | | |
| Plane | Channel | Frequency (MHz) | LVL (dBm) | Correction Factor(dB) | EIRP(dBm) | EIRP(mW) | Polarization (H/V) |
| X | 20850.0 | 2510.0 | -23.99 | 44.16 | 20.17 | 103.99 | H |
| | 21100.0 | 2535.0 | -23.74 | 44.20 | 20.46 | 111.10 | |
| | 21350.0 | 2560.0 | -24.59 | 44.81 | 20.22 | 105.12 | |
| | 20850.0 | 2510.0 | -28.48 | 44.78 | 16.30 | 42.66 | V |
| | 21100.0 | 2535.0 | -27.96 | 44.09 | 16.13 | 41.00 | |
| | 21350.0 | 2560.0 | -28.72 | 44.72 | 16.00 | 39.81 | |

4.2 FREQUENCY STABILITY MEASUREMENT

4.2.1 LIMITS OF FREQUENCY STABILITY MEASUREMENT

The frequency stability shall be sufficient to ensure that the fundamental emissions stay within the authorized bands of operation.

4.2.2 TEST PROCEDURE

- Device is placed at the oven room. The oven room could control the temperatures and humidity. Power warm up is at least 15 min and power applied should perform before recording frequency error.
- EUT is connected the external power supply to control the DC input power. The test voltage range is from minimum to maximum working voltage. Each step shall be record the frequency error rate.
- The temperature range step is 10 degrees in this test items. All temperature levels shall be hold the $\pm 0.5^{\circ}\text{C}$ during the measurement testing. The each temperature step shall be at least 0.5 hours, consider the EUT could be test under the stability condition.

NOTE: The frequency error was recorded frequency error from the communication simulator.

4.2.3 TEST SETUP

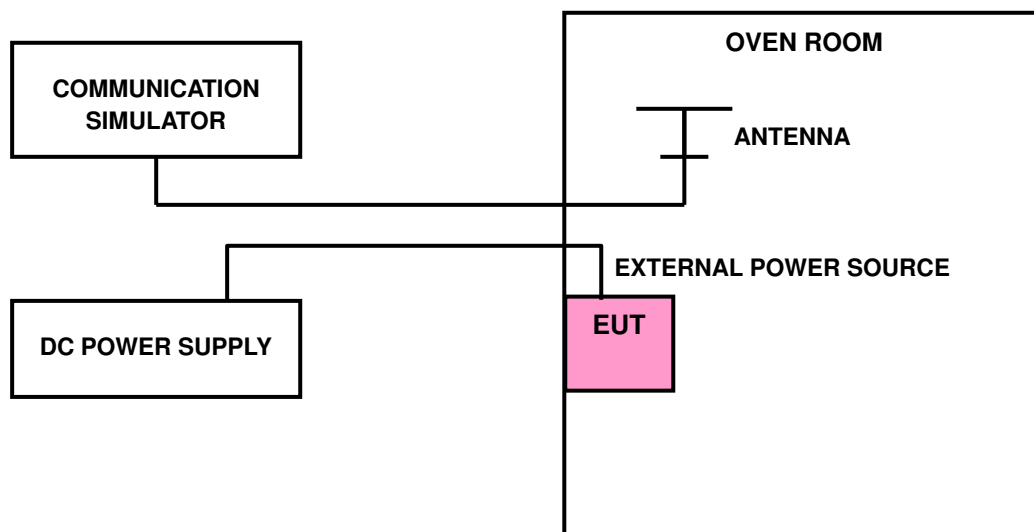

4.2.4 TEST RESULTS

FREQUENCY ERROR vs. VOLTAGE

| VOLTAGE (Volts) | FREQUENCY ERROR (ppm) | | | | LIMIT (ppm) |
|--------------------|-----------------------|---------|--------|---------|-------------|
| | LTE BAND 7 | | | | |
| | 5MHz | 10MHz | 15MHz | 20MHz | |
| 3.8 | -0.0024 | -0.0011 | 0.0029 | -0.0011 | 2.5 |
| 3.6 | -0.0011 | 0.0009 | 0.0043 | 0.0016 | 2.5 |
| 4.35 | -0.0009 | 0.0018 | 0.0059 | 0.0021 | 2.5 |

NOTE: The applicant defined the normal working voltage of the battery is from 3.6Vdc to 4.35Vdc.

FREQUENCY ERROR vs. TEMPERATURE

| TEMP. (°C) | FREQUENCY ERROR (ppm) | | | | LIMIT (ppm) |
|------------|-----------------------|---------|---------|---------|-------------|
| | LTE BAND 7 | | | | |
| | 5MHz | 10MHz | 15MHz | 20MHz | |
| -30 | -0.0031 | -0.0009 | -0.0028 | -0.0022 | 2.5 |
| -20 | 0.0036 | -0.0004 | 0.0005 | -0.0009 | 2.5 |
| -10 | 0.0005 | 0.0011 | 0.0033 | -0.0031 | 2.5 |
| 0 | 0.0015 | 0.0058 | 0.0007 | -0.0003 | 2.5 |
| 10 | 0.0008 | 0.0034 | 0.0006 | 0.0004 | 2.5 |
| 20 | -0.0024 | 0.0003 | 0.0027 | 0.0045 | 2.5 |
| 30 | -0.0018 | 0.0043 | 0.0023 | 0.0044 | 2.5 |
| 40 | 0.0019 | -0.0025 | -0.0014 | -0.0015 | 2.5 |
| 50 | 0.0008 | -0.0011 | -0.0020 | -0.0010 | 2.5 |
| 60 | 0.0012 | 0.0017 | -0.0014 | -0.0007 | 2.5 |

4.3 OCCUPIED BANDWIDTH MEASUREMENT

4.3.1 LIMITS OF OCCUPIED BANDWIDTH MEASUREMENT

The width of a frequency band such that, below the lower and above the upper frequency limits, the mean powers emitted are each equal to a specified percentage 0.5 %of the total mean power of a given emission.

4.3.2 TEST SETUP

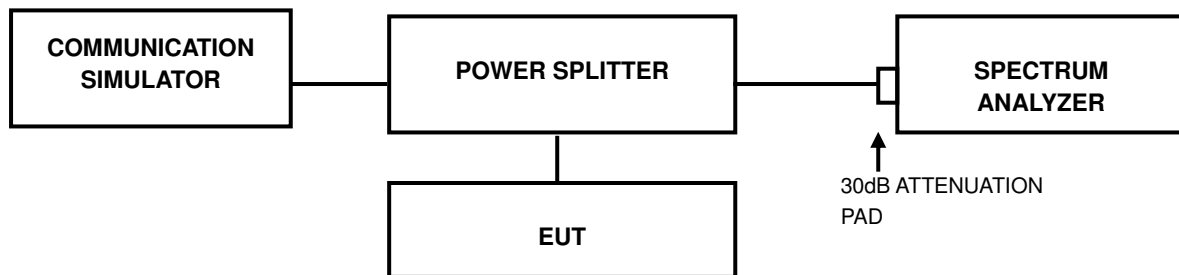

4.3.3 TEST PROCEDURES

- a. The conducted occupied bandwidth used the power splitter via EUT RF power connector between simulation base station and spectrum analyzer.
- b. Use OBW measurement function of Spectrum analyzer to measure 99 % occupied bandwidth.

4.3.4 TEST RESULTS

| LTE BAND 7 | | | | | | | |
|-------------------------|-----------------|------------------------------|--------|--------------------------|-----------------|------------------------------|--------|
| CHANNEL BANDWIDTH: 5MHz | | | | CHANNEL BANDWIDTH: 10MHz | | | |
| CHANNEL | FREQUENCY (MHz) | 99% OCCUPIED BANDWIDTH (MHz) | | CHANNEL | FREQUENCY (MHz) | 99% OCCUPIED BANDWIDTH (MHz) | |
| | | QPSK | 16QAM | | | QPSK | 16QAM |
| 20775 | 2502.5 | 4.4962 | 4.4905 | 20800 | 2505.0 | 8.9136 | 8.9148 |
| 21100 | 2535.0 | 4.4977 | 4.4885 | 21100 | 2535.0 | 8.9136 | 8.9141 |
| 21425 | 2567.5 | 4.4976 | 4.4930 | 21400 | 2565.0 | 8.9219 | 8.9183 |

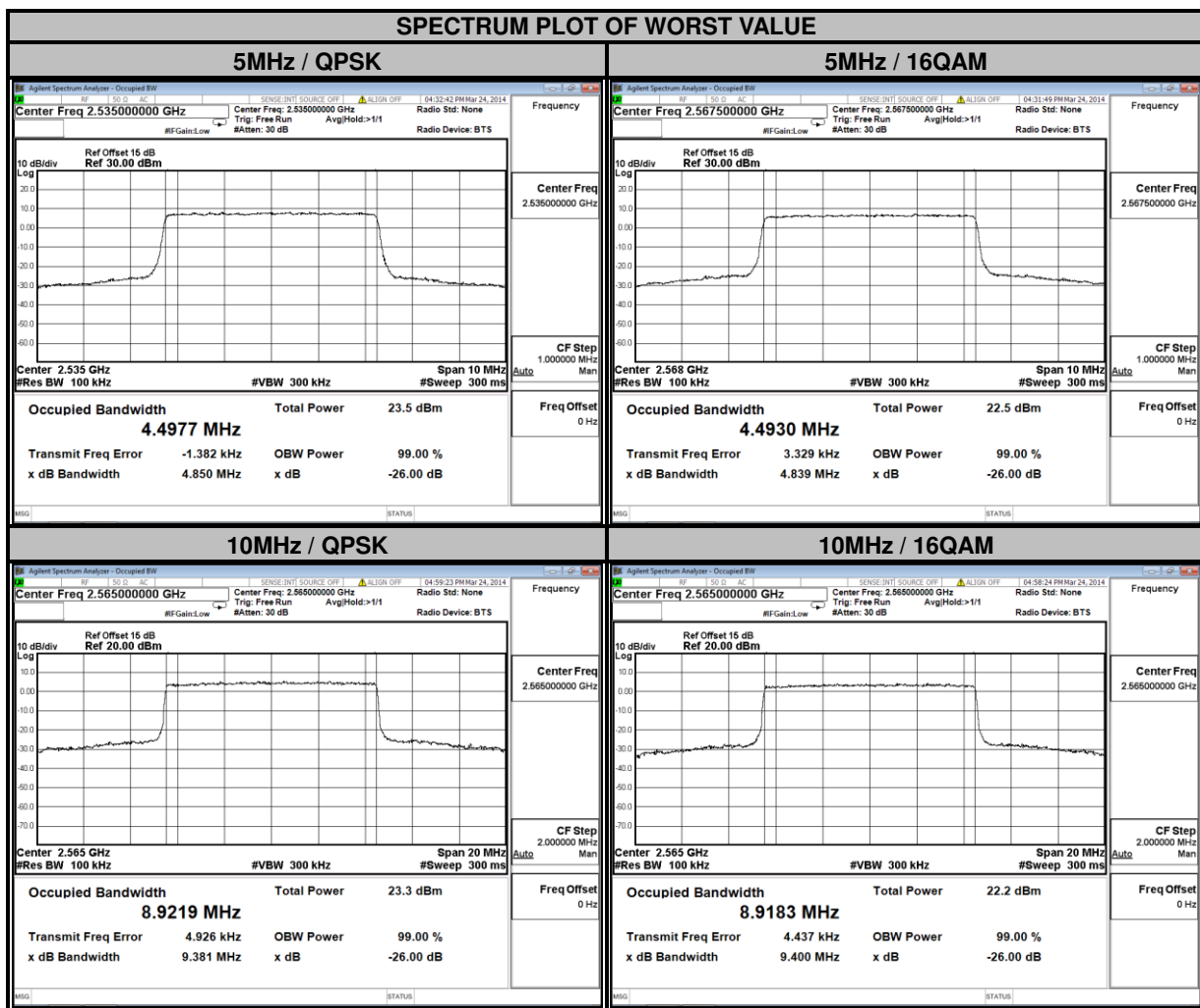



A D T

| LTE BAND 7 | | | | | | | |
|--------------------------|-----------------|------------------------------|--------|--------------------------|-----------------|------------------------------|--------|
| CHANNEL BANDWIDTH: 15MHz | | | | CHANNEL BANDWIDTH: 20MHz | | | |
| CHANNEL | FREQUENCY (MHz) | 99% OCCUPIED BANDWIDTH (MHz) | | CHANNEL | FREQUENCY (MHz) | 99% OCCUPIED BANDWIDTH (MHz) | |
| | | QPSK | 16QAM | | | QPSK | 16QAM |
| 20825 | 2507.5 | 13.375 | 13.361 | 20850 | 2510.0 | 17.795 | 17.802 |
| 21100 | 2535.0 | 13.373 | 13.365 | 21100 | 2535.0 | 17.792 | 17.801 |
| 21375 | 2562.5 | 13.385 | 13.376 | 21350 | 2560.0 | 17.841 | 17.833 |

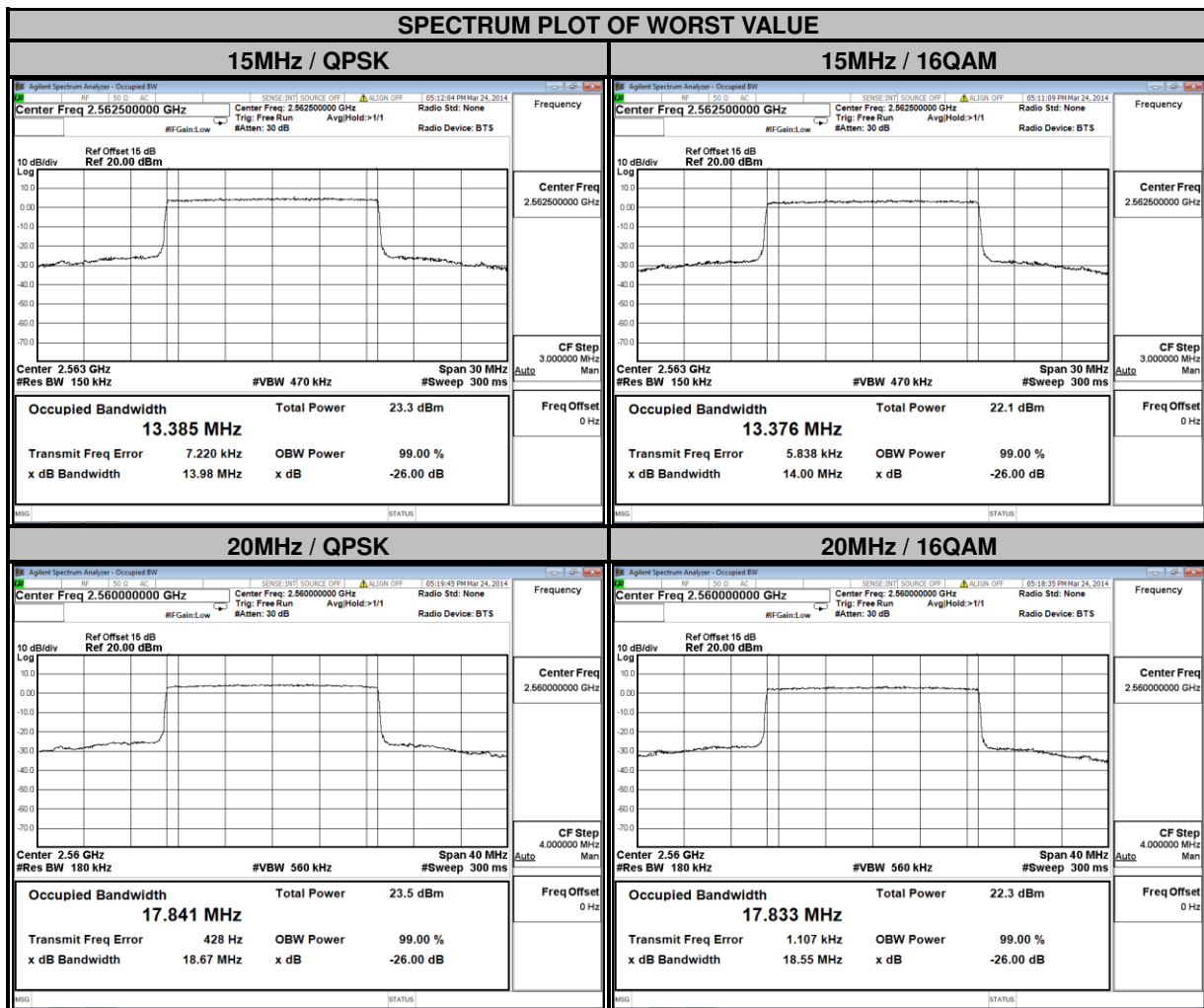

4.4 PEAK TO AVERAGE RATIO

4.4.1 LIMITS OF PEAK TO AVERAGE RATIO MEASUREMENT

In measuring transmissions in this band using an average power technique, the peak to-average ratio (PAR) of the transmission may not exceed 13 dB.

4.4.2 TEST SETUP

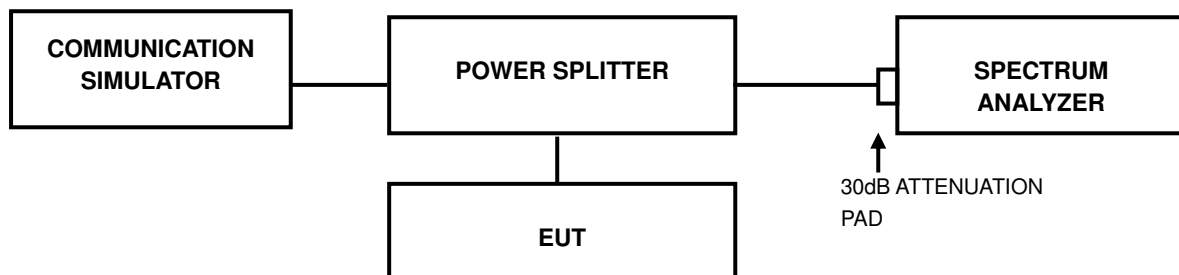

4.4.3 TEST PROCEDURES

1. Set resolution/measurement bandwidth \geq signal's occupied bandwidth;
2. Set the number of counts to a value that stabilizes the measured CCDF curve;
3. Record the maximum PAPR level associated with a probability of 0.1%.



A D T

4.4.4 TEST RESULTS

| LTE BAND 7 | | | | | | | |
|-------------------------|-----------------|----------------------------|-------|--------------------------|-----------------|----------------------------|-------|
| CHANNEL BANDWIDTH: 5MHz | | | | CHANNEL BANDWIDTH: 10MHz | | | |
| CHANNEL | FREQUENCY (MHz) | PEAK TO AVERAGE RATIO (dB) | | CHANNEL | FREQUENCY (MHz) | PEAK TO AVERAGE RATIO (dB) | |
| | | QPSK | 16QAM | | | QPSK | 16QAM |
| 20775 | 2502.5 | 4.84 | 5.34 | 20800 | 2505.0 | 4.81 | 6.02 |
| 21100 | 2535.0 | 4.91 | 5.52 | 21100 | 2535.0 | 4.85 | 5.50 |
| 21425 | 2567.5 | 4.44 | 4.97 | 21400 | 2565.0 | 4.55 | 5.68 |

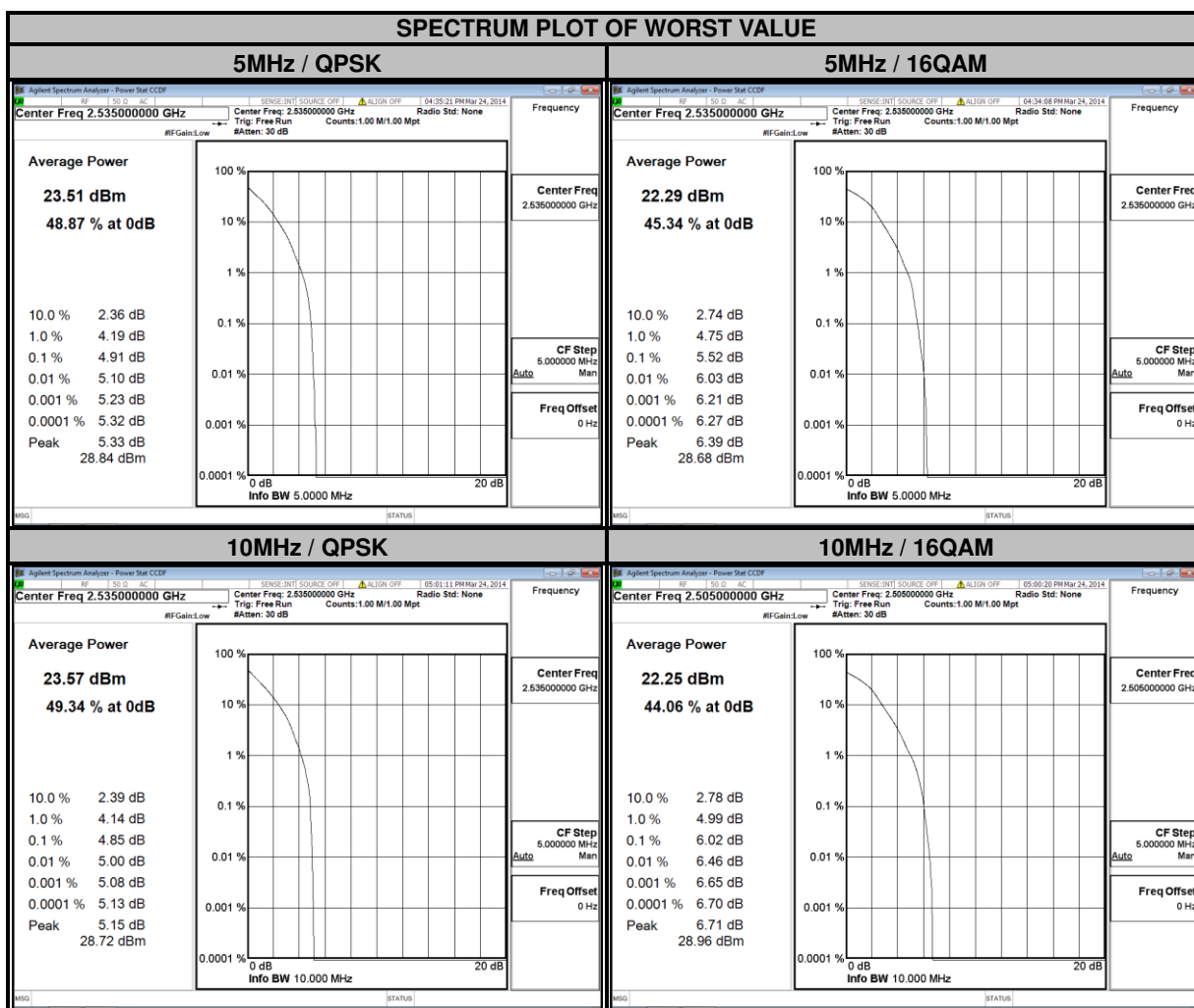

| LTE BAND 7 | | | | | | | |
|--------------------------|-----------------|----------------------------|-------|--------------------------|-----------------|----------------------------|-------|
| CHANNEL BANDWIDTH: 15MHz | | | | CHANNEL BANDWIDTH: 20MHz | | | |
| CHANNEL | FREQUENCY (MHz) | PEAK TO AVERAGE RATIO (dB) | | CHANNEL | FREQUENCY (MHz) | PEAK TO AVERAGE RATIO (dB) | |
| | | QPSK | 16QAM | | | QPSK | 16QAM |
| 20825 | 2507.5 | 4.76 | 5.91 | 20850 | 2510.0 | 4.77 | 6.09 |
| 21100 | 2535.0 | 4.79 | 5.87 | 21100 | 2535.0 | 4.91 | 6.05 |
| 21375 | 2562.5 | 4.72 | 5.87 | 21350 | 2560.0 | 4.96 | 6.04 |

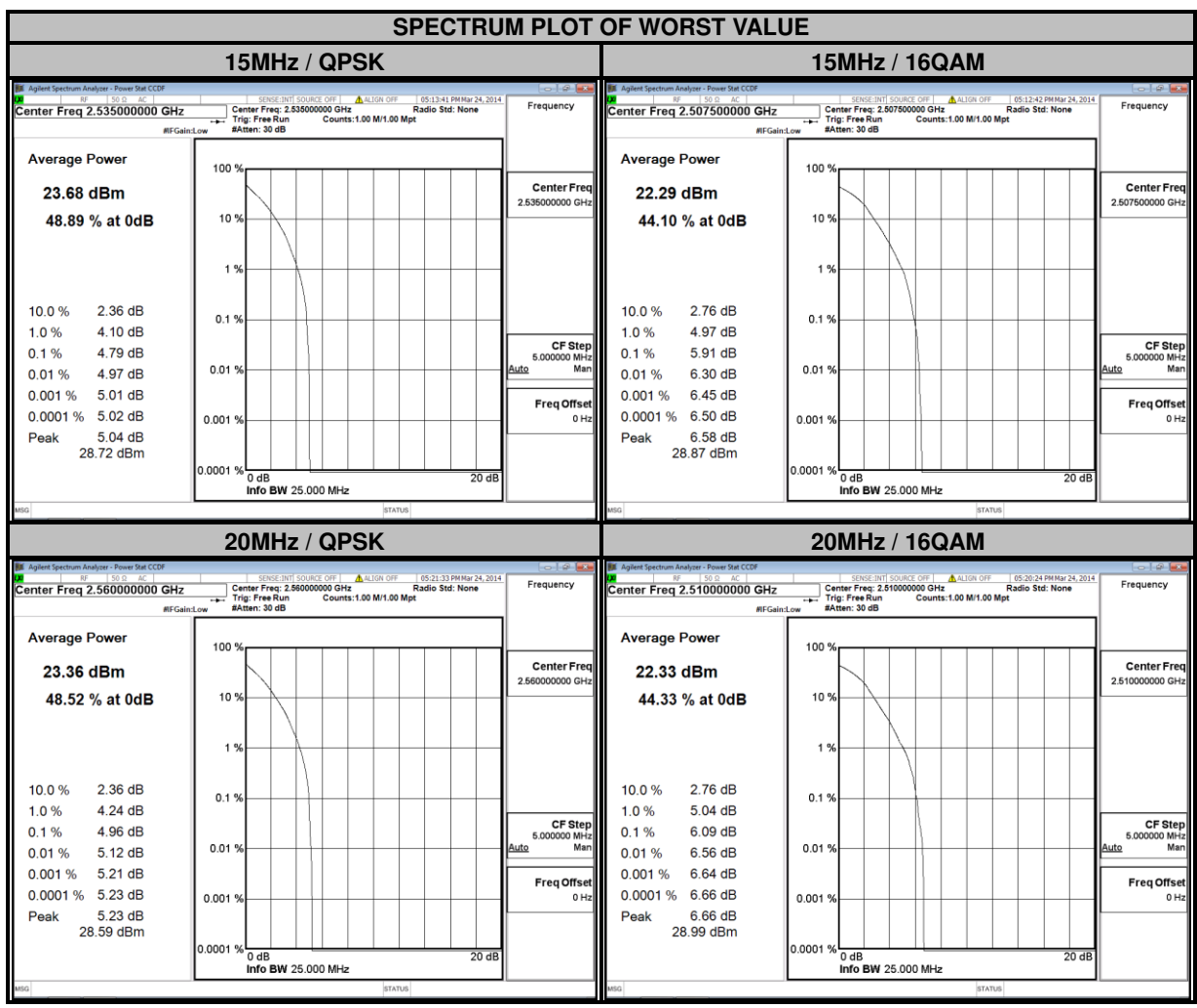

4.5 BAND EDGE MEASUREMENT

4.5.1 LIMITS OF BAND EDGE MEASUREMENT

According to FCC 27.53(l)(4) specified that power of any emission outside of the channel edge must be attenuated below the transmitting power (P) by a factor shall be not less than $43 + 10 \log (P)$ dB at the channel edge, the limit of emission is equal to -13dBm. And $55 + 10 \log (P)$ dB at 5.5 MHz from the channel edges, the limit of emission is equal to -25dBm. In the 1MHz bands immediately outside and adjacent to the frequency block a resolution bandwidth of at least one percent of the emission bandwidth of the fundamental emission of the transmitter may be employed.

4.5.2 TEST SETUP

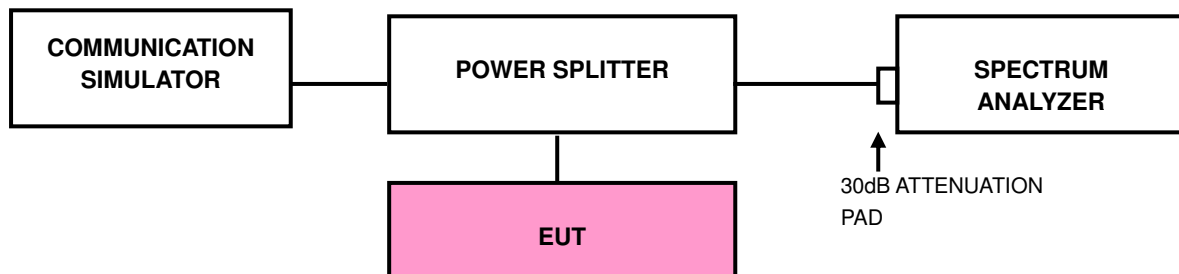

4.5.3 TEST PROCEDURES

- a. The EUT was set up for the maximum peak power with LTE link data modulation. The power was measured with R&S Spectrum Analyzer. All measurements were done at 2 channels (low and high operational frequency range.).
- b. The band edge measurement used the power splitter via EUT RF power connector between simulation base station and spectrum analyzer.
- c. The center frequency of spectrum is the band edge frequency and span is 20MHz. RB of the spectrum is 50kHz and VB of the spectrum is 200kHz (Channel bandwidth 7MHz).
- d. The center frequency of spectrum is the band edge frequency and span is 15MHz. RB of the spectrum is 100kHz and VB of the spectrum is 300kHz (Channel bandwidth 10MHz).
- e. The center frequency of spectrum is the band edge frequency and span is 20MHz. RB of the spectrum is 200kHz and VB of the spectrum is 1MHz (Channel bandwidth 15MHz).
- f. The center frequency of spectrum is the band edge frequency and span is 30MHz. RB of the spectrum is 200kHz and VB of the spectrum is 1MHz (Channel bandwidth 20MHz).
- g. Record the max trace plot into the test report.



A D T

4.5.4 TEST RESULTS

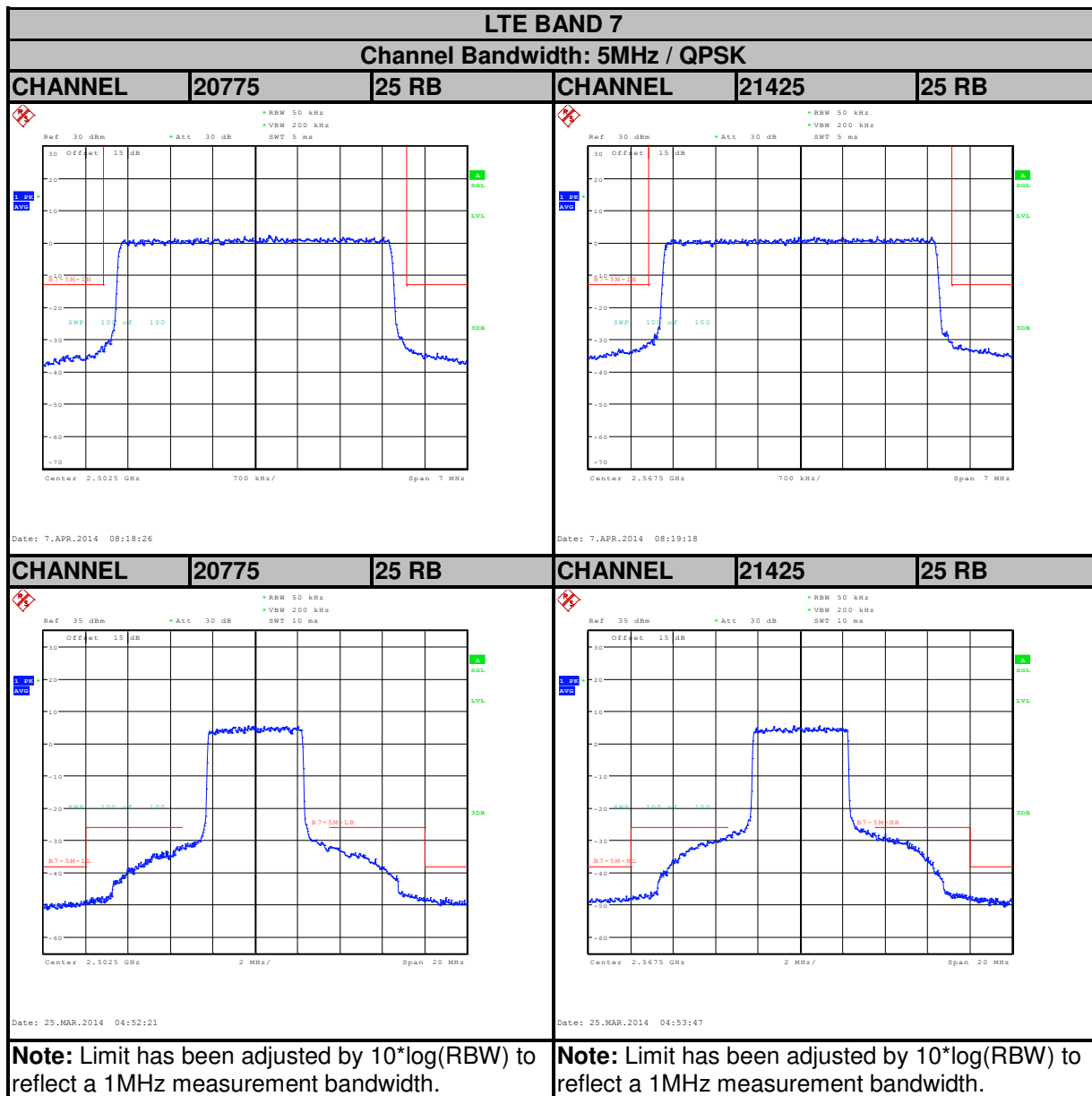



A D T

LTE BAND 7

Channel Bandwidth: 5MHz / 16QAM

| | | | | | |
|----------------|--------------|--------------|----------------|--------------|--------------|
| CHANNEL | 20775 | 25 RB | CHANNEL | 21425 | 25 RB |
|----------------|--------------|--------------|----------------|--------------|--------------|

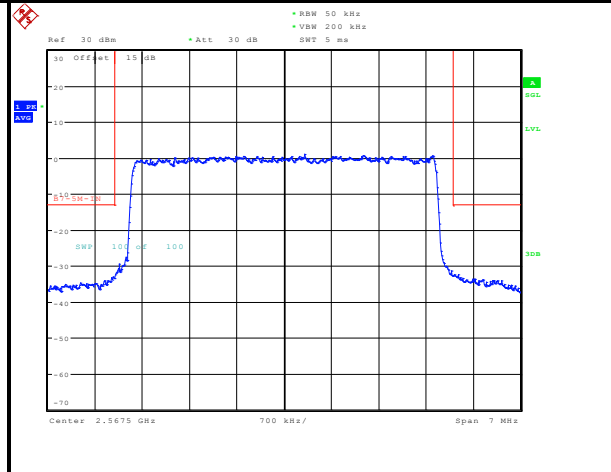
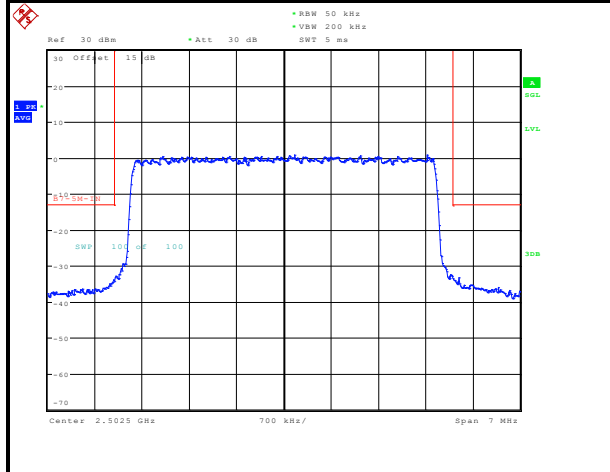

Date: 7.APR.2014 08:18:40

Date: 7.APR.2014 08:19:04

| | | | | | |
|----------------|--------------|--------------|----------------|--------------|--------------|
| CHANNEL | 20775 | 25 RB | CHANNEL | 21425 | 25 RB |
|----------------|--------------|--------------|----------------|--------------|--------------|

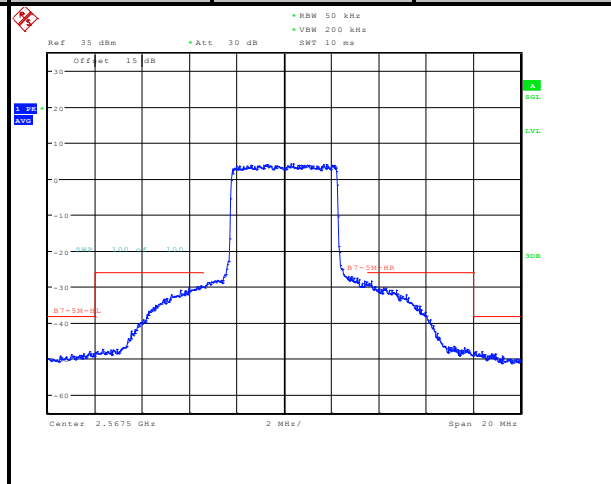
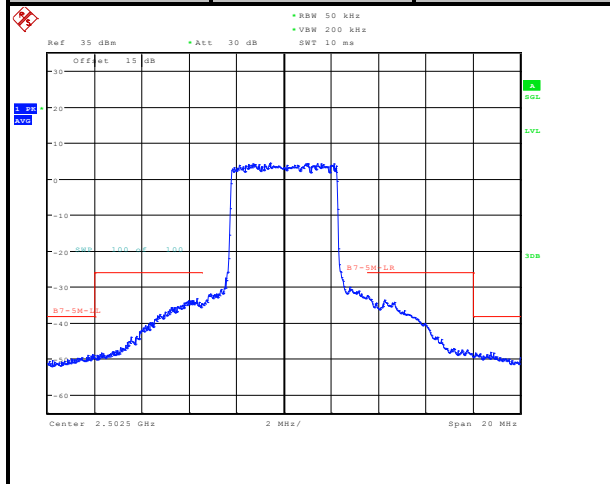

Date: 25.MAR.2014 04:52:39

Date: 25.MAR.2014 04:53:33

Note: Limit has been adjusted by $10 \cdot \log(\text{RBW})$ to reflect a 1MHz measurement bandwidth.

Note: Limit has been adjusted by $10 \cdot \log(\text{RBW})$ to reflect a 1MHz measurement bandwidth.

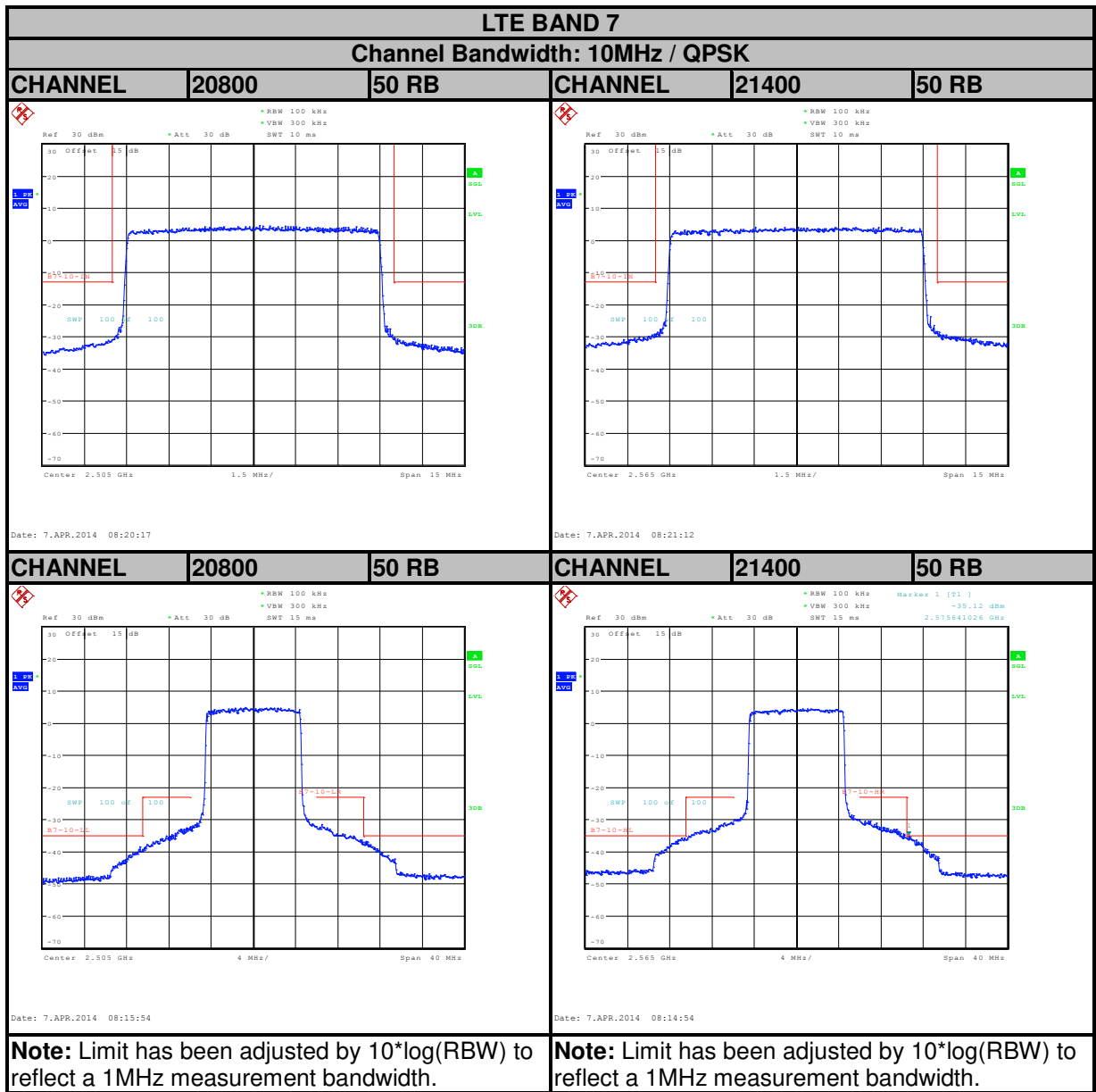



A D T

LTE BAND 7

Channel Bandwidth: 10MHz / 16QAM

| | | | | | |
|---------|-------|-------|---------|-------|-------|
| CHANNEL | 20800 | 50 RB | CHANNEL | 21400 | 50 RB |
|---------|-------|-------|---------|-------|-------|

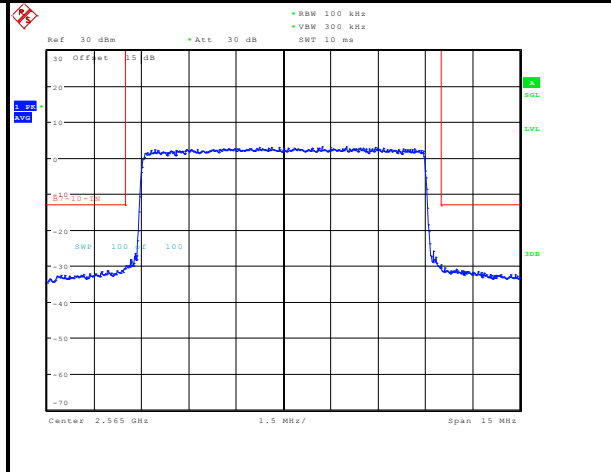
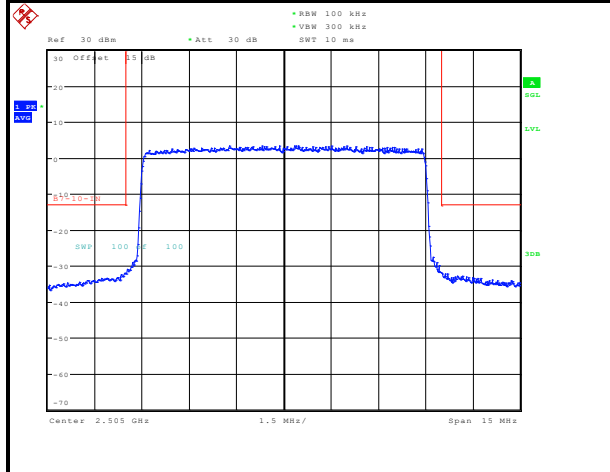

Date: 7.APR.2014 08:20:34

Date: 7.APR.2014 08:20:57

| | | | | | |
|---------|-------|-------|---------|-------|-------|
| CHANNEL | 20800 | 50 RB | CHANNEL | 21400 | 50 RB |
|---------|-------|-------|---------|-------|-------|

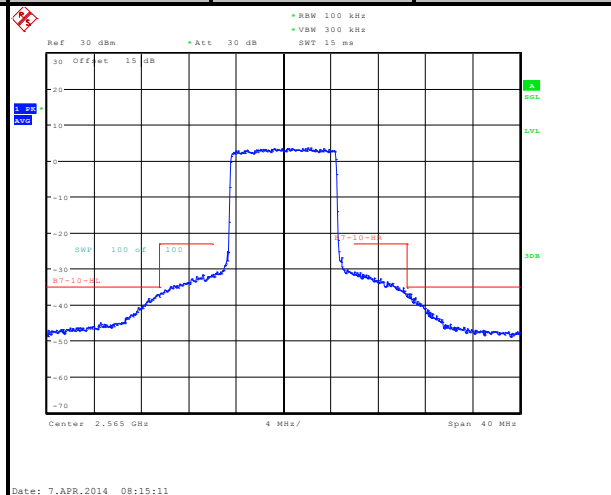
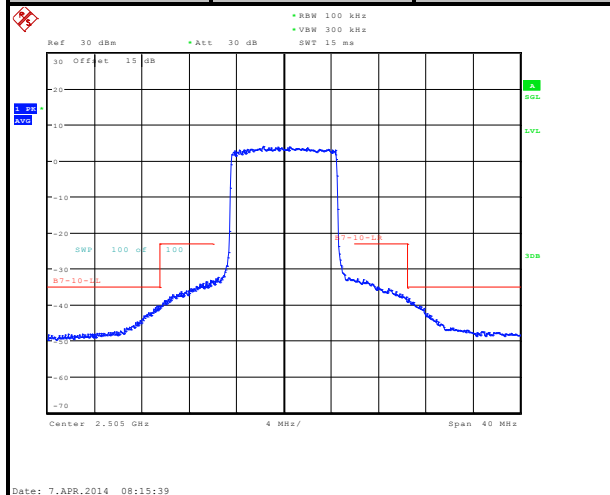

Date: 7.APR.2014 08:15:39

Date: 7.APR.2014 08:15:11

Note: Limit has been adjusted by $10 \cdot \log(\text{RBW})$ to reflect a 1MHz measurement bandwidth.

Note: Limit has been adjusted by $10 \cdot \log(\text{RBW})$ to reflect a 1MHz measurement bandwidth.



A D T

LTE BAND 7

Channel Bandwidth: 15MHz / QPSK

| | | | | | |
|----------------|--------------|--------------|----------------|--------------|--------------|
| CHANNEL | 20825 | 75 RB | CHANNEL | 21375 | 75 RB |
|----------------|--------------|--------------|----------------|--------------|--------------|

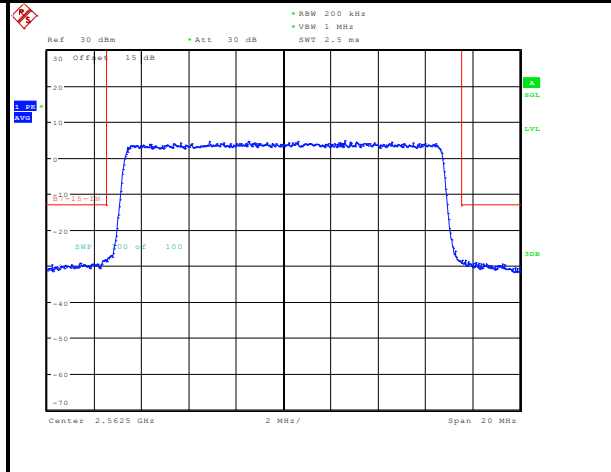
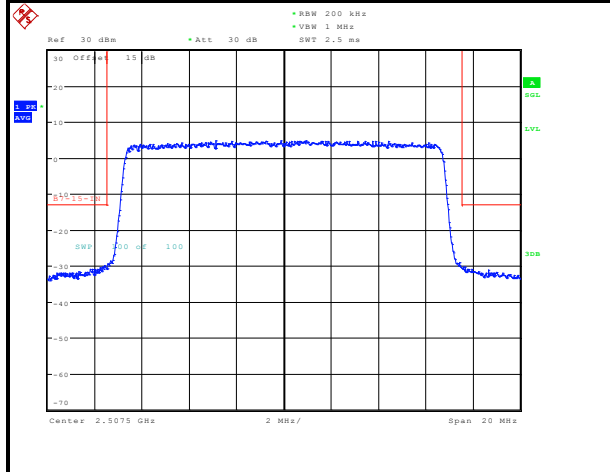

Date: 7.APR.2014 08:22:17

Date: 7.APR.2014 08:23:47

| | | |
|----------------|--------------|--------------|
| CHANNEL | 20825 | 75 RB |
|----------------|--------------|--------------|

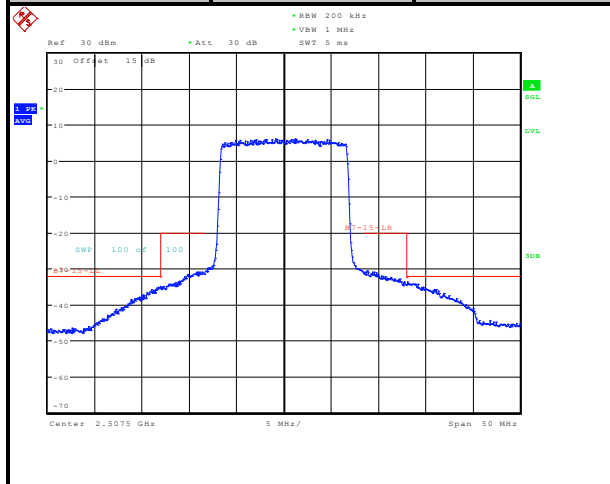

Date: 7.APR.2014 08:13:17

| | | |
|----------------|--------------|--------------|
| CHANNEL | 21375 | 75 RB |
|----------------|--------------|--------------|

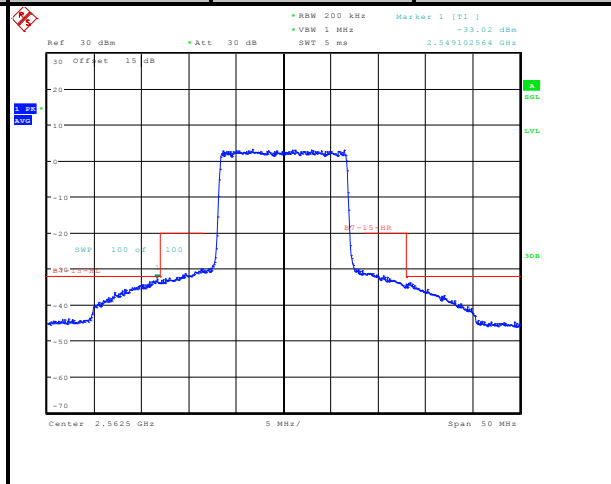

Date: 7.APR.2014 08:12:05

Note: Limit has been adjusted by $10 \cdot \log(\text{RBW})$ to reflect a 1MHz measurement bandwidth.

Note: Limit has been adjusted by $10 \cdot \log(\text{RBW})$ to reflect a 1MHz measurement bandwidth.



A D T

LTE BAND 7
Channel Bandwidth: 15MHz / 16QAM

| | | | | | |
|----------------|--------------|--------------|----------------|--------------|--------------|
| CHANNEL | 20825 | 75 RB | CHANNEL | 21375 | 75 RB |
|----------------|--------------|--------------|----------------|--------------|--------------|

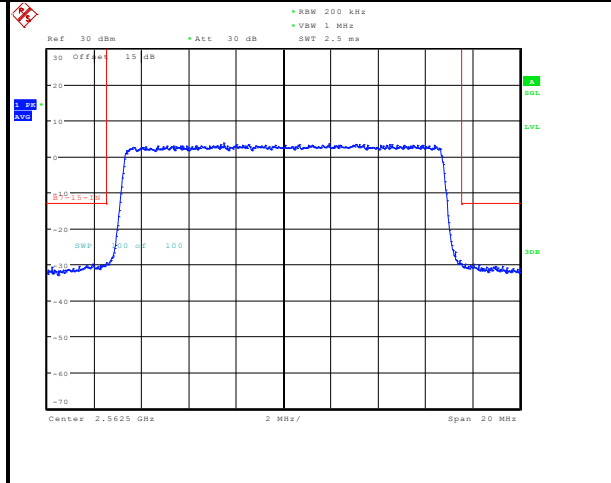
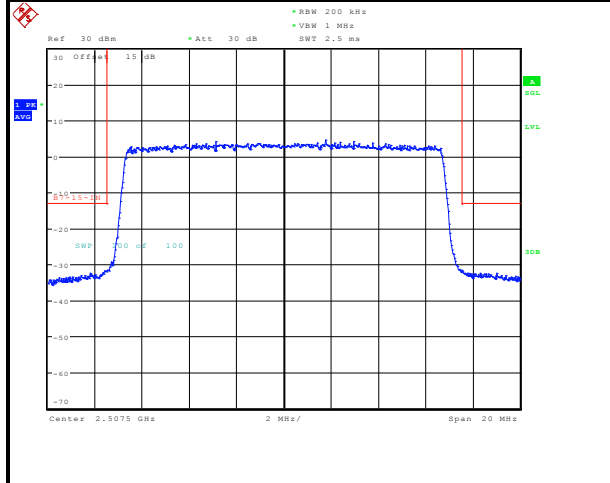

| | | | | | |
|----------------|--------------|--------------|----------------|--------------|--------------|
| CHANNEL | 20825 | 75 RB | CHANNEL | 21375 | 75 RB |
|----------------|--------------|--------------|----------------|--------------|--------------|

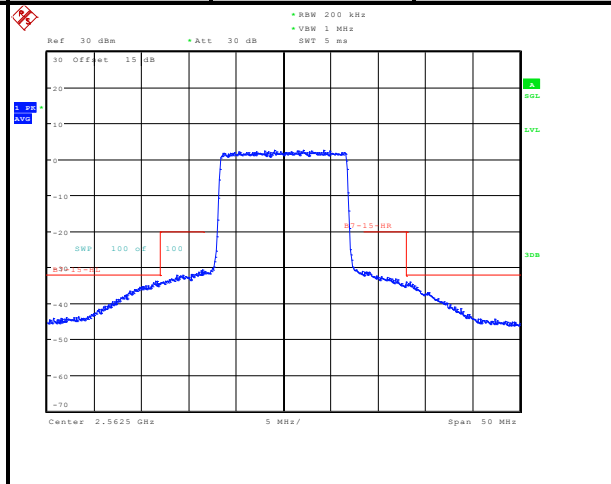
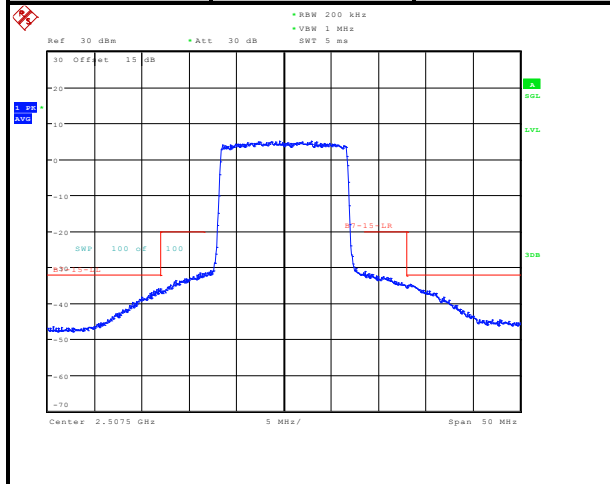

Note: Limit has been adjusted by $10 \cdot \log(\text{RBW})$ to reflect a 1MHz measurement bandwidth.

Note: Limit has been adjusted by $10 \cdot \log(\text{RBW})$ to reflect a 1MHz measurement bandwidth.



A D T

LTE BAND 7

Channel Bandwidth: 20MHz / QPSK

| | | | | | |
|----------------|--------------|---------------|----------------|--------------|---------------|
| CHANNEL | 20850 | 100 RB | CHANNEL | 21350 | 100 RB |
|----------------|--------------|---------------|----------------|--------------|---------------|

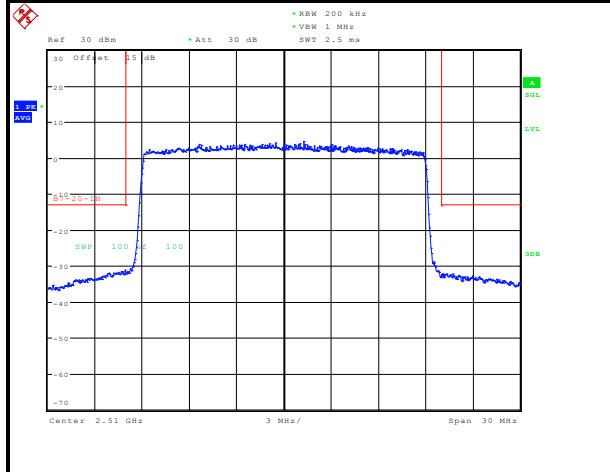

Date: 7.APR.2014 08:24:43

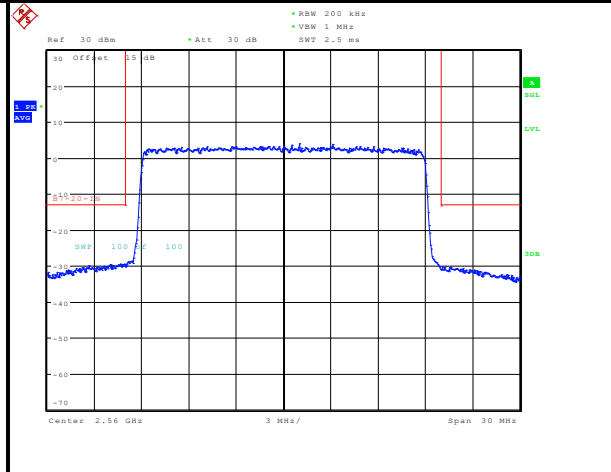

Date: 7.APR.2014 08:25:42

| | | | | | |
|----------------|--------------|---------------|----------------|--------------|---------------|
| CHANNEL | 20850 | 100 RB | CHANNEL | 21350 | 100 RB |
|----------------|--------------|---------------|----------------|--------------|---------------|

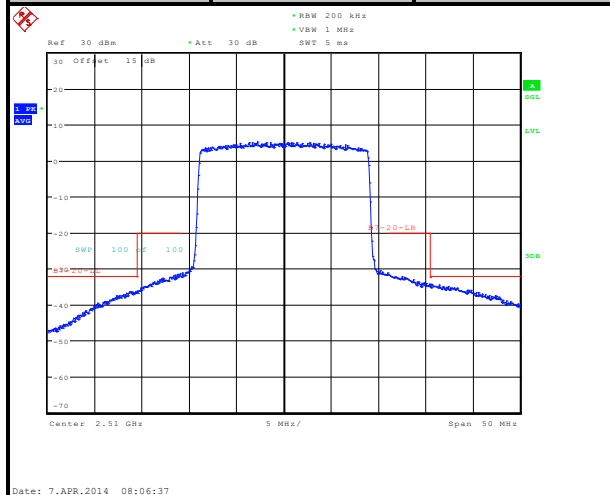

Date: 7.APR.2014 08:06:37

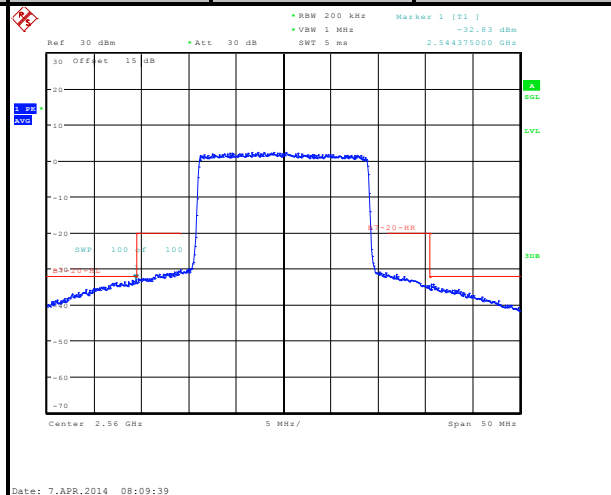

Date: 7.APR.2014 08:09:39

Note: Limit has been adjusted by $10 \cdot \log(\text{RBW})$ to reflect a 1MHz measurement bandwidth.

Note: Limit has been adjusted by $10 \cdot \log(\text{RBW})$ to reflect a 1MHz measurement bandwidth.



A D T

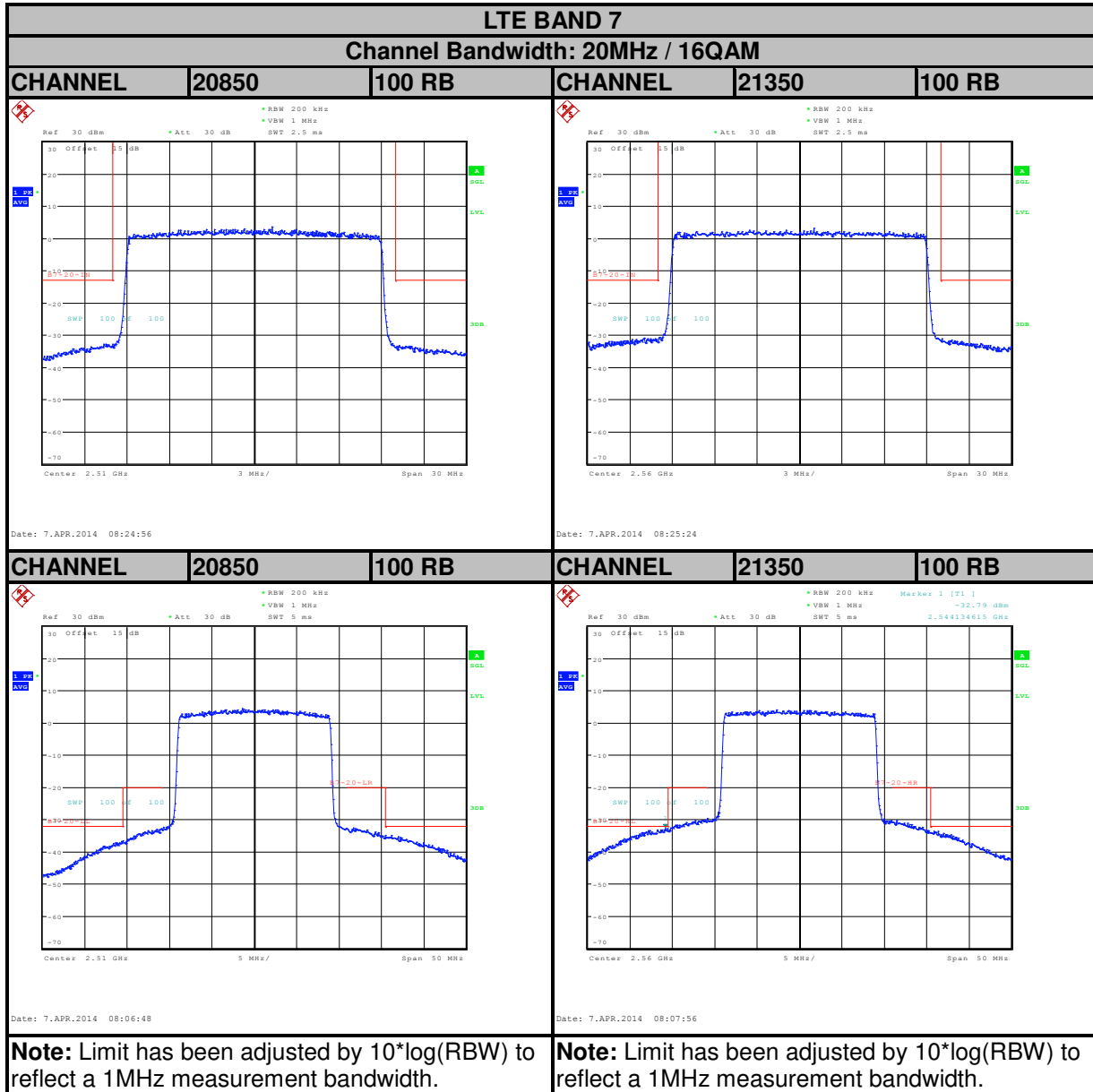

4.6 CONDUCTED SPURIOUS EMISSIONS

4.6.1 LIMITS OF CONDUCTED SPURIOUS EMISSIONS MEASUREMENT

The power of any emission outside a licensee's frequency block shall be attenuated below the transmitter power (P) by at least $55 + 10 \log_{10}(P)$ dB. The limit of emission is equal to -25dBm.

4.6.2 TEST PROCEDURE

- The EUT makes a phone call to the communication simulator. All measurements were done at low, middle and high operational frequency range.
- Measuring frequency range is from 30MHz to 26GHz for LTE Band 7. 10dB attenuation pad is connected with spectrum. RBW=1MHz and VBW=3MHz are used for conducted emission measurement.

4.6.3 TEST SETUP

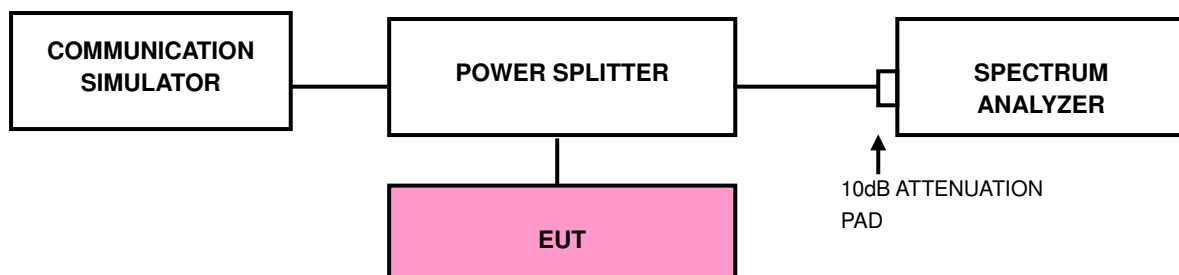



A D T

4.6.4 TEST RESULTS

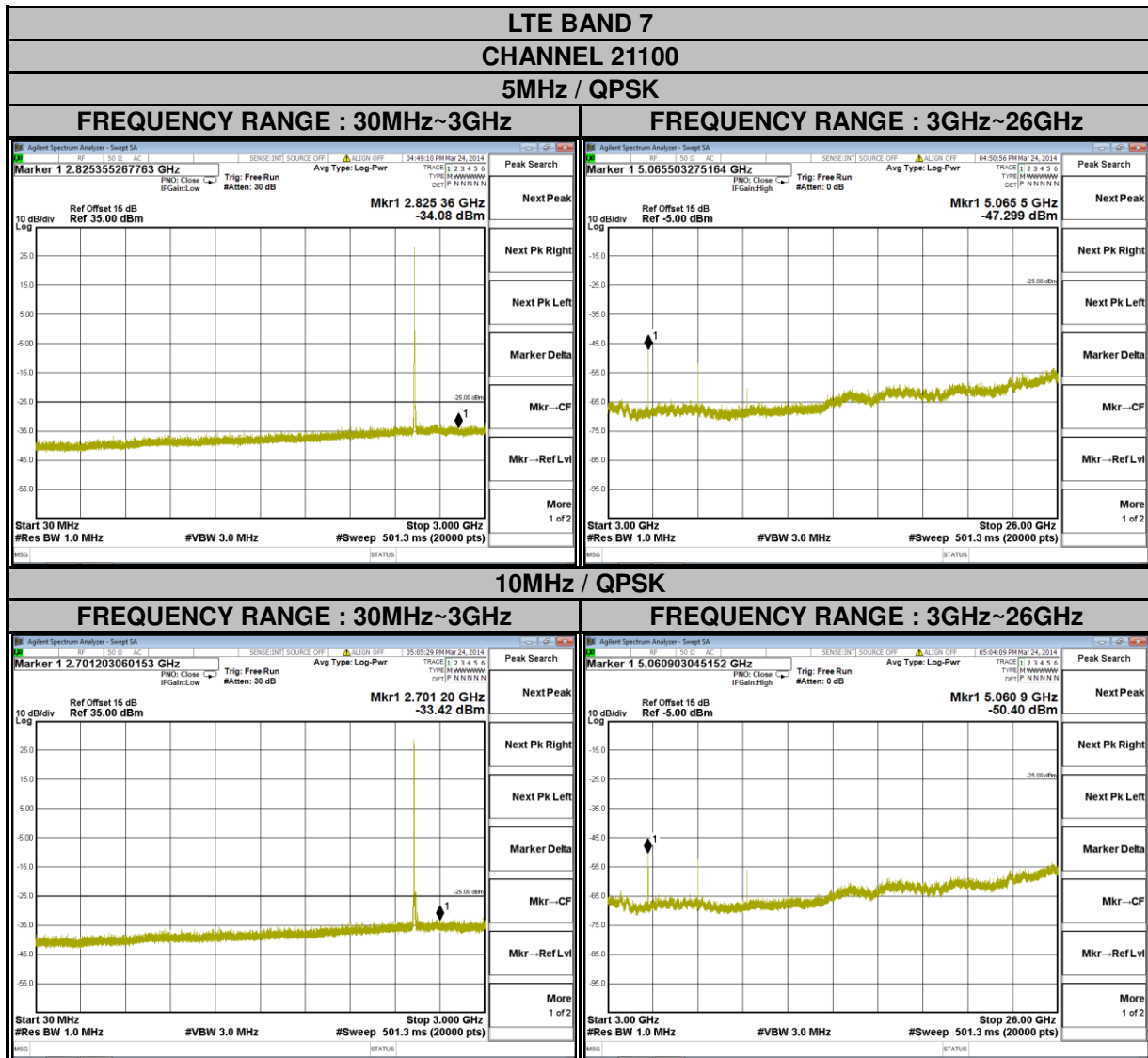



A D T

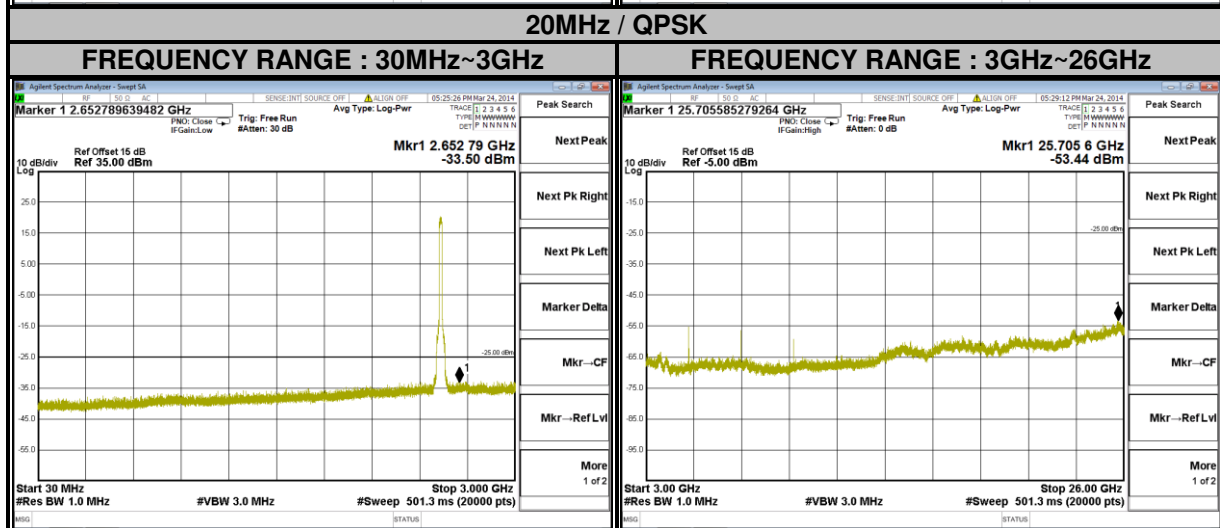
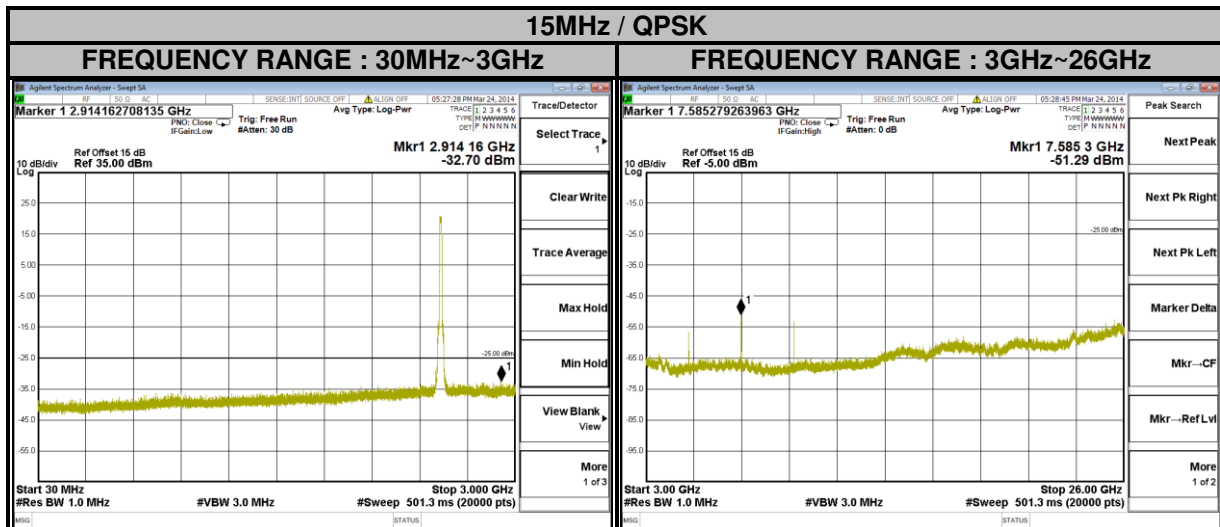

4.7 RADIATED EMISSION MEASUREMENT

4.7.1 LIMITS OF RADIATED EMISSION MEASUREMENT

The power of any emission outside a licensee's frequency block shall be attenuated below the transmitter power (P) by at least $55 + 10 \log_{10}(P)$ dB. The limit of emission is equal to -25dBm.

4.7.2 TEST PROCEDURES

- a. Substitution method is used for E.I.R.P measurement. In the semi-anechoic chamber, EUT placed on the 0.8m height of Turn Table, rotated the table around 360 degrees to search the maximum radiation power and receiver antenna shall be rotated vertical and horizontal polarization and moved height from 1m to 4m to find the maximum polar radiated power. The "Read Value" is the spectrum reading the maximum power value.
- b. The substitution horn antenna is substituted for EUT at the same position and signals generator export the CW signal to the substitution antenna via a TX cable. Rotated the Turn Table and moved receiving antenna to find the maximum radiation power. Adjust output power level of S.G to get a Value of spectrum reading equal to "Read Value " of step a. Record the power level of S.G.
- c. EIRP = Output power level of S.G – TX cable loss + Antenna gain of substitution horn.
- d. E.R.P power can be calculated form E.I.R.P power by subtracting the gain of dipole, E.R.P power = E.I.P.R power - 2.15dBi.

NOTE: The resolution bandwidth of spectrum analyzer is 1 MHz and the video bandwidth is 3 MHz.

4.7.3 DEVIATION FROM TEST STANDARD

No deviation

4.7.4 TEST SETUP

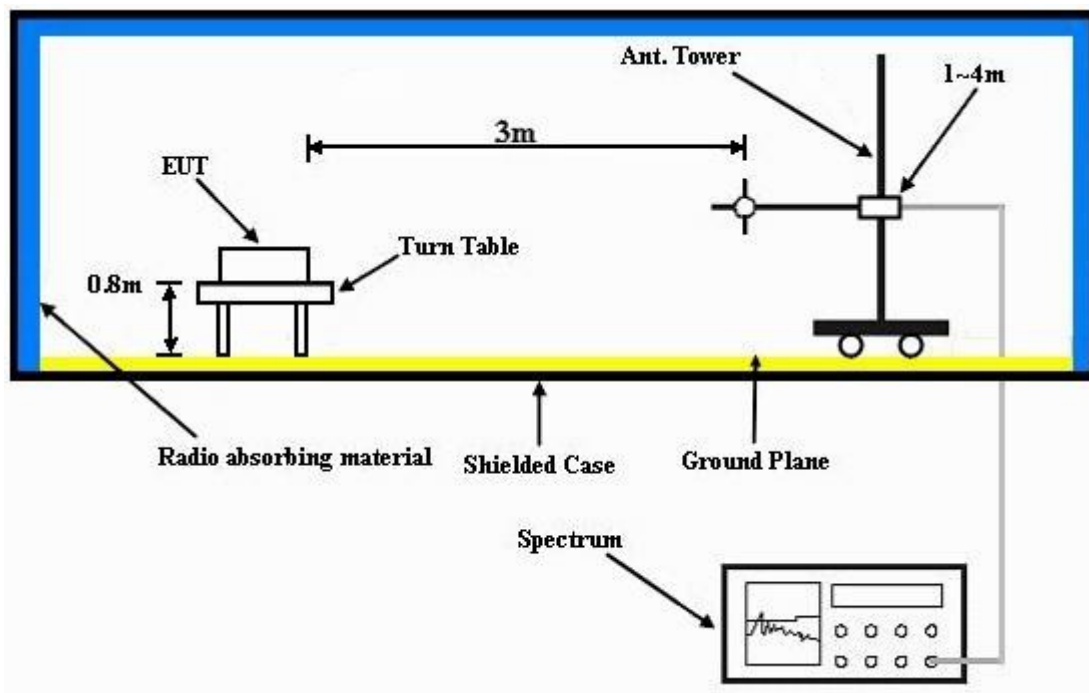

For the actual test configuration, please refer to the attached file (Test Setup Photo).

4.7.5 TEST RESULTS

LTE BAND 7

CHANNEL BANDWIDTH: 5MHz / QPSK



Bureau Veritas Consumer Products Services Ltd., Taoyuan Branch

A D T

Data: 11

Date: 2014-03-17

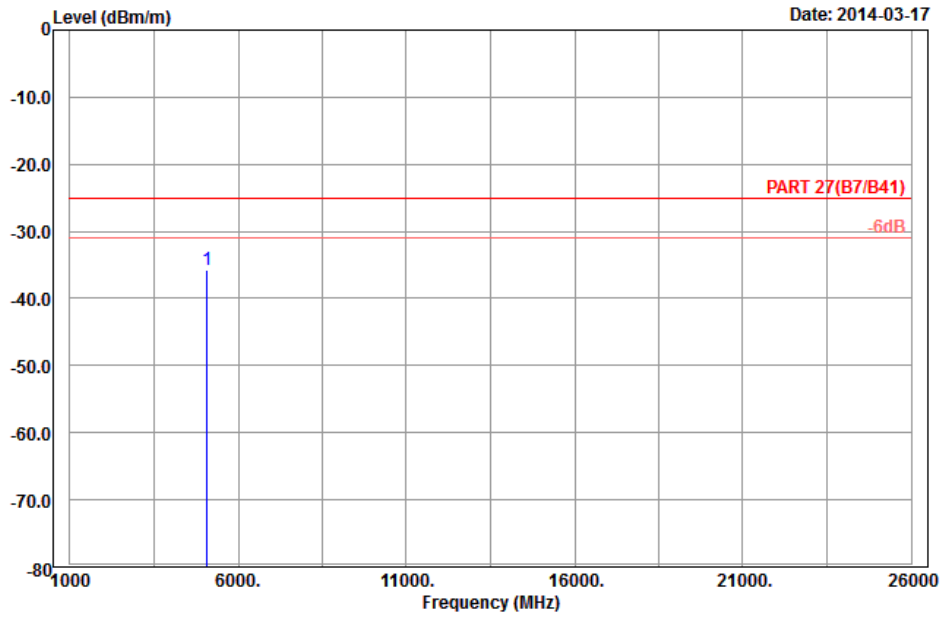

Site : 966 chamber 5
 Condition : PART 27(B7/B41) 3m Horizontal
 Brand/Model: 0P8B100
 Remark : LTE_Band 7_QPSK(1,24)_5M_CH21100
 Tested by : Kay Wu
 Plane : Y

| | Read | Limit | Over | | |
|--------------|--------|--------|--------|--------|------------|
| Freq | Level | Level | Line | Limit | Factor |
| MHz | dBm/m | dBm | dBm/m | dB | dB/m |
| 1 pp 5074.40 | -35.82 | -55.21 | -25.00 | -10.82 | 19.39 Peak |



A D T



Bureau Veritas Consumer Products Services Ltd., Taoyuan Branch

A D T

Data: 12

Date: 2014-03-17

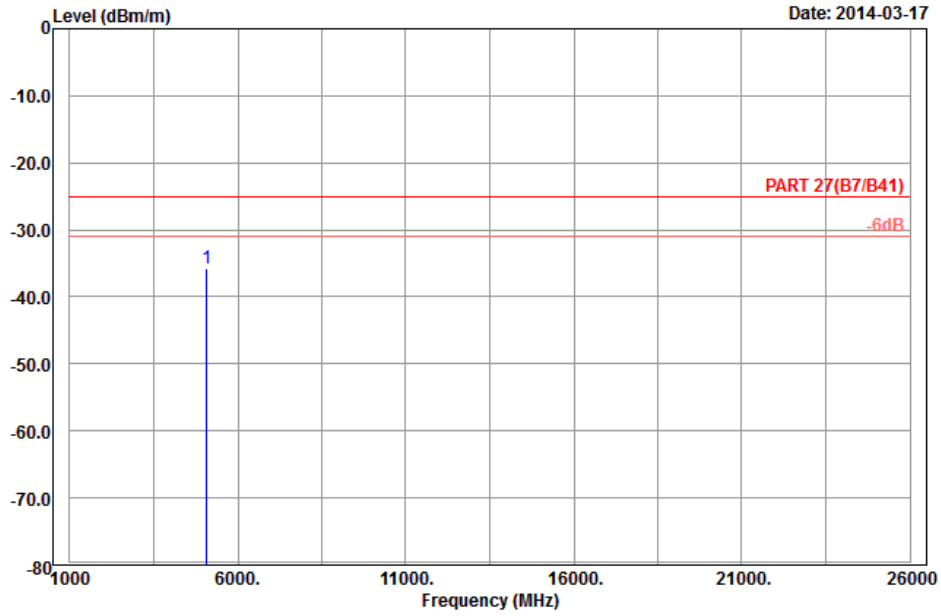

Site : 966 chamber 5
 Condition : PART 27(B7/B41) 3m Vertical
 Brand/Model: 0P8B100
 Remark : LTE_Band 7_QPSK(1,24)_5M_CH21100
 Tested by : Kay Wu
 Plane : Y

| | Freq | Level | Read Level | Limit Line | Over Limit | Factor | Remark |
|------|---------|--------|------------|------------|------------|--------|--------|
| | MHz | dBm/m | dBm | dBm/m | dB | dB/m | |
| 1 pp | 5074.40 | -35.78 | -55.17 | -25.00 | -10.78 | 19.39 | Peak |

CHANNEL BANDWIDTH: 10MHZ / QPSK



Bureau Veritas Consumer Products Services Ltd., Taoyuan Branch

A D T

Data: 15

Date: 2014-03-18

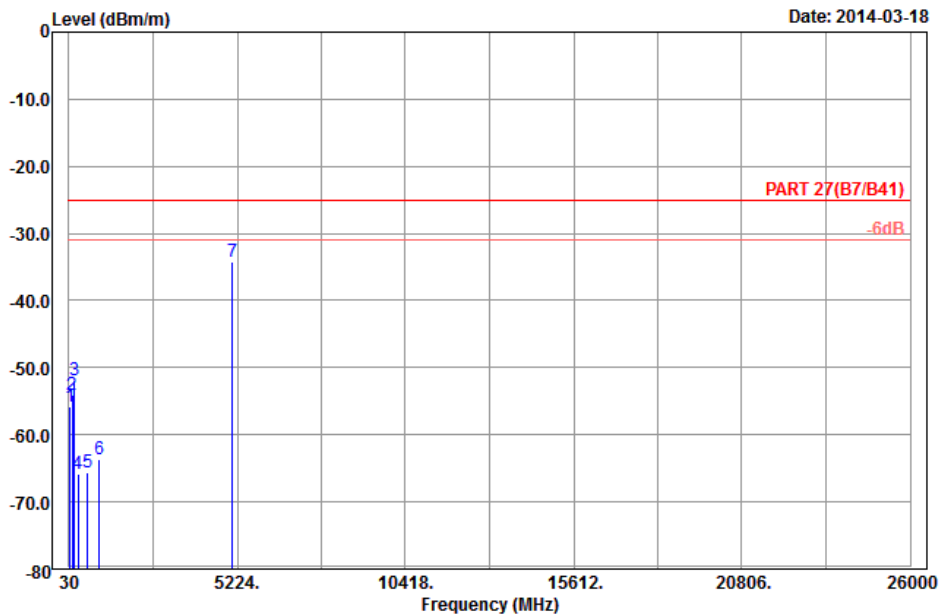

Site : 966 chamber 5
 Condition : PART 27(B7/B41) 3m Horizontal
 Brand/Model: 0P8B100
 Remark : LTE_Band 7_QPSK(1,49)_10M_CH21100
 Tested by : Kay Wu
 Plane : Y

| | Freq | Level | Read Level | Limit | Over | Factor | Remark |
|------|---------|--------|------------|--------|--------|--------|--------|
| | MHz | dBm/m | dBm | dBm/m | dB | dB/m | |
| 1 | 54.84 | -55.87 | -41.81 | -25.00 | -30.87 | -14.06 | Peak |
| 2 | 124.23 | -53.97 | -45.96 | -25.00 | -28.97 | -8.01 | Peak |
| 3 | 196.05 | -51.92 | -45.92 | -25.00 | -26.92 | -6.00 | Peak |
| 4 | 318.90 | -65.75 | -60.01 | -25.00 | -40.75 | -5.74 | Peak |
| 5 | 600.30 | -65.55 | -65.98 | -25.00 | -40.55 | 0.43 | Peak |
| 6 | 958.70 | -63.59 | -68.72 | -25.00 | -38.59 | 5.13 | Peak |
| 7 pp | 5078.80 | -34.18 | -53.68 | -25.00 | -9.18 | 19.50 | Peak |



A D T



Bureau Veritas Consumer Products Services Ltd., Taoyuan Branch

A D T

Data: 16

Date: 2014-03-18

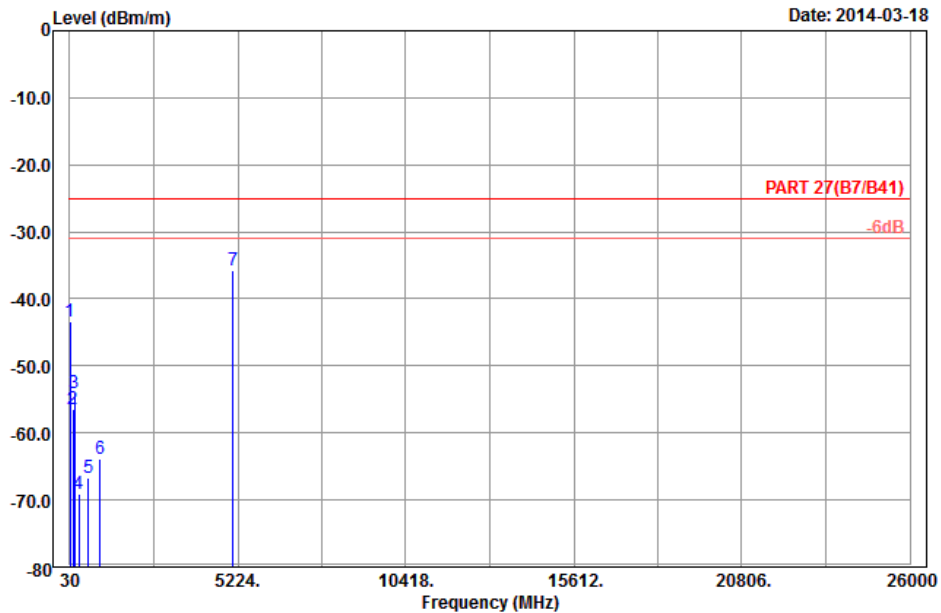

Site : 966 chamber 5
 Condition : PART 27(B7/B41) 3m Vertical
 Brand/Model: 0P8B100
 Remark : LTE_Band 7_QPSK(1,49)_10M_CH21100
 Tested by : Kay Wu
 Plane : Y

| | Read | Limit | Over | | | |
|------|---------|--------|--------|--------|--------|-------------|
| Freq | Level | Level | Line | Limit | Factor | Remark |
| MHz | dBm/m | dBm | dBm/m | dB | dB/m | |
| 1 | 48.09 | -43.35 | -29.92 | -25.00 | -18.35 | -13.43 Peak |
| 2 | 139.08 | -56.48 | -48.79 | -25.00 | -31.48 | -7.69 Peak |
| 3 | 176.61 | -53.96 | -47.97 | -25.00 | -28.96 | -5.99 Peak |
| 4 | 304.20 | -69.00 | -63.10 | -25.00 | -44.00 | -5.90 Peak |
| 5 | 599.60 | -66.80 | -67.19 | -25.00 | -41.80 | 0.39 Peak |
| 6 | 976.90 | -63.87 | -69.06 | -25.00 | -38.87 | 5.19 Peak |
| 7 pp | 5078.80 | -35.76 | -55.26 | -25.00 | -10.76 | 19.50 Peak |



A D T

CHANNEL BANDWIDTH: 15MHZ / QPSK



Bureau Veritas Consumer Products Services Ltd., Taoyuan Branch

A D T

Data: 11

Date: 2014-03-18

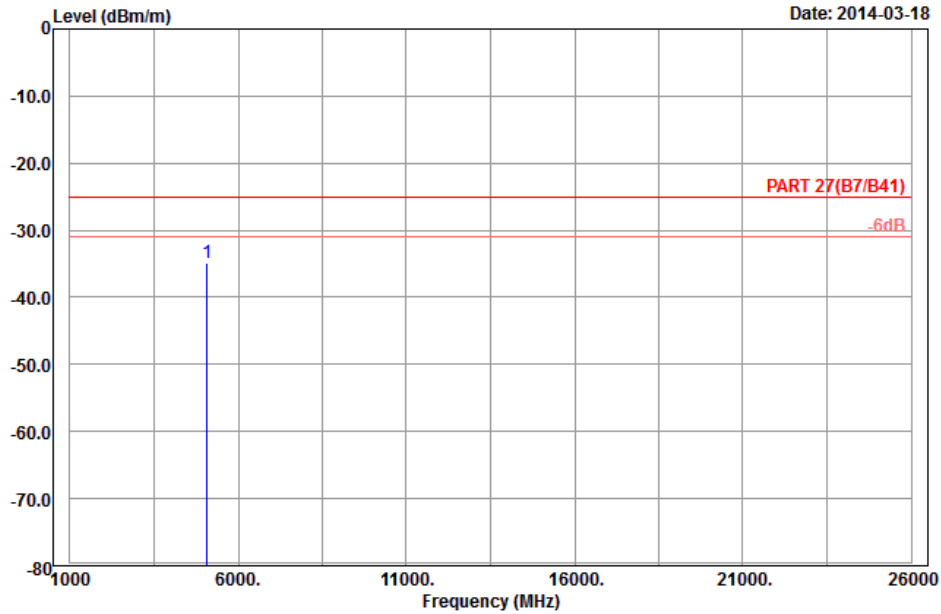

Site : 966 chamber 5
 Condition : PART 27(B7/B41) 3m Horizontal
 Brand/Model: 0P8B100
 Remark : LTE_Band 7_QPSK(1,74)_15M_CH21100
 Tested by : Kay Wu
 Plane : Y

| | Read | Limit | Over | | | |
|--------------|--------|--------|--------|-------|--------|--------|
| Freq | Level | Level | Line | Limit | Factor | Remark |
| MHz | dBm/m | dBm | dBm/m | dB | dB/m | |
| 1 pp 5083.20 | -34.83 | -54.33 | -25.00 | -9.83 | 19.50 | Peak |



A D T



Bureau Veritas Consumer Products Services Ltd., Taoyuan Branch

A D T

Data: 12

Date: 2014-03-18

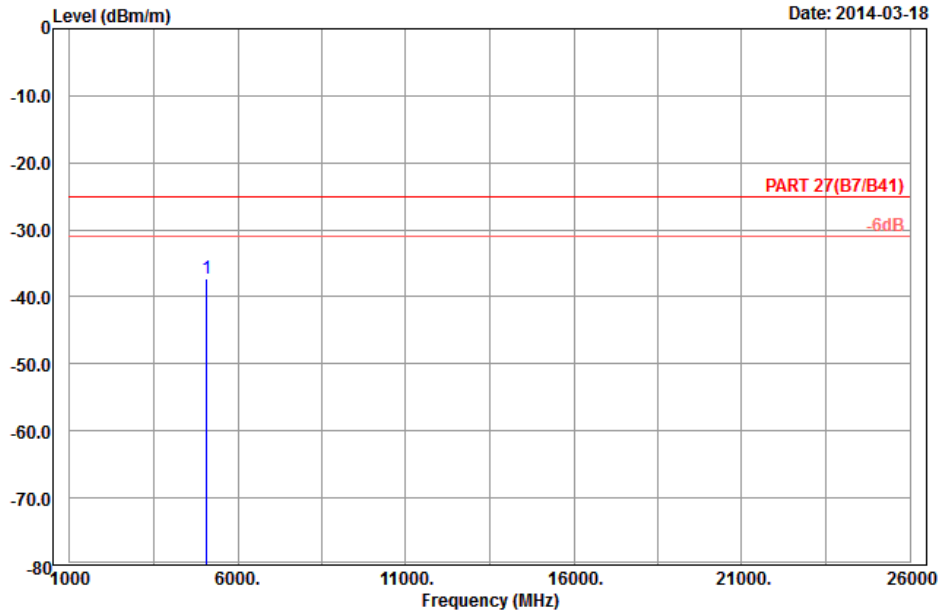

Site : 966 chamber 5
 Condition : PART 27(B7/B41) 3m Vertical
 Brand/Model: 0P8B100
 Remark : LTE_Band 7_QPSK(1,74)_15M_CH21100
 Tested by : Kay Wu
 Plane : Y

| | Read | Limit | Over | | |
|--------------|--------|--------|--------|--------|------------|
| Freq | Level | Level | Line | Limit | Factor |
| MHz | dBm/m | dBm | dBm/m | dB | dB/m |
| 1 pp 5083.20 | -37.36 | -56.86 | -25.00 | -12.36 | 19.50 Peak |



A D T

CHANNEL BANDWIDTH: 20MHZ / QPSK



Bureau Veritas Consumer Products Services Ltd., Taoyuan Branch

A D T

Data: 11

Date: 2014-03-18

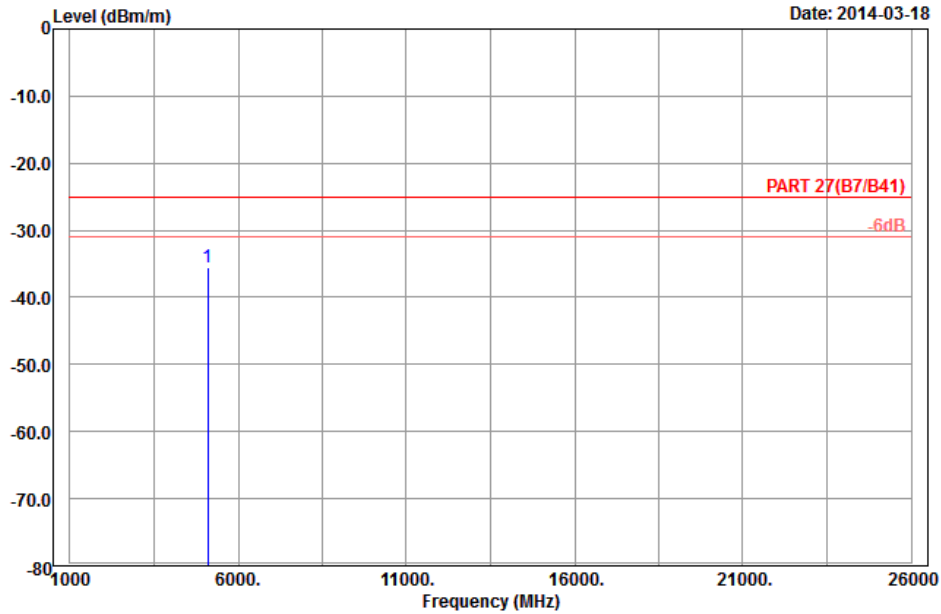

Site : 966 chamber 5
 Condition : PART 27(B7/B41) 3m Horizontal
 Brand/Model: 0P8B100
 Remark : LTE_Band 7_QPSK(1,99)_20M_CH21100
 Tested by : Kay Wu
 Plane : Y

| | Read | Limit | Over | | | |
|--------------|--------|--------|--------|--------|--------|--------|
| Freq | Level | Level | Line | Limit | Factor | Remark |
| MHz | dBm/m | dBm | dBm/m | dB | dB/m | |
| 1 pp 5087.60 | -35.54 | -55.04 | -25.00 | -10.54 | 19.50 | Peak |



A D T



Bureau Veritas Consumer Products Services Ltd., Taoyuan Branch

A D T

Data: 12

Date: 2014-03-18

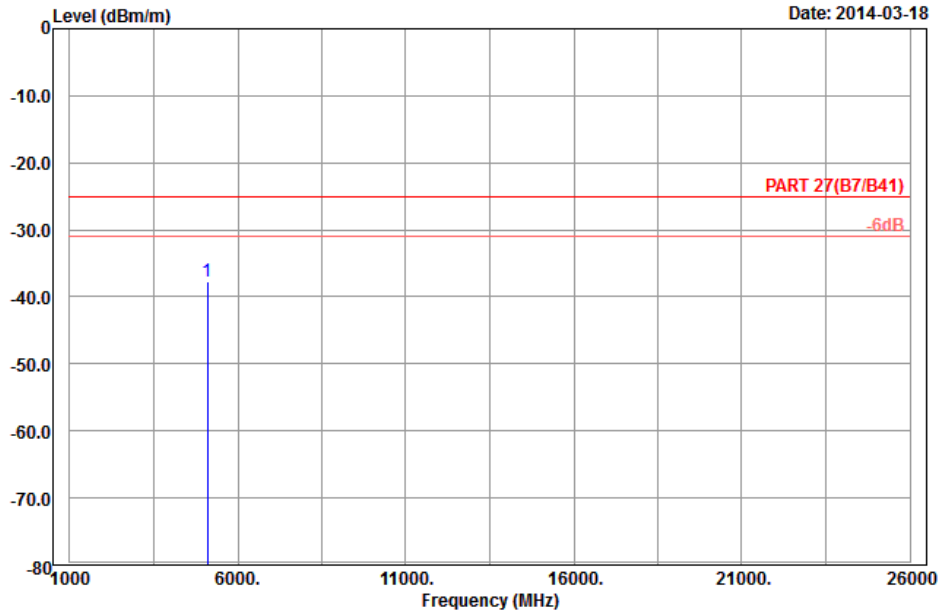

Site : 966 chamber 5
 Condition : PART 27(B7/B41) 3m Vertical
 Brand/Model: 0P8B100
 Remark : LTE_Band 7_QPSK(1,99)_20M_CH21100
 Tested by : Kay Wu
 Plane : Y

| | Freq | Level | Read Level | Limit Line | Over Limit | Factor | Remark |
|------|---------|--------|------------|------------|------------|--------|--------|
| | MHz | dBm/m | dBm | dBm/m | dB | dB/m | |
| 1 pp | 5087.60 | -37.66 | -57.16 | -25.00 | -12.66 | 19.50 | Peak |



5 INFORMATION ON THE TESTING LABORATORIES

We, Bureau Veritas Consumer Products Services (H.K.) Ltd., Taoyuan Branch, were founded in 1988 to provide our best service in EMC, Radio, Telecom and Safety consultation. Our laboratories are accredited and approved according to ISO/IEC 17025.

If you have any comments, please feel free to contact us at the following:

Linko EMC/RF Lab:

Tel: 886-2-26052180

Fax: 886-2-26051924

Hsin Chu EMC/RF Lab:

Tel: 886-3-5935343

Fax: 886-3-5935342

Hwa Ya EMC/RF/Safety/Telecom Lab:

Tel: 886-3-3183232

Fax: 886-3-3270892

Email: service.adt@tw.bureauveritas.com

Web Site: www.adt.com.tw

The address and road map of all our labs can be found in our web site also.

6 APPENDIX A – MODIFICATIONS RECORDERS FOR ENGINEERING CHANGES TO THE EUT BY THE LAB

No modifications were made to the EUT by the lab during the test.

---END---