



FCC TEST REPORT (15.247)

REPORT NO.: RF140303C07-1
MODEL NO.: 0P8B100
FCC ID: NM80P8B100
RECEIVED: Mar. 03, 2014
TESTED: Mar. 18, 2014 ~ Mar. 25, 2014
ISSUED: Apr. 15, 2014

APPLICANT: HTC Corporation

ADDRESS: 1F, 6-3 Baoqiang Road, Xindian District, New Taipei City, Taiwan 231

ISSUED BY: Bureau Veritas Consumer Products Services (H.K.) Ltd., Taoyuan Branch

LAB ADDRESS: No. 47, 14th Ling, Chia Pau Vil., Lin Kou Dist., New Taipei City, Taiwan (R.O.C)

TEST LOCATION: No. 19, Hwa Ya 2nd Rd, Wen Hwa Tsuen, Kwei Shan Hsiang, Taoyuan Hsien 333, Taiwan, R.O.C.

This report should not be used by the client to claim product certification, approval, or endorsement by TAF or any government agencies.



This report is for your exclusive use. Any copying or replication of this report to or for any other person or entity, or use of our name or trademark, is permitted only with our prior written permission. This report sets forth our findings solely with respect to the test samples identified herein. The results set forth in this report are not indicative or representative of the quality or characteristics of the lot from which a test sample was taken or any similar or identical product unless specifically and expressly noted. Our report includes all of the tests requested by you and the results thereof based upon the information that you provided to us. You have 60 days from date of issuance of this report to notify us of any material error or omission caused by our negligence, provided, however, that such notice shall be in writing and shall specifically address the issue you wish to raise. A failure to raise such issue within the prescribed time shall constitute your unqualified acceptance of the completeness of this report, the tests conducted and the correctness of the report contents. Unless specific mention, the uncertainty of measurement has been explicitly taken into account to declare the compliance or non-compliance to the specification.



TABLE OF CONTENTS

- RELEASE CONTROL RECORD5
- 1. CERTIFICATION.....6
- 2. SUMMARY OF TEST RESULTS7
 - 2.1 MEASUREMENT UNCERTAINTY.....7
- 3. GENERAL INFORMATION8
 - 3.1 GENERAL DESCRIPTION OF EUT8
 - 3.2 DESCRIPTION OF TEST MODES9
 - 3.2.1 TEST MODE APPLICABILITY AND TESTED CHANNEL DETAIL 10
 - 3.3 DESCRIPTION OF SUPPORT UNITS 14
 - 3.3.1 CONFIGURATION OF SYSTEM UNDER TEST 14
 - 3.4 DUTY CYCLE TEST SIGNAL 15
 - 3.5 GENERAL DESCRIPTION OF APPLIED STANDARDS 17
- 4. TEST TYPES AND RESULTS (FOR 2.4GHz BAND) 18
 - 4.1 RADIATED EMISSION AND BANDEDGE MEASUREMENT 18
 - 4.1.1 LIMITS OF RADIATED EMISSION AND BANDEDGE MEASUREMENT 18
 - 4.1.2 TEST INSTRUMENTS 19
 - 4.1.3 TEST PROCEDURES 20
 - 4.1.4 DEVIATION FROM TEST STANDARD 20
 - 4.1.5 TEST SETUP 21
 - 4.1.6 EUT OPERATING CONDITIONS 22
 - 4.1.7 TEST RESULTS..... 23
 - 4.2 CONDUCTED EMISSION MEASUREMENT 33
 - 4.2.1 LIMITS OF CONDUCTED EMISSION MEASUREMENT 33
 - 4.2.2 TEST INSTRUMENTS 33
 - 4.2.3 TEST PROCEDURES 34
 - 4.2.4 DEVIATION FROM TEST STANDARD 34
 - 4.2.5 TEST SETUP 35
 - 4.2.6 EUT OPERATING CONDITIONS 35
 - 4.2.7 TEST RESULTS..... 36
 - 4.3 6dB BANDWIDTH MEASUREMENT 38
 - 4.3.1 LIMITS OF 6dB BANDWIDTH MEASUREMENT 38
 - 4.3.2 TEST SETUP 38
 - 4.3.3 TEST INSTRUMENTS 38
 - 4.3.4 TEST PROCEDURE 38
 - 4.3.5 DEVIATION FROM TEST STANDARD 38
 - 4.3.6 EUT OPERATING CONDITIONS 38
 - 4.3.7 TEST RESULTS..... 39
 - 4.4 CONDUCTED OUTPUT POWER 41
 - 4.4.1 LIMITS OF CONDUCTED OUTPUT POWER MEASUREMENT 41
 - 4.4.2 TEST SETUP 41
 - 4.4.3 TEST INSTRUMENTS 41
 - 4.4.4 TEST PROCEDURES 41
 - 4.4.5 DEVIATION FROM TEST STANDARD 41
 - 4.4.6 EUT OPERATING CONDITIONS 41
 - 4.4.7 TEST RESULTS..... 42
 - 4.5 POWER SPECTRAL DENSITY MEASUREMENT 43
 - 4.5.1 LIMITS OF POWER SPECTRAL DENSITY MEASUREMENT 43
 - 4.5.2 TEST SETUP 43
 - 4.5.3 TEST INSTRUMENTS 43
 - 4.5.4 TEST PROCEDURE 43
 - 4.5.5 DEVIATION FROM TEST STANDARD 43
 - 4.5.6 EUT OPERATING CONDITION 43



4.5.7	TEST RESULTS.....	44
4.6	CONDUCTED OUT OF BAND EMISSION MEASUREMENT	46
4.6.1	LIMITS OF CONDUCTED OUT OF BAND EMISSION MEASUREMENT	46
4.6.2	TEST SETUP	46
4.6.3	TEST INSTRUMENTS	46
4.6.4	TEST PROCEDURE	46
4.6.5	DEVIATION FROM TEST STANDARD	46
4.6.6	EUT OPERATING CONDITION.....	46
4.6.7	TEST RESULTS.....	47
5.	TEST TYPES AND RESULTS (FOR 5.0GHz BAND)	50
5.1	RADIATED EMISSION AND BANDEDGE MEASUREMENT	50
5.1.1	LIMITS OF RADIATED EMISSION AND BANDEDGE MEASUREMENT	50
5.1.2	TEST INSTRUMENTS.....	51
5.1.3	TEST PROCEDURES	51
5.1.4	DEVIATION FROM TEST STANDARD	51
5.1.5	TEST SETUP	51
5.1.6	EUT OPERATING CONDITIONS	51
5.1.7	TEST RESULTS.....	52
5.2	CONDUCTED EMISSION MEASUREMENT	61
5.2.1	LIMITS OF CONDUCTED EMISSION MEASUREMENT	61
5.2.2	TEST INSTRUMENTS	61
5.2.3	TEST PROCEDURES	61
5.2.4	DEVIATION FROM TEST STANDARD	61
5.2.5	TEST SETUP	61
5.2.6	EUT OPERATING CONDITIONS	61
5.2.7	TEST RESULTS.....	62
5.3	6dB BANDWIDTH MEASUREMENT	64
5.3.1	LIMITS OF 6dB BANDWIDTH MEASUREMENT	64
5.3.2	TEST SETUP	64
5.3.3	TEST INSTRUMENTS.....	64
5.3.4	TEST PROCEDURE	64
5.3.5	DEVIATION FROM TEST STANDARD	64
5.3.6	EUT OPERATING CONDITIONS	64
5.3.7	TEST RESULTS.....	65
5.4	MAXIMUM OUTPUT POWER	67
5.4.1	LIMITS OF MAXIMUM OUTPUT POWER MEASUREMENT	67
5.4.2	TEST SETUP	67
5.4.3	INSTRUMENTS	67
5.4.4	TEST PROCEDURES	67
5.4.5	DEVIATION FROM TEST STANDARD	67
5.4.6	EUT OPERATING CONDITIONS	67
5.4.7	TEST RESULTS.....	68
5.5	POWER SPECTRAL DENSITY MEASUREMENT.....	69
5.5.1	LIMITS OF POWER SPECTRAL DENSITY MEASUREMENT	69
5.5.2	TEST SETUP	69
5.5.3	TEST INSTRUMENTS.....	69
5.5.4	TEST PROCEDURE	69
5.5.5	DEVIATION FROM TEST STANDARD	69
5.5.6	EUT OPERATING CONDITION.....	69
5.5.7	TEST RESULTS.....	70
5.6	CONDUCTED OUT OF BAND EMISSION MEASUREMENT	72
5.6.1	LIMITS OF OUT OF BAND EMISSION MEASUREMENT	72
5.6.2	TEST SETUP	72
5.6.3	TEST INSTRUMENTS.....	72
5.6.4	TEST PROCEDURE	72



A D T

5.6.5	DEVIATION FROM TEST STANDARD	72
5.6.6	EUT OPERATING CONDITION.....	72
5.6.7	TEST RESULTS.....	72
6.	PHOTOGRAPHS OF THE TEST CONFIGURATION.....	76
7.	INFORMATION ON THE TESTING LABORATORIES	77
8.	APPENDIX A – MODIFICATIONS RECORDERS FOR ENGINEERING CHANGES TO THE EUT BY THE LAB	78



A D T

RELEASE CONTROL RECORD

ISSUE NO.	REASON FOR CHANGE	DATE ISSUED
RF140303C07-1	Original release	Apr. 15, 2014

1. CERTIFICATION

PRODUCT: Smartphone
MODEL NO.: 0P8B100
BRAND: HTC
APPLICANT: HTC Corporation
TESTED: Mar. 18, 2014 ~ Mar. 25, 2014
TEST SAMPLE: PRODUCTION UNIT
STANDARDS: **FCC Part 15, Subpart C (Section 15.247)**
ANSI C63.10-2009

The above equipment (model: 0P8B100) has been tested by **Bureau Veritas Consumer Products Services (H.K.) Ltd., Taoyuan Branch**, and found compliance with the requirement of the above standards. The test record, data evaluation & Equipment Under Test (EUT) configurations represented herein are true and accurate accounts of the measurements of the sample's EMC characteristics under the conditions specified in this report.

PREPARED BY : Ivonne Wu , **DATE** : Apr. 15, 2014
Ivonne Wu / Supervisor

APPROVED BY : Sam Chen , **DATE** : Apr. 15, 2014
Sam Chen / Senior Project Engineer

2. SUMMARY OF TEST RESULTS

The EUT has been tested according to the following specifications:

APPLIED STANDARD: FCC PART 15, SUBPART C (SECTION 15.247)			
STANDARD SECTION	TEST TYPE	RESULT	REMARK
15.207	AC Power Conducted Emission	PASS	Meet the requirement of limit. Minimum passing margin is -10.76dB at 13.56250MHz.
15.247(d) 15.209	Radiated Emissions	PASS	Meet the requirement of limit. Minimum passing margin is -3.05dB at 2483.50MHz.
15.247(d)	Band Edge Measurement	PASS	Meet the requirement of limit.
15.247(a)(2)	6dB bandwidth	PASS	Meet the requirement of limit.
15.247(b)	Conducted power	PASS	Meet the requirement of limit.
15.247(e)	Power Spectral Density	PASS	Meet the requirement of limit.
15.203	Antenna Requirement	PASS	No antenna connector is used.

2.1 MEASUREMENT UNCERTAINTY

Where relevant, the following measurement uncertainty levels have been estimated for tests performed on the EUT as specified in CISPR 16-4-2:

MEASUREMENT	FREQUENCY	UNCERTAINTY
Conducted emissions	9kHz~30MHz	2.44 dB
Radiated emissions	30MHz ~ 200MHz	2.93 dB
	200MHz ~1000MHz	2.95 dB
	1GHz ~ 18GHz	2.26 dB
	18GHz ~ 40GHz	1.94 dB

This uncertainty represents an expanded uncertainty expressed at approximately the 95% confidence level using a coverage factor of $k = 2$.

3. GENERAL INFORMATION

3.1 GENERAL DESCRIPTION OF EUT

EUT	Smartphone
MODEL NO.	0P8B100
POWER SUPPLY	5.0Vdc (adapter or host equipment) 3.8Vdc (Li-ion battery)
MODULATION TYPE	CCK, DQPSK, DBPSK for DSSS 64QAM, 16QAM, QPSK, BPSK for OFDM
MODULATION TECHNOLOGY	DSSS, OFDM
TRANSFER RATE	802.11b: 11.0 / 5.5 / 2.0 / 1.0 Mbps 802.11g: 54.0 / 48.0 / 36.0 / 24.0 / 18.0 / 12.0 / 9.0 / 6.0 Mbps 802.11a: 54.0 / 48.0 / 36.0 / 24.0 / 18.0 / 12.0 / 9.0 / 6.0 Mbps 802.11n: up to MCS7
OPERATING FREQUENCY	2.4GHz: 2412 ~ 2462MHz 5.0GHz: 5745 ~ 5805MHz
NUMBER OF CHANNEL	2.4GHz: 11 for 802.11b, 802.11g, 802.11n (20MHz) 5.0GHz: 4 for 802.11a, 802.11n (20MHz) 2 for 802.11n (40MHz)
OUTPUT POWER	179.47mW for 2412 ~ 2462MHz 239.33mW for 5745 ~ 5805MHz
ANTENNA TYPE	2.4GHz: PIFA antenna with -3.7dBi gain 5.0GHz: PIFA antenna with -6.1dBi gain
ANTENNA CONNECTOR	NA
DATA CABLE	Refer to Note as below
I/O PORTS	Refer to user's manual
ACCESSORY DEVICES	Refer to Note as below

NOTE:

1. The EUT's accessories list refers to Ext. Pho.
2. The above EUT information is declared by the manufacturer and for more detailed features description, please refer to the manufacturer's specifications or User's Manual.

3.2 DESCRIPTION OF TEST MODES

FOR 2.4GHz:

11 channels are provided for 802.11b, 802.11g and 802.11n (20MHz):

CHANNEL	FREQUENCY	CHANNEL	FREQUENCY
1	2412MHz	7	2442MHz
2	2417MHz	8	2447MHz
3	2422MHz	9	2452MHz
4	2427MHz	10	2457MHz
5	2432MHz	11	2462MHz
6	2437MHz		

FOR 5.0GHz (5745 ~ 5805MHz):

4 channels are provided for 802.11a, 802.11n (20MHz):

CHANNEL	FREQUENCY	CHANNEL	FREQUENCY
149	5745MHz	157	5785MHz
153	5765MHz	161	5805MHz

2 channels are provided for 802.11n (40MHz):

CHANNEL	FREQUENCY	CHANNEL	FREQUENCY
151	5755MHz	159	5795MHz



A D T

3.2.1 TEST MODE APPLICABILITY AND TESTED CHANNEL DETAIL

WLAN 2.4GHz:

EUT CONFIGURE MODE	APPLICABLE TO				DESCRIPTION
	RE \geq 1G	RE $<$ 1G	PLC	APCM	
-	√	√	√	√	-

Where **RE \geq 1G:** Radiated Emission above 1GHz **RE $<$ 1G:** Radiated Emission below 1GHz
PLC: Power Line Conducted Emission **APCM:** Antenna Port Conducted Measurement

NOTE: The EUT had been pre-tested on the positioned of each 3 axis. The worst case was found when positioned on **Z-plane**.

RADIATED EMISSION TEST (ABOVE 1GHz):

Pre-Scan has been conducted to determine the worst-case mode from all possible combinations between available modulations, data rates and antenna ports (if EUT with antenna diversity architecture).

Following channel(s) was (were) selected for the final test as listed below.

EUT CONFIGURE MODE	MODE	AVAILABLE CHANNEL	TESTED CHANNEL	MODULATION TECHNOLOGY	MODULATION TYPE	DATA RATE (Mbps)
-	802.11b	1 to 11	1, 6, 11	DSSS	DBPSK	1.0
-	802.11g	1 to 11	1, 6, 11	OFDM	BPSK	6.0
-	802.11n (20MHz)	1 to 11	1, 6, 11	OFDM	BPSK	MCS0

RADIATED EMISSION TEST (BELOW 1GHz):

Pre-Scan has been conducted to determine the worst-case mode from all possible combinations between available modulations, data rates and antenna ports (if EUT with antenna diversity architecture).

Following channel(s) was (were) selected for the final test as listed below.

EUT CONFIGURE MODE	MODE	AVAILABLE CHANNEL	TESTED CHANNEL	MODULATION TECHNOLOGY	MODULATION TYPE	DATA RATE (Mbps)
-	802.11n (20MHz)	1 to 11	11	OFDM	BPSK	MCS0

POWER LINE CONDUCTED EMISSION TEST:

EUT CONFIGURE MODE	MODE	AVAILABLE CHANNEL	TESTED CHANNEL	MODULATION TECHNOLOGY	MODULATION TYPE	DATA RATE (Mbps)
-	802.11n (20MHz)	1 to 11	11	OFDM	BPSK	MCS0



A D T

BANDEDGE MEASUREMENT:

- Pre-Scan has been conducted to determine the worst-case mode from all possible combinations between available modulations, data rates and antenna ports (if EUT with antenna diversity architecture).
- Following channel(s) was (were) selected for the final test as listed below.

EUT CONFIGURE MODE	MODE	AVAILABLE CHANNEL	TESTED CHANNEL	MODULATION TECHNOLOGY	MODULATION TYPE	DATA RATE (Mbps)
-	802.11b	1 to 11	1, 6, 11	DSSS	DBPSK	1.0
-	802.11g	1 to 11	1, 6, 11	OFDM	BPSK	6.0
-	802.11n (20MHz)	1 to 11	1, 6, 11	OFDM	BPSK	MCS0

ANTENNA PORT CONDUCTED MEASUREMENT:

- This item includes all test value of each mode, but only includes spectrum plot of worst value of each mode.
- Pre-Scan has been conducted to determine the worst-case mode from all possible combinations between available modulations, data rates and antenna ports (if EUT with antenna diversity architecture).
- Following channel(s) was (were) selected for the final test as listed below.

EUT CONFIGURE MODE	MODE	AVAILABLE CHANNEL	TESTED CHANNEL	MODULATION TECHNOLOGY	MODULATION TYPE	DATA RATE (Mbps)
-	802.11b	1 to 11	1, 6, 11	DSSS	DBPSK	1.0
-	802.11g	1 to 11	1, 6, 11	OFDM	BPSK	6.0
-	802.11n (20MHz)	1 to 11	1, 6, 11	OFDM	BPSK	MCS0

Test CONDITION:

APPLICABLE TO	ENVIRONMENTAL CONDITIONS	INPUT POWER	TESTED BY
RE \geq 1G	25deg. C, 65%RH	120Vac, 60Hz	Kay Wu
RE $<$ 1G	25deg. C, 65%RH	120Vac, 60Hz	Kay Wu
PLC	25deg. C, 65%RH	120Vac, 60Hz	Peter Weng
APCM	25deg. C, 65%RH	120Vac, 60Hz	Howard Kao



A D T

WLAN 5.0GHz (5745 ~ 5805MHz):

EUT CONFIGURE MODE	APPLICABLE TO				DESCRIPTION
	RE≥1G	RE<1G	PLC	APCM	
-	√	√	√	√	-

Where **RE≥1G:** Radiated Emission above 1GHz **RE<1G:** Radiated Emission below 1GHz
PLC: Power Line Conducted Emission **APCM:** Antenna Port Conducted Measurement

NOTE: The EUT had been pre-tested on the positioned of each 3 axis. The worst case was found when positioned on **Y-plane**.

RADIATED EMISSION TEST (ABOVE 1GHz):

- Pre-Scan has been conducted to determine the worst-case mode from all possible combinations between available modulations, data rates and antenna ports (if EUT with antenna diversity architecture).
- Following channel(s) was (were) selected for the final test as listed below.

EUT CONFIGURE MODE	MODE	AVAILABLE CHANNEL	TESTED CHANNEL	MODULATION TECHNOLOGY	MODULATION TYPE	DATA RATE (Mbps)
-	802.11a	149 to 161	149, 157, 161	OFDM	BPSK	6.0
-	802.11n (20MHz)	149 to 161	149, 157, 161	OFDM	BPSK	MCS0
-	802.11n (40MHz)	151 to 159	151, 159	OFDM	BPSK	MCS0

RADIATED EMISSION TEST (BELOW 1GHz):

- Pre-Scan has been conducted to determine the worst-case mode from all possible combinations between available modulations, data rates and antenna ports (if EUT with antenna diversity architecture).
- Following channel(s) was (were) selected for the final test as listed below.

EUT CONFIGURE MODE	MODE	AVAILABLE CHANNEL	TESTED CHANNEL	MODULATION TECHNOLOGY	MODULATION TYPE	DATA RATE (Mbps)
-	802.11n (40MHz)	151 to 159	151	OFDM	BPSK	MCS0

POWER LINE CONDUCTED EMISSION TEST:

EUT CONFIGURE MODE	MODE	AVAILABLE CHANNEL	TESTED CHANNEL	MODULATION TECHNOLOGY	MODULATION TYPE	DATA RATE (Mbps)
-	802.11n (40MHz)	151 to 159	151	OFDM	BPSK	MCS0



BANDEDGE MEASUREMENT:

Pre-Scan has been conducted to determine the worst-case mode from all possible combinations between available modulations, data rates and antenna ports (if EUT with antenna diversity architecture).

Following channel(s) was (were) selected for the final test as listed below.

EUT CONFIGURE MODE	MODE	AVAILABLE CHANNEL	TESTED CHANNEL	MODULATION TECHNOLOGY	MODULATION TYPE	DATA RATE (Mbps)
-	802.11a	149 to 161	149, 157, 161	OFDM	BPSK	6.0
-	802.11n (20MHz)	149 to 161	149, 157, 161	OFDM	BPSK	MCS0
-	802.11n (40MHz)	151 to 159	151, 159	OFDM	BPSK	MCS0

ANTENNA PORT CONDUCTED MEASUREMENT:

Pre-Scan has been conducted to determine the worst-case mode from all possible combinations between available modulations, data rates and antenna ports (if EUT with antenna diversity architecture).

Following channel(s) was (were) selected for the final test as listed below.

EUT CONFIGURE MODE	MODE	AVAILABLE CHANNEL	TESTED CHANNEL	MODULATION TECHNOLOGY	MODULATION TYPE	DATA RATE (Mbps)
-	802.11a	149 to 161	149, 157, 161	OFDM	BPSK	6.0
-	802.11n (20MHz)	149 to 161	149, 157, 161	OFDM	BPSK	MCS0
-	802.11n (40MHz)	151 to 159	151, 159	OFDM	BPSK	MCS0

Test CONDITION:

APPLICABLE TO	ENVIRONMENTAL CONDITIONS	INPUT POWER	TESTED BY
RE≥1G	25deg. C, 65%RH	120Vac, 60Hz	Kay Wu
RE<1G	25deg. C, 65%RH	120Vac, 60Hz	Kay Wu
PLC	25deg. C, 65%RH	120Vac, 60Hz	Peter Weng
APCM	25deg. C, 65%RH	120Vac, 60Hz	Howard Kao

3.3 DESCRIPTION OF SUPPORT UNITS

The EUT has been tested as an independent unit together with other necessary accessories or support units.

3.3.1 CONFIGURATION OF SYSTEM UNDER TEST

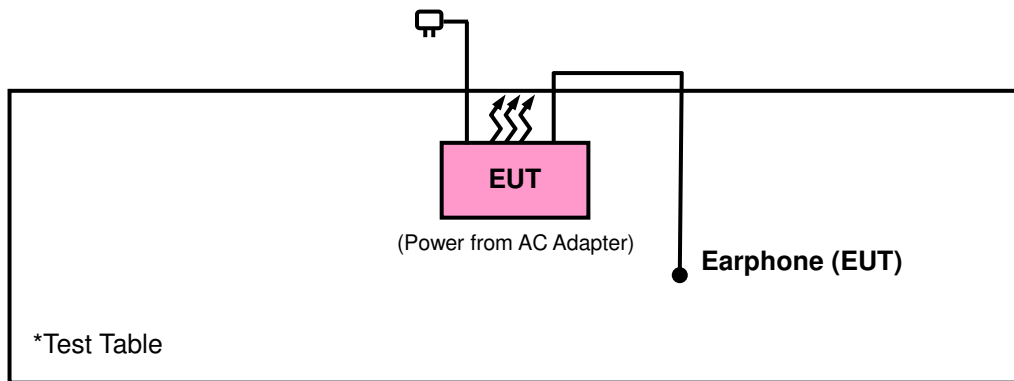



A D T

3.4 DUTY CYCLE TEST SIGNAL

WLAN 2.4GHz

802.11b: Duty cycle of test signal is 100 %, duty factor is not required.

Duty cycle of test signal is > 98 %, duty factor is not required.

802.11g: Duty cycle = 1.357/1.378 = 0.985

802.11n (20MHz): Duty cycle = 1.264/1.283 = 0.985

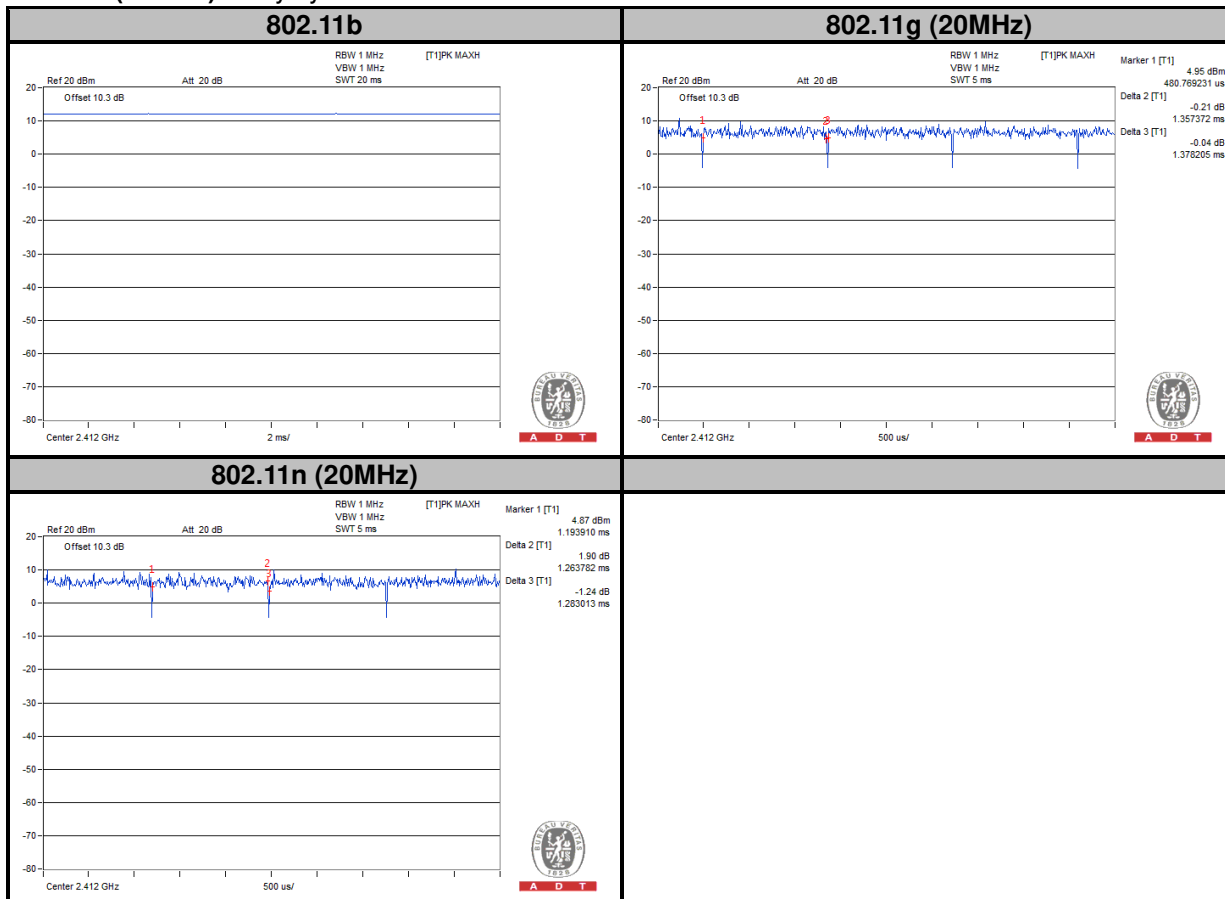



A D T

5725MHz ~ 5850MHz

Duty cycle of test signal is > 98 %, duty factor is not required.

802.11a: Duty cycle = 1.356/1.375 = 0.986

802.11n (20MHz): Duty cycle = 1.267/1.283 = 0.988

802.11n (40MHz): Duty cycle = 603.53/643.59 = 0.938, Duty factor = $10 * \log(1/0.938) = 0.28$





3.5 GENERAL DESCRIPTION OF APPLIED STANDARDS

The EUT is a RF Product. According to the specifications of the manufacturer, it must comply with the requirements of the following standards:

FCC Part 15, Subpart C (15.247)

ANSI C63.10-2009

558074 D01 DTS Meas Guidance v03r01

All test items have been performed and recorded as per the above standards.

NOTE: The EUT is also considered as a kind of computer peripheral, because the connection to computer is necessary for typical use. It has been verified to comply with the requirements of FCC Part 15, Subpart B, Class B (DoC). The test report has been issued separately.

4. TEST TYPES AND RESULTS (FOR 2.4GHz BAND)

4.1 RADIATED EMISSION AND BANDEDGE MEASUREMENT

4.1.1 LIMITS OF RADIATED EMISSION AND BANDEDGE MEASUREMENT

Radiated emissions which fall in the restricted bands must comply with the radiated emission limits specified as below table. Other emissions shall be at least 20dB below the highest level of the desired power:

FREQUENCIES (MHz)	FIELD STRENGTH (microvolts/meter)	MEASUREMENT DISTANCE (meters)
0.009 ~ 0.490	2400/F(kHz)	300
0.490 ~ 1.705	24000/F(kHz)	30
1.705 ~ 30.0	30	30
30 ~ 88	100	3
88 ~ 216	150	3
216 ~ 960	200	3
Above 960	500	3

NOTE:

1. The lower limit shall apply at the transition frequencies.
2. Emission level (dBuV/m) = 20 log Emission level (uV/m).
3. For frequencies above 1000MHz, the field strength limits are based on average detector, however, the peak field strength of any emission shall not exceed the maximum permitted average limits, specified above by more than 20dB under any condition of modulation.



A D T

4.1.2 TEST INSTRUMENTS

DESCRIPTION & MANUFACTURER	MODEL NO.	SERIAL NO.	DATE OF CALIBRATION	DUE DATE OF CALIBRATION
Test Receiver ROHDE & SCHWARZ	ESCI	100744	Apr. 15, 2013	Apr. 14, 2014
Spectrum Analyzer ROHDE & SCHWARZ	FSU43	101261	Dec. 21, 2013	Dec. 20, 2014
BILOG Antenna SCHWARZBECK	VULB9168	9168-472	Feb. 27, 2014	Feb. 26, 2015
HORN Antenna SCHWARZBECK	BBHA 9120 D	9120D-969	Feb. 19, 2014	Feb. 18, 2015
HORN Antenna SCHWARZBECK	BBHA 9170	9170-480	Dec. 18, 2013	Dec. 17, 2014
Loop Antenna	HFH2-Z2	100070	Mar. 06, 2014	Mar. 05, 2016
Preamplifier EMCI	EMC 012645	980115	Dec. 26, 2013	Dec. 25, 2014
Preamplifier EMCI	EMC 184045	980116	Jan. 13, 2014	Jan. 12, 2015
Preamplifier EMCI	EMC 330H	980112	Dec. 27, 2013	Dec. 26, 2014
RF signal cable HUBER+SUHNNER	SUCOFLEX 104	309219/4 2950114	Oct. 18, 2013	Oct. 17, 2014
RF signal cable HUBER+SUHNNER	SUCOFLEX 104	250130/4	Oct. 18, 2013	Oct. 17, 2014
RF signal cable Worken	RG-213	NA	Nov. 07, 2013	Nov. 06, 2014
Software BV ADT	E3 6.120103	NA	NA	NA
Antenna Tower MF	MFA-440H	NA	NA	NA
Turn Table MF	MFT-201SS	NA	NA	NA
Antenna Tower & Turn Table Controller MF	MF-7802	NA	NA	NA
Power Meter	ML2495A	1232002	Aug. 23, 2013	Aug. 22, 2014
Power Sensor	MA2411B	1207325	Aug. 23, 2013	Aug. 22, 2014

- NOTE:**
1. The calibration interval of the above test instruments is 12 months and the calibrations are traceable to NML/ROC and NIST/USA.
 2. The calibration interval of the loop antenna is 24 months and the calibrations are traceable to NML/ROC and NIST/USA.
 3. The test was performed in HwaYa Chamber 10.
 4. The horn antenna and HP preamplifier (model: 8449B) are used only for the measurement of emission frequency above 1GHz if tested.
 5. The FCC Site Registration No. is 690701.
 6. The IC Site Registration No. is IC 7450F-10.

4.1.3 TEST PROCEDURES

- a. The EUT was placed on the top of a rotating table 0.8 meters above the ground at a 3 meters semi-anechoic chamber. The table was rotated 360 degrees to determine the position of the highest radiation.
- b. The EUT was set 3 meters away from the interference-receiving antenna, which was mounted on the top of a variable-height antenna tower.
- c. Height of receiving antenna is varied from one meter to four meters above the ground to determine the maximum value of the field strength. Both horizontal and vertical polarizations of the antenna are set to make the measurement.
- d. For each suspected emission, the EUT was arranged to its worst case and then the antenna was tuned to heights from 1 meter to 4 meters and the rotatable table was turned from 0 degrees to 360 degrees to find the maximum reading.
- e. The test-receiver system was set to Peak Detect Function and Specified Bandwidth with Maximum Hold Mode.
- f. If the emission level of the EUT in peak mode was lower than the limit specified, then testing could be stopped and the peak values of the EUT would be reported. Otherwise the emissions would be re-tested one by one using peak, quasi-peak or average method as specified and then reported in a data sheet.

NOTE:

1. The resolution bandwidth and video bandwidth of test receiver/spectrum analyzer is 120kHz for Quasi-peak detection at frequency below 1GHz.
2. The resolution bandwidth of test receiver/spectrum analyzer is 1MHz and video bandwidth is 3MHz for Peak detection at frequency above 1GHz.
3. The resolution bandwidth of test receiver/spectrum analyzer is 1MHz and the video bandwidth is 1kHz (Duty cycle < 98%) or 10Hz (Duty cycle > 98%) for Average detection (AV) at frequency above 1GHz.
4. All modes of operation were investigated and the worst-case emissions are reported.

4.1.4 DEVIATION FROM TEST STANDARD

No deviation.

4.1.5 TEST SETUP

Frequency Range 30MHz ~ 1GHz

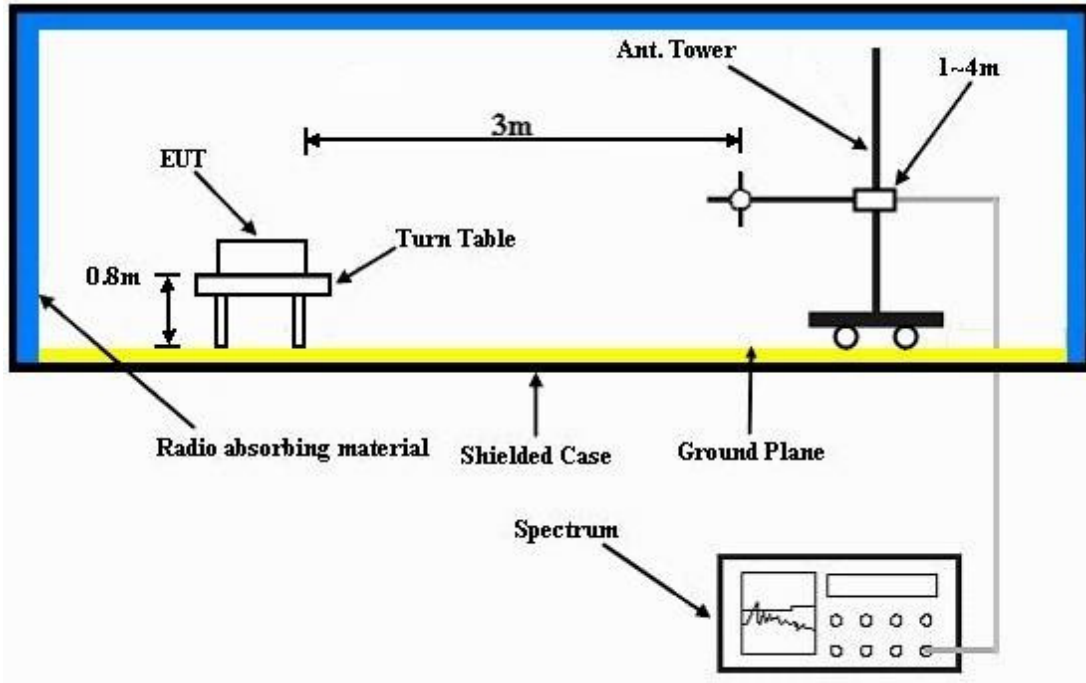

Frequency Range above 1GHz

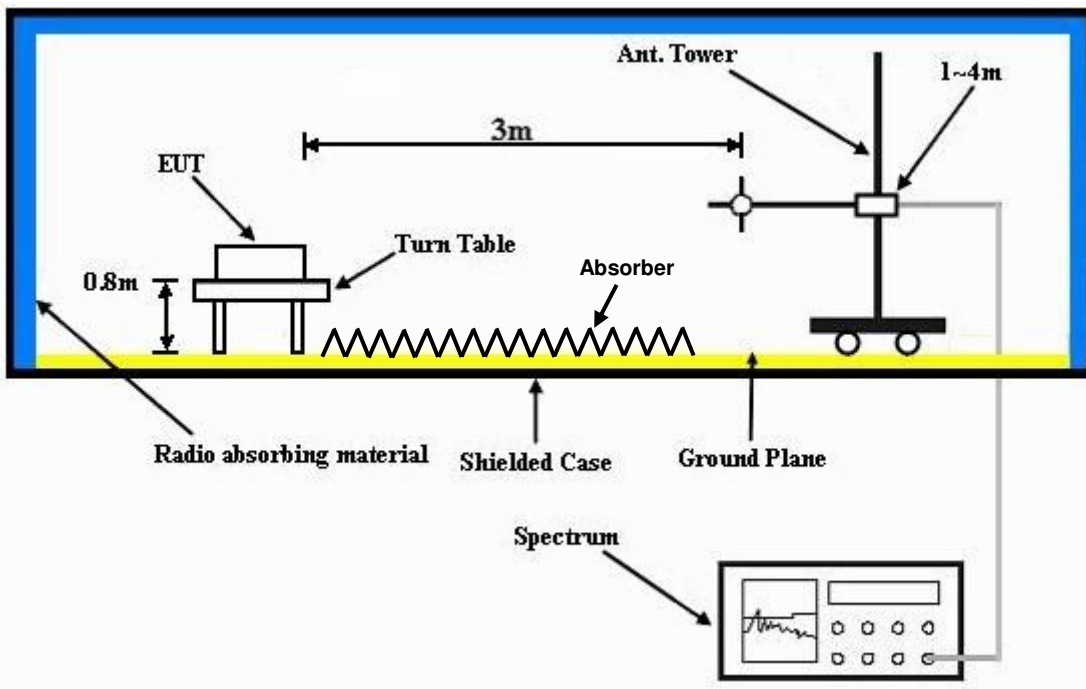

For the actual test configuration, please refer to the attached file (Test Setup Photo).



A D T

4.1.6 EUT OPERATING CONDITIONS

- a. Placed the EUT on a testing table.
- b. Use the software to control the EUT under transmission condition continuously at specific channel frequency.



A D T

4.1.7 TEST RESULTS

ABOVE 1GHz WORST-CASE DATA

802.11b

EUT TEST CONDITION		MEASUREMENT DETAIL	
CHANNEL	Channel 1	FREQUENCY RANGE	1GHz ~ 25GHz
INPUT POWER	120Vac, 60 Hz	DETECTOR FUNCTION	Peak (PK) Average (AV)
ENVIRONMENTAL CONDITIONS	25deg. C, 65%RH	TESTED BY	Kay Wu

ANTENNA POLARITY & TEST DISTANCE: HORIZONTAL AT 3 M

FREQ. (MHz)	EMISSION LEVEL (dBuV/m)	READ LEVEL (dBuV)	LIMIT (dBuV/m)	MARGIN (dB)	ANTENNA FACTOR (dB/m)	CABLE LOSS (dB)	PREAMP FACTOR (dB)	ANTENNA HEIGHT (cm)	TABLE ANGLE (Degree)	REMARK
2346	39.94	38.37	54	-14.06	31.74	5.33	35.5	118	40	Average
2346	55.03	53.46	74	-18.97	31.74	5.33	35.5	118	40	Peak
2412	102.83	101.06			31.81	5.43	35.47	118	40	Average
2412	105.75	103.98			31.81	5.43	35.47	118	40	Peak
2486	40.94	38.95	54	-13.06	31.88	5.53	35.42	118	40	Average
2486	55.08	53.09	74	-18.92	31.88	5.53	35.42	118	40	Peak
4824	46.02	37.89	54	-7.98	33.97	8.26	34.1	154	0	Average
4824	50.81	42.68	74	-23.19	33.97	8.26	34.1	154	0	Peak

ANTENNA POLARITY & TEST DISTANCE: VERTICAL AT 3 M

FREQ. (MHz)	EMISSION LEVEL (dBuV/m)	READ LEVEL (dBuV)	LIMIT (dBuV/m)	MARGIN (dB)	ANTENNA FACTOR (dB/m)	CABLE LOSS (dB)	PREAMP FACTOR (dB)	ANTENNA HEIGHT (cm)	TABLE ANGLE (Degree)	REMARK
2384	40.7	39.01	54	-13.3	31.78	5.4	35.49	109	34	Average
2384	56.08	54.39	74	-17.92	31.78	5.4	35.49	109	34	Peak
2412	104.65	102.88			31.81	5.43	35.47	109	34	Average
2412	107.35	105.58			31.81	5.43	35.47	109	34	Peak
2486	39.98	37.99	54	-14.02	31.88	5.53	35.42	109	34	Average
2486	55.1	53.11	74	-18.9	31.88	5.53	35.42	109	34	Peak
4824	46.65	38.52	54	-7.35	33.97	8.26	34.1	100	40	Average
4824	50.28	42.15	74	-23.72	33.97	8.26	34.1	100	40	Peak

REMARKS:

- Emission Level = Read Level + Antenna Factor + Cable Loss - Preamp Factor
Margin value = Emission level – Limit value
- 2412MHz: Fundamental frequency.



A D T

EUT TEST CONDITION		MEASUREMENT DETAIL	
CHANNEL	Channel 6	FREQUENCY RANGE	1GHz ~ 25GHz
INPUT POWER	120Vac, 60 Hz	DETECTOR FUNCTION	Peak (PK) Average (AV)
ENVIRONMENTAL CONDITIONS	25deg. C, 65%RH	TESTED BY	Kay Wu

ANTENNA POLARITY & TEST DISTANCE: HORIZONTAL AT 3 M

FREQ. (MHz)	EMISSION LEVEL (dBuV/m)	READ LEVEL (dBuV)	LIMIT (dBuV/m)	MARGIN (dB)	ANTENNA FACTOR (dB/m)	CABLE LOSS (dB)	PREAMP FACTOR (dB)	ANTENNA HEIGHT (cm)	TABLE ANGLE (Degree)	REMARK
2358	39.65	38.02	54	-14.35	31.76	5.37	35.5	142	30	Average
2358	56.06	54.43	74	-17.94	31.76	5.37	35.5	142	30	Peak
2437	102.57	100.72			31.85	5.46	35.46	142	30	Average
2437	105.93	104.08			31.85	5.46	35.46	142	30	Peak
2498	40.96	38.94	54	-13.04	31.9	5.53	35.41	142	30	Average
2498	55.17	53.15	74	-18.83	31.9	5.53	35.41	142	30	Peak
4874	48.94	40.75	54	-5.06	33.98	8.27	34.06	152	0	Average
4874	51.68	43.49	74	-22.32	33.98	8.27	34.06	152	0	Peak

ANTENNA POLARITY & TEST DISTANCE: VERTICAL AT 3 M

FREQ. (MHz)	EMISSION LEVEL (dBuV/m)	READ LEVEL (dBuV)	LIMIT (dBuV/m)	MARGIN (dB)	ANTENNA FACTOR (dB/m)	CABLE LOSS (dB)	PREAMP FACTOR (dB)	ANTENNA HEIGHT (cm)	TABLE ANGLE (Degree)	REMARK
2332	40.63	39.09	54	-13.37	31.73	5.33	35.52	101	28	Average
2332	55.35	53.81	74	-18.65	31.73	5.33	35.52	101	28	Peak
2437	106.01	104.16			31.85	5.46	35.46	101	28	Average
2437	108.63	106.78			31.85	5.46	35.46	101	28	Peak
2486	41	39.01	54	-13	31.88	5.53	35.42	101	28	Average
2486	55.56	53.57	74	-18.44	31.88	5.53	35.42	101	28	Peak
4874	45.97	37.78	54	-8.03	33.98	8.27	34.06	169	102	Average
4874	49.39	41.2	74	-24.61	33.98	8.27	34.06	169	102	Peak

REMARKS:

- Emission Level = Read Level + Antenna Factor + Cable Loss - Preamp Factor
Margin value = Emission level – Limit value
- 2437MHz: Fundamental frequency.



A D T

EUT TEST CONDITION		MEASUREMENT DETAIL	
CHANNEL	Channel 11	FREQUENCY RANGE	1GHz ~ 25GHz
INPUT POWER	120Vac, 60 Hz	DETECTOR FUNCTION	Peak (PK) Average (AV)
ENVIRONMENTAL CONDITIONS	25deg. C, 65%RH	TESTED BY	Kay Wu

ANTENNA POLARITY & TEST DISTANCE: HORIZONTAL AT 3 M

FREQ. (MHz)	EMISSION LEVEL (dBuV/m)	READ LEVEL (dBuV)	LIMIT (dBuV/m)	MARGIN (dB)	ANTENNA FACTOR (dB/m)	CABLE LOSS (dB)	PREAMP FACTOR (dB)	ANTENNA HEIGHT (cm)	TABLE ANGLE (Degree)	REMARK
2312	40.54	39.06	54	-13.46	31.71	5.3	35.53	142	30	Average
2312	55.52	54.04	74	-18.48	31.71	5.3	35.53	142	30	Peak
2462	100.93	99			31.87	5.5	35.44	142	30	Average
2462	103.75	101.82			31.87	5.5	35.44	142	30	Peak
2488	42.98	40.97	54	-11.02	31.9	5.53	35.42	142	30	Average
2488	57.17	55.16	74	-16.83	31.9	5.53	35.42	142	30	Peak
4924	48.65	40.4	54	-5.35	33.99	8.28	34.02	132	0	Average
4924	51.7	43.45	74	-22.3	33.99	8.28	34.02	132	0	Peak

ANTENNA POLARITY & TEST DISTANCE: VERTICAL AT 3 M

FREQ. (MHz)	EMISSION LEVEL (dBuV/m)	READ LEVEL (dBuV)	LIMIT (dBuV/m)	MARGIN (dB)	ANTENNA FACTOR (dB/m)	CABLE LOSS (dB)	PREAMP FACTOR (dB)	ANTENNA HEIGHT (cm)	TABLE ANGLE (Degree)	REMARK
2358	40.65	39.02	54	-13.35	31.76	5.37	35.5	107	32	Average
2358	55.47	53.84	74	-18.53	31.76	5.37	35.5	107	32	Peak
2462	103.69	101.76			31.87	5.5	35.44	107	32	Average
2462	106.39	104.46			31.87	5.5	35.44	107	32	Peak
2483.5	48.02	46.06	54	-5.98	31.88	5.5	35.42	107	32	Average
2483.5	57.51	55.55	74	-16.49	31.88	5.5	35.42	107	32	Peak
4924	50.29	42.04	54	-3.71	33.99	8.28	34.02	179	170	Average
4924	53.62	45.37	74	-20.38	33.99	8.28	34.02	179	170	Peak

REMARKS:

- Emission Level = Read Level + Antenna Factor + Cable Loss - Preamp Factor
Margin value = Emission level – Limit value
- 2462MHz: Fundamental frequency.



A D T

802.11g

EUT TEST CONDITION		MEASUREMENT DETAIL	
CHANNEL	Channel 1	FREQUENCY RANGE	1GHz ~ 25GHz
INPUT POWER	120Vac, 60 Hz	DETECTOR FUNCTION	Peak (PK) Average (AV)
ENVIRONMENTAL CONDITIONS	25deg. C, 65%RH	TESTED BY	Kay Wu

ANTENNA POLARITY & TEST DISTANCE: HORIZONTAL AT 3 M

FREQ. (MHz)	EMISSION LEVEL (dBuV/m)	READ LEVEL (dBuV)	LIMIT (dBuV/m)	MARGIN (dB)	ANTENNA FACTOR (dB/m)	CABLE LOSS (dB)	PREAMP FACTOR (dB)	ANTENNA HEIGHT (cm)	TABLE ANGLE (Degree)	REMARK
2390	44.72	42.99	54	-9.28	31.8	5.4	35.47	117	39	Average
2390	61.16	59.43	74	-12.84	31.8	5.4	35.47	117	39	Peak
2412	95.22	93.45			31.81	5.43	35.47	117	39	Average
2412	103.58	101.81			31.81	5.43	35.47	117	39	Peak
2500	39.96	37.94	54	-14.04	31.9	5.53	35.41	117	39	Average
2500	55.31	53.29	74	-18.69	31.9	5.53	35.41	117	39	Peak

ANTENNA POLARITY & TEST DISTANCE: VERTICAL AT 3 M

FREQ. (MHz)	EMISSION LEVEL (dBuV/m)	READ LEVEL (dBuV)	LIMIT (dBuV/m)	MARGIN (dB)	ANTENNA FACTOR (dB/m)	CABLE LOSS (dB)	PREAMP FACTOR (dB)	ANTENNA HEIGHT (cm)	TABLE ANGLE (Degree)	REMARK
2390	46.61	44.88	54	-7.39	31.8	5.4	35.47	103	28	Average
2390	64.18	62.45	74	-9.82	31.8	5.4	35.47	103	28	Peak
2412	98.37	96.6			31.81	5.43	35.47	103	28	Average
2412	106.53	104.76			31.81	5.43	35.47	103	28	Peak
2490	40.99	38.98	54	-13.01	31.9	5.53	35.42	103	28	Average
2490	55.95	53.94	74	-18.05	31.9	5.53	35.42	103	28	Peak

REMARKS:

- Emission Level = Read Level + Antenna Factor + Cable Loss - Preamp Factor
Margin value = Emission level – Limit value
- 2412MHz: Fundamental frequency.



A D T

EUT TEST CONDITION		MEASUREMENT DETAIL	
CHANNEL	Channel 6	FREQUENCY RANGE	1GHz ~ 25GHz
INPUT POWER	120Vac, 60 Hz	DETECTOR FUNCTION	Peak (PK) Average (AV)
ENVIRONMENTAL CONDITIONS	25deg. C, 65%RH	TESTED BY	Kay Wu

ANTENNA POLARITY & TEST DISTANCE: HORIZONTAL AT 3 M

FREQ. (MHz)	EMISSION LEVEL (dBuV/m)	READ LEVEL (dBuV)	LIMIT (dBuV/m)	MARGIN (dB)	ANTENNA FACTOR (dB/m)	CABLE LOSS (dB)	PREAMP FACTOR (dB)	ANTENNA HEIGHT (cm)	TABLE ANGLE (Degree)	REMARK
2356	40.65	39.02	54	-13.35	31.76	5.37	35.5	118	38	Average
2356	54.13	52.5	74	-19.87	31.76	5.37	35.5	118	38	Peak
2437	97.44	95.59			31.85	5.46	35.46	118	38	Average
2437	104.35	102.5			31.85	5.46	35.46	118	38	Peak
2490	39.85	37.84	54	-14.15	31.9	5.53	35.42	118	38	Average
2490	55.01	53	74	-18.99	31.9	5.53	35.42	118	38	Peak

ANTENNA POLARITY & TEST DISTANCE: VERTICAL AT 3 M

FREQ. (MHz)	EMISSION LEVEL (dBuV/m)	READ LEVEL (dBuV)	LIMIT (dBuV/m)	MARGIN (dB)	ANTENNA FACTOR (dB/m)	CABLE LOSS (dB)	PREAMP FACTOR (dB)	ANTENNA HEIGHT (cm)	TABLE ANGLE (Degree)	REMARK
2390	39.72	37.99	54	-14.28	31.8	5.4	35.47	103	28	Average
2390	54.61	52.88	74	-19.39	31.8	5.4	35.47	103	28	Peak
2437	100.03	98.18			31.85	5.46	35.46	103	28	Average
2437	107.34	105.49			31.85	5.46	35.46	103	28	Peak
2498	40.96	38.94	54	-13.04	31.9	5.53	35.41	103	28	Average
2498	56.55	54.53	74	-17.45	31.9	5.53	35.41	103	28	Peak

REMARKS:

- Emission Level = Read Level + Antenna Factor + Cable Loss - Preamp Factor
Margin value = Emission level – Limit value
- 2437MHz: Fundamental frequency.



A D T

EUT TEST CONDITION		MEASUREMENT DETAIL	
CHANNEL	Channel 11	FREQUENCY RANGE	1GHz ~ 25GHz
INPUT POWER	120Vac, 60 Hz	DETECTOR FUNCTION	Peak (PK) Average (AV)
ENVIRONMENTAL CONDITIONS	25deg. C, 65%RH	TESTED BY	Kay Wu

ANTENNA POLARITY & TEST DISTANCE: HORIZONTAL AT 3 M

FREQ. (MHz)	EMISSION LEVEL (dBuV/m)	READ LEVEL (dBuV)	LIMIT (dBuV/m)	MARGIN (dB)	ANTENNA FACTOR (dB/m)	CABLE LOSS (dB)	PREAMP FACTOR (dB)	ANTENNA HEIGHT (cm)	TABLE ANGLE (Degree)	REMARK
2338	39.18	37.63	54	-14.82	31.74	5.33	35.52	117	39	Average
2338	54.72	53.17	74	-19.28	31.74	5.33	35.52	117	39	Peak
2462	95.75	93.82			31.87	5.5	35.44	117	39	Average
2462	103.04	101.11			31.87	5.5	35.44	117	39	Peak
2483.5	49.91	47.95	54	-4.09	31.88	5.5	35.42	117	39	Average
2483.5	64.18	62.22	74	-9.82	31.88	5.5	35.42	117	39	Peak

ANTENNA POLARITY & TEST DISTANCE: VERTICAL AT 3 M

FREQ. (MHz)	EMISSION LEVEL (dBuV/m)	READ LEVEL (dBuV)	LIMIT (dBuV/m)	MARGIN (dB)	ANTENNA FACTOR (dB/m)	CABLE LOSS (dB)	PREAMP FACTOR (dB)	ANTENNA HEIGHT (cm)	TABLE ANGLE (Degree)	REMARK
2334	40.57	39.03	54	-13.43	31.73	5.33	35.52	100	28	Average
2334	54.74	53.2	74	-19.26	31.73	5.33	35.52	100	28	Peak
2462	98.1	96.17			31.87	5.5	35.44	100	28	Average
2462	106.63	104.7			31.87	5.5	35.44	100	28	Peak
2483.5	49.68	47.72	54	-4.32	31.88	5.5	35.42	100	28	Average
2483.5	68.45	66.49	74	-5.55	31.88	5.5	35.42	100	28	Peak

REMARKS:

- Emission Level = Read Level + Antenna Factor + Cable Loss - Preamp Factor
Margin value = Emission level – Limit value
- 2462MHz: Fundamental frequency.



A D T

802.11n (20MHz)

EUT TEST CONDITION		MEASUREMENT DETAIL	
CHANNEL	Channel 1	FREQUENCY RANGE	1GHz ~ 25GHz
INPUT POWER	120Vac, 60 Hz	DETECTOR FUNCTION	Peak (PK) Average (AV)
ENVIRONMENTAL CONDITIONS	25deg. C, 65%RH	TESTED BY	Kay Wu

ANTENNA POLARITY & TEST DISTANCE: HORIZONTAL AT 3 M

FREQ. (MHz)	EMISSION LEVEL (dBuV/m)	READ LEVEL (dBuV)	LIMIT (dBuV/m)	MARGIN (dB)	ANTENNA FACTOR (dB/m)	CABLE LOSS (dB)	PREAMP FACTOR (dB)	ANTENNA HEIGHT (cm)	TABLE ANGLE (Degree)	REMARK
2390	47.06	45.33	54	-6.94	31.8	5.4	35.47	120	0	Average
2390	65.04	63.31	74	-8.96	31.8	5.4	35.47	120	0	Peak
2412	95.81	94.04			31.81	5.43	35.47	120	0	Average
2412	103.15	101.38			31.81	5.43	35.47	120	0	Peak
2494	41	38.98	54	-13	31.9	5.53	35.41	120	0	Average
2494	54.72	52.7	74	-19.28	31.9	5.53	35.41	120	0	Peak

ANTENNA POLARITY & TEST DISTANCE: VERTICAL AT 3 M

FREQ. (MHz)	EMISSION LEVEL (dBuV/m)	READ LEVEL (dBuV)	LIMIT (dBuV/m)	MARGIN (dB)	ANTENNA FACTOR (dB/m)	CABLE LOSS (dB)	PREAMP FACTOR (dB)	ANTENNA HEIGHT (cm)	TABLE ANGLE (Degree)	REMARK
2390	48.19	46.46	54	-5.81	31.8	5.4	35.47	129	0	Average
2390	65.86	64.13	74	-8.14	31.8	5.4	35.47	129	0	Peak
2412	97.1	95.33			31.81	5.43	35.47	129	0	Average
2412	105.33	103.56			31.81	5.43	35.47	129	0	Peak
2496	40	37.98	54	-14	31.9	5.53	35.41	129	0	Average
2496	55.18	53.16	74	-18.82	31.9	5.53	35.41	129	0	Peak

REMARKS:

- Emission Level = Read Level + Antenna Factor + Cable Loss - Preamp Factor
Margin value = Emission level – Limit value
- 2412MHz: Fundamental frequency.



A D T

EUT TEST CONDITION		MEASUREMENT DETAIL	
CHANNEL	Channel 6	FREQUENCY RANGE	1GHz ~ 25GHz
INPUT POWER	120Vac, 60 Hz	DETECTOR FUNCTION	Peak (PK) Average (AV)
ENVIRONMENTAL CONDITIONS	25deg. C, 65%RH	TESTED BY	Kay Wu

ANTENNA POLARITY & TEST DISTANCE: HORIZONTAL AT 3 M										
FREQ. (MHz)	EMISSION LEVEL (dBuV/m)	READ LEVEL (dBuV)	LIMIT (dBuV/m)	MARGIN (dB)	ANTENNA FACTOR (dB/m)	CABLE LOSS (dB)	PREAMP FACTOR (dB)	ANTENNA HEIGHT (cm)	TABLE ANGLE (Degree)	REMARK
2370	40.71	39.05	54	-13.29	31.78	5.37	35.49	142	38	Average
2370	55.81	54.15	74	-18.19	31.78	5.37	35.49	142	38	Peak
2437	95.46	93.61			31.85	5.46	35.46	142	38	Average
2437	103.84	101.99			31.85	5.46	35.46	142	38	Peak
2490	42.96	40.95	54	-11.04	31.9	5.53	35.42	142	38	Average
2490	55.09	53.08	74	-18.91	31.9	5.53	35.42	142	38	Peak

ANTENNA POLARITY & TEST DISTANCE: VERTICAL AT 3 M										
FREQ. (MHz)	EMISSION LEVEL (dBuV/m)	READ LEVEL (dBuV)	LIMIT (dBuV/m)	MARGIN (dB)	ANTENNA FACTOR (dB/m)	CABLE LOSS (dB)	PREAMP FACTOR (dB)	ANTENNA HEIGHT (cm)	TABLE ANGLE (Degree)	REMARK
2386	40.76	39.05	54	-13.24	31.8	5.4	35.49	100	91	Average
2386	54.62	52.91	74	-19.38	31.8	5.4	35.49	100	91	Peak
2437	97.88	96.03			31.85	5.46	35.46	100	91	Average
2437	105.55	103.7			31.85	5.46	35.46	100	91	Peak
2488	43.29	41.28	54	-10.71	31.9	5.53	35.42	100	91	Average
2488	55.41	53.4	74	-18.59	31.9	5.53	35.42	100	91	Peak

REMARKS:

- Emission Level = Read Level + Antenna Factor + Cable Loss - Preamp Factor
Margin value = Emission level – Limit value
- 2437MHz: Fundamental frequency.



A D T

EUT TEST CONDITION		MEASUREMENT DETAIL	
CHANNEL	Channel 11	FREQUENCY RANGE	1GHz ~ 25GHz
INPUT POWER	120Vac, 60 Hz	DETECTOR FUNCTION	Peak (PK) Average (AV)
ENVIRONMENTAL CONDITIONS	25deg. C, 65%RH	TESTED BY	Kay Wu

ANTENNA POLARITY & TEST DISTANCE: HORIZONTAL AT 3 M

FREQ. (MHz)	EMISSION LEVEL (dBuV/m)	READ LEVEL (dBuV)	LIMIT (dBuV/m)	MARGIN (dB)	ANTENNA FACTOR (dB/m)	CABLE LOSS (dB)	PREAMP FACTOR (dB)	ANTENNA HEIGHT (cm)	TABLE ANGLE (Degree)	REMARK
2372	40.67	39.01	54	-13.33	31.78	5.37	35.49	142	38	Average
2372	54.97	53.31	74	-19.03	31.78	5.37	35.49	142	38	Peak
2462	95.33	93.4			31.87	5.5	35.44	142	38	Average
2462	102.14	100.21			31.87	5.5	35.44	142	38	Peak
2483.5	49.97	48.01	54	-4.03	31.88	5.5	35.42	142	38	Average
2483.5	66.74	64.78	74	-7.26	31.88	5.5	35.42	142	38	Peak

ANTENNA POLARITY & TEST DISTANCE: VERTICAL AT 3 M

FREQ. (MHz)	EMISSION LEVEL (dBuV/m)	READ LEVEL (dBuV)	LIMIT (dBuV/m)	MARGIN (dB)	ANTENNA FACTOR (dB/m)	CABLE LOSS (dB)	PREAMP FACTOR (dB)	ANTENNA HEIGHT (cm)	TABLE ANGLE (Degree)	REMARK
2368	40.69	39.05	54	-13.31	31.76	5.37	35.49	100	91	Average
2368	55.02	53.38	74	-18.98	31.76	5.37	35.49	100	91	Peak
2462	97.49	95.56			31.87	5.5	35.44	100	91	Average
2462	104.74	102.81			31.87	5.5	35.44	100	91	Peak
2483.5	50.95	48.99	54	-3.05	31.88	5.5	35.42	100	91	Average
2483.5	66.11	64.15	74	-7.89	31.88	5.5	35.42	100	91	Peak

REMARKS:

- Emission Level = Read Level + Antenna Factor + Cable Loss - Preamp Factor
Margin value = Emission level – Limit value
- 2462MHz: Fundamental frequency.



A D T

BELOW 1GHz WORST-CASE DATA:

802.11n (20MHz)

EUT TEST CONDITION		MEASUREMENT DETAIL	
CHANNEL	Channel 11	FREQUENCY RANGE	30MHz ~ 1GHz
INPUT POWER	120Vac, 60 Hz	DETECTOR FUNCTION	Peak (PK)
ENVIRONMENTAL CONDITIONS	25deg. C, 65%RH	TESTED BY	Kay Wu

ANTENNA POLARITY & TEST DISTANCE: HORIZONTAL AT 3 M

FREQ. (MHz)	EMISSION LEVEL (dBuV/m)	READ LEVEL (dBuV)	LIMIT (dBuV/m)	MARGIN (dB)	ANTENNA FACTOR (dB/m)	CABLE LOSS (dB)	PREAMP FACTOR (dB)	ANTENNA HEIGHT (cm)	TABLE ANGLE (Degree)	REMARK
58.08	28.99	53.34	40	-11.01	6.98	0.9	32.23	165	210	Peak
90.48	25.63	47.29	43.5	-17.87	8.94	1.11	31.71	155	125	Peak
130.44	26.64	48.29	43.5	-16.86	9.2	1.38	32.23	102	127	Peak
400.1	20.62	32.4	46	-25.38	18.1	2.34	32.22	165	201	Peak
599.6	27.67	35.89	46	-18.33	21.1	2.87	32.19	155	145	Peak
737.5	25.43	31.1	46	-20.57	23.3	3.16	32.13	178	105	Peak

ANTENNA POLARITY & TEST DISTANCE: VERTICAL AT 3 M

FREQ. (MHz)	EMISSION LEVEL (dBuV/m)	READ LEVEL (dBuV)	LIMIT (dBuV/m)	MARGIN (dB)	ANTENNA FACTOR (dB/m)	CABLE LOSS (dB)	PREAMP FACTOR (dB)	ANTENNA HEIGHT (cm)	TABLE ANGLE (Degree)	REMARK
30.54	35.91	50.12	40	-4.09	17.31	0.74	32.26	166	52	Peak
48.9	32.62	55.8	40	-7.38	8.14	0.9	32.22	132	258	Peak
89.13	22.54	44.34	43.5	-20.96	8.85	1.11	31.76	159	330	Peak
477.8	20.03	30.68	46	-25.97	18.91	2.56	32.12	116	201	Peak
599.6	31.3	39.52	46	-14.7	21.1	2.87	32.19	100	175	Peak
716.5	24.53	30.26	46	-21.47	23.27	3.11	32.11	166	258	Peak

REMARKS: Emission Level = Read Level + Antenna Factor + Cable Loss - Preamp Factor

Margin value = Emission level – Limit value

4.2 CONDUCTED EMISSION MEASUREMENT

4.2.1 LIMITS OF CONDUCTED EMISSION MEASUREMENT

FREQUENCY OF EMISSION (MHz)	CONDUCTED LIMIT (dB μ V)	
	Quasi-peak	Average
0.15 ~ 0.5	66 to 56	56 to 46
0.5 ~ 5	56	46
5 ~ 30	60	50

- NOTE:**
1. The lower limit shall apply at the transition frequencies.
 2. The limit decreases in line with the logarithm of the frequency in the range of 0.15 to 0.50MHz.
 3. All emanations from a class A/B digital device or system, including any network of conductors and apparatus connected thereto, shall not exceed the level of field strengths specified above.

4.2.2 TEST INSTRUMENTS

DESCRIPTION & MANUFACTURER	MODEL NO.	SERIAL NO.	DATE OF CALIBRATION	DUE DATE OF CALIBRATION
Test Receiver ROHDE & SCHWARZ	ESCS30	100288	Nov. 17, 2013	Nov. 16, 2014
RF signal cable Woken	5D-FB	Cable-HYCO2-01	Dec. 27, 2013	Dec. 26, 2014
LISN ROHDE & SCHWARZ (EUT)	ESH2-Z5	100100	Dec. 23, 2013	Dec. 22, 2014
LISN ROHDE & SCHWARZ (Peripheral)	ESH3-Z5	100312	Jul. 08, 2013	Jul. 07, 2014
Software ADT	BV ADT_Cond_ V7.3.7.3	NA	NA	NA

- NOTE:**
1. The calibration interval of the above test instruments is 12 months and the calibrations are traceable to NML/ROC and NIST/USA.
 2. The test was performed in HwaYa Shielded Room 2.
 3. The VCCI Site Registration No. is C-2047.

4.2.3 TEST PROCEDURES

- a. The EUT was placed 0.4 meters from the conducting wall of the shielded room with EUT being connected to the power mains through a line impedance stabilization network (LISN). Other support units were connected to the power mains through another LISN. The two LISNs provide 50 ohm/ 50uH of coupling impedance for the measuring instrument.
- b. Both lines of the power mains connected to the EUT were checked for maximum conducted interference.
- c. The frequency range from 150kHz to 30MHz was searched. Emission levels under (Limit - 20dB) was not recorded.

NOTE: All modes of operation were investigated and the worst-case emissions are reported.

4.2.4 DEVIATION FROM TEST STANDARD

No deviation.

4.2.5 TEST SETUP

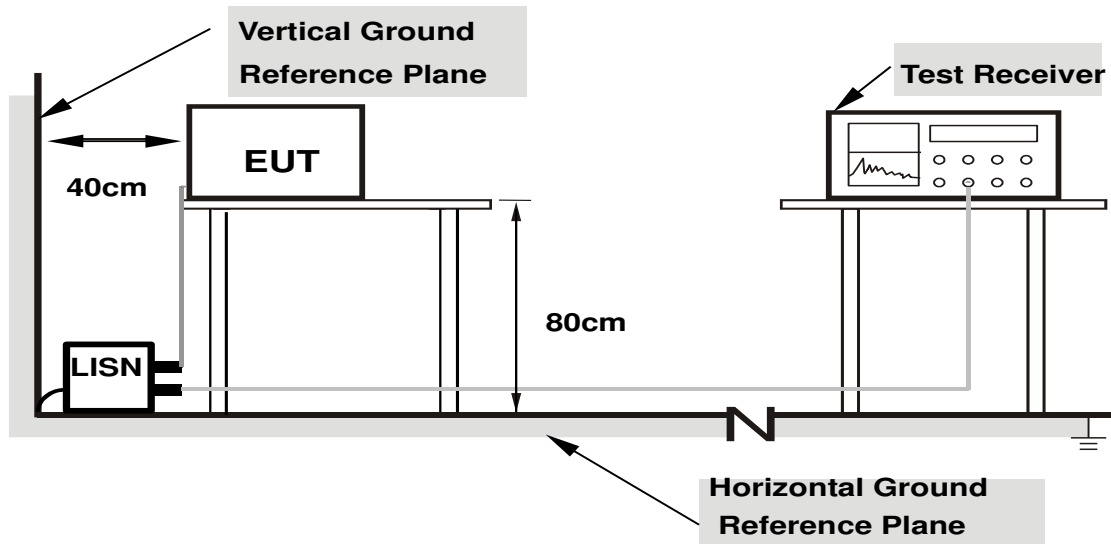

- Note:**
1. Support units were connected to second LISN.
 2. Both of LISNs (AMN) are 80 cm from EUT and at least 80 from other units and other metal planes

For the actual test configuration, please refer to the attached file (Test Setup Photo).

4.2.6 EUT OPERATING CONDITIONS

Same as section 4.1.6.

4.2.7 TEST RESULTS

CONDUCTED WORST-CASE DATA :

PHASE	Line 1	6dB BANDWIDTH	9kHz
-------	--------	---------------	------

No	Freq. [MHz]	Corr. Factor (dB)	Reading Value [dB (uV)]		Emission Level [dB (uV)]		Limit [dB (uV)]		Margin (dB)	
			Q.P.	AV.	Q.P.	AV.	Q.P.	AV.	Q.P.	AV.
			1	0.18906	0.28	37.28	23.29	37.56	23.57	64.08
2	0.38438	0.30	36.98	24.91	37.28	25.21	58.18	48.18	-20.91	-22.98
3	0.94297	0.34	41.42	29.43	41.76	29.77	56.00	46.00	-14.24	-16.23
4	1.35547	0.35	42.03	30.61	42.38	30.96	56.00	46.00	-13.62	-15.04
5	6.47656	0.46	32.19	22.82	32.65	23.28	60.00	50.00	-27.35	-26.72
6	13.56250	0.52	42.17	38.72	42.69	39.24	60.00	50.00	-17.31	-10.76

REMARKS:

1. Q.P. and AV. are abbreviations of quasi-peak and average individually.
2. The emission levels of other frequencies were very low against the limit.
3. Margin value = Emission level - Limit value
4. Correction factor = Insertion loss + Cable loss
5. Emission Level = Correction Factor + Reading Value

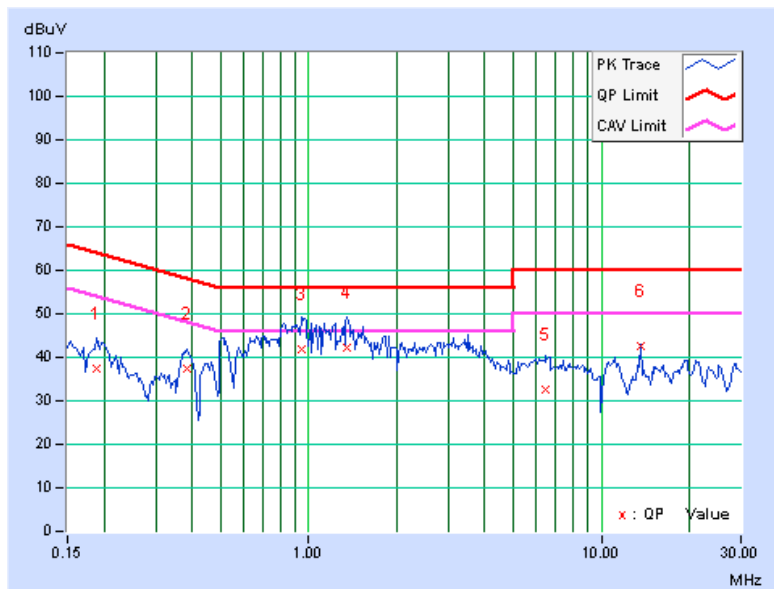



A D T

PHASE	Line 2	6dB BANDWIDTH	9kHz
-------	--------	---------------	------

No	Freq. [MHz]	Corr. Factor (dB)	Reading Value [dB (uV)]		Emission Level [dB (uV)]		Limit [dB (uV)]		Margin (dB)	
			Q.P.	AV.	Q.P.	AV.	Q.P.	AV.	Q.P.	AV.
			1	0.22422	0.28	35.68	21.07	35.96	21.35	62.66
2	0.39219	0.30	37.65	27.92	37.95	28.22	58.02	48.02	-20.07	-19.80
3	0.98594	0.34	36.74	27.42	37.08	27.76	56.00	46.00	-18.92	-18.24
4	3.25391	0.41	29.86	22.49	30.27	22.90	56.00	46.00	-25.73	-23.10
5	6.22266	0.47	25.16	17.56	25.63	18.03	60.00	50.00	-34.37	-31.97
6	13.55859	0.55	34.89	33.38	35.44	33.93	60.00	50.00	-24.56	-16.07

REMARKS:

1. Q.P. and AV. are abbreviations of quasi-peak and average individually.
2. The emission levels of other frequencies were very low against the limit.
3. Margin value = Emission level - Limit value
4. Correction factor = Insertion loss + Cable loss
5. Emission Level = Correction Factor + Reading Value

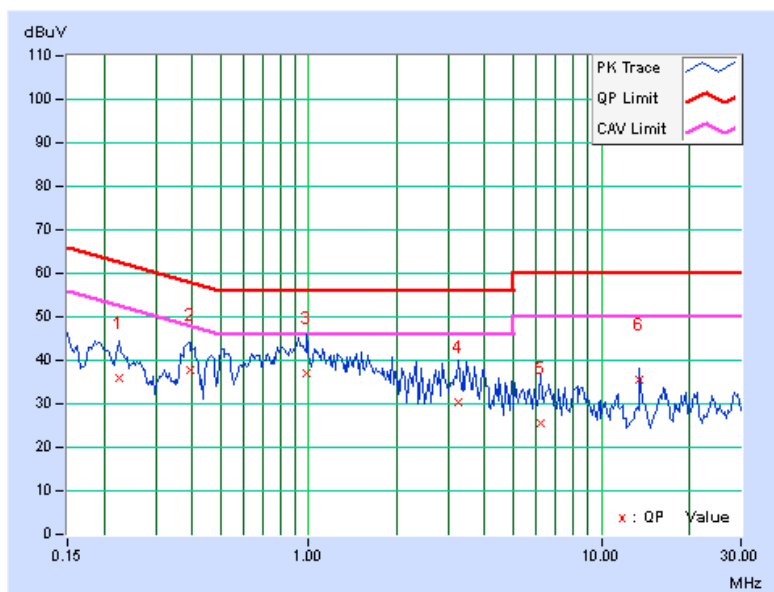

4.3 6dB BANDWIDTH MEASUREMENT

4.3.1 LIMITS OF 6dB BANDWIDTH MEASUREMENT

The minimum of 6dB Bandwidth Measurement is 0.5 MHz.

4.3.2 TEST SETUP

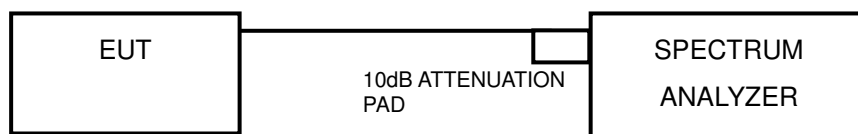

4.3.3 TEST INSTRUMENTS

Refer to section 4.1.2 to get information of above instrument.

4.3.4 TEST PROCEDURE

- Set resolution bandwidth (RBW) = 100kHz
- Set the video bandwidth (VBW) $\geq 3 \times$ RBW, Detector = Peak.
- Trace mode = max hold.
- Sweep = auto couple.
- Measure the maximum width of the emission that is constrained by the frequencies associated with the two amplitude points (upper and lower) that are attenuated by 6 dB relative to the maximum level measured in the fundamental emission

4.3.5 DEVIATION FROM TEST STANDARD

No deviation.

4.3.6 EUT OPERATING CONDITIONS

The software provided by client to enable the EUT under transmission condition continuously at lowest, middle and highest channel frequencies individually.



A D T

4.3.7 TEST RESULTS

802.11b

CHANNEL	FREQUENCY (MHz)	6dB BANDWIDTH (MHz)	MINIMUM LIMIT (MHz)	PASS / FAIL
1	2412	9.56	0.5	PASS
6	2437	9.10	0.5	PASS
11	2462	9.12	0.5	PASS

802.11g

CHANNEL	FREQUENCY (MHz)	6dB BANDWIDTH (MHz)	MINIMUM LIMIT (MHz)	PASS / FAIL
1	2412	16.37	0.5	PASS
6	2437	16.12	0.5	PASS
11	2462	16.43	0.5	PASS

802.11n (20MHz)

CHANNEL	FREQUENCY (MHz)	6dB BANDWIDTH (MHz)	MINIMUM LIMIT (MHz)	PASS / FAIL
1	2412	17.60	0.5	PASS
6	2437	17.25	0.5	PASS
11	2462	17.66	0.5	PASS



A D T

SPECTRUM PLOT OF WORST VALUE

802.11b

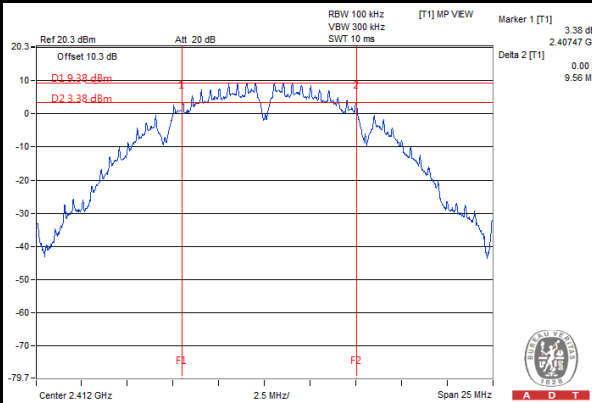

802.11g

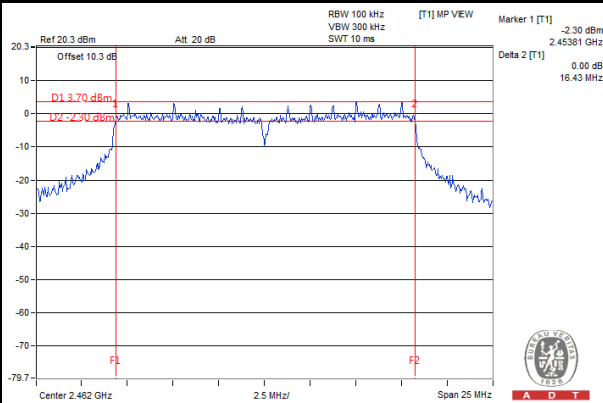

802.11n (20MHz)

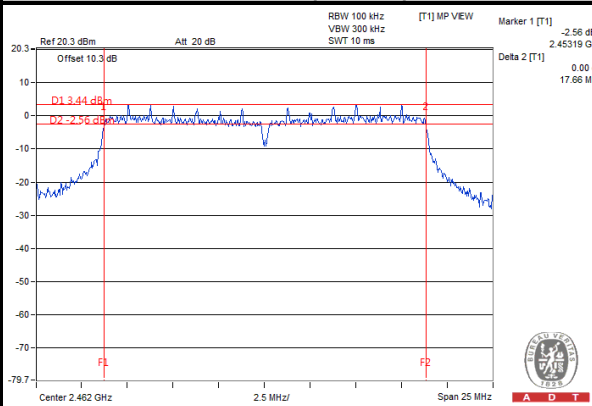

4.4 CONDUCTED OUTPUT POWER

4.4.1 LIMITS OF CONDUCTED OUTPUT POWER MEASUREMENT

For systems using digital modulation in the 2400–2483.5 MHz bands: 1 Watt (30dBm)

4.4.2 TEST SETUP

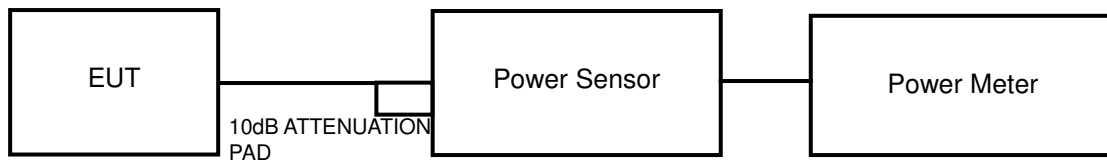

4.4.3 TEST INSTRUMENTS

Refer to section 4.1.2 to get information of above instrument.

4.4.4 TEST PROCEDURES

A peak power sensor was used on the output port of the EUT. A power meter was used to read the response of the peak power sensor. Record the peak power level.

4.4.5 DEVIATION FROM TEST STANDARD

No deviation.

4.4.6 EUT OPERATING CONDITIONS

Same as section 4.3.6.

4.4.7 TEST RESULTS

802.11b

CHANNEL	FREQUENCY (MHz)	PEAK POWER (mW)	PEAK POWER (dBm)	LIMIT (dBm)	PASS / FAIL
1	2412	108.14	20.34	30	PASS
6	2437	111.43	20.47	30	PASS
11	2462	95.50	19.8	30	PASS

802.11g

CHANNEL	FREQUENCY (MHz)	PEAK POWER (mW)	PEAK POWER (dBm)	LIMIT (dBm)	PASS / FAIL
1	2412	172.19	22.36	30	PASS
6	2437	165.58	22.19	30	PASS
11	2462	154.53	21.89	30	PASS

802.11n (20MHz)

CHANNEL	FREQUENCY (MHz)	PEAK POWER (mW)	PEAK POWER (dBm)	LIMIT (dBm)	PASS / FAIL
1	2412	179.47	22.54	30	PASS
6	2437	161.81	22.09	30	PASS
11	2462	163.68	22.14	30	PASS

4.5 POWER SPECTRAL DENSITY MEASUREMENT

4.5.1 LIMITS OF POWER SPECTRAL DENSITY MEASUREMENT

The Maximum of Power Spectral Density Measurement is 8dBm.

4.5.2 TEST SETUP

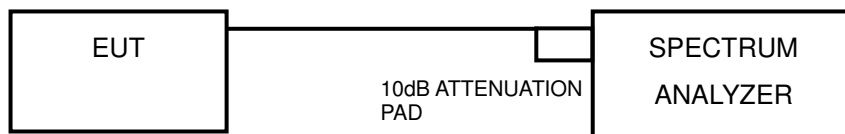

4.5.3 TEST INSTRUMENTS

Refer to section 4.1.2 to get information of above instrument.

4.5.4 TEST PROCEDURE

- Set the RBW = 3 kHz, VBW =10 kHz, Detector = peak.
- Sweep time = auto couple, Trace mode = max hold, allow trace to fully stabilize.
- Use the peak marker function to determine the maximum power level in any 100 kHz band segment within the fundamental EBW.

4.5.5 DEVIATION FROM TEST STANDARD

No deviation.

4.5.6 EUT OPERATING CONDITION

Same as section 4.3.6.



A D T

4.5.7 TEST RESULTS

802.11b

CHANNEL	FREQUENCY (MHz)	PSD (dBm/3kHz)	LIMIT (dBm/3kHz)	PASS / FAIL
1	2412	-4.57	8	PASS
6	2437	-4.71	8	PASS
11	2462	-5.21	8	PASS

802.11g

CHANNEL	FREQUENCY (MHz)	PSD (dBm/3kHz)	LIMIT (dBm/3kHz)	PASS / FAIL
1	2412	-10.63	8	PASS
6	2437	-9.26	8	PASS
11	2462	-10.17	8	PASS

802.11n (20MHz)

CHANNEL	FREQUENCY (MHz)	PSD (dBm/3kHz)	LIMIT (dBm/3kHz)	PASS / FAIL
1	2412	-10.44	8	PASS
6	2437	-9.63	8	PASS
11	2462	-10.26	8	PASS



A D T

SPECTRUM PLOT OF WORST VALUE

802.11b

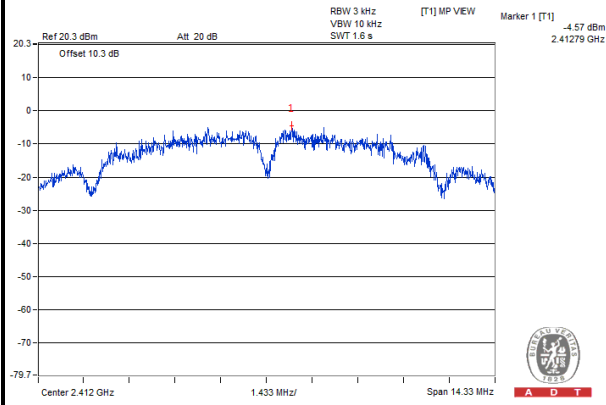

802.11g

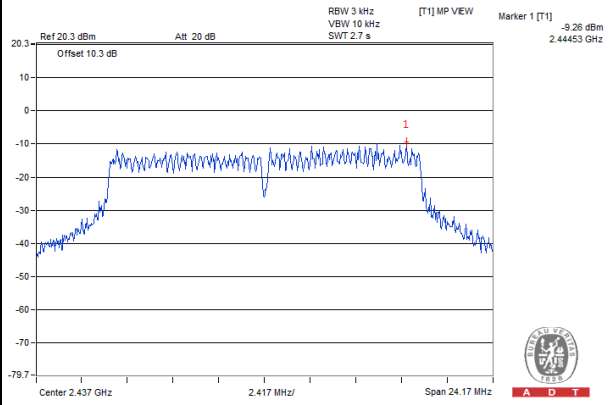

802.11n (20MHz)

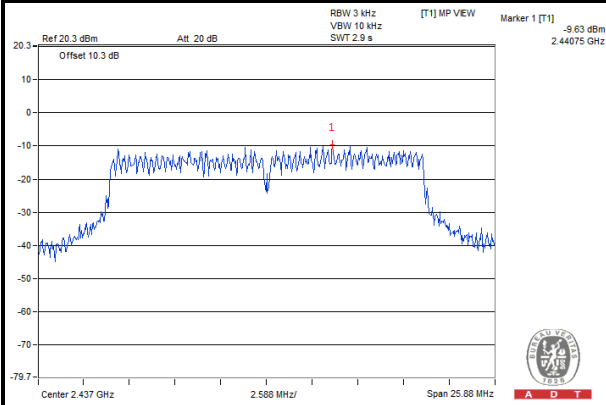

4.6 CONDUCTED OUT OF BAND EMISSION MEASUREMENT

4.6.1 LIMITS OF CONDUCTED OUT OF BAND EMISSION MEASUREMENT

Below -20dB of the highest emission level of operating band (in 100kHz Resolution Bandwidth).

4.6.2 TEST SETUP

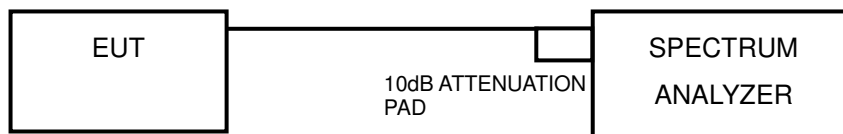

4.6.3 TEST INSTRUMENTS

Refer to section 4.1.2 to get information of above instrument.

4.6.4 TEST PROCEDURE

MEASUREMENT PROCEDURE REF

1. Set the RBW = 100 kHz.
2. Set the VBW \geq 300 kHz.
3. Detector = peak.
4. Sweep time = auto couple.
5. Trace mode = max hold.
6. Allow trace to fully stabilize.
7. Use the peak marker function to determine the maximum power level in any 100 kHz band segment within the fundamental EBW.

MEASUREMENT PROCEDURE OOB

1. Set RBW = 100 kHz.
2. Set VBW \geq 300 kHz.
3. Ensure that the number of measurement points \geq span/RBW
4. According to measurement points to set differ measurement span.
5. Detector = peak.
6. Trace Mode = max hold.
7. Sweep = auto couple.

4.6.5 DEVIATION FROM TEST STANDARD

No deviation.

4.6.6 EUT OPERATING CONDITION

Same as section 4.3.6.



A D T

4.6.7 TEST RESULTS

The spectrum plots are attached on the following images. D1 line indicates the highest level, and D2 line indicates the 20dB offset below D1. It shows compliance with the requirement.

802.11b

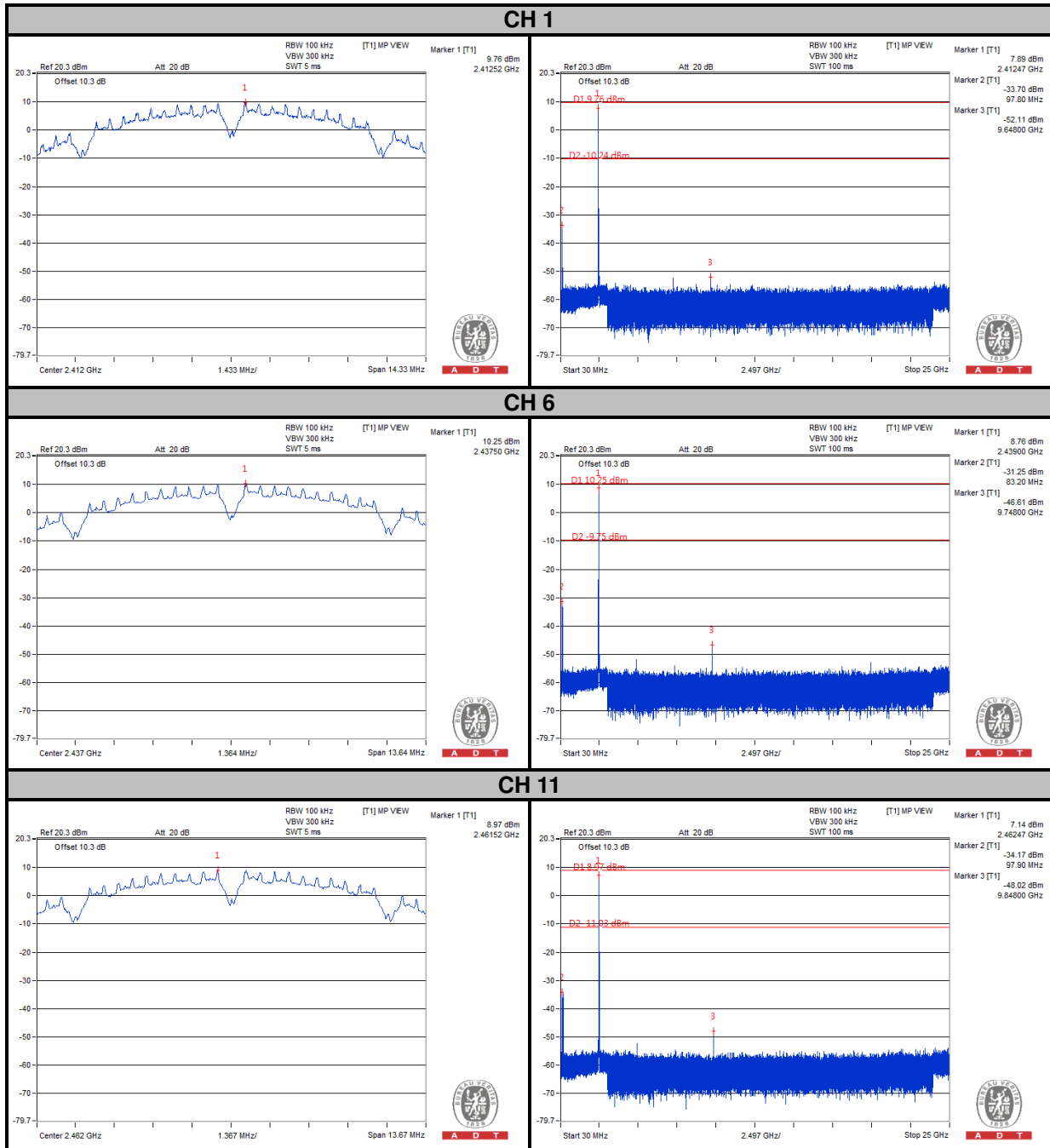



A D T

802.11g

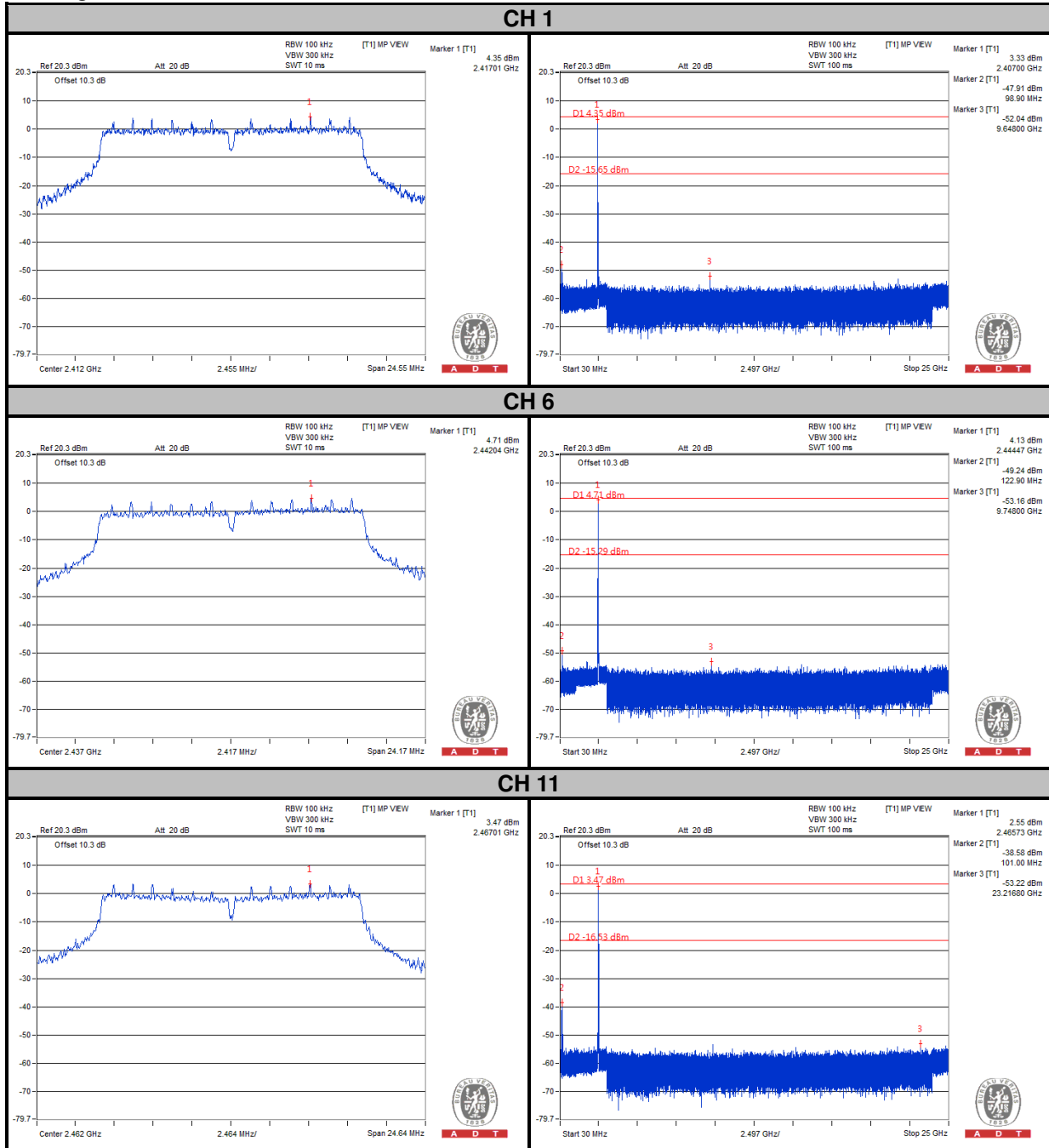



A D T

802.11n (20MHz)

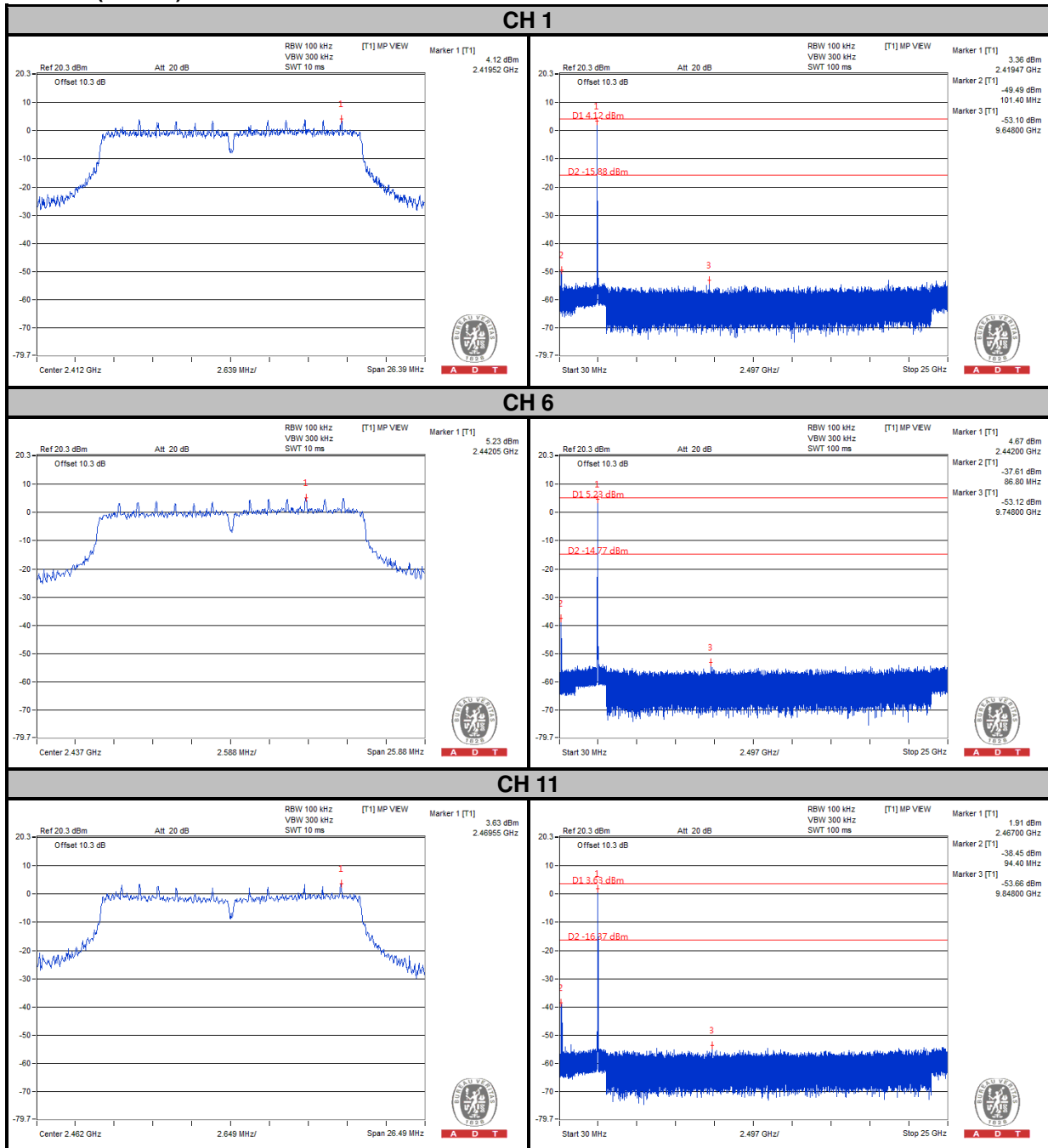

5. TEST TYPES AND RESULTS (FOR 5.0GHz BAND)

5.1 RADIATED EMISSION AND BANDEDGE MEASUREMENT

5.1.1 LIMITS OF RADIATED EMISSION AND BANDEDGE MEASUREMENT

Radiated emissions which fall in the restricted bands must comply with the radiated emission limits specified as below table. Other emissions shall be at least 20dB below the highest level of the desired power:

FREQUENCIES (MHz)	FIELD STRENGTH (microvolts/meter)	MEASUREMENT DISTANCE (meters)
0.009 ~ 0.490	2400/F(kHz)	300
0.490 ~ 1.705	24000/F(kHz)	30
1.705 ~ 30.0	30	30
30 ~ 88	100	3
88 ~ 216	150	3
216 ~ 960	200	3
Above 960	500	3

NOTE:

1. The lower limit shall apply at the transition frequencies.
2. Emission level (dBuV/m) = 20 log Emission level (uV/m).
3. For frequencies above 1000MHz, the field strength limits are based on average detector, however, the peak field strength of any emission shall not exceed the maximum permitted average limits, specified above by more than 20dB under any condition of modulation.



A D T

5.1.2 TEST INSTRUMENTS

Same as section 4.1.2.

5.1.3 TEST PROCEDURES

Same as section 4.1.3.

5.1.4 DEVIATION FROM TEST STANDARD

No deviation.

5.1.5 TEST SETUP

Same as section 4.1.5.

5.1.6 EUT OPERATING CONDITIONS

Same as section 4.1.6.



A D T

5.1.7 TEST RESULTS

ABOVE 1GHz WORST-CASE DATA :

802.11a

EUT TEST CONDITION		MEASUREMENT DETAIL	
CHANNEL	Channel 149	FREQUENCY RANGE	1GHz ~ 40GHz
INPUT POWER	120Vac, 60 Hz	DETECTOR FUNCTION	Peak (PK) Average (AV)
ENVIRONMENTAL CONDITIONS	25deg. C, 65%RH	TESTED BY	Kay Wu

ANTENNA POLARITY & TEST DISTANCE: HORIZONTAL AT 3 M

FREQ. (MHz)	EMISSION LEVEL (dBuV/m)	READ LEVEL (dBuV)	LIMIT (dBuV/m)	MARGIN (dB)	ANTENNA FACTOR (dB/m)	CABLE LOSS (dB)	PREAMP FACTOR (dB)	ANTENNA HEIGHT (cm)	TABLE ANGLE (Degree)	REMARK
5725	54.86	45.7	74.87	-20.01	34.62	8.65	34.11	102	360	Average
5725	66.76	57.6	82.76	-16	34.62	8.65	34.11	102	360	Peak
5745	94.87	85.68			34.64	8.66	34.11	102	360	Average
5745	102.76	93.57			34.64	8.66	34.11	102	360	Peak
5825	44.94	35.65	74.87	-29.93	34.73	8.69	34.13	102	360	Average
5825	57.65	48.36	82.76	-25.11	34.73	8.69	34.13	102	360	Peak

ANTENNA POLARITY & TEST DISTANCE: VERTICAL AT 3 M

FREQ. (MHz)	EMISSION LEVEL (dBuV/m)	READ LEVEL (dBuV)	LIMIT (dBuV/m)	MARGIN (dB)	ANTENNA FACTOR (dB/m)	CABLE LOSS (dB)	PREAMP FACTOR (dB)	ANTENNA HEIGHT (cm)	TABLE ANGLE (Degree)	REMARK
5725	60.97	51.81	79.66	-18.69	34.62	8.65	34.11	100	92	Average
5725	73.25	64.09	87.48	-14.23	34.62	8.65	34.11	100	92	Peak
5745	99.66	90.47			34.64	8.66	34.11	100	92	Average
5745	107.48	98.29			34.64	8.66	34.11	100	92	Peak
5825	44.94	35.65	79.66	-34.72	34.73	8.69	34.13	100	92	Average
5825	57.29	48	87.48	-30.19	34.73	8.69	34.13	100	92	Peak

REMARKS:

- Emission Level = Read Level + Antenna Factor + Cable Loss - Preamp Factor
Margin value = Emission level – Limit value
- 5745MHz: Fundamental frequency.
- 5725MHz & 5825MHz: Out of restricted band



A D T

EUT TEST CONDITION		MEASUREMENT DETAIL	
CHANNEL	Channel 157	FREQUENCY RANGE	1GHz ~ 40GHz
INPUT POWER	120Vac, 60 Hz	DETECTOR FUNCTION	Peak (PK) Average (AV)
ENVIRONMENTAL CONDITIONS	25deg. C, 65%RH	TESTED BY	Kay Wu

ANTENNA POLARITY & TEST DISTANCE: HORIZONTAL AT 3 M

FREQ. (MHz)	EMISSION LEVEL (dBuV/m)	READ LEVEL (dBuV)	LIMIT (dBuV/m)	MARGIN (dB)	ANTENNA FACTOR (dB/m)	CABLE LOSS (dB)	PREAMP FACTOR (dB)	ANTENNA HEIGHT (cm)	TABLE ANGLE (Degree)	REMARK
5725	45.83	36.67	75.92	-30.09	34.62	8.65	34.11	142	208	Average
5725	58.79	49.63	83.47	-24.68	34.62	8.65	34.11	142	208	Peak
5785	95.92	86.69			34.68	8.68	34.13	142	208	Average
5785	103.47	94.24			34.68	8.68	34.13	142	208	Peak
5825	46.94	37.65	75.92	-28.98	34.73	8.69	34.13	142	208	Average
5825	57.95	48.66	83.47	-25.52	34.73	8.69	34.13	142	208	Peak

ANTENNA POLARITY & TEST DISTANCE: VERTICAL AT 3 M

FREQ. (MHz)	EMISSION LEVEL (dBuV/m)	READ LEVEL (dBuV)	LIMIT (dBuV/m)	MARGIN (dB)	ANTENNA FACTOR (dB/m)	CABLE LOSS (dB)	PREAMP FACTOR (dB)	ANTENNA HEIGHT (cm)	TABLE ANGLE (Degree)	REMARK
5725	45.83	36.67	79.92	-34.09	34.62	8.65	34.11	138	282	Average
5725	59.11	49.95	87.06	-27.95	34.62	8.65	34.11	138	282	Peak
5785	99.92	90.69			34.68	8.68	34.13	138	282	Average
5785	107.06	97.83			34.68	8.68	34.13	138	282	Peak
5825	47.99	38.7	79.92	-31.93	34.73	8.69	34.13	138	282	Average
5825	60.5	51.21	87.06	-26.56	34.73	8.69	34.13	138	282	Peak

REMARKS:

- Emission Level = Read Level + Antenna Factor + Cable Loss - Preamp Factor
Margin value = Emission level – Limit value
- 5785MHz: Fundamental frequency.
- 5725MHz & 5825MHz: Out of restricted band



A D T

EUT TEST CONDITION		MEASUREMENT DETAIL	
CHANNEL	Channel 161	FREQUENCY RANGE	1GHz ~ 40GHz
INPUT POWER	120Vac, 60 Hz	DETECTOR FUNCTION	Peak (PK) Average (AV)
ENVIRONMENTAL CONDITIONS	25deg. C, 65%RH	TESTED BY	Kay Wu

ANTENNA POLARITY & TEST DISTANCE: HORIZONTAL AT 3 M

FREQ. (MHz)	EMISSION LEVEL (dBuV/m)	READ LEVEL (dBuV)	LIMIT (dBuV/m)	MARGIN (dB)	ANTENNA FACTOR (dB/m)	CABLE LOSS (dB)	PREAMP FACTOR (dB)	ANTENNA HEIGHT (cm)	TABLE ANGLE (Degree)	REMARK
5725	44.8	35.64	75.95	-31.15	34.62	8.65	34.11	142	206	Average
5725	56.79	47.63	83.48	-26.69	34.62	8.65	34.11	142	206	Peak
5805	95.95	86.69			34.71	8.68	34.13	142	206	Average
5805	103.48	94.22			34.71	8.68	34.13	142	206	Peak
5825	59.77	50.48	75.95	-16.18	34.73	8.69	34.13	142	206	Average
5825	71.47	62.18	83.48	-12.01	34.73	8.69	34.13	142	206	Peak

ANTENNA POLARITY & TEST DISTANCE: VERTICAL AT 3 M

FREQ. (MHz)	EMISSION LEVEL (dBuV/m)	READ LEVEL (dBuV)	LIMIT (dBuV/m)	MARGIN (dB)	ANTENNA FACTOR (dB/m)	CABLE LOSS (dB)	PREAMP FACTOR (dB)	ANTENNA HEIGHT (cm)	TABLE ANGLE (Degree)	REMARK
5725	44.8	35.64	78.63	-33.83	34.62	8.65	34.11	139	277	Average
5725	58.35	49.19	87.06	-28.71	34.62	8.65	34.11	139	277	Peak
5805	98.63	89.37			34.71	8.68	34.13	139	277	Average
5805	107.06	97.8			34.71	8.68	34.13	139	277	Peak
5825	61.58	52.29	78.63	-17.05	34.73	8.69	34.13	139	277	Average
5825	78.2	68.91	87.06	-8.86	34.73	8.69	34.13	139	277	Peak

REMARKS:

- Emission Level = Read Level + Antenna Factor + Cable Loss - Preamp Factor
Margin value = Emission level – Limit value
- 5805MHz: Fundamental frequency.
- 5725MHz & 5825MHz: Out of restricted band



A D T

802.11n (20MHz)

EUT TEST CONDITION		MEASUREMENT DETAIL	
CHANNEL	Channel 149	FREQUENCY RANGE	1GHz ~ 40GHz
INPUT POWER	120Vac, 60 Hz	DETECTOR FUNCTION	Peak (PK) Average (AV)
ENVIRONMENTAL CONDITIONS	25deg. C, 65%RH	TESTED BY	Kay Wu

ANTENNA POLARITY & TEST DISTANCE: HORIZONTAL AT 3 M

FREQ. (MHz)	EMISSION LEVEL (dBuV/m)	READ LEVEL (dBuV)	LIMIT (dBuV/m)	MARGIN (dB)	ANTENNA FACTOR (dB/m)	CABLE LOSS (dB)	PREAMP FACTOR (dB)	ANTENNA HEIGHT (cm)	TABLE ANGLE (Degree)	REMARK
5725	54.8	45.64	74.54	-19.74	34.62	8.65	34.11	101	88	Average
5725	67.87	58.71	81.29	-13.42	34.62	8.65	34.11	101	88	Peak
5745	94.54	85.35			34.64	8.66	34.11	101	88	Average
5745	101.29	92.1			34.64	8.66	34.11	101	88	Peak
5825	45.97	36.68	74.54	-28.57	34.73	8.69	34.13	101	88	Average
5825	57.38	48.09	81.29	-23.91	34.73	8.69	34.13	101	88	Peak

ANTENNA POLARITY & TEST DISTANCE: VERTICAL AT 3 M

FREQ. (MHz)	EMISSION LEVEL (dBuV/m)	READ LEVEL (dBuV)	LIMIT (dBuV/m)	MARGIN (dB)	ANTENNA FACTOR (dB/m)	CABLE LOSS (dB)	PREAMP FACTOR (dB)	ANTENNA HEIGHT (cm)	TABLE ANGLE (Degree)	REMARK
5725	60.84	51.68	78.77	-17.93	34.62	8.65	34.11	100	84	Average
5725	74.1	64.94	86.75	-12.65	34.62	8.65	34.11	100	84	Peak
5745	98.77	89.58			34.64	8.66	34.11	100	84	Average
5745	106.75	97.56			34.64	8.66	34.11	100	84	Peak
5825	45.94	36.65	78.77	-32.83	34.73	8.69	34.13	100	84	Average
5825	58.3	49.01	86.75	-28.45	34.73	8.69	34.13	100	84	Peak

REMARKS:

- Emission Level = Read Level + Antenna Factor + Cable Loss - Preamp Factor
Margin value = Emission level – Limit value
- 5745MHz: Fundamental frequency.
- 5725MHz & 5825MHz: Out of restricted band



A D T

EUT TEST CONDITION		MEASUREMENT DETAIL	
CHANNEL	Channel 157	FREQUENCY RANGE	1GHz ~ 40GHz
INPUT POWER	120Vac, 60 Hz	DETECTOR FUNCTION	Peak (PK) Average (AV)
ENVIRONMENTAL CONDITIONS	25deg. C, 65%RH	TESTED BY	Kay Wu

ANTENNA POLARITY & TEST DISTANCE: HORIZONTAL AT 3 M

FREQ. (MHz)	EMISSION LEVEL (dBuV/m)	READ LEVEL (dBuV)	LIMIT (dBuV/m)	MARGIN (dB)	ANTENNA FACTOR (dB/m)	CABLE LOSS (dB)	PREAMP FACTOR (dB)	ANTENNA HEIGHT (cm)	TABLE ANGLE (Degree)	REMARK
5725	44.8	35.64	75.92	-31.12	34.62	8.65	34.11	139	206	Average
5725	57.52	48.36	82.46	-24.94	34.62	8.65	34.11	139	206	Peak
5785	95.92	86.69			34.68	8.68	34.13	139	206	Average
5785	102.46	93.23			34.68	8.68	34.13	139	206	Peak
5825	45.52	36.23	75.92	-30.4	34.73	8.69	34.13	139	206	Average
5825	59.68	50.39	82.46	-22.78	34.73	8.69	34.13	139	206	Peak

ANTENNA POLARITY & TEST DISTANCE: VERTICAL AT 3 M

FREQ. (MHz)	EMISSION LEVEL (dBuV/m)	READ LEVEL (dBuV)	LIMIT (dBuV/m)	MARGIN (dB)	ANTENNA FACTOR (dB/m)	CABLE LOSS (dB)	PREAMP FACTOR (dB)	ANTENNA HEIGHT (cm)	TABLE ANGLE (Degree)	REMARK
5725	45.79	36.63	78.92	-33.13	34.62	8.65	34.11	100	84	Average
5725	59.14	49.98	86.5	-27.36	34.62	8.65	34.11	100	84	Peak
5785	98.92	89.69			34.68	8.68	34.13	100	84	Average
5785	106.5	97.27			34.68	8.68	34.13	100	84	Peak
5825	46.98	37.69	78.92	-31.94	34.73	8.69	34.13	100	84	Average
5825	60.73	51.44	86.5	-25.77	34.73	8.69	34.13	100	84	Peak

REMARKS:

- Emission Level = Read Level + Antenna Factor + Cable Loss - Preamp Factor
Margin value = Emission level – Limit value
- 5785MHz: Fundamental frequency.
- 5725MHz & 5825MHz: Out of restricted band



A D T

EUT TEST CONDITION		MEASUREMENT DETAIL	
CHANNEL	Channel 161	FREQUENCY RANGE	1GHz ~ 40GHz
INPUT POWER	120Vac, 60 Hz	DETECTOR FUNCTION	Peak (PK) Average (AV)
ENVIRONMENTAL CONDITIONS	25deg. C, 65%RH	TESTED BY	Kay Wu

ANTENNA POLARITY & TEST DISTANCE: HORIZONTAL AT 3 M

FREQ. (MHz)	EMISSION LEVEL (dBuV/m)	READ LEVEL (dBuV)	LIMIT (dBuV/m)	MARGIN (dB)	ANTENNA FACTOR (dB/m)	CABLE LOSS (dB)	PREAMP FACTOR (dB)	ANTENNA HEIGHT (cm)	TABLE ANGLE (Degree)	REMARK
5725	44.84	35.68	74.92	-30.08	34.62	8.65	34.11	142	206	Average
5725	57.16	48	82.51	-25.35	34.62	8.65	34.11	142	206	Peak
5805	94.92	85.66			34.71	8.68	34.13	142	206	Average
5805	102.51	93.25			34.71	8.68	34.13	142	206	Peak
5825	55.97	46.68	74.92	-18.95	34.73	8.69	34.13	142	206	Average
5825	70.05	60.76	82.51	-12.46	34.73	8.69	34.13	142	206	Peak

ANTENNA POLARITY & TEST DISTANCE: VERTICAL AT 3 M

FREQ. (MHz)	EMISSION LEVEL (dBuV/m)	READ LEVEL (dBuV)	LIMIT (dBuV/m)	MARGIN (dB)	ANTENNA FACTOR (dB/m)	CABLE LOSS (dB)	PREAMP FACTOR (dB)	ANTENNA HEIGHT (cm)	TABLE ANGLE (Degree)	REMARK
5725	45.83	36.67	79.51	-33.68	34.62	8.65	34.11	138	276	Average
5725	56.78	47.62	86.5	-29.72	34.62	8.65	34.11	138	276	Peak
5805	99.51	90.25			34.71	8.68	34.13	138	276	Average
5805	106.5	97.24			34.71	8.68	34.13	138	276	Peak
5825	61.07	51.78	79.51	-18.44	34.73	8.69	34.13	138	276	Average
5825	75.43	66.14	86.5	-11.07	34.73	8.69	34.13	138	276	Peak

REMARKS:

- Emission Level = Read Level + Antenna Factor + Cable Loss - Preamp Factor
Margin value = Emission level – Limit value
- 5805MHz: Fundamental frequency.
- 5725MHz & 5825MHz: Out of restricted band



A D T

802.11n (40MHz)

EUT TEST CONDITION		MEASUREMENT DETAIL	
CHANNEL	Channel 151	FREQUENCY RANGE	1GHz ~ 40GHz
INPUT POWER	120Vac, 60 Hz	DETECTOR FUNCTION	Peak (PK) Average (AV)
ENVIRONMENTAL CONDITIONS	25deg. C, 65%RH	TESTED BY	Kay Wu

ANTENNA POLARITY & TEST DISTANCE: HORIZONTAL AT 3 M

FREQ. (MHz)	EMISSION LEVEL (dBuV/m)	READ LEVEL (dBuV)	LIMIT (dBuV/m)	MARGIN (dB)	ANTENNA FACTOR (dB/m)	CABLE LOSS (dB)	PREAMP FACTOR (dB)	ANTENNA HEIGHT (cm)	TABLE ANGLE (Degree)	REMARK
5725	55.84	46.68	68.89	-13.05	34.62	8.65	34.11	142	206	Average
5725	68.62	59.46	76.46	-7.84	34.62	8.65	34.11	142	206	Peak
5755	88.89	79.68			34.66	8.66	34.11	142	206	Average
5755	96.46	87.25			34.66	8.66	34.11	142	206	Peak
5825	44.99	35.7	68.89	-23.9	34.73	8.69	34.13	142	206	Average
5825	58.18	48.89	76.46	-18.28	34.73	8.69	34.13	142	206	Peak

ANTENNA POLARITY & TEST DISTANCE: VERTICAL AT 3 M

FREQ. (MHz)	EMISSION LEVEL (dBuV/m)	READ LEVEL (dBuV)	LIMIT (dBuV/m)	MARGIN (dB)	ANTENNA FACTOR (dB/m)	CABLE LOSS (dB)	PREAMP FACTOR (dB)	ANTENNA HEIGHT (cm)	TABLE ANGLE (Degree)	REMARK
5725	59.93	50.77	73.29	-13.36	34.62	8.65	34.11	100	85	Average
5725	71.92	62.76	80.71	-8.79	34.62	8.65	34.11	100	85	Peak
5755	93.29	84.08			34.66	8.66	34.11	100	85	Average
5755	100.71	91.5			34.66	8.66	34.11	100	85	Peak
5825	44.98	35.69	73.29	-28.31	34.73	8.69	34.13	100	85	Average
5825	57.7	48.41	80.71	-23.01	34.73	8.69	34.13	100	85	Peak

REMARKS:

- Emission Level = Read Level + Antenna Factor + Cable Loss - Preamp Factor
Margin value = Emission level – Limit value
- 5755MHz: Fundamental frequency.
- 5725MHz & 5825MHz: Out of restricted band



A D T

EUT TEST CONDITION		MEASUREMENT DETAIL	
CHANNEL	Channel 159	FREQUENCY RANGE	1GHz ~ 40GHz
INPUT POWER	120Vac, 60 Hz	DETECTOR FUNCTION	Peak (PK) Average (AV)
ENVIRONMENTAL CONDITIONS	25deg. C, 65%RH	TESTED BY	Kay Wu

ANTENNA POLARITY & TEST DISTANCE: HORIZONTAL AT 3 M

FREQ. (MHz)	EMISSION LEVEL (dBuV/m)	READ LEVEL (dBuV)	LIMIT (dBuV/m)	MARGIN (dB)	ANTENNA FACTOR (dB/m)	CABLE LOSS (dB)	PREAMP FACTOR (dB)	ANTENNA HEIGHT (cm)	TABLE ANGLE (Degree)	REMARK
5725	44.84	35.68	68.94	-24.1	34.62	8.65	34.11	142	206	Average
5725	58.1	48.94	76.49	-18.39	34.62	8.65	34.11	142	206	Peak
5795	88.94	79.7			34.69	8.68	34.13	142	206	Average
5795	96.49	87.25			34.69	8.68	34.13	142	206	Peak
5825	53.99	44.7	68.94	-14.95	34.73	8.69	34.13	142	206	Average
5825	65.63	56.34	76.49	-10.86	34.73	8.69	34.13	142	206	Peak

ANTENNA POLARITY & TEST DISTANCE: VERTICAL AT 3 M

FREQ. (MHz)	EMISSION LEVEL (dBuV/m)	READ LEVEL (dBuV)	LIMIT (dBuV/m)	MARGIN (dB)	ANTENNA FACTOR (dB/m)	CABLE LOSS (dB)	PREAMP FACTOR (dB)	ANTENNA HEIGHT (cm)	TABLE ANGLE (Degree)	REMARK
5725	44.84	35.68	74.63	-29.79	34.62	8.65	34.11	138	276	Average
5725	57.01	47.85	81.09	-24.08	34.62	8.65	34.11	138	276	Peak
5795	94.63	85.39			34.69	8.68	34.13	138	276	Average
5795	101.09	91.85			34.69	8.68	34.13	138	276	Peak
5825	57.94	48.65	74.63	-16.69	34.73	8.69	34.13	138	276	Average
5825	68.87	59.58	81.09	-12.22	34.73	8.69	34.13	138	276	Peak

REMARKS:

- Emission Level = Read Level + Antenna Factor + Cable Loss - Preamp Factor
Margin value = Emission level – Limit value
- 5795MHz: Fundamental frequency.
- 5725MHz & 5825MHz: Out of restricted band



A D T

BELOW 1GHz WORST-CASE DATA :

802.11n (40MHz)

EUT TEST CONDITION		MEASUREMENT DETAIL	
CHANNEL	Channel 151	FREQUENCY RANGE	30MHz ~ 1GHz
INPUT POWER	120Vac, 60 Hz	DETECTOR FUNCTION	Peak (PK) Quasi-peak (QP)
ENVIRONMENTAL CONDITIONS	25deg. C, 65%RH	TESTED BY	Kay Wu

ANTENNA POLARITY & TEST DISTANCE: HORIZONTAL AT 3 M

FREQ. (MHz)	EMISSION LEVEL (dBuV/m)	READ LEVEL (dBuV)	LIMIT (dBuV/m)	MARGIN (dB)	ANTENNA FACTOR (dB/m)	CABLE LOSS (dB)	PREAMP FACTOR (dB)	ANTENNA HEIGHT (cm)	TABLE ANGLE (Degree)	REMARK
57	30.51	54.75	40	-9.49	7.09	0.9	32.23	165	210	Peak
124.23	27.86	49.82	43.5	-15.64	8.9	1.38	32.24	155	124	Peak
176.88	27.74	48.12	43.5	-15.76	10.25	1.61	32.24	103	214	Peak
419	20.83	32.84	46	-25.17	17.77	2.41	32.19	165	124	Peak
599.6	25.24	33.46	46	-20.76	21.1	2.87	32.19	175	200	Peak
787.2	28.65	33.41	46	-17.35	24.05	3.27	32.08	188	201	Peak

ANTENNA POLARITY & TEST DISTANCE: VERTICAL AT 3 M

FREQ. (MHz)	EMISSION LEVEL (dBuV/m)	READ LEVEL (dBuV)	LIMIT (dBuV/m)	MARGIN (dB)	ANTENNA FACTOR (dB/m)	CABLE LOSS (dB)	PREAMP FACTOR (dB)	ANTENNA HEIGHT (cm)	TABLE ANGLE (Degree)	REMARK
30.27	35.49	49.47	40	-4.51	17.55	0.74	32.27	102	124	Peak
49.17	32.77	56.03	40	-7.23	8.06	0.9	32.22	156	220	Peak
147.45	18.44	39.27	43.5	-25.06	9.92	1.52	32.27	113	221	Peak
462.4	19.7	30.82	46	-26.3	18.45	2.56	32.13	102	135	Peak
599.6	30.27	38.49	46	-15.73	21.1	2.87	32.19	165	223	Peak
694.8	25.88	31.72	46	-20.12	23.14	3.11	32.09	157	124	Peak

REMARKS: Emission Level = Read Level + Antenna Factor + Cable Loss - Preamp Factor

Margin value = Emission level – Limit value

5.2 CONDUCTED EMISSION MEASUREMENT

5.2.1 LIMITS OF CONDUCTED EMISSION MEASUREMENT

FREQUENCY OF EMISSION (MHz)	CONDUCTED LIMIT (dB μ V)	
	Quasi-peak	Average
0.15 ~ 0.5	66 to 56	56 to 46
0.5 ~ 5	56	46
5 ~ 30	60	50

- NOTE:**
1. The lower limit shall apply at the transition frequencies.
 2. The limit decreases in line with the logarithm of the frequency in the range of 0.15 to 0.50MHz.
 3. All emanations from a class A/B digital device or system, including any network of conductors and apparatus connected thereto, shall not exceed the level of field strengths specified above.

5.2.2 TEST INSTRUMENTS

Same as section 4.2.2.

5.2.3 TEST PROCEDURES

Same as section 4.2.3.

5.2.4 DEVIATION FROM TEST STANDARD

No deviation.

5.2.5 TEST SETUP

Same as section 4.2.5.

5.2.6 EUT OPERATING CONDITIONS

Same as section 4.1.6.

5.2.7 TEST RESULTS

CONDUCTED WORST-CASE DATA :

PHASE	Line 1	6dB BANDWIDTH	9kHz
-------	--------	---------------	------

No	Freq.	Corr. Factor	Reading Value		Emission Level		Limit		Margin	
	[MHz]		[dB (uV)]		[dB (uV)]		[dB (uV)]		(dB)	
			Q.P.	AV.	Q.P.	AV.	Q.P.	AV.	Q.P.	AV.
1	0.18906	0.28	37.22	23.37	37.50	23.65	64.08	54.08	-26.58	-30.43
2	0.38438	0.30	36.98	24.93	37.28	25.23	58.18	48.18	-20.91	-22.96
3	0.93516	0.34	39.90	29.83	40.24	30.17	56.00	46.00	-15.76	-15.83
4	1.27734	0.35	41.72	31.70	42.07	32.05	56.00	46.00	-13.93	-13.95
5	6.62500	0.46	32.58	23.02	33.04	23.48	60.00	50.00	-26.96	-26.52
6	13.55879	0.52	42.08	38.40	42.60	38.92	60.00	50.00	-17.40	-11.08

REMARKS:

1. Q.P. and AV. are abbreviations of quasi-peak and average individually.
2. The emission levels of other frequencies were very low against the limit.
3. Margin value = Emission level - Limit value
4. Correction factor = Insertion loss + Cable loss
5. Emission Level = Correction Factor + Reading Value

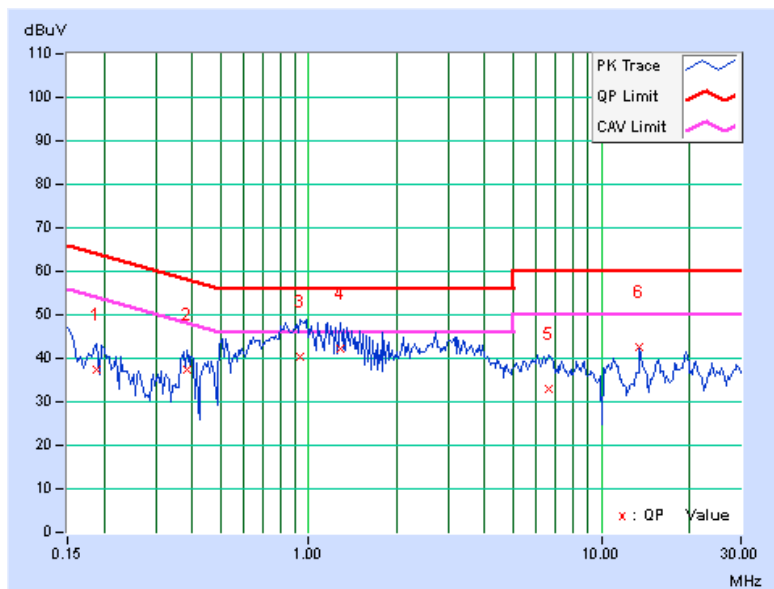

PHASE	Line 2	6dB BANDWIDTH	9kHz
-------	--------	---------------	------

No	Freq. [MHz]	Corr. Factor (dB)	Reading Value [dB (uV)]		Emission Level [dB (uV)]		Limit [dB (uV)]		Margin (dB)	
			Q.P.	AV.	Q.P.	AV.	Q.P.	AV.	Q.P.	AV.
			1	0.20078	0.28	39.41	24.82	39.69	25.10	63.58
2	0.36875	0.30	34.26	19.11	34.56	19.41	58.53	48.53	-23.97	-29.12
3	0.94297	0.34	38.00	26.34	38.34	26.68	56.00	46.00	-17.66	-19.32
4	2.32813	0.38	30.36	20.93	30.74	21.31	56.00	46.00	-25.26	-24.69
5	13.55859	0.55	34.74	33.36	35.29	33.91	60.00	50.00	-24.71	-16.09
6	19.87891	0.64	21.70	13.42	22.34	14.06	60.00	50.00	-37.66	-35.94

REMARKS:

1. Q.P. and AV. are abbreviations of quasi-peak and average individually.
2. The emission levels of other frequencies were very low against the limit.
3. Margin value = Emission level - Limit value
4. Correction factor = Insertion loss + Cable loss
5. Emission Level = Correction Factor + Reading Value

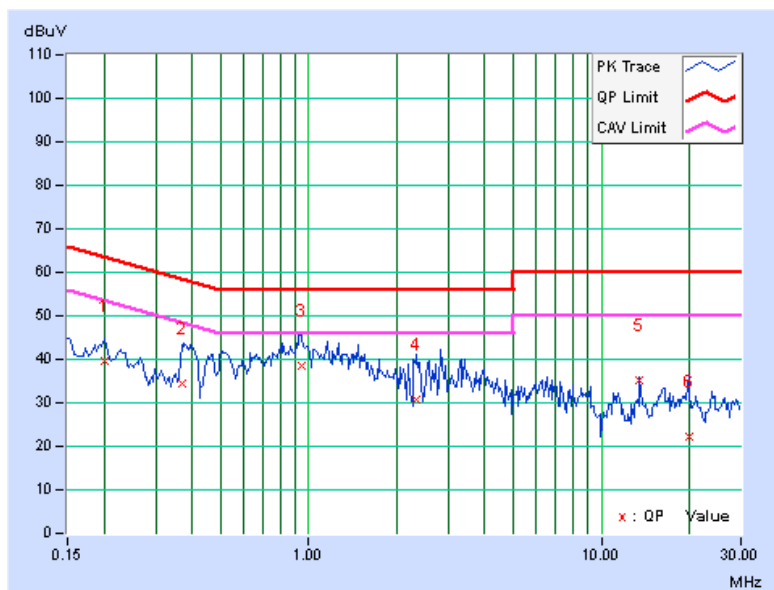

5.3 6dB BANDWIDTH MEASUREMENT

5.3.1 LIMITS OF 6dB BANDWIDTH MEASUREMENT

The minimum of 6dB Bandwidth Measurement is 0.5MHz.

5.3.2 TEST SETUP

Same as section 4.3.2.

5.3.3 TEST INSTRUMENTS

Refer to section 4.1.2 to get information of above instrument.

5.3.4 TEST PROCEDURE

Same as section 4.3.4.

5.3.5 DEVIATION FROM TEST STANDARD

No deviation.

5.3.6 EUT OPERATING CONDITIONS

Same as section 4.3.6.



A D T

5.3.7 TEST RESULTS

802.11a

CHANNEL	FREQUENCY (MHz)	6dB BANDWIDTH (MHz)	MINIMUM LIMIT (MHz)	PASS / FAIL
149	5745	16.37	0.5	PASS
157	5785	16.40	0.5	PASS
161	5805	16.41	0.5	PASS

802.11n (20MHz)

CHANNEL	FREQUENCY (MHz)	6dB BANDWIDTH (MHz)	MINIMUM LIMIT (MHz)	PASS / FAIL
149	5745	17.60	0.5	PASS
157	5785	17.62	0.5	PASS
161	5805	17.62	0.5	PASS

802.11n (40MHz)

CHANNEL	FREQUENCY (MHz)	6dB BANDWIDTH (MHz)	MINIMUM LIMIT (MHz)	PASS / FAIL
151	5755	35.53	0.5	PASS
159	5795	35.30	0.5	PASS



A D T

SPECTRUM PLOT OF WORST VALUE

802.11a

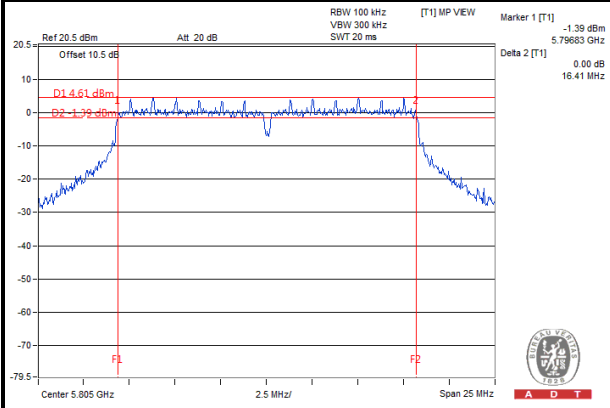

802.11n (20MHz)

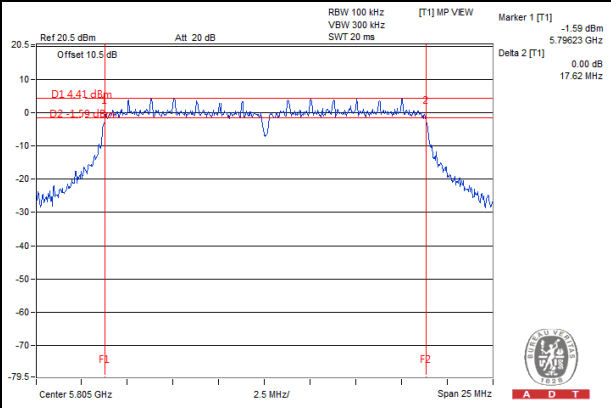

802.11n (40MHz)

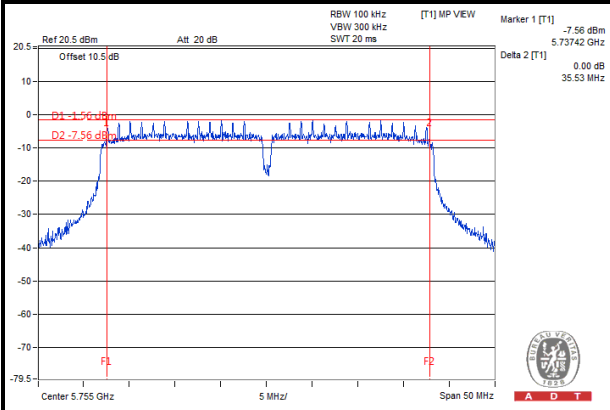

5.4 MAXIMUM OUTPUT POWER

5.4.1 LIMITS OF MAXIMUM OUTPUT POWER MEASUREMENT

For systems using digital modulation in the 5725–5850 MHz bands: 1 Watt (30dBm)

5.4.2 TEST SETUP

Same as section 4.4.2.

5.4.3 INSTRUMENTS

Refer to section 4.1.2 to get information of above instrument.

5.4.4 TEST PROCEDURES

Same as section 4.4.4.

5.4.5 DEVIATION FROM TEST STANDARD

No deviation.

5.4.6 EUT OPERATING CONDITIONS

Same as section 4.3.6.



A D T

5.4.7 TEST RESULTS

802.11a

CHANNEL	FREQUENCY (MHz)	PEAK POWER (mW)	PEAK POWER (dBm)	LIMIT (dBm)	PASS / FAIL
149	5745	239.33	23.79	30	PASS
157	5785	235.50	23.72	30	PASS
161	5805	229.61	23.61	30	PASS

802.11n (20MHz)

CHANNEL	FREQUENCY (MHz)	PEAK POWER (mW)	PEAK POWER (dBm)	LIMIT (dBm)	PASS / FAIL
149	5745	236.59	23.74	30	PASS
157	5785	234.42	23.7	30	PASS
161	5805	234.96	23.71	30	PASS

802.11n (40MHz)

CHANNEL	FREQUENCY (MHz)	PEAK POWER (mW)	PEAK POWER (dBm)	LIMIT (dBm)	PASS / FAIL
151	5755	167.49	22.24	30	PASS
159	5795	165.20	22.18	30	PASS



A D T

5.5 POWER SPECTRAL DENSITY MEASUREMENT

5.5.1 LIMITS OF POWER SPECTRAL DENSITY MEASUREMENT

The Maximum of Power Spectral Density Measurement is 8dBm.

5.5.2 TEST SETUP

Same as section 4.5.2.

5.5.3 TEST INSTRUMENTS

Refer to section 4.1.2 to get information of above instrument.

5.5.4 TEST PROCEDURE.

Same as section 4.5.4.

5.5.5 DEVIATION FROM TEST STANDARD

No deviation.

5.5.6 EUT OPERATING CONDITION

Same as section 4.3.6.

5.5.7 TEST RESULTS

802.11a

CHANNEL	FREQUENCY (MHz)	PSD (dBm/3kHz)	LIMIT (dBm/3kHz)	PASS / FAIL
149	5745	-10.16	8	PASS
157	5785	-10.15	8	PASS
161	5805	-10.32	8	PASS

802.11n (20MHz)

CHANNEL	FREQUENCY (MHz)	PSD (dBm/3kHz)	LIMIT (dBm/3kHz)	PASS / FAIL
149	5745	-9.61	8	PASS
157	5785	-10.69	8	PASS
161	5805	-10.06	8	PASS

802.11n (40MHz)

CHANNEL	FREQUENCY (MHz)	PSD (dBm/3kHz)	LIMIT (dBm/3kHz)	PASS / FAIL
151	5755	-15.84	8	PASS
159	5795	-16.65	8	PASS



A D T

SPECTRUM PLOT OF WORST VALUE

802.11a

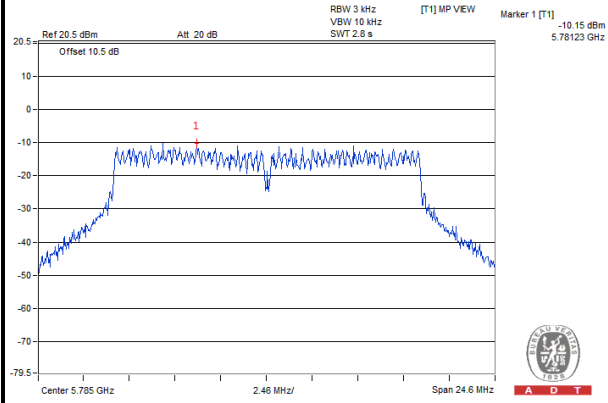

802.11n (20MHz)

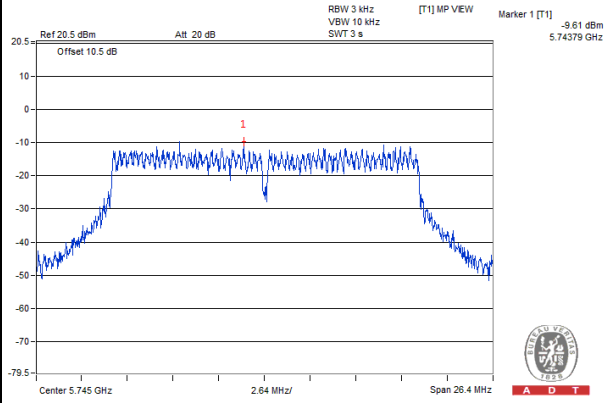

802.11n (40MHz)

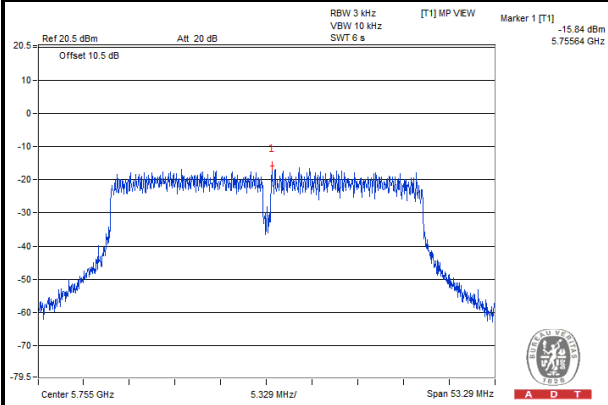

5.6 CONDUCTED OUT OF BAND EMISSION MEASUREMENT

5.6.1 LIMITS OF OUT OF BAND EMISSION MEASUREMENT

Below -20dB of the highest emission level of operating band (in 100kHz Resolution Bandwidth).

5.6.2 TEST SETUP

Same as section 4.6.2.

5.6.3 TEST INSTRUMENTS

Refer to section 4.1.2 to get information of above instrument.

5.6.4 TEST PROCEDURE

Same as section 4.6.4

5.6.5 DEVIATION FROM TEST STANDARD

No deviation.

5.6.6 EUT OPERATING CONDITION

Same as section 4.3.6

5.6.7 TEST RESULTS

The spectrum plots are attached on the following pages. D1 line indicates the highest level, and D2 line indicates the 20dB offset below D1. It shows compliance with the requirement.



A D T

802.11a

CH 149

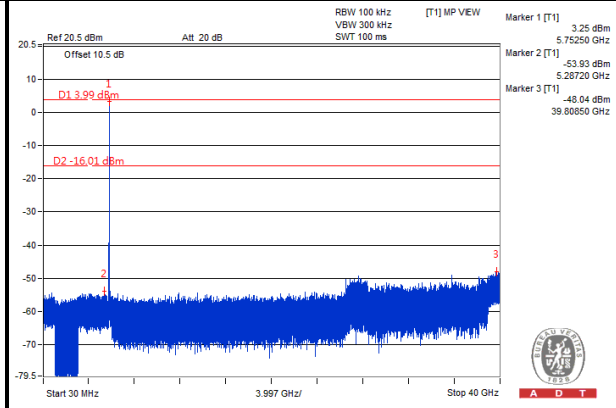
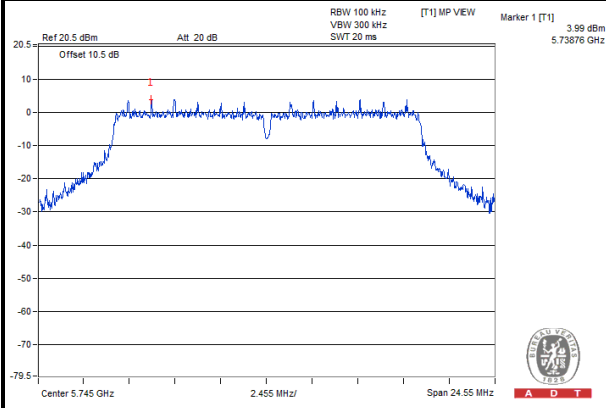

CH 157

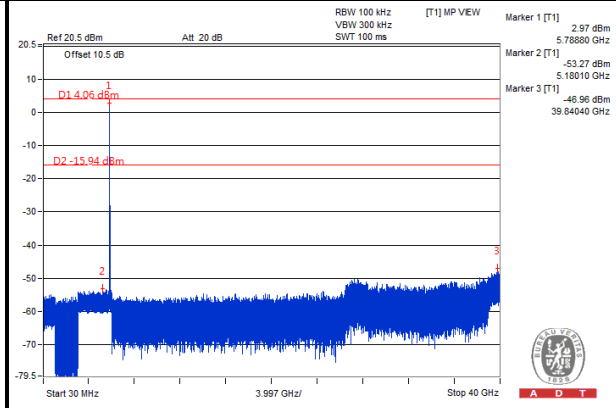
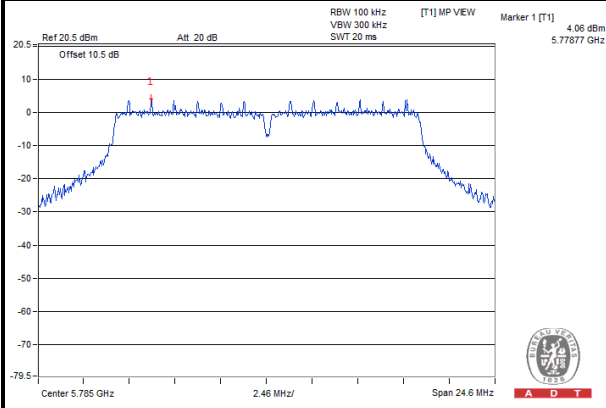

CH 161

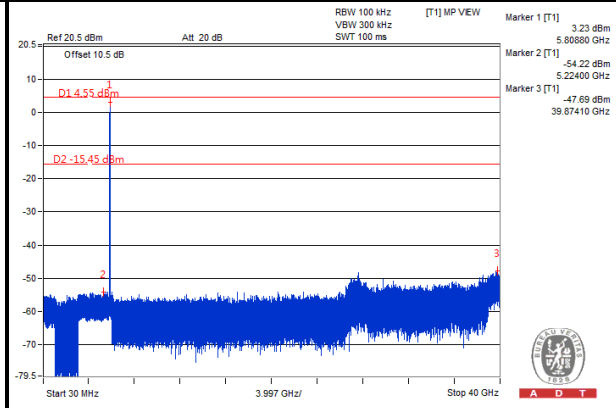
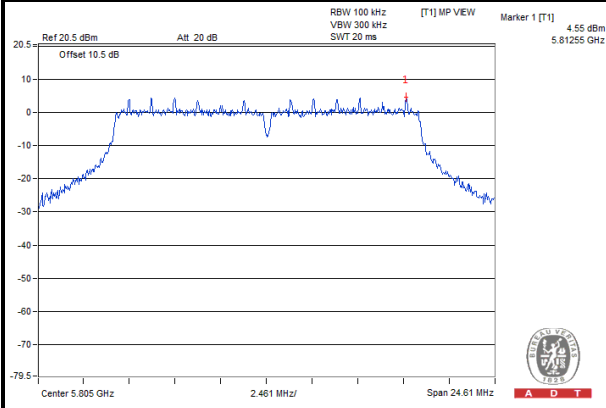



A D T

802.11n (20MHz)

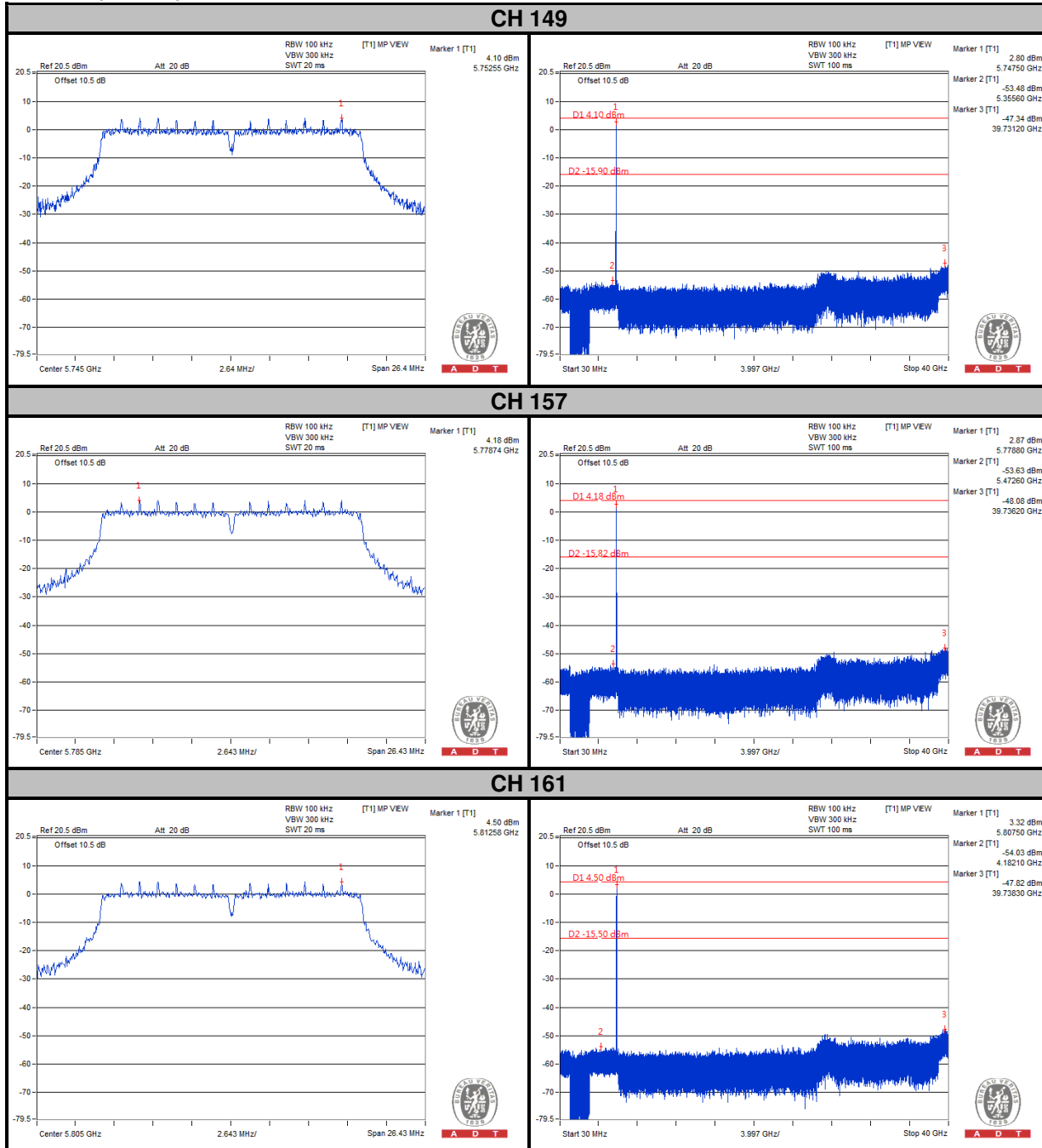



A D T

802.11n (40MHz)

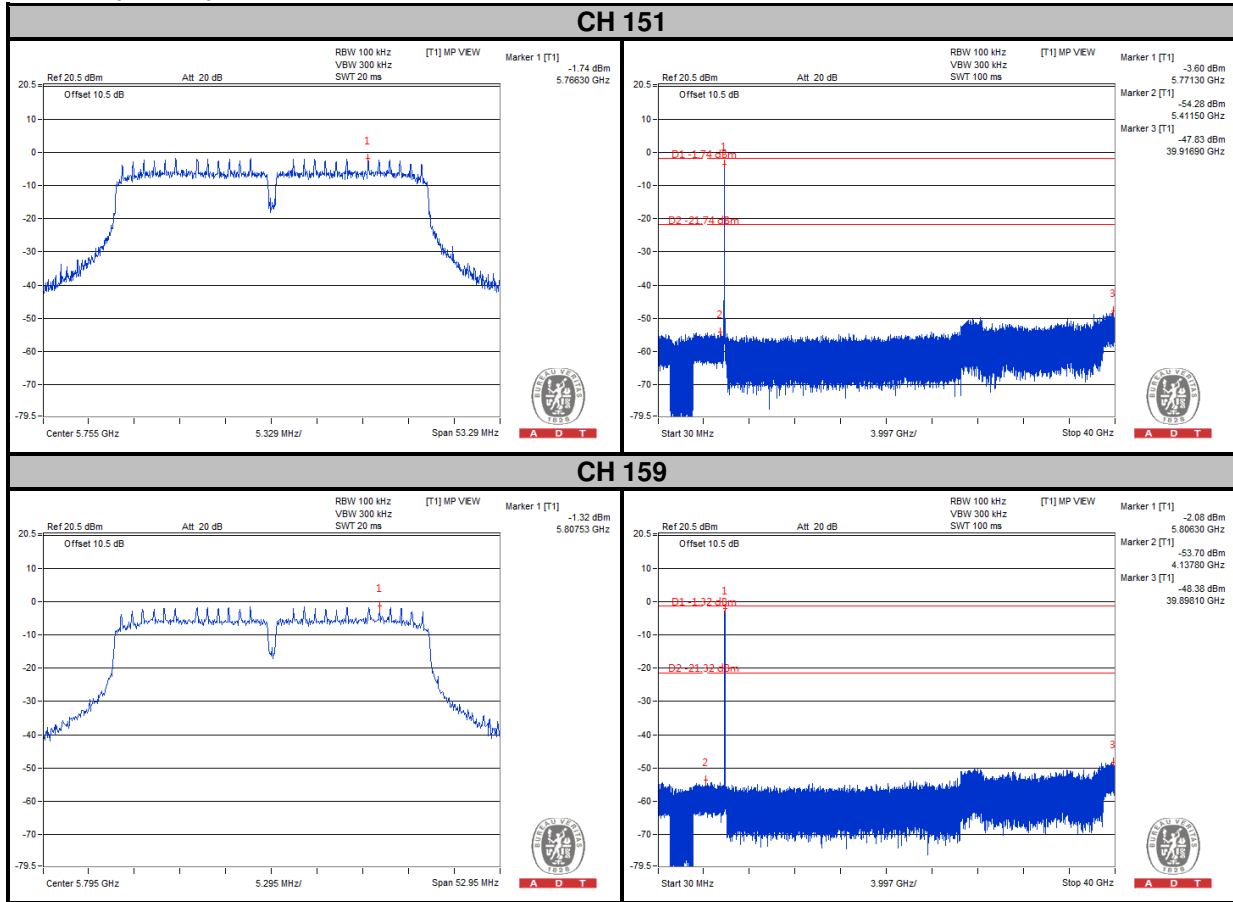



A D T

6. PHOTOGRAPHS OF THE TEST CONFIGURATION

Please refer to the attached file (Test Setup Photo).



7. INFORMATION ON THE TESTING LABORATORIES

We, Bureau Veritas Consumer Products Services (H.K.) Ltd., Taoyuan Branch, were founded in 1988 to provide our best service in EMC, Radio, Telecom and Safety consultation. Our laboratories are accredited and approved according to ISO/IEC 17025.

If you have any comments, please feel free to contact us at the following:

Linko EMC/RF Lab:

Tel: 886-2-26052180

Fax: 886-2-26051924

Hsin Chu EMC/RF Lab:

Tel: 886-3-5935343

Fax: 886-3-5935342

Hwa Ya EMC/RF/Safety Telecom Lab:

Tel: 886-3-3183232

Fax: 886-3-3270892

Email: service.adt@tw.bureauveritas.com

Web Site: www.bureauveritas-adt.com

The address and road map of all our labs can be found in our web site also.



A D T

8. APPENDIX A – MODIFICATIONS RECORDERS FOR ENGINEERING CHANGES TO THE EUT BY THE LAB

No any modifications are made to the EUT by the lab during the test.

---END---