



A D T

# FCC TEST REPORT (PART 22)

**REPORT NO.:** RF140624C19

**MODEL NO.:** 0P82300

**FCC ID:** NM80P82300

**RECEIVED:** Jun. 24, 2014

**TESTED:** Jul. 16, 2014 ~ Aug. 10, 2014

**ISSUED:** Aug. 26, 2014

**APPLICANT:** HTC Corporation

**ADDRESS:** 1F, 6-3 Baoqiang Road, Xindian District, New  
Taipei City, Taiwan 231

**ISSUED BY:** Bureau Veritas Consumer Products Services  
(H.K.) Ltd., Taoyuan Branch

**LAB ADDRESS:** No. 47, 14th Ling, Chia Pau Vil., Lin Kou Dist., New  
Taipei City, Taiwan ( R.O.C. )

**TEST LOCATION:** No. 19, Hwa Ya 2nd Rd, Wen Hwa Tsuen, Kwei  
Shan Hsiang, Taoyuan Hsien 333, Taiwan, R.O.C.

This report should not be used by the client to claim product certification, approval, or endorsement by TAF or any government agencies.



This report is for your exclusive use. Any copying or replication of this report to or for any other person or entity, or use of our name or trademark, is permitted only with our prior written permission. This report sets forth our findings solely with respect to the test samples identified herein. The results set forth in this report are not indicative or representative of the quality or characteristics of the lot from which a test sample was taken or any similar or identical product unless specifically and expressly noted. Our report includes all of the tests requested by you and the results thereof based upon the information that you provided to us. You have 60 days from date of issuance of this report to notify us of any material error or omission caused by our negligence, provided, however, that such notice shall be in writing and shall specifically address the issue you wish to raise. A failure to raise such issue within the prescribed time shall constitute your unqualified acceptance of the completeness of this report, the tests conducted and the correctness of the report contents. Unless specific mention, the uncertainty of measurement has been explicitly taken into account to declare the compliance or non-compliance to the specification

## TABLE OF CONTENTS

RELEASE CONTROL RECORD.....	3
1 CERTIFICATION .....	4
2 SUMMARY OF TEST RESULTS.....	5
2.1 MEASUREMENT UNCERTAINTY .....	5
2.2 TEST SITE AND INSTRUMENTS .....	6
3 GENERAL INFORMATION .....	7
3.1 GENERAL DESCRIPTION OF EUT .....	7
3.2 CONFIGURATION OF SYSTEM UNDER TEST .....	9
3.3 DESCRIPTION OF SUPPORT UNITS .....	9
3.4 TEST ITEM AND TEST CONFIGURATION .....	10
3.5 EUT OPERATING CONDITIONS .....	13
3.6 GENERAL DESCRIPTION OF APPLIED STANDARDS .....	13
4 TEST TYPES AND RESULTS.....	14
4.1 OUTPUT POWER MEASUREMENT .....	14
4.1.1 LIMITS OF OUTPUT POWER MEASUREMENT .....	14
4.1.2 TEST PROCEDURES .....	14
4.1.3 TEST SETUP .....	15
4.1.4 TEST RESULTS .....	16
4.2 FREQUENCY STABILITY MEASUREMENT .....	32
4.2.1 LIMITS OF FREQUENCY STABILITY MEASUREMENT .....	32
4.2.2 TEST PROCEDURE .....	32
4.2.3 TEST SETUP .....	32
4.2.4 TEST RESULTS .....	33
4.3 OCCUPIED BANDWIDTH MEASUREMENT .....	36
4.3.1 TEST PROCEDURES .....	36
4.3.2 TEST SETUP .....	36
4.3.3 TEST RESULTS .....	37
4.4 BAND EDGE MEASUREMENT .....	43
4.4.1 LIMITS OF BAND EDGE MEASUREMENT .....	43
4.4.2 TEST SETUP .....	43
4.4.3 TEST PROCEDURES .....	43
4.4.4 TEST RESULTS .....	44
4.5 CONDUCTED SPURIOUS EMISSIONS.....	54
4.5.1 LIMITS OF CONDUCTED SPURIOUS EMISSIONS MEASUREMENT.....	54
4.5.2 TEST PROCEDURE .....	54
4.5.3 TEST SETUP .....	54
4.5.4 TEST RESULTS .....	55
4.6 RADIATED EMISSION MEASUREMENT .....	58
4.6.1 LIMITS OF RADIATED EMISSION MEASUREMENT .....	58
4.6.2 TEST PROCEDURES .....	58
4.6.3 DEVIATION FROM TEST STANDARD .....	58
4.6.4 TEST SETUP .....	59
4.6.5 TEST RESULTS .....	60
5 PHOTOGRAPHS OF THE TEST CONFIGURATION .....	76
6 INFORMATION ON THE TESTING LABORATORIES .....	77
7 APPENDIX A – MODIFICATIONS RECORDERS FOR ENGINEERING CHANGES TO THE EUT BY THE LAB.....	78



A D T

## RELEASE CONTROL RECORD

ISSUE NO.	REASON FOR CHANGE	DATE ISSUED
RF140624C19	Original release	Aug. 26, 2014



## 1 CERTIFICATION

**PRODUCT:** Tablet

**MODEL:** OP82300

**BRAND:** HTC

**APPLICANT:** HTC Corporation

**TESTED:** Jul. 16, 2014 ~ Aug. 10, 2014

**TEST SAMPLE:** Production Unit

**STANDARDS:** FCC PART 22, Subpart H

The above equipment (model: OP82300) has been tested by **Bureau Veritas Consumer Products Services (H.K.) Ltd., Taoyuan Branch**, and found compliance with the requirement of the above standards. The test record, data evaluation & Equipment Under Test (EUT) configurations represented herein are true and accurate accounts of the measurements of the sample's EMC characteristics under the conditions specified in this report.

**PREPARED BY** : Ivonne Wu , **DATE** : Aug. 26, 2014  
Ivonne Wu / Supervisor

**APPROVED BY** : Sam Chen , **DATE** : Aug. 26, 2014  
Sam Chen / Senior Project Engineer

## 2 SUMMARY OF TEST RESULTS

The EUT has been tested according to the following specifications:

APPLIED STANDARD: FCC Part 22 & Part 2			
STANDARD SECTION	TEST TYPE	RESULT	REMARK
2.1046 22.913 (a)	Effective Radiated Power	PASS	Meet the requirement of limit.
2.1055 22.355	Frequency Stability	PASS	Meet the requirement of limit.
2.1049	Occupied Bandwidth	PASS	Meet the requirement of limit.
22.917	Band Edge Measurements	PASS	Meet the requirement of limit.
2.1051 22.917	Conducted Spurious Emissions	PASS	Meet the requirement of limit.
2.1053 22.917	Radiated Spurious Emissions	PASS	Meet the requirement of limit. Minimum passing margin is -18.55dB at 1672.80MHz.

### 2.1 MEASUREMENT UNCERTAINTY

Where relevant, the following measurement uncertainty levels have been estimated for tests performed on the EUT as specified in CISPR 16-4-2:

MEASUREMENT	FREQUENCY	UNCERTAINTY
Conducted emissions	150kHz~30MHz	2.44 dB
Radiated emissions	30MHz ~ 200MHz	2.93 dB
	200MHz ~1000MHz	2.95 dB
	1GHz ~ 18GHz	2.26 dB
	18GHz ~ 40GHz	1.94 dB

This uncertainty represents an expanded uncertainty expressed at approximately the 95% confidence level using a coverage factor of  $k=2$ .

## 2.2 TEST SITE AND INSTRUMENTS

DESCRIPTION & MANUFACTURER	MODEL NO.	SERIAL NO.	DATE OF CALIBRATION	DUE DATE OF CALIBRATION
Test Receiver ROHDE & SCHWARZ	ESCI	100744	Apr. 15, 2014	Apr. 14, 2015
Spectrum Analyzer ROHDE & SCHWARZ	FSU43	101261	Dec. 21, 2013	Dec. 20, 2014
BILOG Antenna SCHWARZBECK	VULB9168	9168-472	Feb. 27, 2014	Feb. 26, 2015
HORN Antenna SCHWARZBECK	BBHA 9120 D	9120D-969	Feb. 19, 2014	Feb. 18, 2015
HORN Antenna SCHWARZBECK	BBHA 9170	9170-480	Dec. 18, 2013	Dec. 17, 2014
Preamplifier EMCI	EMC 012645	980115	Dec. 26, 2013	Dec. 25, 2014
Preamplifier EMCI	EMC 184045	980116	Jan. 13, 2014	Jan. 12, 2015
Preamplifier EMCI	EMC 330H	980112	Dec. 27, 2013	Dec. 26, 2014
RF signal cable HUBER+SUHNNER	SUCOFLEX 104	309219/4 2950114	Oct. 18, 2013	Oct. 17, 2014
RF signal cable HUBER+SUHNNER	SUCOFLEX 104	250130/4	Oct. 18, 2013	Oct. 17, 2014
RF signal cable Worken	RG-213	NA	Nov. 07, 2013	Nov. 06, 2014
Software BV ADT	E3 6.120103	NA	NA	NA
Antenna Tower MF	MFA-440H	NA	NA	NA
Turn Table MF	MFT-201SS	NA	NA	NA
Antenna Tower & Turn Table Controller MF	MF-7802	NA	NA	NA
JFW 20dB attenuation	50HF-020-SMA	NA	NA	NA
Communications Tester-Wireless	E5515C	MY52102544	Sep. 05, 2012	Sep. 04, 2014
Radio Communication Analyzer	MT8820C	6201300640	Aug. 01, 2013	Jul. 31, 2015

- NOTE:**
1. The calibration interval of the above test instruments is 12/24 months and the calibrations are traceable to NML/ROC and NIST/USA.
  2. The test was performed in HwaYa Chamber 10.
  3. The horn antenna and HP preamplifier (model: 8449B) are used only for the measurement of emission frequency above 1GHz if tested.
  4. The FCC Site Registration No. is 690701.
  5. The IC Site Registration No. is IC 7450F-10.

### 3 GENERAL INFORMATION

#### 3.1 GENERAL DESCRIPTION OF EUT

<b>EUT</b>	Tablet	
<b>MODEL NO.</b>	0P82300	
<b>POWER SUPPLY</b>	5.0Vdc (adapter or host equipment) 3.8Vdc (battery)	
<b>MODULATION TYPE</b>	<b>GPRS</b>	GMSK
	<b>EDGE</b>	GMSK, 8PSK
	<b>WCDMA</b>	BPSK
	<b>LTE</b>	QPSK, 16QAM
<b>FREQUENCY RANGE</b>	<b>GPRS/EDGE</b>	824.2MHz ~ 848.8MHz
	<b>WCDMA</b>	826.4MHz ~ 846.6MHz
	<b>LTE 5 (Channel Bandwidth: 1.4MHz)</b>	824.7MHz ~ 848.3MHz
	<b>LTE 5 (Channel Bandwidth: 3MHz)</b>	825.5MHz ~ 847.5MHz
	<b>LTE 5 (Channel Bandwidth: 5MHz)</b>	826.5MHz ~ 846.5MHz
	<b>LTE 5 (Channel Bandwidth: 10MHz)</b>	829MHz ~ 844MHz
	<b>LTE 26 (Channel Bandwidth: 1.4MHz)</b>	824.7MHz ~ 848.3MHz
	<b>LTE 26 (Channel Bandwidth: 3MHz)</b>	825.5MHz ~ 847.5MHz
	<b>LTE 26 (Channel Bandwidth: 5MHz)</b>	826.5MHz ~ 846.5MHz
	<b>LTE 26 (Channel Bandwidth: 10MHz)</b>	829MHz ~ 844MHz
	<b>LTE 26 (Channel Bandwidth: 15MHz)</b>	831.5MHz ~ 841.5MHz
<b>MAX. ERP POWER</b>	<b>GPRS</b>	391.74mW
	<b>EDGE</b>	94.62mW
	<b>WCDMA</b>	39.08mW
	<b>LTE 5 (Channel Bandwidth: 1.4MHz)</b>	33.43mW
	<b>LTE 5 (Channel Bandwidth: 3MHz)</b>	35.38mW
	<b>LTE 5 (Channel Bandwidth: 5MHz)</b>	37.34mW
	<b>LTE 5 (Channel Bandwidth: 10MHz)</b>	39.98mW
	<b>LTE 26 (Channel Bandwidth: 1.4MHz)</b>	32.66mW
	<b>LTE 26 (Channel Bandwidth: 3MHz)</b>	33.34mW
	<b>LTE 26 (Channel Bandwidth: 5MHz)</b>	33.88mW
	<b>LTE 26 (Channel Bandwidth: 10MHz)</b>	39.70mW
<b>LTE 26 (Channel Bandwidth: 15MHz)</b>	38.89mW	

<b>EMISSION DESIGNATOR</b>	<b>GPRS</b>	245KGXW
	<b>EDGE</b>	243KG7W
	<b>WCDMA</b>	4M18F9W
	<b>LTE 5 (Channel Bandwidth: 1.4MHz)</b>	1M08G7D
	<b>LTE 5 (Channel Bandwidth: 3MHz)</b>	2M68G7D
	<b>LTE 5 (Channel Bandwidth: 5MHz)</b>	4M49G7D
	<b>LTE 5 (Channel Bandwidth: 10MHz)</b>	8M93W7D
	<b>LTE 26 (Channel Bandwidth: 1.4MHz)</b>	1M08G7D
	<b>LTE 26 (Channel Bandwidth: 3MHz)</b>	2M68G7D
	<b>LTE 26 (Channel Bandwidth: 5MHz)</b>	4M50G7D
	<b>LTE 26 (Channel Bandwidth: 10MHz)</b>	8M93W7D
	<b>LTE 26 (Channel Bandwidth: 15MHz)</b>	13M4G7D
<b>ANTENNA TYPE</b>	Fixed Internal Antenna	
<b>I/O PORTS</b>	Refer to users' manual	
<b>DATA CABLE</b>	Refer to NOTE as below	
<b>ACCESSORY DEVICES</b>	Refer to NOTE as below	

**NOTE:**

- There're 2 configurations for the EUT listed as below.  
 Main sample (A): Battery 1 + eMMC 16G  
 2<sup>nd</sup> sample (B): Battery 2 + eMMC 32G  
 ✧ Only the worst test data was presented in the report.
- The EUT's accessories list refers to Ext. Pho.
- The above EUT information was declared by manufacturer and for more detailed features description, please refer to the manufacturer's specifications or User's Manual.



### 3.2 CONFIGURATION OF SYSTEM UNDER TEST

#### FOR RADIATION EMISSION TEST

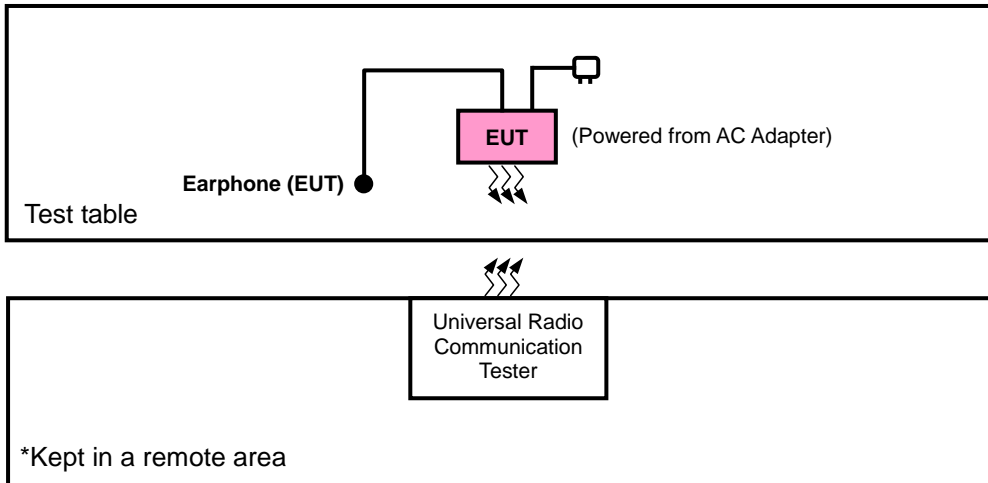

#### FOR E.R.P. TEST

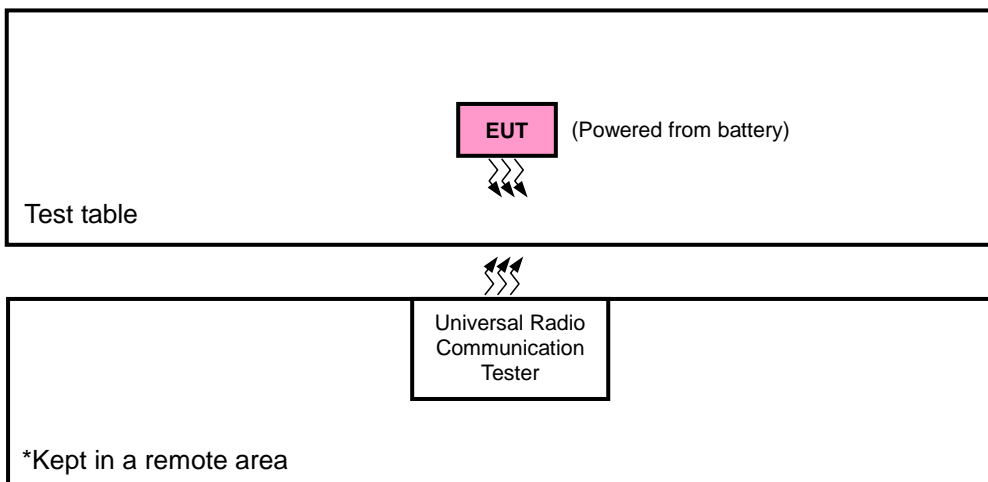

### 3.3 DESCRIPTION OF SUPPORT UNITS

The EUT has been tested as an independent unit together with other necessary accessories or support units.

### 3.4 TEST ITEM AND TEST CONFIGURATION

Pre-Scan has been conducted to determine the worst-case mode from all possible combinations between available modulations, data rates, XYZ axis and antenna ports. The worst case was found when positioned on Z-plane for ERP, Z-axis for GPRS/EDGE/WCDMA/LTE Band 5 and Y-axis for LTE Band 26 for radiated emission for antenna 1. Following channel(s) was (were) selected for the final test as listed below:

EUT CONFIGURE MODE	DESCRIPTION
A	Main sample
B	2 <sup>nd</sup> sample

#### GPRS MODE

EUT CONFIGURE MODE	TEST ITEM	AVAILABLE CHANNEL	TESTED CHANNEL	MODE
A	ERP	128 to 251	128, 189, 251	GPRS, EDGE
B	ERP	128 to 251	128, 189, 251	GPRS
A	FREQUENCY STABILITY	128 to 251	189	GPRS, EDGE
A	OCCUPIED BANDWIDTH	128 to 251	128, 189, 251	GPRS, EDGE
A	BAND EDGE	128 to 251	128, 251	GPRS, EDGE
A	CONDCUDED EMISSION	128 to 251	189	GPRS, EDGE
A	RADIATED EMISSION	128 to 251	189	GPRS, EDGE
B	RADIATED EMISSION	128 to 251	189	GPRS

#### WCDMA MODE

EUT CONFIGURE MODE	TEST ITEM	AVAILABLE CHANNEL	TESTED CHANNEL	MODE
A	ERP	4132 to 4233	4132, 4182, 4233	WCDMA
A	FREQUENCY STABILITY	4132 to 4233	4182	WCDMA
A	OCCUPIED BANDWIDTH	4132 to 4233	4132, 4182, 4233	WCDMA
A	BAND EDGE	4132 to 4233	4132, 4233	WCDMA
A	CONDCUDED EMISSION	4132 to 4233	4182	WCDMA
A	RADIATED EMISSION	4132 to 4233	4182	WCDMA



A D T

**LTE BAND 5 MODE**

EUT CONFIGURE MODE	TEST ITEM	AVAILABLE CHANNEL	TESTED CHANNEL	CHANNEL BANDWIDTH	MODULATION	MODE
A	ERP	20407 to 20643	20407, 20525, 20643	1.4MHz	QPSK, 16QAM	1 RB / 0 RB Offset
		20415 to 20635	20415, 20525, 20635	3MHz	QPSK, 16QAM	1 RB / 0 RB Offset
		20425 to 20625	20425, 20525, 20625	5MHz	QPSK, 16QAM	1 RB / 0 RB Offset
		20450 to 20600	20450, 20525, 20600	10MHz	QPSK, 16QAM	1 RB / 0 RB Offset
B	ERP	20450 to 20600	20450, 20525, 20600	10MHz	QPSK, 16QAM	1 RB / 0 RB Offset
A	FREQUENCY STABILITY	20407 to 20643	20525	1.4MHz	QPSK	1 RB / 0 RB Offset
		20415 to 20635	20525	3MHz	QPSK	1 RB / 0 RB Offset
		20425 to 20625	20525	5MHz	QPSK	1 RB / 0 RB Offset
		20450 to 20600	20525	10MHz	QPSK	1 RB / 0 RB Offset
A	OCCUPIED BANDWIDTH	20407 to 20643	20407, 20525, 20643	1.4MHz	QPSK, 16QAM	6 RB / 0 RB Offset
		20415 to 20635	20415, 20525, 20635	3MHz	QPSK, 16QAM	15 RB / 0 RB Offset
		20425 to 20625	20425, 20525, 20625	5MHz	QPSK, 16QAM	25 RB / 0 RB Offset
		20450 to 20600	20450, 20525, 20600	10MHz	QPSK, 16QAM	50 RB / 0 RB Offset
A	BAND EDGE	20407 to 20643	20407	1.4MHz	QPSK	1 RB / 0 RB Offset
						6 RB / 0 RB Offset
			20643	1.4MHz	QPSK	1 RB / 5 RB Offset
						6 RB / 0 RB Offset
		20415 to 20635	20415	3MHz	QPSK	1 RB / 0 RB Offset
						15 RB / 0 RB Offset
			20635	3MHz	QPSK	1 RB / 14 RB Offset
						15 RB / 0 RB Offset
		20425 to 20626	20425	5MHz	QPSK	1 RB / 0 RB Offset
						25 RB / 0 RB Offset
			20600	5MHz	QPSK	1 RB / 24 RB Offset
						25 RB / 0 RB Offset
20450 to 20600	20450	10MHz	QPSK	1 RB / 0 RB Offset		
				50 RB / 0 RB Offset		
	20600	10MHz	QPSK	1 RB / 49 RB Offset		
				50 RB / 0 RB Offset		
A	CONDCUETED EMISSION	20407 to 20643	20525	1.4MHz	QPSK	1 RB / 0 RB Offset
		20415 to 20635	20525	3MHz	QPSK	1 RB / 0 RB Offset
		20425 to 20625	20525	5MHz	QPSK	1 RB / 0 RB Offset
		20450 to 20600	20525	10MHz	QPSK	1 RB / 0 RB Offset
A, B	RADIATED EMISSION	20450 to 20600	20525	10MHz	QPSK	1 RB / 0 RB Offset

**Note:** This device was tested under all bandwidths, RB configurations and modulations. The worst case was found in QPSK modulation.



**LTE BAND 26 MODE**

EUT CONFIGURE MODE	TEST ITEM	AVAILABLE CHANNEL	TESTED CHANNEL	CHANNEL BANDWIDTH	MODULATION	MODE		
A	ERP	26797 to 27033	26797, 26915, 27033	1.4MHz	QPSK, 16QAM	1 RB / 0 RB Offset		
		26805 to 27025	26805, 26915, 27025	3MHz	QPSK, 16QAM	1 RB / 0 RB Offset		
		26815 to 27015	26815, 26915, 27015	5MHz	QPSK, 16QAM	1 RB / 0 RB Offset		
		26840 to 26990	26840, 26915, 26990	10MHz	QPSK, 16QAM	1 RB / 0 RB Offset		
		26865 to 26965	26865, 26915, 26965	15MHz	QPSK, 16QAM	1 RB / 0 RB Offset		
B	ERP	26865 to 26965	26865, 26915, 26965	15MHz	QPSK, 16QAM	1 RB / 0 RB Offset		
A	FREQUENCY STABILITY	26797 to 27033	26915	1.4MHz	QPSK	1 RB / 0 RB Offset		
		26805 to 27025	26915	3MHz	QPSK	1 RB / 0 RB Offset		
		26815 to 27015	26915	5MHz	QPSK	1 RB / 0 RB Offset		
		26840 to 26990	26915	10MHz	QPSK	1 RB / 0 RB Offset		
		26865 to 26965	26915	15MHz	QPSK	1 RB / 0 RB Offset		
A	OCCUPIED BANDWIDTH	26797 to 27033	26797, 26915, 27033	1.4MHz	QPSK, 16QAM	6 RB / 0 RB Offset		
		26805 to 27025	26805, 26915, 27025	3MHz	QPSK, 16QAM	15 RB / 0 RB Offset		
		26815 to 27015	26815, 26915, 27015	5MHz	QPSK, 16QAM	25 RB / 0 RB Offset		
		26840 to 26990	26840, 26915, 26990	10MHz	QPSK, 16QAM	50 RB / 0 RB Offset		
		26865 to 26965	26865, 26915, 26965	15MHz	QPSK, 16QAM	75 RB / 0 RB Offset		
A	BAND EDGE	26797 to 27033	26797	1.4MHz	QPSK	1 RB / 0 RB Offset 6 RB / 0 RB Offset		
			27033	1.4MHz	QPSK	1 RB / 5 RB Offset 6 RB / 0 RB Offset		
		26805 to 27025	26805	3MHz	QPSK	1 RB / 0 RB Offset 15 RB / 0 RB Offset		
			27025	3MHz	QPSK	1 RB / 14 RB Offset 15 RB / 0 RB Offset		
		26815 to 27015	26815	5MHz	QPSK	1 RB / 0 RB Offset 25 RB / 0 RB Offset		
			27015	5MHz	QPSK	1 RB / 24 RB Offset 25 RB / 0 RB Offset		
		26840 to 26990	26840	10MHz	QPSK	1 RB / 0 RB Offset 50 RB / 0 RB Offset		
			26990	10MHz	QPSK	1 RB / 49 RB Offset 50 RB / 0 RB Offset		
		26865 to 26965	26865	15MHz	QPSK	1 RB / 0 RB Offset 75 RB / 0 RB Offset		
			26965	15MHz	QPSK	1 RB / 74 RB Offset 75 RB / 0 RB Offset		
		A	CONDCUETED EMISSION	26797 to 27033	26915	1.4MHz	QPSK	1 RB / 0 RB Offset
				26805 to 27025	26915	3MHz	QPSK	1 RB / 0 RB Offset
				26815 to 27015	26915	5MHz	QPSK	1 RB / 0 RB Offset
				26840 to 26990	26915	10MHz	QPSK	1 RB / 0 RB Offset
26865 to 26965	26915			15MHz	QPSK	1 RB / 0 RB Offset		
A, B	RADIATED EMISSION	26865 to 26965	26915	15MHz	QPSK	1 RB / 0 RB Offset		

**Note:** This device was tested under all bandwidths, RB configurations and modulations. The worst case was found in QPSK modulation.



### **TEST CONDITION:**

TEST ITEM	ENVIRONMENTAL CONDITIONS	INPUT POWER	TESTED BY
ERP	26deg. C, 58%RH	3.8Vdc	Dylan Yang
FREQUENCY STABILITY	26deg. C, 58%RH	3.8Vdc	Dylan Yang
OCCUPIED BANDWIDTH	26deg. C, 58%RH	3.8Vdc	Dylan Yang
BAND EDGE	26deg. C, 58%RH	3.8Vdc	Dylan Yang
CONDCUDED EMISSION	26deg. C, 58%RH	3.8Vdc	Dylan Yang
RADIATED EMISSION	25deg. C, 65%RH	120Vac, 60Hz	Will Chen / Harry Hsueh

### **3.5 EUT OPERATING CONDITIONS**

The EUT makes a call to the communication simulator. The communication simulator station system controlled a EUT to export maximum output power under transmission mode and specific channel frequency

### **3.6 GENERAL DESCRIPTION OF APPLIED STANDARDS**

The EUT is a RF product. According to the specifications of the manufacturer, it must comply with the requirements of the following standards:

**FCC 47 CFR Part 2**

**FCC 47 CFR Part 22**

**ANSI/TIA/EIA-603-C 2004**

**NOTE:** All test items have been performed and recorded as per the above standards.

## 4 TEST TYPES AND RESULTS

### 4.1 OUTPUT POWER MEASUREMENT

#### 4.1.1 LIMITS OF OUTPUT POWER MEASUREMENT

Mobile / Portable station are limited to 7 watts e.r.p.

#### 4.1.2 TEST PROCEDURES

##### EIRP / ERP MEASUREMENT:

- a. All measurements were done at low, middle and high operational frequency range. RBW and VBW is 1MHz for GPRS & EDGE, 5MHz for WCDMA, and 10MHz for LTE mode.
- b. Substitution method is used for E.I.R.P measurement. In the semi-anechoic chamber, EUT placed on the 0.8m height of Turn Table, rotated the table around 360 degrees to search the maximum radiation power and receiver antenna shall be rotated vertical and horizontal polarization and moved height from 1m to 4m to find the maximum polar radiated power. The "Read Value" is the spectrum reading the maximum power value.
- c. The substitution horn antenna is substituted for EUT at the same position and signals generator export the CW signal to the substitution antenna via a tx cable. Rotated the Turn Table and moved receiving antenna to find the maximum radiation power. Adjust output power level of S.G to get a Value of spectrum reading equal to "Read Value" of step b. Record the power level of S.G
- d.  $EIRP = \text{Output power level of S.G} - \text{TX cable loss} + \text{Antenna gain of substitution horn}$ . E.R.P power can be calculated form E.I.R.P power by subtracting the gain of dipole,  $E.R.P \text{ power} = E.I.R.P \text{ power} - 2.15\text{dBi}$ .

##### CONDUCTED POWER MEASUREMENT:

The EUT was set up for the maximum power with GPRS, EDGE, WCDMA & LTE link data modulation and link up with simulator. Set the EUT to transmit under low, middle and high channel and record the power level shown on simulator.

### 4.1.3 TEST SETUP

#### EIRP / ERP MEASUREMENT:

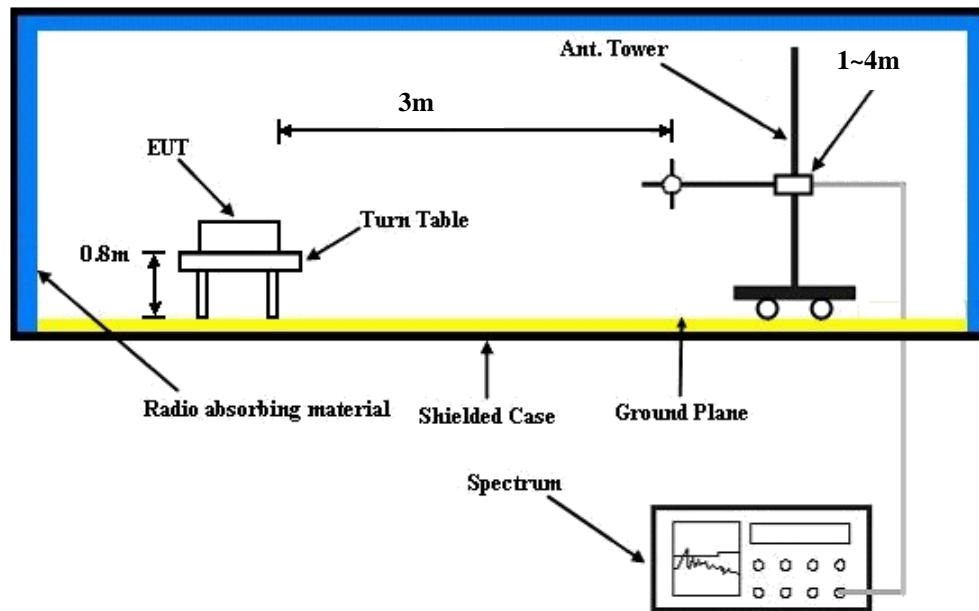

#### CONDUCTED POWER MEASUREMENT:

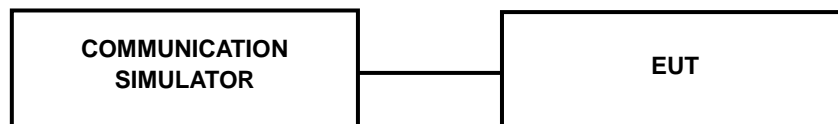



A D T

#### 4.1.4 TEST RESULTS

##### CONDUCTED OUTPUT POWER (dBm)

Band	GPRS850		
Channel	128	189	251
Frequency (MHz)	824.2	836.4	848.8
GPRS 8 (GMSK, 1 slot)	32.87	<b>33.10</b>	32.89
GPRS 10 (GMSK, 2 slot)	32.22	32.25	32.24
GPRS 11 (GMSK, 3 slot)	30.03	30.06	30.05
GPRS 12 (GMSK, 4 slot)	28.93	28.96	28.95
EDGE 8 (GMSK, 1 Uplink)	32.86	32.89	32.88
EDGE 10 (GMSK, 2 Uplink)	32.21	32.24	32.23
EDGE 11 (GMSK, 3 Uplink)	30.01	30.04	30.03
EDGE 12 (GMSK, 4 Uplink)	28.92	28.95	28.94
EDGE 8 (8PSK, 1 Uplink)	26.59	26.62	26.61
EDGE 10 (8PSK, 2 Uplink)	26.46	26.49	26.48
EDGE 11 (8PSK, 3 Uplink)	26.31	26.34	26.33
EDGE 12 (8PSK, 4 Uplink)	25.88	25.91	25.90

Band	WCDMA V		
Channel	4132	4182	4233
Frequency (MHz)	826.4	836.4	846.6
RMC 12.2K	<b>23.04</b>	23.02	22.91
HSDPA Subtest-1	21.92	21.90	21.79
HSDPA Subtest-2	21.94	21.92	21.81
HSDPA Subtest-3	21.53	21.51	21.40
HSDPA Subtest-4	21.56	21.54	21.43
HSUPA Subtest-1	21.53	21.51	21.40
HSUPA Subtest-2	20.40	20.38	20.27
HSUPA Subtest-3	20.55	20.53	20.42
HSUPA Subtest-4	20.25	20.23	20.12
HSUPA Subtest-5	21.95	21.93	21.82





**A D T**

Band / BW	RB Size	RB Offset	QPSK			3GPP MPR (dB)	16QAM			3GPP MPR (dB)
			Low CH 20407	Mid CH 20525	High CH 20643		Low CH 20407	Mid CH 20525	High CH 20643	
			824.7 MHz	836.5 MHz	848.3 MHz		824.7 MHz	836.5 MHz	848.3 MHz	
5 / 1.4M	1	0	22.07	22.27	22.12	0	21.06	21.26	21.11	1
	1	2	22.06	22.14	22.11	0	21.05	21.13	21.1	1
	1	5	22.06	22.14	22.11	0	21.05	21.13	21.1	1
	3	0	22.16	22.24	22.21	0	21.15	21.23	21.2	1
	3	1	22.19	22.15	22.24	0	21.18	21.14	21.23	1
	3	3	22.18	22.26	22.23	0	21.17	21.25	21.22	1
	6	0	21.15	21.23	21.2	1	20.14	20.22	20.19	2

Band / BW	RB Size	RB Offset	QPSK			3GPP MPR (dB)	16QAM			3GPP MPR (dB)
			Low CH 20415	Mid CH 20525	High CH 20635		Low CH 20415	Mid CH 20525	High CH 20635	
			825.5 MHz	836.5 MHz	847.5 MHz		825.5 MHz	836.5 MHz	847.5 MHz	
5 / 3M	1	0	22.2	22.28	22.25	0	21.18	21.26	21.23	1
	1	7	22.19	22.27	22.24	0	21.17	21.25	21.22	1
	1	14	22.19	22.27	22.24	0	21.17	21.25	21.22	1
	8	0	21.15	21.23	21.2	1	20.13	20.21	20.18	2
	8	3	21.18	21.26	21.23	1	20.16	20.24	20.21	2
	8	7	21.17	21.25	21.22	1	20.15	20.23	20.2	2
	15	0	21.28	21.36	21.33	1	20.26	20.34	20.31	2

Band / BW	RB Size	RB Offset	QPSK			3GPP MPR (dB)	16QAM			3GPP MPR (dB)
			Low CH 20425	Mid CH 20525	High CH 20625		Low CH 20425	Mid CH 20525	High CH 20625	
			826.5 MHz	836.5 MHz	846.5 MHz		826.5 MHz	836.5 MHz	846.5 MHz	
5 / 5M	1	0	22.33	22.41	22.38	0	21.27	21.35	21.32	1
	1	12	22.32	22.4	22.37	0	21.26	21.34	21.31	1
	1	24	22.32	22.4	22.37	0	21.26	21.34	21.31	1
	12	0	21.28	21.36	21.33	1	20.22	20.3	20.27	2
	12	6	21.31	21.39	21.36	1	20.25	20.33	20.3	2
	12	13	21.3	21.38	21.35	1	20.24	20.32	20.29	2
	25	0	21.41	21.49	21.46	1	20.35	20.43	20.4	2

Band / BW	RB Size	RB Offset	QPSK			3GPP MPR (dB)	16QAM			3GPP MPR (dB)
			Low CH 20450	Mid CH 20525	High CH 20600		Low CH 20450	Mid CH 20525	High CH 20600	
			829.0 MHz	836.5 MHz	844.0 MHz		829.0 MHz	836.5 MHz	844.0 MHz	
5 / 10M	1	0	22.48	22.56	22.53	0	21.42	21.5	21.47	1
	1	24	22.47	22.55	22.52	0	21.41	21.49	21.46	1
	1	49	22.47	22.55	22.52	0	21.41	21.49	21.46	1
	25	0	21.43	21.51	21.48	1	20.37	20.45	20.42	2
	25	12	21.46	21.54	21.51	1	20.4	20.48	20.45	2
	25	25	21.45	21.53	21.5	1	20.39	20.47	20.44	2
	50	0	21.56	21.64	21.61	1	20.5	20.58	20.55	2



A D T

Band / BW	RB Size	RB Offset	QPSK			3GPP MPR (dB)	16QAM			3GPP MPR (dB)
			Low CH 26797	Mid CH 26915	High CH 27033		Low CH 26797	Mid CH 26915	High CH 27033	
			824.7 MHz	836.5 MHz	848.3 MHz		824.7 MHz	836.5 MHz	848.3 MHz	
26 / 1.4M	1	0	22.07	21.94	21.90	0	21.06	20.93	20.89	1
	1	2	21.99	21.91	21.87	0	20.98	20.90	20.86	1
	1	5	21.96	21.89	21.90	0	20.95	20.88	20.89	1
	3	0	21.08	20.93	20.99	0	20.07	19.92	19.98	1
	3	1	21.04	20.90	20.89	0	20.03	19.89	19.88	1
	3	3	20.99	20.88	20.86	0	19.98	19.87	19.85	1
	6	0	21.09	20.91	21.00	1	20.08	19.90	19.99	2

Band / BW	RB Size	RB Offset	QPSK			3GPP MPR (dB)	16QAM			3GPP MPR (dB)
			Low CH 26805	Mid CH 26915	High CH 27025		Low CH 26805	Mid CH 26915	High CH 27025	
			825.5 MHz	836.5 MHz	847.5 MHz		825.5 MHz	836.5 MHz	847.5 MHz	
26 / 3M	1	0	21.97	22.00	21.96	0	20.96	20.99	20.95	1
	1	7	22.00	21.97	21.93	0	20.99	20.96	20.92	1
	1	14	21.97	21.95	21.96	0	20.96	20.94	20.95	1
	8	0	21.07	20.99	21.05	1	20.06	19.98	20.04	2
	8	3	21.04	20.96	20.95	1	20.03	19.95	19.94	2
	8	7	21.03	20.94	20.92	1	20.02	19.93	19.91	2
	15	0	21.07	20.97	21.06	1	20.06	19.96	20.05	2

Band / BW	RB Size	RB Offset	QPSK			3GPP MPR (dB)	16QAM			3GPP MPR (dB)
			Low CH 26815	Mid CH 26915	High CH 27015		Low CH 26815	Mid CH 26915	High CH 27015	
			826.5 MHz	836.5 MHz	846.5 MHz		826.5 MHz	836.5 MHz	846.5 MHz	
26 / 5M	1	0	22.11	22.07	22.03	0	21.10	21.06	21.02	1
	1	12	22.07	22.04	22.00	0	21.06	21.03	20.99	1
	1	24	22.08	22.02	22.03	0	21.07	21.01	21.02	1
	12	0	21.10	21.06	21.12	1	20.09	20.05	20.11	2
	12	6	21.12	21.03	21.02	1	20.11	20.02	20.01	2
	12	13	21.09	21.01	20.99	1	20.08	20.00	19.98	2
	25	0	21.08	21.04	21.13	1	20.07	20.03	20.12	2

Band / BW	RB Size	RB Offset	QPSK			3GPP MPR (dB)	16QAM			3GPP MPR (dB)
			Low CH 26840	Mid CH 26915	High CH 26990		Low CH 26840	Mid CH 26915	High CH 26990	
			829.0 MHz	836.5 MHz	844.0 MHz		829.0 MHz	836.5 MHz	844.0 MHz	
26 / 10M	1	0	22.27	22.22	22.11	0	21.26	21.21	21.1	1
	1	24	22.23	22.18	22.08	0	21.22	21.17	21.07	1
	1	49	22.26	22.19	22.11	0	21.25	21.18	21.1	1
	25	0	21.25	21.21	21.2	1	20.24	20.2	20.19	2
	25	12	21.41	21.23	21.1	1	20.4	20.22	20.09	2
	25	25	21.24	21.2	21.07	1	20.23	20.19	20.06	2
	50	0	21.25	21.19	21.21	1	20.24	20.18	20.2	2



A D T

Band / BW	RB Size	RB Offset	QPSK			3GPP MPR (dB)	16QAM			3GPP MPR (dB)
			Low CH 26865	Mid CH 26915	High CH 26965		Low CH 26865	Mid CH 26915	High CH 26965	
			831.5 MHz	836.5 MHz	841.5 MHz		831.5 MHz	836.5 MHz	841.5 MHz	
26 / 15M	1	0	22.42	22.41	<b>22.53</b>	0	22.3	22.29	22.39	1
	1	37	22.45	22.38	22.44	0	22.33	22.26	22.34	1
	1	74	22.42	22.41	22.32	0	22.3	22.29	22.31	1
	36	0	21.52	21.5	21.48	1	21.4	21.38	21.43	2
	36	19	21.49	21.4	21.45	1	21.37	21.28	21.4	2
	36	39	21.48	21.37	21.39	1	21.36	21.25	21.36	2
	75	0	21.52	21.51	21.5	1	21.4	21.39	21.41	2



A D T

**ERP POWER (dBm)**

**MODE A**

GPRS							
Plane	Channel	Frequency (MHz)	LVL (dBm)	Correction Factor(dB)	ERP(dBm)	ERP(mW)	Polarization (H/V)
Z	128	824.2	-3.16	31.208	25.90	388.87	H
	189	836.4	-3.22	31.3	25.93	391.74	H
	251	848.8	-3.77	31.222	25.30	339.00	H
	128	824.2	-5.18	31.504	24.17	261.46	V
	189	836.4	-4.84	31.117	24.13	258.64	V
	251	848.8	-5.67	31.922	24.10	257.16	V

EDGE							
Plane	Channel	Frequency (MHz)	LVL (dBm)	Correction Factor(dB)	ERP(dBm)	ERP(mW)	Polarization (H/V)
Z	128	824.2	-9.35	31.208	19.71	93.50	H
	189	836.4	-9.39	31.3	19.76	94.62	H
	251	848.8	-9.98	31.222	19.09	81.13	H
	128	824.2	-10.42	31.504	18.93	78.23	V
	189	836.4	-10.06	31.117	18.91	77.75	V
	251	848.8	-10.90	31.922	18.87	77.13	V

WCDMA							
Plane	Channel	Frequency (MHz)	LVL (dBm)	Correction Factor(dB)	ERP(dBm)	ERP(mW)	Polarization (H/V)
Z	4132	826.4	-13.51	31.208	15.55	35.88	H
	4182	836.4	-13.23	31.3	15.92	39.08	H
	4233	846.6	-13.82	31.222	15.25	33.51	H
	4132	826.4	-15.08	31.504	14.27	26.75	V
	4182	836.4	-14.02	31.117	14.95	31.24	V
	4233	846.6	-15.09	31.922	14.68	29.39	V



A D T

LTE Band 5							
Channel Bandwidth: 1.4MHz / QPSK							
Plane	Channel	Frequency (MHz)	LVL (dBm)	Correction Factor(dB)	ERP(dBm)	ERP(mW)	Polarization (H/V)
Z	20407	824.7	-13.95	31.208	15.11	32.42	H
	20525	836.5	-13.94	31.3	15.21	33.19	H
	20643	848.3	-13.83	31.222	15.24	33.43	H
	20407	824.7	-15.25	31.504	14.10	25.73	V
	20525	836.5	-14.40	31.117	14.57	28.62	V
	20643	848.3	-14.81	31.922	14.96	31.35	V

LTE Band 5							
Channel Bandwidth: 1.4MHz / 16QAM							
Plane	Channel	Frequency (MHz)	LVL (dBm)	Correction Factor(dB)	ERP(dBm)	ERP(mW)	Polarization (H/V)
Z	20407	824.7	-14.99	31.208	14.07	25.52	H
	20525	836.5	-15.25	31.3	13.90	24.55	H
	20643	848.3	-15.02	31.222	14.05	25.42	H
	20407	824.7	-16.47	31.504	12.88	19.43	V
	20525	836.5	-16.54	31.117	12.43	17.49	V
	20643	848.3	-16.87	31.922	12.90	19.51	V



A D T

LTE Band 5							
Channel Bandwidth: 3MHz / QPSK							
Plane	Channel	Frequency (MHz)	LVL (dBm)	Correction Factor(dB)	ERP(dBm)	ERP(mW)	Polarization (H/V)
Z	20415	825.5	-13.57	31.208	15.49	35.38	H
	20525	836.5	-13.74	31.3	15.41	34.75	H
	20635	847.5	-13.69	31.222	15.38	34.53	H
	20415	825.5	-15.25	31.504	14.10	25.73	V
	20525	836.5	-14.29	31.117	14.68	29.36	V
	20635	847.5	-15.33	31.922	14.44	27.81	V

LTE Band 5							
Channel Bandwidth: 3MHz / 16QAM							
Plane	Channel	Frequency (MHz)	LVL (dBm)	Correction Factor(dB)	ERP(dBm)	ERP(mW)	Polarization (H/V)
Z	20415	825.5	-15.05	31.208	14.01	25.17	H
	20525	836.5	-14.96	31.3	14.19	26.24	H
	20635	847.5	-14.69	31.222	14.38	27.43	H
	20415	825.5	-16.34	31.504	13.01	20.02	V
	20525	836.5	-16.35	31.117	12.62	18.27	V
	20635	847.5	-16.57	31.922	13.20	20.90	V



A D T

LTE Band 5							
Channel Bandwidth: 5MHz / QPSK							
Plane	Channel	Frequency (MHz)	LVL (dBm)	Correction Factor(dB)	ERP(dBm)	ERP(mW)	Polarization (H/V)
Z	20425	826.5	-13.91	31.208	15.15	32.72	H
	20525	836.5	-13.89	31.3	15.26	33.57	H
	20625	846.5	-13.35	31.222	15.72	37.34	H
	20425	826.5	-15.32	31.504	14.03	25.32	V
	20525	836.5	-14.25	31.117	14.72	29.63	V
	20625	846.5	-15.51	31.922	14.26	26.68	V

LTE Band 5							
Channel Bandwidth: 5MHz / 16QAM							
Plane	Channel	Frequency (MHz)	LVL (dBm)	Correction Factor(dB)	ERP(dBm)	ERP(mW)	Polarization (H/V)
Z	20425	826.5	-14.98	31.208	14.08	25.57	H
	20525	836.5	-14.69	31.3	14.46	27.93	H
	20625	846.5	-14.60	31.222	14.47	28.00	H
	20425	826.5	-16.22	31.504	13.13	20.58	V
	20525	836.5	-16.14	31.117	12.83	19.17	V
	20625	846.5	-16.55	31.922	13.22	21.00	V



A D T

LTE Band 5							
Channel Bandwidth: 10MHz / QPSK							
Plane	Channel	Frequency (MHz)	LVL (dBm)	Correction Factor(dB)	ERP(dBm)	ERP(mW)	Polarization (H/V)
Z	20450	829.0	-13.04	31.208	16.02	39.98	H
	20525	836.5	-13.68	31.3	15.47	35.24	H
	20600	844.0	-13.40	31.222	15.67	36.91	H
	20450	829.0	-14.20	31.504	15.15	32.76	V
	20525	836.5	-14.10	31.117	14.87	30.67	V
	20600	844.0	-15.45	31.922	14.32	27.05	V

LTE Band 5							
Channel Bandwidth: 10MHz / 16QAM							
Plane	Channel	Frequency (MHz)	LVL (dBm)	Correction Factor(dB)	ERP(dBm)	ERP(mW)	Polarization (H/V)
Z	20450	829.0	-15.03	31.208	14.03	25.28	H
	20525	836.5	-14.28	31.3	14.87	30.69	H
	20600	844.0	-14.58	31.222	14.49	28.13	H
	20450	829.0	-16.18	31.504	13.17	20.77	V
	20525	836.5	-15.84	31.117	13.13	20.54	V
	20600	844.0	-16.61	31.922	13.16	20.71	V





A D T

LTE Band 26							
Channel Bandwidth: 1.4MHz / QPSK							
Plane	Channel	Frequency (MHz)	LVL (dBm)	Correction Factor(dB)	ERP(dBm)	ERP(mW)	Polarization (H/V)
Z	26797	824.7	-14.04	31.208	15.02	31.75	H
	26915	836.5	-14.01	31.3	15.14	32.66	H
	27033	848.3	-14.75	31.222	14.32	27.05	H
	26797	824.7	-15.48	31.504	13.87	24.40	V
	26915	836.5	-14.74	31.117	14.23	26.47	V
	27033	848.3	-16.42	31.922	13.35	21.64	V

LTE Band 26							
Channel Bandwidth: 1.4MHz / 16QAM							
Plane	Channel	Frequency (MHz)	LVL (dBm)	Correction Factor(dB)	ERP(dBm)	ERP(mW)	Polarization (H/V)
Z	26797	824.7	-15.14	31.208	13.92	24.65	H
	26915	836.5	-15.13	31.3	14.02	25.23	H
	27033	848.3	-15.66	31.222	13.41	21.94	H
	26797	824.7	-16.46	31.504	12.89	19.47	V
	26915	836.5	-16.88	31.117	12.09	16.17	V
	27033	848.3	-17.28	31.922	12.49	17.75	V



A D T

LTE Band 26							
Channel Bandwidth: 3MHz / QPSK							
Plane	Channel	Frequency (MHz)	LVL (dBm)	Correction Factor(dB)	ERP(dBm)	ERP(mW)	Polarization (H/V)
Z	26805	825.5	-13.95	31.208	15.11	32.42	H
	26915	836.5	-13.92	31.3	15.23	33.34	H
	27025	847.5	-14.31	31.222	14.76	29.94	H
	26805	825.5	-15.39	31.504	13.96	24.91	V
	26915	836.5	-14.68	31.117	14.29	26.83	V
	27025	847.5	-16.07	31.922	13.70	23.45	V

LTE Band 26							
Channel Bandwidth: 3MHz / 16QAM							
Plane	Channel	Frequency (MHz)	LVL (dBm)	Correction Factor(dB)	ERP(dBm)	ERP(mW)	Polarization (H/V)
Z	26805	825.5	-15.16	31.208	13.90	24.54	H
	26915	836.5	-15.93	31.3	13.22	20.99	H
	27025	847.5	-15.60	31.222	13.47	22.24	H
	26805	825.5	-16.57	31.504	12.78	18.98	V
	26915	836.5	-16.76	31.117	12.21	16.62	V
	27025	847.5	-17.38	31.922	12.39	17.35	V



A D T

LTE Band 26							
Channel Bandwidth: 5MHz / QPSK							
Plane	Channel	Frequency (MHz)	LVL (dBm)	Correction Factor(dB)	ERP(dBm)	ERP(mW)	Polarization (H/V)
Z	26815	826.5	-14.04	31.208	15.02	31.75	H
	26915	836.5	-13.85	31.3	15.30	33.88	H
	27015	846.5	-14.32	31.222	14.75	29.87	H
	26815	826.5	-15.45	31.504	13.90	24.57	V
	26919	836.5	-14.59	31.117	14.38	27.40	V
	27015	846.5	-16.23	31.922	13.54	22.60	V

LTE Band 26							
Channel Bandwidth: 5MHz / 16QAM							
Plane	Channel	Frequency (MHz)	LVL (dBm)	Correction Factor(dB)	ERP(dBm)	ERP(mW)	Polarization (H/V)
Z	26815	826.5	-15.03	31.208	14.03	25.28	H
	26915	836.5	-15.71	31.3	13.44	22.08	H
	27015	846.5	-15.49	31.222	13.58	22.81	H
	26815	826.5	-16.52	31.504	12.83	19.20	V
	26919	836.5	-16.52	31.117	12.45	17.57	V
	27015	846.5	-17.35	31.922	12.42	17.47	V



A D T

LTE Band 26							
Channel Bandwidth: 10MHz / QPSK							
Plane	Channel	Frequency (MHz)	LVL (dBm)	Correction Factor(dB)	ERP(dBm)	ERP(mW)	Polarization (H/V)
Z	26840	829.0	-13.07	31.208	15.99	39.70	H
	26915	836.5	-13.56	31.3	15.59	36.22	H
	26990	844.0	-14.20	31.222	14.87	30.70	H
	26840	829.0	-14.43	31.504	14.92	31.07	V
	26919	836.5	-14.47	31.117	14.50	28.16	V
	26990	844.0	-15.66	31.922	14.11	25.78	V

LTE Band 26							
Channel Bandwidth: 10MHz / 16QAM							
Plane	Channel	Frequency (MHz)	LVL (dBm)	Correction Factor(dB)	ERP(dBm)	ERP(mW)	Polarization (H/V)
Z	26840	829.0	-15.01	31.208	14.05	25.40	H
	26915	836.5	-14.22	31.3	14.93	31.12	H
	26990	844.0	-14.54	31.222	14.53	28.39	H
	26840	829.0	-16.31	31.504	13.04	20.16	V
	26919	836.5	-15.12	31.117	13.85	24.25	V
	26990	844.0	-16.97	31.922	12.80	19.06	V



A D T

LTE Band 26							
Channel Bandwidth: 15MHz / QPSK							
Plane	Channel	Frequency (MHz)	LVL (dBm)	Correction Factor(dB)	ERP(dBm)	ERP(mW)	Polarization (H/V)
Z	26865	831.5	-13.29	31.208	15.77	37.74	H
	26915	836.5	-13.91	31.3	15.24	33.42	H
	26965	841.5	-13.90	31.222	15.17	32.90	H
	26865	831.5	-15.01	31.504	14.34	27.19	V
	26915	836.5	-14.27	31.117	14.70	29.49	V
	26965	841.5	-15.71	31.922	14.06	25.48	V

LTE Band 26							
Channel Bandwidth: 15MHz / 16QAM							
Plane	Channel	Frequency (MHz)	LVL (dBm)	Correction Factor(dB)	ERP(dBm)	ERP(mW)	Polarization (H/V)
Z	26865	831.5	-13.16	31.208	15.90	38.89	H
	26915	836.5	-13.91	31.3	15.24	33.42	H
	26965	841.5	-13.70	31.222	15.37	34.45	H
	26865	831.5	-14.72	31.504	14.63	29.07	V
	26915	836.5	-14.38	31.117	14.59	28.75	V
	26965	841.5	-15.48	31.922	14.29	26.87	V



**MODE B**

GPRS							
Plane	Channel	Frequency (MHz)	LVL (dBm)	Correction Factor(dB)	ERP(dBm)	ERP(mW)	Polarization (H/V)
Z	128	824.2	-3.23	31.208	25.83	382.65	H
	189	836.4	-3.62	31.3	25.53	357.27	H
	251	848.8	-3.74	31.222	25.33	341.35	H
	128	824.2	-5.06	31.504	24.29	268.78	V
	189	836.4	-4.51	31.117	24.46	279.06	V
	251	848.8	-5.19	31.922	24.58	287.21	V

LTE Band 5							
Channel Bandwidth: 10MHz / QPSK							
Plane	Channel	Frequency (MHz)	LVL (dBm)	Correction Factor(dB)	ERP(dBm)	ERP(mW)	Polarization (H/V)
Z	20450	829.0	-13.38	31.208	15.68	36.97	H
	20525	836.5	-13.18	31.3	15.97	39.54	H
	20600	844.0	-13.77	31.222	15.30	33.90	H
	20450	829.0	-14.69	31.504	14.66	29.27	V
	20525	836.5	-14.14	31.117	14.83	30.39	V
	20600	844.0	-15.55	31.922	14.22	26.44	V

LTE Band 5							
Channel Bandwidth: 10MHz / 16QAM							
Plane	Channel	Frequency (MHz)	LVL (dBm)	Correction Factor(dB)	ERP(dBm)	ERP(mW)	Polarization (H/V)
Z	20450	829.0	-14.79	31.208	14.27	26.72	H
	20525	836.5	-14.53	31.3	14.62	28.97	H
	20600	844.0	-14.81	31.222	14.26	26.68	H
	20450	829.0	-16.32	31.504	13.03	20.11	V
	20525	836.5	-15.46	31.117	13.51	22.42	V
	20600	844.0	-16.77	31.922	13.00	19.96	V



A D T

LTE Band 26							
Channel Bandwidth: 15MHz / QPSK							
Plane	Channel	Frequency (MHz)	LVL (dBm)	Correction Factor(dB)	ERP(dBm)	ERP(mW)	Polarization (H/V)
Z	26865	831.5	-13.55	31.208	15.51	35.55	H
	26915	836.5	-13.49	31.3	15.66	36.81	H
	26965	841.5	-13.18	31.222	15.89	38.83	H
	26865	831.5	-15.12	31.504	14.23	26.51	V
	26915	836.5	-14.46	31.117	14.51	28.23	V
	26965	841.5	-15.21	31.922	14.56	28.59	V

LTE Band 26							
Channel Bandwidth: 15MHz / 16QAM							
Plane	Channel	Frequency (MHz)	LVL (dBm)	Correction Factor(dB)	ERP(dBm)	ERP(mW)	Polarization (H/V)
Z	26865	831.5	-13.49	31.208	15.57	36.04	H
	26915	836.5	-13.95	31.3	15.20	33.11	H
	26965	841.5	-13.77	31.222	15.30	33.90	H
	26865	831.5	-14.73	31.504	14.62	29.00	V
	26915	836.5	-14.16	31.117	14.81	30.25	V
	26965	841.5	-15.20	31.922	14.57	28.65	V

## 4.2 FREQUENCY STABILITY MEASUREMENT

### 4.2.1 LIMITS OF FREQUENCY STABILITY MEASUREMENT

1.5 ppm is for base and fixed station. 2.5 ppm is for mobile station.

### 4.2.2 TEST PROCEDURE

- Device is placed at the oven room. The oven room could control the temperatures and humidity. Power warm up is at least 15 min and power applied should perform before recording frequency error.
- EUT is connected the external power supply to control the DC input power. The test voltage range is from minimum to maximum working voltage. Each step shall be record the frequency error rate.
- The temperature range step is 10 degrees in this test items. All temperature levels shall be hold the  $\pm 0.5^{\circ}\text{C}$  during the measurement testing. The each temperature step shall be at least 0.5 hours, consider the EUT could be test under the stability condition.

**NOTE:** The frequency error was recorded frequency error from the communication simulator.

### 4.2.3 TEST SETUP

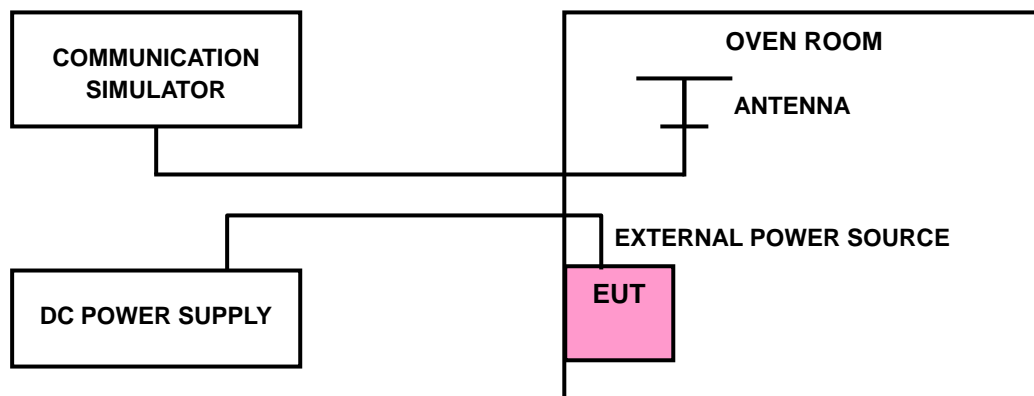



#### 4.2.4 TEST RESULTS

##### FREQUENCY ERROR vs. VOLTAGE

VOLTAGE (Volts)	FREQUENCY ERROR (ppm)			LIMIT (ppm)
	GPRS	EDGE	WCDMA	
3.8	0.030	0.021	-0.004	2.5
3.6	0.027	0.019	-0.003	2.5
4.35	0.029	0.017	-0.004	2.5

**NOTE:** The applicant defined the normal working voltage of the battery is from 3.6Vdc to 4.35Vdc.

##### FREQUENCY ERROR vs. TEMPERATURE

TEMP. (°C)	FREQUENCY ERROR (ppm)			LIMIT (ppm)
	GPRS	EDGE	WCDMA	
-30	0.027	0.016	-0.003	2.5
-20	0.029	0.019	-0.004	2.5
-10	0.033	0.017	-0.002	2.5
0	0.029	0.014	-0.003	2.5
10	0.034	0.015	-0.004	2.5
20	0.026	0.016	-0.003	2.5
30	0.031	0.018	-0.002	2.5
40	0.029	0.011	-0.001	2.5
50	0.031	0.013	-0.003	2.5
55	0.034	0.017	-0.003	2.5

### FREQUENCY ERROR vs. VOLTAGE

VOLTAGE (Volts)	FREQUENCY ERROR (ppm)				LIMIT (ppm)
	LTE Band 5				
	1.4MHz	3MHz	5MHz	10MHz	
3.8	-0.004	-0.004	-0.003	-0.004	2.5
3.6	-0.003	-0.002	-0.002	-0.003	2.5
4.35	-0.002	-0.003	-0.004	-0.002	2.5

**NOTE:** The applicant defined the normal working voltage of the battery is from 3.6Vdc to 4.35Vdc.

### FREQUENCY ERROR vs. TEMPERATURE

TEMP. (°C)	FREQUENCY ERROR (ppm)				LIMIT (ppm)
	LTE Band 5				
	1.4MHz	3MHz	5MHz	10MHz	
-30	-0.003	-0.002	-0.003	-0.003	2.5
-20	-0.004	-0.003	-0.005	-0.004	2.5
-10	-0.001	-0.006	-0.003	-0.005	2.5
0	-0.004	-0.002	-0.001	-0.002	2.5
10	-0.006	-0.004	-0.003	-0.003	2.5
20	-0.002	-0.007	-0.005	-0.005	2.5
30	-0.002	-0.005	-0.003	-0.006	2.5
40	-0.003	-0.003	-0.005	-0.003	2.5
50	-0.002	-0.004	-0.005	-0.003	2.5
55	-0.003	-0.002	-0.004	-0.003	2.5

### FREQUENCY ERROR vs. VOLTAGE

VOLTAGE (Volts)	FREQUENCY ERROR (ppm)					LIMIT (ppm)
	LTE Band 26					
	1.4MHz	3MHz	5MHz	10MHz	15MHz	
3.8	-0.006	-0.007	-0.003	-0.004	-0.005	2.5
3.6	-0.007	-0.007	-0.004	-0.003	-0.003	2.5
4.35	-0.005	-0.005	-0.005	-0.002	-0.002	2.5

**NOTE:** The applicant defined the normal working voltage of the battery is from 3.6Vdc to 4.35Vdc.

### FREQUENCY ERROR vs. TEMPERATURE

TEMP. (°C)	FREQUENCY ERROR (ppm)					LIMIT (ppm)
	LTE Band 26					
	1.4MHz	3MHz	5MHz	10MHz	15MHz	
-30	-0.005	-0.005	-0.006	-0.006	-0.003	2.5
-20	-0.004	-0.005	-0.007	-0.005	-0.004	2.5
-10	-0.005	-0.005	-0.005	-0.003	-0.006	2.5
0	-0.006	-0.007	-0.003	-0.005	-0.006	2.5
10	-0.006	-0.003	-0.003	-0.007	-0.007	2.5
20	-0.004	-0.003	-0.002	-0.006	-0.005	2.5
30	-0.003	-0.004	-0.005	-0.005	-0.004	2.5
40	-0.007	-0.004	-0.002	-0.003	-0.005	2.5
50	-0.008	-0.003	-0.006	-0.002	-0.003	2.5
55	-0.005	-0.004	-0.006	-0.002	-0.003	2.5

## 4.3 OCCUPIED BANDWIDTH MEASUREMENT

### 4.3.1 TEST PROCEDURES

The EUT makes a call to the communication simulator. All measurements were done at low, middle and high operational frequency range. The communication simulator station system controlled a EUT to export maximum output power under transmission mode and specific channel frequency. Use OBW measurement function of Spectrum analyzer to measure 99 % occupied bandwidth.

### 4.3.2 TEST SETUP

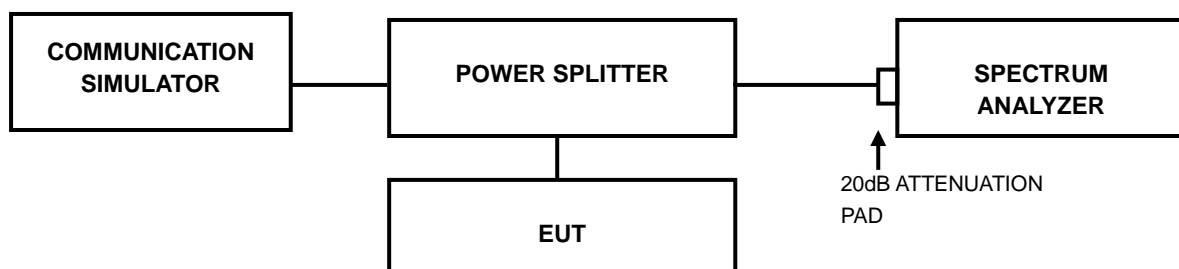

### 4.3.3 TEST RESULTS

CHANNEL	FREQUENCY (MHz)	99% OCCUPIED BANDWIDTH (kHz)		CHANNEL	FREQUENCY (MHz)	99% OCCUPIED BANDWIDTH (MHz)
		GPRS	EDGE			WCDMA
128	824.2	244.26	241.46	4132	826.4	4.1694
189	836.4	244.32	242.95	4182	836.4	4.1651
251	848.8	245.20	243.08	4233	846.6	4.1755
CHANNEL	FREQUENCY (MHz)	26dB BANDWIDTH (kHz)		CHANNEL	FREQUENCY (MHz)	26dB BANDWIDTH (MHz)
		GPRS	EDGE			WCDMA
128	824.2	313.40	302.50	4132	826.4	4.676
189	836.4	314.50	304.50	4182	836.4	4.677
251	848.8	317.30	310.20	4233	846.6	4.680

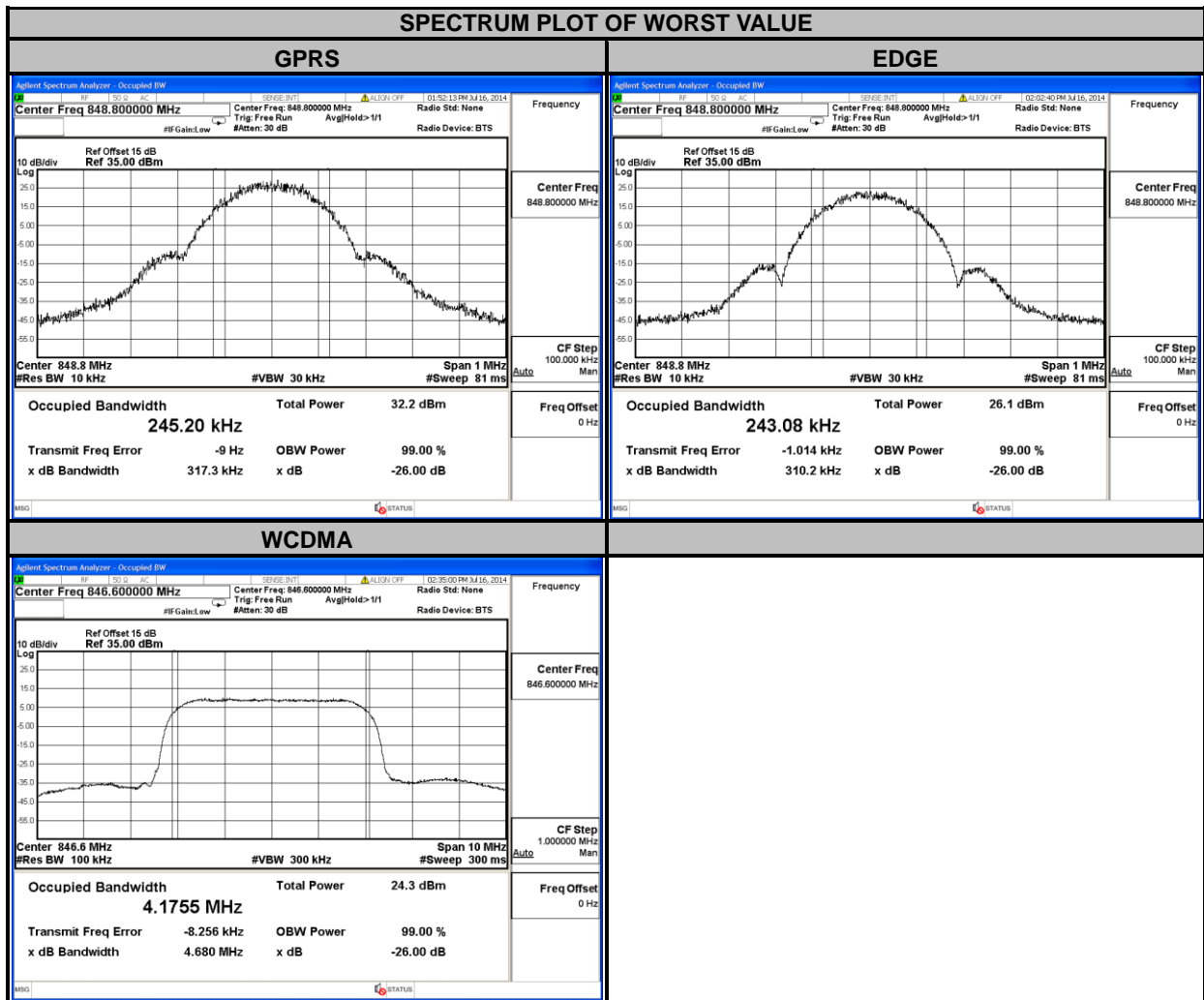



A D T

LTE BAND 5							
CHANNEL BANDWIDTH: 1.4MHz				CHANNEL BANDWIDTH: 3MHz			
CHANNEL	FREQUENCY (MHz)	99% OCCUPIED BANDWIDTH (MHz)		CHANNEL	FREQUENCY (MHz)	99% OCCUPIED BANDWIDTH (MHz)	
		QPSK	16QAM			QPSK	16QAM
20407	824.7	1.0795	1.0761	20415	825.5	2.6810	2.6814
20525	836.5	1.0783	1.0776	20525	836.5	2.6813	2.6795
20643	848.3	1.0795	1.0780	20635	847.5	2.6817	2.6804
CHANNEL	FREQUENCY (MHz)	26dB BANDWIDTH (MHz)		CHANNEL	FREQUENCY (MHz)	26dB BANDWIDTH (MHz)	
		QPSK	16QAM			QPSK	16QAM
20407	824.7	1.225	1.228	20415	825.5	2.859	2.884
20525	836.5	1.227	1.226	20525	836.5	2.879	2.880
20643	848.3	1.236	1.237	20635	847.5	2.886	2.887

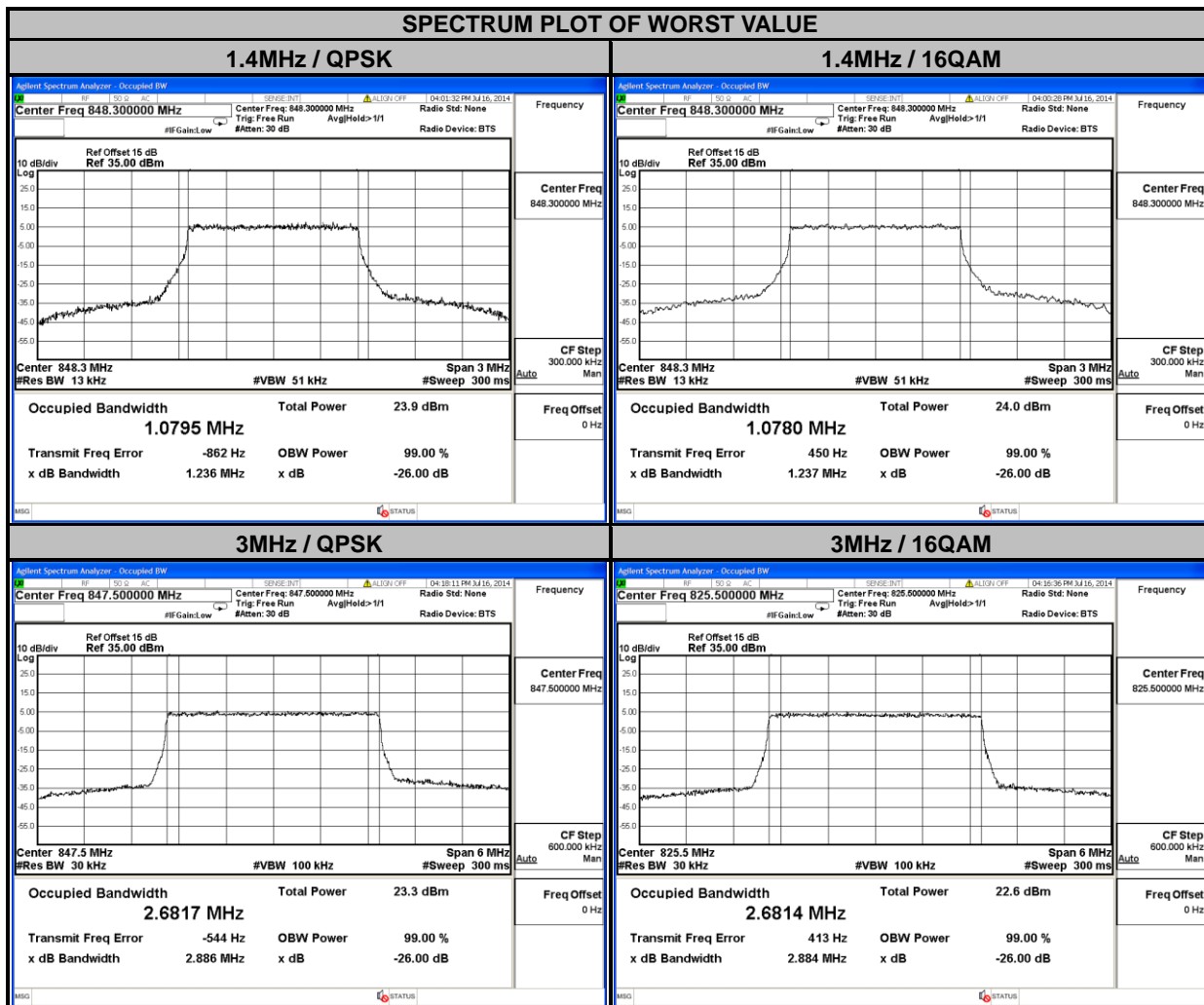



A D T

LTE BAND 5							
CHANNEL BANDWIDTH: 5MHz				CHANNEL BANDWIDTH: 10MHz			
CHANNEL	FREQUENCY (MHz)	99% OCCUPIED BANDWIDTH (MHz)		CHANNEL	FREQUENCY (MHz)	99% OCCUPIED BANDWIDTH (MHz)	
		QPSK	16QAM			QPSK	16QAM
20425	826.5	4.4891	4.4857	20450	829.0	8.9295	8.9313
20525	836.5	4.4814	4.4831	20525	836.5	8.9200	8.9158
20625	846.5	4.4908	4.4891	20600	844.0	8.9269	8.9248
CHANNEL	FREQUENCY (MHz)	26dB BANDWIDTH (MHz)		CHANNEL	FREQUENCY (MHz)	26dB BANDWIDTH (MHz)	
		QPSK	16QAM			QPSK	16QAM
20425	826.5	4.830	4.815	20450	829.0	9.412	9.403
20525	836.5	4.853	4.810	20525	836.5	9.397	9.366
20625	846.5	4.848	4.820	20600	844.0	9.380	9.390

SPECTRUM PLOT OF WORST VALUE

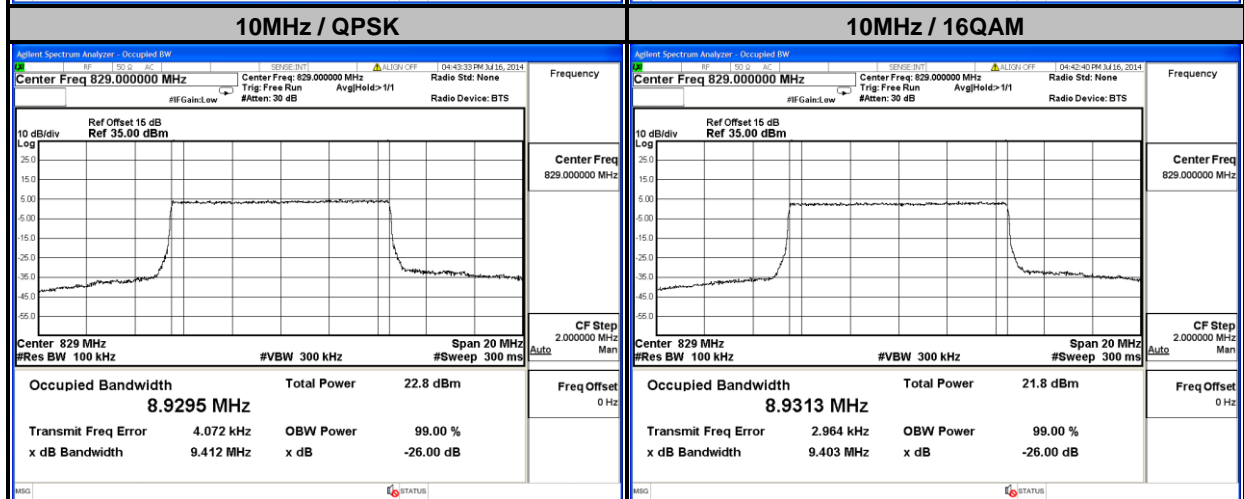
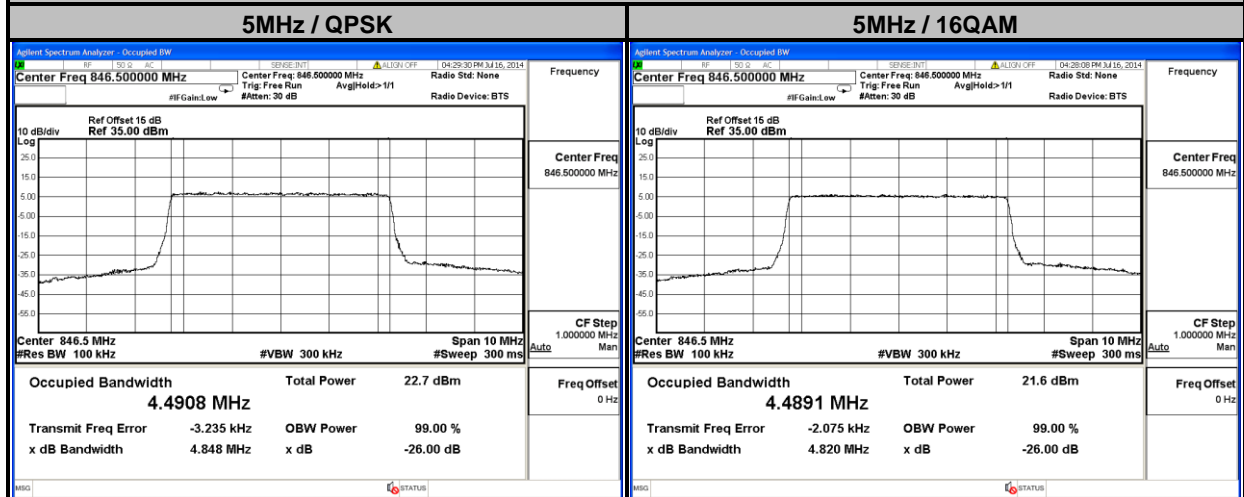



LTE BAND 26							
CHANNEL BANDWIDTH: 1.4MHz				CHANNEL BANDWIDTH: 3MHz			
CHANNEL	FREQUENCY (MHz)	99% OCCUPIED BANDWIDTH (MHz)		CHANNEL	FREQUENCY (MHz)	99% OCCUPIED BANDWIDTH (MHz)	
		QPSK	16QAM			QPSK	16QAM
26797	824.7	1.0795	1.0758	26805	825.5	2.6798	2.6786
26915	836.5	1.0797	1.0774	26915	836.5	2.6789	2.6792
27033	848.3	1.0772	1.0772	27025	847.5	2.6830	2.6820
CHANNEL	FREQUENCY (MHz)	26dB BANDWIDTH (MHz)		CHANNEL	FREQUENCY (MHz)	26dB BANDWIDTH (MHz)	
		QPSK	16QAM			QPSK	16QAM
26797	824.7	1.230	1.227	26805	825.5	2.863	2.882
26915	836.5	1.226	1.245	26915	836.5	2.885	2.884
27033	848.3	1.238	1.226	27025	847.5	2.875	2.889

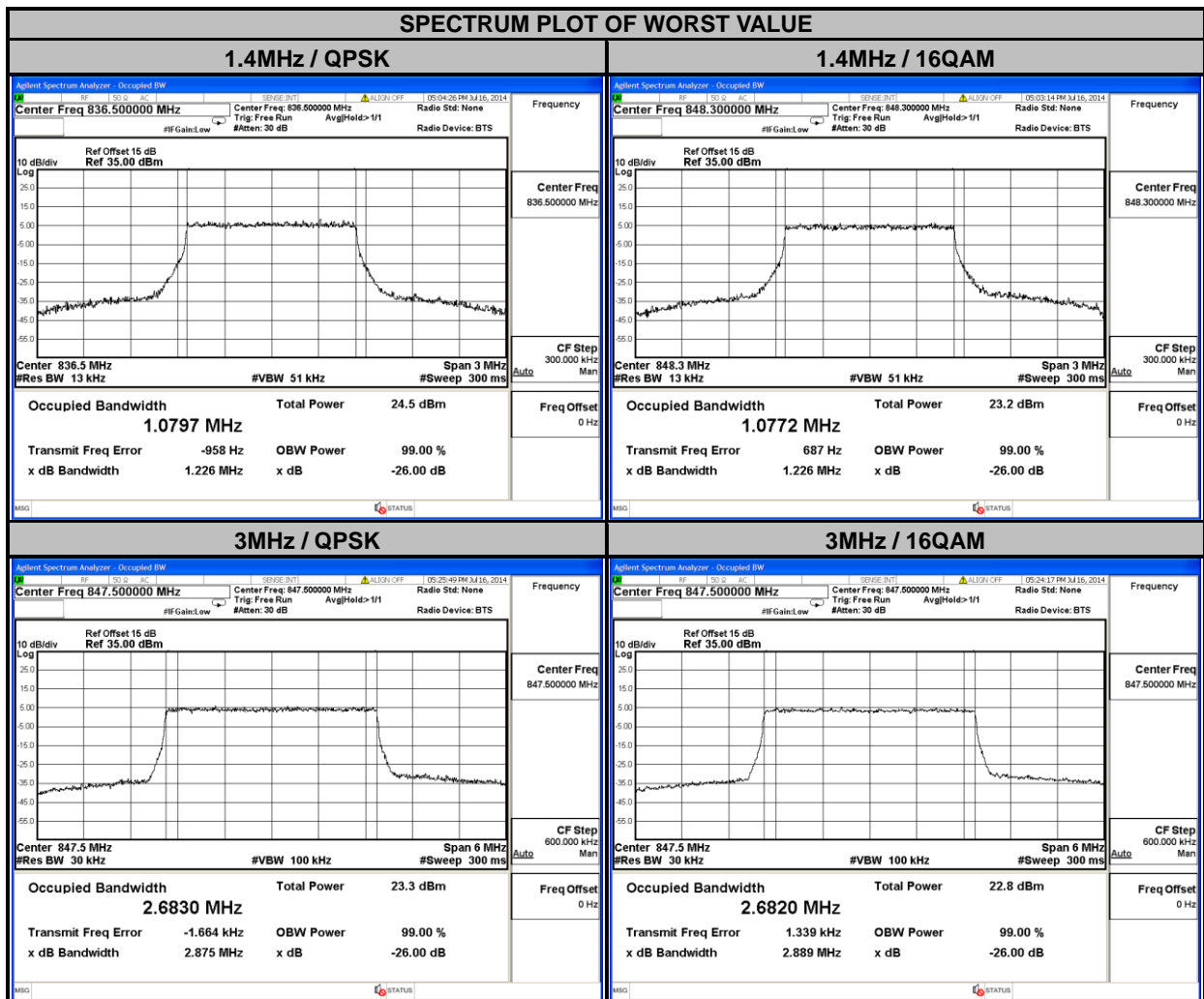





A D T

LTE BAND 26							
CHANNEL BANDWIDTH: 5MHz				CHANNEL BANDWIDTH: 10MHz			
CHANNEL	FREQUENCY (MHz)	99% OCCUPIED BANDWIDTH (MHz)		CHANNEL	FREQUENCY (MHz)	99% OCCUPIED BANDWIDTH (MHz)	
		QPSK	16QAM			QPSK	16QAM
26815	826.5	4.4899	4.4872	26840	829.0	8.9285	8.9319
26915	836.5	4.4879	4.4811	26915	836.5	8.9203	8.9134
27015	846.5	4.4954	4.4860	26990	844.0	8.9258	8.9334
CHANNEL	FREQUENCY (MHz)	26dB BANDWIDTH (MHz)		CHANNEL	FREQUENCY (MHz)	26dB BANDWIDTH (MHz)	
		QPSK	16QAM			QPSK	16QAM
26815	826.5	4.853	4.825	26840	829.0	9.401	9.409
26915	836.5	4.817	4.793	26915	836.5	9.383	9.345
27015	846.5	4.832	4.817	26990	844.0	9.364	9.385

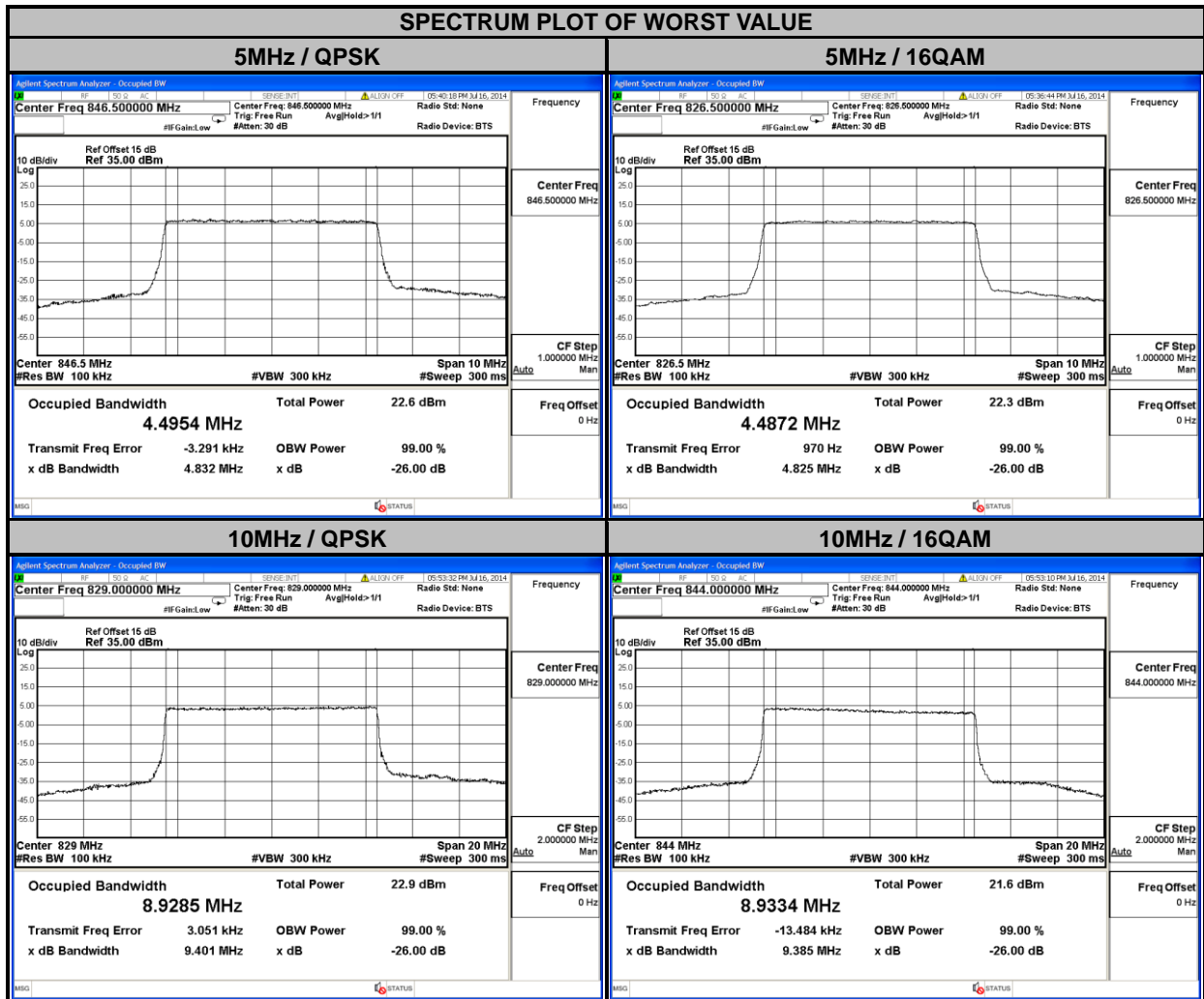



A D T

LTE BAND 26							
CHANNEL BANDWIDTH: 15MHz							
CHANNEL	FREQUENCY (MHz)	99% OCCUPIED BANDWIDTH (MHz)		CHANNEL	FREQUENCY (MHz)	26dB BANDWIDTH (MHz)	
		QPSK	16QAM			QPSK	16QAM
26865	831.5	13.377	13.366	26865	831.5	13.94	13.98
26915	836.5	13.345	13.339	26915	836.5	13.88	13.94
26965	841.5	13.365	13.350	26965	841.5	13.91	13.94

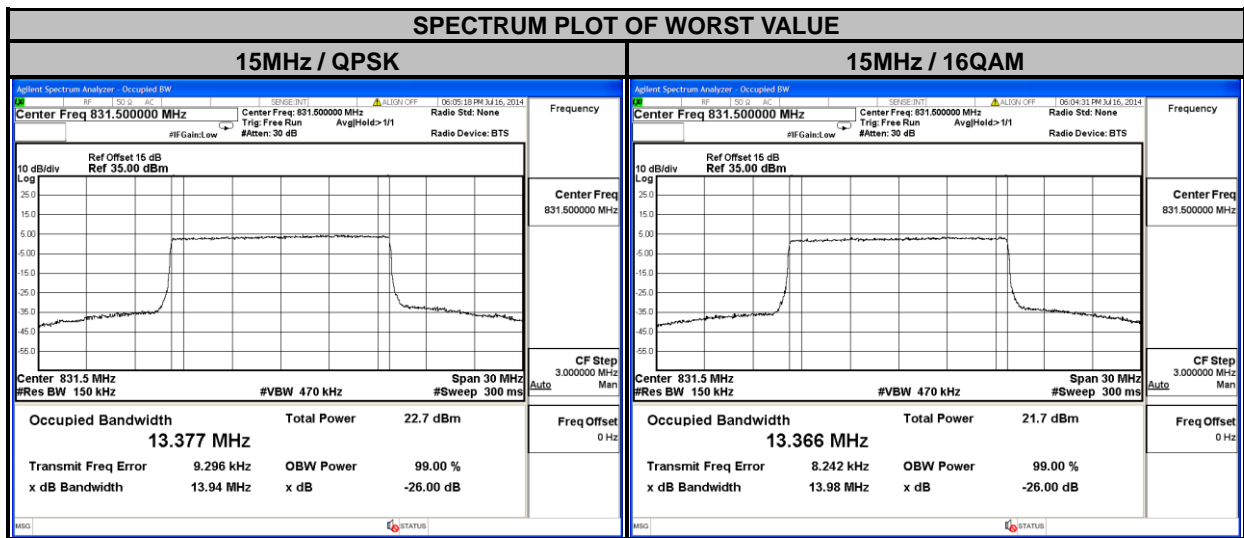

## 4.4 BAND EDGE MEASUREMENT

### 4.4.1 LIMITS OF BAND EDGE MEASUREMENT

Power of any emission outside of the authorized operating frequency ranges must be attenuated below the transmitting power (P) by a factor of at least  $43 + 10 \log(P)$  dB. In the 1 MHz bands immediately outside and adjacent to the frequency block a resolution bandwidth of at least one percent of the emission bandwidth of the fundamental emission of the transmitter may be employed.

### 4.4.2 TEST SETUP

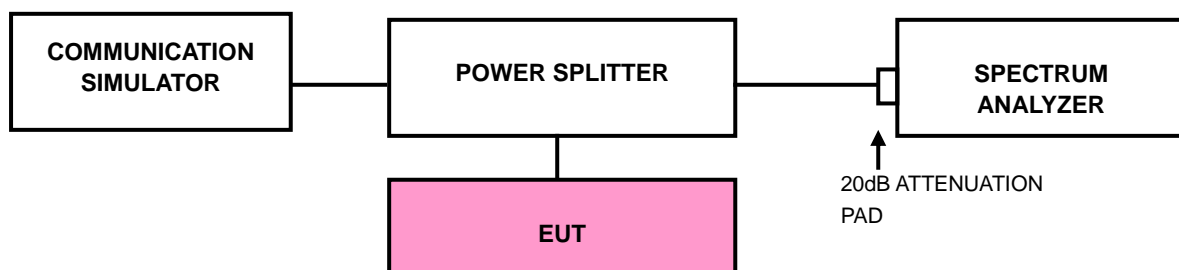

### 4.4.3 TEST PROCEDURES

- All measurements were done at low and high operational frequency range.
- The center frequency of spectrum is the band edge frequency and span is 1MHz. RB of the spectrum is 3.9kHz and VB of the spectrum is 12kHz (GPRS/ EDGE).
- The center frequency of spectrum is the band edge frequency and span is 5MHz. RB of the spectrum is 100kHz and VB of the spectrum is 300kHz (WCDMA).
- The center frequency of spectrum is the band edge frequency and span is 1MHz. RB of the spectrum is 13kHz and VB of the spectrum is 51kHz (LTE Band 5 Bandwidth 1.4MHz / LTE Band 26 Bandwidth 1.4MHz).
- The center frequency of spectrum is the band edge frequency and span is 1MHz. RB of the spectrum is 30kHz and VB of the spectrum is 100kHz (LTE Band 5 Bandwidth 3MHz / LTE Band 26 Bandwidth 3MHz).
- The center frequency of spectrum is the band edge frequency and span is 1MHz. RB of the spectrum is 100kHz and VB of the spectrum is 300kHz (LTE Band 5 Bandwidth 5MHz/10MHz / LTE Band 26 Bandwidth 5MHz/10MHz).
- The center frequency of spectrum is the band edge frequency and span is 1MHz. RB of the spectrum is 150kHz and VB of the spectrum is 470kHz (LTE Band 26 Bandwidth 15MHz).
- Record the max trace plot into the test report.



A D T

### 4.4.4 TEST RESULTS

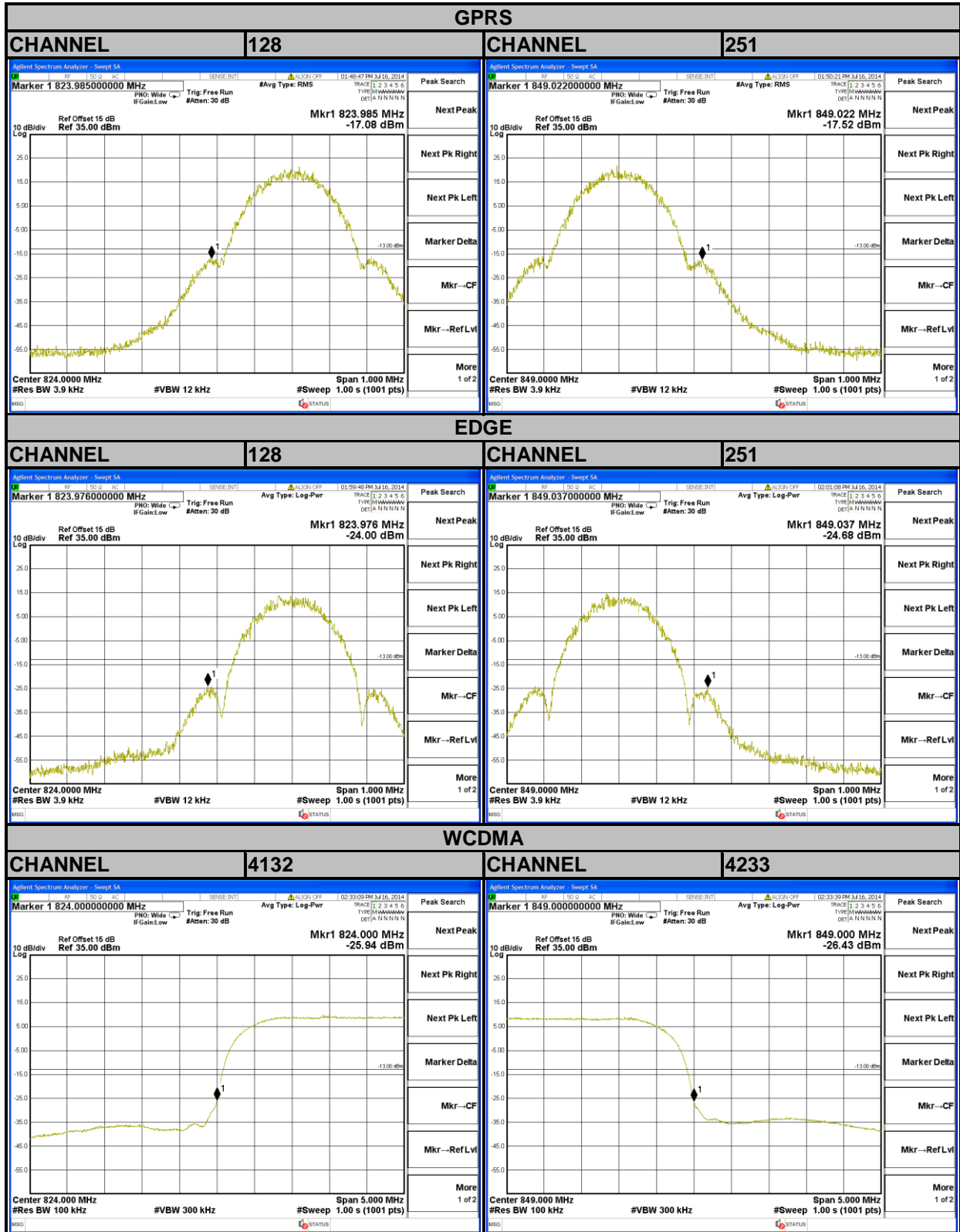



A D T

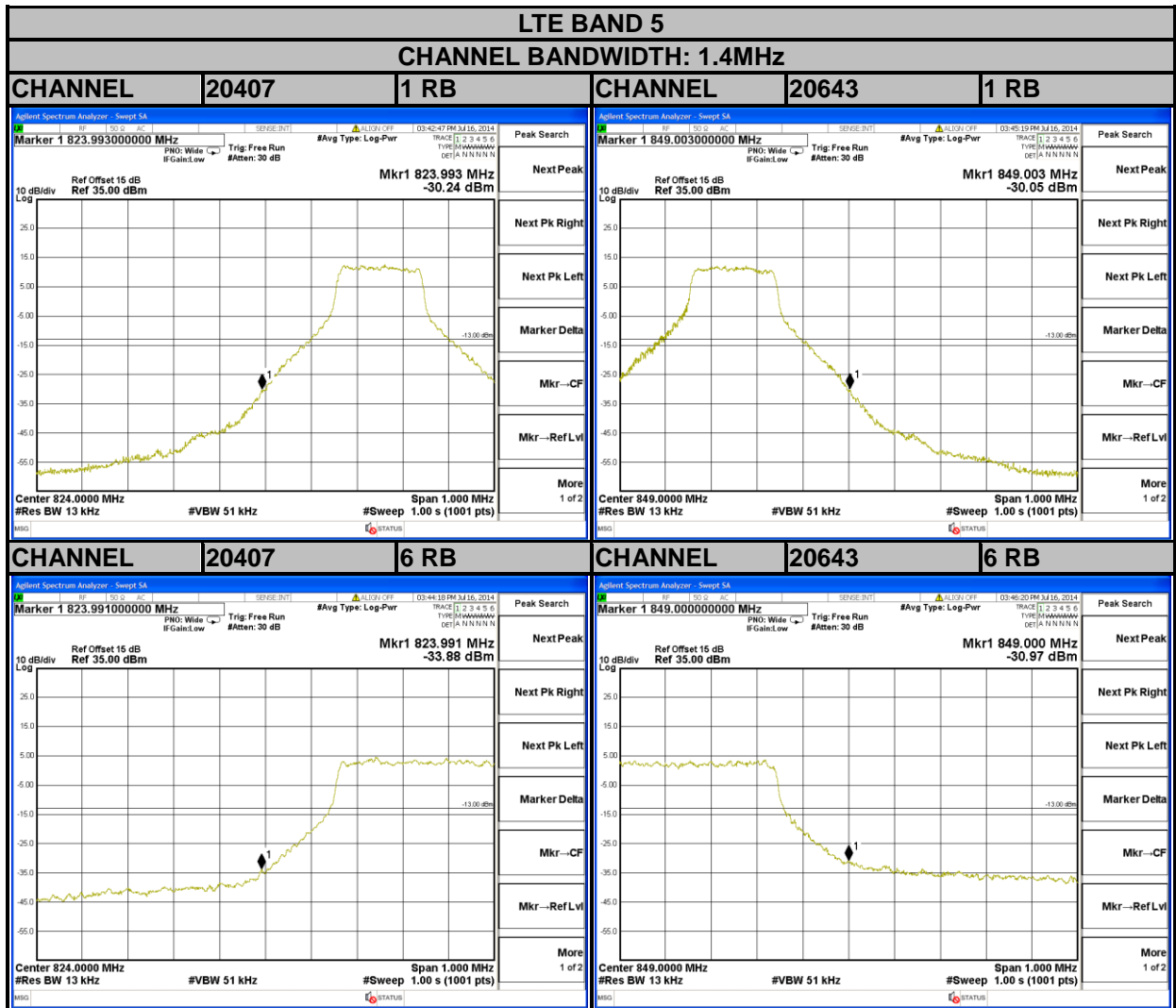



A D T

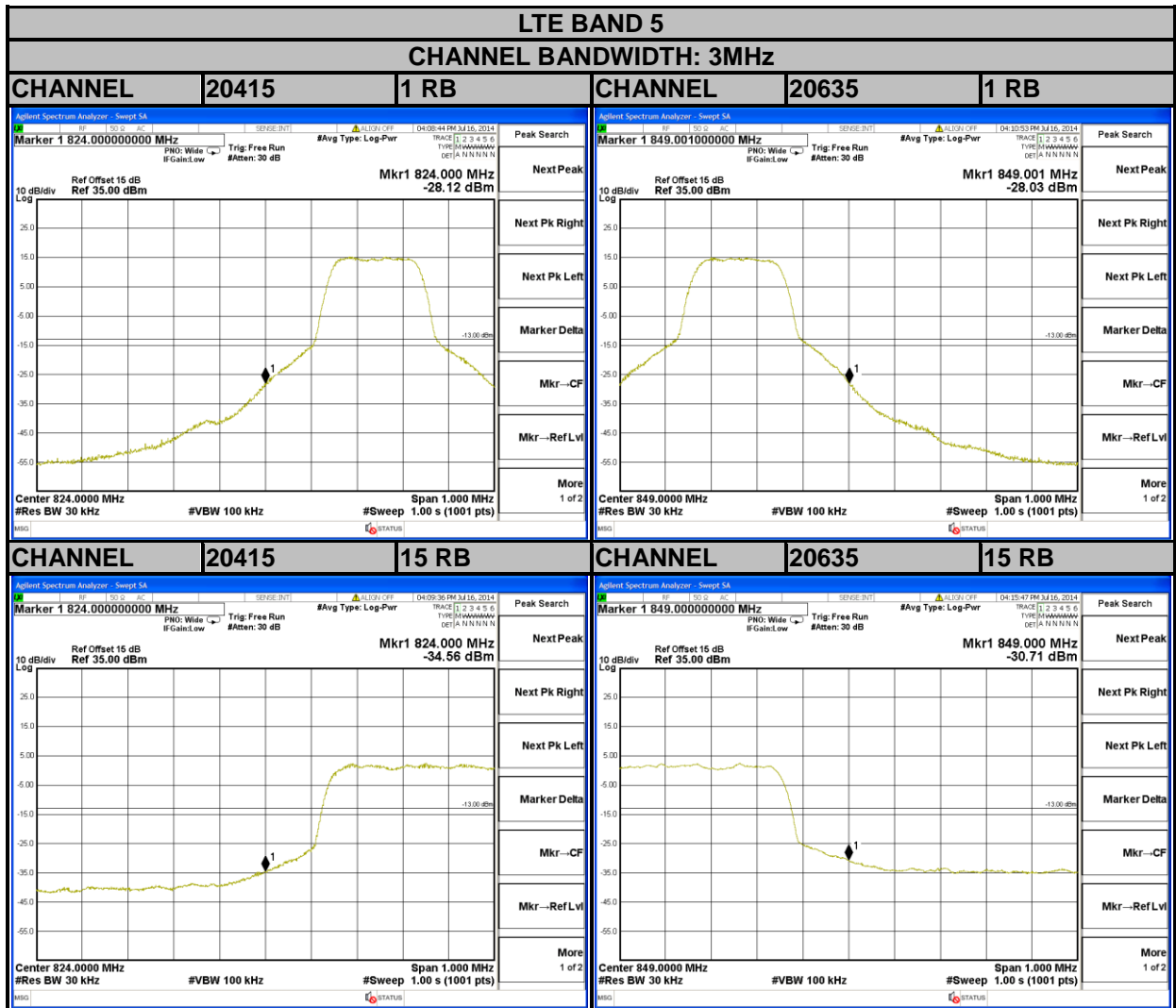



A D T

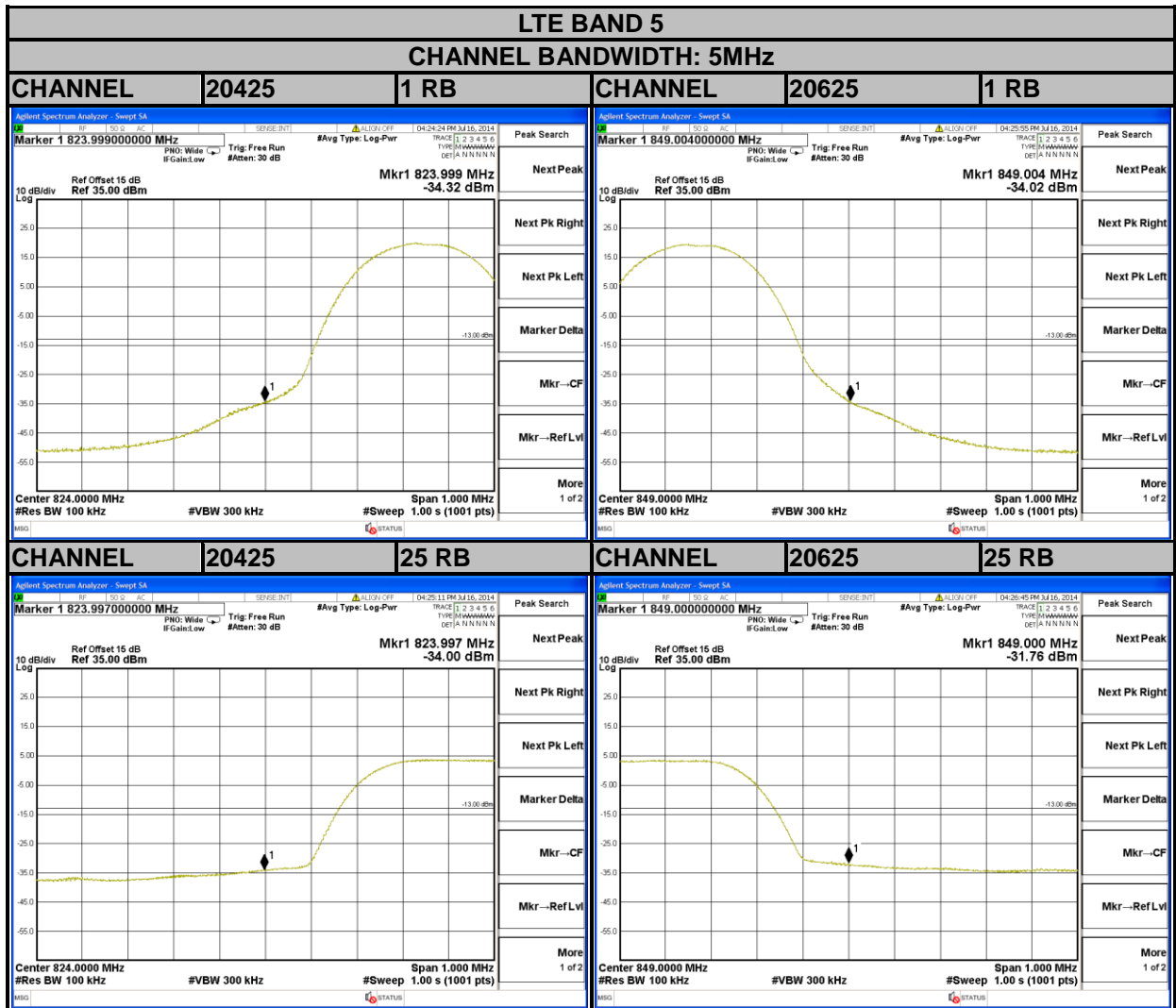



A D T

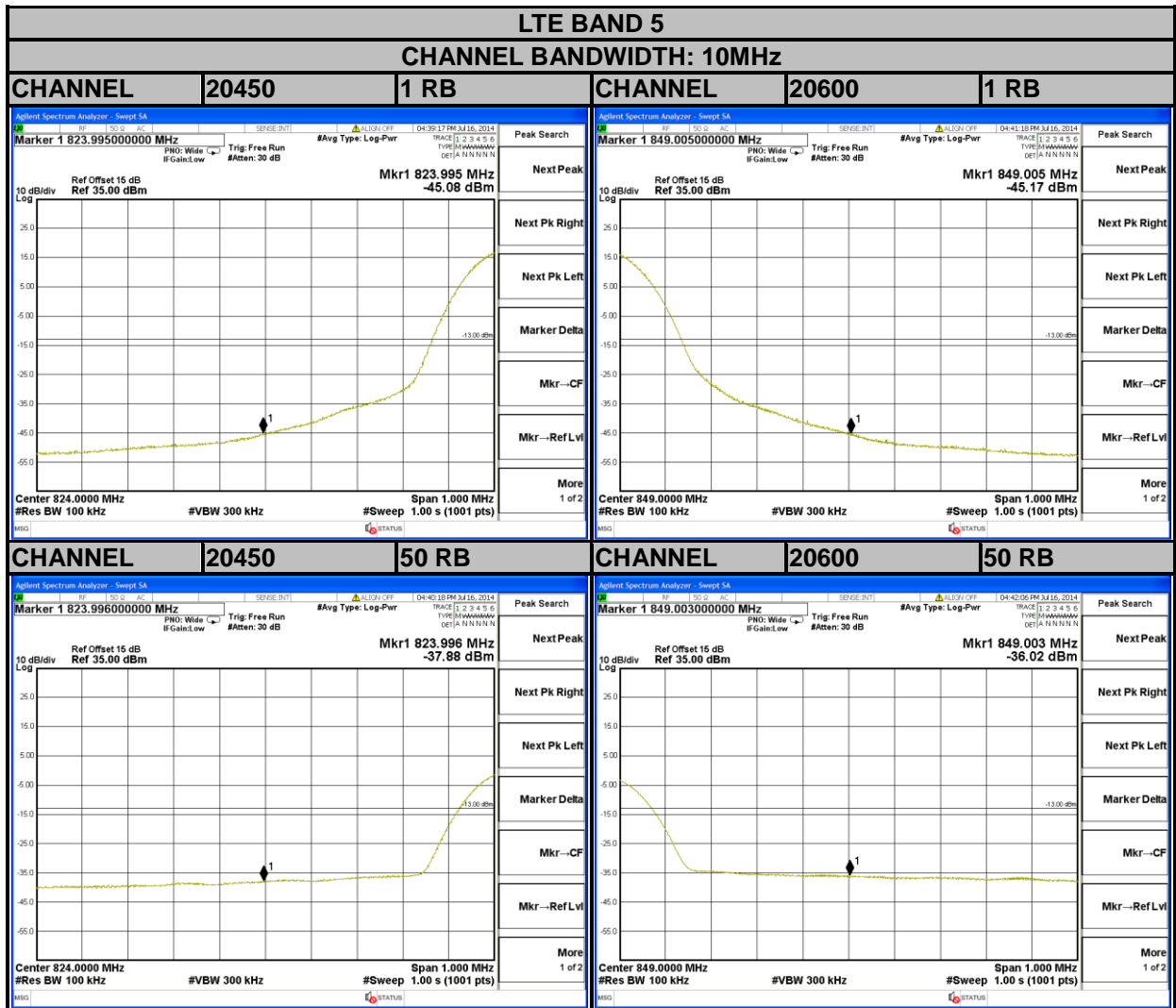





A D T

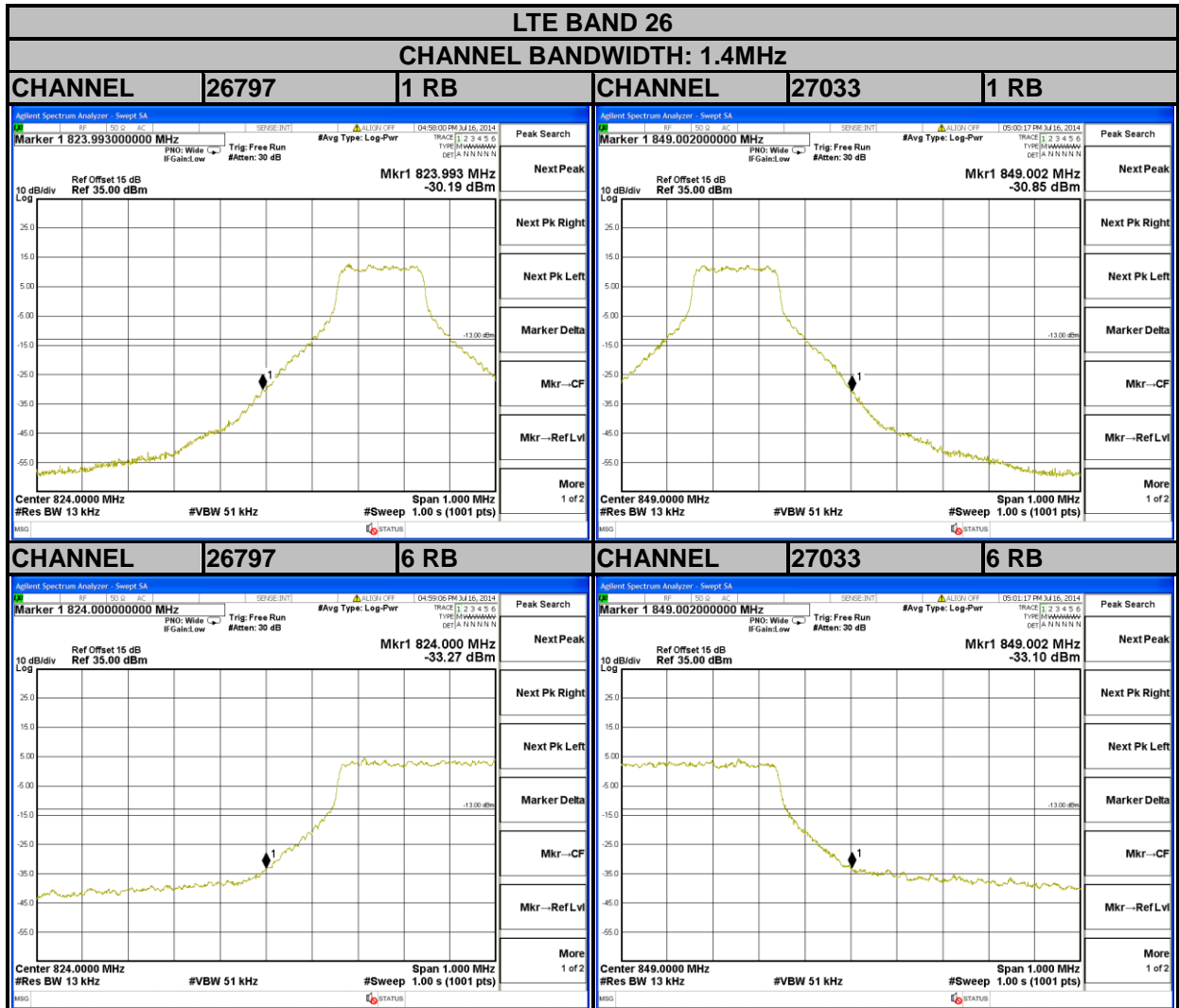



A D T

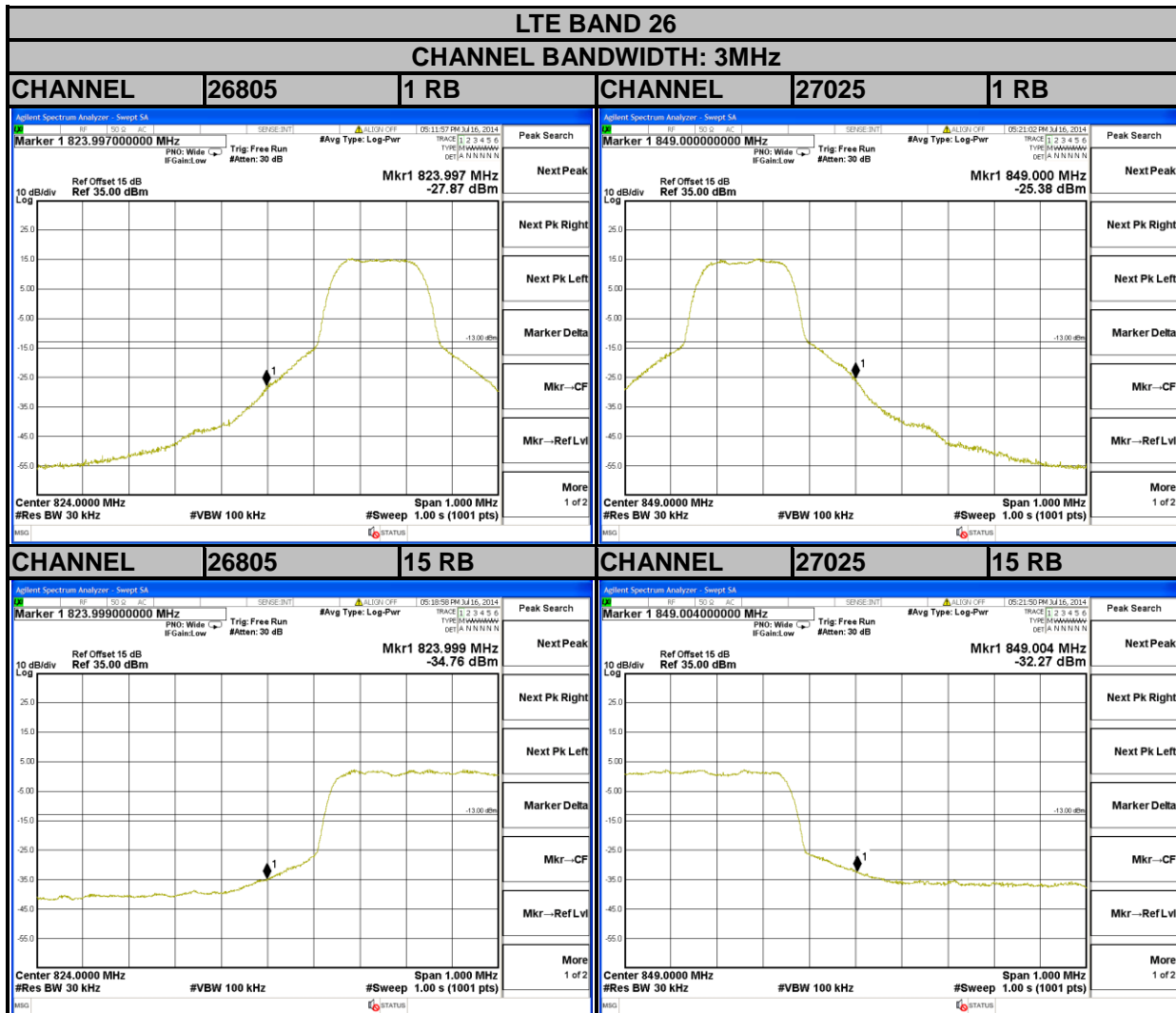



A D T

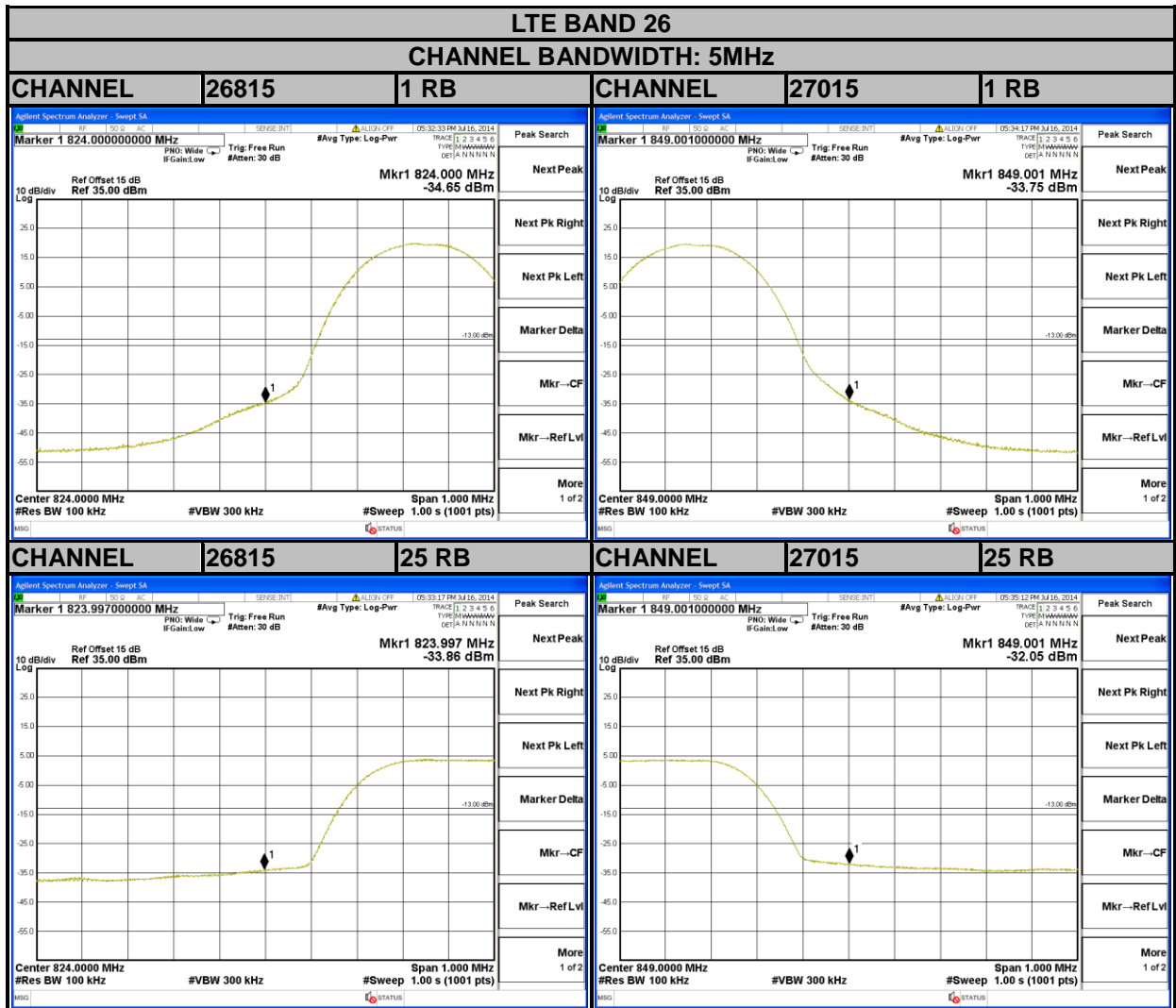



A D T

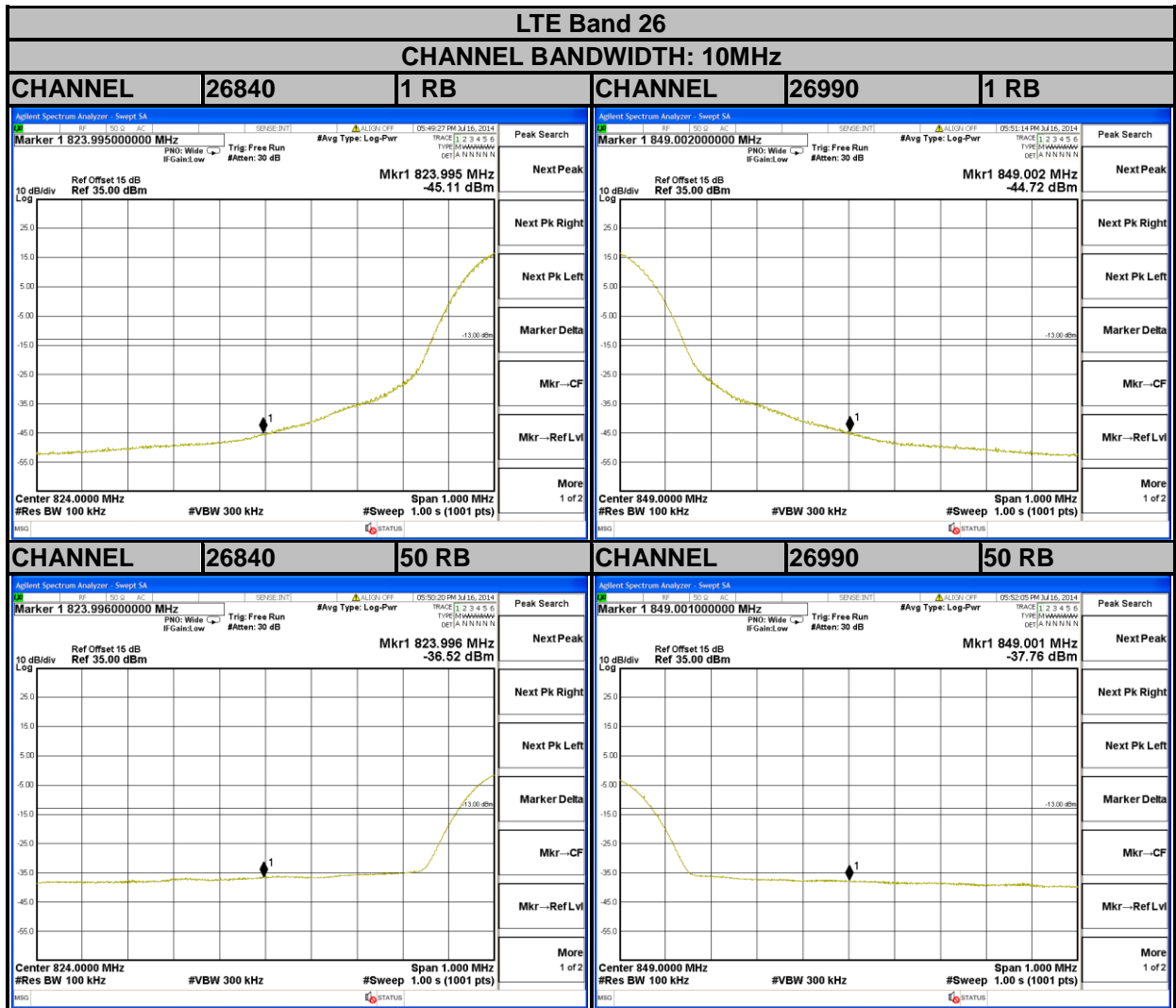



A D T

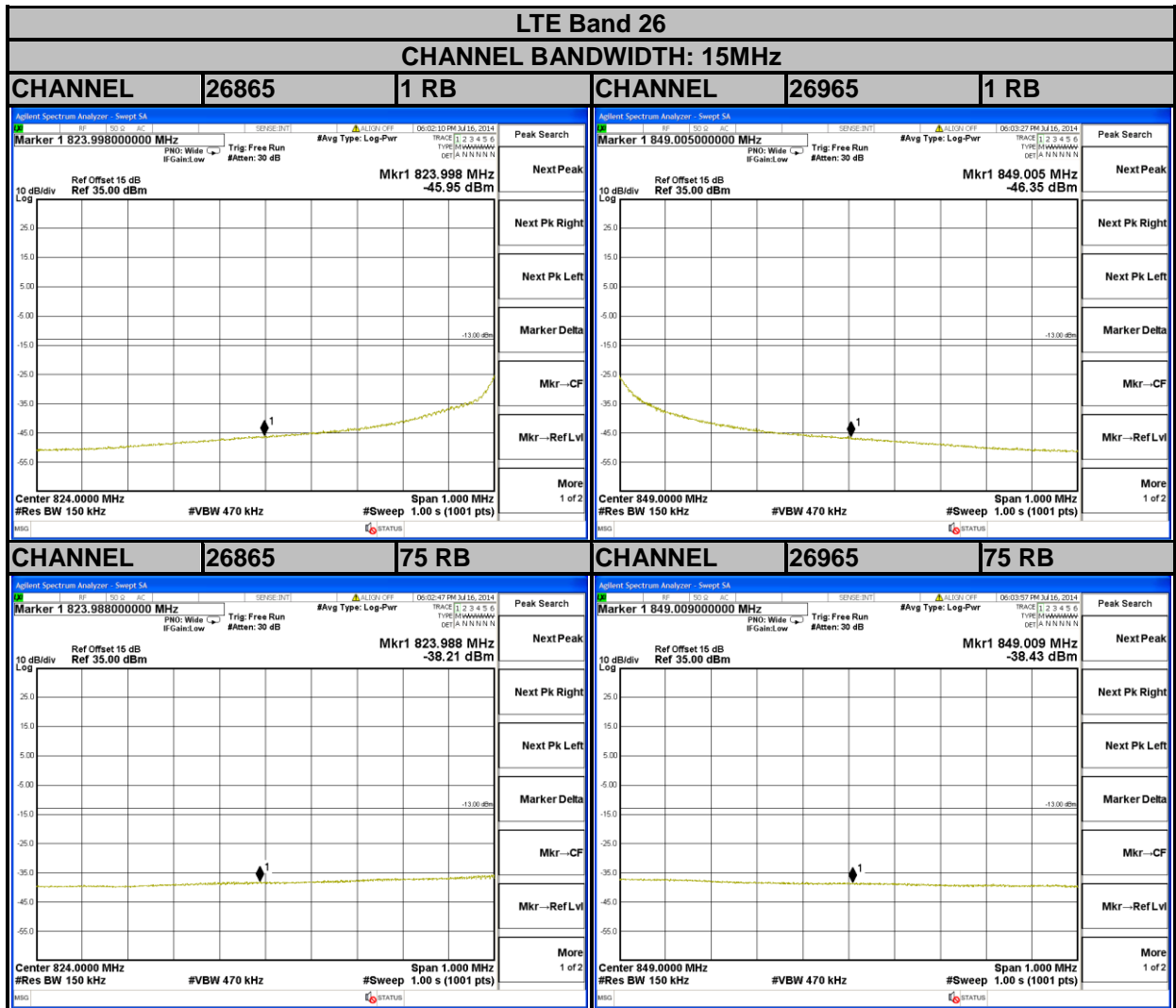

## 4.5 CONDUCTED SPURIOUS EMISSIONS

### 4.5.1 LIMITS OF CONDUCTED SPURIOUS EMISSIONS MEASUREMENT

The power of any emission outside of the authorized operating frequency ranges must be attenuated below the transmitting power (P) by a factor of at least  $43 + 10 \log(P)$  dB. The emission limit is equal to -13dBm.

### 4.5.2 TEST PROCEDURE

- a. The EUT makes a phone call to the communication simulator. All measurements were done at low, middle and high operational frequency range.
- b. Measuring frequency range is from 30 MHz to 9GHz. 10dB attenuation pad is connected with spectrum. RBW=1MHz and VBW=3MHz is used for conducted emission measurement.

### 4.5.3 TEST SETUP

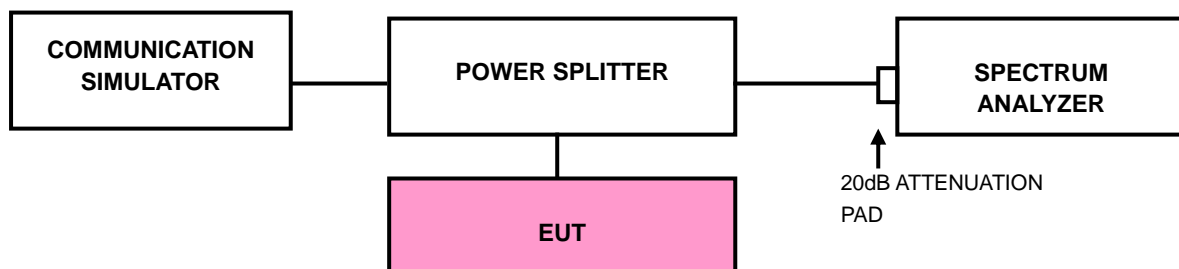



A D T

### 4.5.4 TEST RESULTS

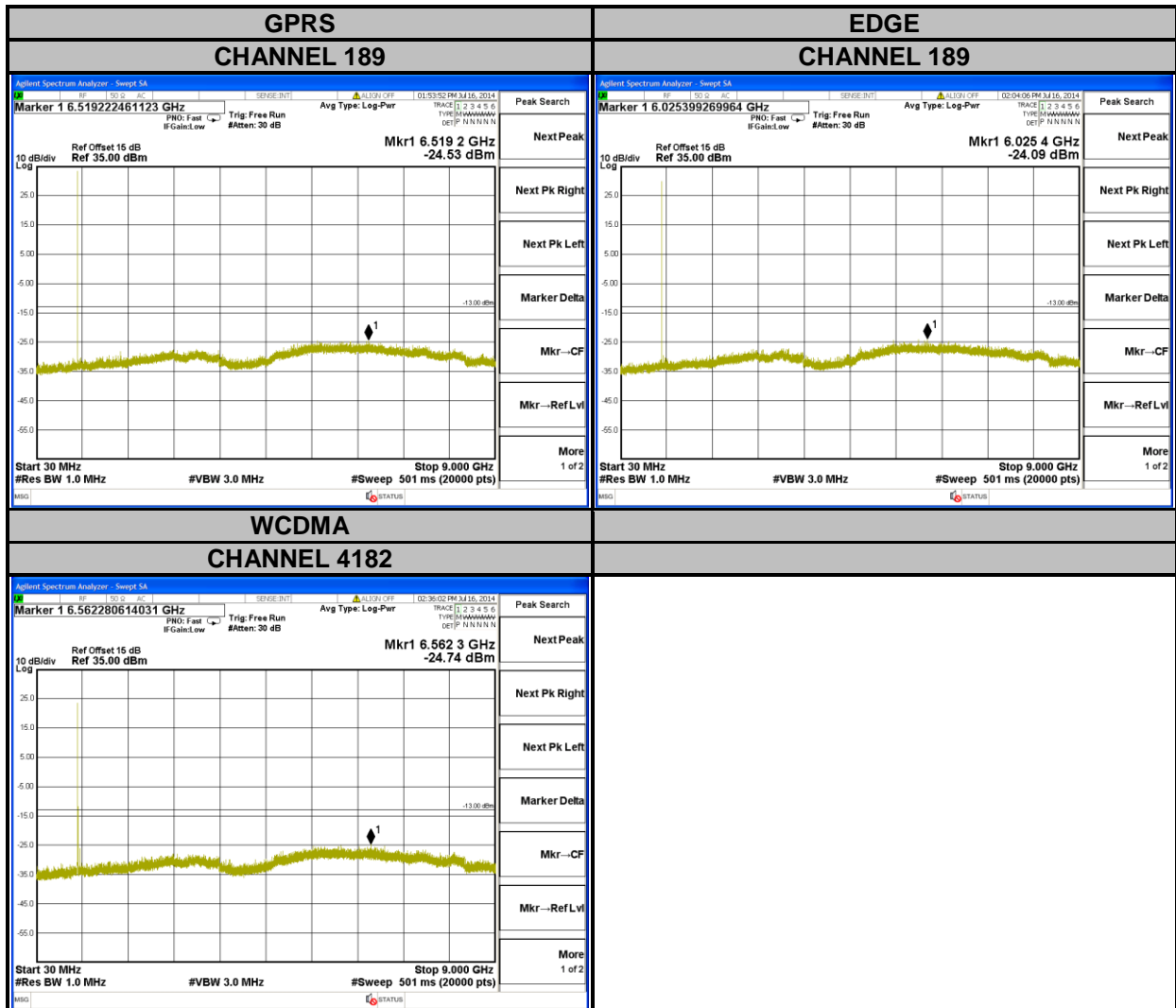



A D T

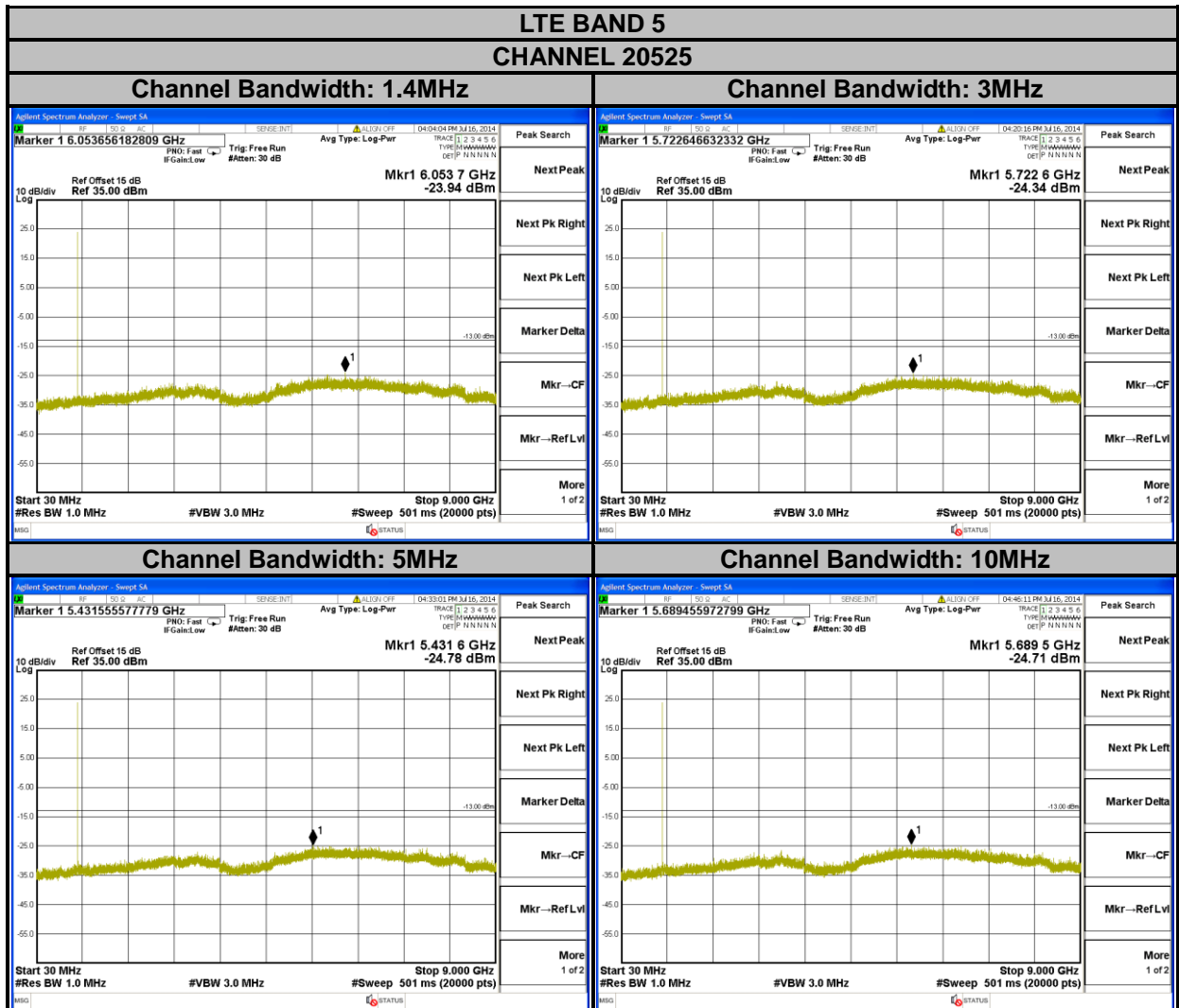





A D T

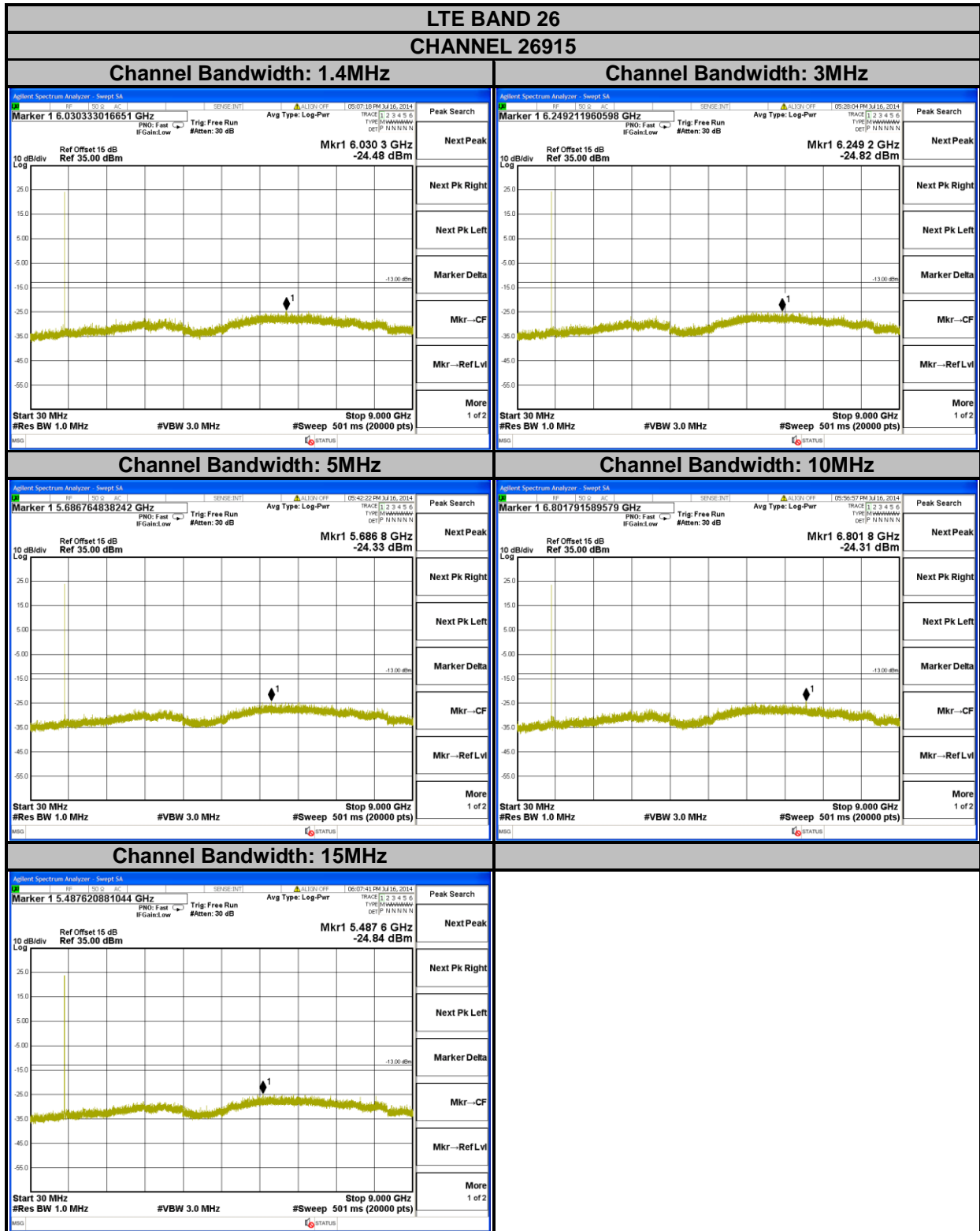

## 4.6 RADIATED EMISSION MEASUREMENT

### 4.6.1 LIMITS OF RADIATED EMISSION MEASUREMENT

The power of any emission outside of the authorized operating frequency ranges must be attenuated below the transmitting power (P) by a factor of at least  $43 + 10 \log(P)$  dB. The emission limit is equal to -13dBm.

### 4.6.2 TEST PROCEDURES

- a. Substitution method is used for E.I.R.P measurement. In the semi-anechoic chamber, EUT placed on the 0.8m height of Turn Table, rotated the table around 360 degrees to search the maximum radiation power and receiver antenna shall be rotated vertical and horizontal polarization and moved height from 1m to 4m to find the maximum polar radiated power. The “Read Value” is the spectrum reading the maximum power value.
- b. The substitution horn antenna is substituted for EUT at the same position and signals generator export the CW signal to the substitution antenna via a TX cable. Rotated the Turn Table and moved receiving antenna to find the maximum radiation power. Adjust output power level of S.G to get a Value of spectrum reading equal to “Read Value” of step a. Record the power level of S.G
- c.  $EIRP = \text{Output power level of S.G} - \text{TX cable loss} + \text{Antenna gain of substitution horn}$ .
- d. E.R.P power can be calculated form E.I.R.P power by subtracting the gain of dipole,  $E.R.P \text{ power} = E.I.R.P \text{ power} - 2.15\text{dBi}$ .

**NOTE:** The resolution bandwidth and video bandwidth of test receiver/spectrum analyzer is 1MHz/3MHz.

### 4.6.3 DEVIATION FROM TEST STANDARD

No deviation

#### 4.6.4 TEST SETUP

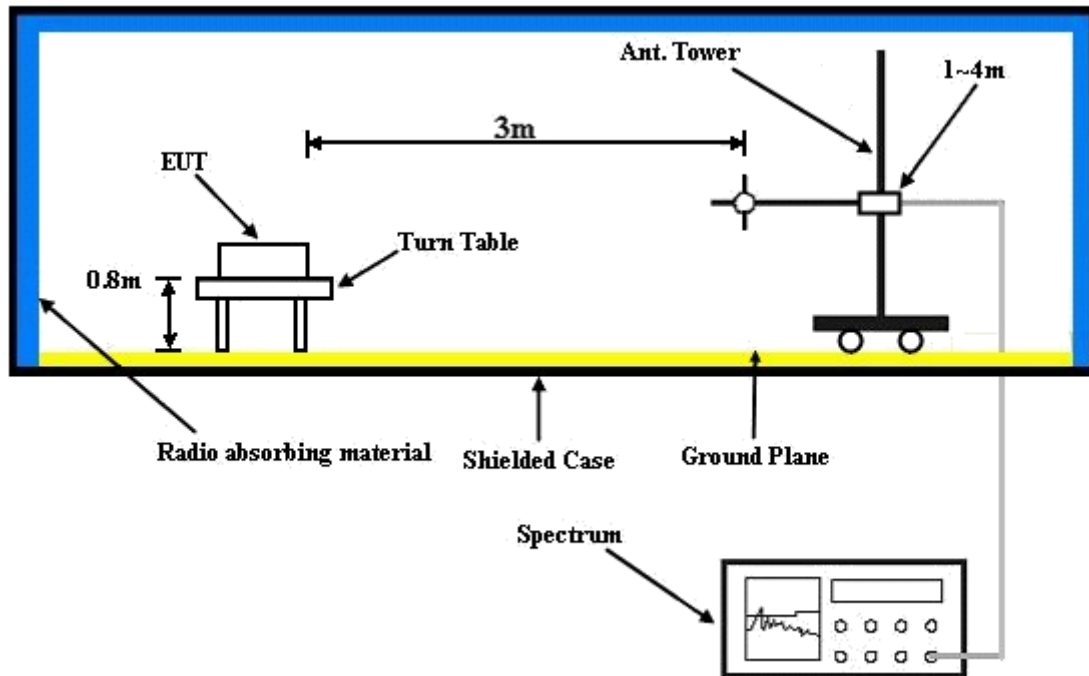

For the actual test configuration, please refer to the attached file (Test Setup Photo).

### 4.6.5 TEST RESULTS

MODE A

GPRS:



Bureau Veritas Consumer Products Services Ltd., Taoyuan Branch

A D T

Data: 9

Date: 2014-07-26

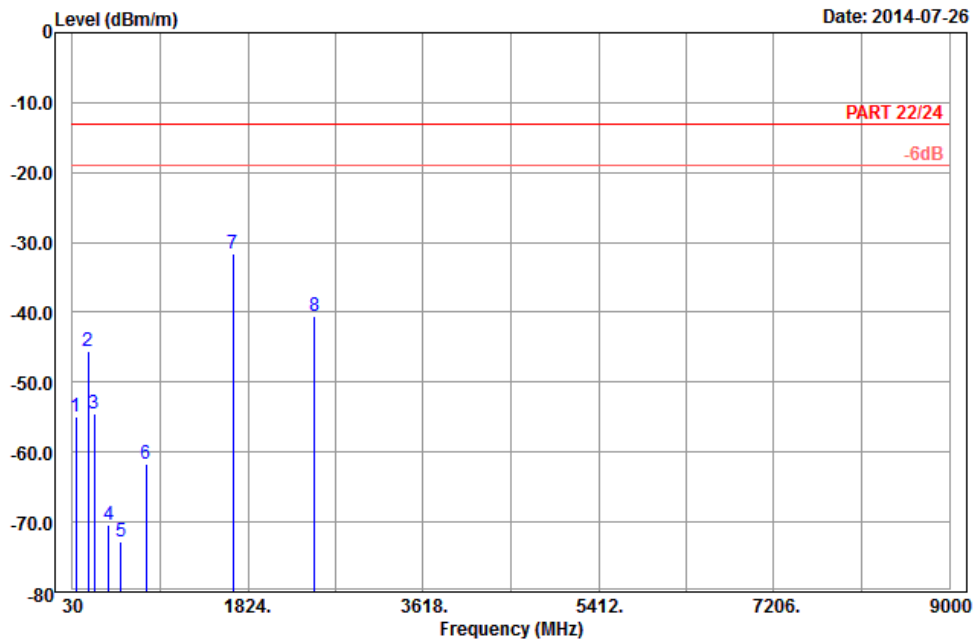

Site : 966 chamber 5  
 Condition: PART 22/24 3m Horizontal  
 Remark : GPRS 850\_Link\_CH189  
 Tested by: Will Chen  
 Plane : Y  
 Ant : Aux

	Freq	Level	Read Level	Limit Line	Over Limit	Factor	Remark
	MHz	dBm/m	dBm	dBm/m	dB	dB/m	
1	68.34	-54.99	-42.17	-13.00	-41.99	-12.82	Peak
2	187.41	-45.51	-39.82	-13.00	-32.51	-5.69	Peak
3	255.45	-54.47	-48.92	-13.00	-41.47	-5.55	Peak
4	398.70	-70.33	-67.54	-13.00	-57.33	-2.79	Peak
5	523.30	-72.73	-69.15	-13.00	-59.73	-3.58	Peak
6	785.10	-61.62	-62.61	-13.00	-48.62	0.99	Peak
7 pp	1672.80	-31.55	-39.46	-13.00	-18.55	7.91	Peak
8	2509.20	-40.48	-51.76	-13.00	-27.48	11.28	Peak



A D T



Bureau Veritas Consumer Products Services Ltd., Taoyuan Branch

A D T

Data: 10

Date: 2014-07-26

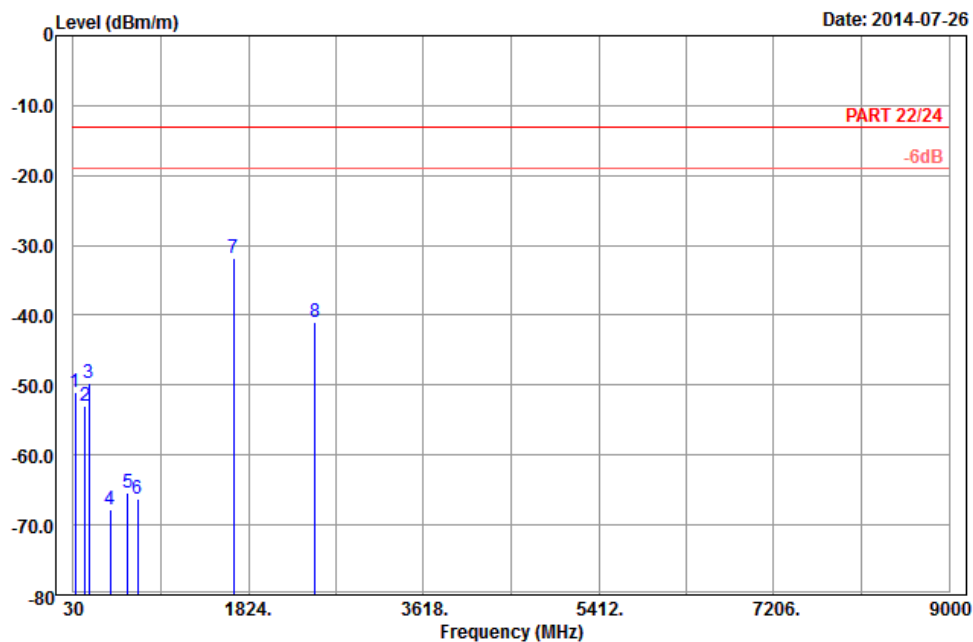

Site : 966 chamber 5  
 Condition: PART 22/24 3m Vertical  
 Remark : GPRS 850\_Link\_CH189  
 Tested by: Will Chen  
 Plane : Y  
 Ant : Aux

	Read	Limit	Over				
Freq	Level	Level	Line	Limit	Factor	Remark	
MHz	dBm/m	dBm	dBm/m	dB	dB/m		
1	47.01	-51.06	-37.95	-13.00	-38.06	-13.11	Peak
2	147.72	-52.99	-45.11	-13.00	-39.99	-7.88	Peak
3	192.27	-49.63	-43.81	-13.00	-36.63	-5.82	Peak
4	407.10	-67.88	-64.97	-13.00	-54.88	-2.91	Peak
5	588.40	-65.50	-65.45	-13.00	-52.50	-0.05	Peak
6	692.00	-66.30	-65.96	-13.00	-53.30	-0.34	Peak
7 pp	1672.80	-31.74	-39.65	-13.00	-18.74	7.91	Peak
8	2509.20	-41.01	-52.29	-13.00	-28.01	11.28	Peak



A D T

EDGE:



Bureau Veritas Consumer Products Services Ltd., Taoyuan Branch

A D T

Data: 5

Date: 2014-07-26

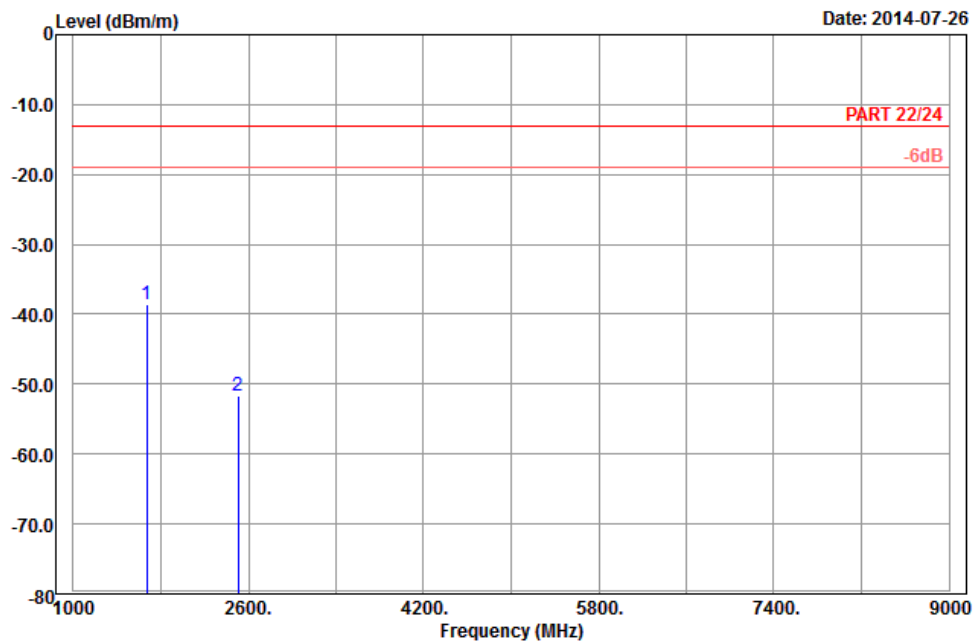

Site : 966 chamber 5  
 Condition: PART 22/24 3m Horizontal  
 Remark : EDGE 850\_Link\_CH189  
 Tested by: Will Chen  
 Plane : Y  
 Ant : Aux

	Read	Limit	Over			
Freq	Level	Level	Line	Limit	Factor	Remark
MHz	dBm/m	dBm	dBm/m	dB	dB/m	
1 pp	1672.80	-38.51	-46.42	-13.00	-25.51	7.91 Peak
2	2509.20	-51.68	-62.96	-13.00	-38.68	11.28 Peak



Data: 6

Date: 2014-07-26

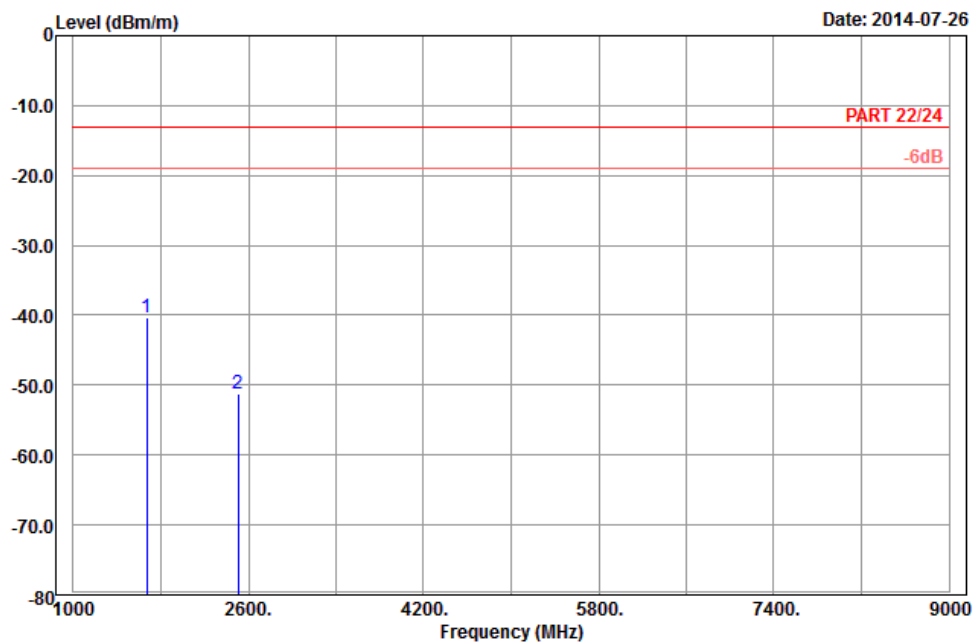

Site : 966 chamber 5  
 Condition: PART 22/24 3m Vertical  
 Remark : EDGE 850\_Link\_CH189  
 Tested by: Will Chen  
 Plane : Y  
 Ant : Aux

	Read	Limit	Over			
Freq	Level	Level	Line	Limit	Factor	Remark
MHz	dBm/m	dBm	dBm/m	dB	dB/m	
1 pp	1672.80	-40.22	-48.13	-13.00	-27.22	7.91 Peak
2	2509.20	-51.26	-62.54	-13.00	-38.26	11.28 Peak

WCDMA:



Bureau Veritas Consumer Products Services Ltd., Taoyuan Branch

A D T

Data: 5

Date: 2014-07-26

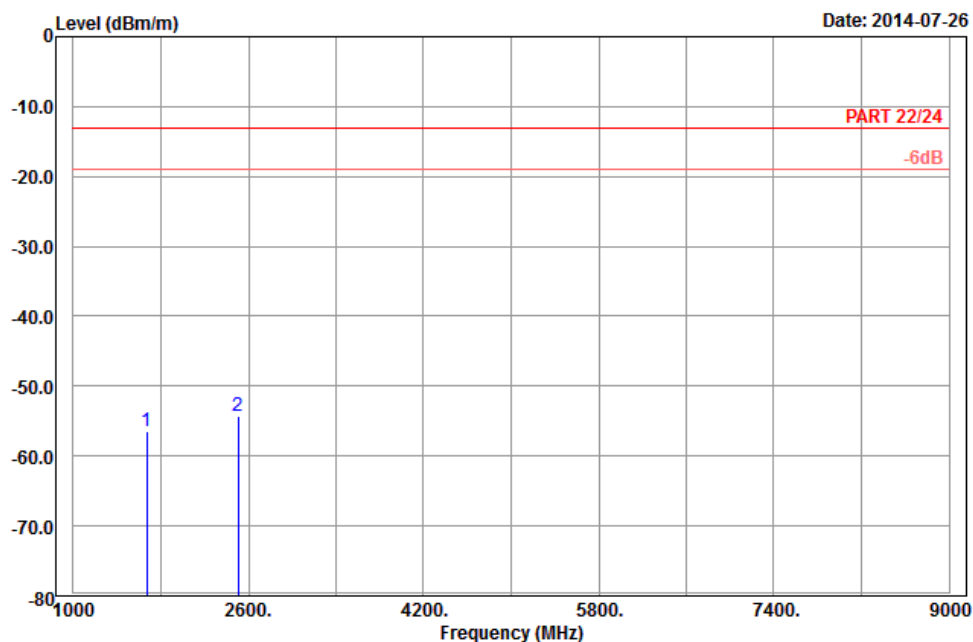

Site : 966 chamber 5  
 Condition: PART 22/24 3m Horizontal  
 Remark : Band V\_Link\_CH4182  
 Tested by: Will Chen  
 Plane : Y  
 Ant : Aux

	Freq	Level	Read Level	Limit Line	Over Limit	Factor	Remark
	MHz	dBm/m	dBm	dBm/m	dB	dB/m	
1	1672.80	-56.36	-64.27	-13.00	-43.36	7.91	Peak
2 pp	2509.20	-54.34	-65.62	-13.00	-41.34	11.28	Peak





A D T

Data: 6

Date: 2014-07-26

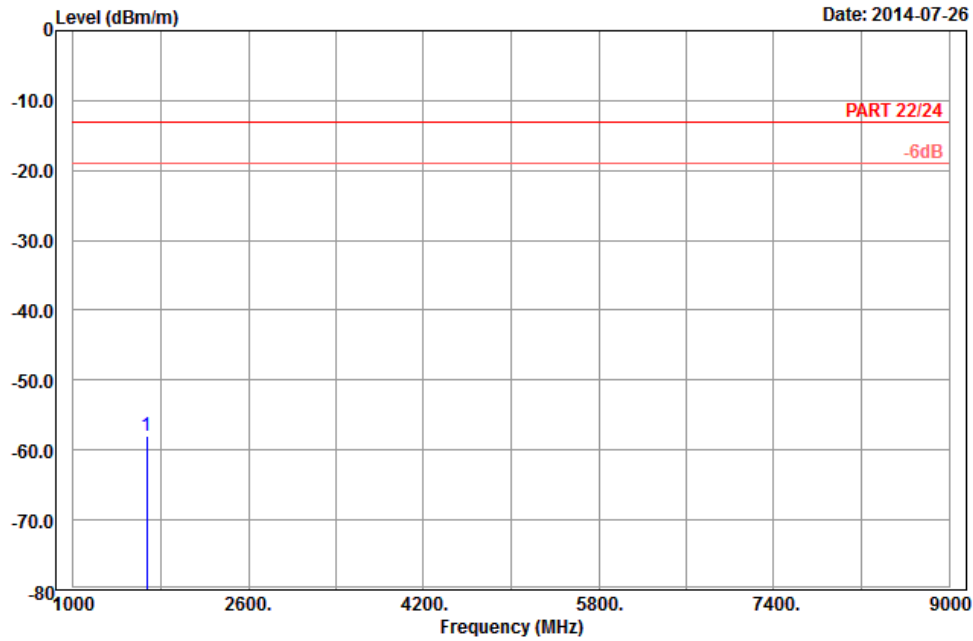

Site : 966 chamber 5  
 Condition: PART 22/24 3m Vertical  
 Remark : Band V\_Link\_CH4182  
 Tested by: Will Chen  
 Plane : Y  
 Ant : Aux

	Read	Limit	Over		
Freq	Level	Level	Line	Limit	Factor Remark
MHz	dBm/m	dBm	dBm/m	dB	dB/m
1 pp 1672.80	-57.91	-65.82	-13.00	-44.91	7.91 Peak

**LTE BAND 5**  
**CHANNEL BANDWIDTH: 10MHz / QPSK**



Bureau Veritas Consumer Products Services Ltd., Taoyuan Branch

A D T

Data: 9

Date: 2014-07-29

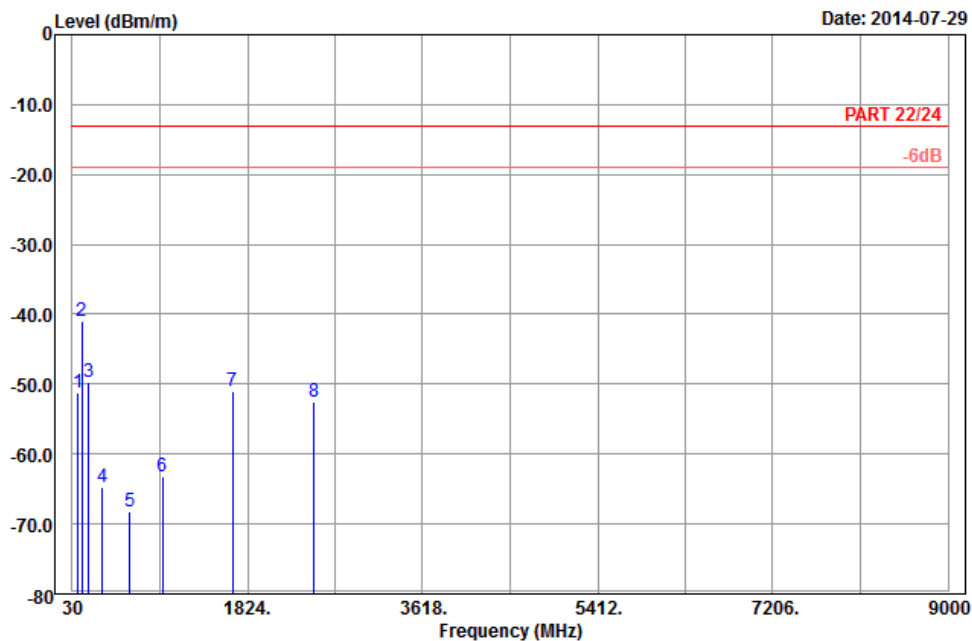

Site : 966 chamber 5  
 Condition: PART 22/24 3m Horizontal  
 Remark : LTE\_Band 5\_QPSK(1,0)\_10M\_CH20525  
 Tested by: Harry Hsueh  
 Plane : Y  
 ANT : Aux

	Freq	Level	Read Level	Limit	Over	Factor	Remark
	MHz	dBm/m	dBm	dBm/m	dB	dB/m	
1	91.83	-51.14	-40.58	-13.00	-38.14	-10.56	Peak
2	pp 125.04	-40.91	-32.96	-13.00	-27.91	-7.95	Peak
3	196.05	-49.60	-43.60	-13.00	-36.60	-6.00	Peak
4	337.80	-64.66	-59.14	-13.00	-51.66	-5.52	Peak
5	619.20	-68.29	-68.51	-13.00	-55.29	0.22	Peak
6	957.30	-63.25	-68.38	-13.00	-50.25	5.13	Peak
7	1673.00	-50.99	-58.90	-13.00	-37.99	7.91	Peak
8	2509.50	-52.63	-63.91	-13.00	-39.63	11.28	Peak



A D T



Bureau Veritas Consumer Products Services Ltd., Taoyuan Branch

A D T

Data: 10

Date: 2014-07-29

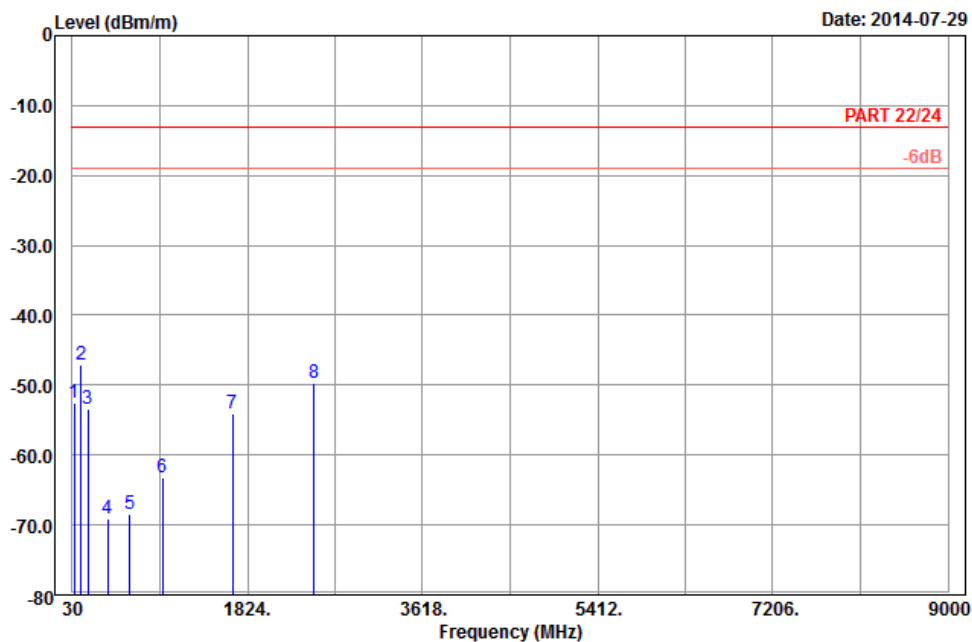

Site : 966 chamber 5  
 Condition: PART 22/24 3m Vertical  
 Remark : LTE\_Band 5\_QPSK(1,0)\_10M\_CH20525  
 Tested by: Harry Hsueh  
 Plane : Y  
 ANT : Aux

	Read	Limit	Over			
Freq	Level	Level	Line	Limit	Factor	Remark
MHz	dBm/m	dBm	dBm/m	dB	dB/m	
1	47.82	-52.49	-39.38	-13.00	-39.49	-13.11 Peak
2	pp 123.42	-47.03	-38.96	-13.00	-34.03	-8.07 Peak
3	193.35	-53.33	-47.46	-13.00	-40.33	-5.87 Peak
4	394.50	-69.06	-66.06	-13.00	-56.06	-3.00 Peak
5	621.30	-68.36	-68.54	-13.00	-55.36	0.18 Peak
6	957.30	-63.22	-68.35	-13.00	-50.22	5.13 Peak
7	1673.00	-54.13	-62.04	-13.00	-41.13	7.91 Peak
8	2509.50	-49.60	-60.88	-13.00	-36.60	11.28 Peak

**LTE BAND 26**  
**CHANNEL BANDWIDTH: 15MHz / QPSK**



Bureau Veritas Consumer Products Services Ltd., Taoyuan Branch

A D T

Data: 9

Date: 2014-07-30

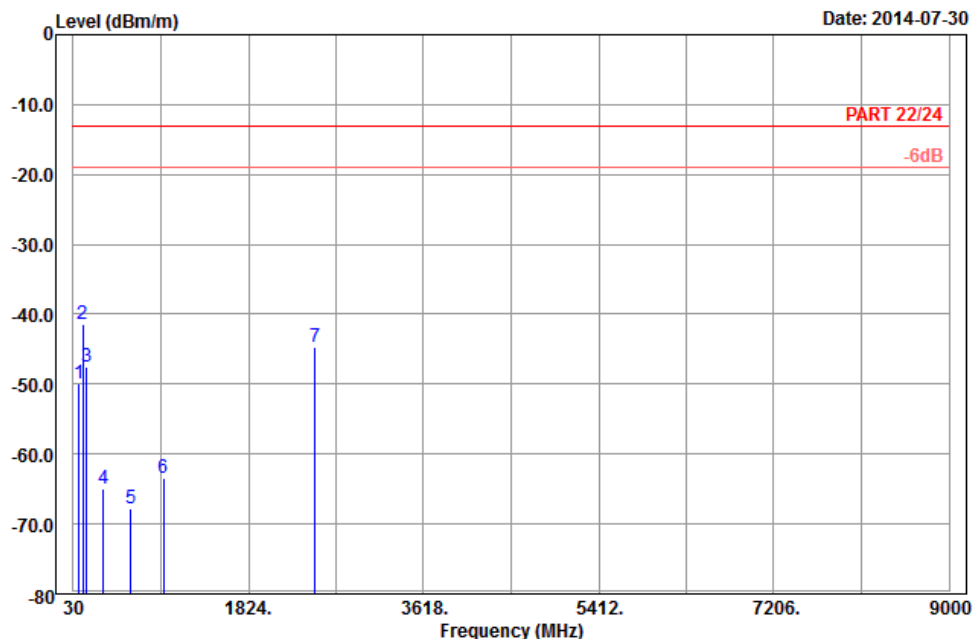

Site : 966 chamber 5  
 Condition: PART 22/24 3m Horizontal  
 Remark : LTE\_Band 26\_QPSK(1,0)\_15M\_CH26915  
 Tested by: Harry Hsueh  
 Plane : Z  
 ANT : Aux

	Freq	Level	Read Level	Limit Line	Over Limit	Factor	Remark
	MHz	dBm/m	dBm	dBm/m	dB	dB/m	
1	90.48	-50.03	-39.36	-13.00	-37.03	-10.67	Peak
2	pp 125.58	-41.46	-33.57	-13.00	-28.46	-7.89	Peak
3	165.81	-47.61	-40.52	-13.00	-34.61	-7.09	Peak
4	341.30	-64.98	-59.50	-13.00	-51.98	-5.48	Peak
5	620.60	-67.77	-67.97	-13.00	-54.77	0.20	Peak
6	951.00	-63.47	-68.58	-13.00	-50.47	5.11	Peak
7	2509.50	-44.71	-55.99	-13.00	-31.71	11.28	Peak



A D T



Bureau Veritas Consumer Products Services Ltd., Taoyuan Branch

A D T

Data: 10

Date: 2014-07-30

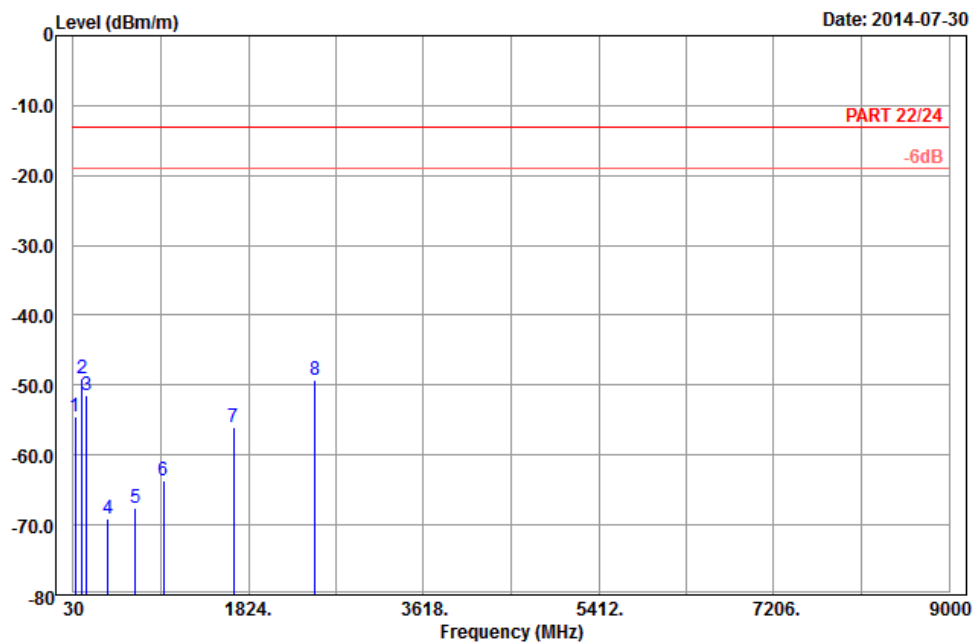

Site : 966 chamber 5  
 Condition: PART 22/24 3m Vertical  
 Remark : LTE\_Band 26\_QPSK(1,0)\_15M\_CH26915  
 Tested by: Harry Hsueh  
 Plane : Z  
 ANT : Aux

	Read	Limit	Over			
Freq	Level	Level	Line	Limit	Factor	Remark
MHz	dBm/m	dBm	dBm/m	dB	dB/m	
1	48.09	-54.58	-41.15	-13.00	-41.58	-13.43 Peak
2	123.15	-49.11	-41.04	-13.00	-36.11	-8.07 Peak
3	165.27	-51.49	-44.30	-13.00	-38.49	-7.19 Peak
4	388.20	-69.02	-65.66	-13.00	-56.02	-3.36 Peak
5	664.70	-67.55	-67.35	-13.00	-54.55	-0.20 Peak
6	956.60	-63.58	-68.71	-13.00	-50.58	5.13 Peak
7	1673.00	-56.13	-64.04	-13.00	-43.13	7.91 Peak
8	2509.50	-49.26	-60.54	-13.00	-36.26	11.28 Peak



A D T

MODE B

GPRS:



Bureau Veritas Consumer Products Services Ltd., Taoyuan Branch

A D T

Data: 9

Date: 2014-08-07

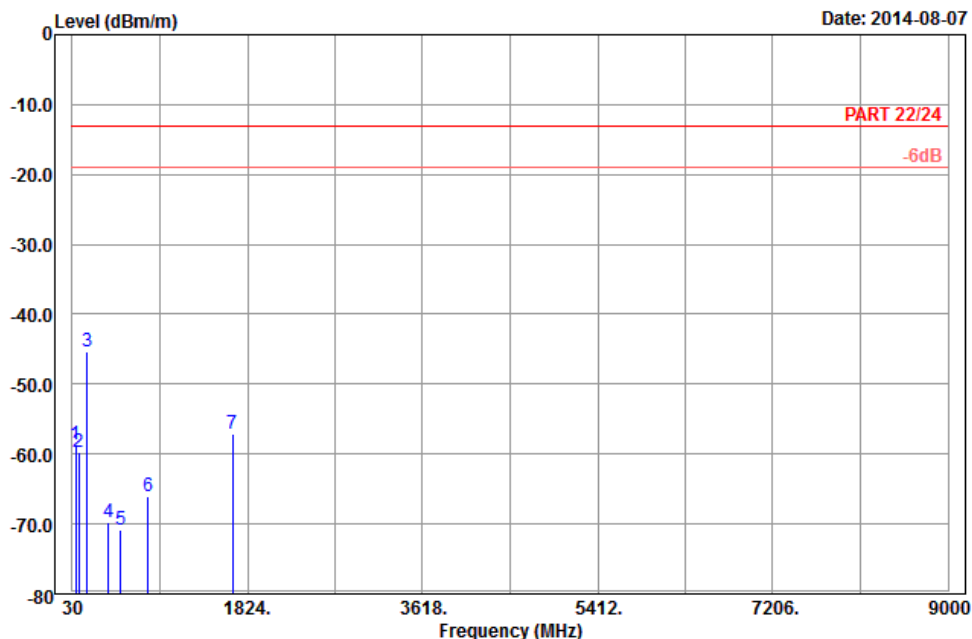

Site : 966 chamber 5  
 Condition: PART 22/24 3m Horizontal  
 Remark : GPRS 850\_Link\_CH189  
 Tested by: Will Chen  
 Plane : Z  
 Ant : Aux

	Freq	Level	Read Level	Limit Line	Over Limit	Factor	Remark
	MHz	dBm/m	dBm	dBm/m	dB	dB/m	
1	66.99	-58.62	-45.52	-13.00	-45.62	-13.10	Peak
2	92.64	-59.67	-49.16	-13.00	-46.67	-10.51	Peak
3 pp	182.28	-45.38	-39.77	-13.00	-32.38	-5.61	Peak
4	397.30	-69.70	-66.86	-13.00	-56.70	-2.84	Peak
5	528.90	-70.80	-67.58	-13.00	-57.80	-3.22	Peak
6	802.60	-65.95	-67.94	-13.00	-52.95	1.99	Peak
7	1672.80	-57.22	-65.13	-13.00	-44.22	7.91	Peak



A D T



Bureau Veritas Consumer Products Services Ltd., Taoyuan Branch

A D T

Data: 10

Date: 2014-08-07

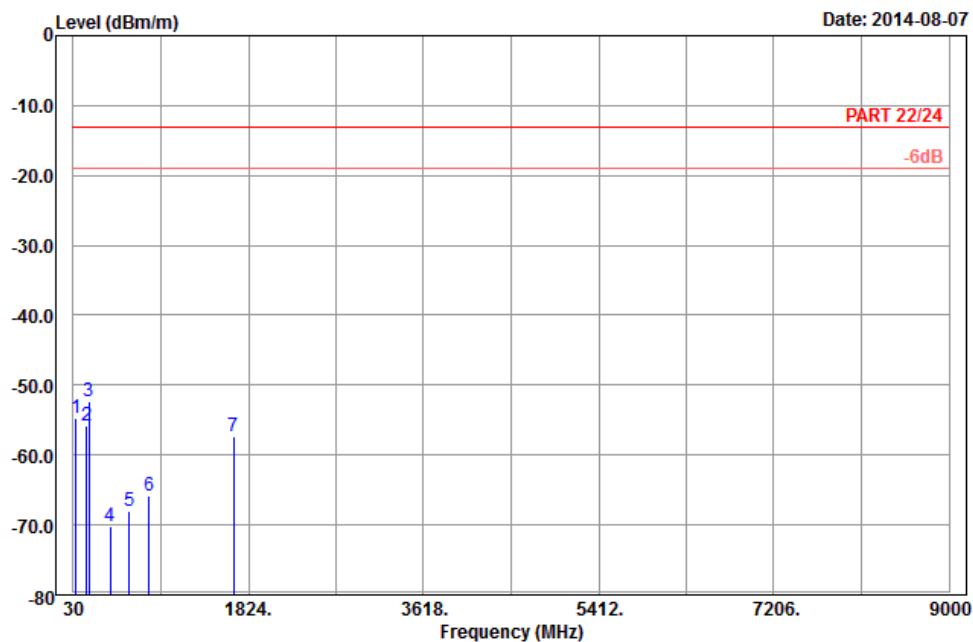

Site : 966 chamber 5  
 Condition: PART 22/24 3m Vertical  
 Remark : GPRS 850\_Link\_CH189  
 Tested by: Will Chen  
 Plane : Z  
 Ant : Aux

	Read	Limit	Over				
Freq	Level	Level	Line	Limit	Factor	Remark	
MHz	dBm/m	dBm	dBm/m	dB	dB/m		
1	55.11	-54.81	-40.75	-13.00	-41.81	-14.06	Peak
2	167.70	-55.73	-48.83	-13.00	-42.73	-6.90	Peak
3 pp	187.95	-52.25	-46.55	-13.00	-39.25	-5.70	Peak
4	406.40	-70.14	-67.25	-13.00	-57.14	-2.89	Peak
5	601.00	-68.09	-68.51	-13.00	-55.09	0.42	Peak
6	807.50	-65.73	-67.65	-13.00	-52.73	1.92	Peak
7	1672.80	-57.31	-65.22	-13.00	-44.31	7.91	Peak

**LTE BAND 5**  
**CHANNEL BANDWIDTH: 10MHz / QPSK**



Bureau Veritas Consumer Products Services Ltd., Taoyuan Branch

A D T

Data: 9

Date: 2014-08-10

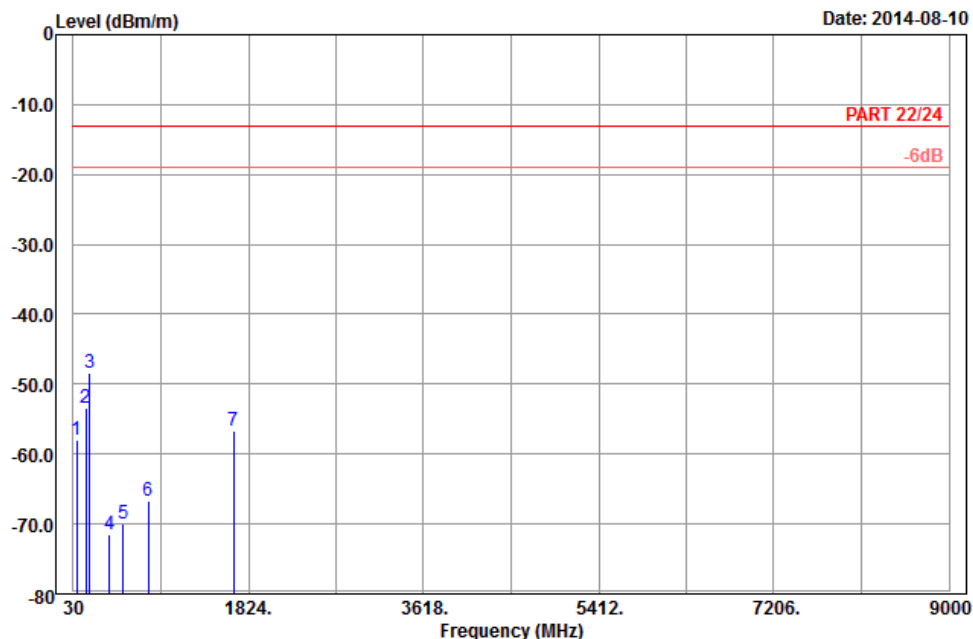

Site : 966 chamber 5  
 Condition: PART 22/24 3m Horizontal  
 Remark : LTE\_Band 5\_QPSK(1,0)\_10M\_CH20525  
 Tested by: Harry Hsueh  
 Plane : Z  
 ANT : Aux

	Freq	Level	Read Level	Limit Line	Over Limit	Factor	Remark
	MHz	dBm/m	dBm	dBm/m	dB	dB/m	
1	66.99	-58.09	-44.99	-13.00	-45.09	-13.10	Peak
2	160.14	-53.31	-45.64	-13.00	-40.31	-7.67	Peak
3 pp	195.51	-48.39	-42.39	-13.00	-35.39	-6.00	Peak
4	398.00	-71.39	-68.55	-13.00	-58.39	-2.84	Peak
5	541.50	-70.02	-67.72	-13.00	-57.02	-2.30	Peak
6	799.80	-66.80	-68.81	-13.00	-53.80	2.01	Peak
7	1673.00	-56.74	-64.65	-13.00	-43.74	7.91	Peak





A D T



Bureau Veritas Consumer Products Services Ltd., Taoyuan Branch

A D T

Data: 10

Date: 2014-08-06

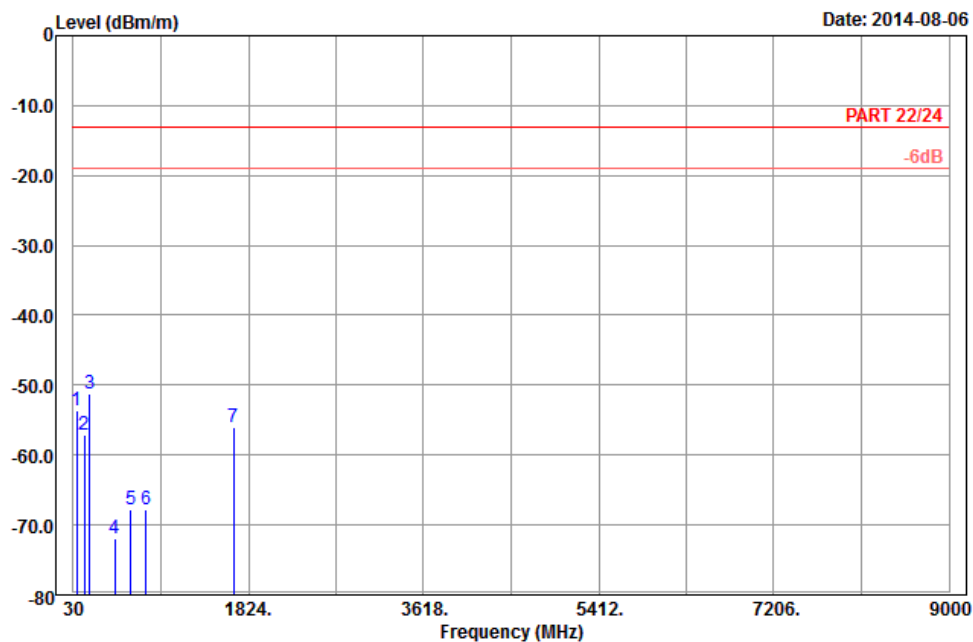

Site : 966 chamber 5  
 Condition: PART 22/24 3m Vertical  
 Remark : LTE\_Band 5\_QPSK(1,0)\_10M\_CH20525  
 Tested by: Harry Hsueh  
 Plane : Z  
 ANT : Aux

	Read	Limit	Over			
Freq	Level	Level	Line	Limit	Factor	Remark
MHz	dBm/m	dBm	dBm/m	dB	dB/m	
1	65.91	-53.56	-40.32	-13.00	-40.56	-13.24 Peak
2	144.21	-57.18	-49.37	-13.00	-44.18	-7.81 Peak
3 pp	198.75	-51.17	-45.03	-13.00	-38.17	-6.14 Peak
4	456.10	-72.00	-67.99	-13.00	-59.00	-4.01 Peak
5	622.70	-67.80	-67.97	-13.00	-54.80	0.17 Peak
6	776.00	-67.75	-68.16	-13.00	-54.75	0.41 Peak
7	1673.00	-56.08	-63.99	-13.00	-43.08	7.91 Peak



A D T

LTE BAND 26  
CHANNEL BANDWIDTH: 15MHz / QPSK



Bureau Veritas Consumer Products Services Ltd., Taoyuan Branch

A D T

Data: 9

Date: 2014-08-25

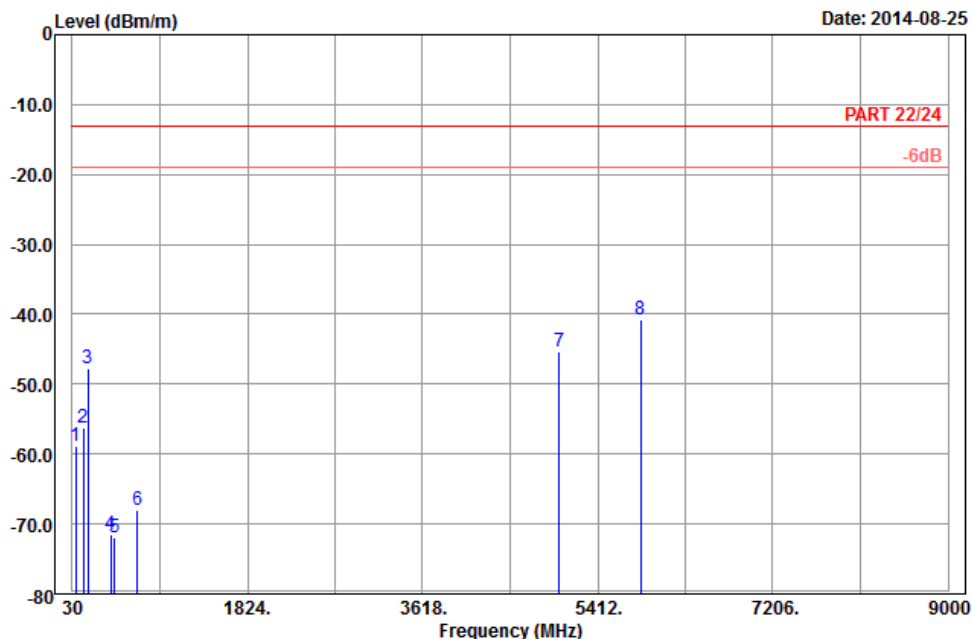

Site : 966 chamber 5  
 Condition: PART 22/24 3m Horizontal  
 Remark : LTE\_Band 26\_QPSK(1,0)\_15M\_CH26915  
 Tested by: Harry Hsueh  
 Plane : Y  
 ANT : Aux

	Read	Limit	Over			
Freq	Level	Level	Line	Limit	Factor	Remark
MHz	dBm/m	dBm	dBm/m	dB	dB/m	
1	67.53	-58.78	-45.82	-13.00	-45.78	-12.96 Peak
2	139.35	-56.26	-48.57	-13.00	-43.26	-7.69 Peak
3	193.08	-47.73	-41.86	-13.00	-34.73	-5.87 Peak
4	420.40	-71.40	-68.21	-13.00	-58.40	-3.19 Peak
5	462.40	-72.01	-67.80	-13.00	-59.01	-4.21 Peak
6	693.40	-68.04	-67.69	-13.00	-55.04	-0.35 Peak
7	5019.00	-45.27	-64.35	-13.00	-32.27	19.08 Peak
8 pp	5855.50	-40.69	-61.47	-13.00	-27.69	20.78 Peak



A D T



Bureau Veritas Consumer Products Services Ltd., Taoyuan Branch

A D T

Data: 10

Date: 2014-08-25

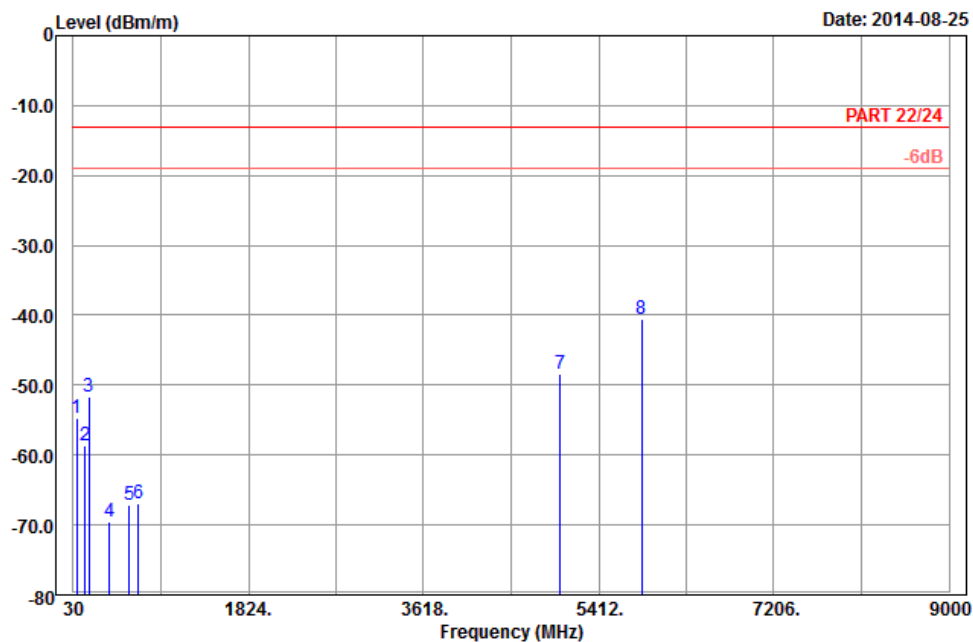

Site : 966 chamber 5  
 Condition: PART 22/24 3m Vertical  
 Remark : LTE\_Band 26\_QPSK(1,0)\_15M\_CH26915  
 Tested by: Harry Hsueh  
 Plane : Y  
 ANT : Aux

	Read	Limit	Over			
Freq	Level	Level	Line	Limit	Factor	Remark
MHz	dBm/m	dBm	dBm/m	dB	dB/m	
1	62.94	-54.61	-40.96	-13.00	-41.61	-13.65 Peak
2	153.39	-58.57	-50.71	-13.00	-45.57	-7.86 Peak
3	187.95	-51.68	-45.98	-13.00	-38.68	-5.70 Peak
4	398.70	-69.60	-66.81	-13.00	-56.60	-2.79 Peak
5	600.30	-67.12	-67.55	-13.00	-54.12	0.43 Peak
6	694.10	-66.85	-66.50	-13.00	-53.85	-0.35 Peak
7	5019.00	-48.50	-67.58	-13.00	-35.50	19.08 Peak
8 pp	5855.50	-40.54	-61.32	-13.00	-27.54	20.78 Peak



A D T

## 5 PHOTOGRAPHS OF THE TEST CONFIGURATION

Please refer to the attached file (Test Setup Photo).



## 6 INFORMATION ON THE TESTING LABORATORIES

We, Bureau Veritas Consumer Products Services (H.K.) Ltd., Taoyuan Branch, were founded in 1988 to provide our best service in EMC, Radio, Telecom and Safety consultation. Our laboratories are accredited and approved according to ISO/IEC 17025.

If you have any comments, please feel free to contact us at the following:

**Linko EMC/RF Lab:**

Tel: 886-2-26052180  
Fax: 886-2-26051924

**Hsin Chu EMC/RF Lab:**

Tel: 886-3-5935343  
Fax: 886-3-5935342

**Hwa Ya EMC/RF/Safety/Telecom Lab:**

Tel: 886-3-3183232  
Fax: 886-3-3270892

**Email:** [service.adt@tw.bureauveritas.com](mailto:service.adt@tw.bureauveritas.com)

**Web Site:** [www.bureauveritas-adt.com](http://www.bureauveritas-adt.com)

The address and road map of all our labs can be found in our web site also.



A D T

## **7 APPENDIX A – MODIFICATIONS RECORDERS FOR ENGINEERING CHANGES TO THE EUT BY THE LAB**

No any modifications were made to the EUT by the lab during the test.

**---END---**