



# FCC TEST REPORT (PART 22)

**REPORT NO.:** RF131023C31-5  
**MODEL NO.:** 0P6B700  
**FCC ID:** NM80P6B700  
**RECEIVED:** Oct. 23, 2013  
**TESTED:** Jan. 01, 2014 ~ Jan. 09, 2014  
**ISSUED:** Jan. 14, 2014

**APPLICANT:** HTC Corporation

**ADDRESS:** No. 23,Xinghua Rd.,Taoyuan 330,Taiwan,R.O.C.

**ISSUED BY:** Bureau Veritas Consumer Products Services  
(H.K.) Ltd., Taoyuan Branch

**LAB ADDRESS:** No. 47, 14th Ling, Chia Pau Vil., Lin Kou Dist., New  
Taipei City, Taiwan ( R.O.C. )

**TEST LOCATION:** No. 19, Hwa Ya 2nd Rd, Wen Hwa Tsuen, Kwei  
Shan Hsiang, Taoyuan Hsien 333, Taiwan, R.O.C.

This report should not be used by the client to claim  
product certification, approval, or endorsement by TAF or  
any government agencies.



This report is for your exclusive use. Any copying or replication of this report to or for any other person or entity, or use of our name or trademark, is permitted only with our prior written permission. This report sets forth our findings solely with respect to the test samples identified herein. The results set forth in this report are not indicative or representative of the quality or characteristics of the lot from which a test sample was taken or any similar or identical product unless specifically and expressly noted. Our report includes all of the tests requested by you and the results thereof based upon the information that you provided to us. You have 60 days from date of issuance of this report to notify us of any material error or omission caused by our negligence, provided, however, that such notice shall be in writing and shall specifically address the issue you wish to raise. A failure to raise such issue within the prescribed time shall constitute your unqualified acceptance of the completeness of this report, the tests conducted and the correctness of the report contents. Unless specific mention, the uncertainty of measurement has been explicitly taken into account to declare the compliance or non-compliance to the specification

## TABLE OF CONTENTS

RELEASE CONTROL RECORD.....	3
1 CERTIFICATION .....	4
2 SUMMARY OF TEST RESULTS.....	5
2.1 MEASUREMENT UNCERTAINTY .....	5
2.2 TEST SITE AND INSTRUMENTS .....	6
3 GENERAL INFORMATION .....	7
3.1 GENERAL DESCRIPTION OF EUT .....	7
3.2 CONFIGURATION OF SYSTEM UNDER TEST .....	9
3.3 DESCRIPTION OF SUPPORT UNITS .....	9
3.4 TEST ITEM AND TEST CONFIGURATION .....	10
3.5 EUT OPERATING CONDITIONS .....	13
3.6 GENERAL DESCRIPTION OF APPLIED STANDARDS .....	13
4 TEST TYPES AND RESULTS.....	14
4.1 OUTPUT POWER MEASUREMENT .....	14
4.1.1 LIMITS OF OUTPUT POWER MEASUREMENT .....	14
4.1.2 TEST PROCEDURES .....	14
4.1.3 TEST SETUP .....	15
4.1.4 TEST RESULTS .....	16
4.2 FREQUENCY STABILITY MEASUREMENT .....	22
4.2.1 LIMITS OF FREQUENCY STABILITY MEASUREMENT .....	22
4.2.2 TEST PROCEDURE .....	22
4.2.3 TEST SETUP .....	22
4.2.4 TEST RESULTS .....	23
4.3 OCCUPIED BANDWIDTH MEASUREMENT .....	24
4.3.1 TEST PROCEDURES .....	24
4.3.2 TEST SETUP .....	24
4.3.3 TEST RESULTS .....	25
4.4 BAND EDGE MEASUREMENT .....	28
4.4.1 LIMITS OF BAND EDGE MEASUREMENT .....	28
4.4.2 TEST SETUP .....	28
4.4.3 TEST PROCEDURES .....	28
4.4.4 TEST RESULTS .....	29
4.5 CONDUCTED SPURIOUS EMISSIONS.....	33
4.5.1 LIMITS OF CONDUCTED SPURIOUS EMISSIONS MEASUREMENT.....	33
4.5.2 TEST PROCEDURE .....	33
4.5.3 TEST SETUP .....	33
4.5.4 TEST RESULTS .....	34
4.6 RADIATED EMISSION MEASUREMENT .....	35
4.6.1 LIMITS OF RADIATED EMISSION MEASUREMENT .....	35
4.6.2 TEST PROCEDURES .....	35
4.6.3 DEVIATION FROM TEST STANDARD .....	35
4.6.4 TEST SETUP .....	36
4.6.5 TEST RESULTS .....	37
5 PHOTOGRAPHS OF THE TEST CONFIGURATION .....	47
6 INFORMATION ON THE TESTING LABORATORIES .....	48
7 APPENDIX A – MODIFICATIONS RECORDERS FOR ENGINEERING CHANGES TO THE EUT BY THE LAB.....	49



A D T

## RELEASE CONTROL RECORD

ISSUE NO.	REASON FOR CHANGE	DATE ISSUED
RF131023C31-5	Original release	Jan. 14, 2014



# 1 CERTIFICATION

**PRODUCT:** Smartphone

**MODEL:** OP6B700

**BRAND:** HTC

**APPLICANT:** HTC Corporation

**TESTED:** Jan. 01, 2014 ~ Jan. 09, 2014

**TEST SAMPLE:** Production Unit

**STANDARDS:** FCC PART 22, Subpart H

The above equipment (model: OP6B700) has been tested by **Bureau Veritas Consumer Products Services (H.K.) Ltd., Taoyuan Branch**, and found compliance with the requirement of the above standards. The test record, data evaluation & Equipment Under Test (EUT) configurations represented herein are true and accurate accounts of the measurements of the sample's EMC characteristics under the conditions specified in this report.

**PREPARED BY** : Ivonne Wu , **DATE** : Jan. 14, 2014  
Ivonne Wu / Supervisor

**APPROVED BY** : Sam Chen , **DATE** : Jan. 14, 2014  
Sam Chen / Senior Project Engineer

## 2 SUMMARY OF TEST RESULTS

The EUT has been tested according to the following specifications:

APPLIED STANDARD: FCC Part 22 & Part 2			
STANDARD SECTION	TEST TYPE	RESULT	REMARK
2.1046 22.913 (a)	Effective radiated power	PASS	Meet the requirement of limit.
2.1055 22.355	Frequency Stability	PASS	Meet the requirement of limit.
2.1049	Occupied Bandwidth	PASS	Meet the requirement of limit.
22.917	Band Edge Measurements	PASS	Meet the requirement of limit.
2.1051 22.917	Conducted Spurious Emissions	PASS	Meet the requirement of limit.
2.1053 22.917	Radiated Spurious Emissions	PASS	Meet the requirement of limit. Minimum passing margin is -20.74dB at 2509.56MHz.

### 2.1 MEASUREMENT UNCERTAINTY

Where relevant, the following measurement uncertainty levels have been estimated for tests performed on the EUT as specified in CISPR 16-4-2:

MEASUREMENT	FREQUENCY	UNCERTAINTY
Conducted emissions	150kHz~30MHz	2.44 dB
Radiated emissions	30MHz ~ 200MHz	2.93 dB
	200MHz ~1000MHz	2.95 dB
	1GHz ~ 18GHz	2.26 dB
	18GHz ~ 40GHz	1.94 dB

This uncertainty represents an expanded uncertainty expressed at approximately the 95% confidence level using a coverage factor of k=2.

## 2.2 TEST SITE AND INSTRUMENTS

DESCRIPTION & MANUFACTURER	MODEL NO.	SERIAL NO.	DATE OF CALIBRATION	DUE DATE OF CALIBRATION
Test Receiver ROHDE & SCHWARZ	ESCI	100744	Apr. 15, 2013	Apr. 14, 2014
Spectrum Analyzer ROHDE & SCHWARZ	FSU43	101261	Dec. 21, 2013	Dec. 20, 2014
BILOG Antenna SCHWARZBECK	VULB9168	9168-472	Mar. 25, 2013	Mar. 24, 2014
HORN Antenna SCHWARZBECK	BBHA 9120 D	9120D-969	Jan. 07, 2013	Jan. 06, 2014
HORN Antenna SCHWARZBECK	BBHA 9170	9170-480	Dec. 18, 2013	Dec. 17, 2014
Loop Antenna	HFH2-Z2	100070	Jan. 31, 2012	Jan. 30, 2014
Preamplifier EMCI	EMC 330H	980112	Dec. 27, 2013	Dec. 26, 2014
RF signal cable HUBER+SUHNNER	SUCOFLEX 104	309219/4 2950114	Oct. 18, 2013	Oct. 17, 2014
RF signal cable HUBER+SUHNNER	SUCOFLEX 104	250130/4	Oct. 18, 2013	Oct. 17, 2014
RF signal cable Worken	RG-213	NA	Nov. 07, 2013	Nov. 06, 2014
Software BV ADT	E3 6.120103	NA	NA	NA
Antenna Tower MF	MFA-440H	NA	NA	NA
Turn Table MF	MFT-201SS	NA	NA	NA
Antenna Tower & Turn Table Controller MF	MF-7802	NA	NA	NA
Mini-Circuits Power Splitter	ZN2PD-9G	NA	Jul. 18, 2013	Jul. 17, 2014
JFW 20dB attenuation	50HF-020-SMA	NA	NA	NA
Communications Tester-Wireless	E5515C	MY52102544	Sep. 05, 2012	Sep. 04, 2014
Radio Communication Analyzer	MT8820C	6201300640	Aug. 01, 2013	Jul. 31, 2014

- NOTE:**
1. The calibration interval of the above test instruments is 12 months and the calibrations are traceable to NML/ROC and NIST/USA.
  2. The test was performed in HwaYa Chamber 10.
  3. The horn antenna and HP preamplifier (model: 8449B) are used only for the measurement of emission frequency above 1GHz if tested.
  4. The FCC Site Registration No. is 690701.
  5. The IC Site Registration No. is IC 7450F-10.

### 3 GENERAL INFORMATION

#### 3.1 GENERAL DESCRIPTION OF EUT

<b>EUT</b>	Smartphone	
<b>MODEL NO.</b>	0P6B700	
<b>POWER SUPPLY</b>	5.0Vdc (adapter or host equipment) 3.8Vdc (battery)	
<b>MODULATION TYPE</b>	<b>CDMA</b>	QPSK, OQPSK, HPSK
	<b>LTE</b>	QPSK, 16QAM
<b>FREQUENCY RANGE</b>	<b>CDMA</b>	824.7MHz ~ 848.31MHz
	<b>LTE 26 (Channel Bandwidth: 1.4MHz)</b>	824.7MHz ~ 848.3MHz
	<b>LTE 26 (Channel Bandwidth: 3MHz)</b>	825.5MHz ~ 847.5MHz
	<b>LTE 26 (Channel Bandwidth: 5MHz)</b>	826.5MHz ~ 846.5MHz
	<b>LTE 26 (Channel Bandwidth: 10MHz)</b>	829MHz ~ 844MHz
<b>MAX. ERP POWER</b>	<b>CDMA</b>	86.50mW
	<b>LTE 26 (Channel Bandwidth: 1.4MHz)</b>	67.30mW
	<b>LTE 26 (Channel Bandwidth: 3MHz)</b>	66.53mW
	<b>LTE 26 (Channel Bandwidth: 5MHz)</b>	69.66mW
	<b>LTE 26 (Channel Bandwidth: 10MHz)</b>	76.91mW
<b>EMISSION DESIGNATOR</b>	<b>CDMA</b>	1M27F9W
	<b>LTE 26 (Channel Bandwidth: 1.4MHz)</b>	1M08G7D
	<b>LTE 26 (Channel Bandwidth: 3MHz)</b>	2M68G7D
	<b>LTE 26 (Channel Bandwidth: 5MHz)</b>	4M49G7D
	<b>LTE 26 (Channel Bandwidth: 10MHz)</b>	8M93W7D
<b>ANTENNA TYPE</b>	<b>CDMA:</b> Fixed Internal Antenna with -2.5dBi gain <b>LTE:</b> Fixed Internal Antenna with -2.5dBi gain	
<b>I/O PORTS</b>	Refer to users' manual	
<b>DATA CABLE</b>	Refer to NOTE as below	
<b>ACCESSORY DEVICES</b>	Refer to NOTE as below	



A D T

**NOTE:**

1. The EUT's accessories list refers to Ext. Pho.
2. There're 2 configurations for the EUT listed as below.  
Main Sample (A): Battery 1 + LCD Panel 1  
2<sup>nd</sup> Sample (B): Battery 2 + LCD Panel 2  
✧ Only the worst test data was presented in the report.
3. The above EUT information was declared by manufacturer and for more detailed features description, please refer to the manufacturer's specifications or User's Manual.



### 3.2 CONFIGURATION OF SYSTEM UNDER TEST

#### FOR RADIATION EMISSION TEST

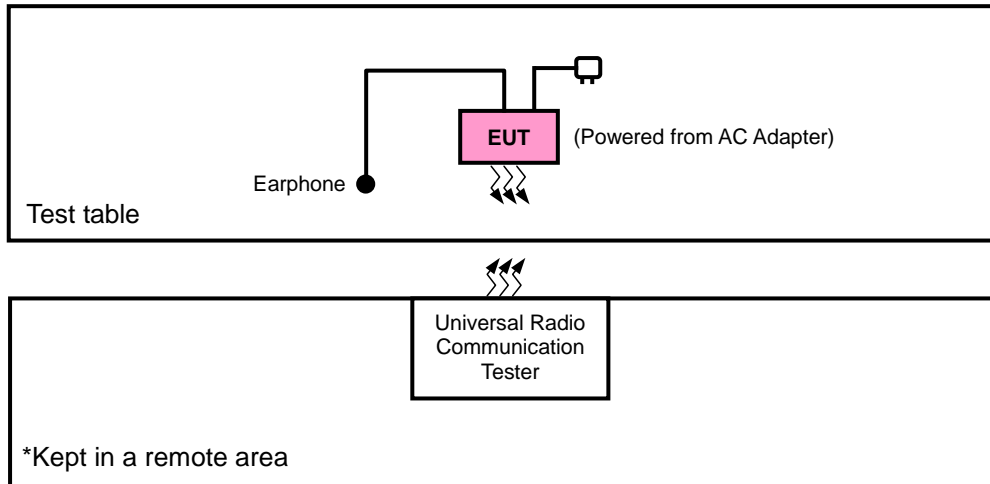

#### FOR E.R.P. TEST

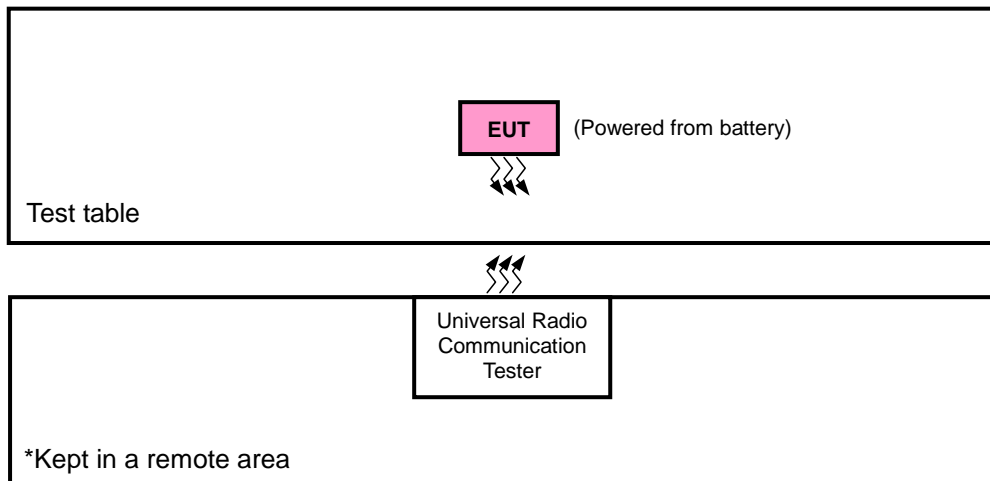

### 3.3 DESCRIPTION OF SUPPORT UNITS

The EUT has been tested as an independent unit together with other necessary accessories or support units.

### 3.4 TEST ITEM AND TEST CONFIGURATION

Pre-Scan has been conducted to determine the worst-case mode from all possible combinations between available modulations, data rates, XYZ axis and antenna ports. The worst case was found when positioned on X-plane for CDMA and Y-plane for LTE for ERP, and X-axis for CDMA and Z-axis for LTE for radiated emission for antenna 0. Following channel(s) was (were) selected for the final test as listed below:

EUT CONFIGURE MODE	DESCRIPTION
A	Main sample
B	2 <sup>nd</sup> sample

#### CDMA MODE

EUT CONFIGURE MODE	TEST ITEM	AVAILABLE CHANNEL	TESTED CHANNEL	MODE
A	ERP	1013 to 777	1013, 384, 777	1xRTT
A	FREQUENCY STABILITY	1013 to 777	384	1xRTT
A	OCCUPIED BANDWIDTH	1013 to 777	1013, 384, 777	1xRTT
A	BAND EDGE	1013 to 777	1013, 777	1xRTT
A	CONDCUDED EMISSION	1013 to 777	384	1xRTT
A	RADIATED EMISSION	1013 to 777	384	1xRTT



**LTE BAND 26 MODE**

EUT CONFIGURE MODE	TEST ITEM	AVAILABLE CHANNEL	TESTED CHANNEL	CHANNEL BANDWIDTH	MODULATION	MODE		
A	ERP	26797 to 27033	26797, 26915, 27033	1.4MHz	QPSK, 16QAM	1 RB / 2 RB Offset		
		26805 to 27025	26805, 26915, 27025	3MHz	QPSK, 16QAM	1 RB / 7 RB Offset		
		26815 to 27015	26815, 26915, 27015	5MHz	QPSK, 16QAM	1 RB / 12 RB Offset		
		26840 to 26990	26840, 26915, 26990	10MHz	QPSK, 16QAM	1 RB / 24 RB Offset		
B	ERP	26840 to 26990	26915	10MHz	QPSK, 16QAM	1 RB / 24 RB Offset		
A	FREQUENCY STABILITY	26797 to 27033	26915	1.4MHz	QPSK	1 RB / 2 RB Offset		
		26805 to 27025	26915	3MHz	QPSK	1 RB / 7 RB Offset		
		26815 to 27015	26915	5MHz	QPSK	1 RB / 12 RB Offset		
		26840 to 26990	26915	10MHz	QPSK	1 RB / 24 RB Offset		
A	OCCUPIED BANDWIDTH	26797 to 27033	26797, 26915, 27033	1.4MHz	QPSK, 16QAM	6 RB / 0 RB Offset		
		26805 to 27025	26805, 26915, 27025	3MHz	QPSK, 16QAM	15 RB / 0 RB Offset		
		26815 to 27015	26815, 26915, 27015	5MHz	QPSK, 16QAM	25 RB / 0 RB Offset		
		26840 to 26990	26840, 26915, 26990	10MHz	QPSK, 16QAM	50 RB / 0 RB Offset		
A	BAND EDGE	26797 to 27033	26797	1.4MHz	QPSK	1 RB / 0 RB Offset 6 RB / 0 RB Offset		
			27033	1.4MHz	QPSK	1 RB / 5 RB Offset 6 RB / 0 RB Offset		
		26805 to 27025	26805	3MHz	QPSK	1 RB / 0 RB Offset 15 RB / 0 RB Offset		
			27025	3MHz	QPSK	1 RB / 14 RB Offset 15 RB / 0 RB Offset		
		26815 to 27015	26815	5MHz	QPSK	1 RB / 0 RB Offset 25 RB / 0 RB Offset		
			27015	5MHz	QPSK	1 RB / 24 RB Offset 25 RB / 0 RB Offset		
		26840 to 26990	26840	10MHz	QPSK	1 RB / 0 RB Offset 50 RB / 0 RB Offset		
			26990	10MHz	QPSK	1 RB / 49 RB Offset 50 RB / 0 RB Offset		
		A	CONDCUDED EMISSION	26797 to 27033	26915	1.4MHz	QPSK	1 RB / 2 RB Offset
				26805 to 27025	26915	3MHz	QPSK	1 RB / 7 RB Offset
				26815 to 27015	26915	5MHz	QPSK	1 RB / 12 RB Offset
				26840 to 26990	26915	10MHz	QPSK	1 RB / 24 RB Offset
A	RADIATED EMISSION	26797 to 27033	26915	1.4MHz	QPSK	1 RB / 2 RB Offset		
		26805 to 27025	26915	3MHz	QPSK	1 RB / 7 RB Offset		
		26815 to 27015	26915	5MHz	QPSK	1 RB / 12 RB Offset		
		26840 to 26990	26915	10MHz	QPSK	1 RB / 24 RB Offset		

**Note:** This device was tested under all bandwidths, RB configurations and modulations. The worst case was found in QPSK modulation.



A D T

**TEST CONDITION:**

TEST ITEM	ENVIRONMENTAL CONDITIONS	INPUT POWER	TESTED BY
ERP	26deg. C, 58%RH	3.8Vdc	Howard Kao
FREQUENCY STABILITY	26deg. C, 58%RH	3.8Vdc	Howard Kao
OCCUPIED BANDWIDTH	26deg. C, 58%RH	3.8Vdc	Howard Kao
BAND EDGE	26deg. C, 58%RH	3.8Vdc	Howard Kao
CONDCUDED EMISSION	26deg. C, 58%RH	3.8Vdc	Howard Kao
RADIATED EMISSION	25deg. C, 65%RH	120Vac, 60Hz	Johnson Liao



A D T

### **3.5 EUT OPERATING CONDITIONS**

The EUT makes a call to the communication simulator. The communication simulator station system controlled a EUT to export maximum output power under transmission mode and specific channel frequency

### **3.6 GENERAL DESCRIPTION OF APPLIED STANDARDS**

The EUT is a RF product. According to the specifications of the manufacturer, it must comply with the requirements of the following standards:

**FCC 47 CFR Part 2**

**FCC 47 CFR Part 22**

**ANSI/TIA/EIA-603-C 2004**

**NOTE:** All test items have been performed and recorded as per the above standards.

## 4 TEST TYPES AND RESULTS

### 4.1 OUTPUT POWER MEASUREMENT

#### 4.1.1 LIMITS OF OUTPUT POWER MEASUREMENT

Mobile / Portable station are limited to 7 watts e.r.p.

#### 4.1.2 TEST PROCEDURES

##### **EIRP / ERP MEASUREMENT:**

- a. All measurements were done at low, middle and high operational frequency range. RBW and VBW is 5MHz for CDMA, and 10MHz for LTE mode.
- b. Substitution method is used for E.I.R.P measurement. In the semi-anechoic chamber, EUT placed on the 0.8m height of Turn Table, rotated the table around 360 degrees to search the maximum radiation power and receiver antenna shall be rotated vertical and horizontal polarization and moved height from 1m to 4m to find the maximum polar radiated power. The “Read Value” is the spectrum reading the maximum power value.
- c. The substitution horn antenna is substituted for EUT at the same position and signals generator export the CW signal to the substitution antenna via a tx cable. Rotated the Turn Table and moved receiving antenna to find the maximum radiation power. Adjust output power level of S.G to get a Value of spectrum reading equal to “Read Value” of step b. Record the power level of S.G
- d.  $EIRP = \text{Output power level of S.G} - \text{TX cable loss} + \text{Antenna gain of substitution horn}$ . E.R.P power can be calculated form E.I.R.P power by subtracting the gain of dipole,  $E.R.P \text{ power} = E.I.R.P \text{ power} - 2.15\text{dBi}$ .

##### **CONDUCTED POWER MEASUREMENT:**

The EUT was set up for the maximum power with GSM, GPRS, EDGE, WCDMA & CDMA link data modulation and link up with simulator. Set the EUT to transmit under low, middle and high channel and record the power level shown on simulator.

### 4.1.3 TEST SETUP

#### EIRP / ERP MEASUREMENT:

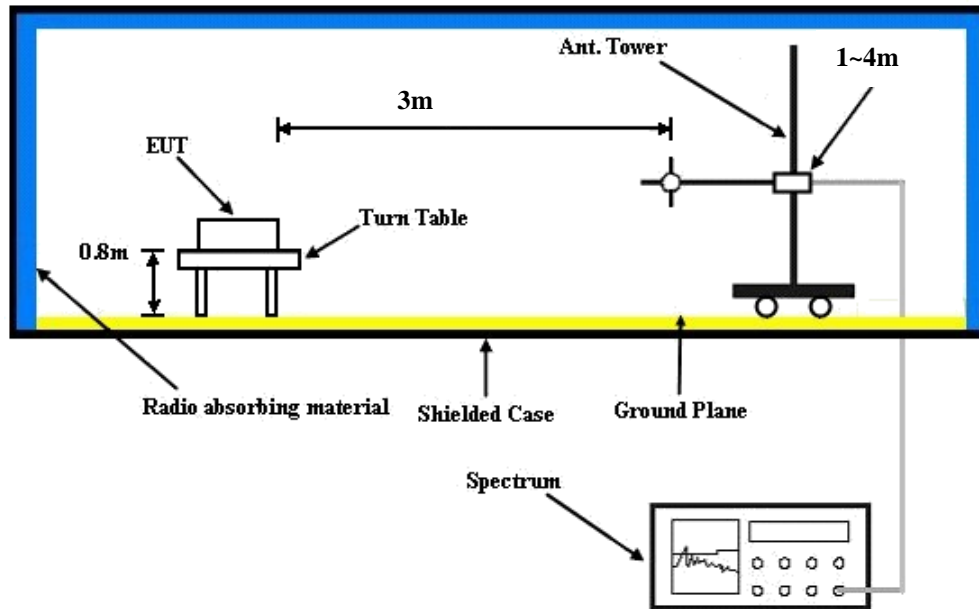

#### CONDUCTED POWER MEASUREMENT:

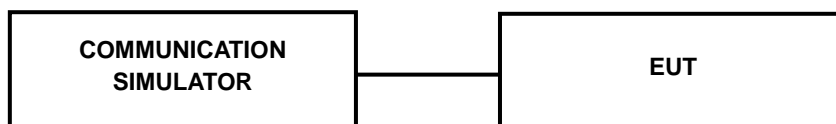

#### 4.1.4 TEST RESULTS

##### CONDUCTED OUTPUT POWER (dBm)

Band	CDMA		
	1013	384	777
Channel	824.70	836.52	848.31
Frequency (MHz)	824.70	836.52	848.31
RC1+SO55	24.25	24.17	24.25
RC3+SO55	24.14	24.17	24.25
RC3+SO32(+ F-SCH)	24.13	24.16	24.24
RC3+SO32(+SCH)	24.12	24.15	24.23
RTAP 153.6	24.17	24.20	<b>24.28</b>
RETAP 4096	24.04	24.07	24.15

##### LTE Band 26

Band / BW	Modulation	RB Size	RB Offset	Low CH	Mid CH	High CH	3PGG MPR (dB)
				26797	26915	27033	
				Frequency	Frequency	Frequency	
				824.7 MHz	836.5 MHz	848.3 MHz	
26 / 1.4M	QPSK	1	0	23.24	23.27	23.21	0
		1	2	23.25	23.34	23.14	0
		1	5	23.23	23.24	23.15	0
		3	0	23.20	23.27	23.18	0
		3	1	23.22	23.25	23.19	0
		3	3	23.17	23.28	23.14	0
		6	0	22.28	22.31	22.22	1
	16QAM	1	0	22.20	22.23	22.17	1
		1	2	22.21	22.30	22.10	1
		1	5	22.19	22.20	22.11	1
		3	0	22.16	22.23	22.14	1
		3	1	22.18	22.21	22.15	1
		3	3	22.13	22.24	22.10	1
		6	0	21.24	21.27	21.18	2

Band / BW	Modulation	RB Size	RB Offset	Low CH	Mid CH	High CH	3PGG MPR (dB)
				26805	26915	27025	
				Frequency	Frequency	Frequency	
				825.5 MHz	836.5 MHz	847.5 MHz	
26 / 3M	QPSK	1	0	23.37	23.40	23.34	0
		1	7	23.38	23.47	23.27	0
		1	14	23.36	23.37	23.28	0
		8	0	22.33	22.40	22.31	1
		8	3	22.35	22.38	22.32	1
		8	7	22.30	22.41	22.27	1
		15	0	22.41	22.44	22.35	1
	16QAM	1	0	22.33	22.36	22.30	1
		1	7	22.34	22.43	22.23	1
		1	14	22.32	22.33	22.24	1
		8	0	21.29	21.36	21.27	2
		8	3	21.31	21.34	21.28	2
		8	7	21.26	21.37	21.23	2
		15	0	21.37	21.40	21.31	2





A D T

Band / BW	Modulation	RB Size	RB Offset	Low CHG 26815	Mid CH 26915	High CH 27015	3PGG MPR (dB)
				Frequency 826.5 MHz	Frequency 836.5 MHz	Frequency 846.5 MHz	
26 / 5M	QPSK	1	0	23.48	23.51	23.45	0
		1	12	23.49	23.58	23.38	0
		1	24	23.47	23.48	23.39	0
		12	0	22.44	22.51	22.42	1
		12	6	22.46	22.49	22.43	1
		12	13	22.41	22.52	22.38	1
	16QAM	25	0	22.52	22.55	22.46	1
		1	0	22.44	22.47	22.41	1
		1	12	22.45	22.54	22.34	1
		1	24	22.43	22.44	22.35	1
		12	0	21.40	21.47	21.38	2
		12	6	21.42	21.45	21.39	2
		12	13	21.37	21.48	21.34	2
		25	0	21.48	21.51	21.42	2

Band / BW	Modulation	RB Size	RB Offset	Low CH 26840	Mid CH 26915	High CH 26990	3PGG MPR (dB)
				Frequency 829.0 MHz	Frequency 836.5 MHz	Frequency 844.0 MHz	
26 / 10M	QPSK	1	0	23.57	23.60	23.54	0
		1	24	23.58	23.67	23.47	0
		1	49	23.56	23.57	23.48	0
		25	0	22.53	22.60	22.51	1
		25	12	22.55	22.58	22.52	1
		25	25	22.50	22.61	22.47	1
		50	0	22.61	22.64	22.55	1
	16QAM	1	0	22.53	22.56	22.50	1
		1	24	22.54	22.63	22.43	1
		1	49	22.52	22.53	22.44	1
		25	0	21.49	21.56	21.47	2
		25	12	21.51	21.54	21.48	2
		25	25	21.46	21.57	21.43	2
		50	0	21.57	21.60	21.51	2



A D T

## ERP POWER (dBm)

### TEST MODE A

#### CDMA

Plane	Channel	Frequency (MHz)	LVL (dBm)	Correction Factor(dB)	ERP(dBm)	ERP(mW)	Polarization (H/V)
X	1013	824.7	-11.10	32.62	19.37	86.50	H
	384	836.52	-11.04	32.52	19.33	85.70	H
	777	848.31	-11.26	32.65	19.24	83.95	H
	1013	824.7	-23.19	32.76	7.42	5.52	V
	384	836.52	-23.19	32.39	7.05	5.07	V
	777	848.31	-23.18	32.54	7.21	5.26	V

#### LTE Band 26

#### CHANNEL BANDWIDTH: 1.4MHz QPSK

Plane	Channel	Frequency (MHz)	LVL (dBm)	Correction Factor(dB)	ERP(dBm)	ERP(mW)	Polarization (H/V)
Y	26797	824.7	-12.19	32.62	18.28	67.30	H
	26915	836.5	-12.38	32.52	17.99	62.95	H
	27033	848.3	-12.22	32.65	18.28	67.30	H
	26797	824.7	-17.34	32.76	13.27	21.23	V
	26915	836.5	-17.33	32.39	12.91	19.54	V
	27033	848.3	-17.42	32.54	12.97	19.82	V

#### CHANNEL BANDWIDTH: 1.4MHz 16QAM

Plane	Channel	Frequency (MHz)	LVL (dBm)	Correction Factor(dB)	ERP(dBm)	ERP(mW)	Polarization (H/V)
Y	26797	824.7	-13.01	32.62	17.46	55.72	H
	26915	836.5	-12.96	32.52	17.41	55.08	H
	27033	848.3	-12.97	32.65	17.53	56.62	H
	26797	824.7	-18.30	32.76	12.31	17.02	V
	26915	836.5	-17.66	32.39	12.58	18.11	V
	27033	848.3	-18.19	32.54	12.20	16.60	V



A D T

### CHANNEL BANDWIDTH: 3MHz QPSK

Plane	Channel	Frequency (MHz)	LVL (dBm)	Correction Factor(dB)	ERP(dBm)	ERP(mW)	Polarization (H/V)
Y	26805	825.5	-12.24	32.62	18.23	66.53	H
	26915	836.5	-12.28	32.52	18.09	64.42	H
	27025	847.5	-12.31	32.65	18.19	65.92	H
	26805	825.5	-17.67	32.76	12.94	19.68	V
	26915	836.5	-17.36	32.39	12.88	19.41	V
	27025	847.5	-17.45	32.54	12.94	19.68	V

### CHANNEL BANDWIDTH: 3MHz 16QAM

Plane	Channel	Frequency (MHz)	LVL (dBm)	Correction Factor(dB)	ERP(dBm)	ERP(mW)	Polarization (H/V)
Y	26805	825.5	-12.81	32.62	17.66	58.34	H
	26915	836.5	-12.90	32.52	17.47	55.85	H
	27025	847.5	-12.88	32.65	17.62	57.81	H
	26805	825.5	-17.91	32.76	12.70	18.62	V
	26915	836.5	-17.98	32.39	12.26	16.83	V
	27025	847.5	-17.87	32.54	12.52	17.86	V

### CHANNEL BANDWIDTH: 5MHz QPSK

Plane	Channel	Frequency (MHz)	LVL (dBm)	Correction Factor(dB)	ERP(dBm)	ERP(mW)	Polarization (H/V)
Y	26815	826.5	-12.16	32.62	18.31	67.76	H
	26915	836.5	-12.27	32.52	18.10	64.57	H
	27015	846.5	-12.07	32.65	18.43	69.66	H
	26815	826.5	-17.75	32.76	12.86	19.32	V
	26919	836.5	-17.54	32.39	12.70	18.62	V
	27015	846.5	-17.74	32.54	12.65	18.41	V



A D T

**CHANNEL BANDWIDTH: 5MHz 16QAM**

Plane	Channel	Frequency (MHz)	LVL (dBm)	Correction Factor(dB)	ERP(dBm)	ERP(mW)	Polarization (H/V)
Y	26815	826.5	-12.88	32.62	17.59	57.41	H
	26915	836.5	-12.94	32.52	17.43	55.34	H
	27015	846.5	-12.75	32.65	17.75	59.57	H
	26815	826.5	-17.74	32.76	12.87	19.36	V
	26919	836.5	-17.53	32.39	12.71	18.66	V
	27015	846.5	-17.64	32.54	12.75	18.84	V

**CHANNEL BANDWIDTH: 10MHz QPSK**

Plane	Channel	Frequency (MHz)	LVL (dBm)	Correction Factor(dB)	ERP(dBm)	ERP(mW)	Polarization (H/V)
Y	26840	829	-11.61	32.62	18.86	76.91	H
	26915	836.5	-11.82	32.52	18.55	71.61	H
	26990	844	-11.66	32.65	18.84	76.56	H
	26840	829	-17.57	32.76	13.04	20.14	V
	26919	836.5	-17.34	32.39	12.90	19.50	V
	26990	844	-17.29	32.54	13.10	20.42	V

**CHANNEL BANDWIDTH: 10MHz 16QAM**

Plane	Channel	Frequency (MHz)	LVL (dBm)	Correction Factor(dB)	ERP(dBm)	ERP(mW)	Polarization (H/V)
Y	26840	829	-12.81	32.62	17.66	58.34	H
	26915	836.5	-12.92	32.52	17.45	55.59	H
	26990	844	-12.87	32.65	17.63	57.94	H
	26840	829	-17.70	32.76	12.91	19.54	V
	26919	836.5	-17.58	32.39	12.66	18.45	V
	26990	844	-17.69	32.54	12.70	18.62	V



A D T

## TEST MODE B

### CHANNEL BANDWIDTH: 10MHz QPSK

Plane	Channel	Frequency (MHz)	LVL (dBm)	Correction Factor(dB)	ERP(dBm)	ERP(mW)	Polarization (H/V)
Y	26915	836.5	-11.78	32.52	18.59	72.28	H
	26915	836.5	-17.27	32.39	12.97	19.82	V

### CHANNEL BANDWIDTH: 10MHz 16QAM

Plane	Channel	Frequency (MHz)	LVL (dBm)	Correction Factor(dB)	ERP(dBm)	ERP(mW)	Polarization (H/V)
Y	26915	836.5	-12.49	32.52	17.88	61.38	H
	26915	836.5	-18.11	32.39	12.13	16.33	V

## 4.2 FREQUENCY STABILITY MEASUREMENT

### 4.2.1 LIMITS OF FREQUENCY STABILITY MEASUREMENT

1.5 ppm is for base and fixed station. 2.5 ppm is for mobile station.

### 4.2.2 TEST PROCEDURE

- Device is placed at the oven room. The oven room could control the temperatures and humidity. Power warm up is at least 15 min and power applied should perform before recording frequency error.
- EUT is connected the external power supply to control the DC input power. The test voltage range is from minimum to maximum working voltage. Each step shall be record the frequency error rate.
- The temperature range step is 10 degrees in this test items. All temperature levels shall be hold the  $\pm 0.5^{\circ}\text{C}$  during the measurement testing. The each temperature step shall be at least 0.5 hours, consider the EUT could be test under the stability condition.

**NOTE:** The frequency error was recorded frequency error from the communication simulator.

### 4.2.3 TEST SETUP

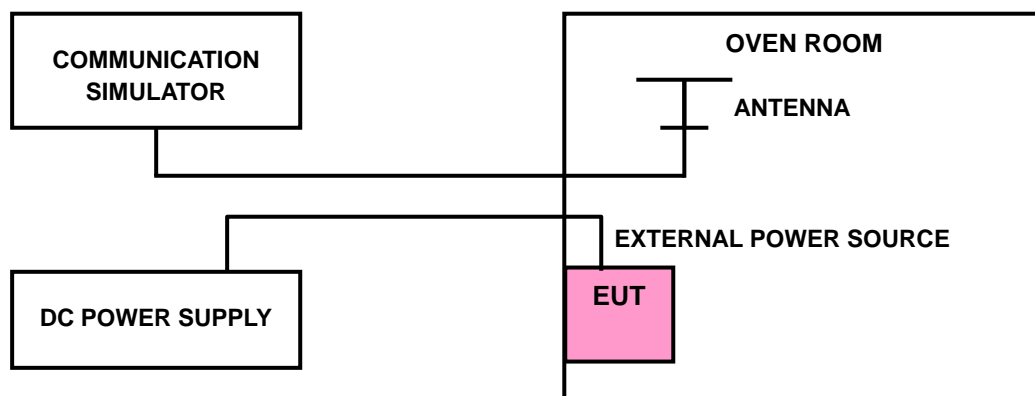

#### 4.2.4 TEST RESULTS

##### FREQUENCY ERROR vs. VOLTAGE

VOLTAGE (Volts)	FREQUENCY ERROR (ppm)					LIMIT (ppm)
	CDMA	LTE Band 26				
		1.4MHz	3MHz	5MHz	10MHz	
3.8	-0.002	0.002	0.001	-0.005	-0.001	2.5
3.55	0.002	0.004	-0.003	-0.003	-0.003	2.5
4.35	0.001	-0.002	0.007	-0.004	-0.003	2.5

**NOTE:** The applicant defined the normal working voltage of the battery is from 3.55Vdc to 4.35Vdc.

##### FREQUENCY ERROR vs. TEMPERATURE

TEMP. (°C)	FREQUENCY ERROR (ppm)					LIMIT (ppm)
	CDMA	LTE Band 26				
		1.4MHz	3MHz	5MHz	10MHz	
-30	-0.002	-0.004	-0.004	-0.004	-0.007	2.5
-20	0.001	-0.004	-0.005	-0.006	-0.003	2.5
-10	-0.002	-0.002	-0.004	-0.007	-0.007	2.5
0	0.001	-0.004	-0.001	-0.001	0.002	2.5
10	-0.001	-0.011	0.005	-0.004	-0.005	2.5
20	-0.002	-0.002	-0.001	-0.005	-0.001	2.5
30	-0.002	-0.001	-0.002	-0.005	-0.005	2.5
40	-0.001	-0.009	0.002	-0.006	-0.001	2.5
50	-0.002	-0.002	-0.004	0.001	-0.002	2.5

### 4.3 OCCUPIED BANDWIDTH MEASUREMENT

#### 4.3.1 TEST PROCEDURES

The EUT makes a call to the communication simulator. All measurements were done at low, middle and high operational frequency range. The communication simulator station system controlled a EUT to export maximum output power under transmission mode and specific channel frequency. Use OBW measurement function of Spectrum analyzer to measure 99 % occupied bandwidth.

#### 4.3.2 TEST SETUP

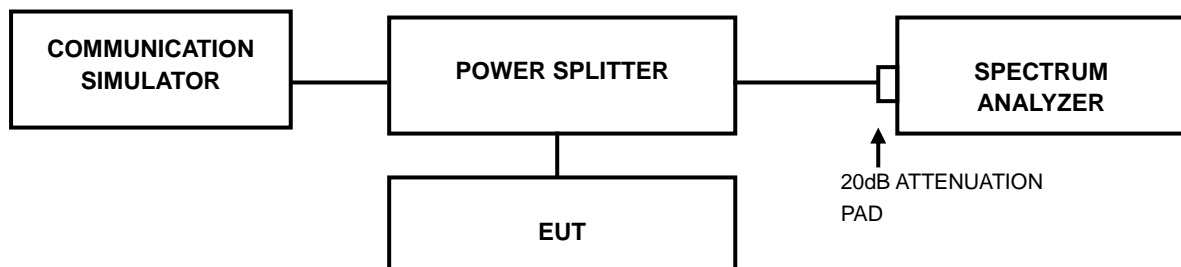





A D T

### 4.3.3 TEST RESULTS

CHANNEL	FREQUENCY (MHz)	99% OCCUPIED BANDWIDTH (MHz)
		CDMA
1013	824.70	1.2743
384	836.52	1.2739
777	848.31	1.2745

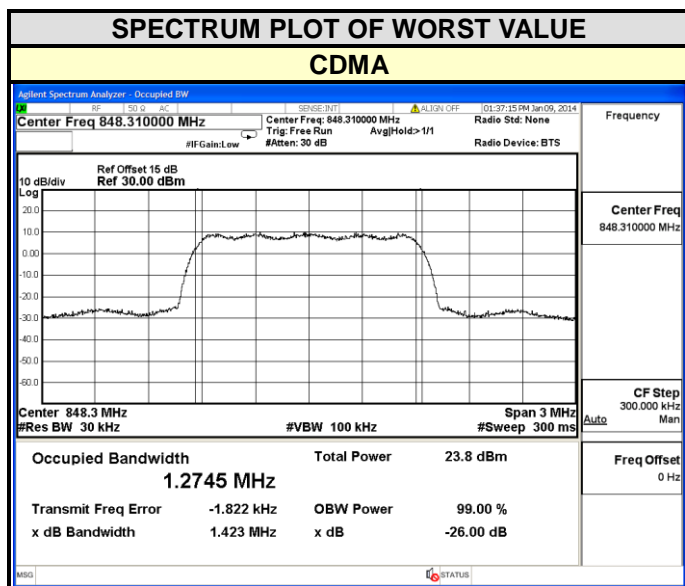



A D T

LTE BAND 26							
CHANNEL BANDWIDTH: 1.4MHz				CHANNEL BANDWIDTH: 3MHz			
CHANNEL	FREQUENCY (MHz)	99% OCCUPIED BANDWIDTH (MHz)		CHANNEL	FREQUENCY (MHz)	99% OCCUPIED BANDWIDTH (MHz)	
		QPSK	16QAM			QPSK	16QAM
26797	824.7	1.079	1.0766	26805	825.5	2.6789	2.6808
26915	836.5	1.0792	1.0763	26915	836.5	2.681	2.6796
27033	848.3	1.0783	1.0774	27025	847.5	2.6826	2.6788

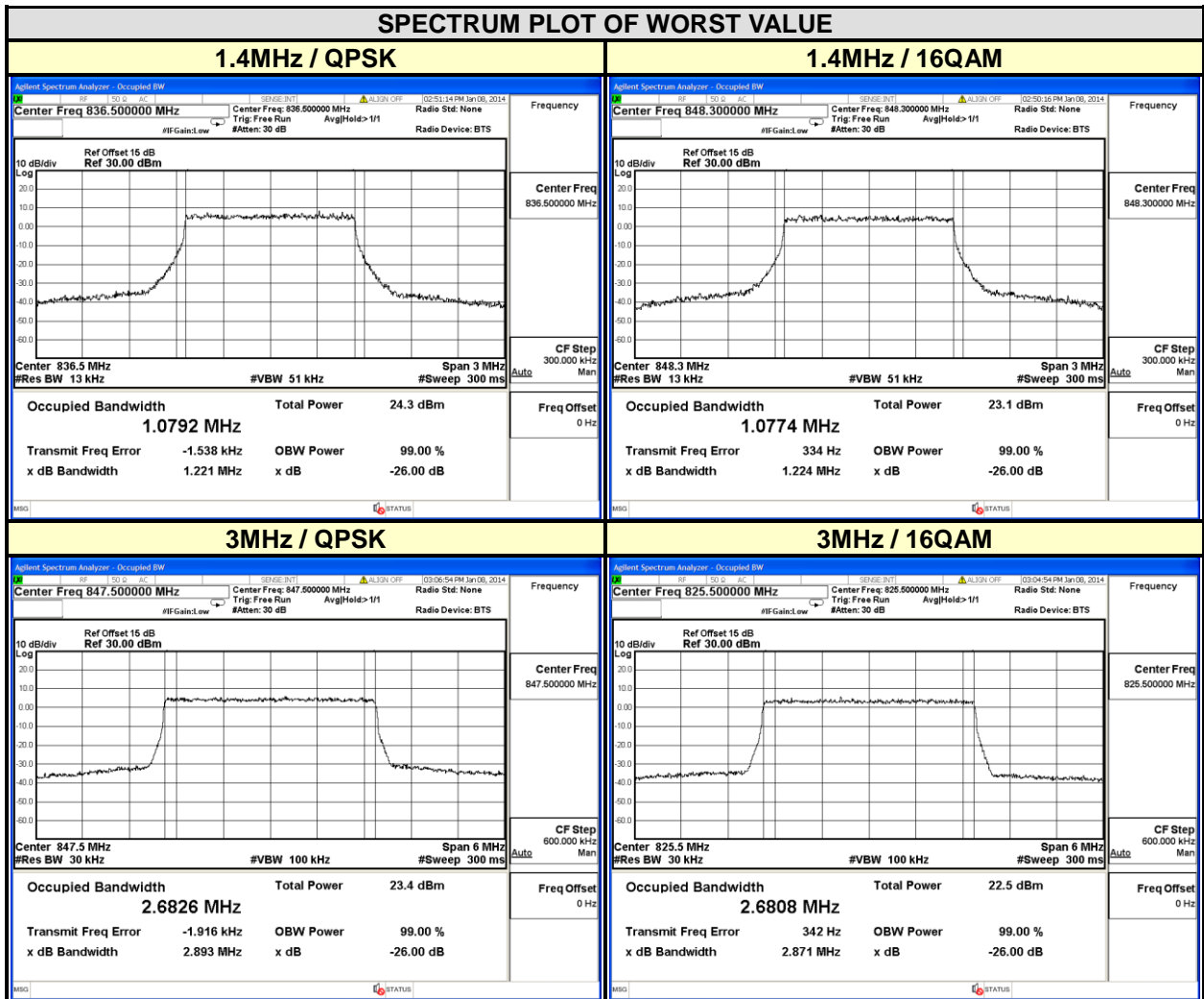



LTE BAND 26							
CHANNEL BANDWIDTH: 5MHz				CHANNEL BANDWIDTH: 10MHz			
CHANNEL	FREQUENCY (MHz)	99% OCCUPIED BANDWIDTH (MHz)		CHANNEL	FREQUENCY (MHz)	99% OCCUPIED BANDWIDTH (MHz)	
		QPSK	16QAM			QPSK	16QAM
26815	826.5	4.4864	4.4863	26840	829	8.9275	8.9336
26915	836.5	4.4909	4.4887	26915	836.5	8.9319	8.9261
27015	846.5	4.4904	4.4883	26990	844	8.9256	8.9277

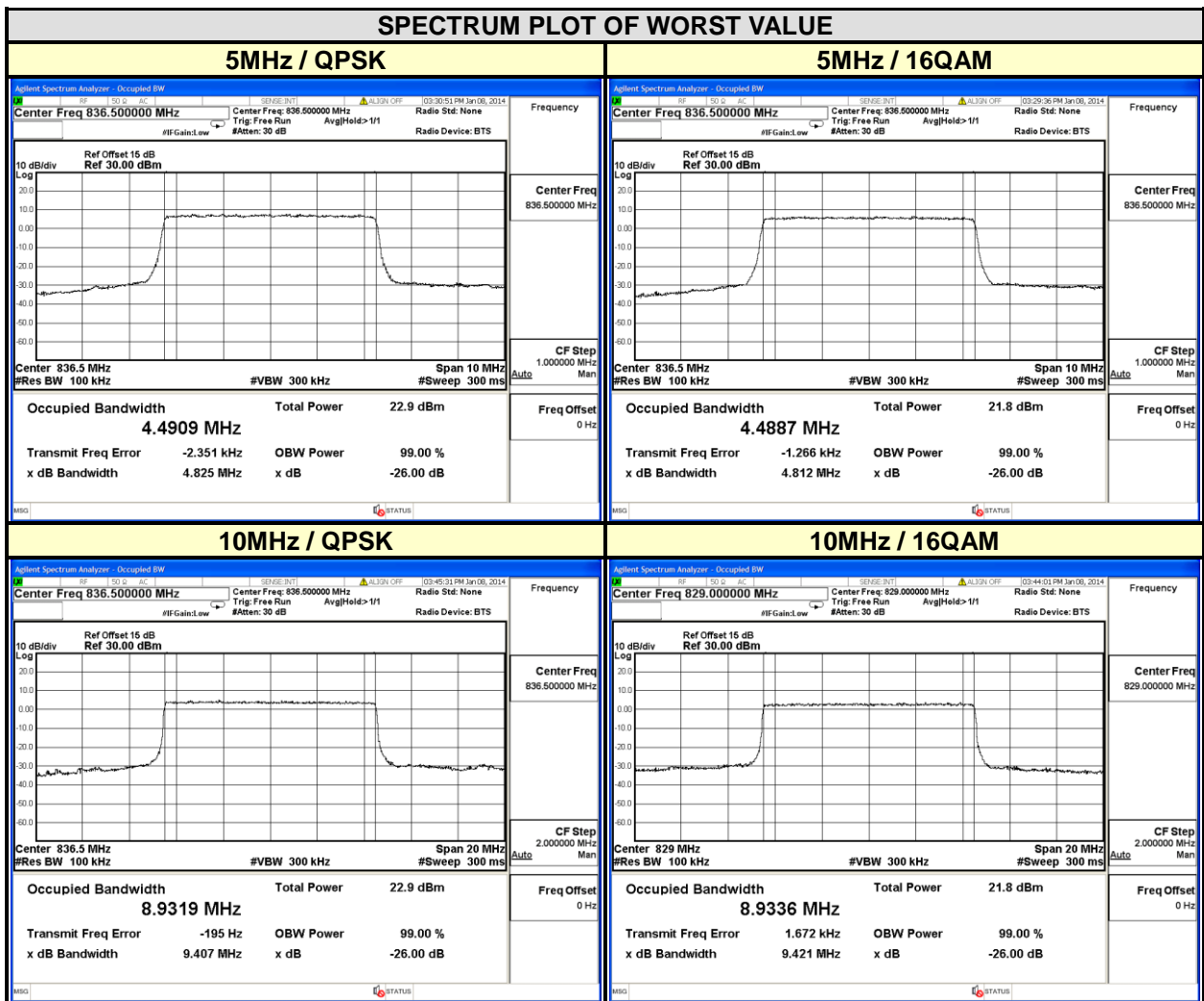

## 4.4 BAND EDGE MEASUREMENT

### 4.4.1 LIMITS OF BAND EDGE MEASUREMENT

Power of any emission outside of the authorized operating frequency ranges must be attenuated below the transmitting power (P) by a factor of at least  $43 + 10 \log(P)$  dB. In the 1 MHz bands immediately outside and adjacent to the frequency block a resolution bandwidth of at least one percent of the emission bandwidth of the fundamental emission of the transmitter may be employed.

### 4.4.2 TEST SETUP

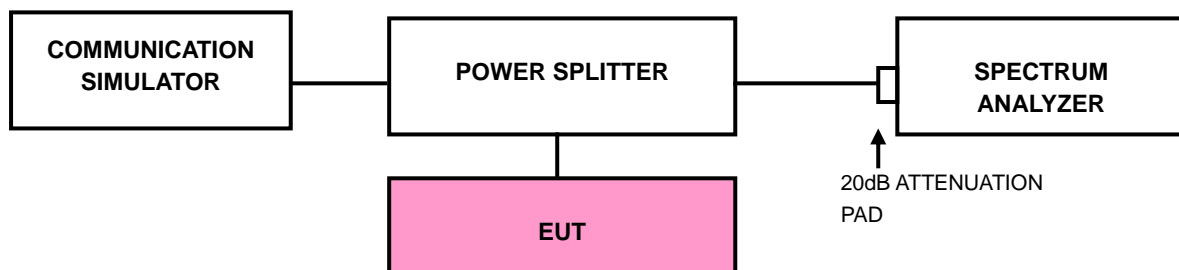

### 4.4.3 TEST PROCEDURES

- a. All measurements were done at low and high operational frequency range.
- b. The center frequency of spectrum is the band edge frequency and span is 1MHz. RB of the spectrum is 13kHz and VB of the spectrum is 51kHz (CDMA / LTE Channel Bandwidth 1.4MHz).
- c. The center frequency of spectrum is the band edge frequency and span is 1MHz. RB of the spectrum is 30kHz and VB of the spectrum is 100kHz (LTE Channel Bandwidth 3MHz).
- d. The center frequency of spectrum is the band edge frequency and span is 1MHz. RB of the spectrum is 100kHz and VB of the spectrum is 300kHz (LTE Channel Bandwidth 5MHz & 10MHz).
- e. Record the max trace plot into the test report.



A D T

### 4.4.4 TEST RESULTS

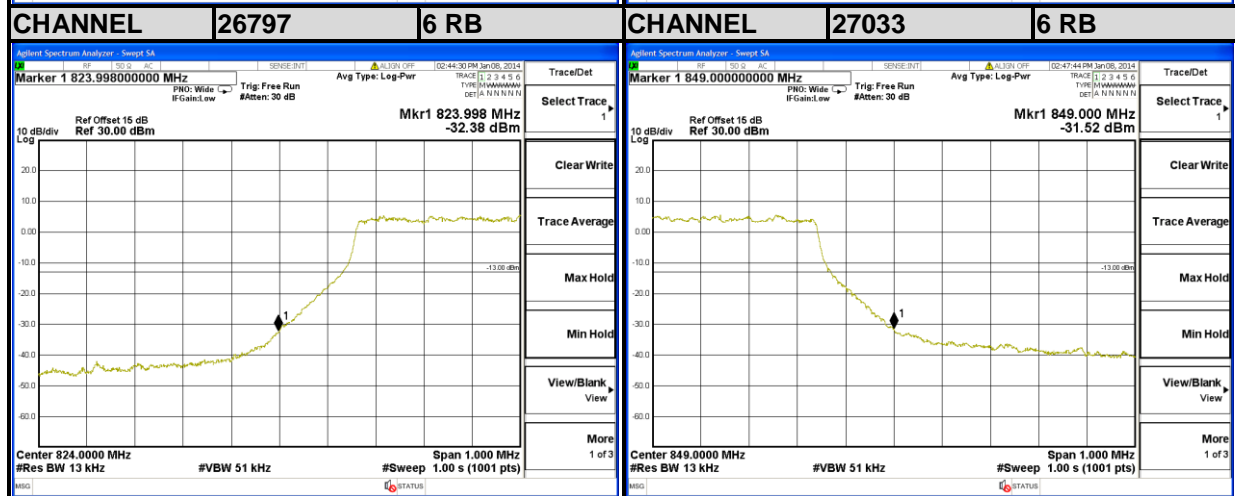
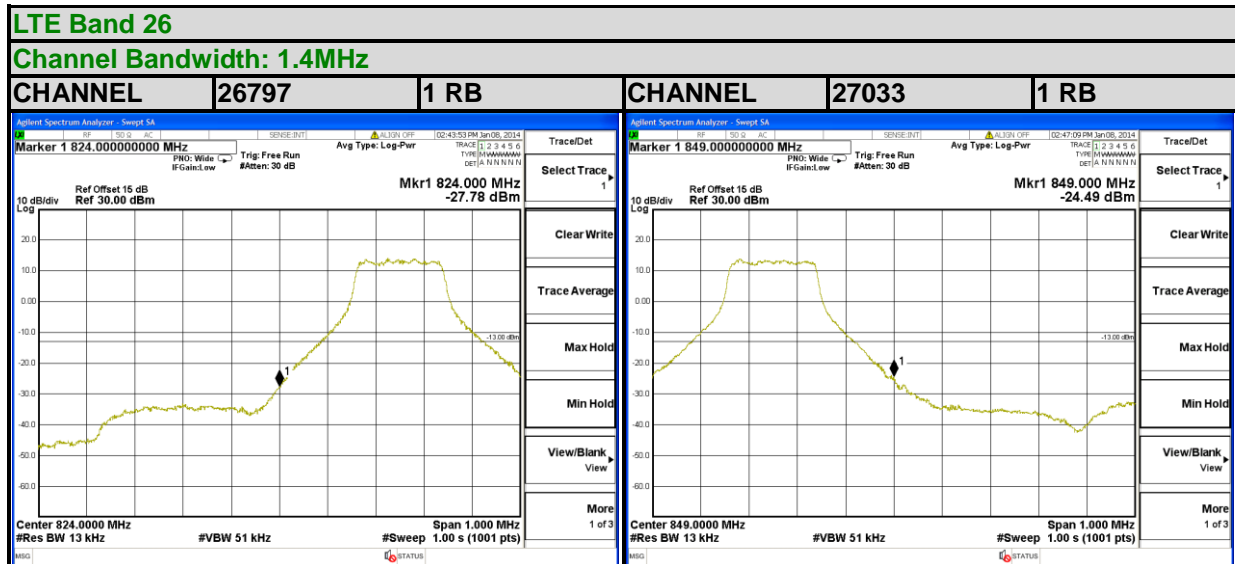
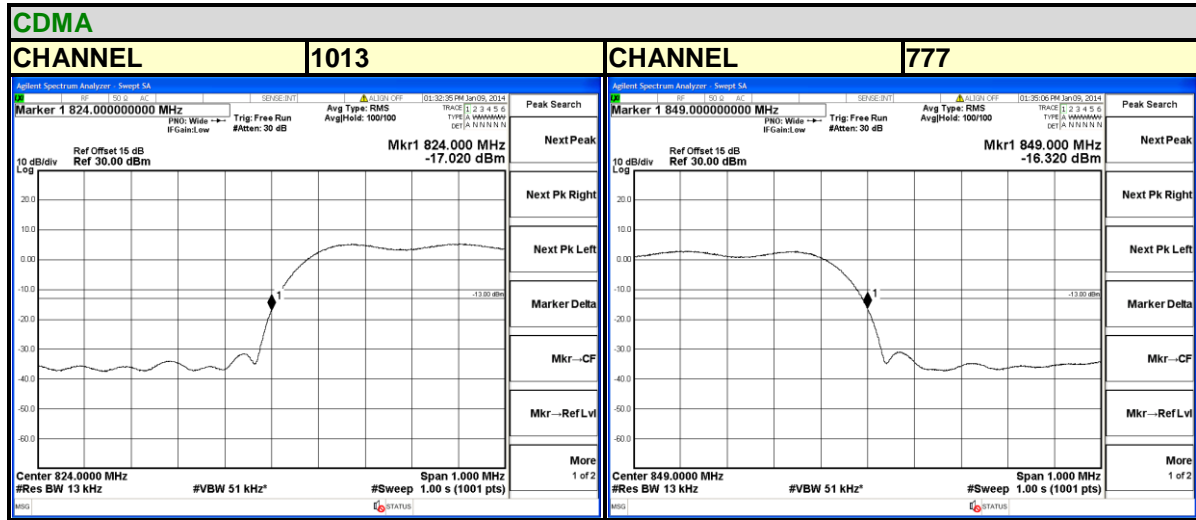



A D T

### LTE Band 26

### Channel Bandwidth: 3MHz

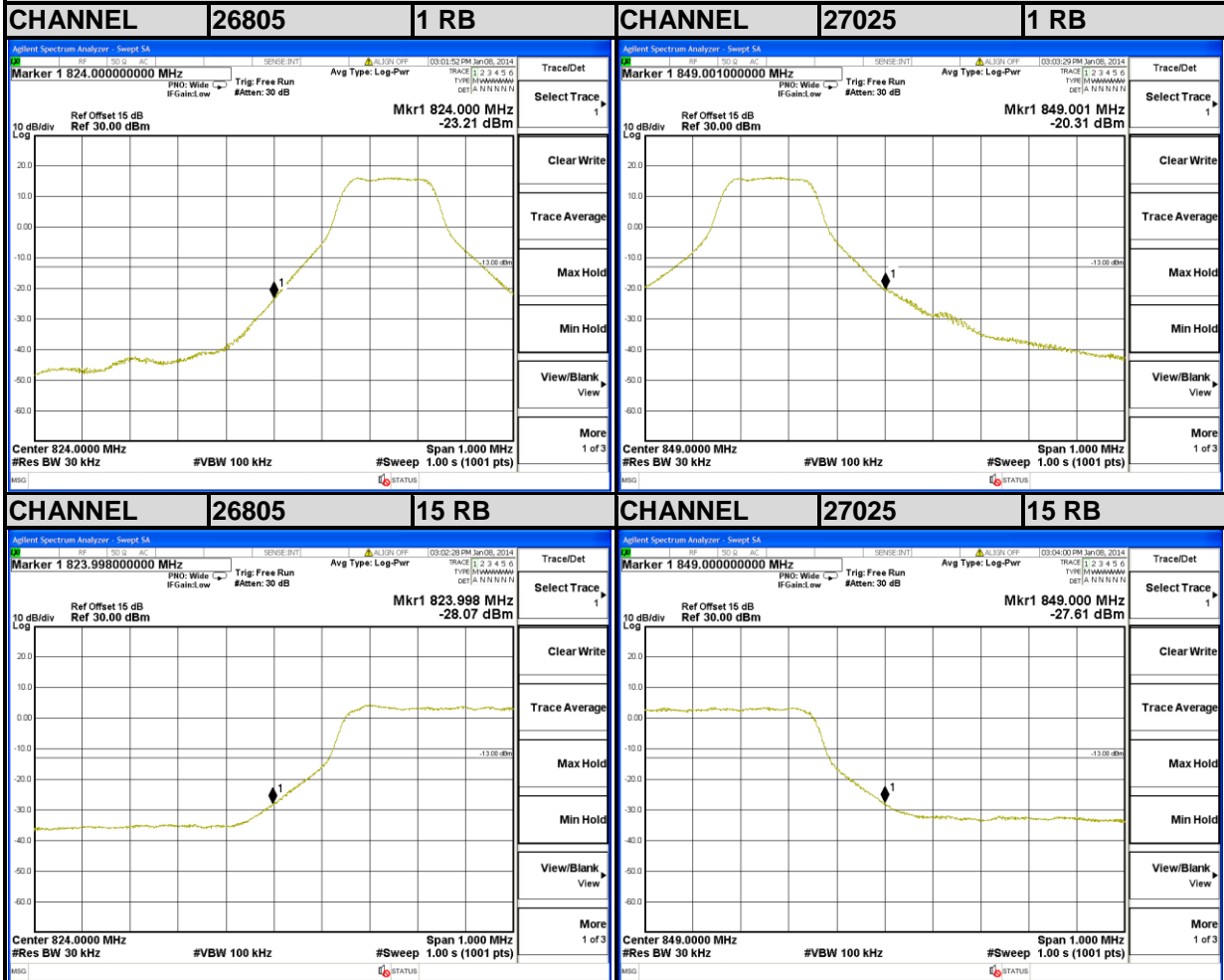



A D T

### LTE Band 26

### Channel Bandwidth: 5MHz

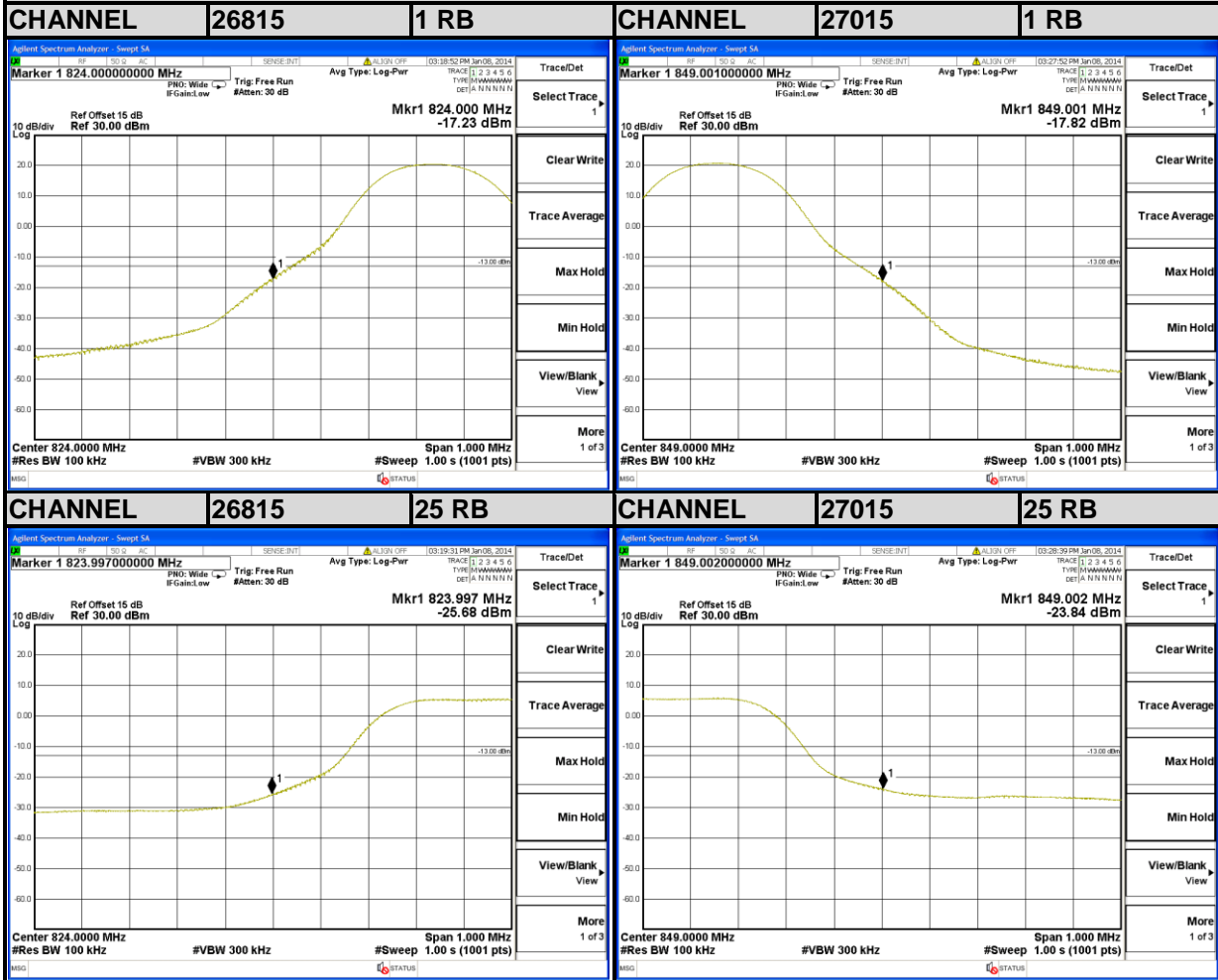



A D T

### LTE Band 26

### Channel Bandwidth: 10MHz

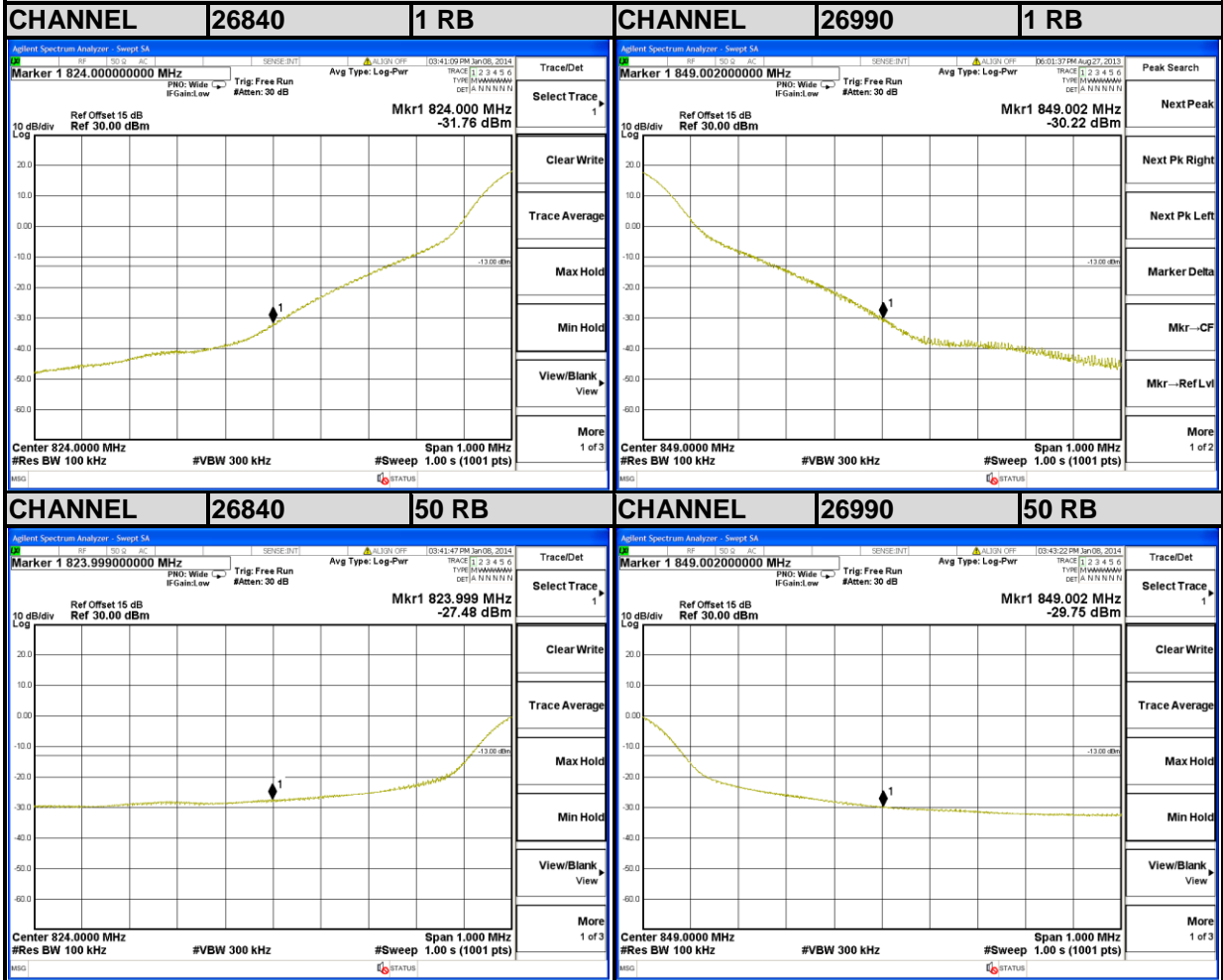



## 4.5 CONDUCTED SPURIOUS EMISSIONS

### 4.5.1 LIMITS OF CONDUCTED SPURIOUS EMISSIONS MEASUREMENT

The power of any emission outside of the authorized operating frequency ranges must be attenuated below the transmitting power (P) by a factor of at least  $43 + 10 \log(P)$  dB. The emission limit equal to  $-13\text{dBm}$ .

### 4.5.2 TEST PROCEDURE

- a. The EUT makes a phone call to the communication simulator. All measurements were done at low, middle and high operational frequency range.
- b. Measuring frequency range is from 30 MHz to 9GHz. 10dB attenuation pad is connected with spectrum. RBW=1MHz and VBW=3MHz is used for conducted emission measurement.

### 4.5.3 TEST SETUP

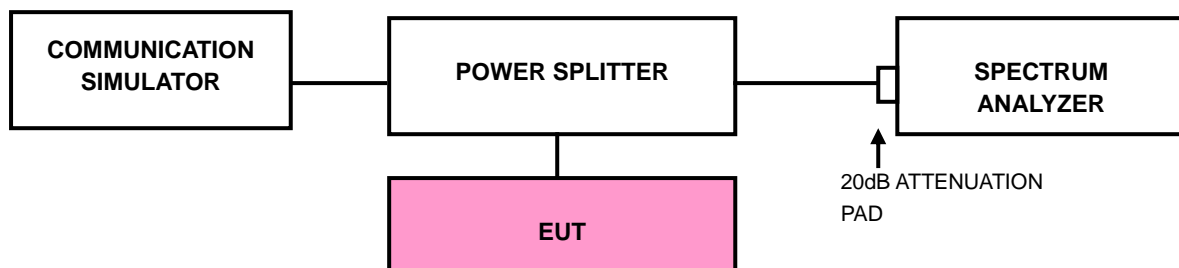

### 4.5.4 TEST RESULTS

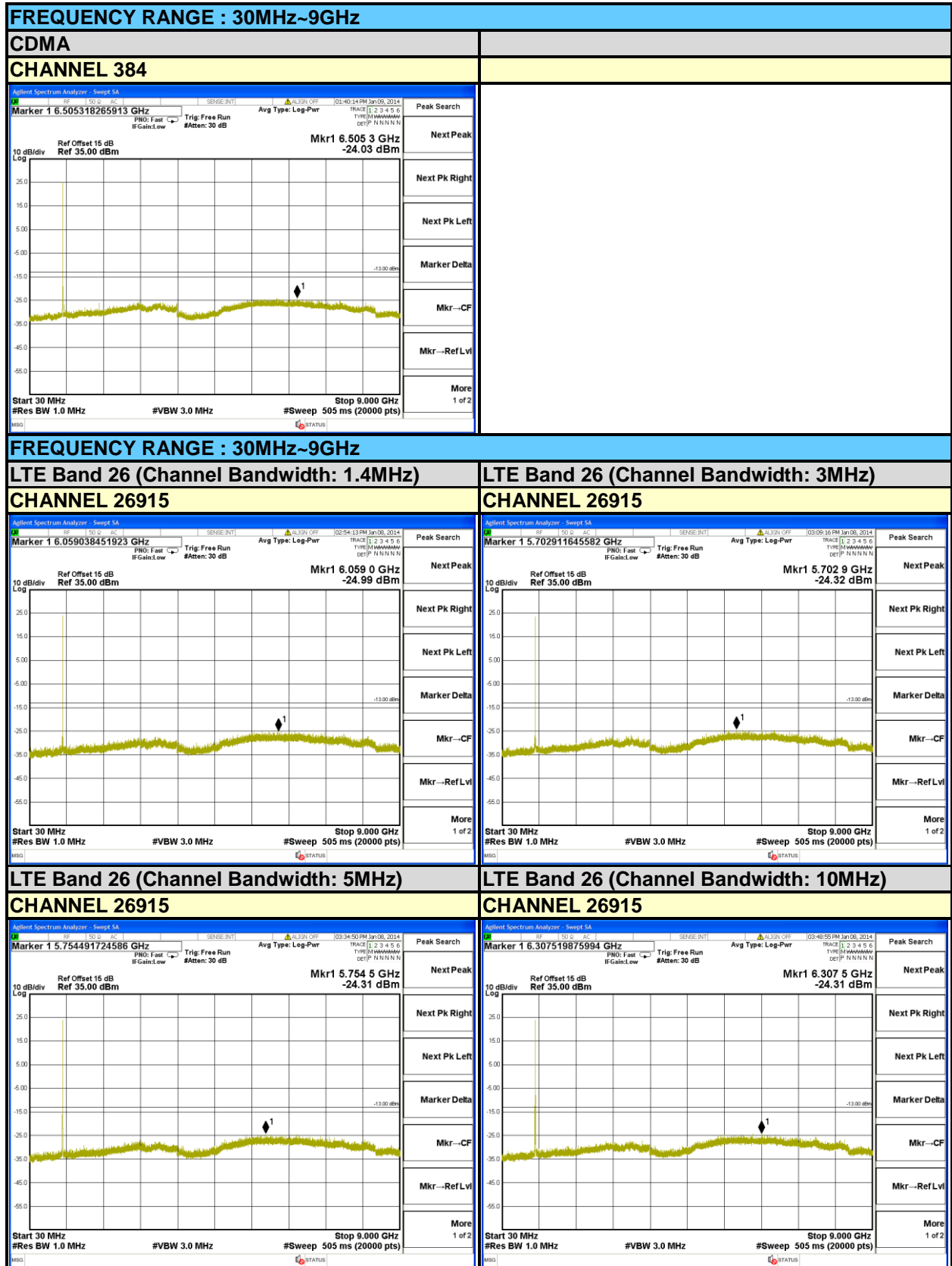

## 4.6 RADIATED EMISSION MEASUREMENT

### 4.6.1 LIMITS OF RADIATED EMISSION MEASUREMENT

The power of any emission outside of the authorized operating frequency ranges must be attenuated below the transmitting power (P) by a factor of at least  $43 + 10 \log(P)$  dB. The emission limit equal to  $-13\text{dBm}$ .

### 4.6.2 TEST PROCEDURES

- a. Substitution method is used for E.I.R.P measurement. In the semi-anechoic chamber, EUT placed on the 0.8m height of Turn Table, rotated the table around 360 degrees to search the maximum radiation power and receiver antenna shall be rotated vertical and horizontal polarization and moved height from 1m to 4m to find the maximum polar radiated power. The “Read Value” is the spectrum reading the maximum power value.
- b. The substitution horn antenna is substituted for EUT at the same position and signals generator export the CW signal to the substitution antenna via a TX cable. Rotated the Turn Table and moved receiving antenna to find the maximum radiation power. Adjust output power level of S.G to get a Value of spectrum reading equal to “Read Value” of step a. Record the power level of S.G
- c.  $\text{EIRP} = \text{Output power level of S.G} - \text{TX cable loss} + \text{Antenna gain of substitution horn.}$
- d. E.R.P power can be calculated form E.I.R.P power by subtracting the gain of dipole,  
 $\text{E.R.P power} = \text{E.I.R.P power} - 2.15\text{dBi.}$

**NOTE:** The resolution bandwidth and video bandwidth of test receiver/spectrum analyzer is 1MHz/3MHz.

### 4.6.3 DEVIATION FROM TEST STANDARD

No deviation

#### 4.6.4 TEST SETUP

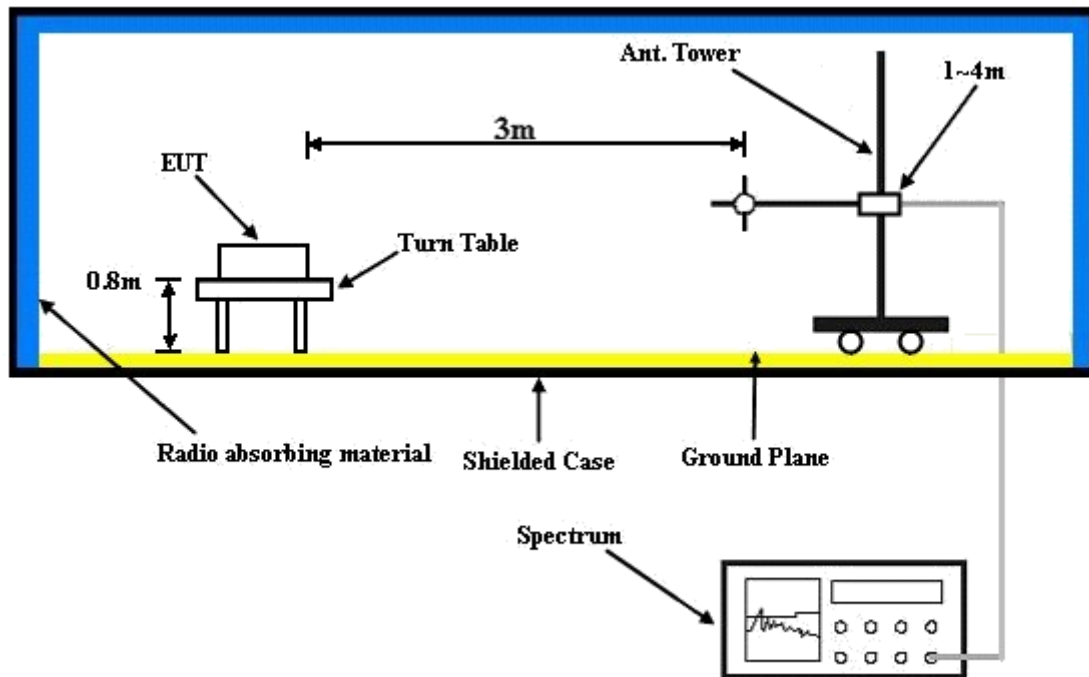

For the actual test configuration, please refer to the attached file (Test Setup Photo).

### 4.6.5 TEST RESULTS

#### CDMA:



Bureau Veritas Consumer Products Services Ltd., Taoyuan Branch

A D T

Data: 9

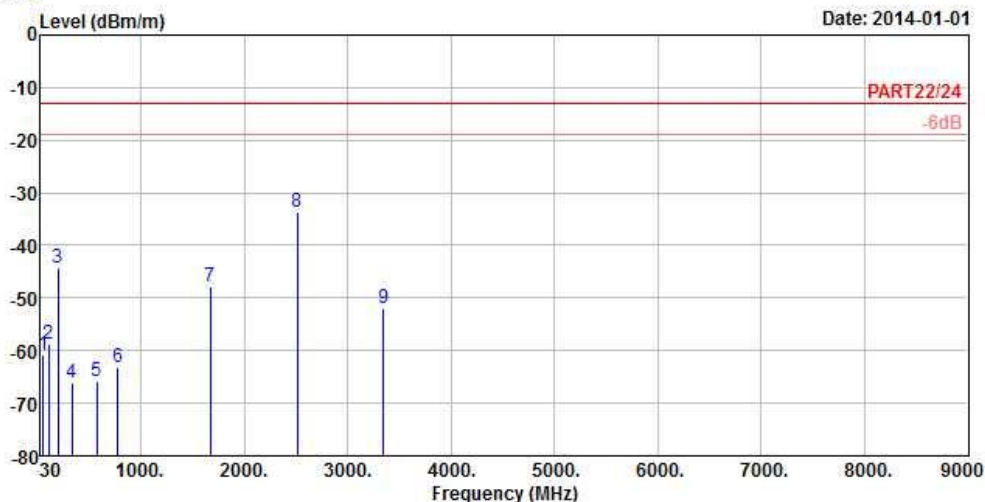

Site : 966 Chamber 5  
 Condition : PART22/24 3m HORIZONTAL  
 Brand/Model: 0P6B700  
 Remark : 1xRTT850 Link  
 Tested by : Anson Lin  
 Temperature : 25°C  
 Humidity : 65%  
 Plane : X

	Read	Limit	Over			
Freq	Level	Level	Line	Limit	Factor	Remark
MHz	dBm/m	dBm	dBm/m	dB	dB/m	
1	56.46	-60.83	-55.33	-13.00	-47.83	-5.50 Peak
2	107.49	-58.89	-48.32	-13.00	-45.89	-10.57 Peak
3	199.02	-44.29	-36.45	-13.00	-31.29	-7.84 Peak
4	332.20	-66.07	-59.93	-13.00	-53.07	-6.14 Peak
5	571.60	-65.89	-64.74	-13.00	-52.89	-1.15 Peak
6	775.30	-63.29	-65.25	-13.00	-50.29	1.96 Peak
7	1673.04	-47.79	-33.95	-13.00	-34.79	-13.84 Peak
8 pp	2509.56	-33.74	-23.75	-13.00	-20.74	-9.99 Peak
9	3346.08	-52.08	-42.72	-13.00	-39.08	-9.36 Peak



A D T



Bureau Veritas Consumer Products Services Ltd., Taoyuan Branch

A D T

Data: 10

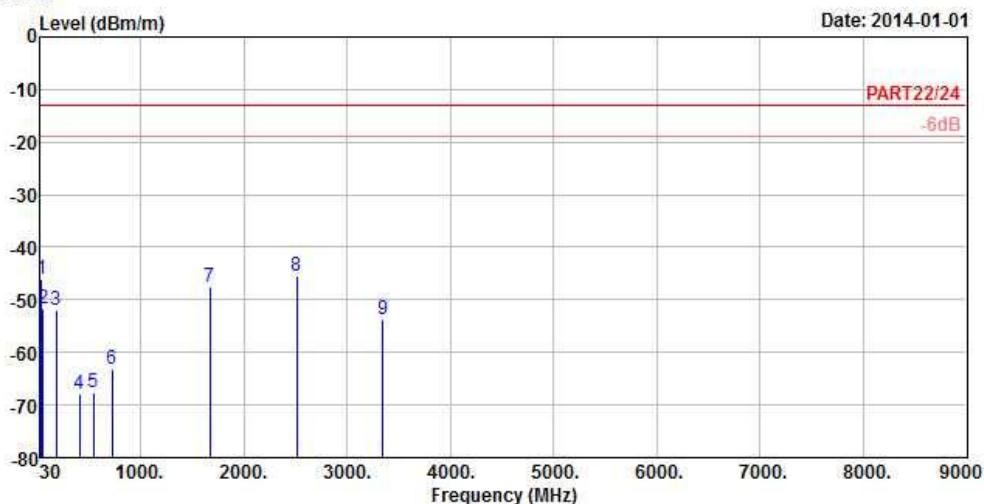

Site : 966 Chamber 5  
 Condition : PART22/24 3m VERTICAL  
 Brand/Model: 0P6B700  
 Remark : 1xRTT850 Link  
 Tested by : Anson Lin  
 Temperature : 25°C  
 Humidity : 65%  
 Plane : X

	Freq	Level	Read Level	Limit Line	Over Limit	Factor	Remark
	MHz	dBm/m	dBm	dBm/m	dB	dB/m	
1	39.18	-46.19	-44.45	-13.00	-33.19	-1.74	Peak
2	58.08	-51.79	-45.99	-13.00	-38.79	-5.80	Peak
3	182.01	-52.01	-46.11	-13.00	-39.01	-5.90	Peak
4	408.50	-67.97	-62.55	-13.00	-54.97	-5.42	Peak
5	545.70	-67.74	-65.90	-13.00	-54.74	-1.84	Peak
6	724.90	-63.30	-64.92	-13.00	-50.30	1.62	Peak
7	1673.04	-47.42	-33.58	-13.00	-34.42	-13.84	Peak
8 pp	2509.56	-45.55	-35.56	-13.00	-32.55	-9.99	Peak
9	3346.08	-53.62	-44.26	-13.00	-40.62	-9.36	Peak

**LTE BAND 26**  
**CHANNEL BANDWIDTH: 1.4MHz / QPSK**



Bureau Veritas Consumer Products Services Ltd., Taoyuan Branch

A D T

Data: 9

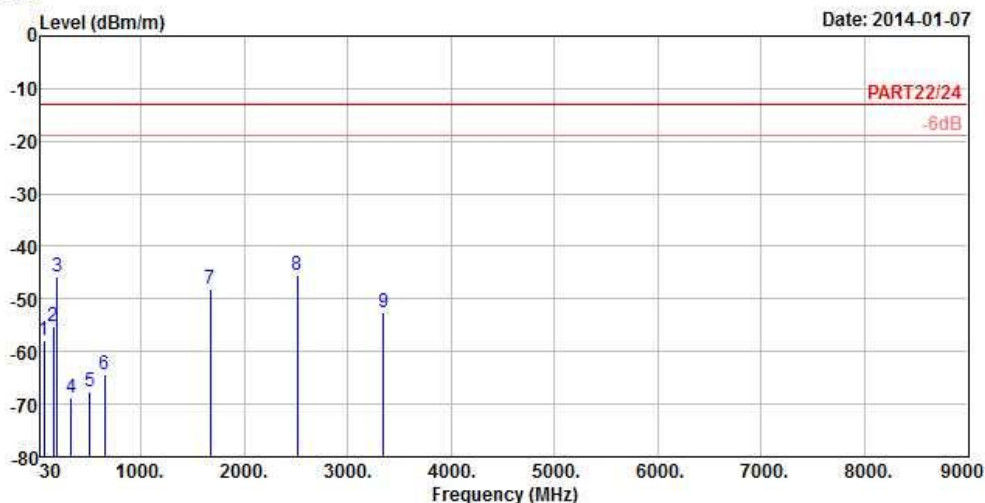

Site : 966 Chamber 5  
 Condition : PART22/24 3m HORIZONTAL  
 Brand/Model: 0P6B700  
 Remark : Band 26\_1.4M\_QPSK(1,2) Link  
 Tested by : Anson Lin  
 Temperature : 25°C  
 Humidity : 65%  
 Plane : Z

	Freq	Level	Read	Limit	Over		
	MHz	dBm/m	Level	Line	Limit	Factor	Remark
			dBm	dBm/m	dB	dB/m	
1	63.48	-57.71	-50.31	-13.00	-44.71	-7.40	Peak
2	152.04	-55.29	-48.90	-13.00	-42.29	-6.39	Peak
3	188.76	-45.66	-38.96	-13.00	-32.66	-6.70	Peak
4	327.30	-68.75	-62.57	-13.00	-55.75	-6.18	Peak
5	503.00	-67.72	-64.71	-13.00	-54.72	-3.01	Peak
6	646.50	-64.33	-64.82	-13.00	-51.33	0.49	Peak
7	1673.00	-48.04	-34.20	-13.00	-35.04	-13.84	Peak
8 pp	2509.50	-45.38	-35.39	-13.00	-32.38	-9.99	Peak
9	3346.00	-52.54	-43.18	-13.00	-39.54	-9.36	Peak





A D T



### Bureau Veritas Consumer Products Services Ltd., Taoyuan Branch

A D T

Data: 10

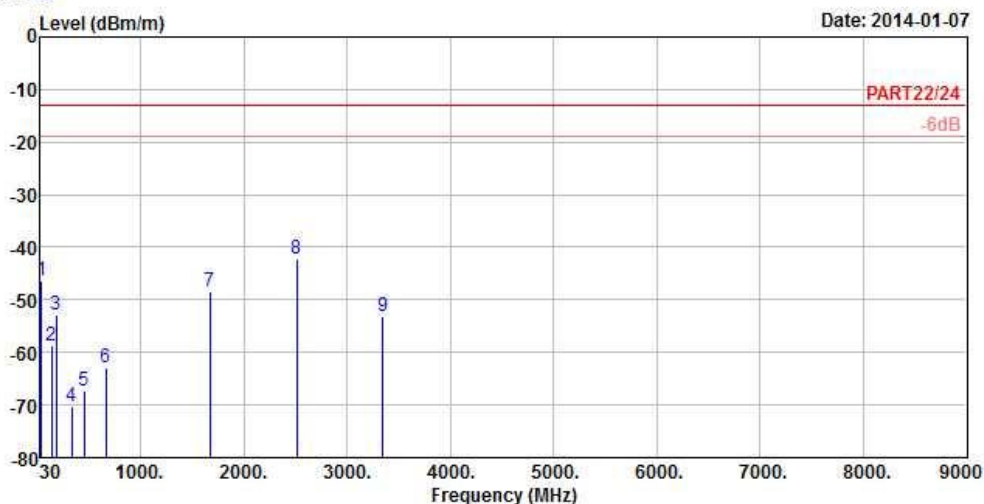

Site : 966 Chamber 5  
 Condition : PART22/24 3m VERTICAL  
 Brand/Model: 0P6B700  
 Remark : Band 26\_1.4M\_QPSK(1,2) Link  
 Tested by : Anson Lin  
 Temperature : 25°C  
 Humidity : 65%  
 Plane : Z

	Freq	Level	Read Level	Limit Line	Over Limit	Factor	Remark
	MHz	dBm/m	dBm	dBm/m	dB	dB/m	
1	39.18	-46.46	-44.72	-13.00	-33.46	-1.74	Peak
2	139.08	-58.84	-52.91	-13.00	-45.84	-5.93	Peak
3	182.55	-52.72	-46.82	-13.00	-39.72	-5.90	Peak
4	333.60	-70.17	-64.04	-13.00	-57.17	-6.13	Peak
5	454.00	-67.25	-62.98	-13.00	-54.25	-4.27	Peak
6	666.10	-62.91	-63.75	-13.00	-49.91	0.84	Peak
7	1673.00	-48.36	-34.52	-13.00	-35.36	-13.84	Peak
8 pp	2509.50	-42.08	-32.09	-13.00	-29.08	-9.99	Peak
9	3346.00	-53.24	-43.88	-13.00	-40.24	-9.36	Peak



**CHANNEL BANDWIDTH: 3MHz / QPSK**



Bureau Veritas Consumer Products Services Ltd., Taoyuan Branch

A D T

Data: 5

Date: 2014-01-07

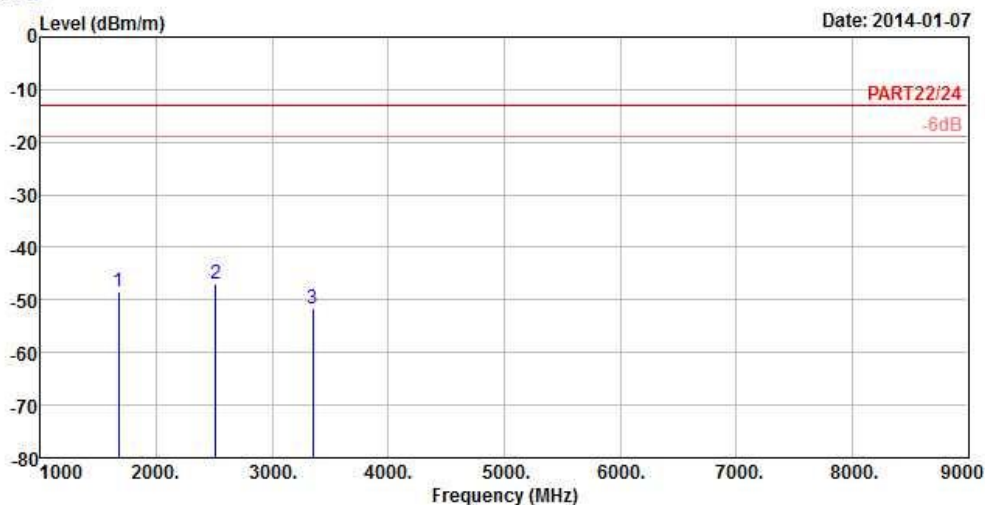

Site : 966 Chamber 5  
 Condition : PART22/24 3m HORIZONTAL  
 Brand/Model: 0P6B700  
 Remark : Band 26\_3M\_QPSK(1,7) Link  
 Tested by : Anson Lin  
 Temperature : 25°C  
 Humidity : 65%  
 Plane : Z

	Freq	Level	Read Level	Limit Line	Over Limit	Factor	Remark
	MHz	dBm/m	dBm	dBm/m	dB	dB/m	
1	1673.00	-48.28	-34.44	-13.00	-35.28	-13.84	Peak
2	2509.50	-47.03	-37.04	-13.00	-34.03	-9.99	Peak
3	3346.00	-51.78	-42.42	-13.00	-38.78	-9.36	Peak



A D T



### Bureau Veritas Consumer Products Services Ltd., Taoyuan Branch

A D T

Data: 6

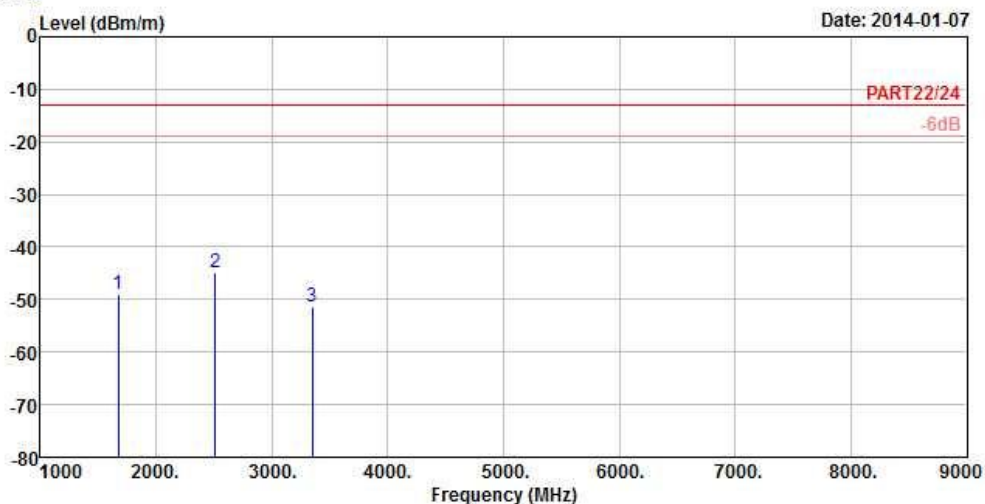

Site : 966 Chamber 5  
 Condition : PART22/24 3m VERTICAL  
 Brand/Model: 0P6B700  
 Remark : Band 26\_3M\_QPSK(1,7) Link  
 Tested by : Anson Lin  
 Temperature : 25°C  
 Humidity : 65%  
 Plane : Z

	Freq	Level	Read Level	Limit Line	Over Limit	Factor	Remark
	MHz	dBm/m	dBm	dBm/m	dB	dB/m	
1	1673.00	-48.93	-35.09	-13.00	-35.93	-13.84	Peak
2 pp	2509.50	-44.78	-34.79	-13.00	-31.78	-9.99	Peak
3	3346.00	-51.25	-41.89	-13.00	-38.25	-9.36	Peak

**CHANNEL BANDWIDTH: 5MHz / QPSK**



Bureau Veritas Consumer Products Services Ltd., Taoyuan Branch

A D T

Data: 5

Date: 2014-01-07

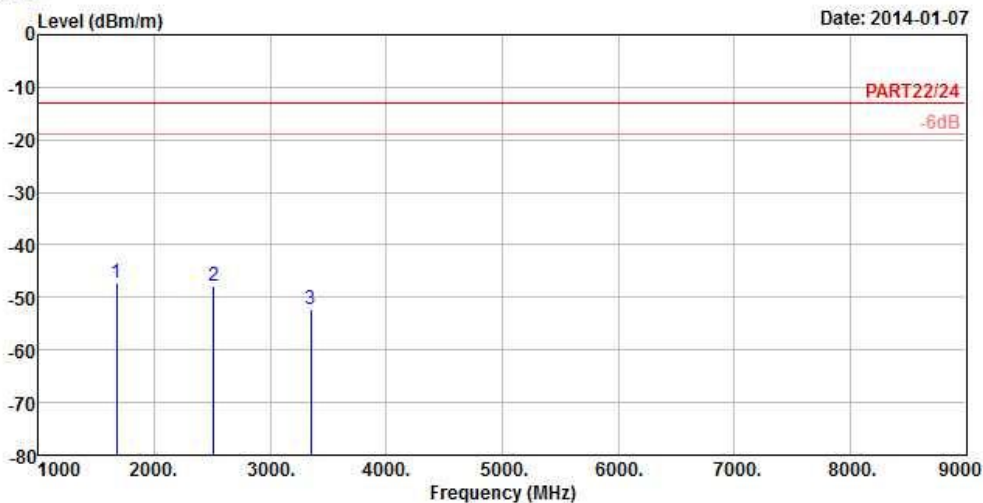

Site : 966 Chamber 5  
 Condition : PART22/24 3m HORIZONTAL  
 Brand/Model: 0P6B700  
 Remark : Band 26\_5M\_QPSK(1,12) Link  
 Tested by : Anson Lin  
 Temperature : 25°C  
 Humidity : 65%  
 Plane : Z

	Freq	Level	Read Level	Limit Line	Over Limit	Factor	Remark
	MHz	dBm/m	dBm	dBm/m	dB	dB/m	
1 pp	1673.00	-47.32	-33.48	-13.00	-34.32	-13.84	Peak
2	2509.50	-47.81	-37.82	-13.00	-34.81	-9.99	Peak
3	3346.00	-52.34	-42.98	-13.00	-39.34	-9.36	Peak



A D T



### Bureau Veritas Consumer Products Services Ltd., Taoyuan Branch

A D T

Data: 6

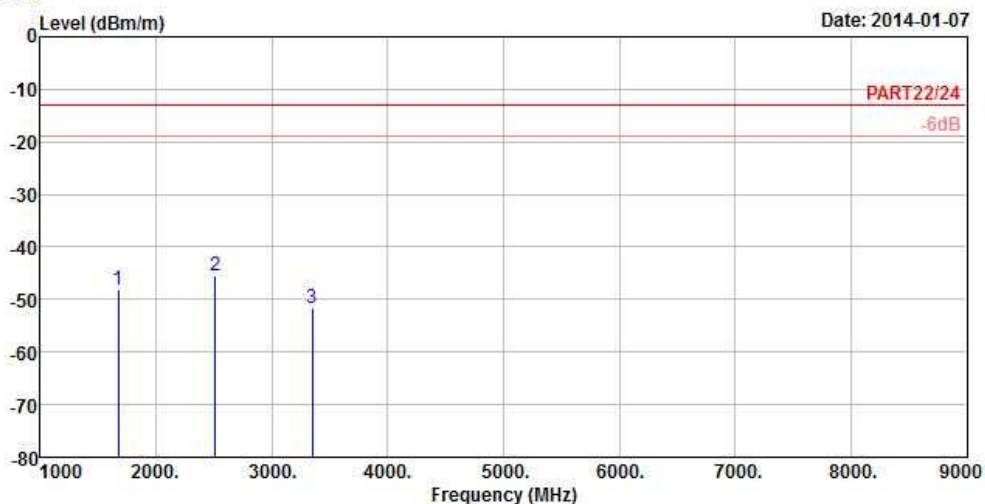

Site : 966 Chamber 5  
 Condition : PART22/24 3m VERTICAL  
 Brand/Model: 0P6B700  
 Remark : Band 26\_5M\_QPSK(1,12) Link  
 Tested by : Anson Lin  
 Temperature : 25°C  
 Humidity : 65%  
 Plane : Z

	Freq	Level	Read Level	Limit Line	Over Limit	Factor	Remark
	MHz	dBm/m	dBm	dBm/m	dB	dB/m	
1	1673.00	-48.19	-34.35	-13.00	-35.19	-13.84	Peak
2 pp	2509.50	-45.39	-35.40	-13.00	-32.39	-9.99	Peak
3	3346.00	-51.64	-42.28	-13.00	-38.64	-9.36	Peak

**CHANNEL BANDWIDTH: 10MHz / QPSK**



Bureau Veritas Consumer Products Services Ltd., Taoyuan Branch

A D T

Data: 5

Date: 2014-01-07

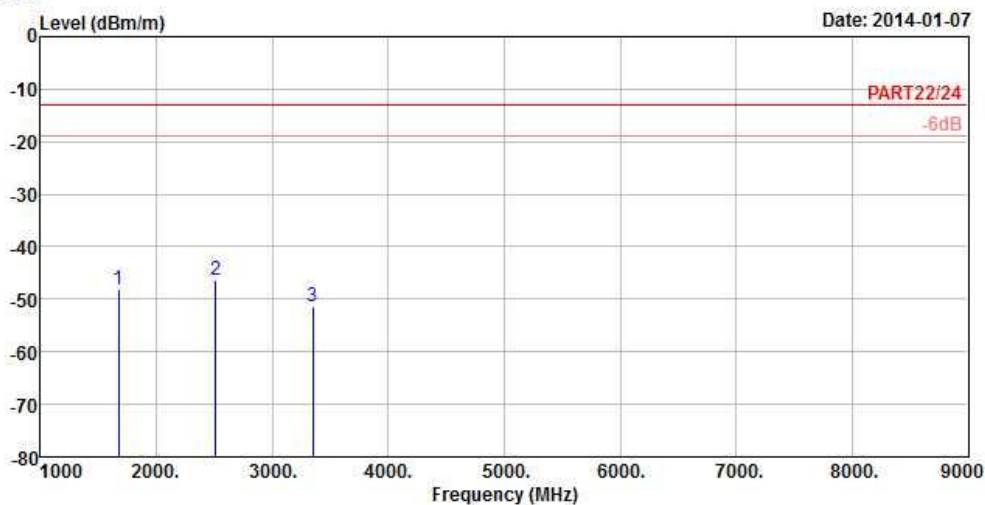

Site : 966 Chamber 5  
 Condition : PART22/24 3m HORIZONTAL  
 Brand/Model: 0P6B700  
 Remark : Band 26\_10M\_QPSK(1,24) Link  
 Tested by : Anson Lin  
 Temperature : 25°C  
 Humidity : 65%  
 Plane : Z

	Freq	Level	Read Level	Limit Line	Over Limit	Factor	Remark
	MHz	dBm/m	dBm	dBm/m	dB	dB/m	
1	1673.00	-48.22	-34.38	-13.00	-35.22	-13.84	Peak
2	2509.50	-46.31	-36.32	-13.00	-33.31	-9.99	Peak
3	3346.00	-51.37	-42.01	-13.00	-38.37	-9.36	Peak



A D T



### Bureau Veritas Consumer Products Services Ltd., Taoyuan Branch

A D T

Data: 6

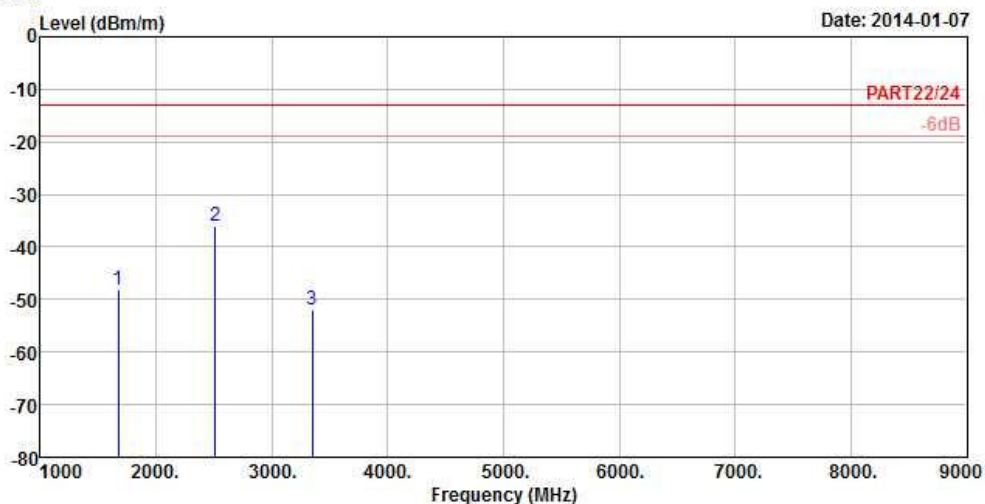

Site : 966 Chamber 5  
 Condition : PART22/24 3m VERTICAL  
 Brand/Model: 0P6B700  
 Remark : Band 26\_10M\_QPSK(1,24) Link  
 Tested by : Anson Lin  
 Temperature : 25°C  
 Humidity : 65%  
 Plane : Z

	Freq	Level	Read Level	Limit Line	Over Limit	Factor	Remark
	MHz	dBm/m	dBm	dBm/m	dB	dB/m	
1	1673.00	-48.14	-34.30	-13.00	-35.14	-13.84	Peak
2 pp	2509.50	-36.14	-26.15	-13.00	-23.14	-9.99	Peak
3	3346.00	-52.04	-42.68	-13.00	-39.04	-9.36	Peak



A D T

## 5 PHOTOGRAPHS OF THE TEST CONFIGURATION

Please refer to the attached file (Test Setup Photo).



## 6 INFORMATION ON THE TESTING LABORATORIES

We, Bureau Veritas Consumer Products Services (H.K.) Ltd., Taoyuan Branch, were founded in 1988 to provide our best service in EMC, Radio, Telecom and Safety consultation. Our laboratories are accredited and approved according to ISO/IEC 17025.

If you have any comments, please feel free to contact us at the following:

**Linko EMC/RF Lab:**

Tel: 886-2-26052180

Fax: 886-2-26051924

**Hsin Chu EMC/RF Lab:**

Tel: 886-3-5935343

Fax: 886-3-5935342

**Hwa Ya EMC/RF/Safety/Telecom Lab:**

Tel: 886-3-3183232

Fax: 886-3-3270892

**Email:** [service.adt@tw.bureauveritas.com](mailto:service.adt@tw.bureauveritas.com)

**Web Site:** [www.bureauveritas-adt.com](http://www.bureauveritas-adt.com)

The address and road map of all our labs can be found in our web site also.





A D T

## **7 APPENDIX A – MODIFICATIONS RECORDERS FOR ENGINEERING CHANGES TO THE EUT BY THE LAB**

No any modifications were made to the EUT by the lab during the test.

**---END---**