



# FCC TEST REPORT (PART 27)

**REPORT NO.:** RF131023C29-7

**MODEL NO.:** 0P6B200

**FCC ID:** NM80P6B200

**RECEIVED:** Oct. 23, 2013

**TESTED:** Dec. 20, 2013 ~ Dec. 28, 2013

**ISSUED:** Jan. 09, 2014

**APPLICANT:** HTC Corporation

**ADDRESS:** No. 23,Xinghua Rd.,Taoyuan 330,Taiwan,R.O.C.

**ISSUED BY:** Bureau Veritas Consumer Products Services  
(H.K.) Ltd., Taoyuan Branch

**LAB ADDRESS:** No. 47, 14th Ling, Chia Pau Vil., Lin Kou Dist.,  
New Taipei City, Taiwan, R.O.C.

**TEST LOCATION:** No. 19, Hwa Ya 2nd Rd, Wen Hwa Tsuen, Kwei  
Shan Hsiang, Taoyuan Hsien 333, Taiwan, R.O.C.

This report should not be used by the client to claim product certification, approval, or endorsement by TAF or any government agencies.



This report is for your exclusive use. Any copying or replication of this report to or for any other person or entity, or use of our name or trademark, is permitted only with our prior written permission. This report sets forth our findings solely with respect to the test samples identified herein. The results set forth in this report are not indicative or representative of the quality or characteristics of the lot from which a test sample was taken or any similar or identical product unless specifically and expressly noted. Our report includes all of the tests requested by you and the results thereof based upon the information that you provided to us. You have 60 days from date of issuance of this report to notify us of any material error or omission caused by our negligence, provided, however, that such notice shall be in writing and shall specifically address the issue you wish to raise. A failure to raise such issue within the prescribed time shall constitute your unqualified acceptance of the completeness of this report, the tests conducted and the correctness of the report contents. Unless specifically mentioned, the uncertainty of measurement has been explicitly taken into account to declare the compliance or non-compliance to the specification.

## TABLE OF CONTENTS

RELEASE CONTROL RECORD.....	3
1 CERTIFICATION .....	4
2 SUMMARY OF TEST RESULTS.....	5
2.1 MEASUREMENT UNCERTAINTY .....	6
2.2 TEST SITE AND INSTRUMENTS .....	7
3 GENERAL INFORMATION .....	8
3.1 GENERAL DESCRIPTION OF EUT.....	8
3.2 CONFIGURATION OF SYSTEM UNDER TEST .....	10
3.3 DESCRIPTION OF SUPPORT UNITS.....	10
3.4 DESCRIPTION OF TEST MODES.....	11
3.5 GENERAL DESCRIPTION OF APPLIED STANDARDS .....	13
4 TEST TYPES AND RESULTS.....	14
4.1 OUTPUT POWER MEASUREMENT .....	14
4.1.1 LIMITS OF OUTPUT POWER MEASUREMENT .....	14
4.1.2 TEST PROCEDURES.....	14
4.1.3 TEST SETUP .....	15
4.1.4 TEST RESULTS .....	16
4.2 FREQUENCY STABILITY MEASUREMENT .....	25
4.2.1 LIMITS OF FREQUENCY STABILITY MEASUREMENT .....	25
4.2.2 TEST PROCEDURE .....	25
4.2.3 TEST SETUP .....	25
4.2.4 TEST RESULTS .....	26
4.3 OCCUPIED BANDWIDTH MEASUREMENT.....	27
4.3.1 LIMITS OF OCCUPIED BANDWIDTH MEASUREMENT.....	27
4.3.2 TEST SETUP .....	27
4.3.3 TEST PROCEDURES.....	27
4.3.4 TEST RESULTS .....	28
4.4 PEAK TO AVERAGE RATIO.....	31
4.4.1 LIMITS OF PEAK TO AVERAGE RATIO MEASUREMENT .....	31
4.4.2 TEST SETUP .....	31
4.4.3 TEST PROCEDURES.....	31
4.4.4 TEST RESULTS .....	32
4.5 BAND EDGE MEASUREMENT .....	35
4.5.1 LIMITS OF BAND EDGE MEASUREMENT .....	35
4.5.2 TEST SETUP .....	35
4.5.3 TEST PROCEDURES.....	36
4.5.4 TEST RESULTS .....	37
4.6 CONDUCTED SPURIOUS EMISSIONS.....	42
4.6.1 LIMITS OF CONDUCTED SPURIOUS EMISSIONS MEASUREMENT.....	42
4.6.2 TEST PROCEDURE .....	42
4.6.3 TEST SETUP .....	42
4.6.4 TEST RESULTS .....	43
4.7 RADIATED EMISSION MEASUREMENT .....	45
4.7.1 LIMITS OF RADIATED EMISSION MEASUREMENT .....	45
4.7.2 TEST PROCEDURES.....	45
4.7.3 DEVIATION FROM TEST STANDARD.....	45
4.7.4 TEST SETUP .....	46
4.7.5 TEST RESULTS .....	47
5 INFORMATION ON THE TESTING LABORATORIES .....	59
6 APPENDIX A – MODIFICATIONS RECORDERS FOR ENGINEERING CHANGES TO THE EUT BY THE LAB.....	60



A D T

## RELEASE CONTROL RECORD

ISSUE NO.	REASON FOR CHANGE	DATE ISSUED
RF131023C29-7	Original release	Jan. 09, 2014



# 1 CERTIFICATION

**PRODUCT:** Smartphone  
**MODEL NO.:** 0P6B200  
**BRAND:** HTC  
**APPLICANT:** HTC Corporation  
**TESTED:** Dec. 20, 2013 ~ Dec. 28, 2013  
**TEST SAMPLE:** Production Unit  
**TEST STANDARDS:** **FCC Part 27, Subpart C, L**  
**FCC Part 2**  
**ANSI C63.4-2003**

The above equipment (model: 0P6B200) has been tested by **Bureau Veritas Consumer Products Services (H.K.) Ltd., Taoyuan Branch**, and found compliance with the requirement of the above standards. The test record, data evaluation & Equipment Under Test (EUT) configurations represented herein are true and accurate accounts of the measurements of the sample's EMC characteristics under the conditions specified in this report.

**PREPARED BY** : Ivonne Wu , **DATE:** Jan. 09, 2014  
Ivonne Wu / Supervisor

**APPROVED BY** : Sam Chen , **DATE:** Jan. 09, 2014  
Sam Chen / Senior Project Engineer

## 2 SUMMARY OF TEST RESULTS

The EUT has been tested according to the following specifications:

LTE BAND 13			
STANDARD SECTION	TEST TYPE AND LIMIT	RESULT	REMARK
2.1046 27.50(C)(10)	Maximum Peak Output Power	PASS	Meet the requirement of limit.
2.1055 27.54	Frequency Stability	PASS	Meet the requirement of limit.
2.1049 27.53(g)	Occupied Bandwidth	PASS	Meet the requirement of limit.
27.50(d)(5)	Peak to average ratio	PASS	Meet the requirement of limit.
27.53(g)	Band Edge Measurements	PASS	Meet the requirement of limit.
2.1051 27.53(g)	Conducted Spurious Emissions	PASS	Meet the requirement of limit.
2.1053 27.53(g)	Radiated Spurious Emissions	PASS	Meet the requirement of limit. Minimum passing margin is -23.90dB at 2332.80MHz.

LTE Band 4			
STANDARD SECTION	TEST TYPE AND LIMIT	RESULT	REMARK
2.1046 27.50(d)(4)	Maximum Peak Output Power	PASS	Meet the requirement of limit.
2.1055 27.54	Frequency Stability	PASS	Meet the requirement of limit.
2.1049 27.53(h)	Occupied Bandwidth	PASS	Meet the requirement of limit.
27.50(d)(5)	Peak to average ratio	PASS	Meet the requirement of limit.
27.53(h)	Band Edge Measurements	PASS	Meet the requirement of limit.
2.1051 27.53(h)	Conducted Spurious Emissions	PASS	Meet the requirement of limit.
2.1053 27.53(h)	Radiated Spurious Emissions	PASS	Meet the requirement of limit. Minimum passing margin is -16.31dB at 6930.00MHz.

## 2.1 MEASUREMENT UNCERTAINTY

Where relevant, the following measurement uncertainty levels have been estimated for tests performed on the EUT as specified in CISPR 16-4-2:

MEASUREMENT	FREQUENCY	UNCERTAINTY
Conducted emissions	150kHz~30MHz	2.44 dB
Radiated emissions	30MHz ~ 200MHz	2.93 dB
	200MHz ~1000MHz	2.95 dB
	1GHz ~ 18GHz	2.26 dB
	18GHz ~ 40GHz	1.94 dB

This uncertainty represents an expanded uncertainty expressed at approximately the 95% confidence level using a coverage factor of  $k=2$ .

## 2.2 TEST SITE AND INSTRUMENTS

DESCRIPTION & MANUFACTURER	MODEL NO.	SERIAL NO.	DATE OF CALIBRATION	DUE DATE OF CALIBRATION
Test Receiver ROHDE & SCHWARZ	ESCI	100744	Apr. 15, 2013	Apr. 14, 2014
Spectrum Analyzer ROHDE & SCHWARZ	FSU43	101261	Dec. 21, 2013	Dec. 20, 2014
BILOG Antenna SCHWARZBECK	VULB9168	9168-472	Mar. 25, 2013	Mar. 24, 2014
HORN Antenna SCHWARZBECK	BBHA 9120 D	9120D-969	Jan. 07, 2013	Jan. 06, 2014
HORN Antenna SCHWARZBECK	BBHA 9170	9170-480	Dec. 18, 2013	Dec. 17, 2014
Loop Antenna	HFH2-Z2	100070	Jan. 31, 2012	Jan. 30, 2014
Preamplifier EMCI	EMC 330H	980112	Dec. 27, 2013	Dec. 26, 2014
RF signal cable HUBER+SUHNNER	SUCOFLEX 104	309219/4 2950114	Oct. 18, 2013	Oct. 17, 2014
RF signal cable HUBER+SUHNNER	SUCOFLEX 104	250130/4	Oct. 18, 2013	Oct. 17, 2014
RF signal cable Worken	RG-213	NA	Nov. 07, 2013	Nov. 06, 2014
Software BV ADT	E3 6.120103	NA	NA	NA
Antenna Tower MF	MFA-440H	NA	NA	NA
Turn Table MF	MFT-201SS	NA	NA	NA
Antenna Tower & Turn Table Controller MF	MF-7802	NA	NA	NA
Mini-Circuits Power Splitter	ZN2PD-9G	NA	Jul. 18, 2013	Jul. 17, 2014
JFW 20dB attenuation	50HF-020-SMA	NA	NA	NA
Communications Tester-Wireless	E5515C	MY52102544	Sep. 05, 2012	Sep. 04, 2014
Radio Communication Analyzer	MT8820C	6201300640	Aug. 01, 2013	Jul. 31, 2014

- NOTE:** 1. The calibration interval of the above test instruments is 12 months and the calibrations are traceable to NML/ROC and NIST/USA.
2. The test was performed in HwaYa Chamber 10.
3. The horn antenna and HP preamplifier (model: 8449B) are used only for the measurement of emission frequency above 1GHz if tested.
4. The FCC Site Registration No. is 690701.
5. The IC Site Registration No. is IC 7450F-10.

### 3 GENERAL INFORMATION

#### 3.1 GENERAL DESCRIPTION OF EUT

<b>PRODUCT</b>	Smartphone	
<b>MODEL NO.</b>	0P6B200	
<b>POWER SUPPLY</b>	5Vdc (adapter or host equipment) 3.8Vdc (battery)	
<b>MODULATION TECHNOLOGY</b>	LTE Band 13	QPSK, 16QAM
	LTE Band 4	QPSK, 16QAM
<b>FREQUENCY RANGE</b>	LTE Band 13 Channel Bandwidth: 10MHz	782.0MHz
	LTE Band 4 Channel Bandwidth: 5MHz	1712.5MHz ~1752.5MHz
	LTE Band 4 Channel Bandwidth: 10MHz	1715.0MHz ~1750.0MHz
	LTE Band 4 Channel Bandwidth: 15MHz	1717.5MHz ~1747.5MHz
	LTE Band 4 Channel Bandwidth: 20MHz	1720.0MHz ~1745.0MHz
<b>EMISSION DESIGNATOR</b>	LTE Band 13 Channel Bandwidth: 10MHz	8M93W7D
	LTE Band 4 Channel Bandwidth: 5MHz	4M49G7D
	LTE Band 4 Channel Bandwidth: 10MHz	8M92G7D
	LTE Band 4 Channel Bandwidth: 15MHz	13M4G7D
	LTE Band 4 Channel Bandwidth: 20MHz	17M8W7D
<b>MAX. ERP POWER</b>	LTE Band 13 Channel Bandwidth: 10MHz	45.81mW
<b>MAX. EIRP POWER</b>	LTE Band 4 Channel Bandwidth: 5MHz	109.65mW
	LTE Band 4 Channel Bandwidth: 10MHz	106.41mW
	LTE Band 4 Channel Bandwidth: 15MHz	105.20mW
	LTE Band 4 Channel Bandwidth: 20MHz	105.93mW



<b>ANTENNA TYPE</b>	Fixed Internal Antenna
<b>DATA CABLE</b>	Refer to Note as below
<b>I/O PORTS</b>	Refer to users' manual
<b>ACCESSORY DEVICES</b>	Refer to Note as below

**NOTE:**

1. The EUT's accessories list refers to Ext. Pho.
2. There're 2 configurations for the EUT listed as below.  
Main Sample (A): Battery 1 + LCD Panel 1  
2nd Sample (B): Battery 2 + LCD Panel 2  
✧ Only the worst test data was presented in the report.
3. The above EUT information is declared by manufacturer and for more detailed features description, please refer to the manufacturer's specifications or User's Manual.

### 3.2 CONFIGURATION OF SYSTEM UNDER TEST

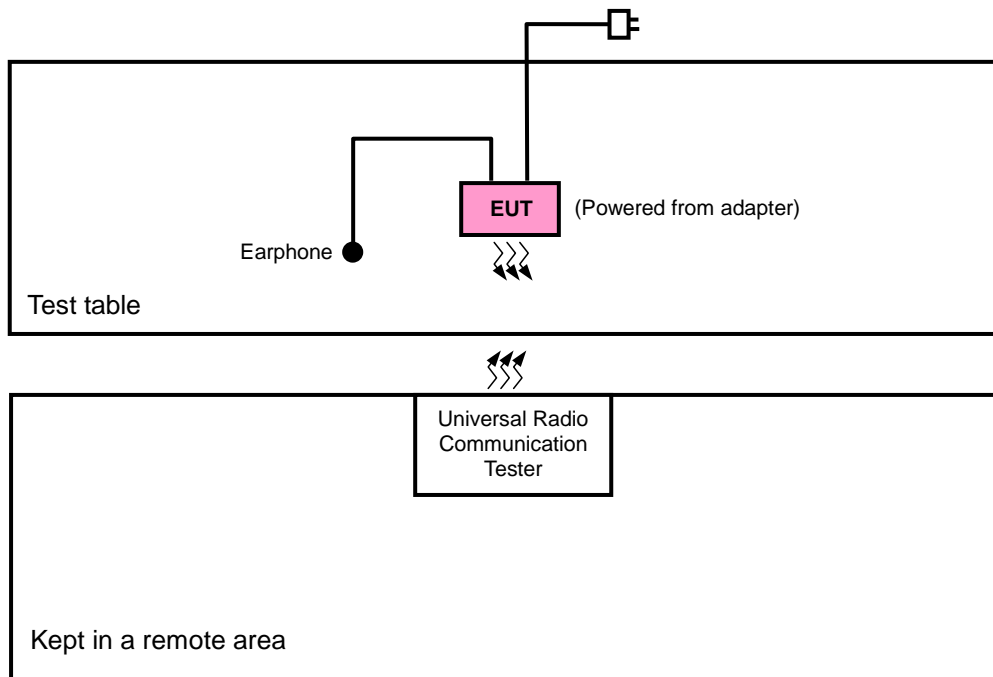

### 3.3 DESCRIPTION OF SUPPORT UNITS

The EUT has been tested as an independent unit together with other necessary accessories or support units.

### 3.4 DESCRIPTION OF TEST MODES

Pre-Scan has been conducted to determine the worst-case mode from all possible combinations between available modulations, data rates, XYZ axis and antenna ports. The worst case was found when positioned on X-axis for LTE Band 13 and Z-axis for LTE Band 4 for radiated emission. Following channel(s) was (were) selected for the final test as listed below:

EUT CONFIGURE MODE	DESCRIPTION
A	Main sample
B	2 <sup>nd</sup> sample

#### LTE Band 13

EUT CONFIGURE MODE	TEST ITEM	AVAILABLE CHANNEL	TESTED CHANNEL	CHANNEL BANDWIDTH	MODULATION	MODE
A, B	ERP	23230	23230	10MHz	QPSK, 16QAM	1 RB / 0 RB Offset
A	FREQUENCY STABILITY	23230	23230	10MHz	QPSK	1 RB / 0 RB Offset
A	OCCUPIED BANDWIDTH	23230	23230	10MHz	QPSK, 16QAM	25 RB / 0 RB Offset
A	PEAK TO AVERAGE RATIO	23230	23230	10MHz	QPSK, 16QAM	1 RB / 0 RB Offset
A	BAND EDGE	23230	23230	10MHz	QPSK	1 RB / 0 RB Offset
						50 RB / 0 RB Offset
			23230	10MHz	QPSK	1 RB / 49 RB Offset
						50 RB / 0 RB Offset
A	CONDCUDED EMISSION	23230	23230	10MHz	QPSK	1 RB / 0 RB Offset
A	RADIATED EMISSION	23230	23230	10MHz	QPSK	1 RB / 0 RB Offset
						50 RB / 0 RB Offset

**Note:** This device was tested under all bandwidths, RB configurations and modulations. The worst case was found in QPSK modulation.



LTE Band 4

EUT CONFIGURE MODE	TEST ITEM	AVAILABLE CHANNEL	TESTED CHANNEL	CHANNEL BANDWIDTH	MODULATION	MODE		
A	EIRP	19975 to 20375	19975, 20175, 20375	5MHz	QPSK, 16QAM	1 RB / 12 RB Offset		
		20000 to 20350	20000, 20175, 20350	10MHz	QPSK, 16QAM	1 RB / 24 RB Offset		
		20025 to 20325	20025, 20175, 20325	15MHz	QPSK, 16QAM	1 RB / 37 RB Offset		
		20050 to 20300	20050, 20175, 20300	20MHz	QPSK, 16QAM	1 RB / 50 RB Offset		
A	FREQUENCY STABILITY	19975 to 20375	20175	5MHz	QPSK	1 RB / 12 RB Offset		
		20000 to 20350	20175	10MHz	QPSK	1 RB / 24 RB Offset		
		20025 to 20325	20175	15MHz	QPSK	1 RB / 37 RB Offset		
		20050 to 20300	20175	20MHz	QPSK	1 RB / 50 RB Offset		
A	OCCUPIED BANDWIDTH	19975 to 20375	19975, 20175, 20375	5MHz	QPSK, 16QAM	25 RB / 0 RB Offset		
		20000 to 20350	20000, 20175, 20350	10MHz	QPSK, 16QAM	50 RB / 0 RB Offset		
		20025 to 20325	20025, 20175, 20325	15MHz	QPSK, 16QAM	75 RB / 0 RB Offset		
		20050 to 20300	20050, 20175, 20300	20MHz	QPSK, 16QAM	100 RB / 0 RB Offset		
A	PEAK TO AVERAGE RATIO	19975 to 20375	19975, 20175, 20375	5MHz	QPSK, 16QAM	1 RB / 12 RB Offset		
		20000 to 20350	20000, 20175, 20350	10MHz	QPSK, 16QAM	1 RB / 24 RB Offset		
		20025 to 20325	20025, 20175, 20325	15MHz	QPSK, 16QAM	1 RB / 0 RB Offset		
		20050 to 20300	20050, 20175, 20300	20MHz	QPSK, 16QAM	1 RB / 0 RB Offset		
A	BAND EDGE	19975 to 20375	19975	5MHz	QPSK	1 RB / 0 RB Offset 25 RB / 0 RB Offset		
			20375	5MHz	QPSK	1 RB / 24 RB Offset 25 RB / 0 RB Offset		
		20000 to 20350	20000	10MHz	QPSK	1 RB / 0 RB Offset 50 RB / 0 RB Offset		
			20350	10MHz	QPSK	1 RB / 49 RB Offset 50 RB / 0 RB Offset		
		20025 to 20325	20025	15MHz	QPSK	1 RB / 0 RB Offset 75 RB / 0 RB Offset		
			20325	15MHz	QPSK	1 RB / 74 RB Offset 75 RB / 0 RB Offset		
		20050 to 20300	20050	20MHz	QPSK	1 RB / 0 RB Offset 100 RB / 0 RB Offset		
			20300	20MHz	QPSK	1 RB / 99 RB Offset 100 RB / 0 RB Offset		
		A	CONDCUDED EMISSION	19975 to 20375	20175	5MHz	QPSK	1 RB / 12 RB Offset
				20000 to 20350	20175	10MHz	QPSK	1 RB / 24 RB Offset
				20025 to 20325	20175	15MHz	QPSK	1 RB / 0 RB Offset
				20050 to 20300	20175	20MHz	QPSK	1 RB / 0 RB Offset
A	RADIATED EMISSION	19975 to 20375	20175	5MHz	QPSK	1 RB / 12 RB Offset		
		20000 to 20350	20175	10MHz	QPSK	1 RB / 24 RB Offset		
		20025 to 20325	20175	15MHz	QPSK	1 RB / 37 RB Offset		
		20050 to 20300	20175	20MHz	QPSK	1 RB / 50 RB Offset		

**Note:** This device was tested under all bandwidths, RB configurations and modulations. The worst case was found in QPSK modulation.



A D T

**TEST CONDITION:**

TEST ITEM	ENVIRONMENTAL CONDITIONS	INPUT POWER	TESTED BY
ERP/EIRP	26deg. C, 58%RH	3.8Vdc	Howard Kao
FREQUENCY STABILITY	26deg. C, 58%RH	3.8Vdc	Howard Kao
OCCUPIED BANDWIDTH	26deg. C, 58%RH	3.8Vdc	Howard Kao
PEAK TO AVERAGE RATIO	26deg. C, 58%RH	3.8Vdc	Howard Kao
BAND EDGE	26deg. C, 58%RH	3.8Vdc	Howard Kao
CONDCUDED EMISSION	26deg. C, 58%RH	3.8Vdc	Howard Kao
RADIATED EMISSION	25deg. C, 65%RH	120Vac, 60Hz	Johnson Liao

**3.5 GENERAL DESCRIPTION OF APPLIED STANDARDS**

The EUT is a RF product. According to the specifications of the manufacturer, it must comply with the requirements of the following standards:

**FCC 47 CFR Part 2**

**FCC 47 CFR Part 27**

**ANSI C63.4-2003**

**ANSI/TIA/EIA-603-C 2004**

**NOTE:** All test items have been performed and recorded as per the above standards.

## 4 TEST TYPES AND RESULTS

### 4.1 OUTPUT POWER MEASUREMENT

#### 4.1.1 LIMITS OF OUTPUT POWER MEASUREMENT

Fixed, mobile, and portable (hand-held) stations operating in the 1710–1755 MHz band are limited to 1 watt EIRP.

Portable stations (hand-held devices) operating in the 777-787 MHz band are limited to 3 watts ERP

#### 4.1.2 TEST PROCEDURES

##### EIRP / ERP MEASUREMENT:

- a. The EUT was placed on a turntable with 1.727 meter height in a fully anechoic chamber.
- b. The EUT was set at 4.858 meters from the receiving antenna, which was mounted on the antenna tower.
- c. The EUT was rotated along 2 axis: Theta-axis: 180 degree and Phi-axis: 360 degree, Step Size: 15 degree.
- d. The height of the receiving antenna is fixed.
- e. Taking the record of received power.
- f. A dipole antenna was used in place of the EUT for pathloss calibration with a network analyzer.
- g. The gain of the dipole antenna and the insertion loss of the connected RF cable were applied into the pathloss calibration.
- h. The maximum ERP/EIRP was calculated with received power and pathloss.
- i.  $ERP/EIRP = P_s + E_t - E_s + G_s = P_s + R_t - R_s + G_s$

$P_s$  (dBm) : Input power to substitution antenna.

$G_s$  (dBi or dBd) : Substitution antenna Gain.

$E_t = R_t + AF$

$E_s = R_s + AF$

$AF$  (dB/m) : Receiver antenna factor

$R_t$ : The highest received signal in spectrum analyzer for EUT.

$R_s$ : The highest received signal in spectrum analyzer for substitution antenna.

**CONDUCTED POWER MEASUREMENT:**

- a. The EUT was set up for the maximum power with LTE link data modulation and link up with simulator.
- b. Set the EUT to transmit under low, middle and high channel and record the power level shown on simulator.

**4.1.3 TEST SETUP**

**EIRP / ERP MEASUREMENT:**

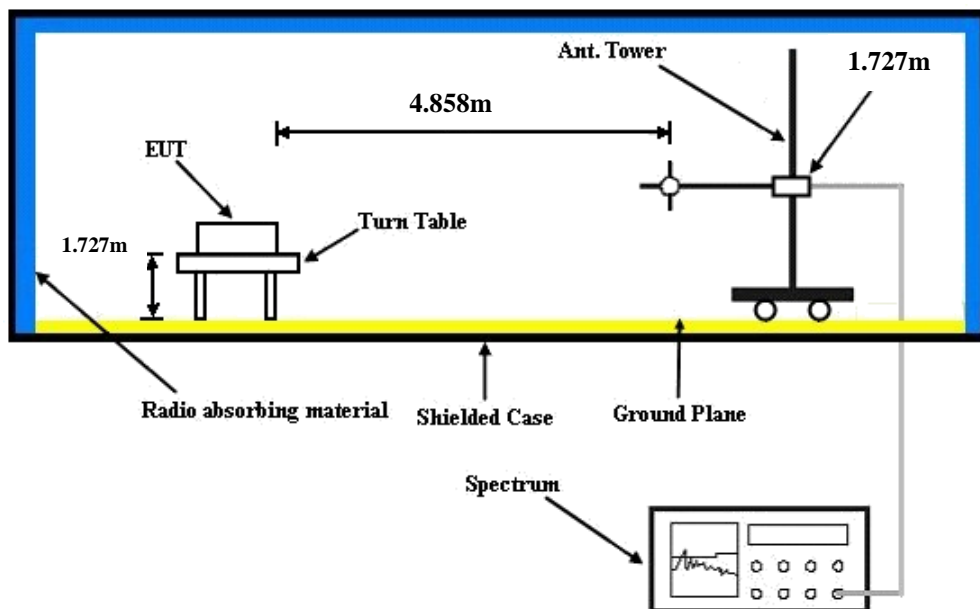

**CONDUCTED POWER MEASUREMENT:**

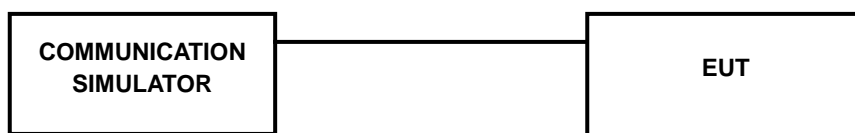

#### 4.1.4 TEST RESULTS

##### AVERAGE CONDUCTED OUTPUT POWER (dBm)

Band / BW	Modulation	RB Size	RB Offset	CH 23230	3PGG MPR (dB)
				Frequency 782 MHz	
13 / 10M	QPSK	1	0	22.37	0
		1	24	22.03	0
		1	49	22.02	0
		25	0	21.11	1
		25	12	21.07	1
		25	25	20.98	1
		50	0	21.09	1
	16QAM	1	0	21.01	1
		1	24	20.93	1
		1	49	20.92	1
		25	0	20.01	2
		25	12	19.97	2
		25	25	19.88	2
		50	0	19.99	2





Band / BW	Modulation	RB Size	RB Offset	Low CH	Mid CH	High CH	3PGG MPR (dB)
				19975 Frequency 1712.5 MHz	20175 Frequency 1732.5 MHz	20375 Frequency 1752.5 MHz	
4 / 5M	QPSK	1	0	21.46	21.87	22.53	0
		1	12	21.62	22.49	22.56	0
		1	24	21.83	22.36	22.40	0
		12	0	20.48	21.53	21.66	1
		12	6	20.71	21.53	21.58	1
		12	13	20.96	21.55	21.21	1
		25	0	20.79	21.40	21.59	1
	16QAM	1	0	20.36	20.77	21.43	1
		1	12	20.52	21.39	21.46	1
		1	24	20.73	21.26	21.30	1
		12	0	19.38	20.43	20.56	2
		12	6	19.61	20.43	20.48	2
		12	13	19.86	20.45	20.11	2
		25	0	19.69	20.30	20.49	2

Band / BW	Modulation	RB Size	RB Offset	Low CH	Mid CH	High CH	3PGG MPR (dB)
				20000 Frequency 1715.0 MHz	20175 Frequency 1732.5 MHz	20350 Frequency 1750.0 MHz	
4 / 10M	QPSK	1	0	21.47	21.88	22.54	0
		1	24	21.63	22.50	22.57	0
		1	49	21.84	22.37	22.41	0
		25	0	20.49	21.54	21.67	1
		25	12	20.72	21.54	21.59	1
		25	25	20.97	21.56	21.22	1
		50	0	20.80	21.41	21.60	1
	16QAM	1	0	20.37	20.78	21.44	1
		1	24	20.53	21.40	21.47	1
		1	49	20.74	21.27	21.31	1
		25	0	19.39	20.44	20.57	2
		25	12	19.62	20.44	20.49	2
		25	25	19.87	20.46	20.12	2
		50	0	19.70	20.31	20.50	2

Band / BW	Modulation	RB Size	RB Offset	Low CH	Mid CH	High CH	3PGG MPR (dB)
				20025 Frequency 1717.5 MHz	20175 Frequency 1732.5 MHz	20325 Frequency 1747.5 MHz	
4 / 15M	QPSK	1	0	21.49	21.90	22.56	0
		1	37	21.65	22.52	22.59	0
		1	74	21.86	22.39	22.43	0
		36	0	20.51	21.56	21.69	1
		36	19	20.74	21.56	21.61	1
		36	39	20.99	21.58	21.24	1
		75	0	20.82	21.43	21.62	1
	16QAM	1	0	20.39	20.80	21.46	1
		1	37	20.55	21.42	21.49	1
		1	74	20.76	21.29	21.33	1
		36	0	19.41	20.46	20.59	2
		36	19	19.64	20.46	20.51	2
		36	39	19.89	20.48	20.14	2
		75	0	19.72	20.33	20.52	2



A D T

Band / BW	Modulation	RB Size	RB Offset	Low CH 20050	Mid CH 20175	High CH 20300	3PGG MPR (dB)
				Frequency 1720.0 MHz	Frequency 1732.5 MHz	Frequency 1745.0 MHz	
4 / 20M	QPSK	1	0	21.61	22.02	22.68	0
		1	50	21.77	22.64	22.71	0
		1	99	21.98	22.51	22.55	0
		50	0	20.63	21.68	21.79	1
		50	25	20.84	21.66	21.71	1
		50	50	21.09	21.68	21.34	1
	16QAM	100	0	20.92	21.53	21.74	1
		1	0	20.51	20.92	21.58	1
		1	50	20.67	21.54	21.61	1
		1	99	20.88	21.41	21.45	1
		50	0	19.53	20.58	20.71	2
		50	25	19.76	20.58	20.63	2
		50	50	20.01	20.60	20.26	2
		100	0	19.84	20.45	20.64	2

**AVERAGE ERP (dBm)**

**TEST MDOE A**

**LTE BAND 13**

**CHANNEL BANDWIDTH: 10MHz QPSK**

LTE Radiated Power ERP						
Horizontal Polarization						
Frequency (MHz)	Rt (dBm)	Rs (dBm)	Ps (dBm)	Gs (dBd)	ERP (dBm)	ERP (mW)
782.0	-30.43	-48.12	0.00	-1.08	16.61	45.81
Vertical Polarization						
Frequency (MHz)	Rt (dBm)	Rs (dBm)	Ps (dBm)	Gs (dBd)	ERP (dBm)	ERP (mW)
782.0	-41.86	-48.28	0.00	-0.93	5.49	3.54

**CHANNEL BANDWIDTH: 10MHz 16QAM**

LTE Radiated Power ERP						
Horizontal Polarization						
Frequency (MHz)	Rt (dBm)	Rs (dBm)	Ps (dBm)	Gs (dBd)	ERP (dBm)	ERP (mW)
782.0	-30.55	-47.97	0.00	-1.08	16.34	43.05
Vertical Polarization						
Frequency (MHz)	Rt (dBm)	Rs (dBm)	Ps (dBm)	Gs (dBd)	ERP (dBm)	ERP (mW)
782.0	-41.89	-48.01	0.00	-0.93	5.19	3.30



A D T

**TEST MDOE B**

**LTE BAND 13**

**CHANNEL BANDWIDTH: 10MHz QPSK**

LTE Radiated Power ERP						
Horizontal Polarization						
Frequency (MHz)	Rt (dBm)	Rs (dBm)	Ps (dBm)	Gs (dBd)	ERP (dBm)	ERP (mW)
782.0	-30.79	-48.12	0.00	-1.08	16.25	42.17
Vertical Polarization						
Frequency (MHz)	Rt (dBm)	Rs (dBm)	Ps (dBm)	Gs (dBd)	ERP (dBm)	ERP (mW)
782.0	-42.33	-48.28	0.00	-0.93	5.02	3.18

**CHANNEL BANDWIDTH: 10MHz 16QAM**

LTE Radiated Power ERP						
Horizontal Polarization						
Frequency (MHz)	Rt (dBm)	Rs (dBm)	Ps (dBm)	Gs (dBd)	ERP (dBm)	ERP (mW)
782.0	-30.89	-47.97	0.00	-1.08	16.00	39.81
Vertical Polarization						
Frequency (MHz)	Rt (dBm)	Rs (dBm)	Ps (dBm)	Gs (dBd)	ERP (dBm)	ERP (mW)
782.0	-42.17	-48.01	0.00	-0.93	4.91	3.10

**AVERAGE EIRP (dBm)**

**TEST MODE A**

**LTE BAND 4**

**CHANNEL BANDWIDTH: 5MHz QPSK**

LTE Radiated Power EIRP						
Horizontal Polarization						
Frequency (MHz)	Rt (dBm)	Rs (dBm)	Ps (dBm)	Gs (dBd)	EIRP (dBm)	EIRP (mW)
1712.5	-26.64	-48.12	0.00	-1.08	20.40	109.65
1732.5	-27.28	-48.28	0.00	-0.93	20.07	101.62
1752.5	-28.56	-48.35	0.00	-0.76	19.03	79.98
Vertical Polarization						
Frequency (MHz)	Rt (dBm)	Rs (dBm)	Ps (dBm)	Gs (dBd)	EIRP (dBm)	EIRP (mW)
1712.5	-28.86	-47.97	0.00	-1.08	18.03	63.53
1732.5	-29.28	-48.01	0.00	-0.93	17.80	60.26
1752.5	-30.51	-48.05	0.00	-0.76	16.78	47.64

**CHANNEL BANDWIDTH: 5MHz 16QAM**

LTE Radiated Power EIRP						
Horizontal Polarization						
Frequency (MHz)	Rt (dBm)	Rs (dBm)	Ps (dBm)	Gs (dBd)	EIRP (dBm)	EIRP (mW)
1712.5	-26.68	-48.12	0.00	-1.08	20.36	108.64
1732.5	-26.98	-48.28	0.00	-0.93	20.37	108.89
1752.5	-28.63	-48.35	0.00	-0.76	18.96	78.70
Vertical Polarization						
Frequency (MHz)	Rt (dBm)	Rs (dBm)	Ps (dBm)	Gs (dBd)	EIRP (dBm)	EIRP (mW)
1712.5	-27.80	-47.97	0.00	-1.08	19.09	81.10
1732.5	-28.01	-48.01	0.00	-0.93	19.07	80.72
1752.5	-29.58	-48.05	0.00	-0.76	17.71	59.02

**CHANNEL BANDWIDTH: 10MHz QPSK**

LTE Radiated Power EIRP						
Horizontal Polarization						
Frequency (MHz)	Rt (dBm)	Rs (dBm)	Ps (dBm)	Gs (dBd)	EIRP (dBm)	EIRP (mW)
1715	-27.41	-48.12	0.00	-1.08	19.63	91.83
1732.5	-27.08	-48.28	0.00	-0.93	20.27	106.41
1750	-28.49	-48.35	0.00	-0.76	19.10	81.28
Vertical Polarization						
Frequency (MHz)	Rt (dBm)	Rs (dBm)	Ps (dBm)	Gs (dBd)	EIRP (dBm)	EIRP (mW)
1715	-29.94	-47.97	0.00	-1.08	16.95	49.55
1732.5	-29.81	-48.01	0.00	-0.93	17.27	53.33
1750	-30.58	-48.05	0.00	-0.76	16.71	46.88

**CHANNEL BANDWIDTH: 10MHz 16QAM**

LTE Radiated Power EIRP						
Horizontal Polarization						
Frequency (MHz)	Rt (dBm)	Rs (dBm)	Ps (dBm)	Gs (dBd)	EIRP (dBm)	EIRP (mW)
1715	-27.05	-48.12	0.00	-1.08	19.99	99.77
1732.5	-27.12	-48.28	0.00	-0.93	20.23	105.44
1750	-29.11	-48.35	0.00	-0.76	18.48	70.47
Vertical Polarization						
Frequency (MHz)	Rt (dBm)	Rs (dBm)	Ps (dBm)	Gs (dBd)	EIRP (dBm)	EIRP (mW)
1715	-28.26	-47.97	0.00	-1.08	18.63	72.95
1732.5	-28.08	-48.01	0.00	-0.93	19.00	79.43
1750	-29.83	-48.05	0.00	-0.76	17.46	55.72

**CHANNEL BANDWIDTH: 15MHz QPSK**

LTE Radiated Power EIRP						
Horizontal Polarization						
Frequency (MHz)	Rt (dBm)	Rs (dBm)	Ps (dBm)	Gs (dBd)	EIRP (dBm)	EIRP (mW)
1717.5	-27.50	-48.12	0.00	-1.08	19.54	89.95
1732.5	-27.13	-48.28	0.00	-0.93	20.22	105.20
1747.5	-28.04	-48.35	0.00	-0.76	19.55	90.16
Vertical Polarization						
Frequency (MHz)	Rt (dBm)	Rs (dBm)	Ps (dBm)	Gs (dBd)	EIRP (dBm)	EIRP (mW)
1717.5	-29.52	-47.97	0.00	-1.08	17.37	54.58
1732.5	-29.08	-48.01	0.00	-0.93	18.00	63.10
1747.5	-30.00	-48.05	0.00	-0.76	17.29	53.58

**CHANNEL BANDWIDTH: 15MHz 16QAM**

LTE Radiated Power EIRP						
Horizontal Polarization						
Frequency (MHz)	Rt (dBm)	Rs (dBm)	Ps (dBm)	Gs (dBd)	EIRP (dBm)	EIRP (mW)
1717.5	-27.61	-48.12	0.00	-1.08	19.43	87.70
1732.5	-27.19	-48.28	0.00	-0.93	20.16	103.75
1747.5	-28.60	-48.35	0.00	-0.76	18.99	79.25
Vertical Polarization						
Frequency (MHz)	Rt (dBm)	Rs (dBm)	Ps (dBm)	Gs (dBd)	EIRP (dBm)	EIRP (mW)
1717.5	-28.85	-47.97	0.00	-1.08	18.04	63.68
1732.5	-28.07	-48.01	0.00	-0.93	19.01	79.62
1747.5	-29.67	-48.05	0.00	-0.76	17.62	57.81

**CHANNEL BANDWIDTH: 20MHz QPSK**

LTE Radiated Power EIRP						
Horizontal Polarization						
Frequency (MHz)	Rt (dBm)	Rs (dBm)	Ps (dBm)	Gs (dBd)	EIRP (dBm)	EIRP (mW)
1720	-27.45	-48.12	0.00	-1.08	19.59	90.99
1732.5	-27.22	-48.28	0.00	-0.93	20.13	103.04
1745	-27.74	-48.35	0.00	-0.76	19.85	96.61
Vertical Polarization						
Frequency (MHz)	Rt (dBm)	Rs (dBm)	Ps (dBm)	Gs (dBd)	EIRP (dBm)	EIRP (mW)
1720	-29.43	-47.97	0.00	-1.08	17.46	55.72
1732.5	-29.12	-48.01	0.00	-0.93	17.96	62.52
1745	-29.62	-48.05	0.00	-0.76	17.67	58.48

**CHANNEL BANDWIDTH: 20MHz 16QAM**

LTE Radiated Power EIRP						
Horizontal Polarization						
Frequency (MHz)	Rt (dBm)	Rs (dBm)	Ps (dBm)	Gs (dBd)	EIRP (dBm)	EIRP (mW)
1720	-27.51	-48.12	0.00	-1.08	19.53	89.74
1732.5	-27.10	-48.28	0.00	-0.93	20.25	105.93
1745	-27.91	-48.35	0.00	-0.76	19.68	92.90
Vertical Polarization						
Frequency (MHz)	Rt (dBm)	Rs (dBm)	Ps (dBm)	Gs (dBd)	EIRP (dBm)	EIRP (mW)
1720	-28.73	-47.97	0.00	-1.08	18.16	65.46
1732.5	-28.15	-48.01	0.00	-0.93	18.93	78.16
1745	-29.20	-48.05	0.00	-0.76	18.09	64.42



## 4.2 FREQUENCY STABILITY MEASUREMENT

### 4.2.1 LIMITS OF FREQUENCY STABILITY MEASUREMENT

The frequency stability shall be sufficient to ensure that the fundamental emissions stay within the authorized bands of operation.

### 4.2.2 TEST PROCEDURE

- a. Device is placed at the oven room. The oven room could control the temperatures and humidity. Power warm up is at least 15 min and power applied should perform before recording frequency error.
- b. EUT is connected the external power supply to control the DC input power. The test voltage range is from minimum to maximum working voltage. Each step shall be record the frequency error rate.
- c. The temperature range step is 10 degrees in this test items. All temperature levels shall be hold the  $\pm 0.5^{\circ}\text{C}$  during the measurement testing. The each temperature step shall be at least 0.5 hours, consider the EUT could be test under the stability condition.

**NOTE:** The frequency error was recorded frequency error from the communication simulator.

### 4.2.3 TEST SETUP

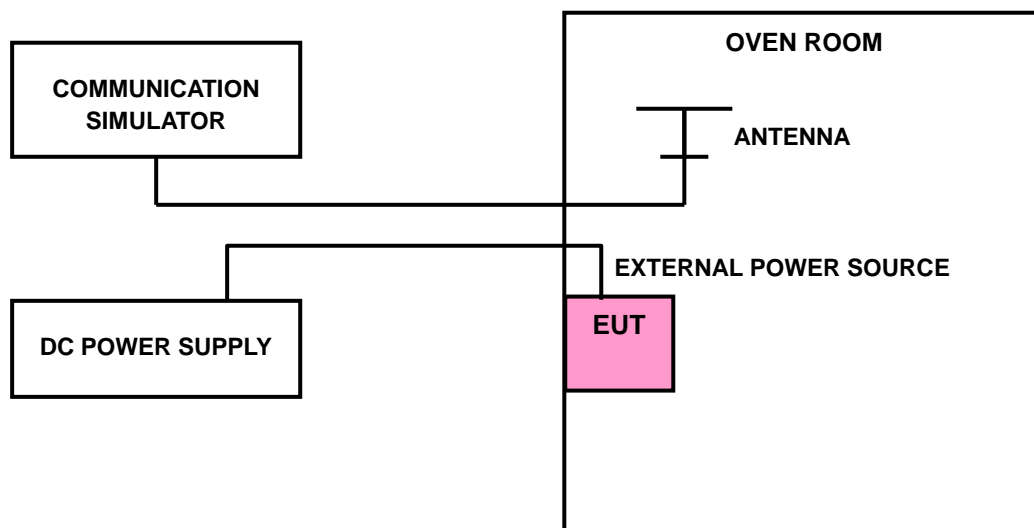

#### 4.2.4 TEST RESULTS

##### FREQUENCY ERROR vs. VOLTAGE

VOLTAGE (Volts)	FREQUENCY ERROR (ppm)					LIMIT (ppm)
	LTE Band 13	LTE Band 4				
	10MHz	5MHz	10MHz	15MHz	20MHz	
3.8	-0.0043	0.0016	-0.0013	0.0029	0.0018	2.5
3.6	-0.0026	-0.0017	0.0014	0.0013	0.0021	2.5
4.35	-0.0024	-0.0017	0.0027	-0.0003	-0.0014	2.5

**NOTE:** The applicant defined the normal working voltage of the battery is from 3.6Vdc to 4.35Vdc.

##### FREQUENCY ERROR vs. TEMPERATURE

TEMP. (°C)	FREQUENCY ERROR (ppm)					LIMIT (ppm)
	LTE Band 13	LTE Band 4				
	10MHz	5MHz	10MHz	15MHz	20MHz	
-30	-0.0041	-0.0012	0.0002	-0.0028	0.0013	2.5
-20	0.0018	-0.0027	0.0008	0.0009	-0.0031	2.5
-10	-0.0066	-0.0009	0.0012	-0.0008	0.0020	2.5
0	-0.0046	-0.0006	-0.0012	0.0017	-0.0019	2.5
10	-0.0037	0.0011	-0.0022	-0.0022	0.0034	2.5
20	-0.0036	0.0006	-0.0001	0.0025	0.0043	2.5
30	-0.0060	-0.0008	0.0020	0.0014	0.0014	2.5
40	-0.0017	0.0011	0.0014	0.0041	0.0021	2.5
50	-0.0026	0.0023	0.0012	0.0009	0.0017	2.5

### 4.3 OCCUPIED BANDWIDTH MEASUREMENT

#### 4.3.1 LIMITS OF OCCUPIED BANDWIDTH MEASUREMENT

The width of a frequency band such that, below the lower and above the upper frequency limits, the mean powers emitted are each equal to a specified percentage 0.5 %of the total mean power of a given emission.

#### 4.3.2 TEST SETUP

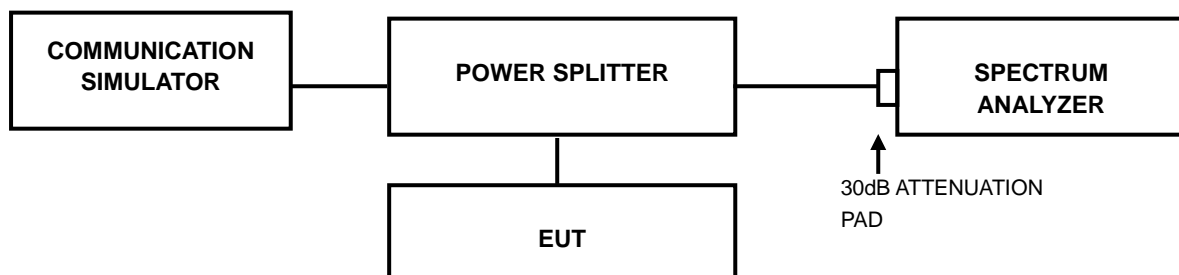

#### 4.3.3 TEST PROCEDURES

- a. The conducted occupied bandwidth used the power splitter via EUT RF power connector between simulation base station and spectrum analyzer.
- b. Use OBW measurement function of Spectrum analyzer to measure 99 % occupied bandwidth.



A D T

### 4.3.4 TEST RESULTS

LTE BAND 13			
CHANNEL BANDWIDTH: 10MHz			
CHANNEL	FREQUENCY (MHz)	99% OCCUPIED BANDWIDTH (MHz)	
		QPSK	16QAM
23230	782.0	8.9303	8.9332

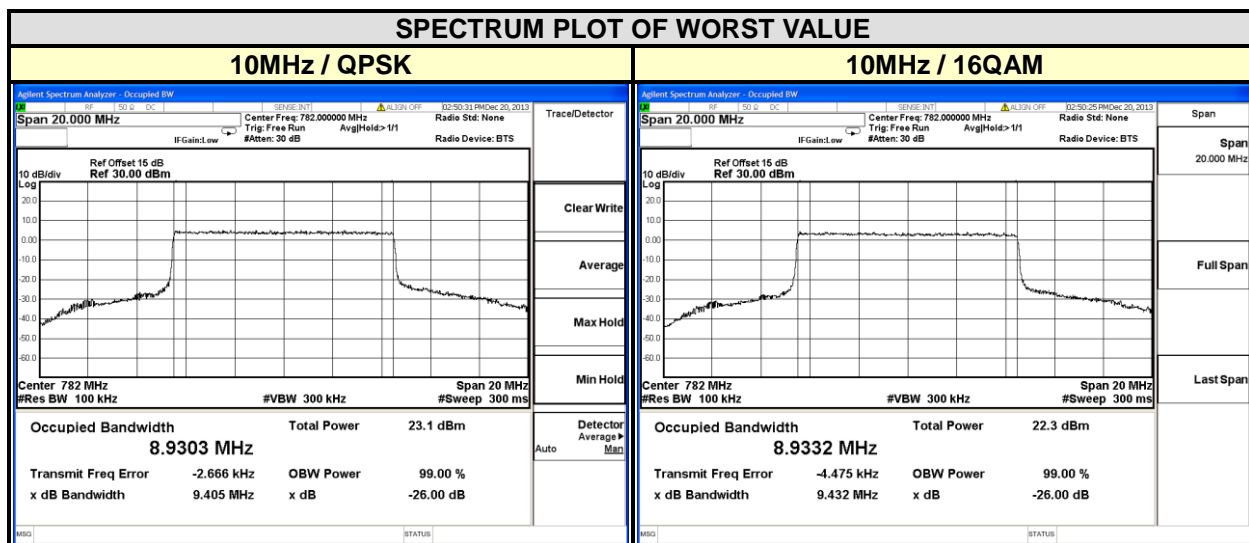



A D T

LTE BAND 4							
CHANNEL BANDWIDTH: 5MHz				CHANNEL BANDWIDTH: 10MHz			
CHANNEL	FREQUENCY (MHz)	99% OCCUPIED BANDWIDTH (MHz)		CHANNEL	FREQUENCY (MHz)	99% OCCUPIED BANDWIDTH (MHz)	
		QPSK	16QAM			QPSK	16QAM
19975	1712.5	4.4894	4.4884	20000	1715.0	8.9236	8.9136
20175	1732.5	4.4897	4.4876	20175	1732.5	8.9222	8.9227
20375	1752.5	4.4864	4.4884	20350	1750.0	8.9215	8.9227

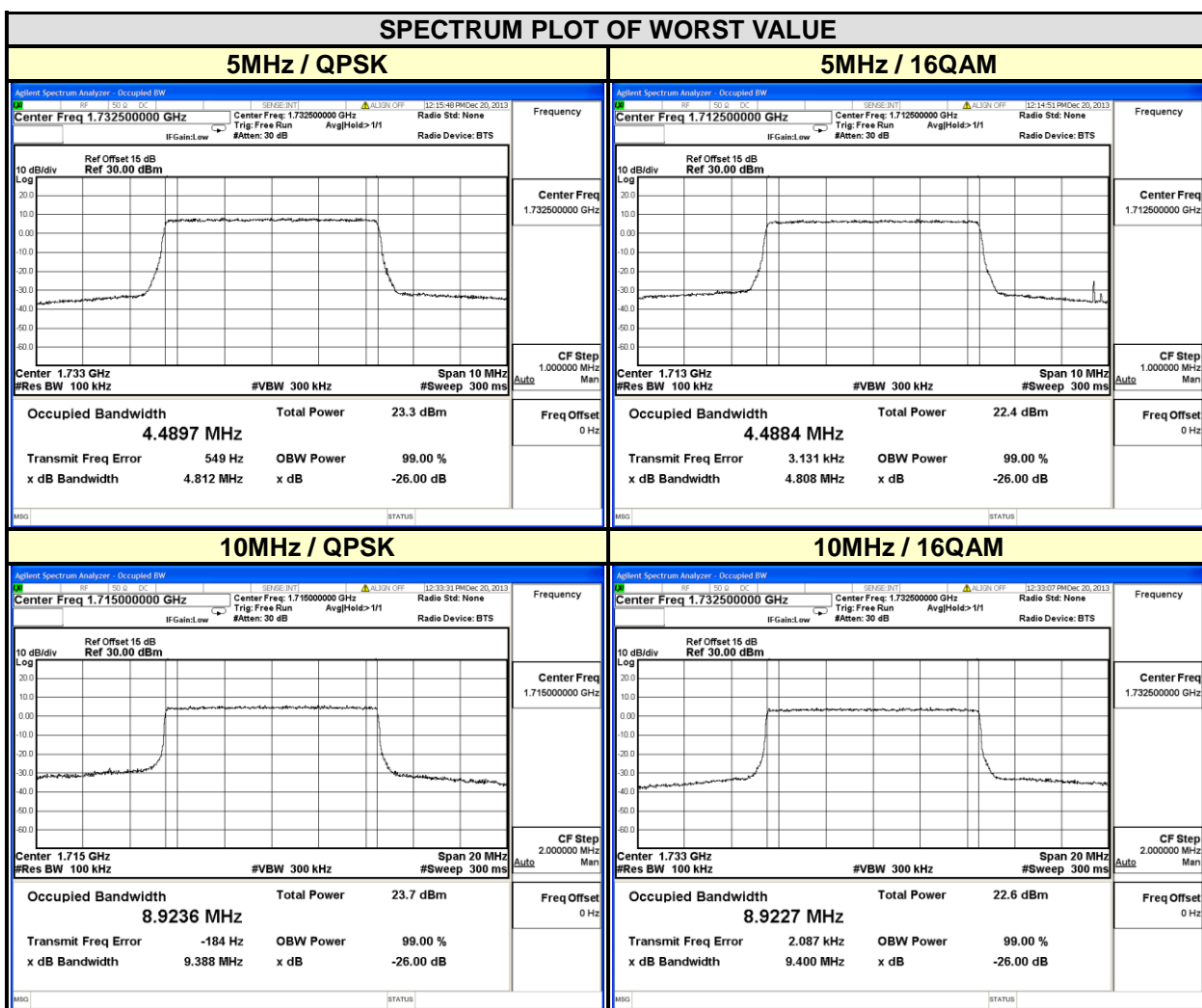



A D T

LTE BAND 4							
CHANNEL BANDWIDTH: 15MHz				CHANNEL BANDWIDTH: 20MHz			
CHANNEL	FREQUENCY (MHz)	99% OCCUPIED BANDWIDTH (MHz)		CHANNEL	FREQUENCY (MHz)	99% OCCUPIED BANDWIDTH (MHz)	
		QPSK	16QAM			QPSK	16QAM
20025	1717.5	13.384	13.374	20050	1720	17.825	17.82
20175	1732.5	13.382	13.381	20175	1732.5	17.809	17.836
20325	1747.5	13.37	13.373	20300	1745	17.813	17.802

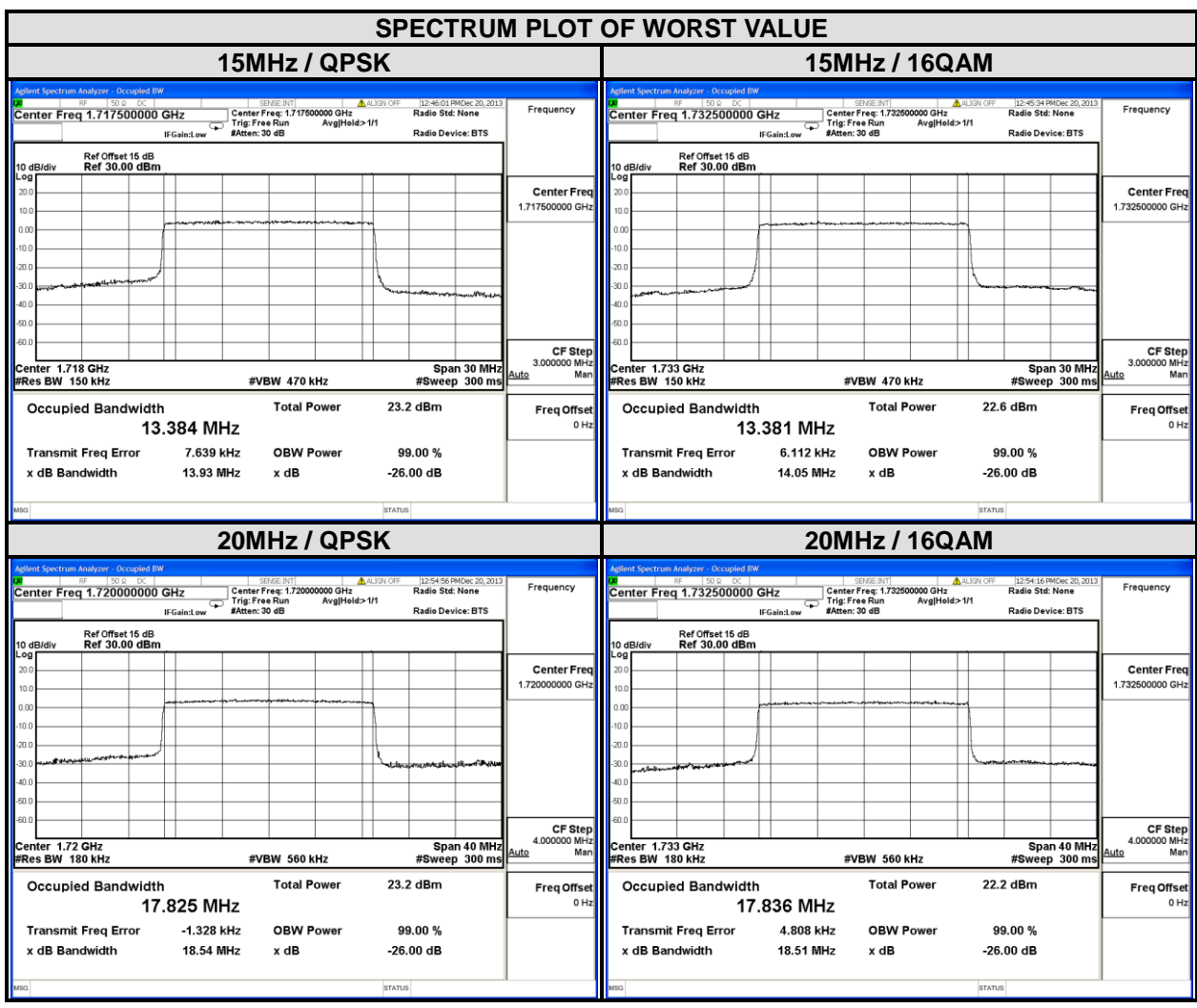

## 4.4 PEAK TO AVERAGE RATIO

### 4.4.1 LIMITS OF PEAK TO AVERAGE RATIO MEASUREMENT

In measuring transmissions in this band using an average power technique, the peak to-average ratio (PAR) of the transmission may not exceed 13 dB

### 4.4.2 TEST SETUP

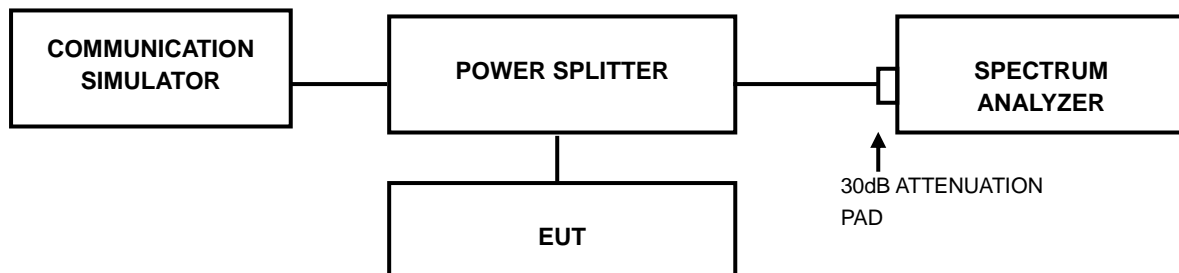

### 4.4.3 TEST PROCEDURES

1. Set resolution/measurement bandwidth  $\geq$  signal's occupied bandwidth;
2. Set the number of counts to a value that stabilizes the measured CCDF curve;
3. Record the maximum PAPR level associated with a probability of 0.1%.

#### 4.4.4 TEST RESULTS

LTE BAND 13			
CHANNEL BANDWIDTH: 10MHz			
CHANNEL	FREQUENCY (MHz)	PEAK TO AVERAGE RATIO (dB)	
		QPSK	16QAM
23230	782.0	4.56	5.33

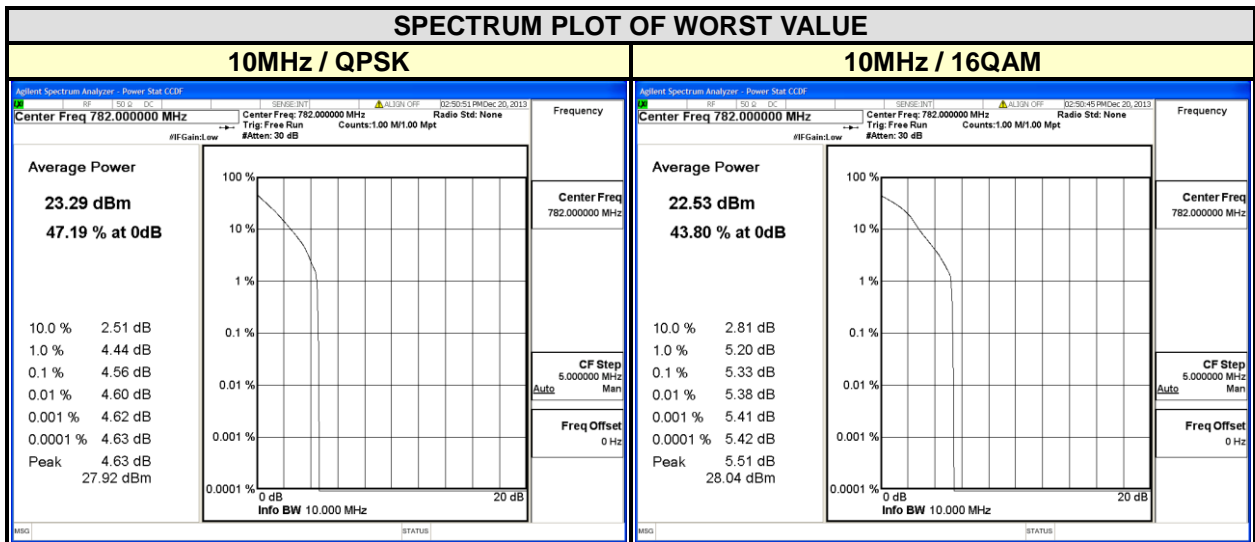





A D T

LTE BAND 4							
CHANNEL BANDWIDTH: 5MHz				CHANNEL BANDWIDTH: 10MHz			
CHANNEL	FREQUENCY (MHz)	PEAK TO AVERAGE RATIO (dB)		CHANNEL	FREQUENCY (MHz)	PEAK TO AVERAGE RATIO (dB)	
		QPSK	16QAM			QPSK	16QAM
19975	1712.5	3.75	5.06	20000	1715.0	3.60	4.92
20175	1732.5	4.82	5.49	20175	1732.5	4.66	5.30
20375	1752.5	3.70	4.79	20350	1750.0	3.54	4.75

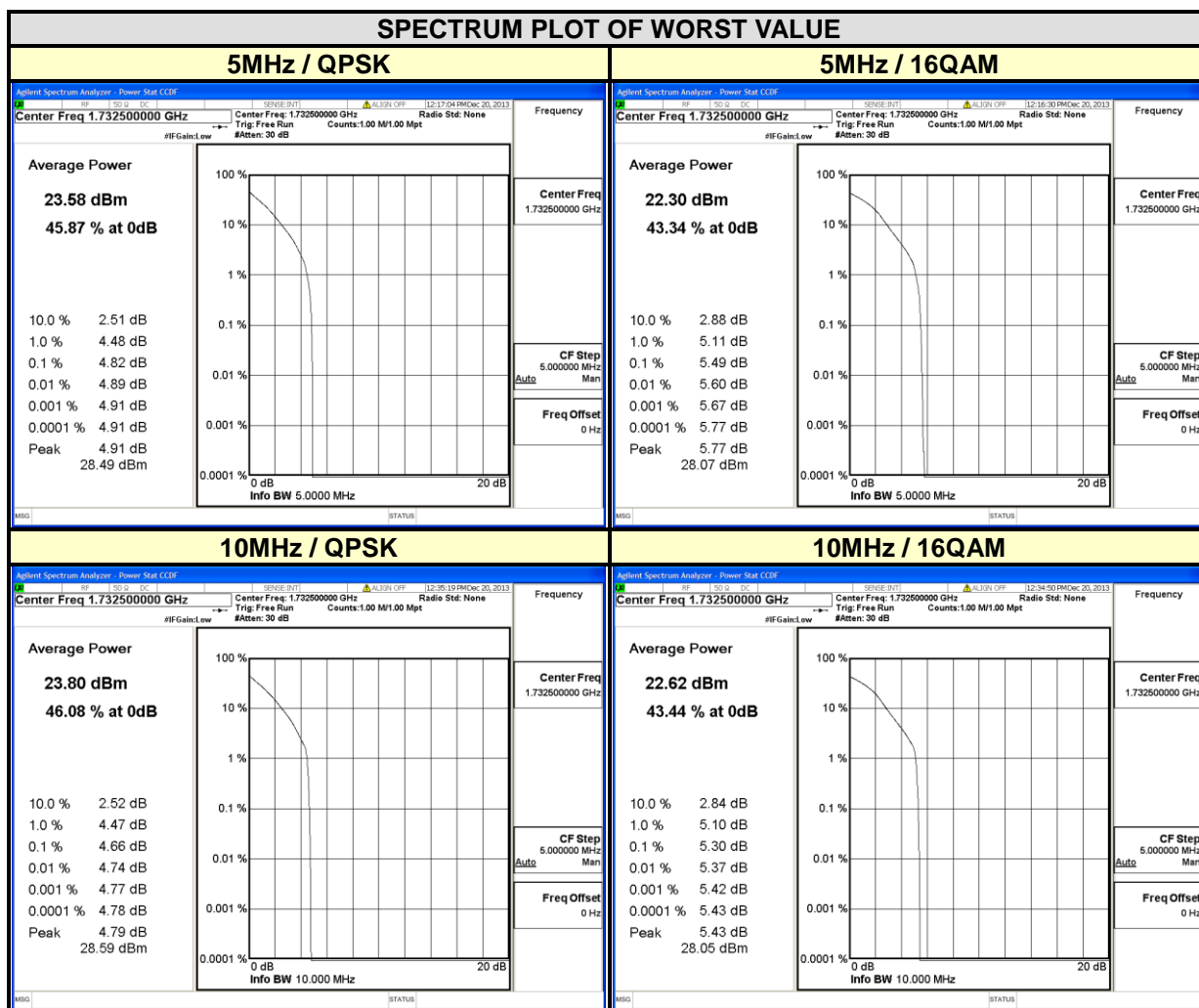



A D T

LTE BAND 4							
CHANNEL BANDWIDTH: 15MHz				CHANNEL BANDWIDTH: 20MHz			
CHANNEL	FREQUENCY (MHz)	PEAK TO AVERAGE RATIO (dB)		CHANNEL	FREQUENCY (MHz)	PEAK TO AVERAGE RATIO (dB)	
		QPSK	16QAM			QPSK	16QAM
20025	1717.5	3.86	5.10	20050	1720	3.74	5.00
20175	1732.5	4.66	5.35	20175	1732.5	4.62	5.44
20325	1747.5	4.29	5.37	20300	1745	4.73	5.53

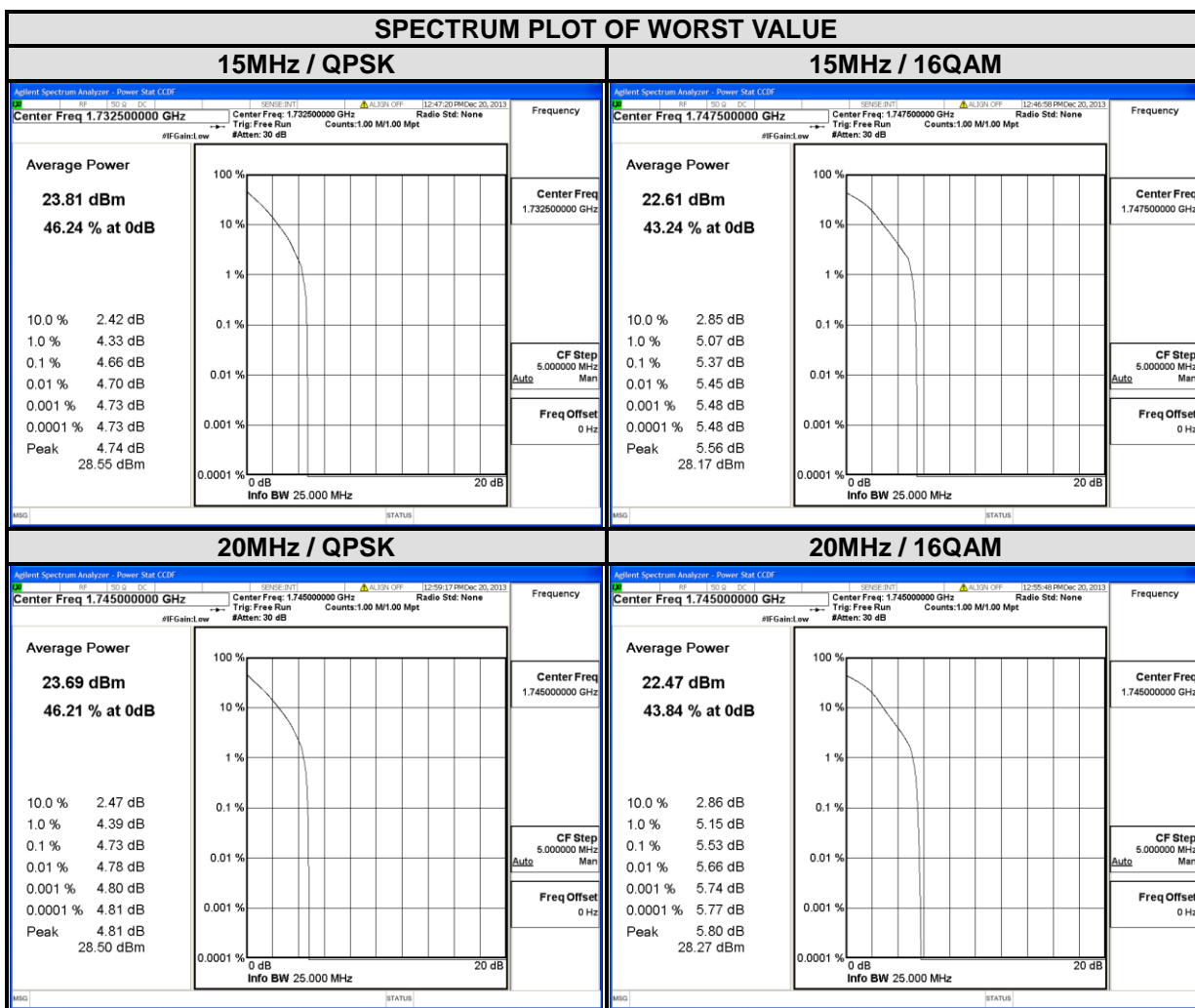

## 4.5 BAND EDGE MEASUREMENT

### 4.5.1 LIMITS OF BAND EDGE MEASUREMENT

For operations in the 777-787 MHz band, the power of any emission outside a licensee's frequency band(s) of operation shall be attenuated below the transmitter power (P) within the licensed band(s) of operation, measured in watts, by at least  $43 + 10 \log (P)$  dB. Compliance with this provision is based on the use of measurement instrumentation employing a resolution bandwidth of 100 kilohertz or greater.

However, in the 100 kilohertz bands immediately outside and adjacent to a licensee's frequency block, a resolution bandwidth of at least 30 kHz may be employed.

For operations in the 1710 – 1755 MHz MHz bands, the power of any emission outside a licensee's frequency block shall be attenuated below the transmitter power (P) by at least  $43 + 10 \log_{10}(P)$  dB.

### 4.5.2 TEST SETUP

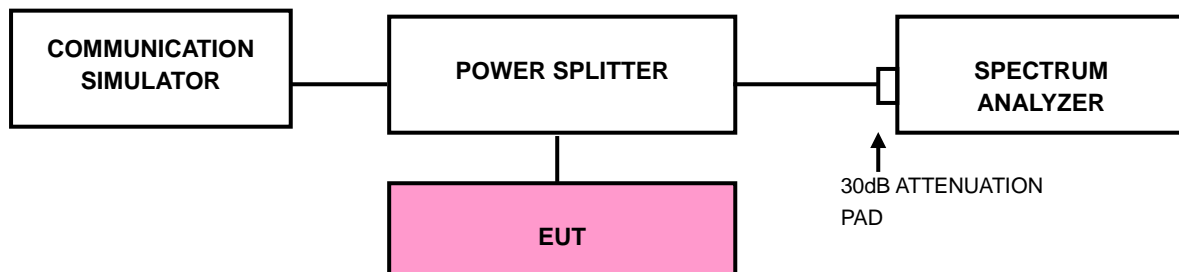

#### 4.5.3 TEST PROCEDURES

- a. The EUT was set up for the maximum peak power with LTE link data modulation. The power was measured with R&S Spectrum Analyzer. All measurements were done at 2 channels (low and high operational frequency range.).
- b. The band edge measurement used the power splitter via EUT RF power connector between simulation base station and spectrum analyzer.
- c. The center frequency of spectrum is the band edge frequency and span is 1 MHz. RB of the spectrum is 150kHz and VB of the spectrum is 470kHz (LTE Band 13 / LTE Band 4 Channel Bandwidth 5MHz & 10MHz).
- d. The center frequency of spectrum is the band edge frequency and span is 1 MHz. RB of the spectrum is 180kHz and VB of the spectrum is 560kHz (LTE Band 4 Channel Bandwidth 20MHz).
- e. The center frequency of spectrum is the band edge frequency and span is 1 MHz. RB of the spectrum is 180kHz and VB of the spectrum is 560kHz (LTE Band 4 Channel Bandwidth 15MHz).
- f. Record the max trace plot into the test report.

## 4.5.4 TEST RESULTS

### LTE BAND 13

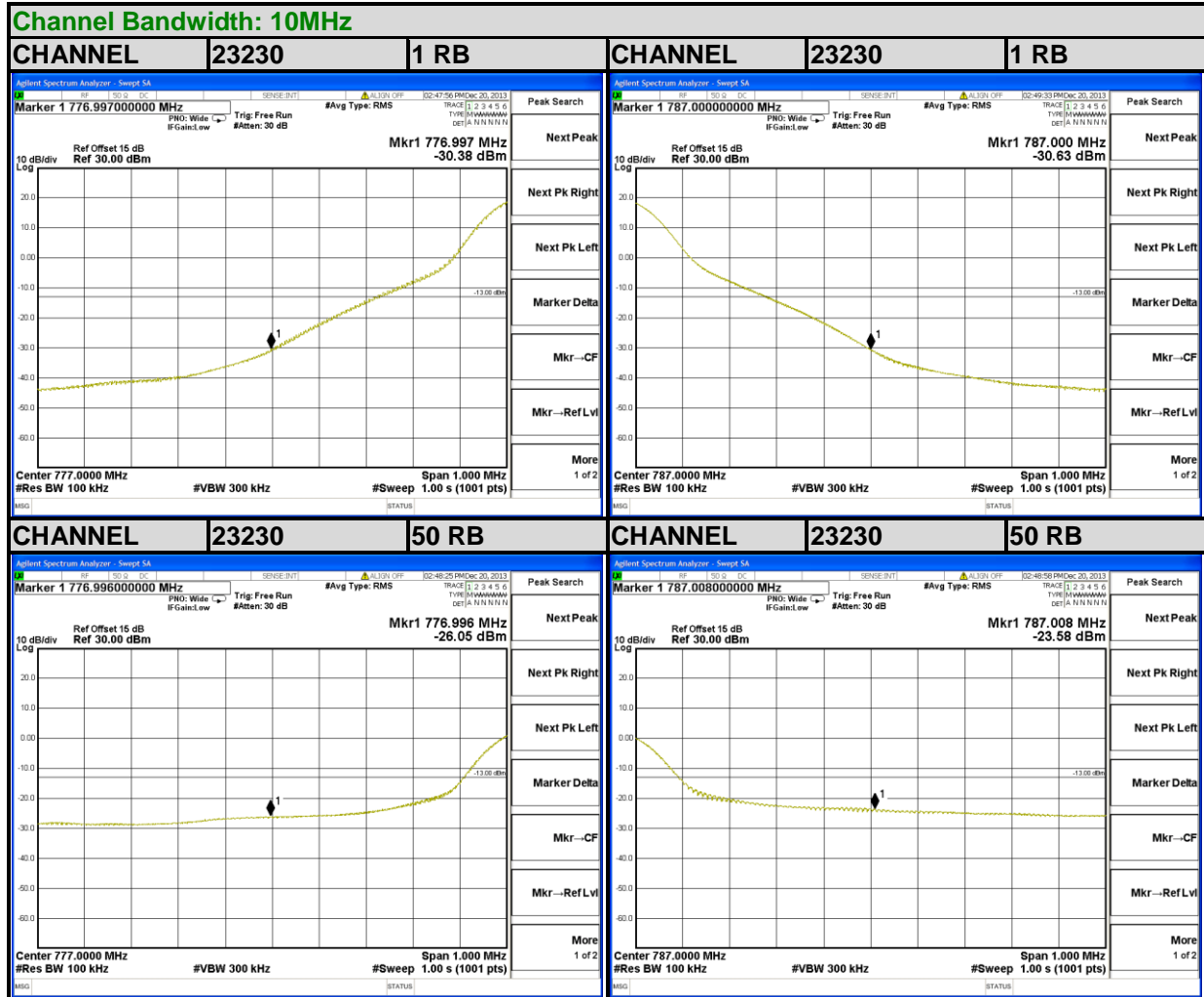

### LTE BAND 4

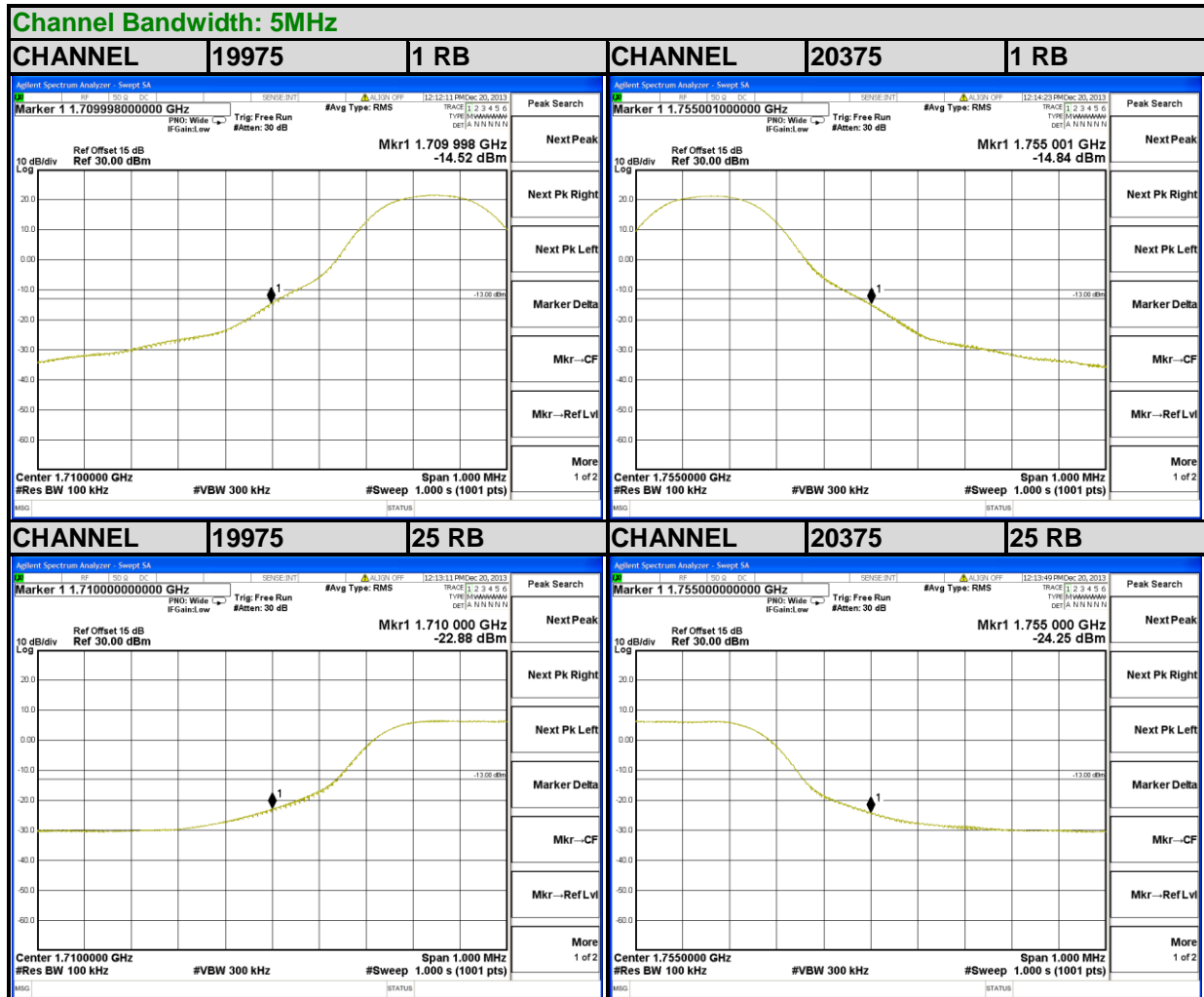



A D T

### Channel Bandwidth: 10MHz

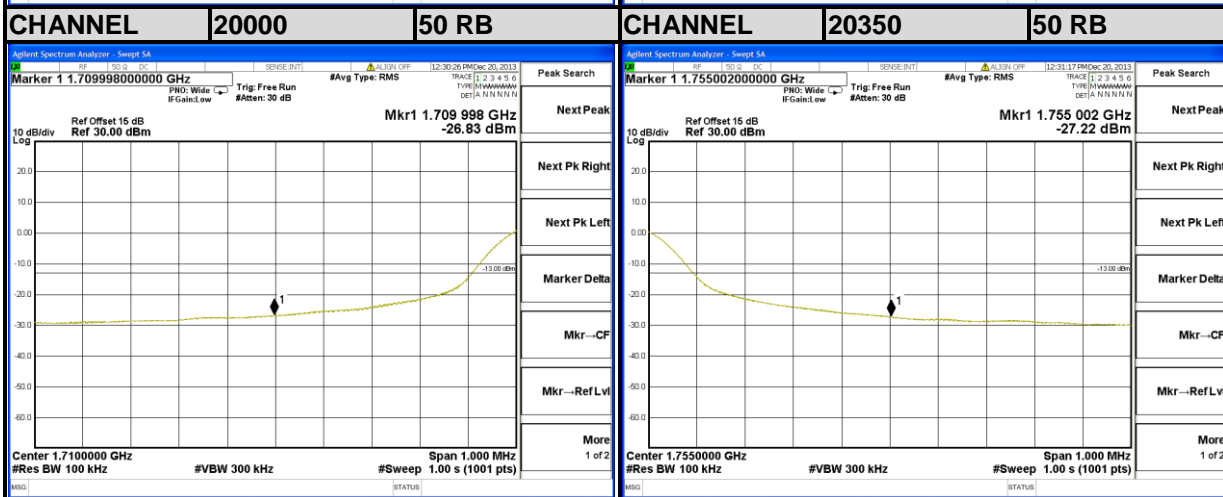
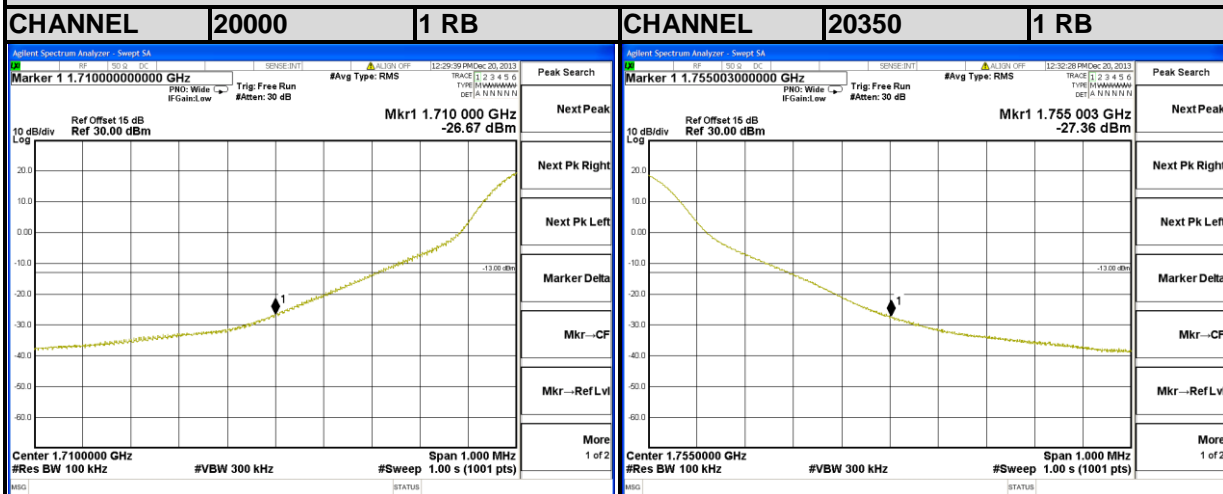



A D T

### Channel Bandwidth: 15MHz

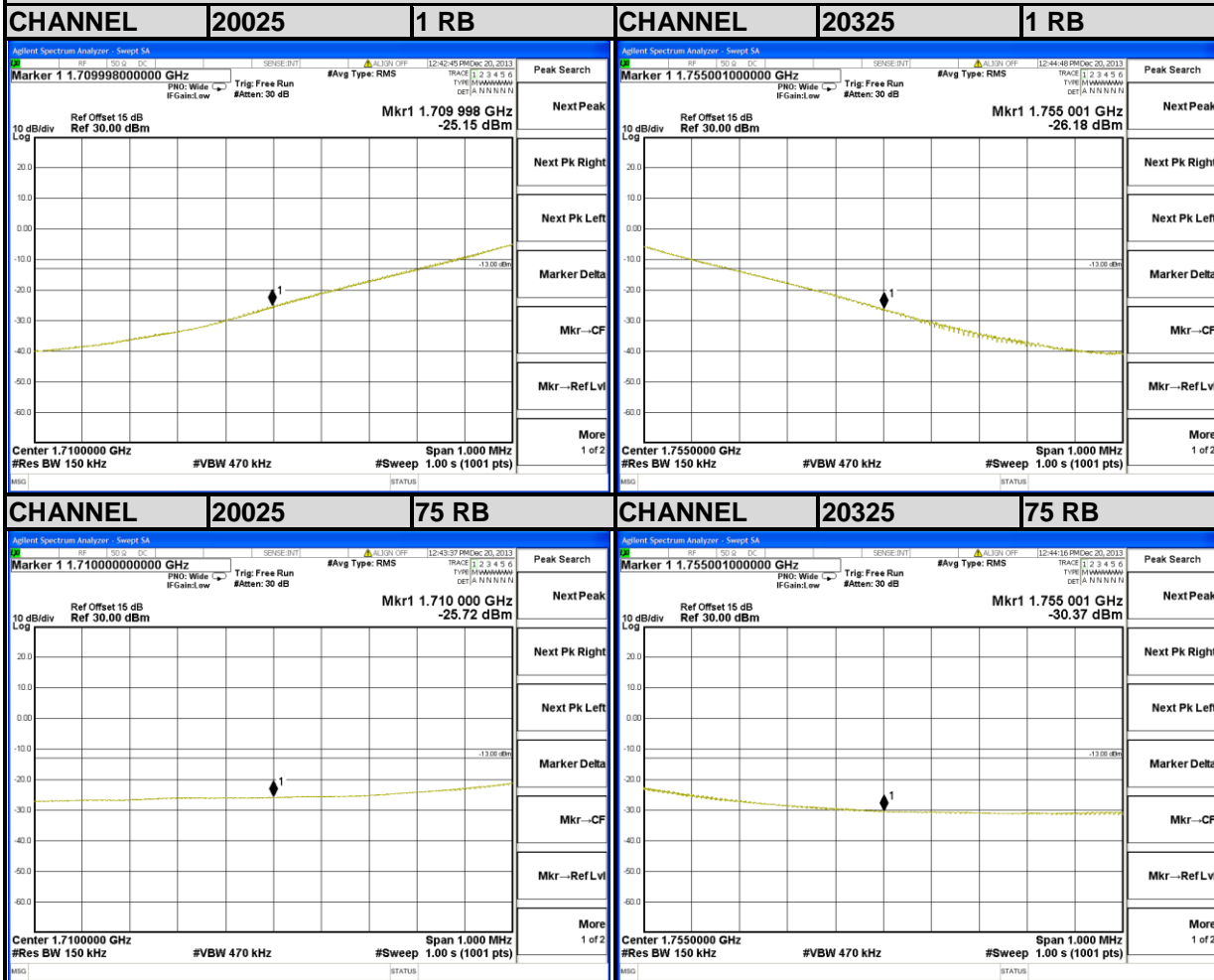





A D T

**Channel Bandwidth: 20MHz**

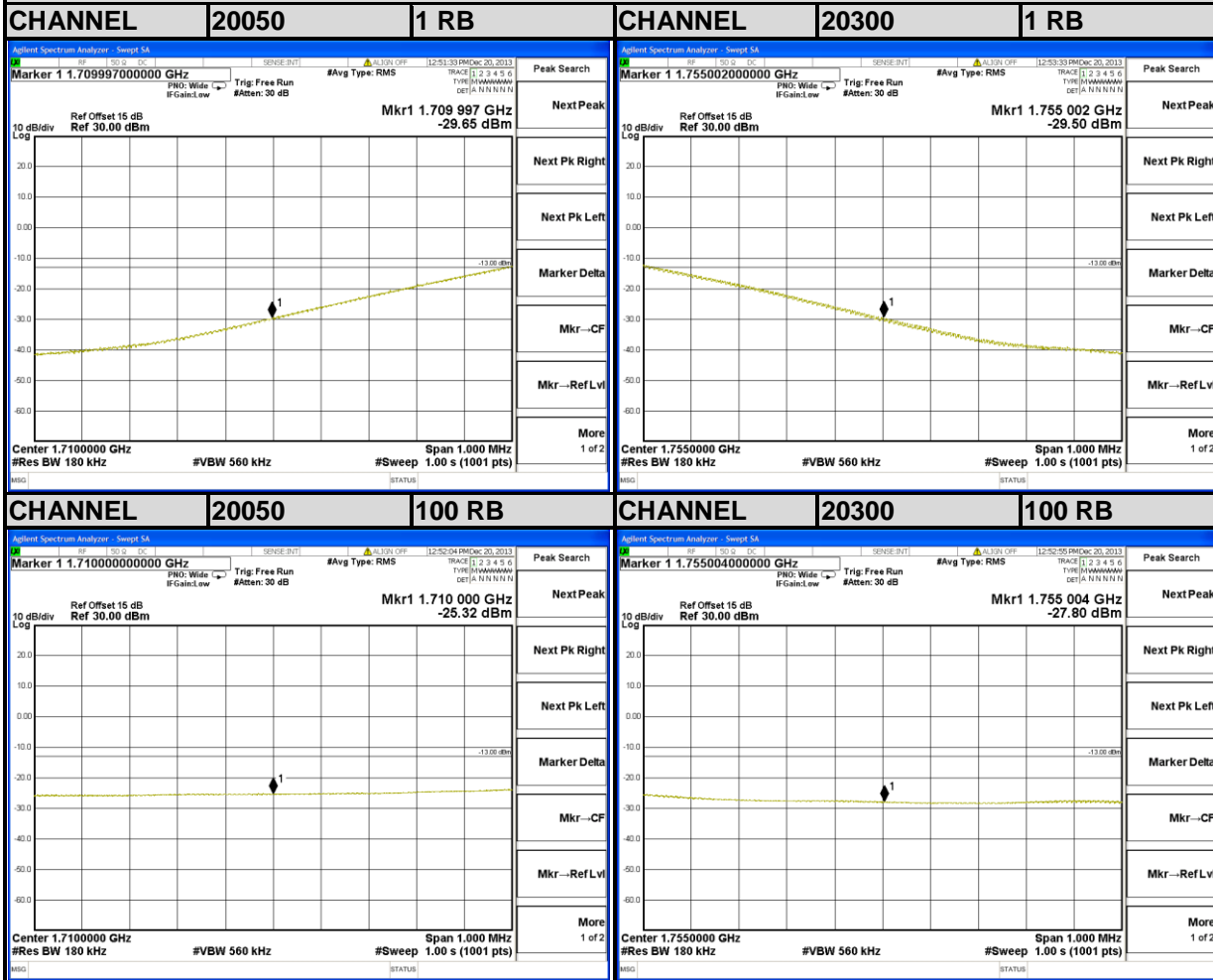

## 4.6 CONDUCTED SPURIOUS EMISSIONS

### 4.6.1 LIMITS OF CONDUCTED SPURIOUS EMISSIONS MEASUREMENT

The power of any emission outside a licensee's frequency block shall be attenuated below the transmitter power (P) by at least  $43 + 10 \log_{10}(P)$  dB. The limit of emission equal to  $-13\text{dBm}$

### 4.6.2 TEST PROCEDURE

- a. The EUT makes a phone call to the communication simulator. All measurements were done at low, middle and high operational frequency range.
- b. Measuring frequency range is from 30 MHz to 9GHz for LTE Band 13 and from 30MHz to 18GHz for LTE Band 4. 10dB attenuation pad is connected with spectrum. RBW=1MHz and VBW=3MHz are used for conducted emission measurement.

### 4.6.3 TEST SETUP

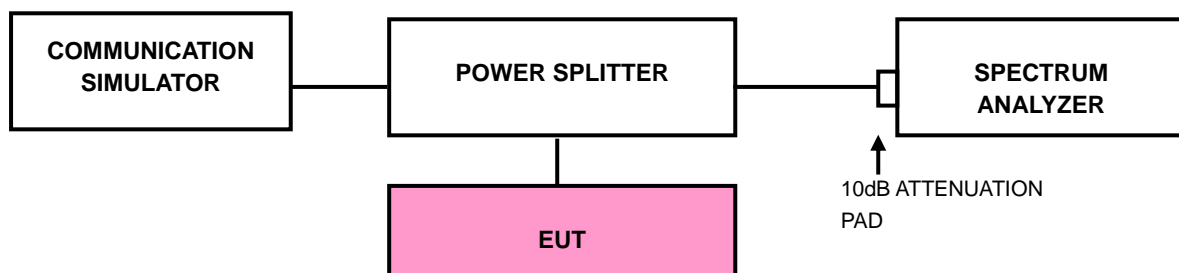



A D T

## 4.6.4 TEST RESULTS

### LTE BAND 13

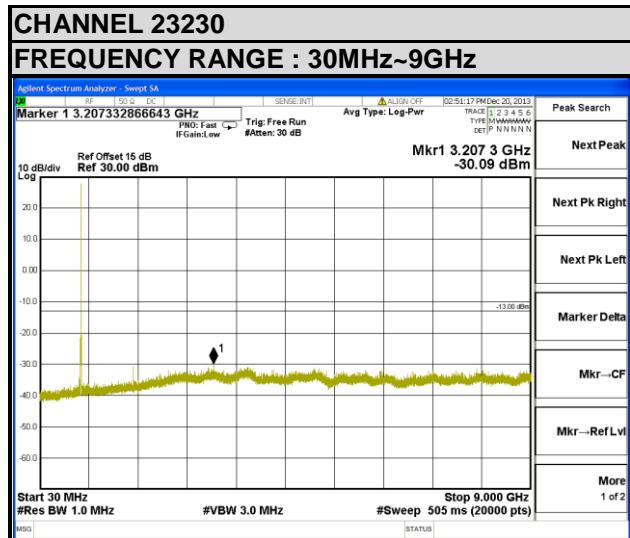



A D T

### LTE BAND 4

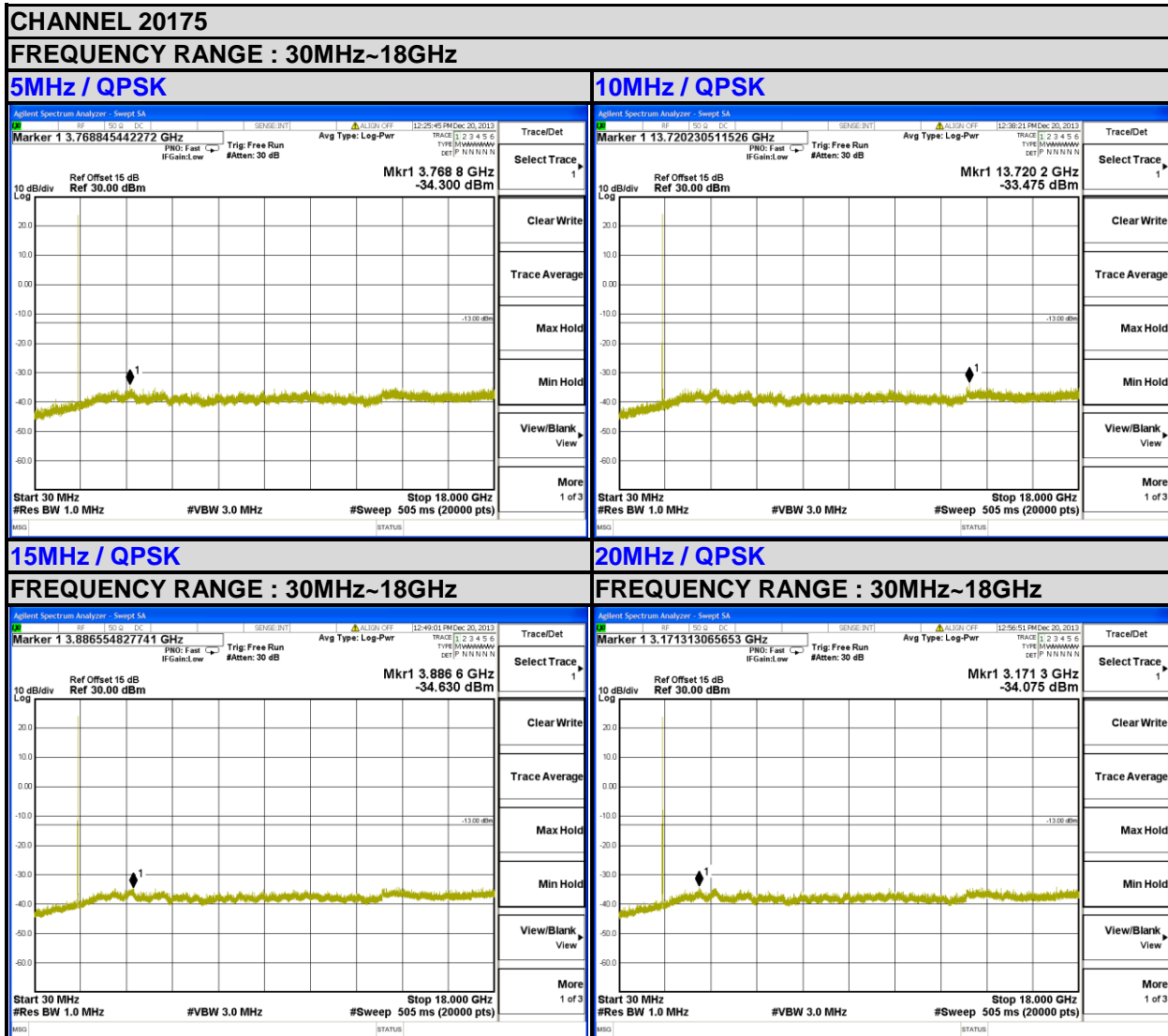

## 4.7 RADIATED EMISSION MEASUREMENT

### 4.7.1 LIMITS OF RADIATED EMISSION MEASUREMENT

The power of any emission outside a licensee's frequency block shall be attenuated below the transmitter power (P) by at least  $43 + 10 \log_{10}(P)$  dB. The limit of emission equal to  $-13\text{dBm}$

### 4.7.2 TEST PROCEDURES

- a. Substitution method is used for E.I.R.P measurement. In the semi-anechoic chamber, EUT placed on the 0.8m height of Turn Table, rotated the table around 360 degrees to search the maximum radiation power and receiver antenna shall be rotated vertical and horizontal polarization and moved height from 1m to 4m to find the maximum polar radiated power. The "Read Value" is the spectrum reading the maximum power value.
- b. The substitution horn antenna is substituted for EUT at the same position and signals generator export the CW signal to the substitution antenna via a TX cable. Rotated the Turn Table and moved receiving antenna to find the maximum radiation power. Adjust output power level of S.G to get a Value of spectrum reading equal to "Read Value" of step a. Record the power level of S.G
- c.  $\text{EIRP} = \text{Output power level of S.G} - \text{TX cable loss} + \text{Antenna gain of substitution horn.}$
- d. E.R.P power can be calculated form E.I.R.P power by subtracting the gain of dipole,  $\text{E.R.P power} = \text{E.I.P.R power} - 2.15\text{dBi.}$

**NOTE:** The resolution bandwidth of spectrum analyzer is 1 MHz and the video bandwidth is 3 MHz.

### 4.7.3 DEVIATION FROM TEST STANDARD

No deviation

#### 4.7.4 TEST SETUP

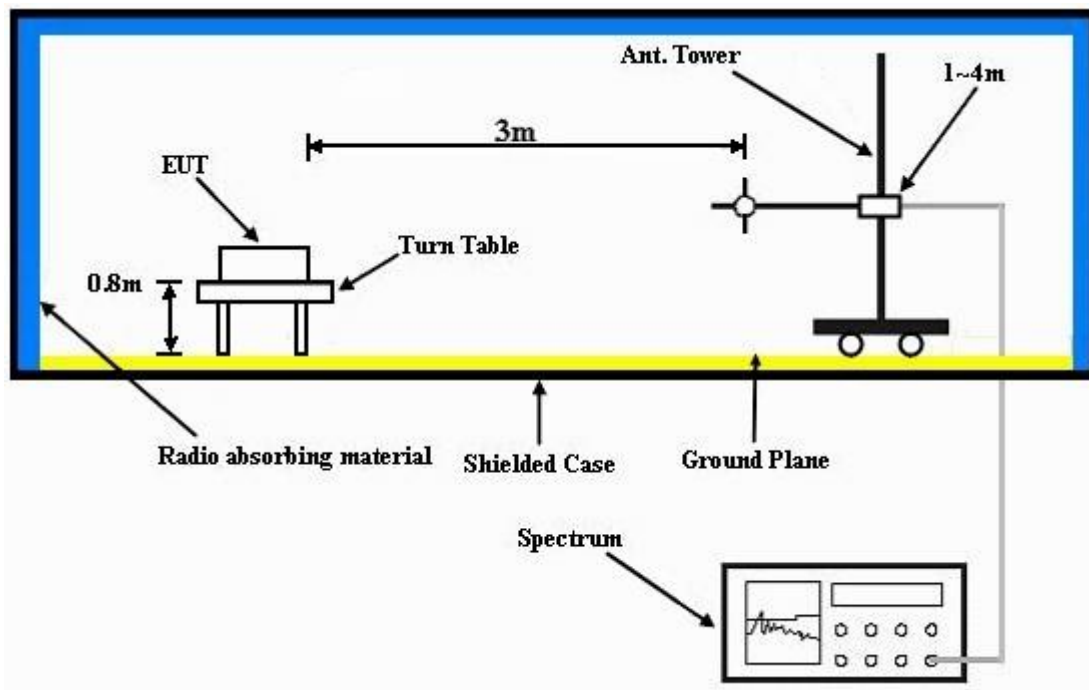

For the actual test configuration, please refer to the attached file (Test Setup Photo).



A D T

### 4.7.5 TEST RESULTS

#### LTE BAND 13

#### CHANNEL BANDWIDTH: 10MHz / QPSK



Bureau Veritas Consumer Products Services Ltd., Taoyuan Branch

A D T

Data: 9

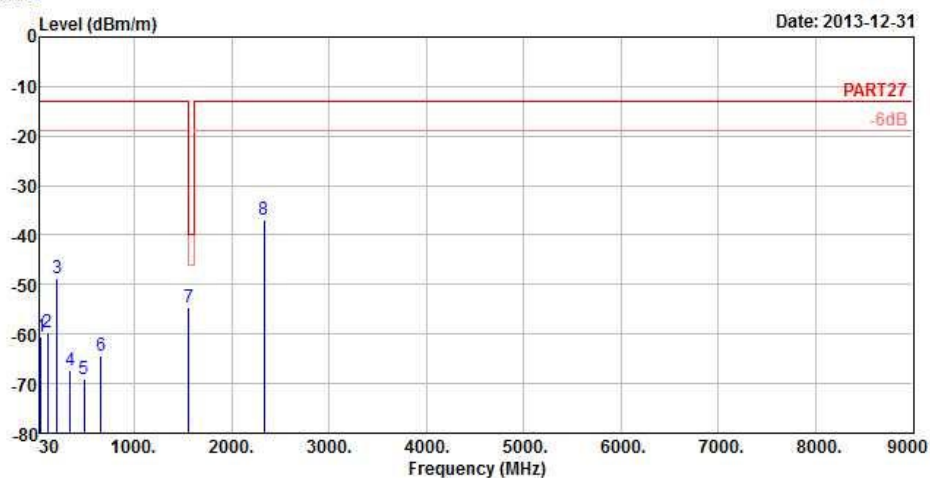

Site : 966 Chamber 5  
 Condition : PART27 3m HORIZONTAL  
 Brand/Model: 0P6B200  
 Remark : Band 13\_10M\_QPSK(1,0) Link  
 Tested by : Johnson Liao  
 Temperature : 25°C  
 Humidity : 65%  
 Plane : X

	Freq	Level	Read	Limit	Over	
	MHz	dBm/m	Level	Line	Limit	Factor Remark
			dBm	dBm/m	dB	dB/m
1	38.64	-60.51	-58.77	-13.00	-47.51	-1.74 Peak
2	108.84	-59.75	-49.16	-13.00	-46.75	-10.59 Peak
3	208.20	-48.71	-41.15	-13.00	-35.71	-7.56 Peak
4	342.00	-67.20	-61.14	-13.00	-54.20	-6.06 Peak
5	479.90	-68.98	-65.38	-13.00	-55.98	-3.60 Peak
6	654.90	-64.43	-65.06	-13.00	-51.43	0.63 Peak
7	1555.20	-54.72	-40.92	-13.00	-41.72	-13.80 Peak
8 pp	2332.80	-36.90	-26.17	-13.00	-23.90	-10.73 Peak



A D T



Bureau Veritas Consumer Products Services Ltd., Taoyuan Branch

A D T

Data: 10

Date: 2013-12-31

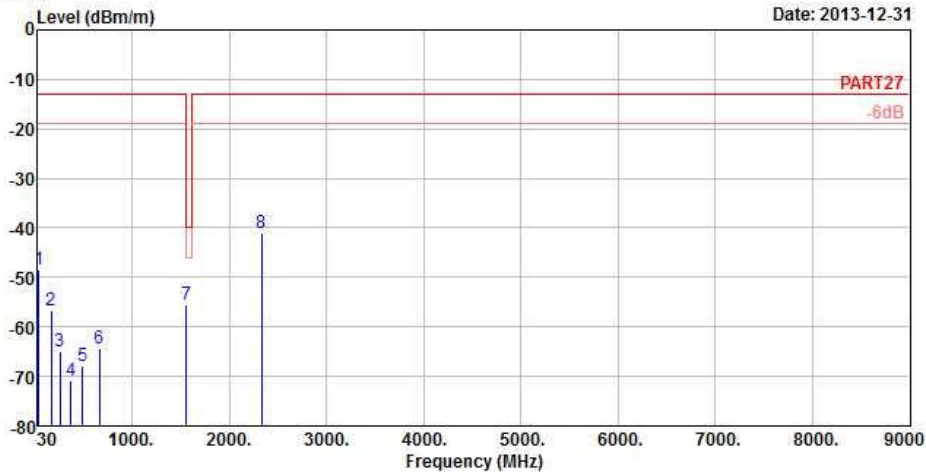

Site : 966 Chamber 5  
 Condition : PART27 3m VERTICAL  
 Brand/Model: 0P6B200  
 Remark : Band 13\_10M\_QPSK(1,0) Link  
 Tested by : Johnson Liao  
 Temperature : 25°C  
 Humidity : 65%  
 Plane : X

	Freq	Level	Read	Limit	Over		
	MHz	dBm/m	Level	Line	Limit	Factor	Remark
			dBm	dBm/m	dB	dB/m	
1	39.72	-48.33	-46.80	-13.00	-35.33	-1.53	Peak
2	170.94	-56.57	-49.85	-13.00	-43.57	-6.72	Peak
3	257.07	-64.91	-59.13	-13.00	-51.91	-5.78	Peak
4	367.20	-70.84	-64.96	-13.00	-57.84	-5.88	Peak
5	492.50	-67.92	-64.63	-13.00	-54.92	-3.29	Peak
6	661.90	-64.21	-64.96	-13.00	-51.21	0.75	Peak
7	1555.20	-55.39	-41.59	-13.00	-42.39	-13.80	Peak
8 pp	2332.80	-40.90	-30.17	-13.00	-27.90	-10.73	Peak





A D T



Bureau Veritas Consumer Products Services Ltd., Taoyuan Branch

A D T

Data: 5

Date: 2013-12-31

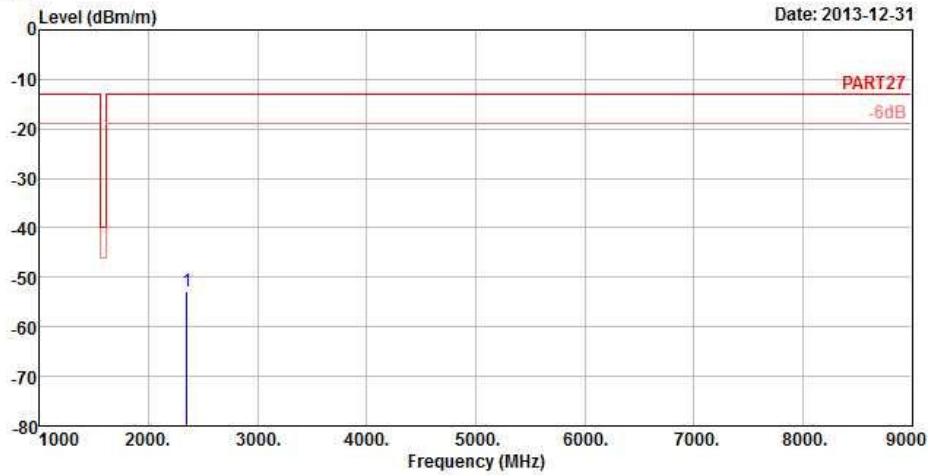

Site : 966 Chamber 5  
 Condition : PART27 3m HORIZONTAL  
 Brand/Model: 0P6B200  
 Remark : Band 13\_10M\_QPSK(50,0) Link  
 Tested by : Johnson Liao  
 Temperature : 25°C  
 Humidity : 65%  
 Plane : X

	Read	Limit	Over		
Freq	Level	Level	Line	Limit	Factor Remark
MHz	dBm/m	dBm	dBm/m	dB	dB/m
1 pp 2346.00	-52.85	-42.24	-13.00	-39.85	-10.61 Peak



A D T



Bureau Veritas Consumer Products Services Ltd., Taoyuan Branch

A D T

Data: 6

Date: 2013-12-31

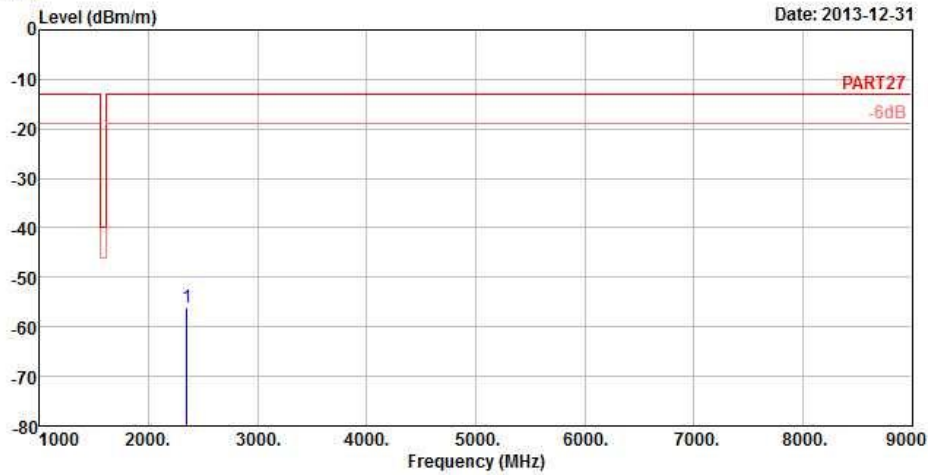

Site : 966 Chamber 5  
 Condition : PART27 3m VERTICAL  
 Brand/Model: 0P6B200  
 Remark : Band 13\_10M\_QPSK(50,0) Link  
 Tested by : Johnson Liao  
 Temperature : 25°C  
 Humidity : 65%  
 Plane : X

Freq	Level	Read Level	Limit Line	Over Limit	Factor	Remark
MHz	dBm/m	dBm	dBm/m	dB	dB/m	
1 pp 2346.00	-56.19	-45.58	-13.00	-43.19	-10.61	Peak

**LTE BAND 4**

**CHANNEL BANDWIDTH: 5MHz / QPSK**



Bureau Veritas Consumer Products Services Ltd., Taoyuan Branch

A D T

Data: 15

Date: 2013-12-28

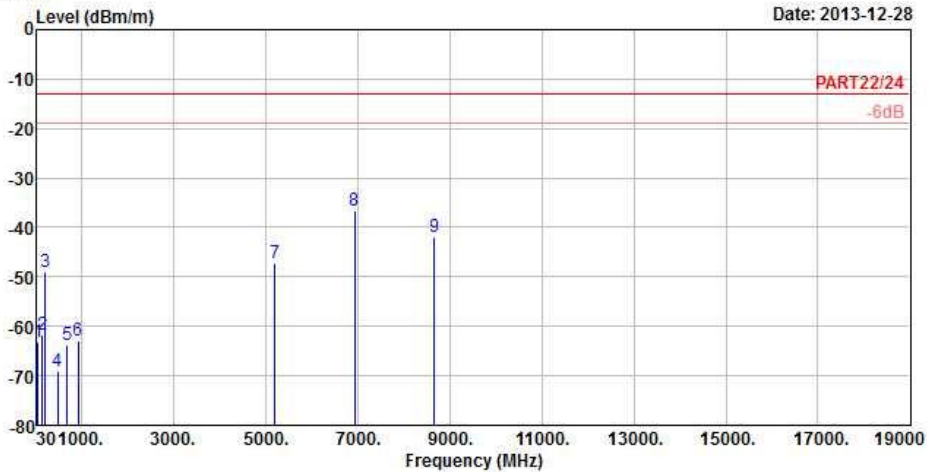

Site : 966 Chamber 5  
 Condition : PART22/24 3m HORIZONTAL  
 Brand/Model: 0P6B200  
 Remark : Band 4\_5M\_QPSK(1,12) Link  
 Tested by : Johnson Liao  
 Temperature : 25°C  
 Humidity : 65%  
 Plane : Z

	Freq	Level	Read	Limit	Over	
	MHz	dBm/m	Level	Line	Limit	Factor Remark
			dBm	dBm/m	dB	dB/m
1	57.27	-63.14	-57.49	-13.00	-50.14	-5.65 Peak
2	144.48	-61.75	-55.77	-13.00	-48.75	-5.98 Peak
3	213.06	-48.95	-41.61	-13.00	-35.95	-7.34 Peak
4	473.60	-69.21	-65.43	-13.00	-56.21	-3.78 Peak
5	694.10	-63.65	-65.00	-13.00	-50.65	1.35 Peak
6	925.10	-62.98	-66.18	-13.00	-49.98	3.20 Peak
7	5197.50	-47.31	-44.25	-13.00	-34.31	-3.06 Peak
8 pp	6930.00	-36.49	-38.79	-13.00	-23.49	2.30 Peak
9	8662.50	-41.79	-46.74	-13.00	-28.79	4.95 Peak



A D T



Bureau Veritas Consumer Products Services Ltd., Taoyuan Branch

A D T

Data: 16

Date: 2013-12-28

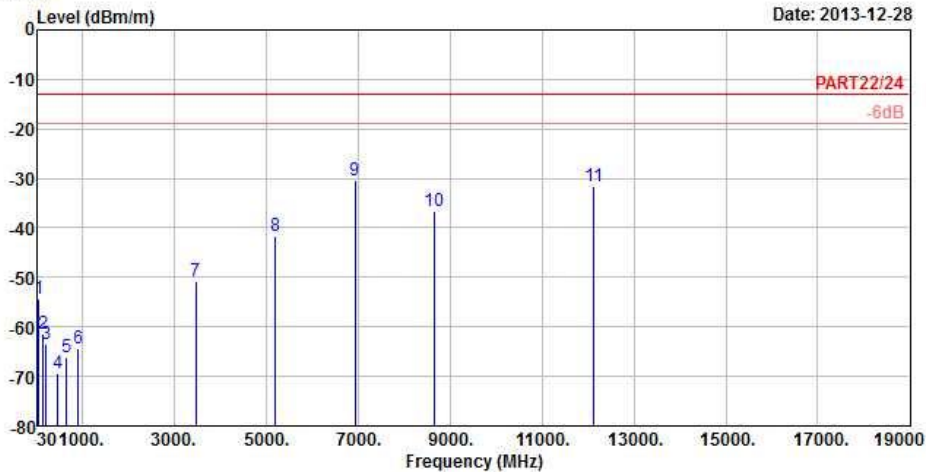

Site : 966 Chamber 5  
 Condition : PART22/24 3m VERTICAL  
 Brand/Model: 0P6B200  
 Remark : Band 4\_5M\_QPSK(1,12) Link  
 Tested by : Johnson Liao  
 Temperature : 25°C  
 Humidity : 65%  
 Plane : Z

	Freq	Level	Read	Limit	Over	
	MHz	dBm/m	Level	Line	Limit	Factor Remark
			dBm	dBm/m	dB	dB/m
1	58.08	-54.40	-48.60	-13.00	-41.40	-5.80 Peak
2	144.75	-61.50	-55.52	-13.00	-48.50	-5.98 Peak
3	217.38	-63.52	-56.36	-13.00	-50.52	-7.16 Peak
4	469.40	-69.36	-65.49	-13.00	-56.36	-3.87 Peak
5	657.70	-66.20	-66.88	-13.00	-53.20	0.68 Peak
6	909.70	-64.28	-67.17	-13.00	-51.28	2.89 Peak
7	3465.00	-50.65	-41.63	-13.00	-37.65	-9.02 Peak
8	5197.50	-41.60	-38.54	-13.00	-28.60	-3.06 Peak
9 pp	6930.00	-30.45	-32.75	-13.00	-17.45	2.30 Peak
10	8662.50	-36.70	-41.65	-13.00	-23.70	4.95 Peak
11	12127.50	-31.71	-40.12	-13.00	-18.71	8.41 Peak

**CHANNEL BANDWIDTH: 10MHz / QPSK**



Bureau Veritas Consumer Products Services Ltd., Taoyuan Branch

A D T

Data: 11

Date: 2013-12-28

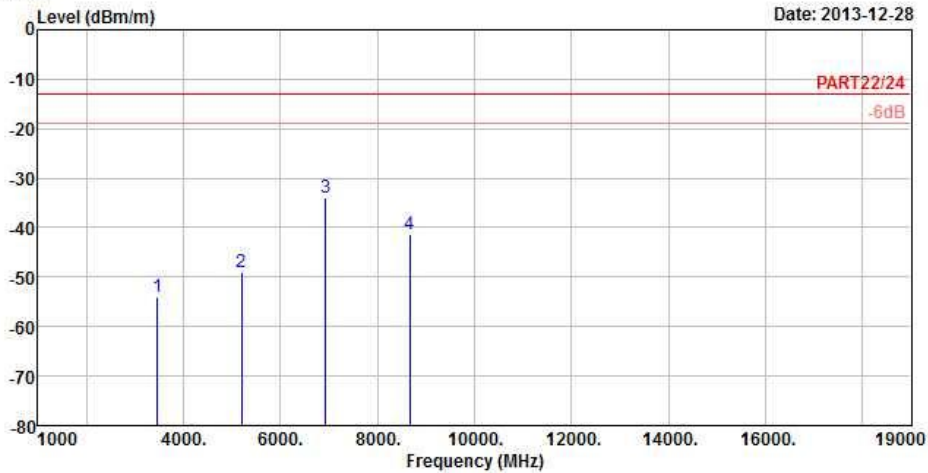

Site : 966 Chamber 5  
 Condition : PART22/24 3m HORIZONTAL  
 Brand/Model: 0P6B200  
 Remark : Band 4\_10M\_QPSK(1,24) Link  
 Tested by : Johnson Liao  
 Temperature : 25°C  
 Humidity : 65%  
 Plane : Z

	Freq	Level	Read	Limit	Over	
	MHz	dBm/m	Level	Line	Limit	Factor Remark
			dBm	dBm/m	dB	dB/m
1	3465.00	-54.10	-45.08	-13.00	-41.10	-9.02 Peak
2	5197.50	-49.13	-46.07	-13.00	-36.13	-3.06 Peak
3 pp	6930.00	-33.95	-36.25	-13.00	-20.95	2.30 Peak
4	8662.50	-41.34	-46.29	-13.00	-28.34	4.95 Peak



A D T



Bureau Veritas Consumer Products Services Ltd., Taoyuan Branch

A D T

Data: 12

Date: 2013-12-28

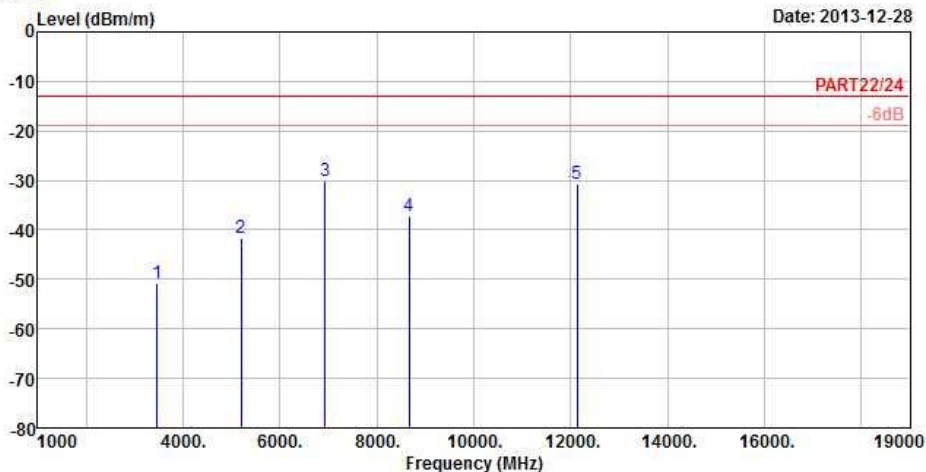

Site : 966 Chamber 5  
 Condition : PART22/24 3m VERTICAL  
 Brand/Model: 0P6B200  
 Remark : Band 4\_10M\_QPSK(1,24) Link  
 Tested by : Johnson Liao  
 Temperature : 25°C  
 Humidity : 65%  
 Plane : Z

	Freq	Level	Read Level	Limit Line	Over Limit	Factor	Remark
	MHz	dBm/m	dBm	dBm/m	dB	dB/m	
1	3465.00	-50.64	-41.62	-13.00	-37.64	-9.02	Peak
2	5197.50	-41.56	-38.50	-13.00	-28.56	-3.06	Peak
3 pp	6930.00	-30.09	-32.39	-13.00	-17.09	2.30	Peak
4	8662.50	-37.16	-42.11	-13.00	-24.16	4.95	Peak
5	12127.50	-30.67	-39.08	-13.00	-17.67	8.41	Peak



A D T

### CHANNEL BANDWIDTH: 15MHz / QPSK



Bureau Veritas Consumer Products Services Ltd., Taoyuan Branch

A D T

Data: 11

Date: 2013-12-28

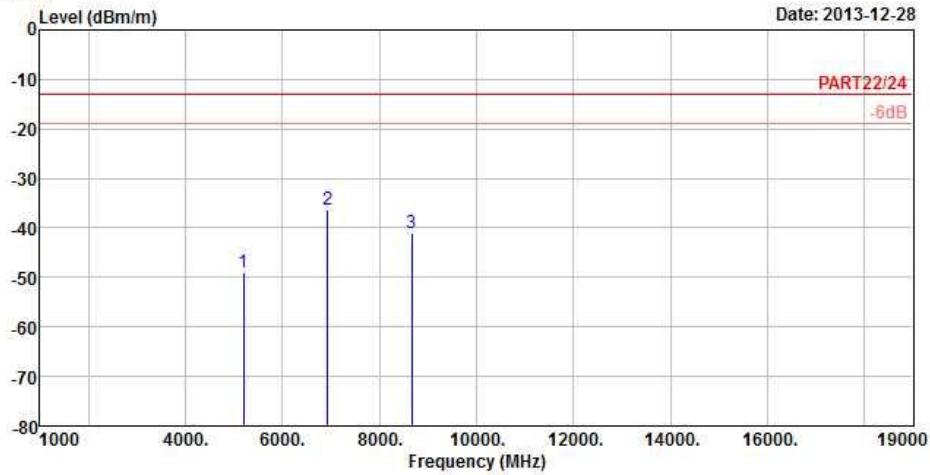

Site : 966 Chamber 5  
 Condition : PART22/24 3m HORIZONTAL  
 Brand/Model: 0P6B200  
 Remark : Band 4\_15M\_QPSK(1,37) Link  
 Tested by : Johnson Liao  
 Temperature : 25°C  
 Humidity : 65%  
 Plane : Z

	Freq	Level	Read	Limit	Over	
	MHz	dBm/m	Level	Line	Limit	Factor Remark
			dBm	dBm/m	dB	dB/m
1	5197.50	-49.08	-46.02	-13.00	-36.08	-3.06 Peak
2	pp 6930.00	-36.28	-38.58	-13.00	-23.28	2.30 Peak
3	8662.50	-40.99	-45.94	-13.00	-27.99	4.95 Peak



A D T



Bureau Veritas Consumer Products Services Ltd., Taoyuan Branch

A D T

Data: 12

Date: 2013-12-28

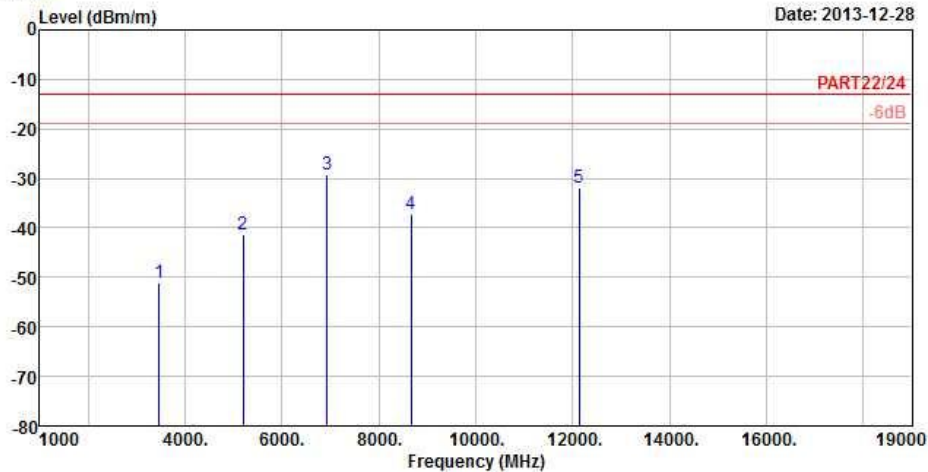

Site : 966 Chamber 5  
 Condition : PART22/24 3m VERTICAL  
 Brand/Model: 0P6B200  
 Remark : Band 4\_15M\_QPSK(1,37) Link  
 Tested by : Johnson Liao  
 Temperature : 25°C  
 Humidity : 65%  
 Plane : Z

	Freq	Level	Read Level	Limit Line	Over Limit	Factor	Remark
	MHz	dBm/m	dBm	dBm/m	dB	dB/m	
1	3465.00	-51.20	-42.18	-13.00	-38.20	-9.02	Peak
2	5197.50	-41.32	-38.26	-13.00	-28.32	-3.06	Peak
3 pp	6930.00	-29.31	-31.61	-13.00	-16.31	2.30	Peak
4	8662.50	-37.26	-42.21	-13.00	-24.26	4.95	Peak
5	12127.50	-31.87	-40.28	-13.00	-18.87	8.41	Peak





A D T

### CHANNEL BANDWIDTH: 20MHz / QPSK



Bureau Veritas Consumer Products Services Ltd., Taoyuan Branch

A D T

Data: 11

Date: 2013-12-28

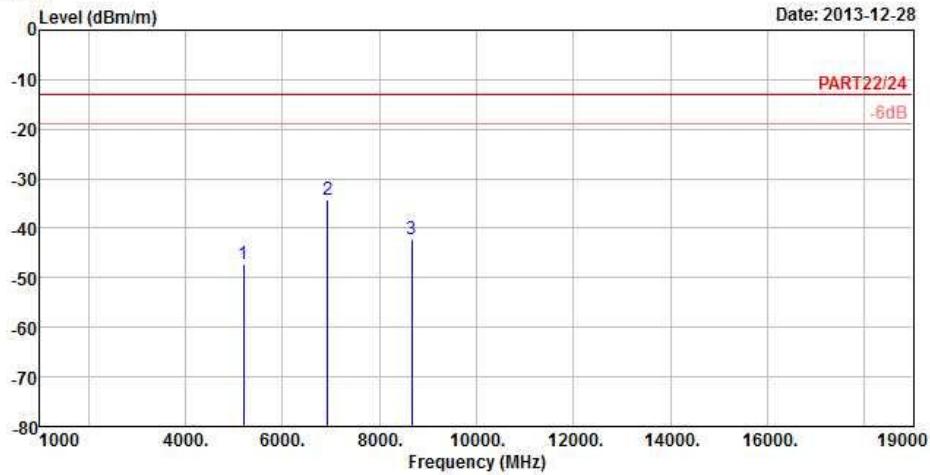

Site : 966 Chamber 5  
 Condition : PART22/24 3m HORIZONTAL  
 Brand/Model: 0P6B200  
 Remark : Band 4\_20M\_QPSK(1,50) Link  
 Tested by : Johnson Liao  
 Temperature : 25°C  
 Humidity : 65%  
 Plane : Z

	Freq	Level	Read Level	Limit Line	Over Limit	Factor	Remark
	MHz	dBm/m	dBm	dBm/m	dB	dB/m	
1	5197.50	-47.33	-44.27	-13.00	-34.33	-3.06	Peak
2	pp 6930.00	-34.29	-36.59	-13.00	-21.29	2.30	Peak
3	8662.50	-42.21	-47.16	-13.00	-29.21	4.95	Peak



A D T



Bureau Veritas Consumer Products Services Ltd., Taoyuan Branch

A D T

Data: 12

Date: 2013-12-28

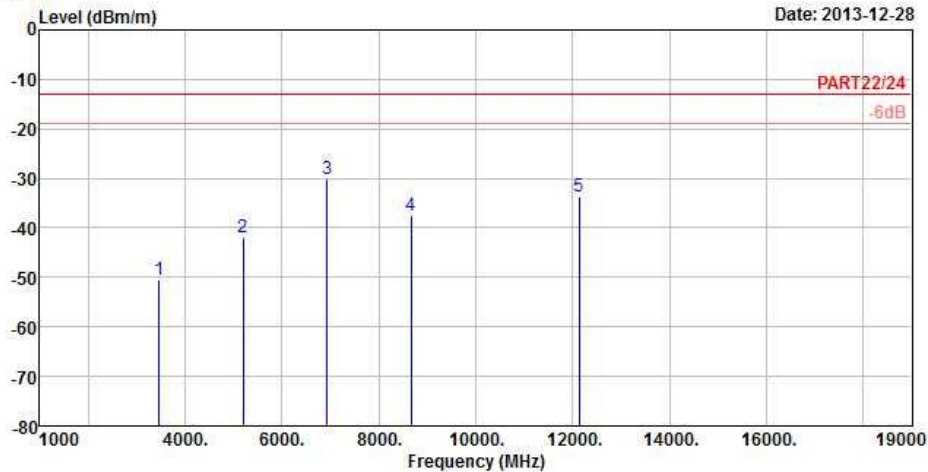

Site : 966 Chamber 5  
 Condition : PART22/24 3m VERTICAL  
 Brand/Model: 0P6B200  
 Remark : Band 4\_20M\_QPSK(1,50) Link  
 Tested by : Johnson Liao  
 Temperature : 25°C  
 Humidity : 65%  
 Plane : Z

	Freq	Level	Read Level	Limit Line	Over Limit	Factor	Remark
	MHz	dBm/m	dBm	dBm/m	dB	dB/m	
1	3465.00	-50.52	-41.50	-13.00	-37.52	-9.02	Peak
2	5197.50	-41.78	-38.72	-13.00	-28.78	-3.06	Peak
3 pp	6930.00	-30.04	-32.34	-13.00	-17.04	2.30	Peak
4	8662.50	-37.44	-42.39	-13.00	-24.44	4.95	Peak
5	12127.50	-33.70	-42.11	-13.00	-20.70	8.41	Peak

## 5 INFORMATION ON THE TESTING LABORATORIES

We, Bureau Veritas Consumer Products Services (H.K.) Ltd., Taoyuan Branch, were founded in 1988 to provide our best service in EMC, Radio, Telecom and Safety consultation. Our laboratories are accredited and approved according to ISO/IEC 17025.

If you have any comments, please feel free to contact us at the following:

**Linko EMC/RF Lab:**

Tel: 886-2-26052180

Fax: 886-2-26051924

**Hsin Chu EMC/RF Lab:**

Tel: 886-3-5935343

Fax: 886-3-5935342

**Hwa Ya EMC/RF/Safety/Telecom Lab:**

Tel: 886-3-3183232

Fax: 886-3-3270892

**Email:** [service.adt@tw.bureauveritas.com](mailto:service.adt@tw.bureauveritas.com)

**Web Site:** [www.adt.com.tw](http://www.adt.com.tw)

The address and road map of all our labs can be found in our web site also.

## 6 APPENDIX A – MODIFICATIONS RECORDERS FOR ENGINEERING CHANGES TO THE EUT BY THE LAB

No modifications were made to the EUT by the lab during the test.

---END---