



FCC TEST REPORT (PART 22)

REPORT NO.: RF131023C29-5
MODEL NO.: 0P6B200
FCC ID: NM80P6B200
RECEIVED: Oct. 23, 2013
TESTED: Dec. 18, 2013 ~ Jan. 02, 2014
ISSUED: Jan. 09, 2014

APPLICANT: HTC Corporation

ADDRESS: No. 23,Xinghua Rd.,Taoyuan 330,Taiwan,R.O.C.

ISSUED BY: Bureau Veritas Consumer Products Services
(H.K.) Ltd., Taoyuan Branch

LAB ADDRESS: No. 47, 14th Ling, Chia Pau Vil., Lin Kou Dist., New
Taipei City, Taiwan (R.O.C.)

TEST LOCATION: No. 19, Hwa Ya 2nd Rd, Wen Hwa Tsuen, Kwei
Shan Hsiang, Taoyuan Hsien 333, Taiwan, R.O.C.

This report should not be used by the client to claim
product certification, approval, or endorsement by TAF or
any government agencies.



This report is for your exclusive use. Any copying or replication of this report to or for any other person or entity, or use of our name or trademark, is permitted only with our prior written permission. This report sets forth our findings solely with respect to the test samples identified herein. The results set forth in this report are not indicative or representative of the quality or characteristics of the lot from which a test sample was taken or any similar or identical product unless specifically and expressly noted. Our report includes all of the tests requested by you and the results thereof based upon the information that you provided to us. You have 60 days from date of issuance of this report to notify us of any material error or omission caused by our negligence, provided, however, that such notice shall be in writing and shall specifically address the issue you wish to raise. A failure to raise such issue within the prescribed time shall constitute your unqualified acceptance of the completeness of this report, the tests conducted and the correctness of the report contents. Unless specific mention, the uncertainty of measurement has been explicitly taken into account to declare the compliance or non-compliance to the specification

TABLE OF CONTENTS

RELEASE CONTROL RECORD.....	3
1 CERTIFICATION	4
2 SUMMARY OF TEST RESULTS.....	5
2.1 MEASUREMENT UNCERTAINTY	5
2.2 TEST SITE AND INSTRUMENTS	6
3 GENERAL INFORMATION	7
3.1 GENERAL DESCRIPTION OF EUT	7
3.2 CONFIGURATION OF SYSTEM UNDER TEST	8
3.3 DESCRIPTION OF SUPPORT UNITS	8
3.4 TEST ITEM AND TEST CONFIGURATION	9
3.5 EUT OPERATING CONDITIONS	11
3.6 GENERAL DESCRIPTION OF APPLIED STANDARDS	11
4 TEST TYPES AND RESULTS.....	12
4.1 OUTPUT POWER MEASUREMENT	12
4.1.1 LIMITS OF OUTPUT POWER MEASUREMENT	12
4.1.2 TEST PROCEDURES	12
4.1.3 TEST SETUP	13
4.1.4 TEST RESULTS	14
4.2 FREQUENCY STABILITY MEASUREMENT	18
4.2.1 LIMITS OF FREQUENCY STABILITY MEASUREMENT	18
4.2.2 TEST PROCEDURE	18
4.2.3 TEST SETUP	18
4.2.4 TEST RESULTS	19
4.3 OCCUPIED BANDWIDTH MEASUREMENT	20
4.3.1 TEST PROCEDURES	20
4.3.2 TEST SETUP	20
4.3.3 TEST RESULTS	21
4.4 BAND EDGE MEASUREMENT	22
4.4.1 LIMITS OF BAND EDGE MEASUREMENT	22
4.4.2 TEST SETUP	22
4.4.3 TEST PROCEDURES	22
4.4.4 TEST RESULTS	23
4.5 CONDUCTED SPURIOUS EMISSIONS.....	25
4.5.1 LIMITS OF CONDUCTED SPURIOUS EMISSIONS MEASUREMENT.....	25
4.5.2 TEST PROCEDURE	25
4.5.3 TEST SETUP	25
4.5.4 TEST RESULTS	26
4.6 RADIATED EMISSION MEASUREMENT	27
4.6.1 LIMITS OF RADIATED EMISSION MEASUREMENT	27
4.6.2 TEST PROCEDURES	27
4.6.3 DEVIATION FROM TEST STANDARD	27
4.6.4 TEST SETUP	28
4.6.5 TEST RESULTS	29
5 PHOTOGRAPHS OF THE TEST CONFIGURATION	39
6 INFORMATION ON THE TESTING LABORATORIES	40
7 APPENDIX A – MODIFICATIONS RECORDERS FOR ENGINEERING CHANGES TO THE EUT BY THE LAB.....	41



A D T

RELEASE CONTROL RECORD

ISSUE NO.	REASON FOR CHANGE	DATE ISSUED
RF131023C29-5	Original release	Jan. 09, 2014



1 CERTIFICATION

PRODUCT: Smartphone

MODEL: OP6B200

BRAND: HTC

APPLICANT: HTC Corporation

TESTED: Dec. 18, 2013 ~ Jan. 02, 2014

TEST SAMPLE: Production Unit

STANDARDS: FCC PART 22, Subpart H

The above equipment (model: OP6B200) has been tested by **Bureau Veritas Consumer Products Services (H.K.) Ltd., Taoyuan Branch**, and found compliance with the requirement of the above standards. The test record, data evaluation & Equipment Under Test (EUT) configurations represented herein are true and accurate accounts of the measurements of the sample's EMC characteristics under the conditions specified in this report.

PREPARED BY : Ivonne Wu , **DATE** : Jan. 09, 2014
Ivonne Wu / Supervisor

APPROVED BY : Sam Chen , **DATE** : Jan. 09, 2014
Sam Chen / Senior Project Engineer

2 SUMMARY OF TEST RESULTS

The EUT has been tested according to the following specifications:

APPLIED STANDARD: FCC Part 22 & Part 2			
STANDARD SECTION	TEST TYPE	RESULT	REMARK
2.1046 22.913 (a)	Effective radiated power	PASS	Meet the requirement of limit.
2.1055 22.355	Frequency Stability	PASS	Meet the requirement of limit.
2.1049	Occupied Bandwidth	PASS	Meet the requirement of limit.
22.917	Band Edge Measurements	PASS	Meet the requirement of limit.
2.1051 22.917	Conducted Spurious Emissions	PASS	Meet the requirement of limit.
2.1053 22.917	Radiated Spurious Emissions	PASS	Meet the requirement of limit. Minimum passing margin is -18.25dB at 2509.20MHz.

2.1 MEASUREMENT UNCERTAINTY

Where relevant, the following measurement uncertainty levels have been estimated for tests performed on the EUT as specified in CISPR 16-4-2:

MEASUREMENT	FREQUENCY	UNCERTAINTY
Conducted emissions	150kHz~30MHz	2.44 dB
Radiated emissions	30MHz ~ 200MHz	2.93 dB
	200MHz ~1000MHz	2.95 dB
	1GHz ~ 18GHz	2.26 dB
	18GHz ~ 40GHz	1.94 dB

This uncertainty represents an expanded uncertainty expressed at approximately the 95% confidence level using a coverage factor of k=2.

2.2 TEST SITE AND INSTRUMENTS

DESCRIPTION & MANUFACTURER	MODEL NO.	SERIAL NO.	DATE OF CALIBRATION	DUE DATE OF CALIBRATION
Test Receiver ROHDE & SCHWARZ	ESCI	100744	Apr. 15, 2013	Apr. 14, 2014
Spectrum Analyzer ROHDE & SCHWARZ	FSU43	101261	Dec. 21, 2013	Dec. 20, 2014
BILOG Antenna SCHWARZBECK	VULB9168	9168-472	Mar. 25, 2013	Mar. 24, 2014
HORN Antenna SCHWARZBECK	BBHA 9120 D	9120D-969	Jan. 07, 2013	Jan. 06, 2014
HORN Antenna SCHWARZBECK	BBHA 9170	9170-480	Dec. 18, 2013	Dec. 17, 2014
Loop Antenna	HFH2-Z2	100070	Jan. 31, 2012	Jan. 30, 2014
Preamplifier EMCI	EMC 330H	980112	Dec. 27, 2013	Dec. 26, 2014
RF signal cable HUBER+SUHNNER	SUCOFLEX 104	309219/4 2950114	Oct. 18, 2013	Oct. 17, 2014
RF signal cable HUBER+SUHNNER	SUCOFLEX 104	250130/4	Oct. 18, 2013	Oct. 17, 2014
RF signal cable Worken	RG-213	NA	Nov. 07, 2013	Nov. 06, 2014
Software BV ADT	E3 6.120103	NA	NA	NA
Antenna Tower MF	MFA-440H	NA	NA	NA
Turn Table MF	MFT-201SS	NA	NA	NA
Antenna Tower & Turn Table Controller MF	MF-7802	NA	NA	NA
Mini-Circuits Power Splitter	ZN2PD-9G	NA	Jul. 18, 2013	Jul. 17, 2014
JFW 20dB attenuation	50HF-020-SMA	NA	NA	NA
Communications Tester-Wireless	E5515C	MY52102544	Sep. 05, 2012	Sep. 04, 2014
Radio Communication Analyzer	MT8820C	6201300640	Aug. 01, 2013	Jul. 31, 2014

- NOTE:**
1. The calibration interval of the above test instruments is 12 months and the calibrations are traceable to NML/ROC and NIST/USA.
 2. The test was performed in HwaYa Chamber 10.
 3. The horn antenna and HP preamplifier (model: 8449B) are used only for the measurement of emission frequency above 1GHz if tested.
 4. The FCC Site Registration No. is 690701.
 5. The IC Site Registration No. is IC 7450F-10.

3 GENERAL INFORMATION

3.1 GENERAL DESCRIPTION OF EUT

EUT	Smartphone	
MODEL NO.	0P6B200	
POWER SUPPLY	5.0Vdc (adapter or host equipment) 3.8Vdc (battery)	
MODULATION TYPE	GSM/GPRS	GMSK
	EDGE	GMSK, 8PSK
	WCDMA	BPSK
	CDMA	QPSK, OQPSK, HPSK
FREQUENCY RANGE	GSM/GPRS/EDGE	824.2MHz ~ 848.8MHz
	WCDMA	826.4MHz ~ 846.6MHz
	CDMA	824.7MHz ~ 848.31MHz
MAX. ERP POWER	GSM	792.50mW
	EDGE	276.69mW
	WCDMA	72.11mW
	CDMA	62.81mW
EMISSION DESIGNATOR	GSM	247KGXW
	EDGE	247KG7W
	WCDMA	4M18F9W
	CDMA	1M27F9W
ANTENNA TYPE	Fixed Internal Antenna	
I/O PORTS	Refer to users' manual	
DATA CABLE	Refer to NOTE as below	
ACCESSORY DEVICES	Refer to NOTE as below	

NOTE:

- The EUT's accessories list refers to Ext. Pho.
- There're 2 configurations for the EUT listed as below.
 Main Sample (A): Battery 1 + LCD Panel 1
 2nd Sample (B): Battery 2 + LCD Panel 2
 ✧ Only the worst test data was presented in the report.
- The above EUT information was declared by manufacturer and for more detailed features description, please refer to the manufacturer's specifications or User's Manual.

3.2 CONFIGURATION OF SYSTEM UNDER TEST

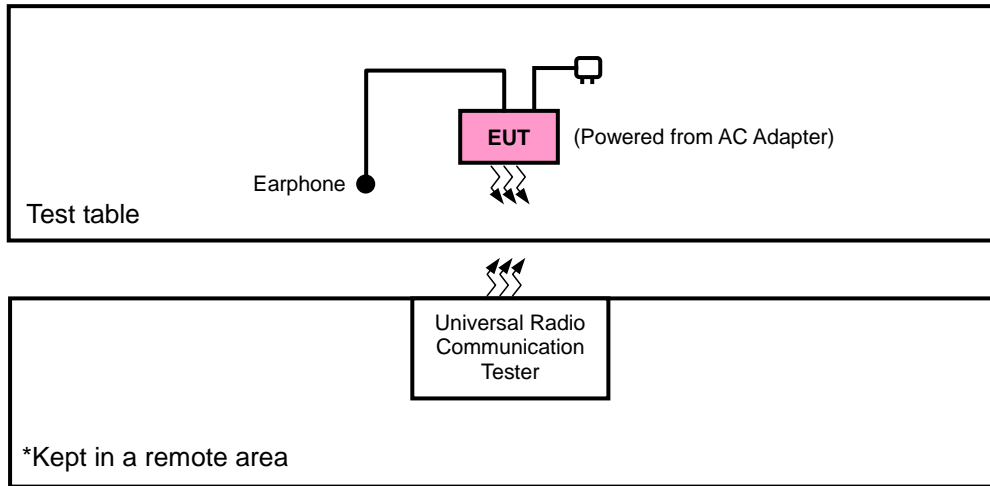

3.3 DESCRIPTION OF SUPPORT UNITS

The EUT has been tested as an independent unit together with other necessary accessories or support units.

3.4 TEST ITEM AND TEST CONFIGURATION

Pre-Scan has been conducted to determine the worst-case mode from all possible combinations between available modulations, data rates, XYZ axis and antenna ports. The worst case was found when positioned on X-axis for radiated emission. Following channel(s) was (were) selected for the final test as listed below:

EUT CONFIGURE MODE	DESCRIPTION
A	Main sample
B	2 nd sample

GSM MODE

EUT CONFIGURE MODE	TEST ITEM	AVAILABLE CHANNEL	TESTED CHANNEL	MODE
A	ERP	128 to 251	128, 189, 251	GSM, EDGE
B	ERP	128 to 251	189	GSM
A	FREQUENCY STABILITY	128 to 251	189	GSM, EDGE
A	OCCUPIED BANDWIDTH	128 to 251	128, 189, 251	GSM, EDGE
A	BAND EDGE	128 to 251	128, 251	GSM, EDGE
A	CONDCUDED EMISSION	128 to 251	189	GSM, EDGE
A	RADIATED EMISSION	128 to 251	189	GSM, EDGE
B	RADIATED EMISSION	128 to 251	189	GSM

WCDMA MODE

EUT CONFIGURE MODE	TEST ITEM	AVAILABLE CHANNEL	TESTED CHANNEL	MODE
A	ERP	4132 to 4233	4132, 4182, 4233	WCDMA
A	FREQUENCY STABILITY	4132 to 4233	4182	WCDMA
A	OCCUPIED BANDWIDTH	4132 to 4233	4132, 4182, 4233	WCDMA
A	BAND EDGE	4132 to 4233	4132, 4233	WCDMA
A	CONDCUDED EMISSION	4132 to 4233	4182	WCDMA
A	RADIATED EMISSION	4132 to 4233	4182	WCDMA



A D T

CDMA MODE

EUT CONFIGURE MODE	TEST ITEM	AVAILABLE CHANNEL	TESTED CHANNEL	MODE
A	ERP	1013 to 777	1013, 384, 777	1xRTT
A	FREQUENCY STABILITY	1013 to 777	384	1xRTT
A	OCCUPIED BANDWIDTH	1013 to 777	1013, 384, 777	1xRTT
A	BAND EDGE	1013 to 777	1013, 777	1xRTT
A	CONDCUDED EMISSION	1013 to 777	384	1xRTT
A	RADIATED EMISSION	1013 to 777	384	1xRTT

TEST CONDITION:

TEST ITEM	ENVIRONMENTAL CONDITIONS	INPUT POWER	TESTED BY
ERP	26deg. C, 58%RH	3.8Vdc	Howard Kao
FREQUENCY STABILITY	26deg. C, 58%RH	3.8Vdc	Howard Kao
OCCUPIED BANDWIDTH	26deg. C, 58%RH	3.8Vdc	Howard Kao
BAND EDGE	26deg. C, 58%RH	3.8Vdc	Howard Kao
CONDCUDED EMISSION	26deg. C, 58%RH	3.8Vdc	Howard Kao
RADIATED EMISSION	25deg. C, 65%RH	120Vac, 60Hz	Johnson Liao



A D T

3.5 EUT OPERATING CONDITIONS

The EUT makes a call to the communication simulator. The communication simulator station system controlled a EUT to export maximum output power under transmission mode and specific channel frequency

3.6 GENERAL DESCRIPTION OF APPLIED STANDARDS

The EUT is a RF product. According to the specifications of the manufacturer, it must comply with the requirements of the following standards:

FCC 47 CFR Part 2

FCC 47 CFR Part 22

ANSI/TIA/EIA-603-C 2004

NOTE: All test items have been performed and recorded as per the above standards.

4 TEST TYPES AND RESULTS

4.1 OUTPUT POWER MEASUREMENT

4.1.1 LIMITS OF OUTPUT POWER MEASUREMENT

Mobile / Portable station are limited to 7 watts e.r.p.

4.1.2 TEST PROCEDURES

EIRP / ERP MEASUREMENT:

- a. The EUT was placed on a turntable with 1.727 meter height in a fully anechoic chamber.
- b. The EUT was set at 4.858 meters from the receiving antenna, which was mounted on the antenna tower.
- c. The EUT was rotated along 2 axis: Theta-axis: 180 degree and Phi-axis: 360 degree, Step Size: 15 degree.
- d. The height of the receiving antenna is fixed.
- e. Taking the record of received power.
- f. A dipole antenna was used in place of the EUT for pathloss calibration with a network analyzer.
- g. The gain of the dipole antenna and the insertion loss of the connected RF cable were applied into the pathloss calibration.
- h. The maximum ERP/EIRP was calculated with received power and pathloss.
- i. $ERP/EIRP = P_s + E_t - E_s + G_s = P_s + R_t - R_s + G_s$
Ps (dBm) : Input power to substitution antenna.
Gs (dBi or dBd) : Substitution antenna Gain.
Et = Rt + AF
Es = Rs + AF
AF (dB/m) : Receiver antenna factor
Rt: The highest received signal in spectrum analyzer for EUT.
Rs: The highest received signal in spectrum analyzer for substitution antenna.

CONDUCTED POWER MEASUREMENT:

The EUT was set up for the maximum power with GSM, GPRS, EDGE, WCDMA & CDMA link data modulation and link up with simulator. Set the EUT to transmit under low, middle and high channel and record the power level shown on simulator.

4.1.3 TEST SETUP

EIRP / ERP MEASUREMENT:

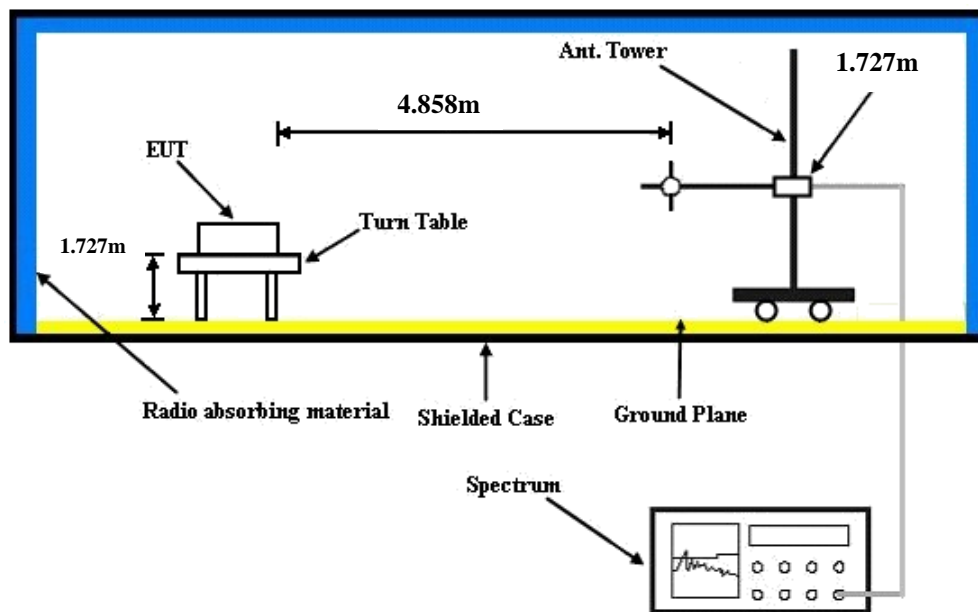

CONDUCTED POWER MEASUREMENT:

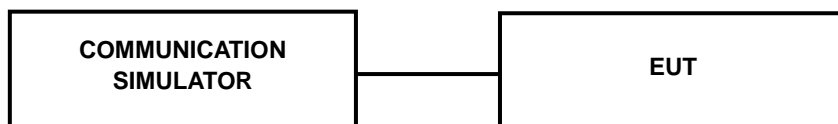

4.1.4 TEST RESULTS

CONDUCTED OUTPUT POWER (dBm)

Band	GSM850		
Channel	128	189	251
Frequency (MHz)	824.2	836.4	848.8
GSM (1 Uplink)	33.26	33.36	33.34
GPRS 8 (GMSK, 1 slot)	33.25	33.35	33.33
GPRS 10 (GMSK, 2 slot)	33.08	33.18	33.16
GPRS 11 (GMSK, 3 slot)	32.82	32.92	32.90
GPRS 12 (GMSK, 4 slot)	32.61	32.71	32.69
EDGE 8 (GMSK, 1 Uplink)	33.13	33.23	33.21
EDGE 10 (GMSK, 2 Uplink)	32.95	33.05	33.03
EDGE 11 (GMSK, 3 Uplink)	32.75	32.85	32.83
EDGE 12 (GMSK, 4 Uplink)	32.50	32.60	32.58
EDGE 8 (8PSK, 1 Uplink)	26.99	27.09	27.07
EDGE 10 (8PSK, 2 Uplink)	26.88	26.98	26.96
EDGE 11 (8PSK, 3 Uplink)	26.67	26.77	26.75
EDGE 12 (8PSK, 4 Uplink)	26.48	26.58	26.56

Band	WCDMA V		
Channel	4132	4182	4233
Frequency (MHz)	826.4	836.4	846.6
RMC 12.2K	23.37	23.35	23.25
HSDPA Subtest-1	22.31	22.29	22.19
HSDPA Subtest-2	20.66	20.64	20.54
HSDPA Subtest-3	19.26	19.24	19.14
HSDPA Subtest-4	19.02	19.00	18.90
HSUPA Subtest-1	22.38	22.36	22.26
HSUPA Subtest-2	21.22	21.20	21.10
HSUPA Subtest-3	21.36	21.34	21.24
HSUPA Subtest-4	21.90	21.88	21.78
HSUPA Subtest-5	22.36	22.34	22.24

Band	CDMA		
Channel	1013	384	777
Frequency (MHz)	824.70	836.52	848.31
RC1+SO55	24.25	24.27	24.15
RC3+SO55	24.26	24.28	24.16
RC3+SO32(+ F-SCH)	24.24	24.26	24.14
RC3+SO32(+SCH)	24.25	24.27	24.15
RTAP 153.6	24.12	24.14	24.02
RETAP 4096	24.07	24.09	23.97



A D T

ERP POWER (dBm)

TEST MODE A

GSM

GSM Radiated Power ERP						
Horizontal Polarization						
Frequency (MHz)	Rt (dBm)	Rs (dBm)	Ps (dBm)	Gs (dBd)	ERP (dBm)	ERP (mW)
824.20	-19.05	-48.12	0.00	-1.08	27.99	629.51
836.40	-18.36	-48.28	0.00	-0.93	28.99	792.50
848.80	-19.37	-48.35	0.00	-0.76	28.22	663.74
Vertical Polarization						
Frequency (MHz)	Rt (dBm)	Rs (dBm)	Ps (dBm)	Gs (dBd)	ERP (dBm)	ERP (mW)
824.20	-27.85	-47.97	0.00	-1.08	19.04	80.17
836.40	-27.84	-48.01	0.00	-0.93	19.24	83.95
848.80	-28.06	-48.05	0.00	-0.76	19.23	83.75

EDGE

EDGE Radiated Power ERP						
Horizontal Polarization						
Frequency (MHz)	Rt (dBm)	Rs (dBm)	Ps (dBm)	Gs (dBd)	ERP (dBm)	ERP (mW)
824.20	-22.79	-48.12	0.00	-1.08	24.25	266.07
836.40	-22.93	-48.28	0.00	-0.93	24.42	276.69
848.80	-23.25	-48.35	0.00	-0.76	24.34	271.64
Vertical Polarization						
Frequency (MHz)	Rt (dBm)	Rs (dBm)	Ps (dBm)	Gs (dBd)	ERP (dBm)	ERP (mW)
824.20	-31.84	-47.97	0.00	-1.08	15.05	31.99
836.40	-32.53	-48.01	0.00	-0.93	14.55	28.51
848.80	-32.39	-48.05	0.00	-0.76	14.90	30.90

WCDMA

EDGE Radiated Power ERP						
Horizontal Polarization						
Frequency (MHz)	Rt (dBm)	Rs (dBm)	Ps (dBm)	Gs (dBd)	ERP (dBm)	ERP (mW)
826.40	-28.60	-48.12	0.00	-1.08	18.44	69.82
836.40	-28.92	-48.28	0.00	-0.93	18.43	69.66
846.60	-29.01	-48.35	0.00	-0.76	18.58	72.11
Vertical Polarization						
Frequency (MHz)	Rt (dBm)	Rs (dBm)	Ps (dBm)	Gs (dBd)	ERP (dBm)	ERP (mW)
826.40	-36.75	-47.97	0.00	-1.08	10.14	10.33
836.40	-36.94	-48.01	0.00	-0.93	10.14	10.33
846.60	-36.88	-48.05	0.00	-0.76	10.41	10.99

CDMA

EDGE Radiated Power ERP						
Horizontal Polarization						
Frequency (MHz)	Rt (dBm)	Rs (dBm)	Ps (dBm)	Gs (dBd)	ERP (dBm)	ERP (mW)
824.70	-29.06	-48.12	0.00	-1.08	17.98	62.81
836.52	-29.79	-48.28	0.00	-0.93	17.56	57.02
848.31	-30.24	-48.35	0.00	-0.76	17.35	54.33
Vertical Polarization						
Frequency (MHz)	Rt (dBm)	Rs (dBm)	Ps (dBm)	Gs (dBd)	ERP (dBm)	ERP (mW)
824.70	-37.32	-47.97	0.00	-1.08	9.57	9.06
836.52	-37.75	-48.01	0.00	-0.93	9.33	8.57
848.31	-38.09	-48.05	0.00	-0.76	9.20	8.32



A D T

TEST MODE B

GSM

GSM Radiated Power ERP						
Horizontal Polarization						
Frequency (MHz)	Rt (dBm)	Rs (dBm)	Ps (dBm)	Gs (dBd)	ERP (dBm)	ERP (mW)
836.40	-18.36	-48.12	0.00	-1.08	28.68	737.90
Vertical Polarization						
Frequency (MHz)	Rt (dBm)	Rs (dBm)	Ps (dBm)	Gs (dBd)	ERP (dBm)	ERP (mW)
836.40	-29.23	-48.28	0.00	-0.93	18.12	64.86

4.2 FREQUENCY STABILITY MEASUREMENT

4.2.1 LIMITS OF FREQUENCY STABILITY MEASUREMENT

1.5 ppm is for base and fixed station. 2.5 ppm is for mobile station.

4.2.2 TEST PROCEDURE

- Device is placed at the oven room. The oven room could control the temperatures and humidity. Power warm up is at least 15 min and power applied should perform before recording frequency error.
- EUT is connected the external power supply to control the DC input power. The test voltage range is from minimum to maximum working voltage. Each step shall be record the frequency error rate.
- The temperature range step is 10 degrees in this test items. All temperature levels shall be hold the $\pm 0.5^{\circ}\text{C}$ during the measurement testing. The each temperature step shall be at least 0.5 hours, consider the EUT could be test under the stability condition.

NOTE: The frequency error was recorded frequency error from the communication simulator.

4.2.3 TEST SETUP

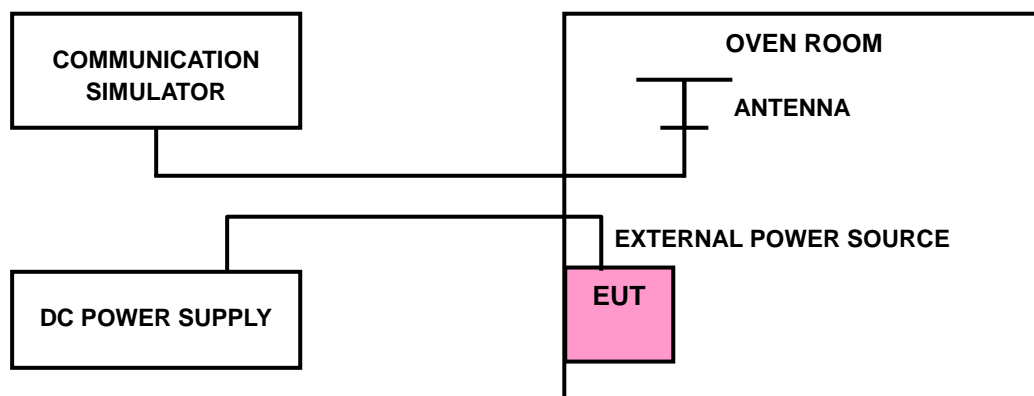

4.2.4 TEST RESULTS

FREQUENCY ERROR vs. VOLTAGE

VOLTAGE (Volts)	FREQUENCY ERROR (ppm)				LIMIT (ppm)
	GSM	EDGE	WCDMA	CDMA	
3.8	0.031	0.033	0.003	-0.002	2.5
3.6	0.032	0.033	0.003	-0.002	2.5
4.35	0.032	0.033	0.003	0.001	2.5

NOTE: The applicant defined the normal working voltage of the battery is from 3.6Vdc to 4.35Vdc.

FREQUENCY ERROR vs. TEMPERATURE

TEMP. (°C)	FREQUENCY ERROR (ppm)				LIMIT (ppm)
	GSM	EDGE	WCDMA	CDMA	
-30	0.033	0.032	0.003	0.002	2.5
-20	0.033	0.031	0.004	0.001	2.5
-10	0.031	0.033	0.003	0.002	2.5
0	0.034	0.034	0.002	0.002	2.5
10	0.034	0.031	0.003	-0.001	2.5
20	0.032	0.032	0.003	-0.001	2.5
30	0.033	0.030	0.003	-0.002	2.5
40	0.032	0.030	0.003	-0.001	2.5
50	0.033	0.033	0.003	-0.002	2.5

4.3 OCCUPIED BANDWIDTH MEASUREMENT

4.3.1 TEST PROCEDURES

The EUT makes a call to the communication simulator. All measurements were done at low, middle and high operational frequency range. The communication simulator station system controlled a EUT to export maximum output power under transmission mode and specific channel frequency. Use OBW measurement function of Spectrum analyzer to measure 99 % occupied bandwidth.

4.3.2 TEST SETUP

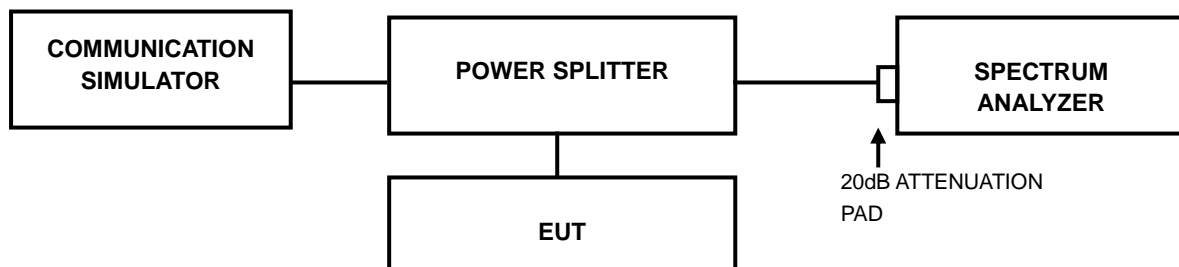

4.3.3 TEST RESULTS

CHANNEL	FREQUENCY (MHz)	99% OCCUPIED BANDWIDTH (kHz)		CHANNEL	FREQUENCY (MHz)	99% OCCUPIED BANDWIDTH (MHz)
		GSM	EDGE			WCDMA
128	824.2	246.79	235.59	4132	826.4	4.1801
189	836.4	245.04	246.93	4182	836.4	4.1811
251	848.8	240.59	244.27	4233	846.6	4.1756

CHANNEL	FREQUENCY (MHz)	99% OCCUPIED BANDWIDTH (MHz)
		CDMA
1013	824.70	1.2739
384	836.52	1.2677
777	848.31	1.2677

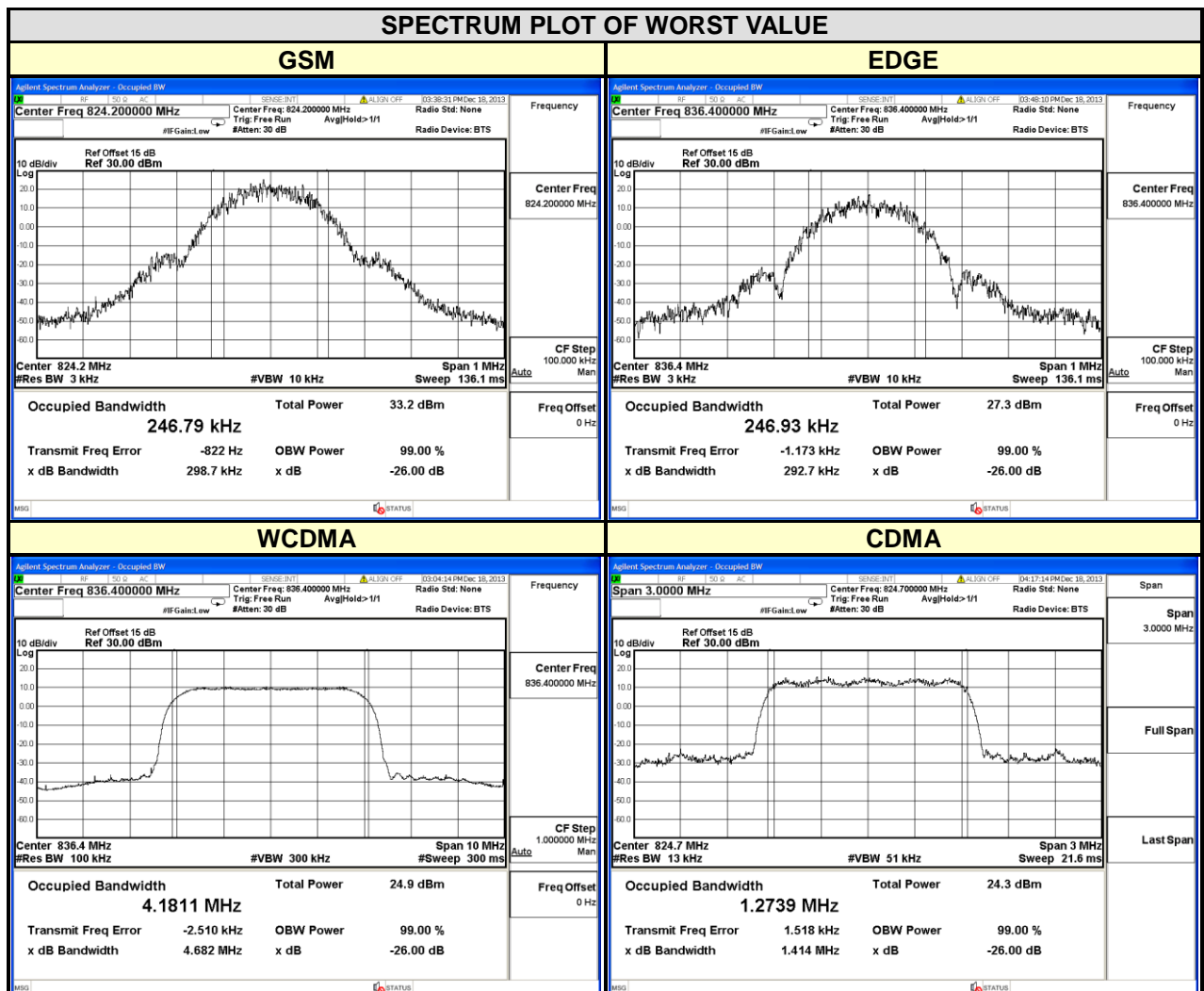

4.4 BAND EDGE MEASUREMENT

4.4.1 LIMITS OF BAND EDGE MEASUREMENT

Power of any emission outside of the authorized operating frequency ranges must be attenuated below the transmitting power (P) by a factor of at least $43 + 10 \log(P)$ dB. In the 1 MHz bands immediately outside and adjacent to the frequency block a resolution bandwidth of at least one percent of the emission bandwidth of the fundamental emission of the transmitter may be employed.

4.4.2 TEST SETUP

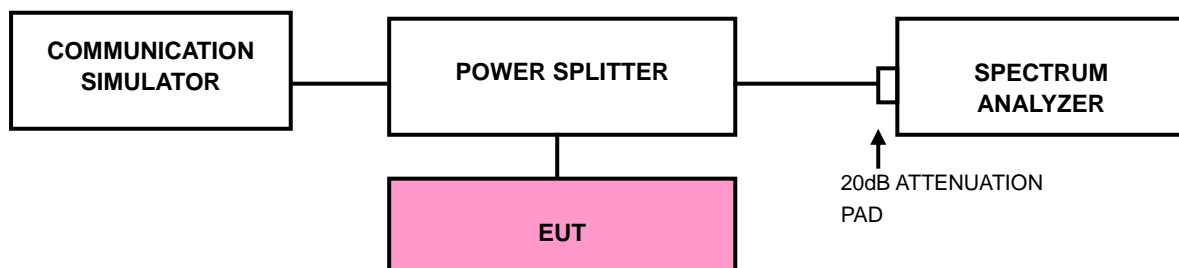

4.4.3 TEST PROCEDURES

- a. All measurements were done at low and high operational frequency range.
- b. The center frequency of spectrum is the band edge frequency and span is 1MHz. RB of the spectrum is 3kHz and VB of the spectrum is 10kHz (GSM/GPRS/EDGE).
- c. The center frequency of spectrum is the band edge frequency and span is 5MHz. RB of the spectrum is 100kHz and VB of the spectrum is 300kHz (WCDMA).
- d. The center frequency of spectrum is the band edge frequency and span is 1MHz. RB of the spectrum is 13kHz and VB of the spectrum is 51kHz (CDMA).
- e. Record the max trace plot into the test report.



A D T

4.4.4 TEST RESULTS

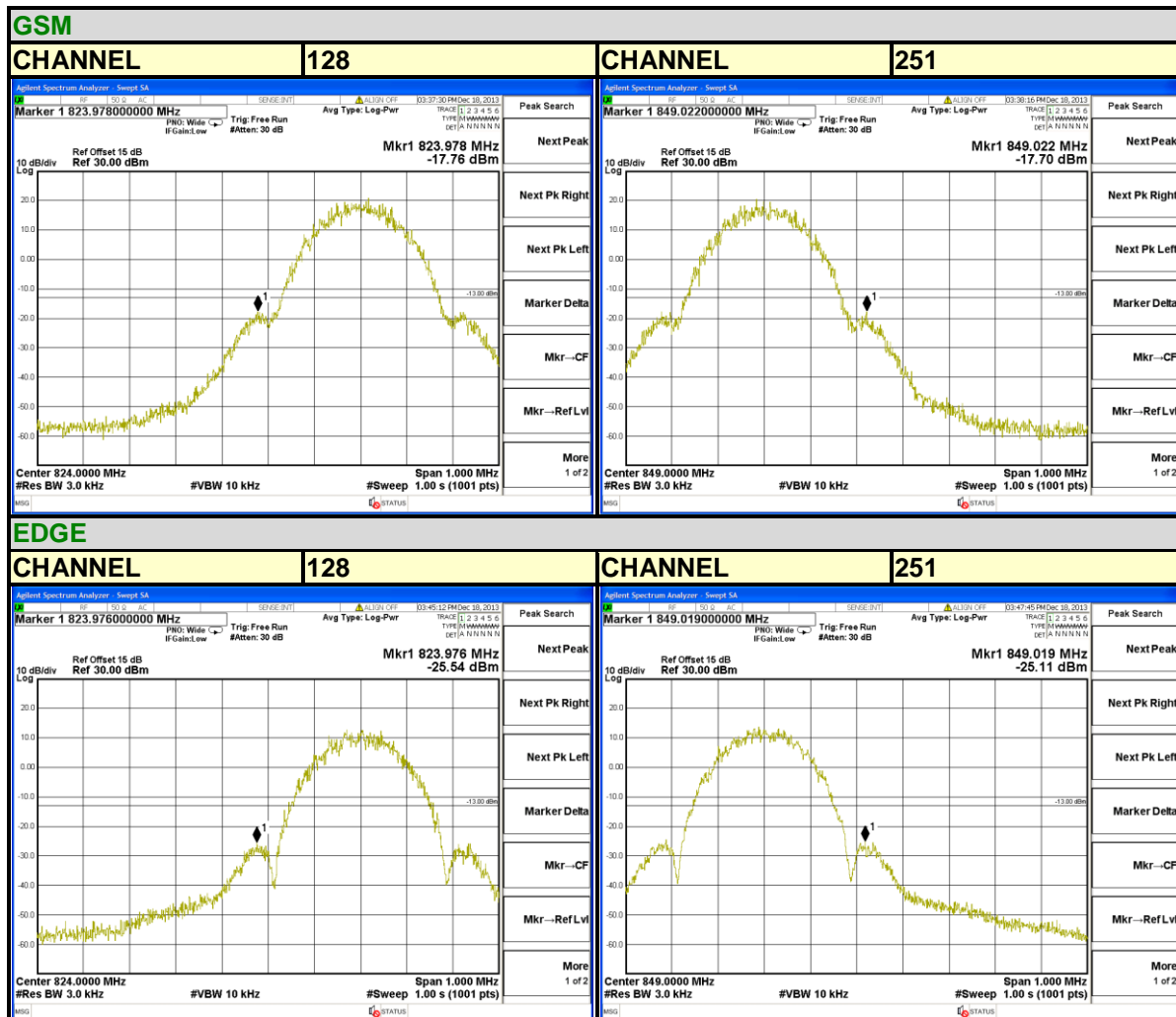



A D T

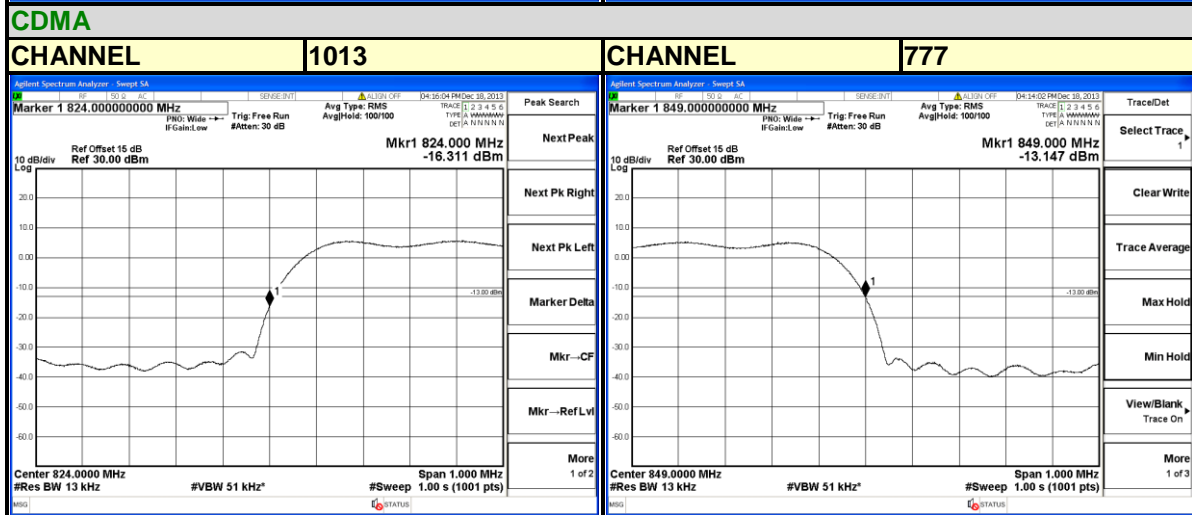
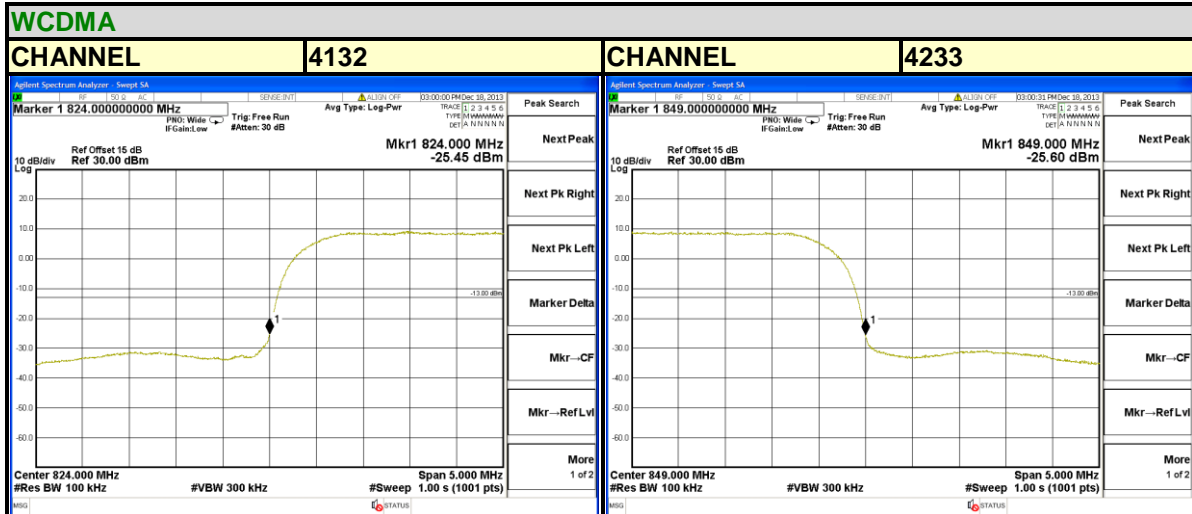

4.5 CONDUCTED SPURIOUS EMISSIONS

4.5.1 LIMITS OF CONDUCTED SPURIOUS EMISSIONS MEASUREMENT

The power of any emission outside of the authorized operating frequency ranges must be attenuated below the transmitting power (P) by a factor of at least $43 + 10 \log(P)$ dB. The emission limit equal to -13dBm .

4.5.2 TEST PROCEDURE

- a. The EUT makes a phone call to the communication simulator. All measurements were done at low, middle and high operational frequency range.
- b. Measuring frequency range is from 30 MHz to 9GHz. 10dB attenuation pad is connected with spectrum. RBW=1MHz and VBW=3MHz is used for conducted emission measurement.

4.5.3 TEST SETUP

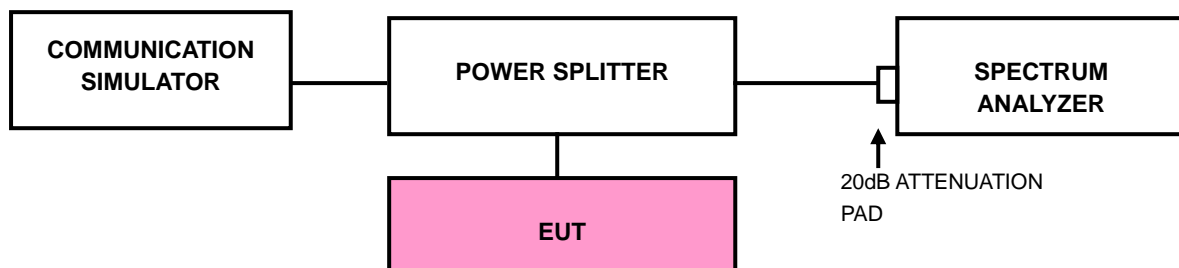



A D T

4.5.4 TEST RESULTS



4.6 RADIATED EMISSION MEASUREMENT

4.6.1 LIMITS OF RADIATED EMISSION MEASUREMENT

The power of any emission outside of the authorized operating frequency ranges must be attenuated below the transmitting power (P) by a factor of at least $43 + 10 \log(P)$ dB. The emission limit equal to -13dBm .

4.6.2 TEST PROCEDURES

- a. Substitution method is used for E.I.R.P measurement. In the semi-anechoic chamber, EUT placed on the 0.8m height of Turn Table, rotated the table around 360 degrees to search the maximum radiation power and receiver antenna shall be rotated vertical and horizontal polarization and moved height from 1m to 4m to find the maximum polar radiated power. The “Read Value” is the spectrum reading the maximum power value.
- b. The substitution horn antenna is substituted for EUT at the same position and signals generator export the CW signal to the substitution antenna via a TX cable. Rotated the Turn Table and moved receiving antenna to find the maximum radiation power. Adjust output power level of S.G to get a Value of spectrum reading equal to “Read Value” of step a. Record the power level of S.G
- c. $\text{EIRP} = \text{Output power level of S.G} - \text{TX cable loss} + \text{Antenna gain of substitution horn}$.
- d. E.R.P power can be calculated form E.I.R.P power by subtracting the gain of dipole,
 $\text{E.R.P power} = \text{E.I.R.P power} - 2.15\text{dBi}$.

NOTE: The resolution bandwidth and video bandwidth of test receiver/spectrum analyzer is 1MHz/3MHz.

4.6.3 DEVIATION FROM TEST STANDARD

No deviation

4.6.4 TEST SETUP

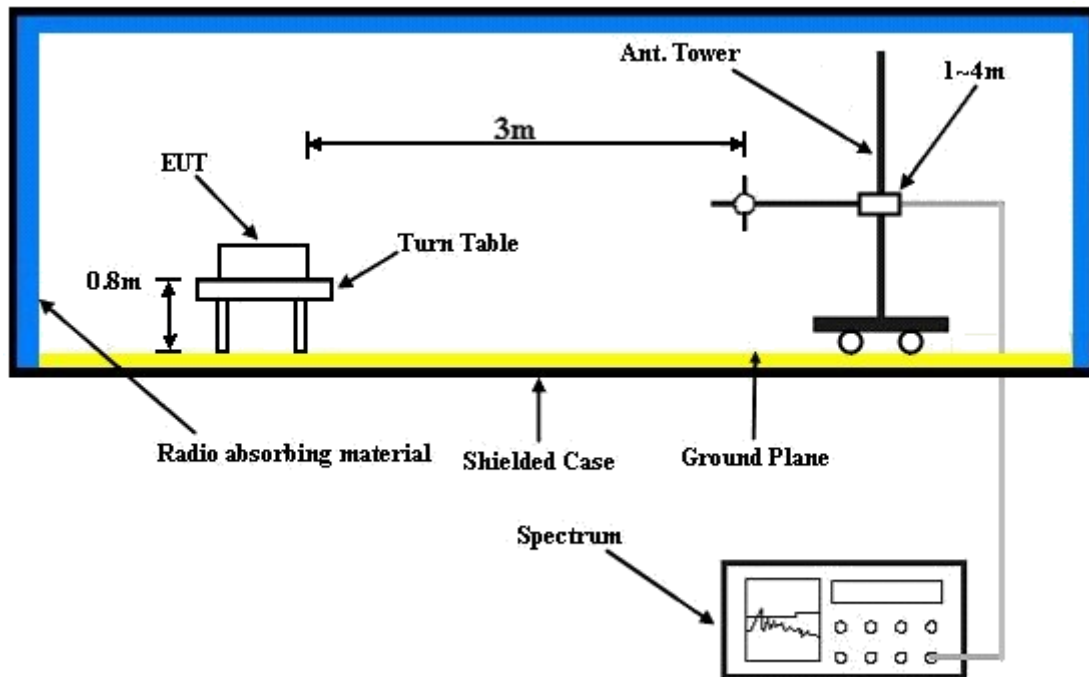

For the actual test configuration, please refer to the attached file (Test Setup Photo).

4.6.5 TEST RESULTS

TEST MODE A

GSM:



Bureau Veritas Consumer Products Services Ltd., Taoyuan Branch

A D T

Data: 9

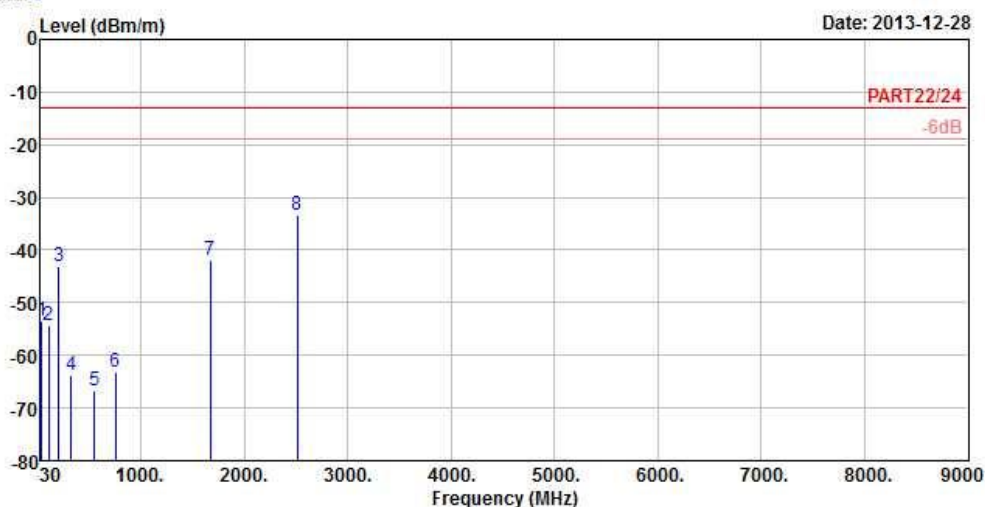

Site : 966 Chamber 5
 Condition : PART22/24 3m HORIZONTAL
 Brand/Model: 0P6B200
 Remark : GSM850 Link
 Tested by : Johnson Liao
 Temperature : 25°C
 Humidity : 65%
 Plane : X

	Freq	Level	Read Level	Limit Line	Over Limit	Factor	Remark
	MHz	dBm/m	dBm	dBm/m	dB	dB/m	
1	38.91	-53.58	-51.84	-13.00	-40.58	-1.74	Peak
2	109.92	-54.33	-43.72	-13.00	-41.33	-10.61	Peak
3	201.72	-43.19	-35.33	-13.00	-30.19	-7.86	Peak
4	328.00	-63.91	-57.74	-13.00	-50.91	-6.17	Peak
5	550.60	-66.60	-64.89	-13.00	-53.60	-1.71	Peak
6	752.90	-63.03	-64.84	-13.00	-50.03	1.81	Peak
7	1672.80	-41.87	-28.03	-13.00	-28.87	-13.84	Peak
8 pp	2509.20	-33.25	-23.26	-13.00	-20.25	-9.99	Peak



A D T

Data: 10

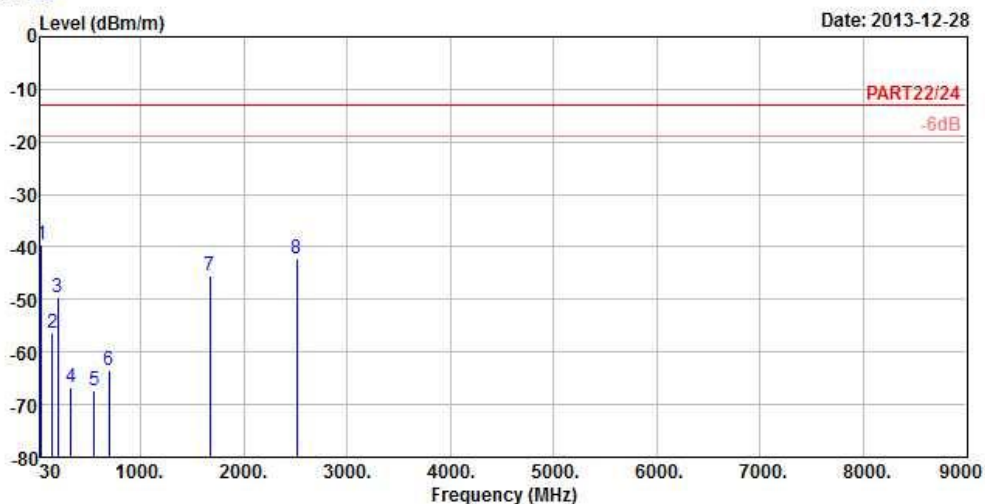

Site : 966 Chamber 5
 Condition : PART22/24 3m VERTICAL
 Brand/Model: 0P6B200
 Remark : GSM850 Link
 Tested by : Johnson Liao
 Temperature : 25°C
 Humidity : 65%
 Plane : X

	Freq	Level	Read Level	Limit Line	Over Limit	Factor	Remark
	MHz	dBm/m	dBm	dBm/m	dB	dB/m	
1	pp	39.45	-39.54	-38.01	-13.00	-26.54	-1.53 Peak
2		142.05	-56.44	-50.58	-13.00	-43.44	-5.86 Peak
3		197.40	-49.65	-41.93	-13.00	-36.65	-7.72 Peak
4		328.00	-66.80	-60.63	-13.00	-53.80	-6.17 Peak
5		549.20	-67.39	-65.63	-13.00	-54.39	-1.76 Peak
6		692.00	-63.39	-64.68	-13.00	-50.39	1.29 Peak
7		1672.80	-45.42	-31.58	-13.00	-32.42	-13.84 Peak
8		2509.20	-42.27	-32.28	-13.00	-29.27	-9.99 Peak



A D T

EDGE:



Bureau Veritas Consumer Products Services Ltd., Taoyuan Branch

A D T

Data: 5

Date: 2013-12-28

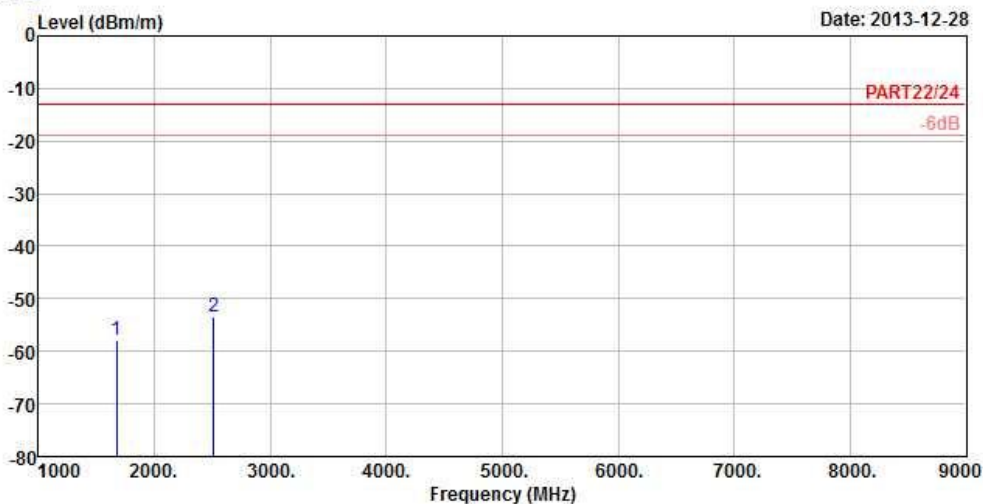

Site : 966 Chamber 5
 Condition : PART22/24 3m HORIZONTAL
 Brand/Model: 0P6B200
 Remark : EDGE850 Link
 Tested by : Johnson Liao
 Temperature : 25°C
 Humidity : 65%
 Plane : X

	Freq	Level	Read Level	Limit Line	Over Limit	Factor	Remark
	MHz	dBm/m	dBm	dBm/m	dB	dB/m	
1	1672.80	-57.81	-43.97	-13.00	-44.81	-13.84	Peak
2	2509.20	-53.32	-43.33	-13.00	-40.32	-9.99	Peak



A D T



Bureau Veritas Consumer Products Services Ltd., Taoyuan Branch

A D T

Data: 6

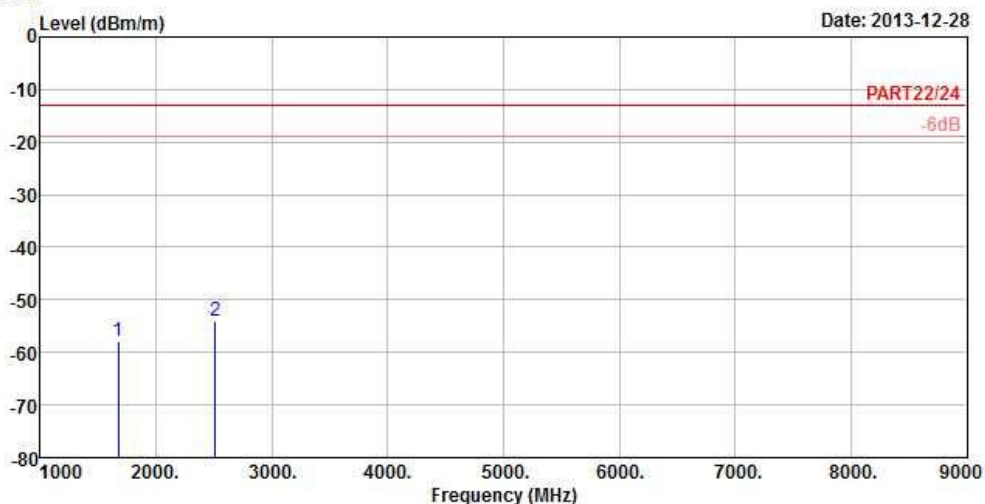

Site : 966 Chamber 5
 Condition : PART22/24 3m VERTICAL
 Brand/Model: 0P6B200
 Remark : EDGE850 Link
 Tested by : Johnson Liao
 Temperature : 25°C
 Humidity : 65%
 Plane : X

	Freq	Level	Read Level	Limit Line	Over Limit	Factor	Remark
	MHz	dBm/m	dBm	dBm/m	dB	dB/m	
1	1672.80	-57.75	-43.91	-13.00	-44.75	-13.84	Peak
2	2509.20	-54.04	-44.05	-13.00	-41.04	-9.99	Peak



A D T

WCDMA:



Bureau Veritas Consumer Products Services Ltd., Taoyuan Branch

A D T

Data: 5

Date: 2013-12-28

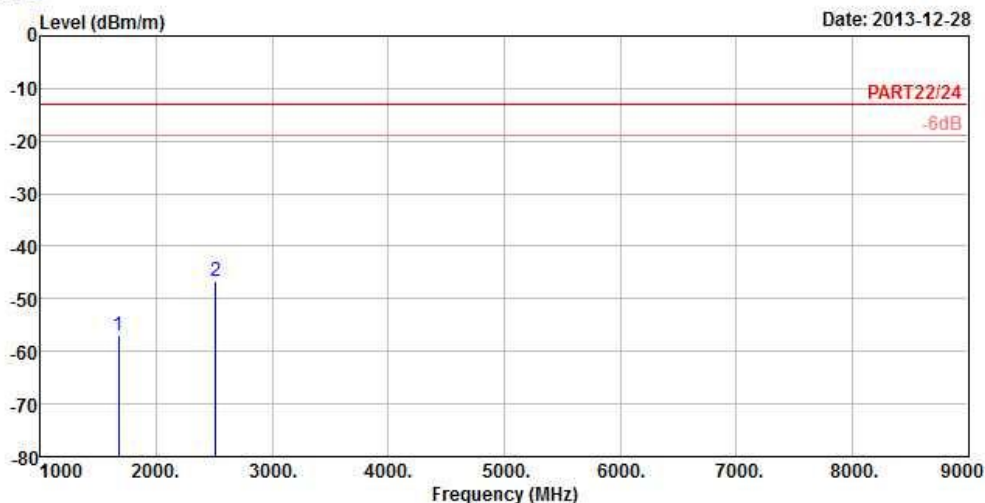

Site : 966 Chamber 5
 Condition : PART22/24 3m HORIZONTAL
 Brand/Model: 0P6B200
 Remark : Band V Link
 Tested by : Johnson Liao
 Temperature : 25°C
 Humidity : 65%
 Plane : X

	Freq	Level	Read	Limit	Over		
	MHz	dBm/m	Level	Line	Limit	Factor	Remark
			dBm	dBm/m	dB	dB/m	
1	1672.80	-56.88	-43.04	-13.00	-43.88	-13.84	Peak
2 pp	2509.20	-46.57	-36.58	-13.00	-33.57	-9.99	Peak



A D T



Bureau Veritas Consumer Products Services Ltd., Taoyuan Branch

A D T

Data: 6

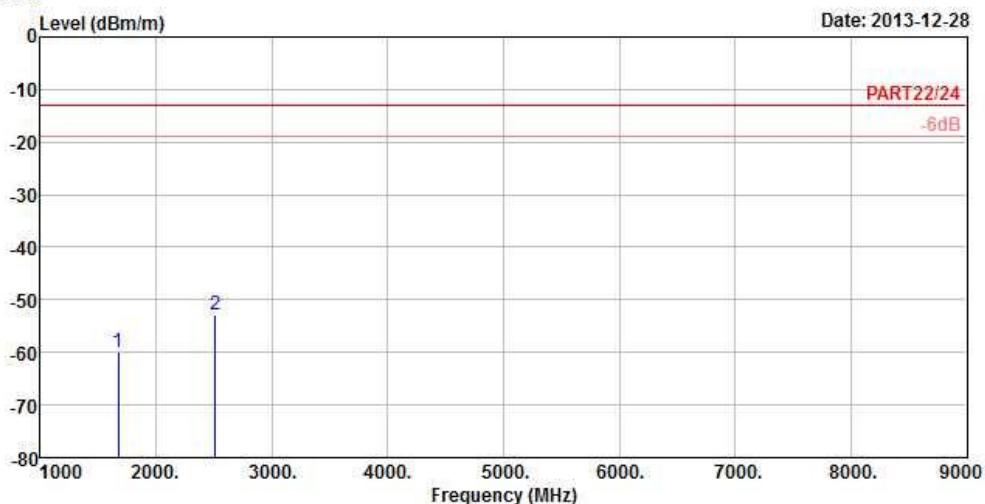

Site : 966 Chamber 5
 Condition : PART22/24 3m VERTICAL
 Brand/Model: 0P6B200
 Remark : Band V Link
 Tested by : Johnson Liao
 Temperature : 25°C
 Humidity : 65%
 Plane : X

	Freq	Level	Read Level	Limit Line	Over Limit	Factor	Remark
	MHz	dBm/m	dBm	dBm/m	dB	dB/m	
1	1672.80	-59.91	-46.07	-13.00	-46.91	-13.84	Peak
2 pp	2509.20	-52.82	-42.83	-13.00	-39.82	-9.99	Peak

CDMA:



Bureau Veritas Consumer Products Services Ltd., Taoyuan Branch

A D T

Data: 9

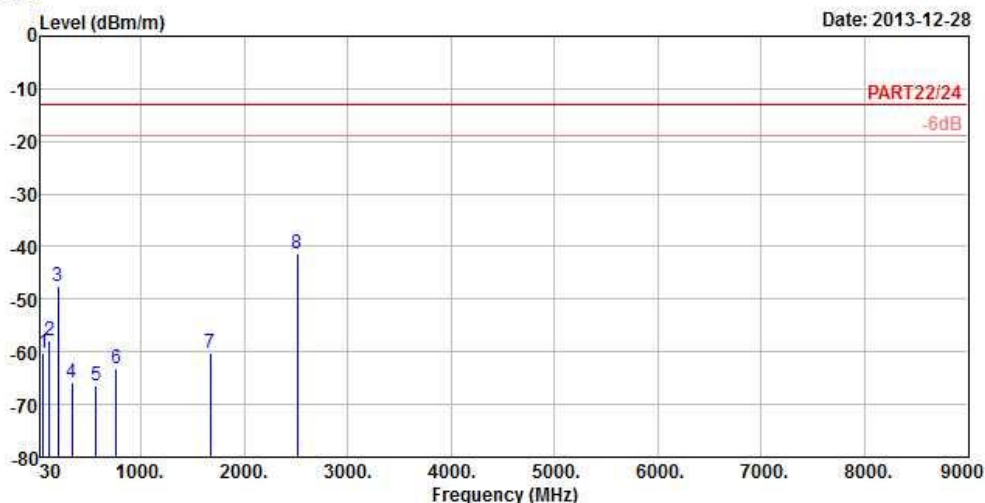

Site : 966 Chamber 5
 Condition : PART22/24 3m HORIZONTAL
 Brand/Model: 0P6B200
 Remark : 1XRTT850 Link
 Tested by : Johnson Liao
 Temperature : 25°C
 Humidity : 65%
 Plane : X

	Freq	Level	Read	Limit	Over		
	MHz	dBm/m	Level	Line	Limit	Factor	Remark
			dBm	dBm/m	dB	dB/m	
1	57.27	-60.12	-54.47	-13.00	-47.12	-5.65	Peak
2	115.05	-57.79	-47.05	-13.00	-44.79	-10.74	Peak
3	195.24	-47.58	-40.20	-13.00	-34.58	-7.38	Peak
4	335.00	-65.73	-59.61	-13.00	-52.73	-6.12	Peak
5	566.00	-66.48	-65.20	-13.00	-53.48	-1.28	Peak
6	757.80	-63.31	-65.15	-13.00	-50.31	1.84	Peak
7	1673.04	-60.36	-46.52	-13.00	-47.36	-13.84	Peak
8 pp	2509.56	-41.19	-31.20	-13.00	-28.19	-9.99	Peak



A D T

Data: 10

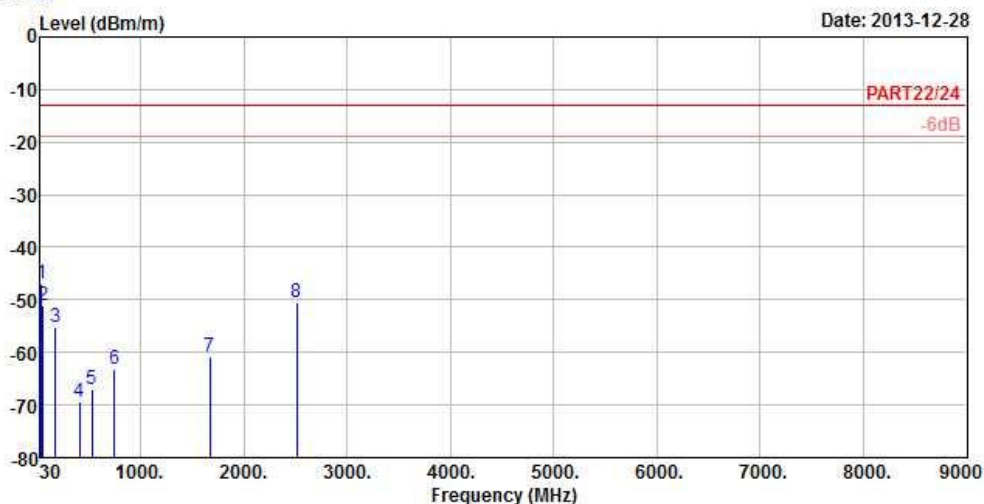

Site : 966 Chamber 5
 Condition : PART22/24 3m VERTICAL
 Brand/Model: 0P6B200
 Remark : 1XRTT850 Link
 Tested by : Johnson Liao
 Temperature : 25°C
 Humidity : 65%
 Plane : X

	Freq	Level	Read Level	Limit Line	Over Limit	Factor	Remark
	MHz	dBm/m	dBm	dBm/m	dB	dB/m	
1	pp	39.18	-46.97	-45.23	-13.00	-33.97	-1.74 Peak
2		57.81	-51.09	-45.29	-13.00	-38.09	-5.80 Peak
3		177.69	-55.20	-48.97	-13.00	-42.20	-6.23 Peak
4		411.30	-69.34	-63.99	-13.00	-56.34	-5.35 Peak
5		531.00	-66.96	-64.69	-13.00	-53.96	-2.27 Peak
6		743.80	-63.25	-65.00	-13.00	-50.25	1.75 Peak
7		1673.04	-60.75	-46.91	-13.00	-47.75	-13.84 Peak
8		2509.56	-50.62	-40.63	-13.00	-37.62	-9.99 Peak



A D T

TEST MODE B

GSM:



Bureau Veritas Consumer Products Services Ltd., Taoyuan Branch

A D T

Data: 9

Date: 2014-01-02

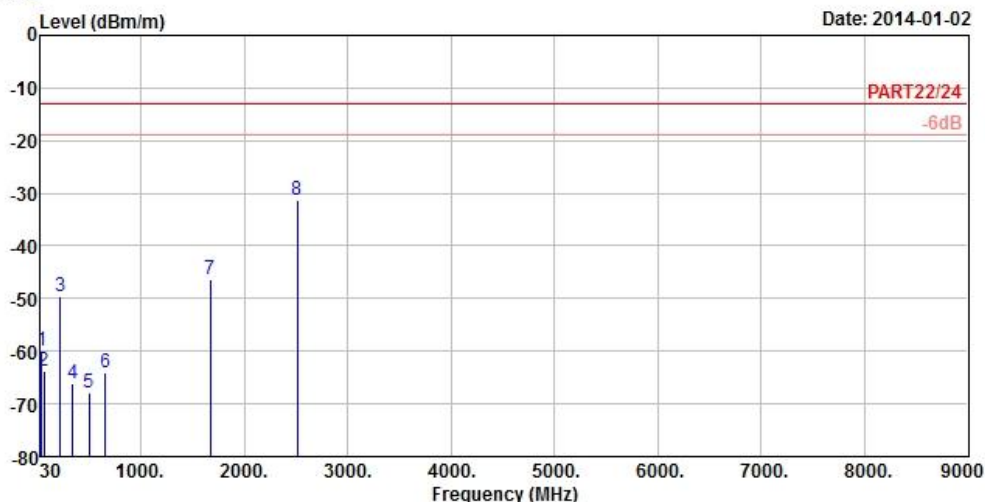

Site : 966 Chamber 5
 Condition : PART22/24 3m HORIZONTAL
 Brand/Model: 0P6B200
 Remark : GSM850 Link
 Tested by : Johnson Liao
 Temperature : 25°C
 Humidity : 65%
 Plane : X

	Freq	Level	Read	Limit	Over		
	MHz	dBm/m	Level	Line	Limit	Factor	Remark
			dBm	dBm/m	dB	dB/m	
1	40.80	-59.96	-58.50	-13.00	-46.96	-1.46	Peak
2	63.75	-63.64	-56.24	-13.00	-50.64	-7.40	Peak
3	220.35	-49.72	-42.69	-13.00	-36.72	-7.03	Peak
4	341.30	-66.17	-60.10	-13.00	-53.17	-6.07	Peak
5	501.60	-67.90	-64.84	-13.00	-54.90	-3.06	Peak
6	652.80	-64.18	-64.77	-13.00	-51.18	0.59	Peak
7	1672.80	-46.49	-32.65	-13.00	-33.49	-13.84	Peak
8 pp	2509.20	-31.25	-21.26	-13.00	-18.25	-9.99	Peak



A D T

Data: 10

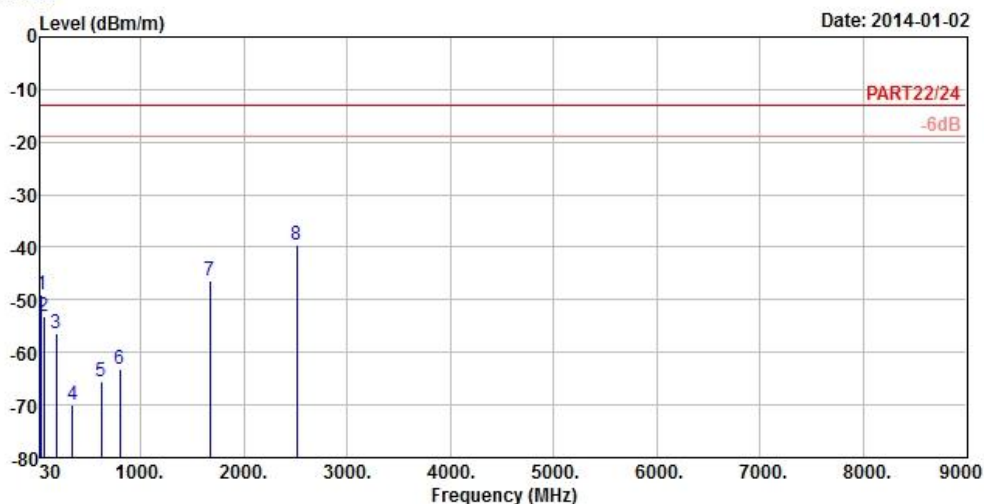

Site : 966 Chamber 5
 Condition : PART22/24 3m VERTICAL
 Brand/Model: 0P6B200
 Remark : GSM850 Link
 Tested by : Johnson Liao
 Temperature : 25°C
 Humidity : 65%
 Plane : X

	Freq	Level	Read Level	Limit Line	Over Limit	Factor	Remark
	MHz	dBm/m	dBm	dBm/m	dB	dB/m	
1	40.80	-48.89	-47.43	-13.00	-35.89	-1.46	Peak
2	59.70	-53.10	-47.00	-13.00	-40.10	-6.10	Peak
3	183.36	-56.39	-50.38	-13.00	-43.39	-6.01	Peak
4	342.00	-70.06	-64.00	-13.00	-57.06	-6.06	Peak
5	619.20	-65.43	-65.41	-13.00	-52.43	-0.02	Peak
6	797.70	-63.05	-65.16	-13.00	-50.05	2.11	Peak
7	1672.80	-46.21	-32.37	-13.00	-33.21	-13.84	Peak
8 pp	2509.20	-39.42	-29.43	-13.00	-26.42	-9.99	Peak



A D T

5 PHOTOGRAPHS OF THE TEST CONFIGURATION

Please refer to the attached file (Test Setup Photo).



6 INFORMATION ON THE TESTING LABORATORIES

We, Bureau Veritas Consumer Products Services (H.K.) Ltd., Taoyuan Branch, were founded in 1988 to provide our best service in EMC, Radio, Telecom and Safety consultation. Our laboratories are accredited and approved according to ISO/IEC 17025.

If you have any comments, please feel free to contact us at the following:

Linko EMC/RF Lab:

Tel: 886-2-26052180

Fax: 886-2-26051924

Hsin Chu EMC/RF Lab:

Tel: 886-3-5935343

Fax: 886-3-5935342

Hwa Ya EMC/RF/Safety/Telecom Lab:

Tel: 886-3-3183232

Fax: 886-3-3270892

Email: service.adt@tw.bureauveritas.com

Web Site: www.bureauveritas-adt.com

The address and road map of all our labs can be found in our web site also.



A D T

7 APPENDIX A – MODIFICATIONS RECORDERS FOR ENGINEERING CHANGES TO THE EUT BY THE LAB

No any modifications were made to the EUT by the lab during the test.

---END---