



FCC TEST REPORT (15.247)

REPORT NO.: RF140127C02

MODEL NO.: 0P6B170

FCC ID: NM80P6B170

RECEIVED: Oct. 23, 2013

TESTED: Nov. 19, 2013 ~ Jan. 03, 2014

ISSUED: Feb. 12, 2014

APPLICANT: HTC Corporation

ADDRESS: No. 23, Xinghua Rd., Taoyuan 330, Taiwan, R.O.C.

ISSUED BY: Bureau Veritas Consumer Products Services
(H.K.) Ltd., Taoyuan Branch

LAB ADDRESS: No. 47, 14th Ling, Chia Pau Vil., Lin Kou Dist.,
New Taipei City, Taiwan (R.O.C)

TEST LOCATION: No. 19, Hwa Ya 2nd Rd, Wen Hwa Tsuen, Kwei
Shan Hsiang, Taoyuan Hsien 333, Taiwan, R.O.C.

This report should not be used by the client to claim product certification, approval, or endorsement by TAF or any government agencies.



This report is for your exclusive use. Any copying or replication of this report to or for any other person or entity, or use of our name or trademark, is permitted only with our prior written permission. This report sets forth our findings solely with respect to the test samples identified herein. The results set forth in this report are not indicative or representative of the quality or characteristics of the lot from which a test sample was taken or any similar or identical product unless specifically and expressly noted. Our report includes all of the tests requested by you and the results thereof based upon the information that you provided to us. You have 60 days from date of issuance of this report to notify us of any material error or omission caused by our negligence, provided, however, that such notice shall be in writing and shall specifically address the issue you wish to raise. A failure to raise such issue within the prescribed time shall constitute your unqualified acceptance of the completeness of this report, the tests conducted and the correctness of the report contents. Unless specifically mentioned, the uncertainty of measurement has been explicitly taken into account to declare the compliance or non-compliance to the specification.



TABLE OF CONTENTS

- RELEASE CONTROL RECORD5
- 1. CERTIFICATION.....6
- 2. SUMMARY OF TEST RESULTS7
 - 2.1 MEASUREMENT UNCERTAINTY.....7
- 3. GENERAL INFORMATION8
 - 3.1 GENERAL DESCRIPTION OF EUT8
 - 3.2 DESCRIPTION OF TEST MODES9
 - 3.2.1 TEST MODE APPLICABILITY AND TESTED CHANNEL DETAIL 10
 - 3.3 DESCRIPTION OF SUPPORT UNITS 14
 - 3.3.1 CONFIGURATION OF SYSTEM UNDER TEST 14
 - 3.4 DUTY CYCLE TEST SIGNAL 15
 - 3.5 GENERAL DESCRIPTION OF APPLIED STANDARDS 17
- 4. TEST TYPES AND RESULTS (FOR 2.4GHz BAND) 18
 - 4.1 RADIATED EMISSION AND BANDEDGE MEASUREMENT 18
 - 4.1.1 LIMITS OF RADIATED EMISSION AND BANDEDGE MEASUREMENT 18
 - 4.1.2 TEST INSTRUMENTS 19
 - 4.1.3 TEST PROCEDURES 20
 - 4.1.4 DEVIATION FROM TEST STANDARD 20
 - 4.1.5 TEST SETUP 21
 - 4.1.6 EUT OPERATING CONDITIONS 22
 - 4.1.7 TEST RESULTS..... 23
 - 4.2 CONDUCTED EMISSION MEASUREMENT 33
 - 4.2.1 LIMITS OF CONDUCTED EMISSION MEASUREMENT 33
 - 4.2.2 TEST INSTRUMENTS 33
 - 4.2.3 TEST PROCEDURES 34
 - 4.2.4 DEVIATION FROM TEST STANDARD 34
 - 4.2.5 TEST SETUP 35
 - 4.2.6 EUT OPERATING CONDITIONS 35
 - 4.2.7 TEST RESULTS..... 36
 - 4.3 6dB BANDWIDTH MEASUREMENT 38
 - 4.3.1 LIMITS OF 6dB BANDWIDTH MEASUREMENT 38
 - 4.3.2 TEST SETUP 38
 - 4.3.3 TEST INSTRUMENTS 38
 - 4.3.4 TEST PROCEDURE 38
 - 4.3.5 DEVIATION FROM TEST STANDARD 38
 - 4.3.6 EUT OPERATING CONDITIONS 38
 - 4.3.7 TEST RESULTS..... 39
 - 4.4 CONDUCTED OUTPUT POWER 41
 - 4.4.1 LIMITS OF CONDUCTED OUTPUT POWER MEASUREMENT 41
 - 4.4.2 TEST SETUP 41
 - 4.4.3 TEST INSTRUMENTS 41
 - 4.4.4 TEST PROCEDURES 41
 - 4.4.5 DEVIATION FROM TEST STANDARD 41
 - 4.4.6 EUT OPERATING CONDITIONS 41
 - 4.4.7 TEST RESULTS..... 42
 - 4.5 POWER SPECTRAL DENSITY MEASUREMENT 43
 - 4.5.1 LIMITS OF POWER SPECTRAL DENSITY MEASUREMENT 43
 - 4.5.2 TEST SETUP 43
 - 4.5.3 TEST INSTRUMENTS 43
 - 4.5.4 TEST PROCEDURE 43
 - 4.5.5 DEVIATION FROM TEST STANDARD 43
 - 4.5.6 EUT OPERATING CONDITION..... 43



4.5.7	TEST RESULTS.....	44
4.6	CONDUCTED OUT OF BAND EMISSION MEASUREMENT	46
4.6.1	LIMITS OF CONDUCTED OUT OF BAND EMISSION MEASUREMENT	46
4.6.2	TEST SETUP	46
4.6.3	TEST INSTRUMENTS	46
4.6.4	TEST PROCEDURE	46
4.6.5	DEVIATION FROM TEST STANDARD	47
4.6.6	EUT OPERATING CONDITION.....	47
4.6.7	TEST RESULTS.....	47
5.	TEST TYPES AND RESULTS (FOR 5.0GHz BAND)	51
5.1	RADIATED EMISSION AND BANDEDGE MEASUREMENT	51
5.1.1	LIMITS OF RADIATED EMISSION AND BANDEDGE MEASUREMENT	51
5.1.2	TEST INSTRUMENTS.....	52
5.1.3	TEST PROCEDURES	52
5.1.4	DEVIATION FROM TEST STANDARD	52
5.1.5	TEST SETUP	52
5.1.6	EUT OPERATING CONDITIONS	52
5.1.7	TEST RESULTS.....	53
5.2	CONDUCTED EMISSION MEASUREMENT	63
5.2.1	LIMITS OF CONDUCTED EMISSION MEASUREMENT	63
5.2.2	TEST INSTRUMENTS	63
5.2.3	TEST PROCEDURES	63
5.2.4	DEVIATION FROM TEST STANDARD	63
5.2.5	TEST SETUP	63
5.2.6	EUT OPERATING CONDITIONS	63
5.2.7	TEST RESULTS.....	64
5.3	6dB BANDWIDTH MEASUREMENT	66
5.3.1	LIMITS OF 6dB BANDWIDTH MEASUREMENT	66
5.3.2	TEST SETUP	66
5.3.3	TEST INSTRUMENTS.....	66
5.3.4	TEST PROCEDURE	66
5.3.5	DEVIATION FROM TEST STANDARD	66
5.3.6	EUT OPERATING CONDITIONS	66
5.3.7	TEST RESULTS.....	67
5.4	MAXIMUM OUTPUT POWER	69
5.4.1	LIMITS OF MAXIMUM OUTPUT POWER MEASUREMENT	69
5.4.2	TEST SETUP	69
5.4.3	INSTRUMENTS	69
5.4.4	TEST PROCEDURES	69
5.4.5	DEVIATION FROM TEST STANDARD	69
5.4.6	EUT OPERATING CONDITIONS	69
5.4.7	TEST RESULTS.....	70
5.5	POWER SPECTRAL DENSITY MEASUREMENT.....	71
5.5.1	LIMITS OF POWER SPECTRAL DENSITY MEASUREMENT	71
5.5.2	TEST SETUP	71
5.5.3	TEST INSTRUMENTS.....	71
5.5.4	TEST PROCEDURE	71
5.5.5	DEVIATION FROM TEST STANDARD	71
5.5.6	EUT OPERATING CONDITION.....	71
5.5.7	TEST RESULTS.....	72
5.6	CONDUCTED OUT OF BAND EMISSION MEASUREMENT	74
5.6.1	LIMITS OF OUT OF BAND EMISSION MEASUREMENT	74
5.6.2	TEST SETUP	74
5.6.3	TEST INSTRUMENTS.....	74
5.6.4	TEST PROCEDURE	74



A D T

5.6.5	DEVIATION FROM TEST STANDARD	74
5.6.6	EUT OPERATING CONDITION.....	74
5.6.7	TEST RESULTS.....	74
6.	PHOTOGRAPHS OF THE TEST CONFIGURATION.....	78
7.	INFORMATION ON THE TESTING LABORATORIES	79
8.	APPENDIX A - MODIFICATIONS RECORDERS FOR ENGINEERING CHANGES TO THE EUT BY THE LAB	80



A D T

RELEASE CONTROL RECORD

ISSUE NO.	REASON FOR CHANGE	DATE ISSUED
RF140127C02	Original release	Feb. 12, 2014



A D T

1. CERTIFICATION

PRODUCT: Smartphone
MODEL NO.: 0P6B170
BRAND: HTC
APPLICANT: HTC Corporation
TESTED: Nov. 19, 2013 ~ Jan. 03, 2014
TEST SAMPLE: PRODUCTION UNIT
STANDARDS: **FCC Part 15, Subpart C (Section 15.247)**
ANSI C63.10-2009

The above equipment (model: 0P6B170) has been tested by **Bureau Veritas Consumer Products Services (H.K.) Ltd., Taoyuan Branch**, and found compliance with the requirement of the above standards. The test record, data evaluation & Equipment Under Test (EUT) configurations represented herein are true and accurate accounts of the measurements of the sample's EMC characteristics under the conditions specified in this report.

PREPARED BY : Ivonne Wu , **DATE** : Feb. 12, 2014
Ivonne Wu / Supervisor

APPROVED BY : Sam Chen , **DATE** : Feb. 12, 2014
Sam Chen / Senior Project Engineer

2. SUMMARY OF TEST RESULTS

The EUT has been tested according to the following specifications:

APPLIED STANDARD: FCC PART 15, SUBPART C (SECTION 15.247)			
STANDARD SECTION	TEST TYPE	RESULT	REMARK
15.207	AC Power Conducted Emission	PASS	Meet the requirement of limit. Minimum passing margin is -17.13dB at 13.56250MHz.
15.247(d) 15.209	Radiated Emissions	PASS	Meet the requirement of limit. Minimum passing margin is -1.61dB at 2484.00MHz.
15.247(d)	Band Edge Measurement	PASS	Meet the requirement of limit.
15.247(a)(2)	6dB bandwidth	PASS	Meet the requirement of limit.
15.247(b)	Conducted power	PASS	Meet the requirement of limit.
15.247(e)	Power Spectral Density	PASS	Meet the requirement of limit.
15.203	Antenna Requirement	PASS	No antenna connector is used.

2.1 MEASUREMENT UNCERTAINTY

Where relevant, the following measurement uncertainty levels have been estimated for tests performed on the EUT as specified in CISPR 16-4-2:

MEASUREMENT	FREQUENCY	UNCERTAINTY
Conducted emissions	9kHz~30MHz	2.44 dB
Radiated emissions	30MHz ~ 200MHz	2.93 dB
	200MHz ~1000MHz	2.95 dB
	1GHz ~ 18GHz	2.26 dB
	18GHz ~ 40GHz	1.94 dB

This uncertainty represents an expanded uncertainty expressed at approximately the 95% confidence level using a coverage factor of $k = 2$.



A D T

3. GENERAL INFORMATION

3.1 GENERAL DESCRIPTION OF EUT

EUT	Smartphone
MODEL NO.	0P6B170
POWER SUPPLY	5.0Vdc (adapter or host equipment) 3.8Vdc (Li-ion battery)
MODULATION TYPE	CCK, DQPSK, DBPSK for DSSS 256QAM, 64QAM, 16QAM, QPSK, BPSK for OFDM
MODULATION TECHNOLOGY	DSSS, OFDM
TRANSFER RATE	802.11b: 11.0/ 5.5/ 2.0/ 1.0Mbps 802.11g: 54.0/ 48.0/ 36.0/ 24.0/ 18.0/ 12.0/ 9.0/ 6.0Mbps 802.11a: 54.0/ 48.0/ 36.0/ 24.0/ 18.0/ 12.0/ 9.0/ 6.0Mbps 802.11n: up to MCS7 802.11ac: up to V9
OPERATING FREQUENCY	2.4GHz: 2412 ~ 2462MHz 5.0GHz: 5745 ~ 5825MHz
NUMBER OF CHANNEL	2.4GHz: 11 for 802.11b, 802.11g, 802.11n (20MHz) 5.0GHz: 5 for 802.11a, 802.11n (20MHz) 2 for 802.11n (40MHz) 1 for 802.11ac (80MHz)
OUTPUT POWER	162.930mW for 2412 ~ 2462MHz 333.426mW for 5745 ~ 5825MHz
ANTENNA TYPE	2.4GHz: PIFA antenna with -2dBi gain 5.0GHz: PIFA antenna with -3.5dBi gain
ANTENNA CONNECTOR	NA
DATA CABLE	Refer to Note as below
I/O PORTS	Refer to user's manual
ACCESSORY DEVICES	Refer to Note as below

NOTE:

1. The EUT's accessories list refers to Ext. Pho.
2. The above EUT information is declared by the manufacturer and for more detailed features description, please refer to the manufacturer's specifications or User's Manual.

3.2 DESCRIPTION OF TEST MODES

FOR 2.4GHz:

11 channels are provided for 802.11b, 802.11g and 802.11n (20MHz):

CHANNEL	FREQUENCY	CHANNEL	FREQUENCY
1	2412MHz	7	2442MHz
2	2417MHz	8	2447MHz
3	2422MHz	9	2452MHz
4	2427MHz	10	2457MHz
5	2432MHz	11	2462MHz
6	2437MHz		

FOR 5.0GHz (5745 ~ 5825MHz):

5 channels are provided for 802.11a, 802.11n (20MHz):

CHANNEL	FREQUENCY	CHANNEL	FREQUENCY
149	5745MHz	161	5805MHz
153	5765MHz	165	5825MHz
157	5785MHz		

2 channels are provided for 802.11n (40MHz):

CHANNEL	FREQUENCY	CHANNEL	FREQUENCY
151	5755MHz	159	5795MHz

1 channel is provided for 802.11ac (80MHz):

CHANNEL	FREQUENCY
155	5775MHz

3.2.1 TEST MODE APPLICABILITY AND TESTED CHANNEL DETAIL

FOR 2.4GHz:

EUT CONFIGURE MODE	APPLICABLE TO				DESCRIPTION
	RE \geq 1G	RE<1G	PLC	APCM	
-	√	√	√	√	-

Where **RE \geq 1G:** Radiated Emission above 1GHz

RE<1G: Radiated Emission below 1GHz

PLC: Power Line Conducted Emission

APCM: Antenna Port Conducted Measurement

NOTE: The EUT had been pre-tested on the positioned of each 3 axis. The worst case was found when positioned on Z-plane.

RADIATED EMISSION TEST (ABOVE 1GHz):

- Pre-Scan has been conducted to determine the worst-case mode from all possible combinations between available modulations, data rates and antenna ports (if EUT with antenna diversity architecture).
- Following channel(s) was (were) selected for the final test as listed below.

EUT CONFIGURE MODE	MODE	AVAILABLE CHANNEL	TESTED CHANNEL	MODULATION TECHNOLOGY	MODULATION TYPE	DATA RATE (Mbps)
-	802.11b	1 to 11	1, 6, 11	DSSS	DBPSK	1.0
	802.11g	1 to 11	1, 6, 11	OFDM	BPSK	6.0
	802.11n (20MHz)	1 to 11	1, 6, 11	OFDM	BPSK	MCS0

RADIATED EMISSION TEST (BELOW 1GHz):

- Pre-Scan has been conducted to determine the worst-case mode from all possible combinations between available modulations, data rates and antenna ports (if EUT with antenna diversity architecture).
- Following channel(s) was (were) selected for the final test as listed below.

EUT CONFIGURE MODE	MODE	AVAILABLE CHANNEL	TESTED CHANNEL	MODULATION TECHNOLOGY	MODULATION TYPE	DATA RATE (Mbps)
-	802.11n (20MHz)	1 to 11	11	OFDM	BPSK	MCS0

POWER LINE CONDUCTED EMISSION TEST:

EUT CONFIGURE MODE	MODE	AVAILABLE CHANNEL	TESTED CHANNEL	MODULATION TECHNOLOGY	MODULATION TYPE	DATA RATE (Mbps)
-	802.11n (20MHz)	1 to 11	11	OFDM	BPSK	MCS0



BANDEDGE MEASUREMENT:

- Pre-Scan has been conducted to determine the worst-case mode from all possible combinations between available modulations, data rates and antenna ports (if EUT with antenna diversity architecture).
- Following channel(s) was (were) selected for the final test as listed below.

EUT CONFIGURE MODE	MODE	AVAILABLE CHANNEL	TESTED CHANNEL	MODULATION TECHNOLOGY	MODULATION TYPE	DATA RATE (Mbps)
-	802.11b	1 to 11	1, 11	DSSS	DBPSK	1.0
	802.11g	1 to 11	1, 11	OFDM	BPSK	6.0
	802.11n (20MHz)	1 to 11	1, 11	OFDM	BPSK	MCS0

ANTENNA PORT CONDUCTED MEASUREMENT:

- This item includes all test value of each mode, but only includes spectrum plot of worst value of each mode.
- Pre-Scan has been conducted to determine the worst-case mode from all possible combinations between available modulations, data rates and antenna ports (if EUT with antenna diversity architecture).
- Following channel(s) was (were) selected for the final test as listed below.

EUT CONFIGURE MODE	MODE	AVAILABLE CHANNEL	TESTED CHANNEL	MODULATION TECHNOLOGY	MODULATION TYPE	DATA RATE (Mbps)
-	802.11b	1 to 11	1, 6, 11	DSSS	DBPSK	1.0
	802.11g	1 to 11	1, 6, 11	OFDM	BPSK	6.0
	802.11n (20MHz)	1 to 11	1, 6, 11	OFDM	BPSK	MCS0

TEST CONDITION:

APPLICABLE TO	ENVIRONMENTAL CONDITIONS	INPUT POWER	TESTED BY
RE≥1G	25deg. C, 65%RH	120Vac, 60Hz	David Huang
RE<1G	25deg. C, 65%RH	120Vac, 60Hz	David Huang
PLC	25deg. C, 65%RH	120Vac, 60Hz	Johnson Liao
APCM	25deg. C, 65%RH	120Vac, 60Hz	Demon Lin



A D T

FOR 5.0GHz (5745 ~ 5825MHz):

EUT CONFIGURE MODE	APPLICABLE TO				DESCRIPTION
	RE≥1G	RE<1G	PLC	APCM	
-	√	√	√	√	-

Where **RE≥1G**: Radiated Emission above 1GHz **RE<1G**: Radiated Emission below 1GHz
PLC: Power Line Conducted Emission **APCM**: Antenna Port Conducted Measurement

NOTE: The EUT had been pre-tested on the positioned of each 3 axis. The worst case was found when positioned on Z-plane.

RADIATED EMISSION TEST (ABOVE 1GHz):

- Pre-Scan has been conducted to determine the worst-case mode from all possible combinations between available modulations, data rates and antenna ports (if EUT with antenna diversity architecture).
- Following channel(s) was (were) selected for the final test as listed below.

EUT CONFIGURE MODE	MODE	AVAILABLE CHANNEL	TESTED CHANNEL	MODULATION TECHNOLOGY	MODULATION TYPE	DATA RATE (Mbps)
-	802.11a	149 to 165	149, 157, 165	OFDM	BPSK	6.0
	802.11n (20MHz)	149 to 165	149, 157, 165	OFDM	BPSK	MCS0
	802.11n (40MHz)	151 to 159	151, 159	OFDM	BPSK	MCS0
	802.11ac (80MHz)	155	155	OFDM	BPSK	V0

RADIATED EMISSION TEST (BELOW 1GHz):

- Pre-Scan has been conducted to determine the worst-case mode from all possible combinations between available modulations, data rates and antenna ports (if EUT with antenna diversity architecture).
- Following channel(s) was (were) selected for the final test as listed below.

EUT CONFIGURE MODE	MODE	AVAILABLE CHANNEL	TESTED CHANNEL	MODULATION TECHNOLOGY	MODULATION TYPE	DATA RATE (Mbps)
-	802.11n (20MHz)	149 to 165	149	OFDM	BPSK	MCS0

POWER LINE CONDUCTED EMISSION TEST:

EUT CONFIGURE MODE	MODE	AVAILABLE CHANNEL	TESTED CHANNEL	MODULATION TECHNOLOGY	MODULATION TYPE	DATA RATE (Mbps)
-	802.11n (20MHz)	149 to 165	149	OFDM	BPSK	MCS0



BANDEDGE MEASUREMENT:

- Pre-Scan has been conducted to determine the worst-case mode from all possible combinations between available modulations, data rates and antenna ports (if EUT with antenna diversity architecture).
- Following channel(s) was (were) selected for the final test as listed below.

EUT CONFIGURE MODE	MODE	AVAILABLE CHANNEL	TESTED CHANNEL	MODULATION TECHNOLOGY	MODULATION TYPE	DATA RATE (Mbps)
	802.11a	149 to 165	149, 165	OFDM	BPSK	6.0
	802.11n (20MHz)	149 to 165	149, 165	OFDM	BPSK	MCS0
	802.11n (40MHz)	151 to 159	151, 159	OFDM	BPSK	MCS0
	802.11ac (80MHz)	155	155	OFDM	BPSK	V0

ANTENNA PORT CONDUCTED MEASUREMENT:

- Pre-Scan has been conducted to determine the worst-case mode from all possible combinations between available modulations, data rates and antenna ports (if EUT with antenna diversity architecture).
- Following channel(s) was (were) selected for the final test as listed below.

EUT CONFIGURE MODE	MODE	AVAILABLE CHANNEL	TESTED CHANNEL	MODULATION TECHNOLOGY	MODULATION TYPE	DATA RATE (Mbps)
	802.11a	149 to 165	149, 157, 165	OFDM	BPSK	6.0
	802.11n (20MHz)	149 to 165	149, 157, 165	OFDM	BPSK	MCS0
	802.11n (40MHz)	151 to 159	151, 159	OFDM	BPSK	MCS0
	802.11ac (80MHz)	155	155	OFDM	BPSK	V0

TEST CONDITION:

APPLICABLE TO	ENVIRONMENTAL CONDITIONS	INPUT POWER	TESTED BY
RE≥1G	25deg. C, 65%RH	120Vac, 60Hz	David Huang
RE<1G	25deg. C, 65%RH	120Vac, 60Hz	David Huang
PLC	25deg. C, 65%RH	120Vac, 60Hz	Johnson Liao
APCM	25deg. C, 65%RH	120Vac, 60Hz	Demon Lin

3.3 DESCRIPTION OF SUPPORT UNITS

The EUT has been tested as an independent unit together with other necessary accessories or support units.

3.3.1 CONFIGURATION OF SYSTEM UNDER TEST

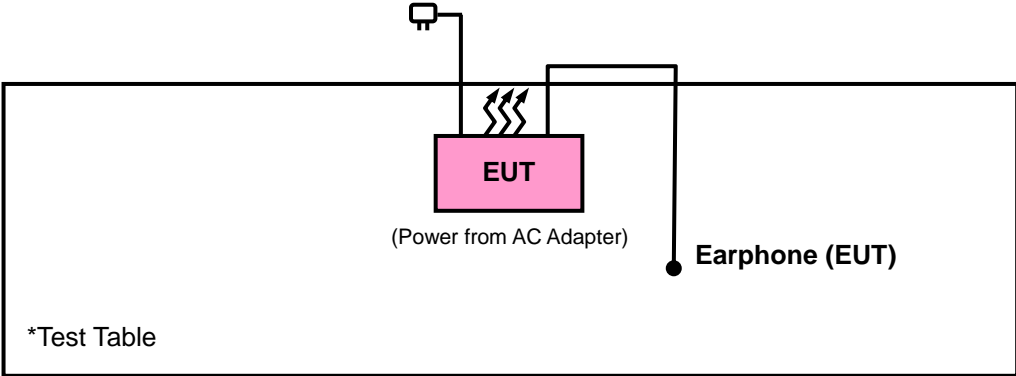



A D T

3.4 DUTY CYCLE TEST SIGNAL

2.4GHz

If duty cycle is < 98%

802.11b: Duty cycle = 8.213/8.413 = 0.976, Duty factor = 10 * log(1/0.976) = 0.11

802.11g: Duty cycle = 1.354/1.563 = 0.866, Duty factor = 10 * log(1/0.866) = 0.62

802.11n (20MHz): Duty cycle = 1.267/1.490 = 0.850, Duty factor = 10 * log(1/0.850) = 0.71

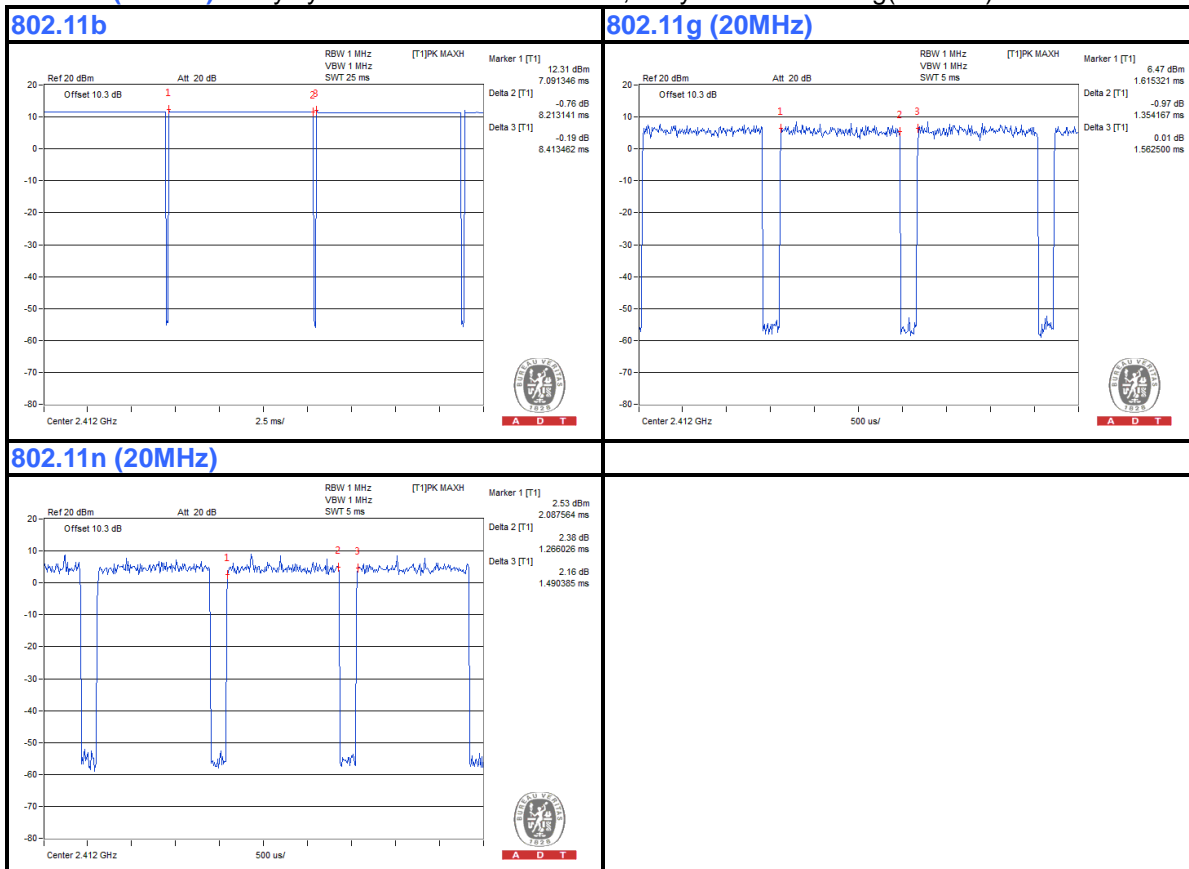



A D T

5725MHz ~ 5850MHz

If duty cycle is < 98%

802.11a: Duty cycle = 1.338/1.563 = 0.856, Duty factor = $10 * \log(1/0.856) = 0.66$

802.11n (20MHz): Duty cycle = 1.274/1.490 = 0.855, Duty factor = $10 * \log(1/0.855) = 0.68$

802.11n (40MHz): Duty cycle = 641.03/839.74 = 0.763, Duty factor = $10 * \log(1/0.763) = 1.17$

802.11ac (80MHz): Duty cycle = 246.79/451.92 = 0.546, Duty factor = $10 * \log(1/0.546) = 2.63$

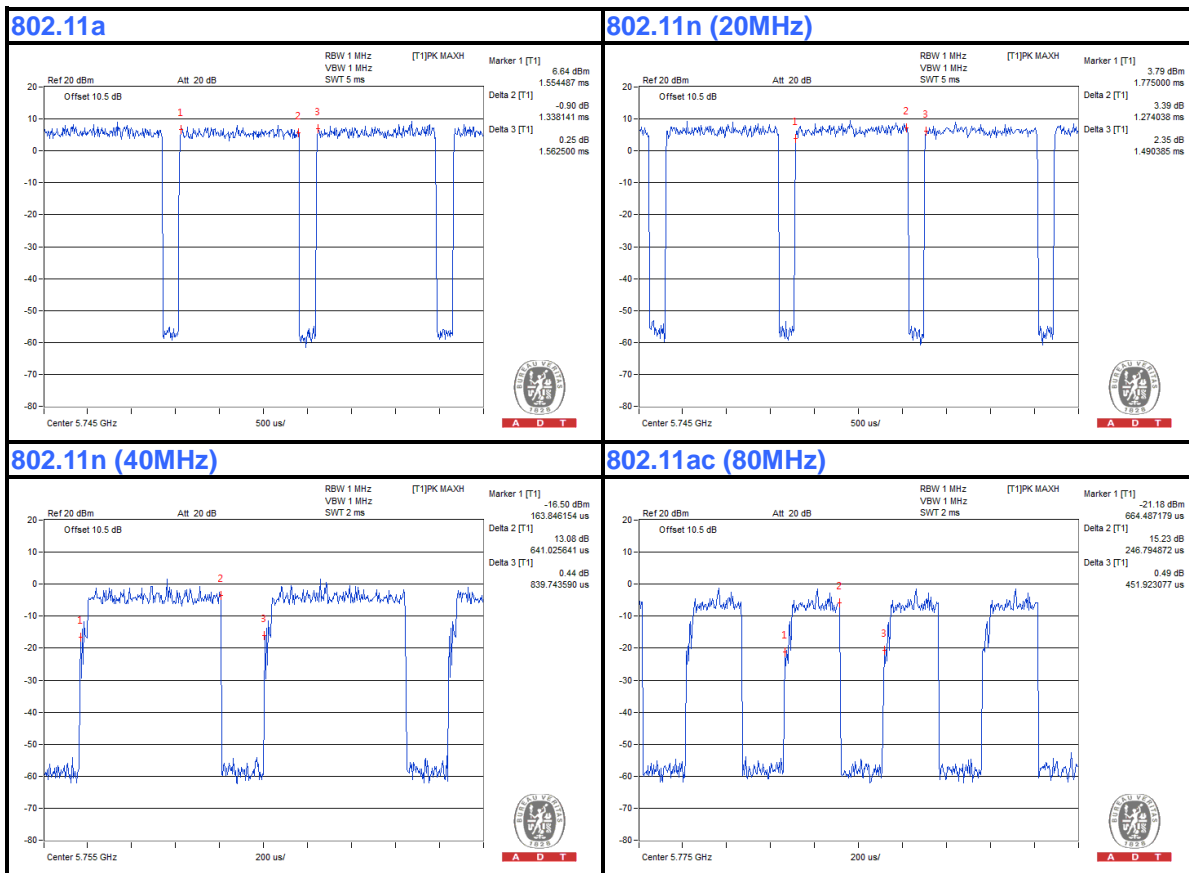



3.5 GENERAL DESCRIPTION OF APPLIED STANDARDS

The EUT is a RF Product. According to the specifications of the manufacturer, it must comply with the requirements of the following standards:

FCC Part 15, Subpart C (15.247)

ANSI C63.10-2009

KDB 558074 D01 DTS Meas Guidance v03r01

All test items have been performed and recorded as per the above standards.

NOTE: The EUT is also considered as a kind of computer peripheral, because the connection to computer is necessary for typical use. It has been verified to comply with the requirements of FCC Part 15, Subpart B, Class B (DoC). The test report has been issued separately.

4. TEST TYPES AND RESULTS (FOR 2.4GHz BAND)

4.1 RADIATED EMISSION AND BANDEDGE MEASUREMENT

4.1.1 LIMITS OF RADIATED EMISSION AND BANDEDGE MEASUREMENT

Radiated emissions which fall in the restricted bands must comply with the radiated emission limits specified as below table. Other emissions shall be at least 20dB below the highest level of the desired power:

FREQUENCIES (MHz)	FIELD STRENGTH (microvolts/meter)	MEASUREMENT DISTANCE (meters)
0.009 ~ 0.490	2400/F(kHz)	300
0.490 ~ 1.705	24000/F(kHz)	30
1.705 ~ 30.0	30	30
30 ~ 88	100	3
88 ~ 216	150	3
216 ~ 960	200	3
Above 960	500	3

NOTE:

1. The lower limit shall apply at the transition frequencies.
2. Emission level (dBuV/m) = 20 log Emission level (uV/m).
3. For frequencies above 1000MHz, the field strength limits are based on average detector, however, the peak field strength of any emission shall not exceed the maximum permitted average limits, specified above by more than 20dB under any condition of modulation.



A D T

4.1.2 TEST INSTRUMENTS

DESCRIPTION & MANUFACTURER	MODEL NO.	SERIAL NO.	DATE OF CALIBRATION	DUE DATE OF CALIBRATION
Test Receiver ROHDE & SCHWARZ	ESCI	100744	Apr. 15, 2013	Apr. 14, 2014
Spectrum Analyzer ROHDE & SCHWARZ	FSU-26	101645	Jul. 16, 2013	Jul. 15, 2014
BILOG Antenna SCHWARZBECK	VULB9168	9168-472	Mar. 25, 2013	Mar. 24, 2014
HORN Antenna SCHWARZBECK	BBHA 9120 D	9120D-969	Jan. 07, 2013	Jan. 06, 2014
HORN Antenna SCHWARZBECK	BBHA 9170	9170-480	Jan. 07, 2013	Jan. 06, 2014
Loop Antenna	HFH2-Z2	100070	Jan. 31, 2012	Jan. 30, 2014
Preamplifier EMCI	EMC 330H	980112	Dec. 28, 2012	Dec. 26, 2014
RF signal cable HUBER+SUHNNER	SUCOFLEX 104	309219/4	Oct. 18, 2013	Oct. 17, 2014
RF signal cable HUBER+SUHNNER	SUCOFLEX 104	250130/4	Oct. 18, 2013	Oct. 17, 2014
RF signal cable Worken	RG-213	NA	Nov. 07, 2013	Nov. 06, 2014
Software BV ADT	E3 6.120103	NA	NA	NA
Antenna Tower MF	MFA-440H	NA	NA	NA
Turn Table MF	MFT-201SS	NA	NA	NA
Antenna Tower & Turn Table Controller MF	MF-7802	NA	NA	NA
Power Meter	ML2495A	1232002	Aug. 23, 2013	Aug. 22, 2014
Power Sensor	MA2411B	1207325	Aug. 23, 2013	Aug. 22, 2014

- NOTE:** 1. The calibration interval of the above test instruments is 12 months and the calibrations are traceable to NML/ROC and NIST/USA.
2. The calibration interval of the loop antenna is 24 months and the calibrations are traceable to NML/ROC and NIST/USA.
3. The test was performed in HwaYa Chamber 10.
4. The horn antenna and HP preamplifier (model: 8449B) are used only for the measurement of emission frequency above 1GHz if tested.
5. The FCC Site Registration No. is 690701.
6. The IC Site Registration No. is IC 7450F-10.

4.1.3 TEST PROCEDURES

- a. The EUT was placed on the top of a rotating table 0.8 meters above the ground at a 3 meters semi-anechoic chamber. The table was rotated 360 degrees to determine the position of the highest radiation.
- b. The EUT was set 3 meters away from the interference-receiving antenna, which was mounted on the top of a variable-height antenna tower.
- c. Height of receiving antenna is varied from one meter to four meters above the ground to determine the maximum value of the field strength. Both horizontal and vertical polarizations of the antenna are set to make the measurement.
- d. For each suspected emission, the EUT was arranged to its worst case and then the antenna was tuned to heights from 1 meter to 4 meters and the rotatable table was turned from 0 degrees to 360 degrees to find the maximum reading.
- e. The test-receiver system was set to Peak Detect Function and Specified Bandwidth with Maximum Hold Mode.
- f. If the emission level of the EUT in peak mode was lower than the limit specified, then testing could be stopped and the peak values of the EUT would be reported. Otherwise the emissions would be re-tested one by one using peak, quasi-peak or average method as specified and then reported in a data sheet.

NOTE:

1. The resolution bandwidth and video bandwidth of test receiver/spectrum analyzer is 120kHz for Quasi-peak detection at frequency below 1GHz.
2. The resolution bandwidth of test receiver/spectrum analyzer is 1MHz and video bandwidth is 3MHz for Peak detection at frequency above 1GHz.
3. The resolution bandwidth of test receiver/spectrum analyzer is 1MHz and the video bandwidth is 1kHz (Duty cycle < 98%) or 10Hz (Duty cycle > 98%) for Average detection (AV) at frequency above 1GHz.
4. All modes of operation were investigated and the worst-case emissions are reported.

4.1.4 DEVIATION FROM TEST STANDARD

No deviation.

4.1.5 TEST SETUP

Frequency Range 30MHz ~ 1GHz

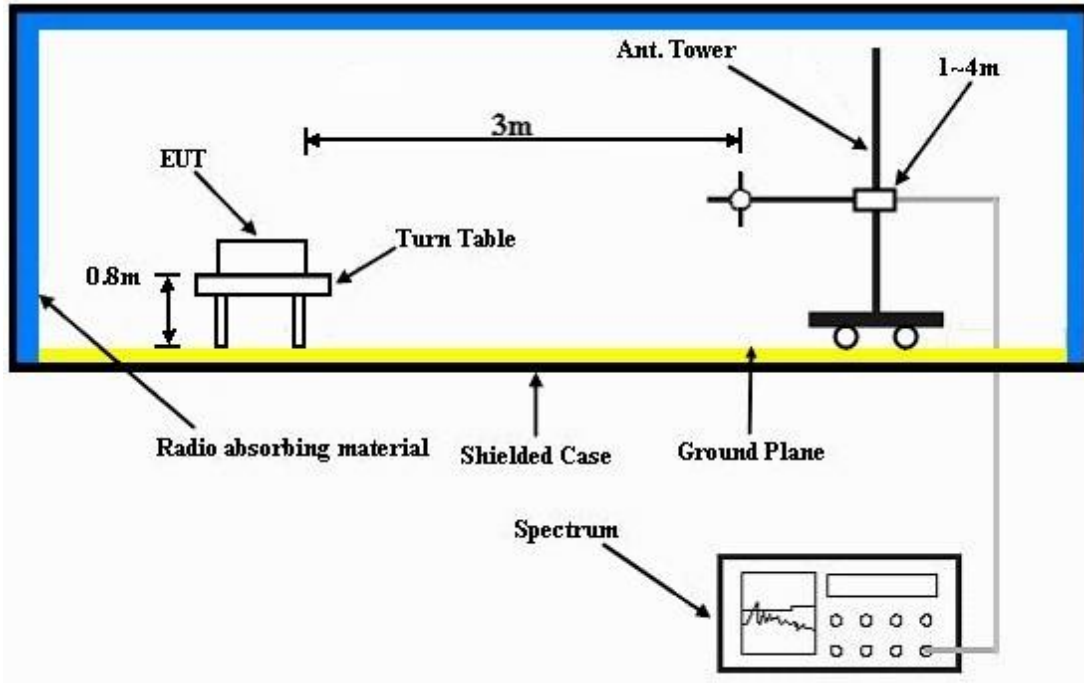

Frequency Range above 1GHz

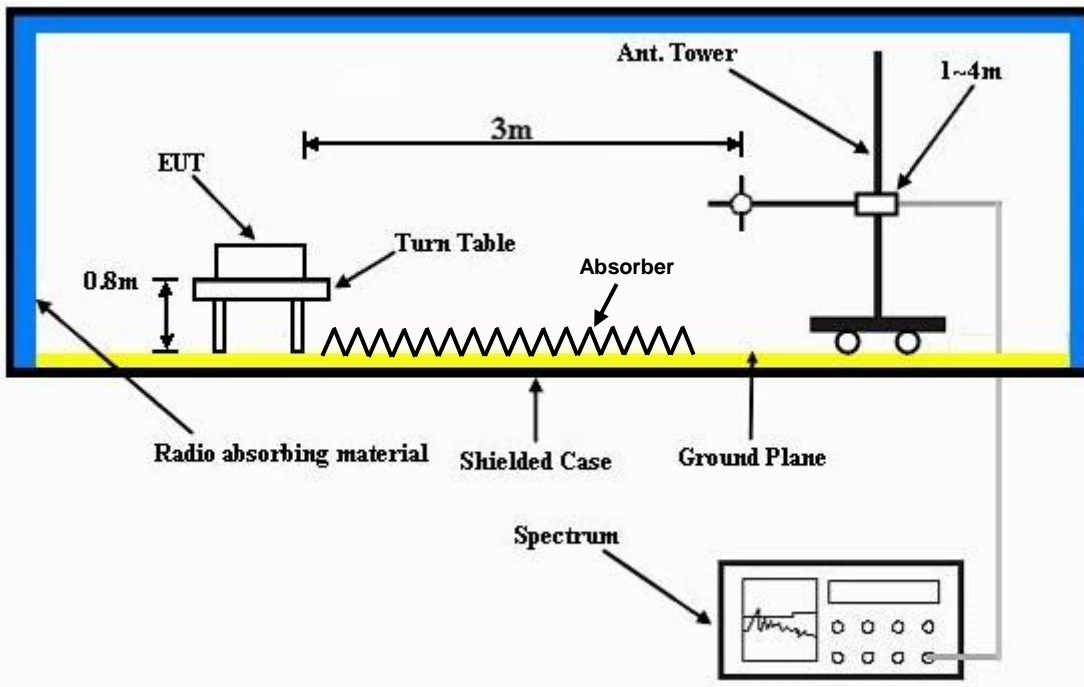

For the actual test configuration, please refer to the attached file (Test Setup Photo).



A D T

4.1.6 EUT OPERATING CONDITIONS

- a. Placed the EUT on a testing table.
- b. Use the software to control the EUT under transmission condition continuously at specific channel frequency.



A D T

4.1.7 TEST RESULTS

ABOVE 1GHz WORST-CASE DATA

802.11b

EUT TEST CONDITION		MEASUREMENT DETAIL	
CHANNEL	Channel 1	FREQUENCY RANGE	1GHz ~ 25GHz
INPUT POWER (SYSTEM)	120Vac, 60 Hz	DETECTOR FUNCTION	Peak (PK) Average (AV)
ENVIRONMENTAL CONDITIONS	25deg. C, 65%RH	TESTED BY	David Huang

ANTENNA POLARITY & TEST DISTANCE: HORIZONTAL AT 3 M										
FREQ. (MHz)	EMISSION LEVEL (dBuV/m)	READ LEVEL (dBuV)	LIMIT (dBuV/m)	MARGIN (dB)	ANTENNA FACTOR (dB/m)	CABLE LOSS (dB)	PREAMP FACTOR (dB)	ANTENNA HEIGHT (cm)	TABLE ANGLE (Degree)	REMARK
2390	34.5	41.57	54	-19.5	26.91	3.54	37.52	119	182	Average
2390	50.9	57.97	74	-23.1	26.91	3.54	37.52	119	182	Peak
2412	93.95	100.97			26.96	3.54	37.52	119	182	Average
2412	97.86	104.88			26.96	3.54	37.52	119	182	Peak
2484	33.8	40.37	54	-20.2	27.15	3.6	37.32	119	182	Average
2484	51.19	57.76	74	-22.81	27.15	3.6	37.32	119	182	Peak
ANTENNA POLARITY & TEST DISTANCE: VERTICAL AT 3 M										
FREQ. (MHz)	EMISSION LEVEL (dBuV/m)	READ LEVEL (dBuV)	LIMIT (dBuV/m)	MARGIN (dB)	ANTENNA FACTOR (dB/m)	CABLE LOSS (dB)	PREAMP FACTOR (dB)	ANTENNA HEIGHT (cm)	TABLE ANGLE (Degree)	REMARK
2390	34.49	41.56	54	-19.51	26.91	3.54	37.52	118	183	Average
2390	51.5	58.57	74	-22.5	26.91	3.54	37.52	118	183	Peak
2412	93.57	100.59			26.96	3.54	37.52	118	183	Average
2412	97.64	104.66			26.96	3.54	37.52	118	183	Peak
2484	33.82	40.39	54	-20.18	27.15	3.6	37.32	118	183	Average
2484	50.98	57.55	74	-23.02	27.15	3.6	37.32	118	183	Peak

REMARKS:

- Emission Level = Read Level + Antenna Factor + Cable Loss - Preamp Factor
Margin value = Emission level – Limit value
- 2412MHz: Fundamental frequency.



A D T

EUT TEST CONDITION		MEASUREMENT DETAIL	
CHANNEL	Channel 6	FREQUENCY RANGE	1GHz ~ 25GHz
INPUT POWER (SYSTEM)	120Vac, 60 Hz	DETECTOR FUNCTION	Peak (PK) Average (AV)
ENVIRONMENTAL CONDITIONS	25deg. C, 65%RH	TESTED BY	David Huang

ANTENNA POLARITY & TEST DISTANCE: HORIZONTAL AT 3 M										
FREQ. (MHz)	EMISSION LEVEL (dBuV/m)	READ LEVEL (dBuV)	LIMIT (dBuV/m)	MARGIN (dB)	ANTENNA FACTOR (dB/m)	CABLE LOSS (dB)	PREAMP FACTOR (dB)	ANTENNA HEIGHT (cm)	TABLE ANGLE (Degree)	REMARK
2390	34.07	41.14	54	-19.93	26.91	3.54	37.52	111	24	Average
2390	51.73	58.8	74	-22.27	26.91	3.54	37.52	111	24	Peak
2437	94.21	101.05			27.06	3.56	37.46	111	24	Average
2437	98.05	104.89			27.06	3.56	37.46	111	24	Peak
2484	34.59	41.16	54	-19.41	27.15	3.6	37.32	111	24	Average
2484	52.56	59.13	74	-21.44	27.15	3.6	37.32	111	24	Peak

ANTENNA POLARITY & TEST DISTANCE: VERTICAL AT 3 M										
FREQ. (MHz)	EMISSION LEVEL (dBuV/m)	READ LEVEL (dBuV)	LIMIT (dBuV/m)	MARGIN (dB)	ANTENNA FACTOR (dB/m)	CABLE LOSS (dB)	PREAMP FACTOR (dB)	ANTENNA HEIGHT (cm)	TABLE ANGLE (Degree)	REMARK
2390	35.14	42.21	54	-18.86	26.91	3.54	37.52	100	93	Average
2390	52.65	59.72	74	-21.35	26.91	3.54	37.52	100	93	Peak
2437	101.13	107.97			27.06	3.56	37.46	100	93	Average
2437	105.05	111.89			27.06	3.56	37.46	100	93	Peak
2484	36.43	43	54	-17.57	27.15	3.6	37.32	100	93	Average
2484	52.16	58.73	74	-21.84	27.15	3.6	37.32	100	93	Peak

REMARKS:

1. Emission Level = Read Level + Antenna Factor + Cable Loss - Preamp Factor
Margin value = Emission level – Limit value
2. 2437MHz: Fundamental frequency.



A D T

EUT TEST CONDITION		MEASUREMENT DETAIL	
CHANNEL	Channel 11	FREQUENCY RANGE	1GHz ~ 25GHz
INPUT POWER (SYSTEM)	120Vac, 60 Hz	DETECTOR FUNCTION	Peak (PK) Average (AV)
ENVIRONMENTAL CONDITIONS	25deg. C, 65%RH	TESTED BY	David Huang

ANTENNA POLARITY & TEST DISTANCE: HORIZONTAL AT 3 M										
FREQ. (MHz)	EMISSION LEVEL (dBuV/m)	READ LEVEL (dBuV)	LIMIT (dBuV/m)	MARGIN (dB)	ANTENNA FACTOR (dB/m)	CABLE LOSS (dB)	PREAMP FACTOR (dB)	ANTENNA HEIGHT (cm)	TABLE ANGLE (Degree)	REMARK
2390	32.42	39.49	54	-21.58	26.91	3.54	37.52	102	48	Average
2390	52.64	59.71	74	-21.36	26.91	3.54	37.52	102	48	Peak
2462	93	99.71			27.1	3.58	37.39	102	48	Average
2462	97.3	104.01			27.1	3.58	37.39	102	48	Peak
2484	36.76	43.33	54	-17.24	27.15	3.6	37.32	102	48	Average
2484	53.06	59.63	74	-20.94	27.15	3.6	37.32	102	48	Peak
ANTENNA POLARITY & TEST DISTANCE: VERTICAL AT 3 M										
FREQ. (MHz)	EMISSION LEVEL (dBuV/m)	READ LEVEL (dBuV)	LIMIT (dBuV/m)	MARGIN (dB)	ANTENNA FACTOR (dB/m)	CABLE LOSS (dB)	PREAMP FACTOR (dB)	ANTENNA HEIGHT (cm)	TABLE ANGLE (Degree)	REMARK
2362	33.96	41.14	54	-20.04	26.81	3.5	37.49	147	95	Average
2362	52.9	60.08	74	-21.1	26.81	3.5	37.49	147	95	Peak
2462	99.36	106.07			27.1	3.58	37.39	147	95	Average
2462	103.45	110.16			27.1	3.58	37.39	147	95	Peak
2484	42.28	48.85	54	-11.72	27.15	3.6	37.32	147	95	Average
2484	54.71	61.28	74	-19.29	27.15	3.6	37.32	147	95	Peak

REMARKS:

- Emission Level = Read Level + Antenna Factor + Cable Loss - Preamp Factor
Margin value = Emission level – Limit value
- 2462MHz: Fundamental frequency.



A D T

802.11g

EUT TEST CONDITION		MEASUREMENT DETAIL	
CHANNEL	Channel 1	FREQUENCY RANGE	1GHz ~ 25GHz
INPUT POWER (SYSTEM)	120Vac, 60 Hz	DETECTOR FUNCTION	Peak (PK) Average (AV)
ENVIRONMENTAL CONDITIONS	25deg. C, 65%RH	TESTED BY	David Huang

ANTENNA POLARITY & TEST DISTANCE: HORIZONTAL AT 3 M										
FREQ. (MHz)	EMISSION LEVEL (dBuV/m)	READ LEVEL (dBuV)	LIMIT (dBuV/m)	MARGIN (dB)	ANTENNA FACTOR (dB/m)	CABLE LOSS (dB)	PREAMP FACTOR (dB)	ANTENNA HEIGHT (cm)	TABLE ANGLE (Degree)	REMARK
2390	41.02	48.09	54	-12.98	26.91	3.54	37.52	121	182	Average
2390	61.3	68.37	74	-12.7	26.91	3.54	37.52	121	182	Peak
2412	86.89	93.91			26.96	3.54	37.52	121	182	Average
2412	96.34	103.36			26.96	3.54	37.52	121	182	Peak
2484	33.87	40.44	54	-20.13	27.15	3.6	37.32	121	182	Average
2484	50.76	57.33	74	-23.24	27.15	3.6	37.32	121	182	Peak
ANTENNA POLARITY & TEST DISTANCE: VERTICAL AT 3 M										
FREQ. (MHz)	EMISSION LEVEL (dBuV/m)	READ LEVEL (dBuV)	LIMIT (dBuV/m)	MARGIN (dB)	ANTENNA FACTOR (dB/m)	CABLE LOSS (dB)	PREAMP FACTOR (dB)	ANTENNA HEIGHT (cm)	TABLE ANGLE (Degree)	REMARK
2390	46.03	53.1	54	-7.97	26.91	3.54	37.52	100	93	Average
2390	65.05	72.12	74	-8.95	26.91	3.54	37.52	100	93	Peak
2412	93.57	100.59			26.96	3.54	37.52	100	93	Average
2412	103.53	110.55			26.96	3.54	37.52	100	93	Peak
2484	34.6	41.17	54	-19.4	27.15	3.6	37.32	100	93	Average
2484	51.86	58.43	74	-22.14	27.15	3.6	37.32	100	93	Peak

REMARKS:

- Emission Level = Read Level + Antenna Factor + Cable Loss - Preamp Factor
Margin value = Emission level – Limit value
- 2412MHz: Fundamental frequency.



A D T

EUT TEST CONDITION		MEASUREMENT DETAIL	
CHANNEL	Channel 6	FREQUENCY RANGE	1GHz ~ 25GHz
INPUT POWER (SYSTEM)	120Vac, 60 Hz	DETECTOR FUNCTION	Peak (PK) Average (AV)
ENVIRONMENTAL CONDITIONS	25deg. C, 65%RH	TESTED BY	David Huang

ANTENNA POLARITY & TEST DISTANCE: HORIZONTAL AT 3 M										
FREQ. (MHz)	EMISSION LEVEL (dBuV/m)	READ LEVEL (dBuV)	LIMIT (dBuV/m)	MARGIN (dB)	ANTENNA FACTOR (dB/m)	CABLE LOSS (dB)	PREAMP FACTOR (dB)	ANTENNA HEIGHT (cm)	TABLE ANGLE (Degree)	REMARK
2390	33.19	40.26	54	-20.81	26.91	3.54	37.52	132	28	Average
2390	51.26	58.33	74	-22.74	26.91	3.54	37.52	132	28	Peak
2437	88.56	95.4			27.06	3.56	37.46	132	28	Average
2437	98.33	105.17			27.06	3.56	37.46	132	28	Peak
2484	34.64	41.21	54	-19.36	27.15	3.6	37.32	132	28	Average
2484	52.08	58.65	74	-21.92	27.15	3.6	37.32	132	28	Peak
ANTENNA POLARITY & TEST DISTANCE: VERTICAL AT 3 M										
FREQ. (MHz)	EMISSION LEVEL (dBuV/m)	READ LEVEL (dBuV)	LIMIT (dBuV/m)	MARGIN (dB)	ANTENNA FACTOR (dB/m)	CABLE LOSS (dB)	PREAMP FACTOR (dB)	ANTENNA HEIGHT (cm)	TABLE ANGLE (Degree)	REMARK
2390	34.09	41.16	54	-19.91	26.91	3.54	37.52	100	93	Average
2390	51.2	58.27	74	-22.8	26.91	3.54	37.52	100	93	Peak
2437	94.73	101.57			27.06	3.56	37.46	100	93	Average
2437	104.38	111.22			27.06	3.56	37.46	100	93	Peak
2484	36.6	43.17	54	-17.4	27.15	3.6	37.32	100	93	Average
2484	51.91	58.48	74	-22.09	27.15	3.6	37.32	100	93	Peak

REMARKS:

- Emission Level = Read Level + Antenna Factor + Cable Loss - Preamp Factor
Margin value = Emission level – Limit value
- 2437MHz: Fundamental frequency.



A D T

EUT TEST CONDITION		MEASUREMENT DETAIL	
CHANNEL	Channel 11	FREQUENCY RANGE	1GHz ~ 25GHz
INPUT POWER (SYSTEM)	120Vac, 60 Hz	DETECTOR FUNCTION	Peak (PK) Average (AV)
ENVIRONMENTAL CONDITIONS	25deg. C, 65%RH	TESTED BY	David Huang

ANTENNA POLARITY & TEST DISTANCE: HORIZONTAL AT 3 M										
FREQ. (MHz)	EMISSION LEVEL (dBuV/m)	READ LEVEL (dBuV)	LIMIT (dBuV/m)	MARGIN (dB)	ANTENNA FACTOR (dB/m)	CABLE LOSS (dB)	PREAMP FACTOR (dB)	ANTENNA HEIGHT (cm)	TABLE ANGLE (Degree)	REMARK
2390	32.81	39.88	54	-21.19	26.91	3.54	37.52	129	42	Average
2390	48.42	55.49	74	-25.58	26.91	3.54	37.52	129	42	Peak
2462	96.75	103.46			27.1	3.58	37.39	129	42	Average
2462	106.21	112.92			27.1	3.58	37.39	129	42	Peak
2484	50.57	57.14	54	-3.43	27.15	3.6	37.32	129	42	Average
2484	67.67	74.24	74	-6.33	27.15	3.6	37.32	129	42	Peak
ANTENNA POLARITY & TEST DISTANCE: VERTICAL AT 3 M										
FREQ. (MHz)	EMISSION LEVEL (dBuV/m)	READ LEVEL (dBuV)	LIMIT (dBuV/m)	MARGIN (dB)	ANTENNA FACTOR (dB/m)	CABLE LOSS (dB)	PREAMP FACTOR (dB)	ANTENNA HEIGHT (cm)	TABLE ANGLE (Degree)	REMARK
2390	33.03	40.1	54	-20.97	26.91	3.54	37.52	107	357	Average
2390	49.05	56.12	74	-24.95	26.91	3.54	37.52	107	357	Peak
2462	91.75	98.46			27.1	3.58	37.39	107	357	Average
2462	101.94	108.65			27.1	3.58	37.39	107	357	Peak
2484	44.62	51.19	54	-9.38	27.15	3.6	37.32	107	357	Average
2484	64.16	70.73	74	-9.84	27.15	3.6	37.32	107	357	Peak

REMARKS:

- Emission Level = Read Level + Antenna Factor + Cable Loss - Preamp Factor
Margin value = Emission level – Limit value
- 2462MHz: Fundamental frequency.



802.11n (20MHz)

EUT TEST CONDITION		MEASUREMENT DETAIL	
CHANNEL	Channel 1	FREQUENCY RANGE	1GHz ~ 25GHz
INPUT POWER (SYSTEM)	120Vac, 60 Hz	DETECTOR FUNCTION	Peak (PK) Average (AV)
ENVIRONMENTAL CONDITIONS	25deg. C, 65%RH	TESTED BY	David Huang

ANTENNA POLARITY & TEST DISTANCE: HORIZONTAL AT 3 M

FREQ. (MHz)	EMISSION LEVEL (dBuV/m)	READ LEVEL (dBuV)	LIMIT (dBuV/m)	MARGIN (dB)	ANTENNA FACTOR (dB/m)	CABLE LOSS (dB)	PREAMP FACTOR (dB)	ANTENNA HEIGHT (cm)	TABLE ANGLE (Degree)	REMARK
2390	37.97	45.04	54	-16.03	26.91	3.54	37.52	118	190	Average
2390	55.59	62.66	74	-18.41	26.91	3.54	37.52	118	190	Peak
2412	84.96	91.98			26.96	3.54	37.52	118	190	Average
2412	94.03	101.05			26.96	3.54	37.52	118	190	Peak
2488	33.81	40.31	54	-20.19	27.2	3.62	37.32	118	190	Average
2488	52.42	58.92	74	-21.58	27.2	3.62	37.32	118	190	Peak

ANTENNA POLARITY & TEST DISTANCE: VERTICAL AT 3 M

FREQ. (MHz)	EMISSION LEVEL (dBuV/m)	READ LEVEL (dBuV)	LIMIT (dBuV/m)	MARGIN (dB)	ANTENNA FACTOR (dB/m)	CABLE LOSS (dB)	PREAMP FACTOR (dB)	ANTENNA HEIGHT (cm)	TABLE ANGLE (Degree)	REMARK
2390	44.2	51.27	54	-9.8	26.91	3.54	37.52	102	93	Average
2390	63.95	71.02	74	-10.05	26.91	3.54	37.52	102	93	Peak
2412	92.16	99.18			26.96	3.54	37.52	102	93	Average
2412	101.7	108.72			26.96	3.54	37.52	102	93	Peak
2486	34.65	41.22	54	-19.35	27.15	3.6	37.32	102	93	Average
2486	52.39	58.96	74	-21.61	27.15	3.6	37.32	102	93	Peak

REMARKS:

- Emission Level = Read Level + Antenna Factor + Cable Loss - Preamp Factor
Margin value = Emission level – Limit value
- 2412MHz: Fundamental frequency.



A D T

EUT TEST CONDITION		MEASUREMENT DETAIL	
CHANNEL	Channel 6	FREQUENCY RANGE	1GHz ~ 25GHz
INPUT POWER (SYSTEM)	120Vac, 60 Hz	DETECTOR FUNCTION	Peak (PK) Average (AV)
ENVIRONMENTAL CONDITIONS	25deg. C, 65%RH	TESTED BY	David Huang

ANTENNA POLARITY & TEST DISTANCE: HORIZONTAL AT 3 M										
FREQ. (MHz)	EMISSION LEVEL (dBuV/m)	READ LEVEL (dBuV)	LIMIT (dBuV/m)	MARGIN (dB)	ANTENNA FACTOR (dB/m)	CABLE LOSS (dB)	PREAMP FACTOR (dB)	ANTENNA HEIGHT (cm)	TABLE ANGLE (Degree)	REMARK
2366	33.2	40.37	54	-20.8	26.81	3.52	37.5	117	191	Average
2366	52.76	59.93	74	-21.24	26.81	3.52	37.5	117	191	Peak
2437	85.1	91.94			27.06	3.56	37.46	117	191	Average
2437	95.92	102.76			27.06	3.56	37.46	117	191	Peak
2492	34.22	40.65	54	-19.78	27.2	3.62	37.25	117	191	Average
2492	51.83	58.26	74	-22.17	27.2	3.62	37.25	117	191	Peak
ANTENNA POLARITY & TEST DISTANCE: VERTICAL AT 3 M										
FREQ. (MHz)	EMISSION LEVEL (dBuV/m)	READ LEVEL (dBuV)	LIMIT (dBuV/m)	MARGIN (dB)	ANTENNA FACTOR (dB/m)	CABLE LOSS (dB)	PREAMP FACTOR (dB)	ANTENNA HEIGHT (cm)	TABLE ANGLE (Degree)	REMARK
2368	33.41	40.58	54	-20.59	26.81	3.52	37.5	100	92	Average
2368	51.58	58.75	74	-22.42	26.81	3.52	37.5	100	92	Peak
2437	92.02	98.86			27.06	3.56	37.46	100	92	Average
2437	101.77	108.61			27.06	3.56	37.46	100	92	Peak
2490	52.38	58.88	74	-21.62	27.2	3.62	37.32	100	92	Peak
2499	36.34	42.77	54	-17.66	27.2	3.62	37.25	100	92	Average

REMARKS:

- Emission Level = Read Level + Antenna Factor + Cable Loss - Preamp Factor
Margin value = Emission level – Limit value
- 2437MHz: Fundamental frequency.



A D T

EUT TEST CONDITION		MEASUREMENT DETAIL	
CHANNEL	Channel 11	FREQUENCY RANGE	1GHz ~ 25GHz
INPUT POWER (SYSTEM)	120Vac, 60 Hz	DETECTOR FUNCTION	Peak (PK) Average (AV)
ENVIRONMENTAL CONDITIONS	25deg. C, 65%RH	TESTED BY	David Huang

ANTENNA POLARITY & TEST DISTANCE: HORIZONTAL AT 3 M										
FREQ. (MHz)	EMISSION LEVEL (dBuV/m)	READ LEVEL (dBuV)	LIMIT (dBuV/m)	MARGIN (dB)	ANTENNA FACTOR (dB/m)	CABLE LOSS (dB)	PREAMP FACTOR (dB)	ANTENNA HEIGHT (cm)	TABLE ANGLE (Degree)	REMARK
2390	35.77	42.84	54	-18.23	26.91	3.54	37.52	104	21	Average
2390	48.64	55.71	74	-25.36	26.91	3.54	37.52	104	21	Peak
2462	97.22	103.93			27.1	3.58	37.39	104	21	Average
2462	107	113.71			27.1	3.58	37.39	104	21	Peak
2484	50.62	57.19	54	-3.38	27.15	3.6	37.32	104	21	Average
2484	72.39	78.96	74	-1.61	27.15	3.6	37.32	104	21	Peak
ANTENNA POLARITY & TEST DISTANCE: VERTICAL AT 3 M										
FREQ. (MHz)	EMISSION LEVEL (dBuV/m)	READ LEVEL (dBuV)	LIMIT (dBuV/m)	MARGIN (dB)	ANTENNA FACTOR (dB/m)	CABLE LOSS (dB)	PREAMP FACTOR (dB)	ANTENNA HEIGHT (cm)	TABLE ANGLE (Degree)	REMARK
2390	34.03	41.1	54	-19.97	26.91	3.54	37.52	100	227	Average
2390	48.52	55.59	74	-25.48	26.91	3.54	37.52	100	227	Peak
2462	88.13	94.84			27.1	3.58	37.39	100	227	Average
2462	97.56	104.27			27.1	3.58	37.39	100	227	Peak
2484	45.71	52.28	54	-8.29	27.15	3.6	37.32	100	227	Average
2484	59.83	66.4	74	-14.17	27.15	3.6	37.32	100	227	Peak

REMARKS:

- Emission Level = Read Level + Antenna Factor + Cable Loss - Preamp Factor
Margin value = Emission level – Limit value
- 2462MHz: Fundamental frequency.



A D T

BELOW 1GHz WORST-CASE DATA:

802.11n (20MHz)

EUT TEST CONDITION		MEASUREMENT DETAIL	
CHANNEL	Channel 11	FREQUENCY RANGE	30MHz ~ 1GHz
INPUT POWER (SYSTEM)	120Vac, 60 Hz	DETECTOR FUNCTION	Peak (PK)
ENVIRONMENTAL CONDITIONS	25deg. C, 65%RH	TESTED BY	David Huang

ANTENNA POLARITY & TEST DISTANCE: HORIZONTAL AT 3 M

FREQ. (MHz)	EMISSION LEVEL (dBuV/m)	READ LEVEL (dBuV)	LIMIT (dBuV/m)	MARGIN (dB)	ANTENNA FACTOR (dB/m)	CABLE LOSS (dB)	PREAMP FACTOR (dB)	ANTENNA HEIGHT (cm)	TABLE ANGLE (Degree)	REMARK
57	27.67	45.96	40	-12.33	12.25	0.81	31.35	100	145	Peak
108.3	27.56	48.39	43.5	-15.94	9.9	1.12	31.85	100	203	Peak
188.49	34.4	54.37	43.5	-9.1	10.19	1.54	31.7	100	135	Peak
320.3	21.1	37.44	46	-24.9	13.43	2.12	31.89	100	55	Peak
501.6	21.19	32.68	46	-24.81	17.35	2.78	31.62	100	198	Peak
617.1	23.36	32.55	46	-22.64	19.81	3.14	32.14	100	318	Peak

ANTENNA POLARITY & TEST DISTANCE: VERTICAL AT 3 M

FREQ. (MHz)	EMISSION LEVEL (dBuV/m)	READ LEVEL (dBuV)	LIMIT (dBuV/m)	MARGIN (dB)	ANTENNA FACTOR (dB/m)	CABLE LOSS (dB)	PREAMP FACTOR (dB)	ANTENNA HEIGHT (cm)	TABLE ANGLE (Degree)	REMARK
58.08	33.24	51.63	40	-6.76	12.15	0.81	31.35	102	146	Peak
146.91	24.5	42.18	43.5	-19	12.61	1.33	31.62	100	175	Peak
183.09	26.7	46.45	43.5	-16.8	10.53	1.51	31.79	100	263	Peak
423.2	19.64	33.38	46	-26.36	15.79	2.51	32.04	100	212	Peak
546.4	22.17	32.73	46	-23.83	18.37	2.93	31.86	100	48	Peak
662.6	24.91	33.17	46	-21.09	20.36	3.29	31.91	100	237	Peak

REMARKS: Emission Level = Read Level + Antenna Factor + Cable Loss - Preamp Factor
 Margin value = Emission level – Limit value

4.2 CONDUCTED EMISSION MEASUREMENT

4.2.1 LIMITS OF CONDUCTED EMISSION MEASUREMENT

FREQUENCY OF EMISSION (MHz)	CONDUCTED LIMIT (dB μ V)	
	Quasi-peak	Average
0.15 ~ 0.5	66 to 56	56 to 46
0.5 ~ 5	56	46
5 ~ 30	60	50

- NOTE:** 1. The lower limit shall apply at the transition frequencies.
2. The limit decreases in line with the logarithm of the frequency in the range of 0.15 to 0.50MHz.
3. All emanations from a class A/B digital device or system, including any network of conductors and apparatus connected thereto, shall not exceed the level of field strengths specified above.

4.2.2 TEST INSTRUMENTS

Tested Date: Nov. 21, 2013

DESCRIPTION & MANUFACTURER	MODEL NO.	SERIAL NO.	DATE OF CALIBRATION	DUE DATE OF CALIBRATION
Test Receiver ROHDE & SCHWARZ	ESCS30	100288	Nov. 17, 2013	Nov. 16, 2014
RF signal cable Woken	5D-FB	Cable-HYCO2-01	Dec. 28, 2012	Dec. 27, 2013
LISN ROHDE & SCHWARZ (EUT)	ESH2-Z5	100100	Dec. 21, 2012	Dec. 20, 2013
LISN ROHDE & SCHWARZ (Peripheral)	ESH3-Z5	100311	Jul. 17, 2013	Jul. 16, 2014
Software ADT	BV ADT_Cond_ V7.3.7.3	NA	NA	NA

- NOTE:** 1. The calibration interval of the above test instruments is 12 months and the calibrations are traceable to NML/ROC and NIST/USA.
2. The test was performed in HwaYa Shielded Room 2.
3. The VCCI Site Registration No. is C-2047.



A D T

4.2.3 TEST PROCEDURES

- a. The EUT was placed 0.4 meters from the conducting wall of the shielded room with EUT being connected to the power mains through a line impedance stabilization network (LISN). Other support units were connected to the power mains through another LISN. The two LISNs provide 50 ohm/ 50uH of coupling impedance for the measuring instrument.
- b. Both lines of the power mains connected to the EUT were checked for maximum conducted interference.
- c. The frequency range from 150kHz to 30MHz was searched. Emission levels under (Limit - 20dB) was not recorded.

NOTE: All modes of operation were investigated and the worst-case emissions are reported.

4.2.4 DEVIATION FROM TEST STANDARD

No deviation.

4.2.5 TEST SETUP

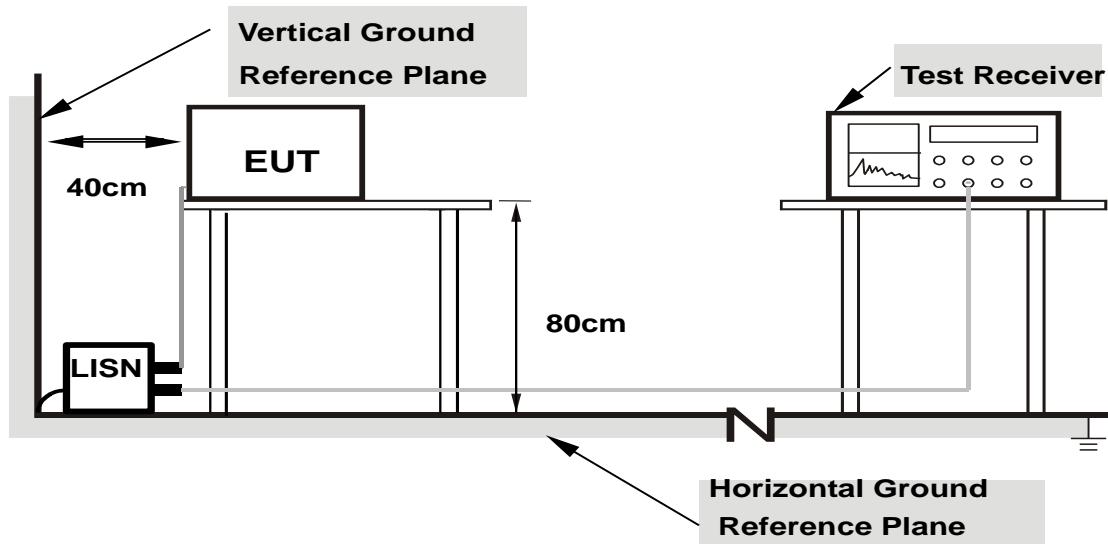

- Note:**
1. Support units were connected to second LISN.
 2. Both of LISNs (AMN) are 80 cm from EUT and at least 80 from other units and other metal planes

For the actual test configuration, please refer to the attached file (Test Setup Photo).

4.2.6 EUT OPERATING CONDITIONS

Same as 4.1.6.

4.2.7 TEST RESULTS

CONDUCTED WORST-CASE DATA :

PHASE	Line 1	6dB BANDWIDTH	9kHz
--------------	--------	----------------------	------

No	Freq.	Corr. Factor	Reading Value		Emission Level		Limit		Margin	
	[MHz]		[dB (uV)]		[dB (uV)]		[dB (uV)]		(dB)	
			Q.P.	AV.	Q.P.	AV.	Q.P.	AV.	Q.P.	AV.
1	0.17734	0.17	44.50	31.01	44.67	31.18	64.61	54.61	-19.94	-23.43
2	0.34922	0.20	32.94	21.17	33.14	21.37	58.98	48.98	-25.84	-27.61
3	0.99766	0.27	32.61	17.68	32.88	17.95	56.00	46.00	-23.12	-28.05
4	1.84766	0.28	28.09	18.00	28.37	18.28	56.00	46.00	-27.63	-27.72
5	4.79688	0.38	24.82	16.32	25.20	16.70	56.00	46.00	-30.80	-29.30
6	13.56250	0.50	34.73	32.37	35.23	32.87	60.00	50.00	-24.77	-17.13

REMARKS:

1. Q.P. and AV. are abbreviations of quasi-peak and average individually.
2. The emission levels of other frequencies were very low against the limit.
3. Margin value = Emission level - Limit value
4. Correction factor = Insertion loss + Cable loss
5. Emission Level = Correction Factor + Reading Value

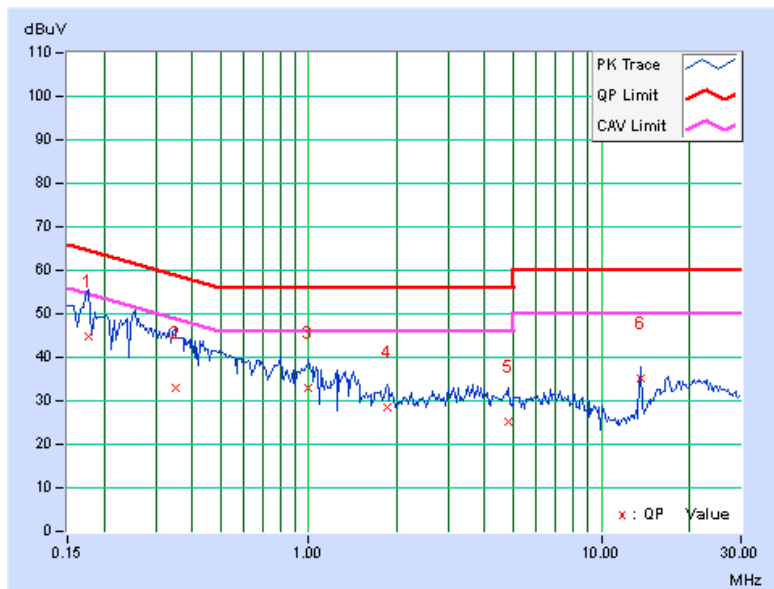

PHASE	Line 2	6dB BANDWIDTH	9kHz
-------	--------	---------------	------

No	Freq. [MHz]	Corr. Factor (dB)	Reading Value		Emission Level		Limit		Margin	
			[dB (uV)]		[dB (uV)]		[dB (uV)]		(dB)	
			Q.P.	AV.	Q.P.	AV.	Q.P.	AV.	Q.P.	AV.
1	0.25938	0.20	40.51	25.17	40.71	25.37	61.45	51.45	-20.74	-26.08
2	0.66953	0.24	33.64	18.54	33.88	18.78	56.00	46.00	-22.12	-27.22
3	0.89609	0.23	25.97	8.69	26.20	8.92	56.00	46.00	-29.80	-37.08
4	1.48438	0.25	24.79	13.90	25.04	14.15	56.00	46.00	-30.96	-31.85
5	13.55859	0.57	37.92	28.20	38.49	28.77	60.00	50.00	-21.51	-21.23
6	20.18359	0.73	24.26	15.38	24.99	16.11	60.00	50.00	-35.01	-33.89

REMARKS:

1. Q.P. and AV. are abbreviations of quasi-peak and average individually.
2. The emission levels of other frequencies were very low against the limit.
3. Margin value = Emission level - Limit value
4. Correction factor = Insertion loss + Cable loss
5. Emission Level = Correction Factor + Reading Value

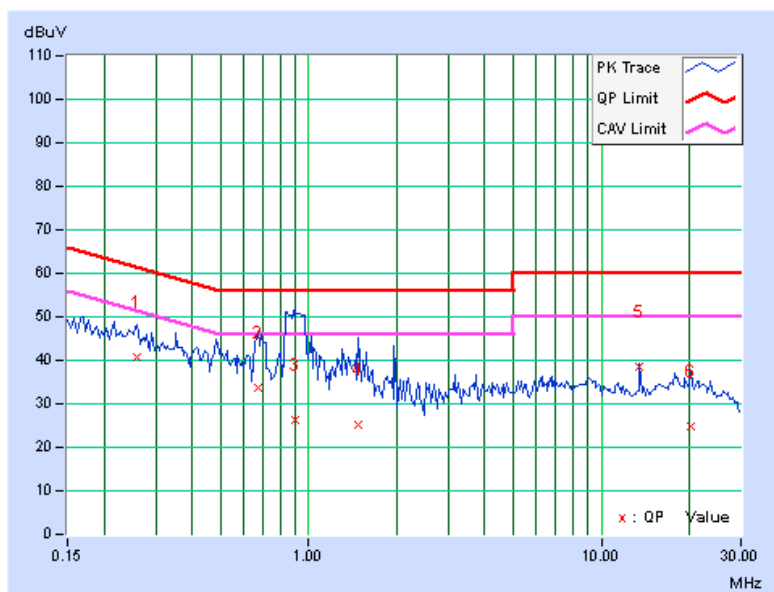

4.3 6dB BANDWIDTH MEASUREMENT

4.3.1 LIMITS OF 6dB BANDWIDTH MEASUREMENT

The minimum of 6dB Bandwidth Measurement is 0.5 MHz.

4.3.2 TEST SETUP

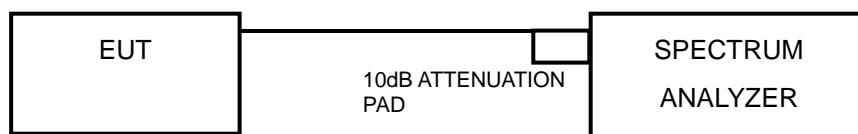

4.3.3 TEST INSTRUMENTS

Refer to section 4.1.2 to get information of above instrument.

4.3.4 TEST PROCEDURE

- a. Set resolution bandwidth (RBW) = 100kHz
- b. Set the video bandwidth (VBW) $\geq 3 \times$ RBW, Detector = Peak.
- c. Trace mode = max hold.
- d. Sweep = auto couple.
- e. Measure the maximum width of the emission that is constrained by the frequencies associated with the two amplitude points (upper and lower) that are attenuated by 6 dB relative to the maximum level measured in the fundamental emission

4.3.5 DEVIATION FROM TEST STANDARD

No deviation.

4.3.6 EUT OPERATING CONDITIONS

The software provided by client to enable the EUT under transmission condition continuously at lowest, middle and highest channel frequencies individually.



4.3.7 TEST RESULTS

802.11b

CHANNEL	FREQUENCY (MHz)	6dB BANDWIDTH (MHz)	MINIMUM LIMIT (MHz)	PASS / FAIL
1	2412	9.55	0.5	PASS
6	2437	8.6	0.5	PASS
11	2462	8.56	0.5	PASS

802.11g

CHANNEL	FREQUENCY (MHz)	6dB BANDWIDTH (MHz)	MINIMUM LIMIT (MHz)	PASS / FAIL
1	2412	16.43	0.5	PASS
6	2437	16.41	0.5	PASS
11	2462	16.36	0.5	PASS

802.11n (20MHz)

CHANNEL	FREQUENCY (MHz)	6dB BANDWIDTH (MHz)	MINIMUM LIMIT (MHz)	PASS / FAIL
1	2412	17.62	0.5	PASS
6	2437	17.58	0.5	PASS
11	2462	17.33	0.5	PASS



A D T

SPECTRUM PLOT OF WORST VALUE

802.11b

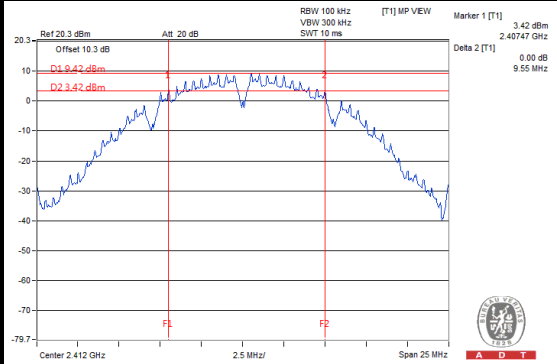

802.11g

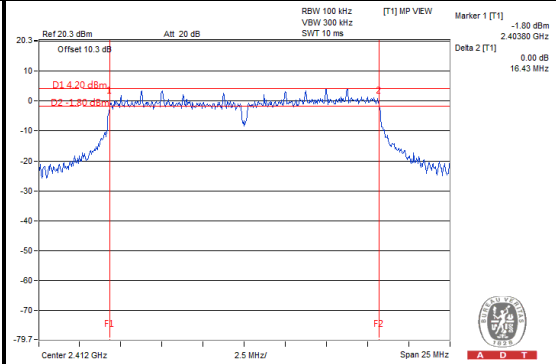

802.11n (20MHz)

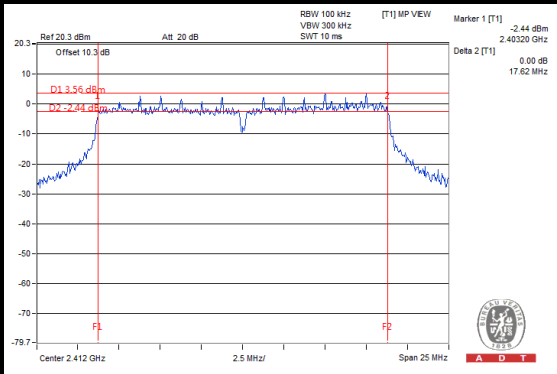

4.4 CONDUCTED OUTPUT POWER

4.4.1 LIMITS OF CONDUCTED OUTPUT POWER MEASUREMENT

For systems using digital modulation in the 2400–2483.5 MHz bands: 1 Watt (30dBm)

4.4.2 TEST SETUP

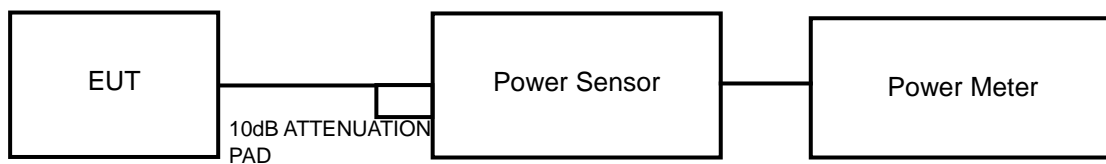

4.4.3 TEST INSTRUMENTS

Refer to section 4.1.2 to get information of above instrument.

4.4.4 TEST PROCEDURES

A peak power sensor was used on the output port of the EUT. A power meter was used to read the response of the peak power sensor. Record the peak power level.

4.4.5 DEVIATION FROM TEST STANDARD

No deviation.

4.4.6 EUT OPERATING CONDITIONS

Same as Item 4.3.6.



A D T

4.4.7 TEST RESULTS

802.11b

CHANNEL	FREQUENCY (MHz)	PEAK POWER (mW)	PEAK POWER (dBm)	LIMIT (dBm)	PASS/FAIL
1	2412	114.288	20.58	30	PASS
6	2437	112.202	20.5	30	PASS
11	2462	108.393	20.35	30	PASS

802.11g

CHANNEL	FREQUENCY (MHz)	PEAK POWER (mW)	PEAK POWER (dBm)	LIMIT (dBm)	PASS/FAIL
1	2412	162.930	22.12	30	PASS
6	2437	159.956	22.04	30	PASS
11	2462	150.314	21.77	30	PASS

802.11n (20MHz)

CHANNEL	FREQUENCY (MHz)	PEAK POWER (mW)	PEAK POWER (dBm)	LIMIT (dBm)	PASS/FAIL
1	2412	154.882	21.9	30	PASS
6	2437	149.279	21.74	30	PASS
11	2462	149.968	21.76	30	PASS

4.5 POWER SPECTRAL DENSITY MEASUREMENT

4.5.1 LIMITS OF POWER SPECTRAL DENSITY MEASUREMENT

The Maximum of Power Spectral Density Measurement is 8dBm.

4.5.2 TEST SETUP



4.5.3 TEST INSTRUMENTS

Refer to section 4.1.2 to get information of above instrument.

4.5.4 TEST PROCEDURE

- Set the RBW = 3 kHz, VBW = 10 kHz, Detector = peak.
- Sweep time = auto couple, Trace mode = max hold, allow trace to fully stabilize.
- Use the peak marker function to determine the maximum power level in any 100 kHz band segment within the fundamental EBW.

4.5.5 DEVIATION FROM TEST STANDARD

No deviation.

4.5.6 EUT OPERATING CONDITION

Same as Item 4.3.6



A D T

4.5.7 TEST RESULTS

802.11b

Channel	FREQ. (MHz)	PSD (dBm/3kHz)	Limit (dBm/3kHz)	PASS /FAIL
1	2412	-4.45	8	PASS
6	2437	-3.60	8	PASS
11	2462	-4.09	8	PASS

802.11g

Channel	FREQ. (MHz)	PSD (dBm/3kHz)	Limit (dBm/3kHz)	PASS /FAIL
1	2412	-10.40	8	PASS
6	2437	-11.42	8	PASS
11	2462	-10.61	8	PASS

802.11n (20MHz)

Channel	FREQ. (MHz)	PSD (dBm/3kHz)	Limit (dBm/3kHz)	PASS /FAIL
1	2412	-11.30	8	PASS
6	2437	-11.01	8	PASS
11	2462	-9.65	8	PASS



A D T

SPECTRUM PLOT OF WORST VALUE

802.11b

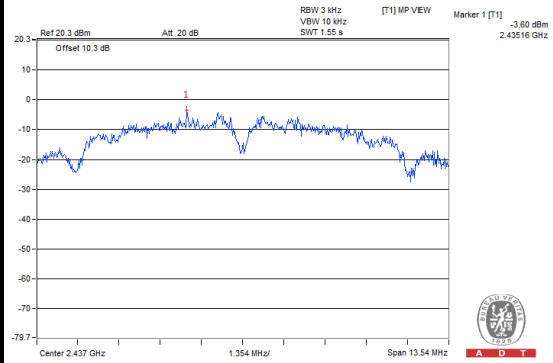

802.11g

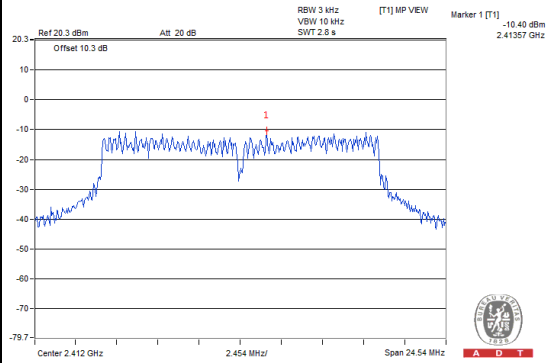

802.11n (20MHz)

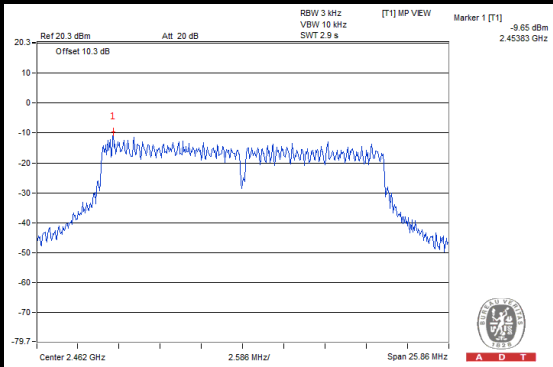

4.6 CONDUCTED OUT OF BAND EMISSION MEASUREMENT

4.6.1 LIMITS OF CONDUCTED OUT OF BAND EMISSION MEASUREMENT

Below -20dB of the highest emission level of operating band (in 100kHz Resolution Bandwidth).

4.6.2 TEST SETUP

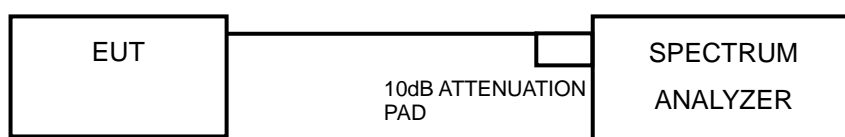

4.6.3 TEST INSTRUMENTS

Refer to section 4.1.2 to get information of above instrument.

4.6.4 TEST PROCEDURE

MEASUREMENT PROCEDURE REF

1. Set the RBW = 100 kHz.
2. Set the VBW \geq 300 kHz.
3. Detector = peak.
4. Sweep time = auto couple.
5. Trace mode = max hold.
6. Allow trace to fully stabilize.
7. Use the peak marker function to determine the maximum power level in any 100 kHz band segment within the fundamental EBW.



A D T

MEASUREMENT PROCEDURE OOBE

1. Set RBW = 100 kHz.
2. Set VBW \geq 300 kHz.
3. Ensure that the number of measurement points \geq span/RBW
4. According to measurement points to set differ measurement span.
5. Detector = peak.
6. Trace Mode = max hold.
7. Sweep = auto couple.

4.6.5 DEVIATION FROM TEST STANDARD

No deviation.

4.6.6 EUT OPERATING CONDITION

Same as Item 4.3.6

4.6.7 TEST RESULTS

The spectrum plots are attached on the following pages. D1 line indicates the highest level, and D2 line indicates the 20dB offset below D1. It shows compliance with the requirement.



A D T

802.11b

CH 1

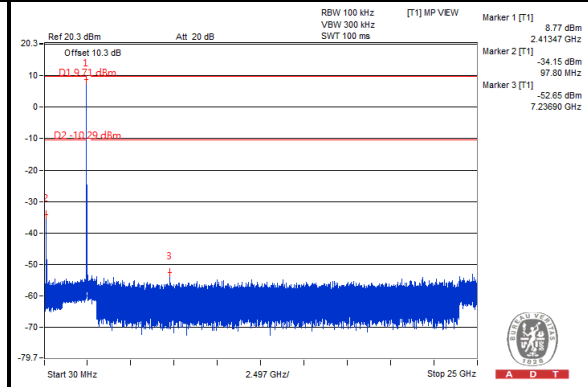
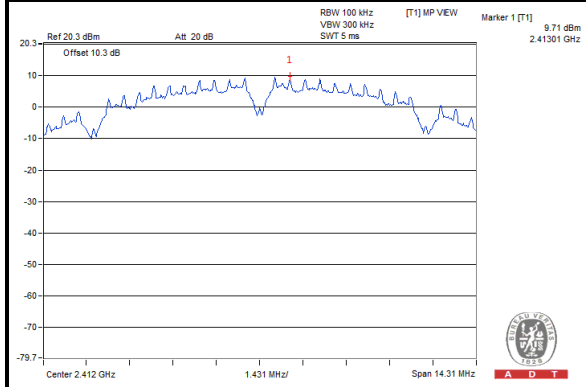

CH 6

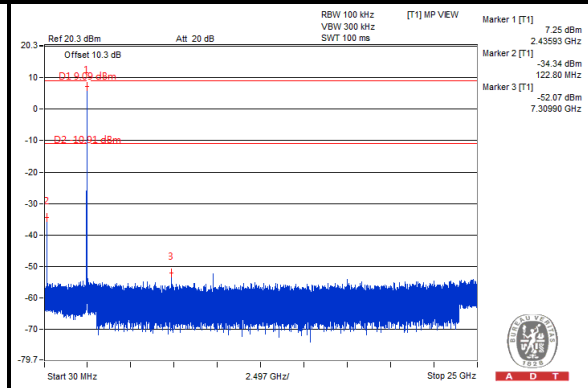
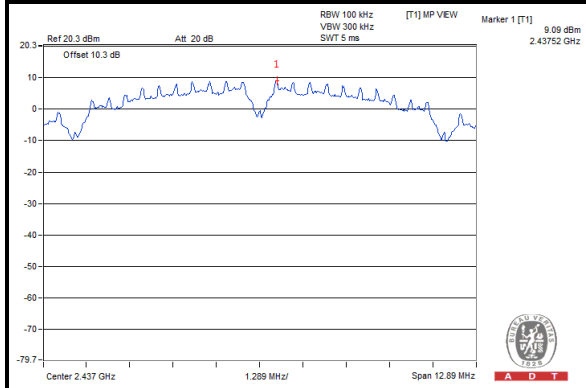

CH 11

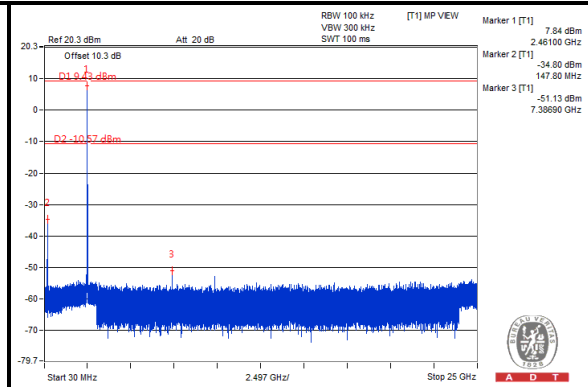
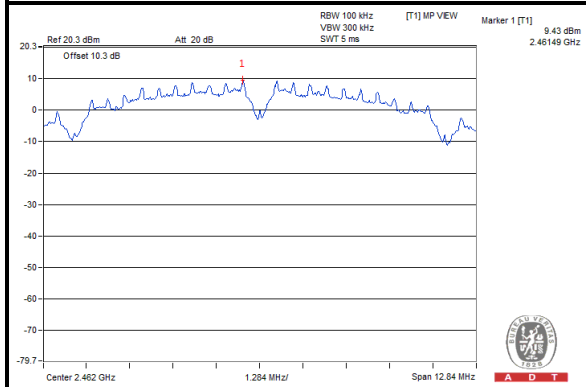



A D T

802.11g

CH 1

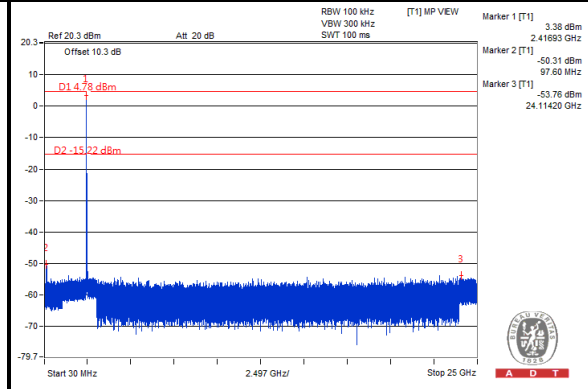
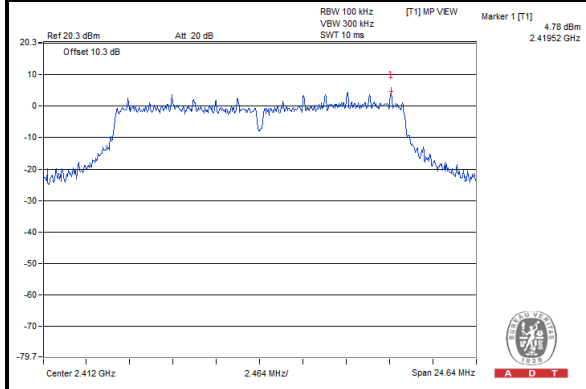

CH 6

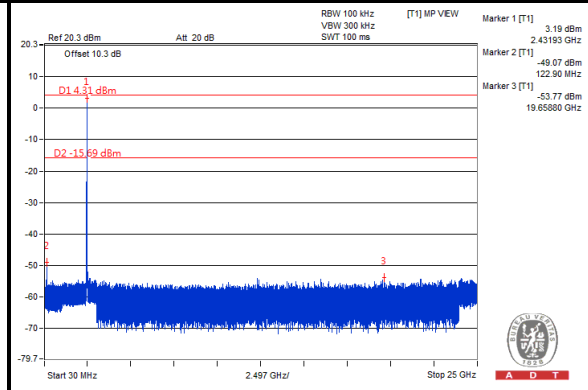
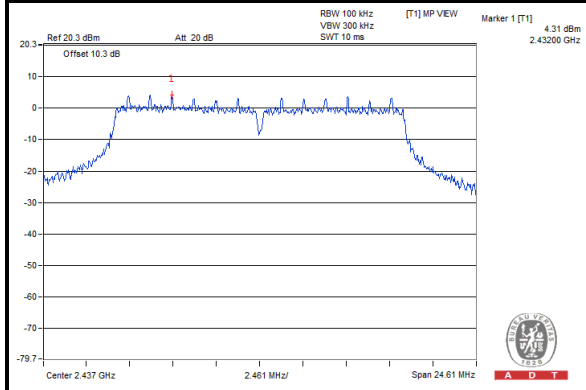

CH 11

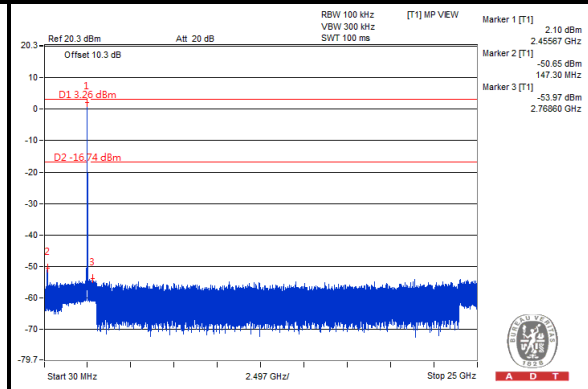
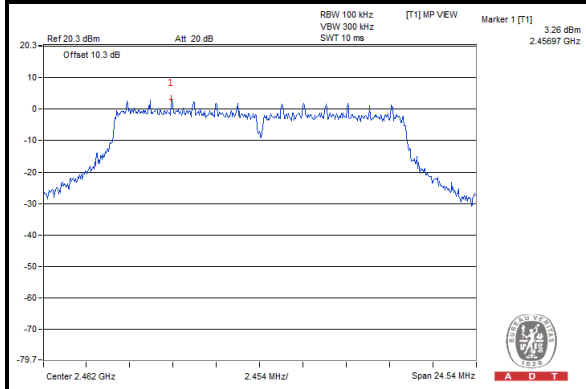



A D T

802.11n (20MHz)

CH 1

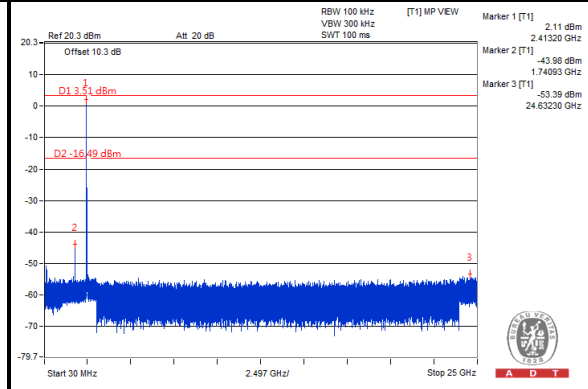
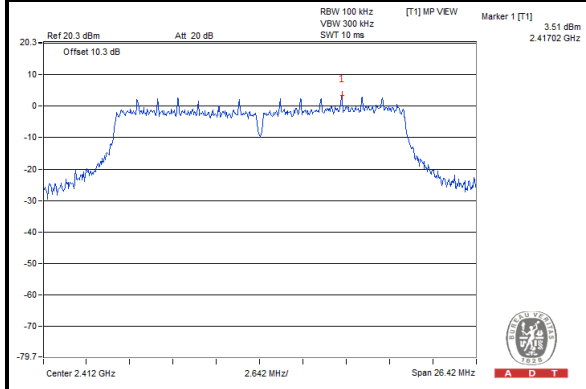

CH 6

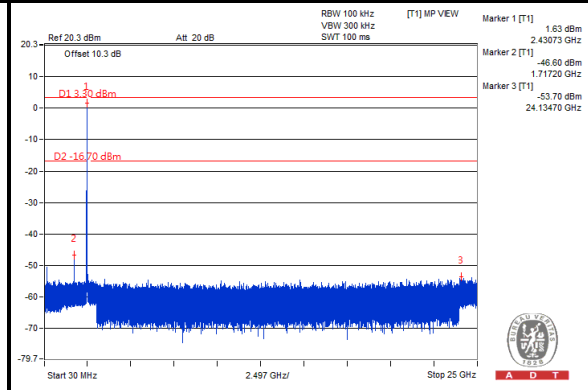
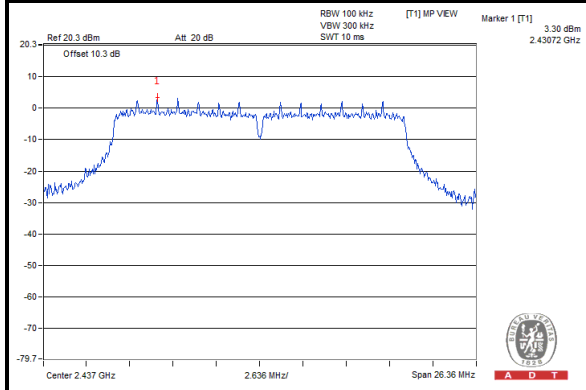

CH 11

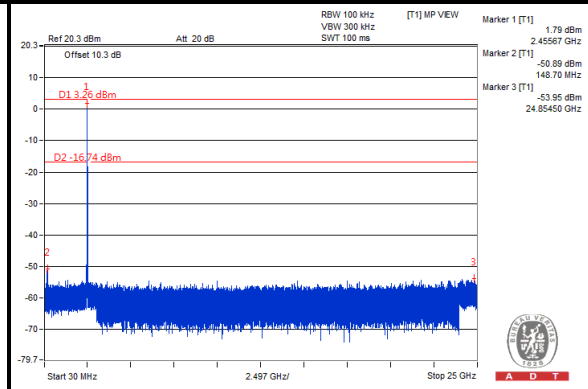
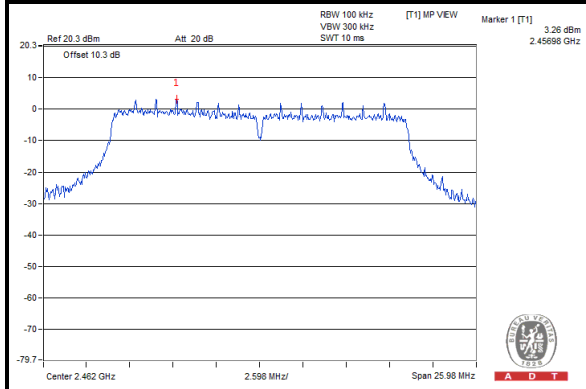

5. TEST TYPES AND RESULTS (FOR 5.0GHz BAND)

5.1 RADIATED EMISSION AND BANDEDGE MEASUREMENT

5.1.1 LIMITS OF RADIATED EMISSION AND BANDEDGE MEASUREMENT

Radiated emissions which fall in the restricted bands must comply with the radiated emission limits specified as below table. Other emissions shall be at least 20dB below the highest level of the desired power:

FREQUENCIES (MHz)	FIELD STRENGTH (microvolts/meter)	MEASUREMENT DISTANCE (meters)
0.009 ~ 0.490	2400/F(kHz)	300
0.490 ~ 1.705	24000/F(kHz)	30
1.705 ~ 30.0	30	30
30 ~ 88	100	3
88 ~ 216	150	3
216 ~ 960	200	3
Above 960	500	3

NOTE:

1. The lower limit shall apply at the transition frequencies.
2. Emission level (dBuV/m) = 20 log Emission level (uV/m).
3. For frequencies above 1000MHz, the field strength limits are based on average detector, however, the peak field strength of any emission shall not exceed the maximum permitted average limits, specified above by more than 20dB under any condition of modulation.



A D T

5.1.2 TEST INSTRUMENTS

Same as item 4.1.2.

5.1.3 TEST PROCEDURES

Same as item 4.1.3.

5.1.4 DEVIATION FROM TEST STANDARD

No deviation.

5.1.5 TEST SETUP

Same as item 4.1.5.

5.1.6 EUT OPERATING CONDITIONS

Same as 4.1.6.



A D T

5.1.7 TEST RESULTS

ABOVE 1GHz WORST-CASE DATA : 802.11a

EUT TEST CONDITION		MEASUREMENT DETAIL	
CHANNEL	Channel 149	FREQUENCY RANGE	1GHz ~ 40GHz
INPUT POWER (SYSTEM)	120Vac, 60 Hz	DETECTOR FUNCTION	Peak (PK) Average (AV)
ENVIRONMENTAL CONDITIONS	25deg. C, 65%RH	TESTED BY	David Huang

ANTENNA POLARITY & TEST DISTANCE: HORIZONTAL AT 3 M										
FREQ. (MHz)	EMISSION LEVEL (dBuV/m)	READ LEVEL (dBuV)	LIMIT (dBuV/m)	MARGIN (dB)	ANTENNA FACTOR (dB/m)	CABLE LOSS (dB)	PREAMP FACTOR (dB)	ANTENNA HEIGHT (cm)	TABLE ANGLE (Degree)	REMARK
5725	50.47	50.35	75.65	-25.18	31.96	5.59	37.43	100	307	Average
5725	68.01	67.89	84.76	-16.75	31.96	5.59	37.43	100	307	Peak
5745	95.65	95.53			31.99	5.6	37.47	100	307	Average
5745	104.76	104.64			31.99	5.6	37.47	100	307	Peak
5850	38.01	37.71	75.65	-37.64	32.15	5.66	37.51	100	307	Average
5850	55.08	54.78	84.76	-29.68	32.15	5.66	37.51	100	307	Peak
ANTENNA POLARITY & TEST DISTANCE: VERTICAL AT 3 M										
FREQ. (MHz)	EMISSION LEVEL (dBuV/m)	READ LEVEL (dBuV)	LIMIT (dBuV/m)	MARGIN (dB)	ANTENNA FACTOR (dB/m)	CABLE LOSS (dB)	PREAMP FACTOR (dB)	ANTENNA HEIGHT (cm)	TABLE ANGLE (Degree)	REMARK
5725	49.45	49.33	74.62	-25.17	31.96	5.59	37.43	100	36	Average
5725	68.51	68.39	84.03	-15.52	31.96	5.59	37.43	100	36	Peak
5745	94.62	94.5			31.99	5.6	37.47	100	36	Average
5745	104.03	103.91			31.99	5.6	37.47	100	36	Peak
5850	38.08	37.78	74.62	-36.54	32.15	5.66	37.51	100	36	Average
5850	54.84	54.54	84.03	-29.19	32.15	5.66	37.51	100	36	Peak

REMARKS:

- Emission Level = Read Level + Antenna Factor + Cable Loss - Preamp Factor
Margin value = Emission level – Limit value
- 5745MHz: Fundamental frequency.
- 5725MHz & 5850MHz: Out of restricted band



A D T

EUT TEST CONDITION		MEASUREMENT DETAIL	
CHANNEL	Channel 157	FREQUENCY RANGE	1GHz ~ 40GHz
INPUT POWER (SYSTEM)	120Vac, 60 Hz	DETECTOR FUNCTION	Peak (PK) Average (AV)
ENVIRONMENTAL CONDITIONS	25deg. C, 65%RH	TESTED BY	David Huang

ANTENNA POLARITY & TEST DISTANCE: HORIZONTAL AT 3 M										
FREQ. (MHz)	EMISSION LEVEL (dBuV/m)	READ LEVEL (dBuV)	LIMIT (dBuV/m)	MARGIN (dB)	ANTENNA FACTOR (dB/m)	CABLE LOSS (dB)	PREAMP FACTOR (dB)	ANTENNA HEIGHT (cm)	TABLE ANGLE (Degree)	REMARK
5725	38.29	38.17	75.73	-37.44	31.96	5.59	37.43	100	305	Average
5725	54.73	54.61	84.78	-30.05	31.96	5.59	37.43	100	305	Peak
5785	95.73	95.61			32.04	5.62	37.54	100	305	Average
5785	104.78	104.66			32.04	5.62	37.54	100	305	Peak
5850	38.75	38.45	75.73	-36.98	32.15	5.66	37.51	100	305	Average
5850	54.65	54.35	84.78	-30.13	32.15	5.66	37.51	100	305	Peak
ANTENNA POLARITY & TEST DISTANCE: VERTICAL AT 3 M										
FREQ. (MHz)	EMISSION LEVEL (dBuV/m)	READ LEVEL (dBuV)	LIMIT (dBuV/m)	MARGIN (dB)	ANTENNA FACTOR (dB/m)	CABLE LOSS (dB)	PREAMP FACTOR (dB)	ANTENNA HEIGHT (cm)	TABLE ANGLE (Degree)	REMARK
5725	37.87	37.75	74.26	-36.39	31.96	5.59	37.43	100	35	Average
5725	53.63	53.51	83.82	-30.19	31.96	5.59	37.43	100	35	Peak
5785	94.26	94.14			32.04	5.62	37.54	100	35	Average
5785	103.82	103.7			32.04	5.62	37.54	100	35	Peak
5850	38.26	37.96	74.26	-36	32.15	5.66	37.51	100	35	Average
5850	54.08	53.78	83.82	-29.74	32.15	5.66	37.51	100	35	Peak

REMARKS:

- Emission Level = Read Level + Antenna Factor + Cable Loss - Preamp Factor
Margin value = Emission level – Limit value
- 5785MHz: Fundamental frequency.
- 5725MHz & 5850MHz: Out of restricted band



A D T

EUT TEST CONDITION		MEASUREMENT DETAIL	
CHANNEL	Channel 165	FREQUENCY RANGE	1GHz ~ 40GHz
INPUT POWER (SYSTEM)	120Vac, 60 Hz	DETECTOR FUNCTION	Peak (PK) Average (AV)
ENVIRONMENTAL CONDITIONS	25deg. C, 65%RH	TESTED BY	David Huang

ANTENNA POLARITY & TEST DISTANCE: HORIZONTAL AT 3 M										
FREQ. (MHz)	EMISSION LEVEL (dBuV/m)	READ LEVEL (dBuV)	LIMIT (dBuV/m)	MARGIN (dB)	ANTENNA FACTOR (dB/m)	CABLE LOSS (dB)	PREAMP FACTOR (dB)	ANTENNA HEIGHT (cm)	TABLE ANGLE (Degree)	REMARK
5725	37.97	37.85	74.87	-36.9	31.96	5.59	37.43	100	308	Average
5725	56.62	56.5	84.15	-27.53	31.96	5.59	37.43	100	308	Peak
5825	94.87	94.64			32.12	5.64	37.53	100	308	Average
5825	104.15	103.92			32.12	5.64	37.53	100	308	Peak
5850	44.85	44.55	74.87	-30.02	32.15	5.66	37.51	100	308	Average
5850	64.8	64.5	84.15	-19.35	32.15	5.66	37.51	100	308	Peak
ANTENNA POLARITY & TEST DISTANCE: VERTICAL AT 3 M										
FREQ. (MHz)	EMISSION LEVEL (dBuV/m)	READ LEVEL (dBuV)	LIMIT (dBuV/m)	MARGIN (dB)	ANTENNA FACTOR (dB/m)	CABLE LOSS (dB)	PREAMP FACTOR (dB)	ANTENNA HEIGHT (cm)	TABLE ANGLE (Degree)	REMARK
5725	37.75	37.63	73.24	-35.49	31.96	5.59	37.43	106	41	Average
5725	55.41	55.29	82.79	-27.38	31.96	5.59	37.43	106	41	Peak
5825	93.24	93.01			32.12	5.64	37.53	106	41	Average
5825	102.79	102.56			32.12	5.64	37.53	106	41	Peak
5850	42.98	42.68	73.24	-30.26	32.15	5.66	37.51	106	41	Average
5850	61.39	61.09	82.79	-21.4	32.15	5.66	37.51	106	41	Peak

REMARKS:

- Emission Level = Read Level + Antenna Factor + Cable Loss - Preamp Factor
Margin value = Emission level – Limit value
- 5825MHz: Fundamental frequency.
- 5725MHz & 5850MHz: Out of restricted band



A D T

802.11n (20MHz)

EUT TEST CONDITION		MEASUREMENT DETAIL	
CHANNEL	Channel 149	FREQUENCY RANGE	1GHz ~ 40GHz
INPUT POWER (SYSTEM)	120Vac, 60 Hz	DETECTOR FUNCTION	Peak (PK) Average (AV)
ENVIRONMENTAL CONDITIONS	25deg. C, 65%RH	TESTED BY	David Huang

ANTENNA POLARITY & TEST DISTANCE: HORIZONTAL AT 3 M										
FREQ. (MHz)	EMISSION LEVEL (dBuV/m)	READ LEVEL (dBuV)	LIMIT (dBuV/m)	MARGIN (dB)	ANTENNA FACTOR (dB/m)	CABLE LOSS (dB)	PREAMP FACTOR (dB)	ANTENNA HEIGHT (cm)	TABLE ANGLE (Degree)	REMARK
5725	55.23	55.11	75.88	-20.65	31.96	5.59	37.43	100	306	Average
5725	70.24	70.12	85.32	-15.08	31.96	5.59	37.43	100	306	Peak
5745	95.88	95.76			31.99	5.6	37.47	100	306	Average
5745	105.32	105.2			31.99	5.6	37.47	100	306	Peak
5850	37.95	37.65	75.88	-37.93	32.15	5.66	37.51	100	306	Average
5850	55.29	54.99	85.32	-30.03	32.15	5.66	37.51	100	306	Peak

ANTENNA POLARITY & TEST DISTANCE: VERTICAL AT 3 M										
FREQ. (MHz)	EMISSION LEVEL (dBuV/m)	READ LEVEL (dBuV)	LIMIT (dBuV/m)	MARGIN (dB)	ANTENNA FACTOR (dB/m)	CABLE LOSS (dB)	PREAMP FACTOR (dB)	ANTENNA HEIGHT (cm)	TABLE ANGLE (Degree)	REMARK
5725	54.03	53.91	74.72	-20.69	31.96	5.59	37.43	100	37	Average
5725	72.19	72.07	84.51	-12.32	31.96	5.59	37.43	100	37	Peak
5745	94.72	94.6			31.99	5.6	37.47	100	37	Average
5745	104.51	104.39			31.99	5.6	37.47	100	37	Peak
5850	37.94	37.64	74.72	-36.78	32.15	5.66	37.51	100	37	Average
5850	55.66	55.36	84.51	-28.85	32.15	5.66	37.51	100	37	Peak

REMARKS:

1. Emission Level = Read Level + Antenna Factor + Cable Loss - Preamp Factor
Margin value = Emission level – Limit value
2. 5745MHz: Fundamental frequency.
3. 5725MHz & 5850MHz: Out of restricted band



A D T

EUT TEST CONDITION		MEASUREMENT DETAIL	
CHANNEL	Channel 157	FREQUENCY RANGE	1GHz ~ 40GHz
INPUT POWER (SYSTEM)	120Vac, 60 Hz	DETECTOR FUNCTION	Peak (PK) Average (AV)
ENVIRONMENTAL CONDITIONS	25deg. C, 65%RH	TESTED BY	David Huang

ANTENNA POLARITY & TEST DISTANCE: HORIZONTAL AT 3 M										
FREQ. (MHz)	EMISSION LEVEL (dBuV/m)	READ LEVEL (dBuV)	LIMIT (dBuV/m)	MARGIN (dB)	ANTENNA FACTOR (dB/m)	CABLE LOSS (dB)	PREAMP FACTOR (dB)	ANTENNA HEIGHT (cm)	TABLE ANGLE (Degree)	REMARK
5725	38.26	38.14	76.69	-38.43	31.96	5.59	37.43	100	307	Average
5725	54.54	54.42	85.81	-31.27	31.96	5.59	37.43	100	307	Peak
5785	96.69	96.57			32.04	5.62	37.54	100	307	Average
5785	105.81	105.69			32.04	5.62	37.54	100	307	Peak
5850	38.67	38.37	76.69	-38.02	32.15	5.66	37.51	100	307	Average
5850	56.69	56.39	85.81	-29.12	32.15	5.66	37.51	100	307	Peak
ANTENNA POLARITY & TEST DISTANCE: VERTICAL AT 3 M										
FREQ. (MHz)	EMISSION LEVEL (dBuV/m)	READ LEVEL (dBuV)	LIMIT (dBuV/m)	MARGIN (dB)	ANTENNA FACTOR (dB/m)	CABLE LOSS (dB)	PREAMP FACTOR (dB)	ANTENNA HEIGHT (cm)	TABLE ANGLE (Degree)	REMARK
5725	38.19	38.07	75.08	-36.89	31.96	5.59	37.43	100	37	Average
5725	54.15	54.03	84.39	-30.24	31.96	5.59	37.43	100	37	Peak
5785	95.08	94.96			32.04	5.62	37.54	100	37	Average
5785	104.39	104.27			32.04	5.62	37.54	100	37	Peak
5850	38.21	37.91	75.08	-36.87	32.15	5.66	37.51	100	37	Average
5850	55.02	54.72	84.39	-29.37	32.15	5.66	37.51	100	37	Peak

REMARKS:

1. Emission Level = Read Level + Antenna Factor + Cable Loss - Preamp Factor
Margin value = Emission level – Limit value
2. 5785MHz: Fundamental frequency.
3. 5725MHz & 5850MHz: Out of restricted band



A D T

EUT TEST CONDITION		MEASUREMENT DETAIL	
CHANNEL	Channel 165	FREQUENCY RANGE	1GHz ~ 40GHz
INPUT POWER (SYSTEM)	120Vac, 60 Hz	DETECTOR FUNCTION	Peak (PK) Average (AV)
ENVIRONMENTAL CONDITIONS	25deg. C, 65%RH	TESTED BY	David Huang

ANTENNA POLARITY & TEST DISTANCE: HORIZONTAL AT 3 M										
FREQ. (MHz)	EMISSION LEVEL (dBuV/m)	READ LEVEL (dBuV)	LIMIT (dBuV/m)	MARGIN (dB)	ANTENNA FACTOR (dB/m)	CABLE LOSS (dB)	PREAMP FACTOR (dB)	ANTENNA HEIGHT (cm)	TABLE ANGLE (Degree)	REMARK
5725	38.06	37.94	76.13	-38.07	31.96	5.59	37.43	100	296	Average
5725	54.08	53.96	85.37	-31.29	31.96	5.59	37.43	100	296	Peak
5825	96.13	95.9			32.12	5.64	37.53	100	296	Average
5825	105.37	105.14			32.12	5.64	37.53	100	296	Peak
5850	47.86	47.56	76.13	-28.27	32.15	5.66	37.51	100	296	Average
5850	64.63	64.33	85.37	-20.74	32.15	5.66	37.51	100	296	Peak
ANTENNA POLARITY & TEST DISTANCE: VERTICAL AT 3 M										
FREQ. (MHz)	EMISSION LEVEL (dBuV/m)	READ LEVEL (dBuV)	LIMIT (dBuV/m)	MARGIN (dB)	ANTENNA FACTOR (dB/m)	CABLE LOSS (dB)	PREAMP FACTOR (dB)	ANTENNA HEIGHT (cm)	TABLE ANGLE (Degree)	REMARK
5725	37.82	37.7	73.75	-35.93	31.96	5.59	37.43	107	35	Average
5725	54.09	53.97	82.87	-28.78	31.96	5.59	37.43	107	35	Peak
5825	93.75	93.52			32.12	5.64	37.53	107	35	Average
5825	102.87	102.64			32.12	5.64	37.53	107	35	Peak
5850	46.98	46.68	73.75	-26.77	32.15	5.66	37.51	107	35	Average
5850	64.01	63.71	82.87	-18.86	32.15	5.66	37.51	107	35	Peak

REMARKS:

1. Emission Level = Read Level + Antenna Factor + Cable Loss - Preamp Factor
Margin value = Emission level – Limit value
2. 5825MHz: Fundamental frequency.
3. 5725MHz & 5850MHz: Out of restricted band



A D T

802.11n (40MHz)

EUT TEST CONDITION		MEASUREMENT DETAIL	
CHANNEL	Channel 151	FREQUENCY RANGE	1GHz ~ 40GHz
INPUT POWER (SYSTEM)	120Vac, 60 Hz	DETECTOR FUNCTION	Peak (PK) Average (AV)
ENVIRONMENTAL CONDITIONS	25deg. C, 65%RH	TESTED BY	David Huang

ANTENNA POLARITY & TEST DISTANCE: HORIZONTAL AT 3 M										
FREQ. (MHz)	EMISSION LEVEL (dBuV/m)	READ LEVEL (dBuV)	LIMIT (dBuV/m)	MARGIN (dB)	ANTENNA FACTOR (dB/m)	CABLE LOSS (dB)	PREAMP FACTOR (dB)	ANTENNA HEIGHT (cm)	TABLE ANGLE (Degree)	REMARK
5725	45.84	45.72	70.29	-24.45	31.96	5.59	37.43	100	306	Average
5725	60.49	60.37	79.38	-18.89	31.96	5.59	37.43	100	306	Peak
5755	90.29	90.15			32.01	5.6	37.47	100	306	Average
5755	99.38	99.24			32.01	5.6	37.47	100	306	Peak
5850	38.33	38.03	70.29	-31.96	32.15	5.66	37.51	100	306	Average
5850	54.34	54.04	79.38	-25.04	32.15	5.66	37.51	100	306	Peak
ANTENNA POLARITY & TEST DISTANCE: VERTICAL AT 3 M										
FREQ. (MHz)	EMISSION LEVEL (dBuV/m)	READ LEVEL (dBuV)	LIMIT (dBuV/m)	MARGIN (dB)	ANTENNA FACTOR (dB/m)	CABLE LOSS (dB)	PREAMP FACTOR (dB)	ANTENNA HEIGHT (cm)	TABLE ANGLE (Degree)	REMARK
5725	45.54	45.42	69.31	-23.77	31.96	5.59	37.43	100	37	Average
5725	58.91	58.79	78.92	-20.01	31.96	5.59	37.43	100	37	Peak
5755	89.31	89.17			32.01	5.6	37.47	100	37	Average
5755	98.92	98.78			32.01	5.6	37.47	100	37	Peak
5850	38.19	37.89	69.31	-31.12	32.15	5.66	37.51	100	37	Average
5850	54.34	54.04	78.92	-24.58	32.15	5.66	37.51	100	37	Peak

REMARKS:

- Emission Level = Read Level + Antenna Factor + Cable Loss - Preamp Factor
Margin value = Emission level – Limit value
- 5755MHz: Fundamental frequency.
- 5725MHz & 5850MHz: Out of restricted band



EUT TEST CONDITION		MEASUREMENT DETAIL	
CHANNEL	Channel 159	FREQUENCY RANGE	1GHz ~ 40GHz
INPUT POWER (SYSTEM)	120Vac, 60 Hz	DETECTOR FUNCTION	Peak (PK) Average (AV)
ENVIRONMENTAL CONDITIONS	25deg. C, 65%RH	TESTED BY	David Huang

ANTENNA POLARITY & TEST DISTANCE: HORIZONTAL AT 3 M										
FREQ. (MHz)	EMISSION LEVEL (dBuV/m)	READ LEVEL (dBuV)	LIMIT (dBuV/m)	MARGIN (dB)	ANTENNA FACTOR (dB/m)	CABLE LOSS (dB)	PREAMP FACTOR (dB)	ANTENNA HEIGHT (cm)	TABLE ANGLE (Degree)	REMARK
5725	38.66	38.54	70.71	-32.05	31.96	5.59	37.43	100	295	Average
5725	54.18	54.06	79.22	-25.04	31.96	5.59	37.43	100	295	Peak
5795	90.71	90.55			32.07	5.63	37.54	100	295	Average
5795	99.22	99.06			32.07	5.63	37.54	100	295	Peak
5850	39.14	38.84	70.71	-31.57	32.15	5.66	37.51	100	295	Average
5850	54.61	54.31	79.22	-24.61	32.15	5.66	37.51	100	295	Peak
ANTENNA POLARITY & TEST DISTANCE: VERTICAL AT 3 M										
FREQ. (MHz)	EMISSION LEVEL (dBuV/m)	READ LEVEL (dBuV)	LIMIT (dBuV/m)	MARGIN (dB)	ANTENNA FACTOR (dB/m)	CABLE LOSS (dB)	PREAMP FACTOR (dB)	ANTENNA HEIGHT (cm)	TABLE ANGLE (Degree)	REMARK
5725	38.53	38.41	68.88	-30.35	31.96	5.59	37.43	100	43	Average
5725	54.33	54.21	77.74	-23.41	31.96	5.59	37.43	100	43	Peak
5795	88.88	88.72			32.07	5.63	37.54	100	43	Average
5795	97.74	97.58			32.07	5.63	37.54	100	43	Peak
5850	38.56	38.26	68.88	-30.32	32.15	5.66	37.51	100	43	Average
5850	54.08	53.78	77.74	-23.66	32.15	5.66	37.51	100	43	Peak

REMARKS:

- Emission Level = Read Level + Antenna Factor + Cable Loss - Preamp Factor
Margin value = Emission level – Limit value
- 5795MHz: Fundamental frequency.
- 5725MHz & 5850MHz: Out of restricted band



802.11ac (80MHz)

EUT TEST CONDITION		MEASUREMENT DETAIL	
CHANNEL	Channel 155	FREQUENCY RANGE	1GHz ~ 40GHz
INPUT POWER (SYSTEM)	120Vac, 60 Hz	DETECTOR FUNCTION	Peak (PK) Average (AV)
ENVIRONMENTAL CONDITIONS	25deg. C, 65%RH	TESTED BY	David Huang

ANTENNA POLARITY & TEST DISTANCE: HORIZONTAL AT 3 M

FREQ. (MHz)	EMISSION LEVEL (dBuV/m)	READ LEVEL (dBuV)	LIMIT (dBuV/m)	MARGIN (dB)	ANTENNA FACTOR (dB/m)	CABLE LOSS (dB)	PREAMP FACTOR (dB)	ANTENNA HEIGHT (cm)	TABLE ANGLE (Degree)	REMARK
5725	47.37	47.25	68.36	-20.99	31.96	5.59	37.43	100	307	Average
5725	58.24	58.12	77.79	-19.55	31.96	5.59	37.43	100	307	Peak
5775	88.36	88.2			32.04	5.62	37.5	100	307	Average
5775	97.79	97.63			32.04	5.62	37.5	100	307	Peak
5850	42.79	42.49	68.36	-25.57	32.15	5.66	37.51	100	307	Average
5850	57.72	57.42	77.79	-20.07	32.15	5.66	37.51	100	307	Peak

ANTENNA POLARITY & TEST DISTANCE: VERTICAL AT 3 M

FREQ. (MHz)	EMISSION LEVEL (dBuV/m)	READ LEVEL (dBuV)	LIMIT (dBuV/m)	MARGIN (dB)	ANTENNA FACTOR (dB/m)	CABLE LOSS (dB)	PREAMP FACTOR (dB)	ANTENNA HEIGHT (cm)	TABLE ANGLE (Degree)	REMARK
5725	45.97	45.85	66.8	-20.83	31.96	5.59	37.43	100	42	Average
5725	60.34	60.22	76.27	-15.93	31.96	5.59	37.43	100	42	Peak
5775	86.8	86.64			32.04	5.62	37.5	100	42	Average
5775	96.27	96.11			32.04	5.62	37.5	100	42	Peak
5850	40.9	40.6	66.8	-25.9	32.15	5.66	37.51	100	42	Average
5850	54.91	54.61	76.27	-21.36	32.15	5.66	37.51	100	42	Peak

REMARKS:

- Emission Level = Read Level + Antenna Factor + Cable Loss - Preamp Factor
Margin value = Emission level – Limit value
- 5775MHz: Fundamental frequency.
- 5725MHz & 5850MHz: Out of restricted band



A D T

BELOW 1GHz WORST-CASE DATA :

802.11n (20MHz)

EUT TEST CONDITION		MEASUREMENT DETAIL	
CHANNEL	Channel 149	FREQUENCY RANGE	30MHz ~ 1GHz
INPUT POWER (SYSTEM)	120Vac, 60 Hz	DETECTOR FUNCTION	Peak (PK) Quasi-peak (QP)
ENVIRONMENTAL CONDITIONS	25deg. C, 65%RH	TESTED BY	David Huang

ANTENNA POLARITY & TEST DISTANCE: HORIZONTAL AT 3 M										
FREQ. (MHz)	EMISSION LEVEL (dBuV/m)	READ LEVEL (dBuV)	LIMIT (dBuV/m)	MARGIN (dB)	ANTENNA FACTOR (dB/m)	CABLE LOSS (dB)	PREAMP FACTOR (dB)	ANTENNA HEIGHT (cm)	TABLE ANGLE (Degree)	REMARK
57.81	27.17	45.56	40	-12.83	12.15	0.81	31.35	100	194	Peak
108.03	25.9	46.84	43.5	-17.6	9.81	1.11	31.86	100	263	Peak
183.36	34.22	53.97	43.5	-9.28	10.53	1.51	31.79	100	243	Peak
320.3	20.69	37.03	46	-25.31	13.43	2.12	31.89	100	176	Peak
542.9	22.6	33.18	46	-23.4	18.3	2.92	31.8	100	180	Peak
699.7	25.09	32.64	46	-20.91	20.81	3.43	31.79	100	215	Peak
ANTENNA POLARITY & TEST DISTANCE: VERTICAL AT 3 M										
FREQ. (MHz)	EMISSION LEVEL (dBuV/m)	READ LEVEL (dBuV)	LIMIT (dBuV/m)	MARGIN (dB)	ANTENNA FACTOR (dB/m)	CABLE LOSS (dB)	PREAMP FACTOR (dB)	ANTENNA HEIGHT (cm)	TABLE ANGLE (Degree)	REMARK
58.62	33.15	51.64	40	-6.85	12.04	0.82	31.35	100	231	Peak
107.49	21.44	42.38	43.5	-22.06	9.81	1.11	31.86	100	110	Peak
183.36	26.69	46.44	43.5	-16.81	10.53	1.51	31.79	100	52	Peak
401.5	19.71	34.01	46	-26.29	15.37	2.43	32.1	100	103	Peak
570.9	22.91	33.03	46	-23.09	18.95	3.01	32.08	100	277	Peak
700.4	25.56	33.1	46	-20.44	20.82	3.43	31.79	100	81	Peak

REMARKS: Emission Level = Read Level + Antenna Factor + Cable Loss - Preamp Factor
Margin value = Emission level – Limit value

5.2 CONDUCTED EMISSION MEASUREMENT

5.2.1 LIMITS OF CONDUCTED EMISSION MEASUREMENT

FREQUENCY OF EMISSION (MHz)	CONDUCTED LIMIT (dB μ V)	
	Quasi-peak	Average
0.15 ~ 0.5	66 to 56	56 to 46
0.5 ~ 5	56	46
5 ~ 30	60	50

- NOTE:**
1. The lower limit shall apply at the transition frequencies.
 2. The limit decreases in line with the logarithm of the frequency in the range of 0.15 to 0.50MHz.
 3. All emanations from a class A/B digital device or system, including any network of conductors and apparatus connected thereto, shall not exceed the level of field strengths specified above.

5.2.2 TEST INSTRUMENTS

Same as item 4.2.2.

5.2.3 TEST PROCEDURES

Same as item 4.2.3.

5.2.4 DEVIATION FROM TEST STANDARD

No deviation.

5.2.5 TEST SETUP

Same as item 4.2.5.

5.2.6 EUT OPERATING CONDITIONS

Same as 4.1.6

5.2.7 TEST RESULTS

CONDUCTED WORST-CASE DATA :

PHASE	Line 1	6dB BANDWIDTH	9kHz
--------------	--------	----------------------	------

No	Freq.	Corr. Factor	Reading Value		Emission Level		Limit		Margin	
	[MHz]		[dB (uV)]		[dB (uV)]		[dB (uV)]		(dB)	
			Q.P.	AV.	Q.P.	AV.	Q.P.	AV.	Q.P.	AV.
1	0.17344	0.17	37.37	28.50	37.54	28.67	64.79	54.79	-27.25	-26.12
2	0.43125	0.21	31.30	22.36	31.51	22.57	57.23	47.23	-25.72	-24.66
3	0.70469	0.24	31.70	22.56	31.94	22.80	56.00	46.00	-24.06	-23.20
4	1.29688	0.27	28.25	18.13	28.52	18.40	56.00	46.00	-27.48	-27.60
5	13.55859	0.50	39.01	36.86	39.51	37.36	60.00	50.00	-20.49	-12.64
6	20.51172	0.64	22.19	15.95	22.83	16.59	60.00	50.00	-37.17	-33.41

REMARKS:

1. Q.P. and AV. are abbreviations of quasi-peak and average individually.
2. The emission levels of other frequencies were very low against the limit.
3. Margin value = Emission level - Limit value
4. Correction factor = Insertion loss + Cable loss
5. Emission Level = Correction Factor + Reading Value

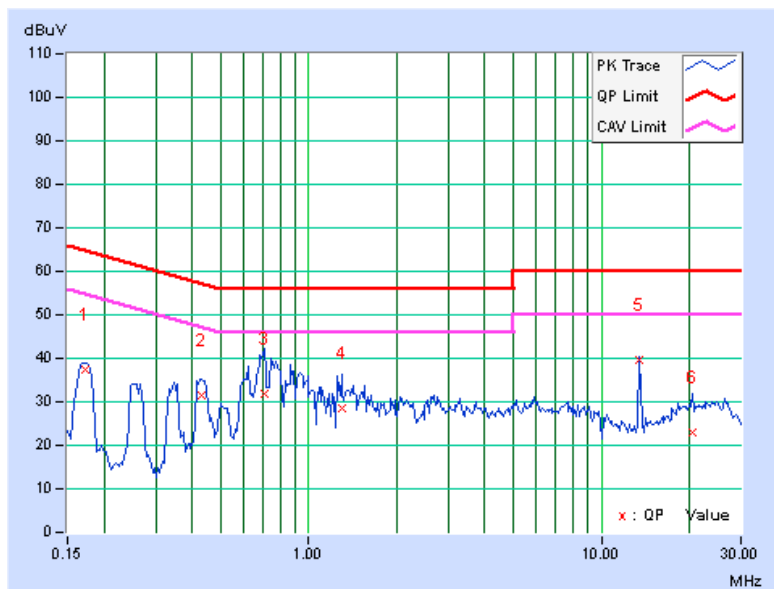

PHASE	Line 2	6dB BANDWIDTH	9kHz
-------	--------	---------------	------

No	Freq. [MHz]	Corr. Factor (dB)	Reading Value [dB (uV)]		Emission Level [dB (uV)]		Limit [dB (uV)]		Margin (dB)	
			Q.P.	AV.	Q.P.	AV.	Q.P.	AV.	Q.P.	AV.
			1	0.25938	0.20	34.84	22.93	35.04	23.13	61.45
2	0.42344	0.25	33.71	21.15	33.96	21.40	57.38	47.38	-23.42	-25.98
3	0.77109	0.24	33.99	21.88	34.23	22.12	56.00	46.00	-21.77	-23.88
4	1.52344	0.26	27.22	16.00	27.48	16.26	56.00	46.00	-28.52	-29.74
5	7.01563	0.44	23.42	13.47	23.86	13.91	60.00	50.00	-36.14	-36.09
6	13.55859	0.57	39.60	35.02	40.17	35.59	60.00	50.00	-19.83	-14.41

REMARKS:

1. Q.P. and AV. are abbreviations of quasi-peak and average individually.
2. The emission levels of other frequencies were very low against the limit.
3. Margin value = Emission level - Limit value
4. Correction factor = Insertion loss + Cable loss
5. Emission Level = Correction Factor + Reading Value

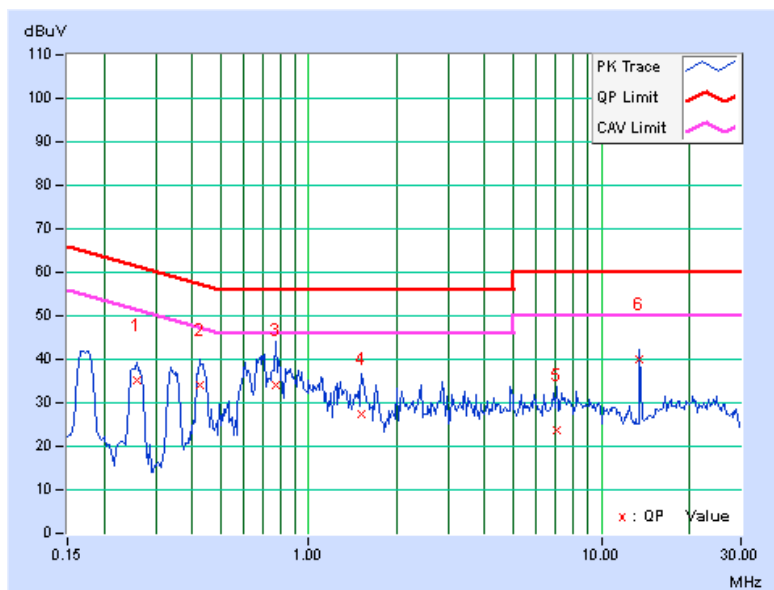



A D T

5.3 6dB BANDWIDTH MEASUREMENT

5.3.1 LIMITS OF 6dB BANDWIDTH MEASUREMENT

The minimum of 6dB Bandwidth Measurement is 0.5MHz.

5.3.2 TEST SETUP

Same as item 4.3.2.

5.3.3 TEST INSTRUMENTS

Refer to section 4.1.2 to get information of above instrument.

5.3.4 TEST PROCEDURE

Same as item 4.3.4.

5.3.5 DEVIATION FROM TEST STANDARD

No deviation.

5.3.6 EUT OPERATING CONDITIONS

Same as item 4.3.6.



5.3.7 TEST RESULTS

802.11a

CHANNEL	CHANNEL FREQUENCY (MHz)	6dB BANDWIDTH (MHz)	MINIMUM LIMIT (MHz)	PASS / FAIL
149	5745	16.37	0.5	PASS
157	5785	16.42	0.5	PASS
165	5825	16.41	0.5	PASS

802.11n (20MHz)

CHANNEL	CHANNEL FREQUENCY (MHz)	6dB BANDWIDTH (MHz)	MINIMUM LIMIT (MHz)	PASS / FAIL
149	5745	16.42	0.5	PASS
157	5785	17.61	0.5	PASS
165	5825	16.42	0.5	PASS

802.11n (40MHz)

CHANNEL	CHANNEL FREQUENCY (MHz)	6dB BANDWIDTH (MHz)	MINIMUM LIMIT (MHz)	PASS / FAIL
151	5755	35.29	0.5	PASS
159	5795	35.29	0.5	PASS

802.11ac (80MHz)

CHANNEL	CHANNEL FREQUENCY (MHz)	6dB BANDWIDTH (MHz)	MINIMUM LIMIT (MHz)	PASS / FAIL
155	5775	75.41	0.5	PASS



A D T

SPECTRUM PLOT OF WORST VALUE

802.11a

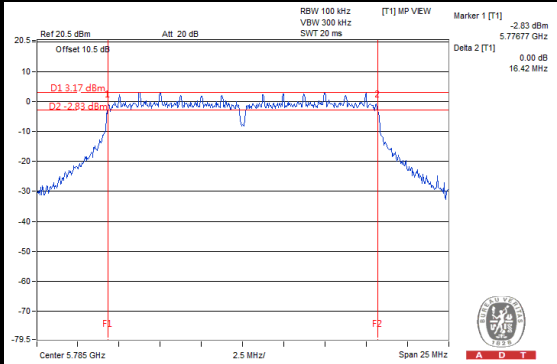

802.11n (20MHz)

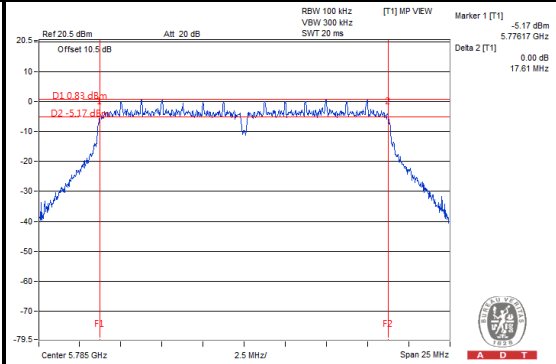

802.11n (40MHz)

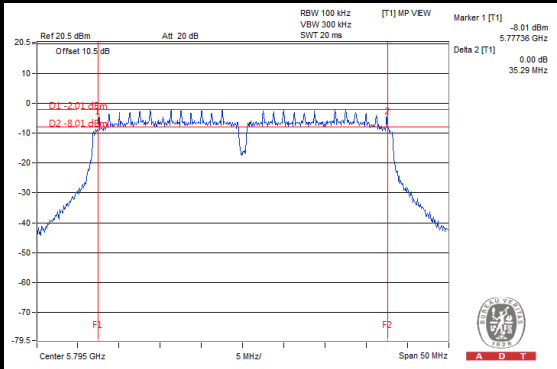

802.11ac (80MHz)

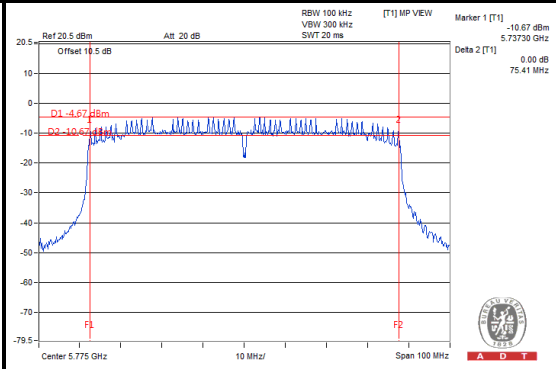

5.4 MAXIMUM OUTPUT POWER

5.4.1 LIMITS OF MAXIMUM OUTPUT POWER MEASUREMENT

For systems using digital modulation in the 5725–5850 MHz bands: 1 Watt (30dBm)

5.4.2 TEST SETUP

Same as Item 4.4.2.

5.4.3 INSTRUMENTS

Refer to section 4.1.2 to get information of above instrument.

5.4.4 TEST PROCEDURES

Same as Item 4.4.4.

5.4.5 DEVIATION FROM TEST STANDARD

No deviation.

5.4.6 EUT OPERATING CONDITIONS

Same as Item 4.3.6.



5.4.7 TEST RESULTS

802.11a

CHANNEL	FREQUENCY (MHz)	PEAK POWER (mW)	PEAK POWER (dBm)	LIMIT (dBm)	PASS/FAIL
149	5745	307.610	24.88	30	PASS
157	5785	309.030	24.9	30	PASS
165	5825	303.389	24.82	30	PASS

802.11n (20MHz)

CHANNEL	FREQUENCY (MHz)	PEAK POWER (mW)	PEAK POWER (dBm)	LIMIT (dBm)	PASS/FAIL
149	5745	324.340	25.11	30	PASS
157	5785	333.426	25.23	30	PASS
165	5825	322.849	25.09	30	PASS

802.11n (40MHz)

CHANNEL	FREQUENCY (MHz)	PEAK POWER (mW)	PEAK POWER (dBm)	LIMIT (dBm)	PASS/FAIL
151	5755	236.048	23.73	30	PASS
159	5795	228.560	23.59	30	PASS

802.11ac (80MHz)

CHANNEL	FREQUENCY (MHz)	PEAK POWER (mW)	PEAK POWER (dBm)	LIMIT (dBm)	PASS/FAIL
155	5775	103.514	20.15	30	PASS



A D T

5.5 POWER SPECTRAL DENSITY MEASUREMENT

5.5.1 LIMITS OF POWER SPECTRAL DENSITY MEASUREMENT

The Maximum of Power Spectral Density Measurement is 8dBm.

5.5.2 TEST SETUP

Same as item 4.5.2.

5.5.3 TEST INSTRUMENTS

Refer to section 4.1.2 to get information of above instrument.

5.5.4 TEST PROCEDURE.

Same as item 4.5.4.

5.5.5 DEVIATION FROM TEST STANDARD

No deviation.

5.5.6 EUT OPERATING CONDITION

Same as item 4.3.6.



5.5.7 TEST RESULTS

802.11a

Channel	FREQ. (MHz)	PSD (dBm/3kHz)	Limit (dBm/3kHz)	PASS /FAIL
149	5745	-10.91	8	PASS
157	5785	-11.49	8	PASS
165	5825	-11.12	8	PASS

802.11n (20MHz)

Channel	FREQ. (MHz)	PSD (dBm/3kHz)	Limit (dBm/3kHz)	PASS /FAIL
149	5745	-10.81	8	PASS
157	5785	-9.58	8	PASS
165	5825	-9.88	8	PASS

802.11n (40MHz)

Channel	FREQ. (MHz)	PSD (dBm/100kHz)	Limit (dBm/3kHz)	PASS /FAIL
151	5755	-13.58	8	PASS
159	5795	-15.35	8	PASS

802.11ac (80MHz)

Channel	FREQ. (MHz)	PSD (dBm/3kHz)	Limit (dBm/3kHz)	PASS /FAIL
155	5775	-19.48	8	PASS



A D T

SPECTRUM PLOT OF WORST VALUE

802.11a

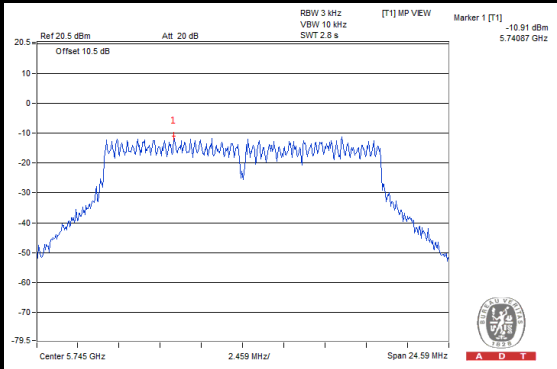

802.11n (20MHz)

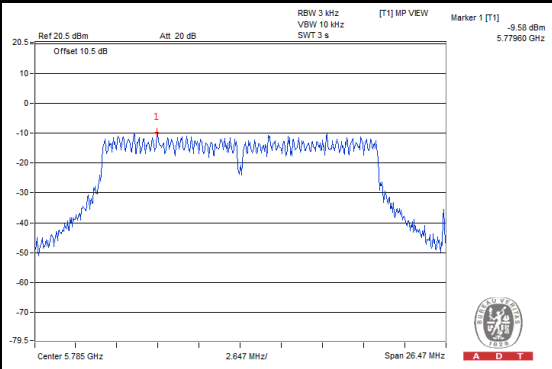

802.11n (40MHz)

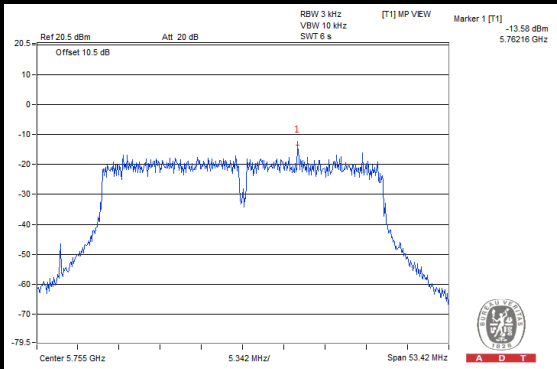

802.11ac (80MHz)

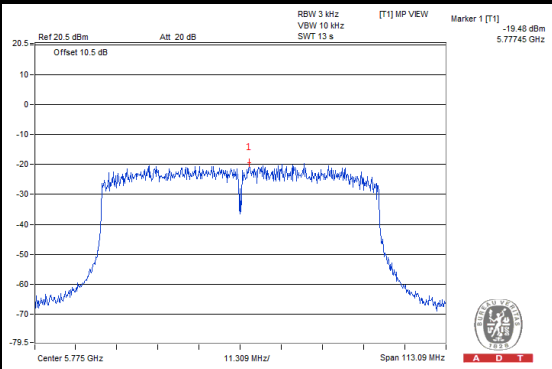

5.6 CONDUCTED OUT OF BAND EMISSION MEASUREMENT

5.6.1 LIMITS OF OUT OF BAND EMISSION MEASUREMENT

Below -20dB of the highest emission level of operating band (in 100kHz Resolution Bandwidth).

5.6.2 TEST SETUP

Same as Item 4.6.2

5.6.3 TEST INSTRUMENTS

Refer to section 4.1.2 to get information of above instrument.

5.6.4 TEST PROCEDURE

Same as Item 4.6.4

5.6.5 DEVIATION FROM TEST STANDARD

No deviation.

5.6.6 EUT OPERATING CONDITION

Same as Item 4.3.6

5.6.7 TEST RESULTS

The spectrum plots are attached on the following pages. D1 line indicates the highest level, and D2 line indicates the 20dB offset below D1. It shows compliance with the requirement.



A D T

802.11a

CH 149

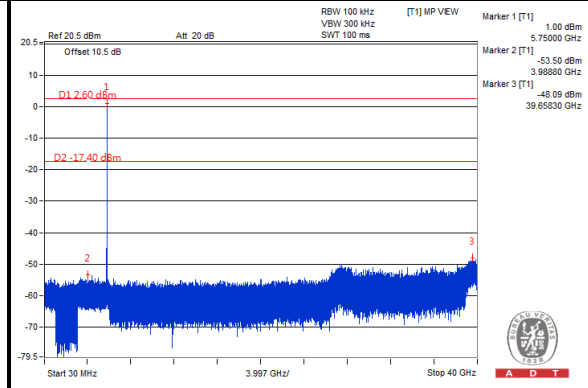
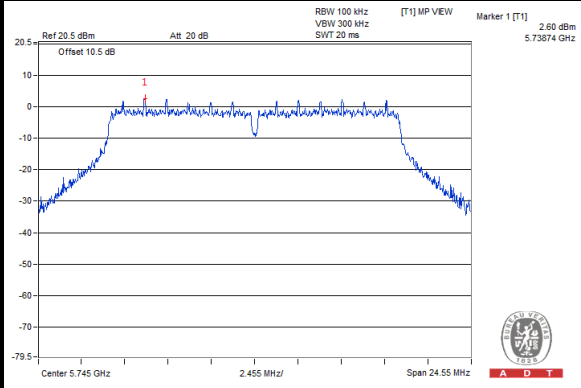

CH 157

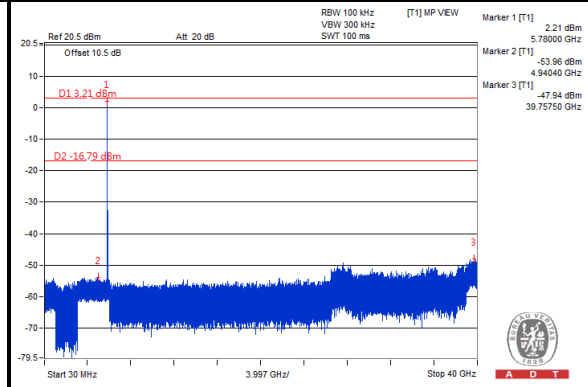
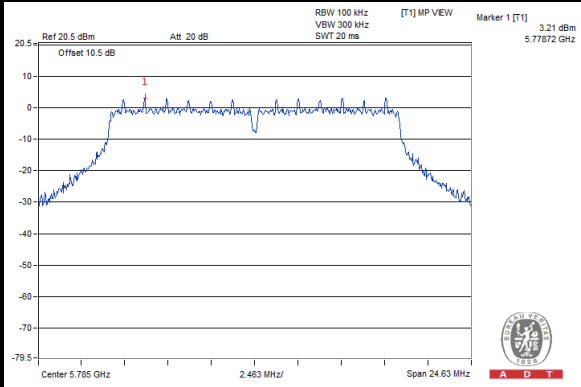

CH 165

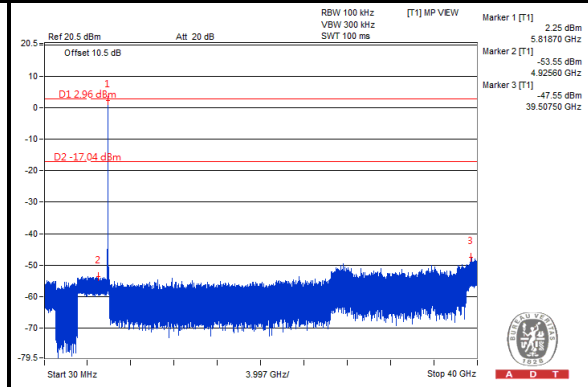
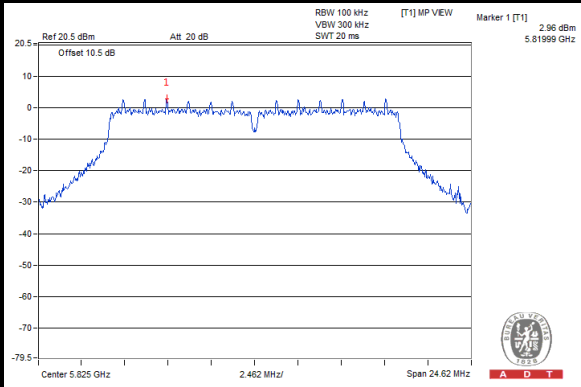



A D T

802.11n (20MHz)

CH 149

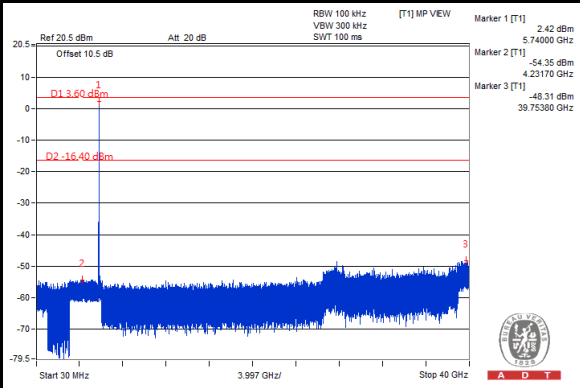
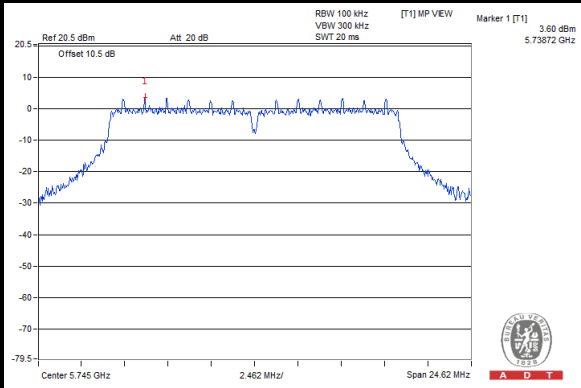

CH 157

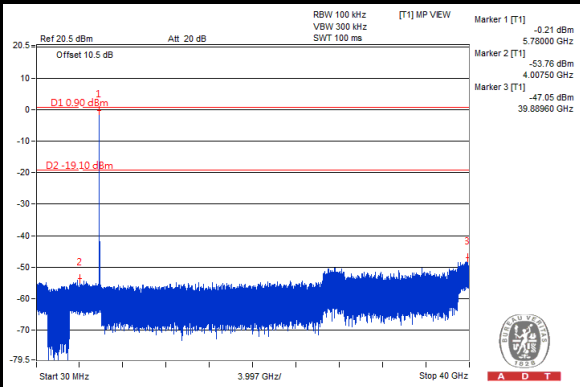
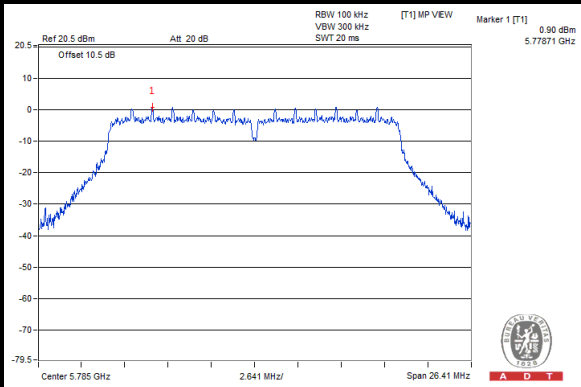

CH 165

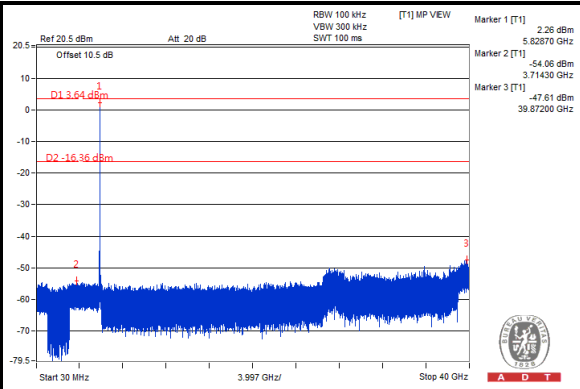
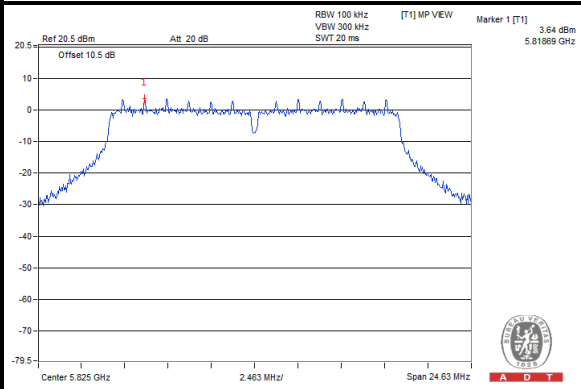



A D T

802.11n (40MHz)

CH 151

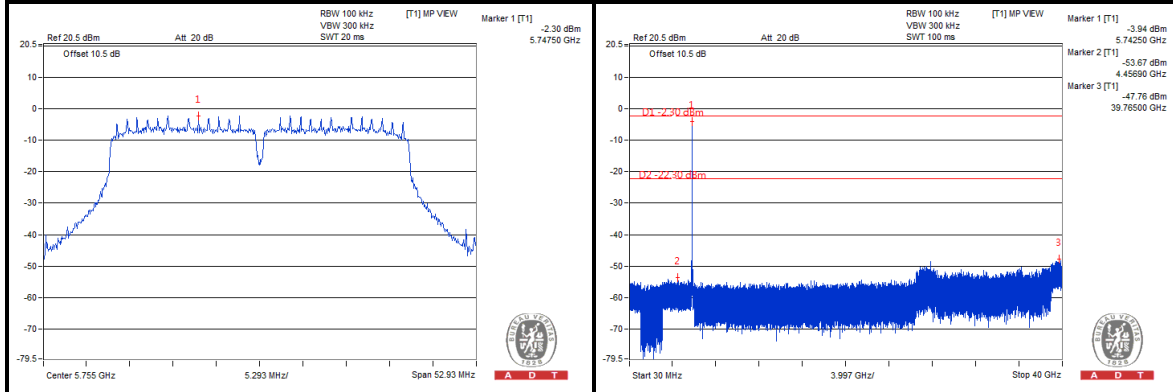

CH 159

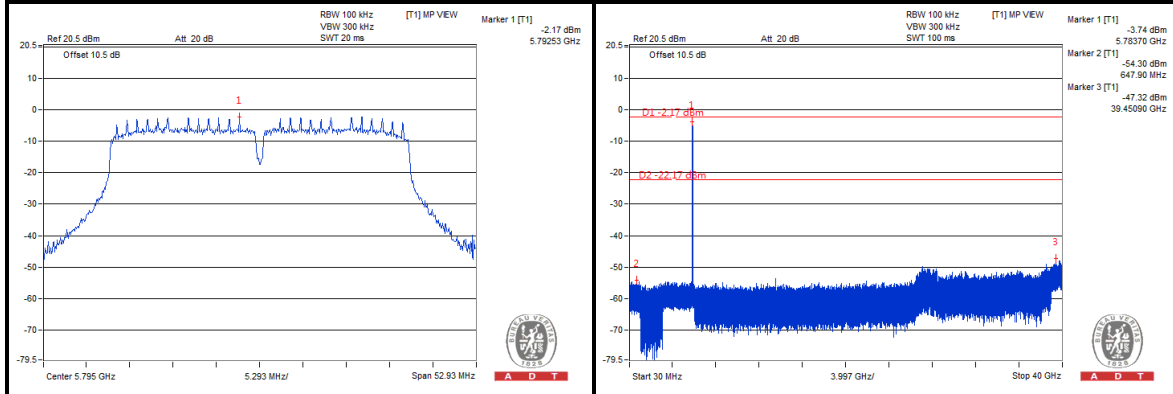

802.11ac (80MHz)

CH 155

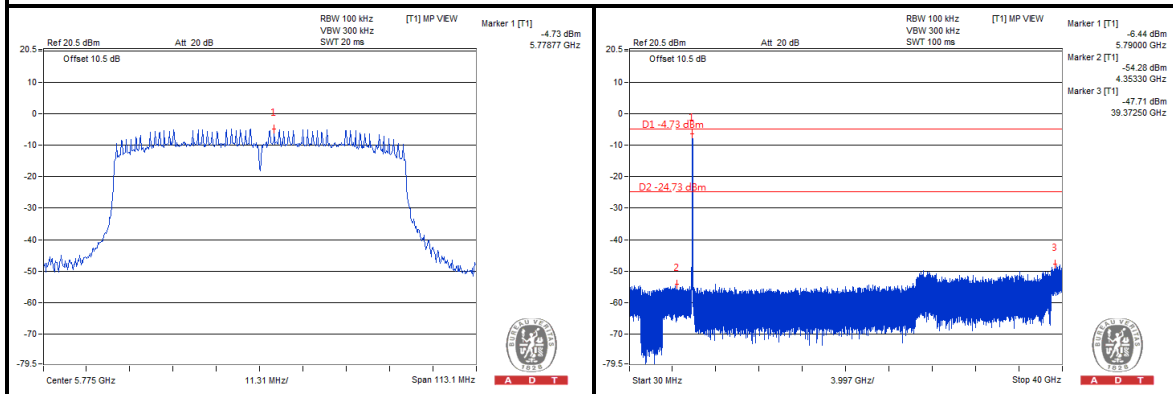



A D T

6. PHOTOGRAPHS OF THE TEST CONFIGURATION

Please refer to the attached file (Test Setup Photo).



7. INFORMATION ON THE TESTING LABORATORIES

We, Bureau Veritas Consumer Products Services (H.K.) Ltd., Taoyuan Branch, were founded in 1988 to provide our best service in EMC, Radio, Telecom and Safety consultation. Our laboratories are accredited and approved according to ISO/IEC 17025.

If you have any comments, please feel free to contact us at the following:

Linko EMC/RF Lab:

Tel: 886-2-26052180

Fax: 886-2-26051924

Hsin Chu EMC/RF Lab:

Tel: 886-3-5935343

Fax: 886-3-5935342

Hwa Ya EMC/RF/Safety Telecom Lab:

Tel: 886-3-3183232

Fax: 886-3-3270892

Email: service.adt@tw.bureauveritas.com

Web Site: www.bureauveritas-adt.com

The address and road map of all our labs can be found in our web site also.



A D T

8. APPENDIX A - MODIFICATIONS RECORDERS FOR ENGINEERING CHANGES TO THE EUT BY THE LAB

No any modifications are made to the EUT by the lab during the test.

---END---