



A D T

FCC HAC (RF Emission) Test Report

Report No. : SA131204C31-1
Applicant : HTC Corporation
Address : No. 23, Xinghua Rd., Taoyuan 330, Taiwan, R.O.C.
Product : Smartphone
FCC ID : NM80P6B160
Brand : HTC
Model No. : 0P6B160
Standards : FCC 47 CFR Part 20.19
ANSI C63.19-2011
Sample Received Date : Dec. 04, 2013
Date of Testing : Jan. 09, 2014
Summary M-Rating : M3

CERTIFICATION: The above equipment have been tested by **Bureau Veritas Consumer Products Services (H.K.) Ltd., Taoyuan Branch – Lin Kou Laboratories**, and found compliance with the requirement of the above standards. The test record, data evaluation & Equipment Under Test (EUT) configurations represented herein are true and accurate accounts of the measurements of the sample's HAC characteristics under the conditions specified in this report. It should not be reproduced except in full, without the written approval of our laboratory. The client should not use it to claim product certification, approval, or endorsement by TAF or any government agencies.

Prepared By : Ivonne Wu
Ivonne Wu / Supervisor

Approved By : Roy Wu
Roy Wu / Manager



This report is for your exclusive use. Any copying or replication of this report to or for any other person or entity, or use of our name or trademark, is permitted only with our prior written permission. This report sets forth our findings solely with respect to the test samples identified herein. The results set forth in this report are not indicative or representative of the quality or characteristics of the lot from which a test sample was taken or any similar or identical product unless specifically and expressly noted. Our report includes all of the tests requested by you and the results thereof based upon the information that you provided to us. You have 60 days from date of issuance of this report to notify us of any material error or omission caused by our negligence, provided, however, that such notice shall be in writing and shall specifically address the issue you wish to raise. A failure to raise such issue within the prescribed time shall constitute your unqualified acceptance of the completeness of this report, the tests conducted and the correctness of the report contents. Unless specific mention, the uncertainty of measurement has been explicitly taken into account to declare the compliance or non-compliance to the specification.



Table of Contents

Release Control Record	3
1. Summary of Maximum M-Rating	4
2. Description of Equipment Under Test	5
3. HAC RF Emission Measurement System	6
3.1 SPEAG DASY System	6
3.1.1 Robot.....	7
3.1.2 Probes.....	7
3.1.3 Data Acquisition Electronics (DAE)	7
3.1.4 Phantoms.....	7
3.1.5 Device Holder.....	8
3.1.6 RF Emission Calibration Dipoles.....	8
3.2 DASY System Verification.....	9
3.3 EUT Measurements Reference and Plane.....	10
3.4 HAC RF Emission Measurement Procedure.....	11
3.5 Modulation Interference Factor	13
4. HAC Measurement Evaluation.....	14
4.1 M-Rating Category	14
4.2 EUT Configuration and Setting.....	14
4.3 System Verification.....	14
4.4 Conducted Power Results.....	15
4.5 HAC RF Emission Testing Results.....	16
4.5.1 E-Field Emissions	16
5. Calibration of Test Equipment.....	17
6. Measurement Uncertainty.....	18
7. Information on the Testing Laboratories.....	19
Appendix A. Plots of System Verification	
Appendix B. Plots of HAC RF Emission Measurement	
Appendix C. Calibration Certificate for Probe and Dipole	
Appendix D. Photographs of EUT and Setup	



Release Control Record

Issue No.	Reason for Change	Date Issued
R01	Initial release	Jan. 21, 2014



1. Summary of Maximum M-Rating

Mode / Band	Maximum RF Audio Interference Level (dBV/m)	M-Rating
GSM850	33.89	M4
GSM1900	32.78	M3
WCDMA Band II	5.28	M4
WCDMA Band IV	5.15	M4
WCDMA Band V	5.83	M4
Summary		M3

Note:

1. The HAC RF emission limit (**M-rating Category M3**) is specified in FCC 47 CFR part 20.19 and ANSI C63.19.
2. The device RF emission rating is determined by the minimum rating.



FCC HAC (RF Emission) Test Report

2. Description of Equipment Under Test

EUT Type	Smartphone
FCC ID	NM80P6B160
Brand Name	HTC
Model Name	0P6B160
EUT Configurations	Sample 1: Phone + LCD1 + Battery1 Sample 2: Phone + LCD2 + Battery2
Tx Frequency Bands (Unit: MHz)	GSM850 : 824.2 ~ 848.8 GSM1900 : 1850.2 ~ 1909.8 WCDMA Band II : 1852.4 ~ 1907.6 WCDMA Band IV : 1712.4 ~ 1752.6 WCDMA Band V : 826.4 ~ 846.6
Uplink Modulations	GSM : GMSK WCDMA : QPSK
Maximum AVG Conducted Power (Unit: dBm)	GSM850 : 32.97 GSM1900 : 30.18 WCDMA Band II : 23.67 WCDMA Band IV : 23.59 WCDMA Band V : 23.24
Antenna Type	Fixed Internal Antenna
EUT Stage	Identical Prototype

Note:

- The above EUT information is declared by manufacturer and for more detailed features description please refers to the manufacturer's specifications or User's Manual.

Air Interface and Operational Mode								
Air Interface	Bands	Type Transport	HAC Tested	Simultaneous But Not Tested	Concurrent HAC Tested or Not Tested	Voice Over Digital Transport OTT Capability	WiFi Low Power	Additional GSM Power Reduction
GSM	850	VO	YES	WLAN or BT	Not Tested ¹	N/A	N/A	N/A
	1900							
	GPRS/EDGE	DT	N/A	WLAN or BT	N/A	YES		
WCDMA	II	VO	YES	WLAN or BT	Not Tested ¹	N/A	N/A	N/A
	IV							
	V							
	HSPA	DT	N/A	WLAN or BT	N/A	YES		
LTE	4	DT	N/A	WLAN or BT	N/A	YES	N/A	N/A
	7							
	17							
WLAN	2.4G	DT	N/A	WWAN	N/A	YES	N/A	N/A
	5G							
Bluetooth	2.4G	DT	N/A	WWAN	N/A	N/A	N/A	N/A
Type Transport VO = Voice only DT = Digital Data – Not Indented for CMRS Service VD = CMRS and Data transport				Note 1. Non-concurrent mode was found to be the Worst Case mode				

3. HAC RF Emission Measurement System

3.1 SPEAG DASY System

DASY system consists of high precision robot, probe alignment sensor, phantom, robot controller, controlled measurement server and near-field probe. The robot includes six axes that can move to the precision position of the DASY5 software defined. The DASY software can define the area that is detected by the probe. The robot is connected to controlled box. Controlled measurement server is connected to the controlled robot box. The DAE includes amplifier, signal multiplexing, AD converter, offset measurement and surface detection. It is connected to the Electro-optical coupler (ECO). The ECO performs the conversion from the optical into digital electric signal of the DAE and transfers data to the PC.

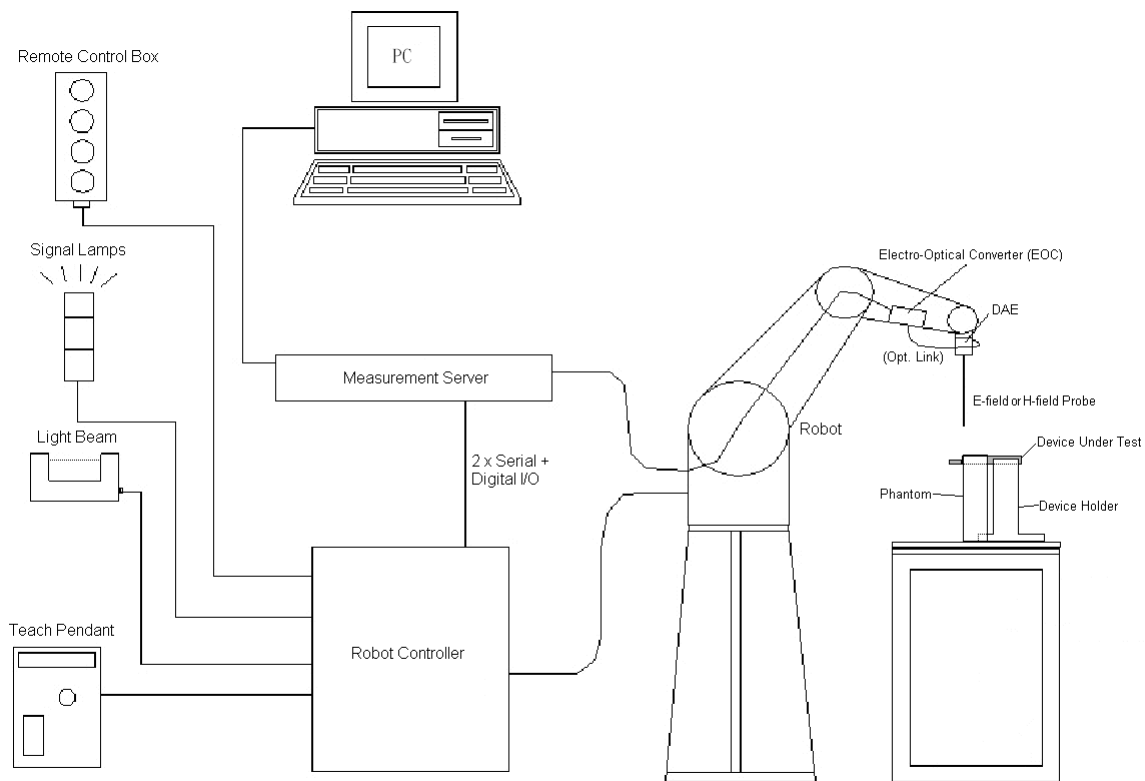

Fig-3.1 DASY System Setup

FCC HAC (RF Emission) Test Report

3.1.1 Robot

The DASY system uses the high precision robots from Stäubli SA (France). For the 6-axis controller system, the robot controller version (DASY5: CS8c) from Stäubli is used. The Stäubli robot series have many features that are important for our application:

- High precision (repeatability ± 0.035 mm)
- High reliability (industrial design)
- Jerk-free straight movements
- Low ELF interference (the closed metallic construction shields against motor control fields)



Fig-3.2 DASY5

3.1.2 Probes

Model	ER3DV6	
Construction	One dipole parallel, two dipoles normal to probe axis Built-in shielding against static charges	
Frequency	40 MHz to 6 GHz Linearity: ± 0.2 dB	
Directivity	± 0.2 dB in air (rotation around probe axis) ± 0.4 dB in air (rotation normal to probe axis)	
Dynamic Range	2 V/m to 1000 V/m Linearity: ± 0.2 dB	
Dimensions	Overall length: 337 mm (Tip: 16 mm) Tip diameter: 8 mm (Body: 12 mm) Distance from probe tip to dipole centers: 2.5 mm	

3.1.3 Data Acquisition Electronics (DAE)

Model	DAE3, DAE4	
Construction	Signal amplifier, multiplexer, A/D converter and control logic. Serial optical link for communication with DASY5 embedded system (fully remote controlled). Two step probe touch detector for mechanical surface detection and emergency robot stop.	
Measurement Range	-100 to +300 mV (16 bit resolution and two range settings: 4mV, 400mV)	
Input Offset Voltage	< 5 μ V (with auto zero)	
Input Bias Current	< 50 fA	
Dimensions	60 x 60 x 68 mm	

3.1.4 Phantoms

FCC HAC (RF Emission) Test Report

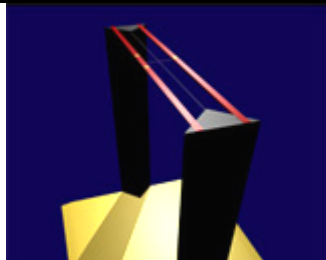
Model	Test Arch	
Construction	Enables easy and well defined positioning of the phone and validation dipoles as well as simple teaching of the robot.	
Dimensions	Length : 370 mm Width : 370 mm Height : 370 mm	

3.1.5 Device Holder

Model	Mounting Device	
Construction	The Mounting Device enables the rotation of the mounted transmitter device in spherical coordinates. Rotation point is the ear opening point. Transmitter devices can be easily and accurately positioned according to ANSI C63.19.	
Material	POM	

3.1.6 RF Emission Calibration Dipoles

Model	CD-Serial	
Construction	Free space antenna Hearing Aid susceptibility measurements according to ANSI C63.19. Validation of Hearing Aid RF setup for wireless device emission measurements according to ANSI C63.19	
Frequency	CD835V3 : 800 ~ 960 MHz CD1880V3 : 1710 ~ 2000 MHz CD2450 : 2250 ~ 2650 MHz	
Return Loss	CD835V3 : > 15 dB (835 MHz > 25 dB) CD1880V3 : > 18 dB (1880 MHz > 20 dB) CD2450V3 : > 18 dB (2450 MHz > 25 dB)	
Power Capability	> 40 W continuous	

FCC HAC (RF Emission) Test Report

3.2 DASYS System Verification

The system check verifies that the system operates within its specifications. It is performed before every E-field measurement. The system check uses normal measurements in the center section of the arch phantom with a matched dipole at a specified distance. The system verification setup is shown as below.

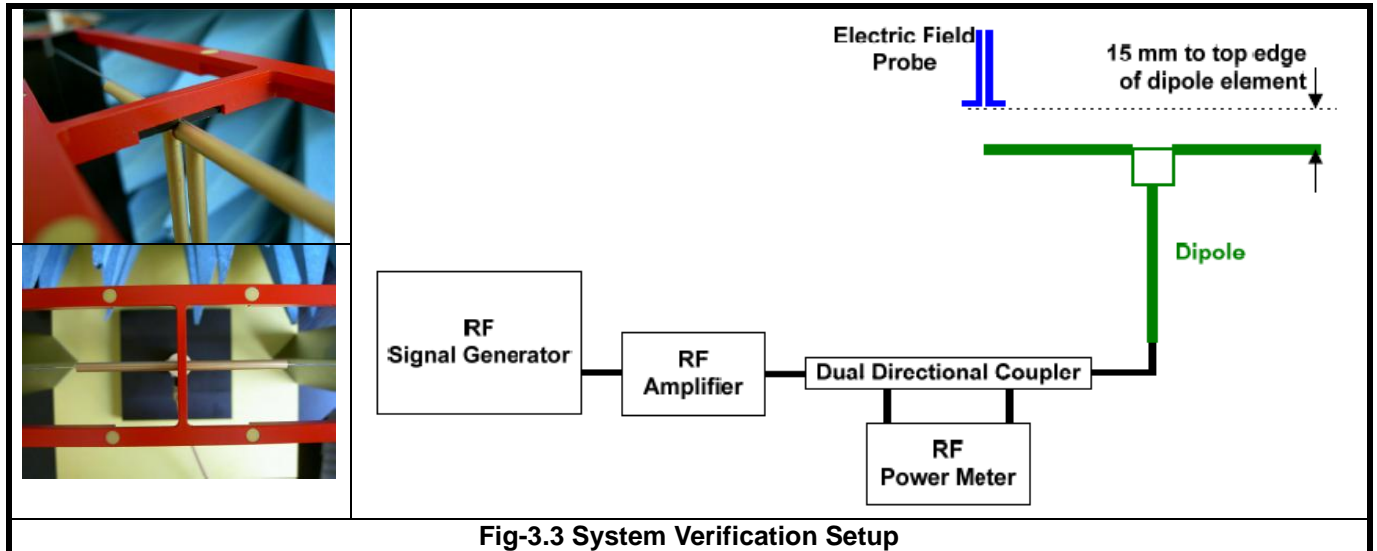

Fig-3.3 System Verification Setup

The validation dipole is placed beneath the center of arch phantom. The power meter measures the forward power at the location of the system check dipole connector. The signal generator is adjusted for the desired forward power, 100 mW (20 dBm) at the dipole connector and the RF power meter is read at that level. After connecting the cable to the dipole, the signal generator is readjusted for the same reading at RF power meter.

After system check testing, the E-field result will be compared with the reference value derived from validation dipole certificate report. The deviation of system check should be within 25 %.

The result of system verification is shown in section 4.3 of this report.

FCC HAC (RF Emission) Test Report

3.3 EUT Measurements Reference and Plane

The EUT is mounted in the device holder. The acoustic output of the EUT will coincide with the center point of the area formed by the dielectric wire and the middle bar of the arch's top frame. Then EUT will be moved vertically upwards until it touches the frame.

Fig-3.4 and Fig-3.5 illustrate the references and reference plane that is used in the RF emissions measurement.

- (a) The grid is 50 mm by 50 mm area that is divided into nine evenly sized blocks or sub-grids.
- (b) The grid is centered on the audio frequency output transducer of the EUT.
- (c) The grid is in a reference plane, which is defined as the planar area that contains the highest point in the area of the phone that normally rests against the user's ear. It is parallel to the centerline of the receiver area of the phone and is defined by the points of the receiver-end of the EUT handset, which in normal handset use rest against the ear.
- (d) The measurement plane is parallel to and 15 mm in front of the reference plane.



Fig-3.4 EUT Reference and Plane

FCC HAC (RF Emission) Test Report

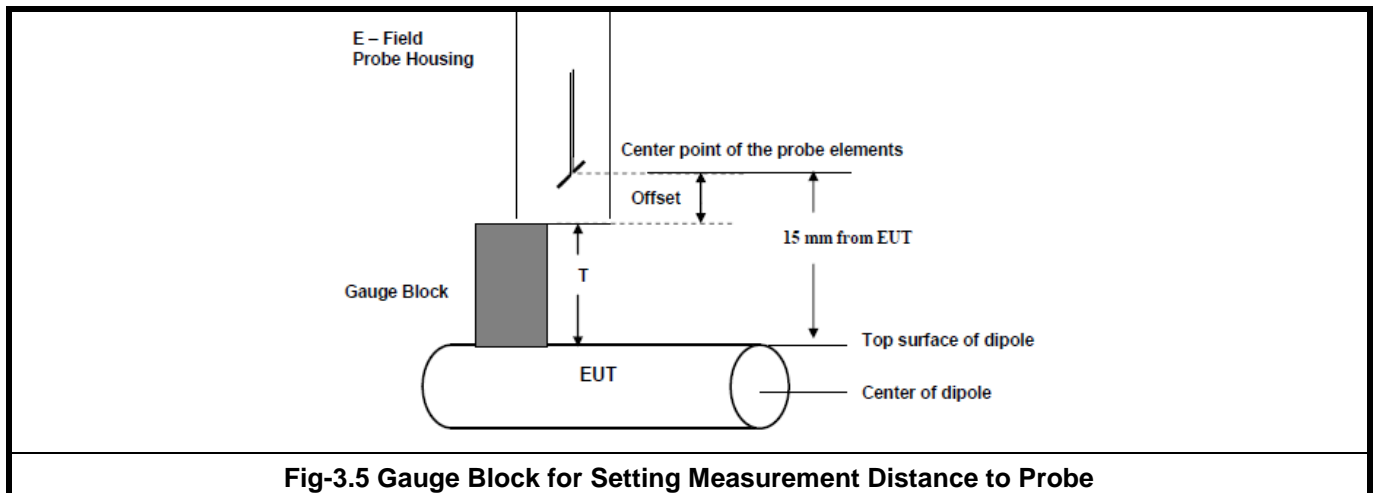

Fig-3.5 Gauge Block for Setting Measurement Distance to Probe

3.4 HAC RF Emission Measurement Procedure

The RF emissions test procedure for wireless communications device is as below.

1. Confirm the proper operation of the field probe, probe measurement system, and other instrumentation and the positioning system.
2. Position the WD in its intended test position.
3. Set the WD to transmit a fixed and repeatable combination of signal power and modulation characteristic that is representative of the worst case (highest interference potential) encountered in normal use. Transiently occurring start-up, changeover, or termination conditions, or other operations likely to occur less than 1% of the time during normal operation, may be excluded from consideration.
4. The center sub-grid shall be centered on the T-Coil mode perpendicular measurement point or the acoustic output, as appropriate. Locate the field probe at the initial test position in the 50 mm by 50 mm grid, which is contained in the measurement plane, illustrated in Fig-3.4. If the field alignment method is used, align the probe for maximum field reception.
5. Record the reading at the output of the measurement system.
6. Scan the entire 50 mm by 50 mm region in equally spaced increments and record the reading at each measurement point. The distance between measurement points shall be sufficient to assure the identification of the maximum reading.
7. Identify the five contiguous sub-grids around the center sub-grid whose maximum reading is the lowest of all available choices. This eliminates the three sub-grids with the maximum readings. Thus, the six areas to be used to determine the WD's highest emissions are identified.
8. Identify the maximum reading within the non-excluded sub-grids identified in step 7.
9. Indirect Measurement Method: The RF audio interference level in dB(V/m) is obtained by adding the MIF (in dB) to the maximum steady-state rms field-strength reading, in dB(V/m), from step 8. Use this result to determine the category rating.

FCC HAC (RF Emission) Test Report

10. Compare this RF audio interference level with the categories in section 4.1 and record the resulting WD category rating.
- 11 For the T-Coil mode M-rating assessment, determine whether the chosen perpendicular measurement point is contained in an included sub-grid of the first can. If so, then a second scan is not necessary. The first scan and resultant category rating may be used for the T-Coil mode M-rating. Otherwise, repeat step 1 through step 9, with the grid shifted so that it is centered on the perpendicular measurement point. Record the WD category rating.

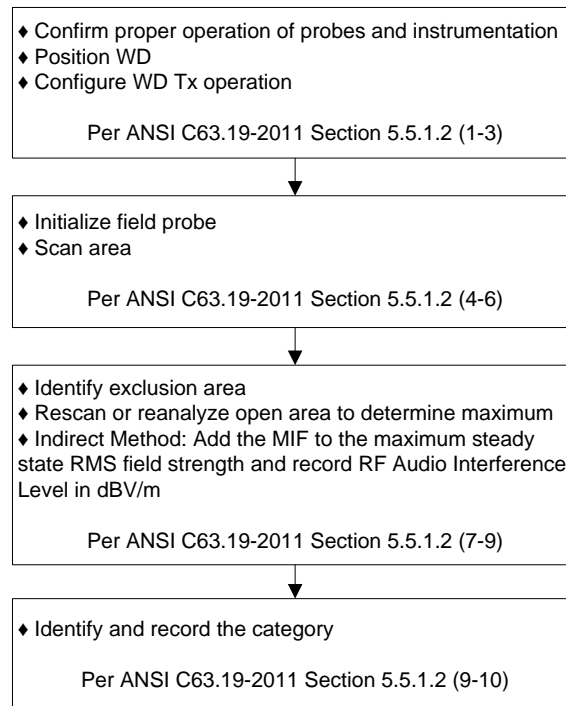

Fig-3.6 WD Near-Field Emission Test Flowchart

FCC HAC (RF Emission) Test Report

3.5 Modulation Interference Factor

The HAC Standard ANSI C63.19-2011 defines a new scaling using the Modulation Interference Factor (MIF) which replaces the need for the Articulation Weighting Factor (AWF) during the evaluation and is applicable to any modulation scheme.

The Modulation Interference Factor (MIF, in dB) is added to the measured average E-field (in dBV/m) and converts it to the RF audio interference potential (in dBV/m). This level considers the audible amplitude modulation components in the RF E-field. CW fields without amplitude modulation are assumed to not interfere with the hearing aid electronics. Modulations without time slots and low fluctuations at low frequencies have low MIF values, TDMA modulations with narrow transmission slots and repetition rates of few 100 Hz have high MIF values and give similar classification as ANSI C63.19-2007.

ER3D E-field probe have a bandwidth <10 kHz and can therefore not evaluate the RF envelope in the full audio band. DASY52 is therefore using the "indirect" measurement method according to ANSI C63.19-2011 which is the primary method. This near field probe read the averaged E-field. Especially for the new high peak-to-average (PAR) signal types, the probes shall be linearized by PMR calibration in order to not overestimate the field reading.

The evaluation method for the MIF is defined in ANSI C63.19-2011 section D.7. An RMS demodulated RF signal is fed to a spectral filter (similar to an A weighting filter) and forwarded to a temporal filter acting as a quasi-peak detector. The averaged output of these filtering is scaled to a 1 kHz 80% AM signal as reference. It may alternatively be determined through analysis and simulation, because it is constant and characteristic for a communication signal. DASY52 uses well-defined signals for PMR calibration. The MIF of these signals has been determined numerically. It allows a precise scaling and is therefore automatically applied.

The following table lists the MIF values evaluated by DASY manufacturer (SPEAG), and the test result will be calculated with the MIF parameter automatically. The detailed parameters for E-field probe can be found in the probe calibration report in appendix C.

SPEAG UID	UID Version	Communication System	MIF (dB)
10021	DAA (13.05.2013)	GSM-FDD (TDMA, GMSK)	3.63
10011	CAA (28.02.2013)	UMTS-FDD (WCDMA)	-27.23

The MIF measurement uncertainty listed in following table is estimated by SPEAG.

MIF (dB)	MIF Measurement Uncertainty (dB)
-7 to +5	0.2
-13 to +11	0.5
> -20	1.0

FCC HAC (RF Emission) Test Report

4. HAC Measurement Evaluation

4.1 M-Rating Category

The HAC Standard ANSI C63.19-2011 represents performance requirements for acceptable interoperability of hearing aids with wireless communications devices. When these parameters are met, a hearing aid operates acceptably in close proximity to a wireless communications device.

Emission Categories	E-Field Emissions < 960 MHz (dB V/m)	E-Field Emissions > 960 MHz (dB V/m)
Category M1	50 - 55	40 - 45
Category M2	45 - 50	35 - 40
Category M3	40 - 45	30 - 35
Category M4	< 40	< 30

4.2 EUT Configuration and Setting

For HAC RF emission testing, the EUT was linked and controlled by base station emulator. Communication between the EUT and the emulator was established by air link. The distance between the EUT and the communicating antenna of the emulator is larger than 50 cm and the output power radiated from the emulator antenna is at least 30 dB smaller than the output power of EUT. The EUT was set from the emulator to radiate maximum output power during HAC testing.

4.3 System Verification

The measuring results for system check are shown as below.

Frequency (MHz)	Input Power (dBm)	Target Value (V/m)	E-Field 1 (V/m)	E-Field 2 (V/m)	Average E-Field (V/m)	Deviation (%)	Test Date
835	20	108	110.2	111.6	110.9	2.69	Jan. 09, 2014
1880	20	91.4	91.85	92.11	91.98	0.63	Jan. 09, 2014

Note:

1. Comparing to the reference target value provided by SPEAG, the validation data should be within its specification of 25 %. The result indicates the system check can meet the variation criterion and the plots can be referred to Appendix A of this report.
2. For E-Field, the deviation is $[(E\text{-Field } 1 + E\text{-Field } 2) / 2 - \text{Target Value}] / \text{Target Value} \times 100\%$



FCC HAC (RF Emission) Test Report

4.4 Conducted Power Results

The measuring conducted average power (Unit: dBm) are shown as below.

Band	GSM850			GSM1900		
Channel	128	189	251	512	661	810
Frequency (MHz)	824.2	836.4	848.8	1850.2	1880.0	1909.8
GSM (GMSK, 1 Uplink)	32.97	32.88	32.71	30.07	30.18	30.00

Band	WCDMA Band II			WCDMA Band V		
Channel	9262	9400	9538	4132	4182	4233
Frequency (MHz)	1852.4	1880.0	1907.6	826.4	836.4	846.6
RMC 12.2K	23.67	23.59	23.62	23.21	23.24	23.22

Band	WCDMA Band IV		
Channel	1312	1413	1513
Frequency (MHz)	1712.4	1732.6	1752.6
RMC 12.2K	23.43	23.59	23.55

FCC HAC (RF Emission) Test Report

4.5 HAC RF Emission Testing Results

4.5.1 E-Field Emissions

Plot No.	Band	Mode	Ch.	EUT Config.	Tx Antenna	MIF (dB)	Peak RF Audio Interference (dBV/m)	M-Rating	Margin to Next Lower Rated Category (dB)
	GSM850	GSM	189	1	0	3.63	32.39	M4	11.24
	GSM850	GSM	189	1	1	3.63	33.16	M4	10.47
01	GSM850	GSM	128	1	1	3.63	33.89	M4	9.74
	GSM850	GSM	251	1	1	3.63	33.78	M4	9.85
	GSM850	GSM	128	2	1	3.63	32.70	M4	10.93
	GSM1900	GSM	661	1	0	3.63	29.65	M4	3.98
	GSM1900	GSM	661	1	1	3.63	32.46	M3	1.17
02	GSM1900	GSM	512	1	1	3.63	32.78	M3	0.85
	GSM1900	GSM	810	1	1	3.63	31.97	M3	1.66
	GSM1900	GSM	512	2	1	3.63	29.18	M4	4.45
	WCDMA II	RMC12.2K	9400	1	0	-27.23	1.78	M4	0.99
	WCDMA II	RMC12.2K	9400	1	1	-27.23	4.86	M4	-2.09
03	WCDMA II	RMC12.2K	9262	1	1	-27.23	5.28	M4	-2.51
	WCDMA II	RMC12.2K	9538	1	1	-27.23	4.32	M4	-1.55
	WCDMA II	RMC12.2K	9262	2	1	-27.23	0.96	M4	1.81
	WCDMA IV	RMC12.2K	1413	1	0	-27.23	3.07	M4	-0.30
04	WCDMA IV	RMC12.2K	1413	1	1	-27.23	5.15	M4	-2.38
	WCDMA IV	RMC12.2K	1312	1	1	-27.23	4.96	M4	-2.19
	WCDMA IV	RMC12.2K	1513	1	1	-27.23	4.91	M4	-2.14
	WCDMA IV	RMC12.2K	1413	2	1	-27.23	3.20	M4	-0.43
	WCDMA V	RMC12.2K	4182	1	0	-27.23	1.14	M4	11.63
	WCDMA V	RMC12.2K	4182	1	1	-27.23	4.69	M4	8.08
05	WCDMA V	RMC12.2K	4132	1	1	-27.23	5.83	M4	6.94
	WCDMA V	RMC12.2K	4233	1	1	-27.23	3.77	M4	9.00
	WCDMA V	RMC12.2K	4132	2	1	-27.23	0.45	M4	12.32

Note:

- Margin to Next Lower Rated Category, defined as: The e-field transition value for the next lower rated category of the established HAC category minus the maximum steady-state RMS field strength (before adding the MIF).

Test Engineer : Sam Onn



5. Calibration of Test Equipment

Equipment	Manufacturer	Model	SN	Cal. Date	Cal. Interval
835MHz Calibration Dipole	SPEAG	CD835V3	1041	Mar. 15, 2013	Annual
1880MHz Calibration Dipole	SPEAG	CD1880V3	1032	Apr. 23, 2013	Annual
Isotropic E-Field Probe	SPEAG	ER3DV6	2445	Feb. 18, 2013	Annual
Data Acquisition Electronics	SPEAG	DAE3	510	Sep. 25, 2013	Annual
Test Arch Phantom	SPEAG	Arch	N/A	N/A	N/A
Universal Radio Communication Tester	R&S	CMU200	104484	Jan. 24, 2013	Annual
MXG Analog Signal Generator	Agilent	N5181A	MY50143868	Jun. 06, 2013	Annual
Power Meter	Anritsu	ML2495A	1218009	Jun. 11, 2013	Annual
Power Sensor	Anritsu	MA2411B	1207252	Jun. 11, 2013	Annual
EXA Spectrum Analyzer	Agilent	N9010A	MY52100136	Jun. 26, 2013	Annual
Directional Coupler	Woken	0110A056020-10	11122702	Apr. 18, 2013	Annual
Power Amplifier	AR	5S1G4	0339656	Apr. 18, 2013	Annual
Attenuator	Woken	00800A1G01L-03	N/A	Apr. 18, 2013	Annual



6. Measurement Uncertainty

Error Description	Uncertainty Value (±%)	Probability Distribution	Divisor	Ci (E)	Ci (H)	Standard Uncertainty (E)
Measurement System						
Probe Calibration	5.1	Normal	1	1	1	± 5.1 %
Axial Isotropy	4.7	Rectangular	√3	1	1	± 2.7 %
Sensor Displacement	16.5	Rectangular	√3	1	0.145	± 9.5 %
Boundary Effects	2.4	Rectangular	√3	1	1	± 1.4 %
Phantom Boundary Effect	7.2	Rectangular	√3	1	0	± 4.1 %
Linearity	4.7	Rectangular	√3	1	1	± 2.7 %
Scaling with PMR Calibration	10.0	Rectangular	√3	1	1	± 5.8 %
System Detection Limit	1.0	Rectangular	√3	1	1	± 0.6 %
Readout Electronics	0.3	Normal	1	1	1	± 0.3 %
Response Time	0.8	Rectangular	√3	1	1	± 0.5 %
Integration Time	2.6	Rectangular	√3	1	1	± 1.5 %
RF Ambient Conditions	3.0	Rectangular	√3	1	1	± 1.7 %
RF Reflections	12.0	Rectangular	√3	1	1	± 6.9 %
Probe Positioner	1.2	Rectangular	√3	1	0.67	± 0.7 %
Probe Positioning	4.7	Rectangular	√3	1	0.67	± 2.7 %
Extrap. and Interpolation	1.0	Rectangular	√3	1	1	± 0.6 %
Test Sample Related						
Device Positioning Vertical	4.7	Rectangular	√3	1	0.67	± 2.7 %
Device Positioning Lateral	1.0	Rectangular	√3	1	1	± 0.6 %
Device Holder and Phantom	2.4	Rectangular	√3	1	1	± 1.4 %
Power Drift	5.0	Rectangular	√3	1	1	± 2.9 %
Phantom and Setup Related						
Phantom Thickness	2.4	Rectangular	√3	1	0.67	± 1.4 %
Combined Standard Uncertainty						± 16.3 %
Coverage Factor for 95 %						K = 2
Expanded Uncertainty						± 32.6 %

Uncertainty budget for HAC RF Emission



FCC HAC (RF Emission) Test Report

7. Information on the Testing Laboratories

We, Bureau Veritas Consumer Products Services (H.K.) Ltd., Taoyuan Branch, were founded in 1988 to provide our best service in EMC, Radio, Telecom and Safety consultation. Our laboratories are accredited and approved according to ISO/IEC 17025.

If you have any comments, please feel free to contact us at the following:

Taiwan HwaYa EMC/RF/Safety/Telecom Lab:

Add: No. 19, Hwa Ya 2nd Rd, Wen Hwa Vil., Kwei Shan Hsiang, Taoyuan Hsien 333, Taiwan, R.O.C.

Tel: 886-3-318-3232

Fax: 886-3-327-0892

Taiwan LinKo EMC/RF Lab:

Add: No. 47, 14th Ling, Chia Pau Vil., Linkou Dist., New Taipei City 244, Taiwan, R.O.C.

Tel: 886-2-2605-2180

Fax: 886-2-2605-1924

Taiwan HsinChu EMC/RF Lab:

Add: No. 81-1, Lu Liao Keng, 9th Ling, Wu Lung Vil., Chiung Lin Township, Hsinchu County 307, Taiwan, R.O.C.

Tel: 886-3-593-5343

Fax: 886-3-593-5342

Email: service.adt@tw.bureauveritas.com

Web Site: www.adt.com.tw

The road map of all our labs can be found in our web site also.

---END---



Appendix A. Plots of System Verification

The plots for system verification are shown as follows.

System Check_E-Field_835_140109

DUT: HAC Dipole 835 MHz; Type: CD835V3; SN: 1041

Communication System: CW; Frequency: 835 MHz; Duty Cycle: 1:1

Medium: Air Medium parameters used: $\sigma = 0 \text{ S/m}$, $\epsilon_r = 1$; $\rho = 1000 \text{ kg/m}^3$

Ambient Temperature : 21.2 °C

DASY5 Configuration:

- Probe: ER3DV6 - SN2445; ConvF(1, 1, 1); Calibrated: 2013/02/18;
- Sensor-Surface: (Fix Surface)
- Electronics: DAE3 Sn510; Calibrated: 2013/09/25
- Phantom: HAC Test Arch with AMCC; Type: SD HAC P01 BA;
- Measurement SW: DASY52, Version 52.8 (7); SEMCAD X Version 14.6.10 (7164)

- Hearing Aid Compatibility (41x361x1): Interpolated grid: dx=0.5000 mm, dy=0.5000 mm

Device Reference Point: 0, 0, -6.3 mm

Reference Value = 130.0 V/m; Power Drift = -0.09 dB

PMR not calibrated. PMF = 1.000 is applied.

E-field emissions = 111.6 V/m

Grid 1 M4 109.1 V/m	Grid 2 M4 110.2 V/m	Grid 3 M4 106.4 V/m
Grid 4 M4 65.11 V/m	Grid 5 M4 65.78 V/m	Grid 6 M4 64.33 V/m
Grid 7 M4 110.8 V/m	Grid 8 M4 111.6 V/m	Grid 9 M4 107.7 V/m

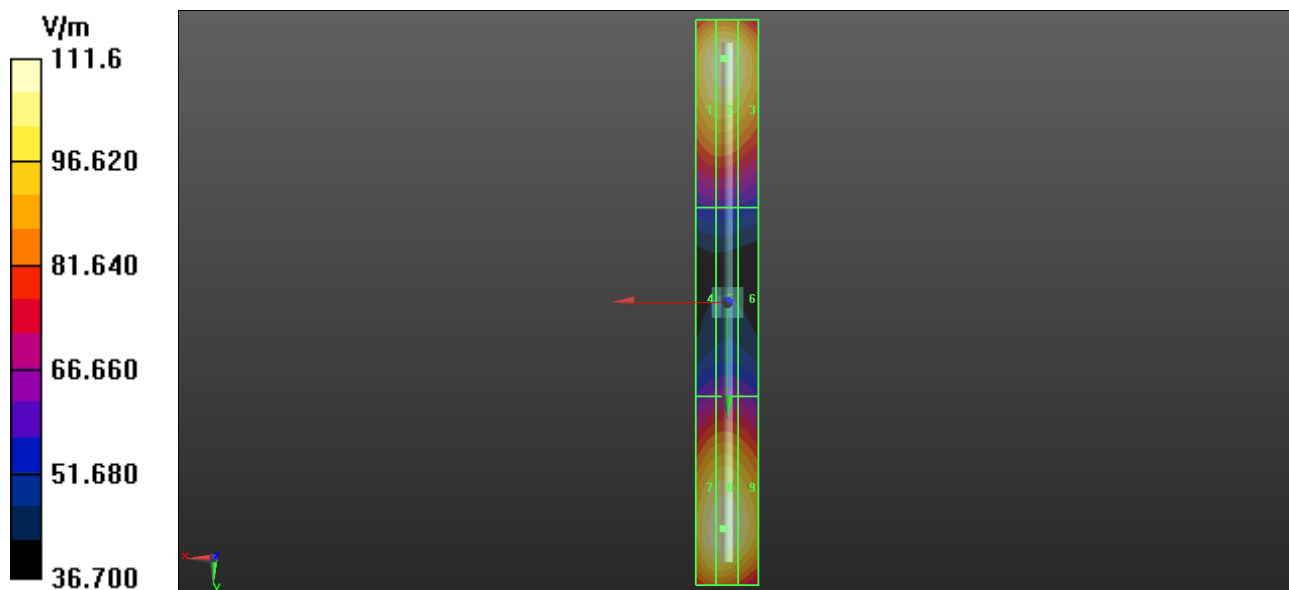

System Check_E-Field_1880_140109

DUT: HAC Dipole 1880 MHz; Type: CD1880V3; SN: 1032

Communication System: CW; Frequency: 1880 MHz; Duty Cycle: 1:1

Medium: Air Medium parameters used: $\sigma = 0 \text{ S/m}$, $\epsilon_r = 1$; $\rho = 1000 \text{ kg/m}^3$

Ambient Temperature : 21.2 °C

DASY5 Configuration:

- Probe: ER3DV6 - SN2445; ConvF(1, 1, 1); Calibrated: 2013/02/18;
- Sensor-Surface: (Fix Surface)
- Electronics: DAE3 Sn510; Calibrated: 2013/09/25
- Phantom: HAC Test Arch with AMCC; Type: SD HAC P01 BA;
- Measurement SW: DASY52, Version 52.8 (7); SEMCAD X Version 14.6.10 (7164)

- Hearing Aid Compatibility (41x181x1): Interpolated grid: dx=0.5000 mm, dy=0.5000 mm

Device Reference Point: 0, 0, -6.3 mm

Reference Value = 145.3 V/m; Power Drift = -0.02 dB

PMR not calibrated. PMF = 1.000 is applied.

E-field emissions = 92.11 V/m

Grid 1 M3 91.11 V/m	Grid 2 M3 91.85 V/m	Grid 3 M3 88.27 V/m
Grid 4 M3 70.07 V/m	Grid 5 M3 70.90 V/m	Grid 6 M3 69.67 V/m
Grid 7 M3 91.68 V/m	Grid 8 M3 92.11 V/m	Grid 9 M3 88.76 V/m

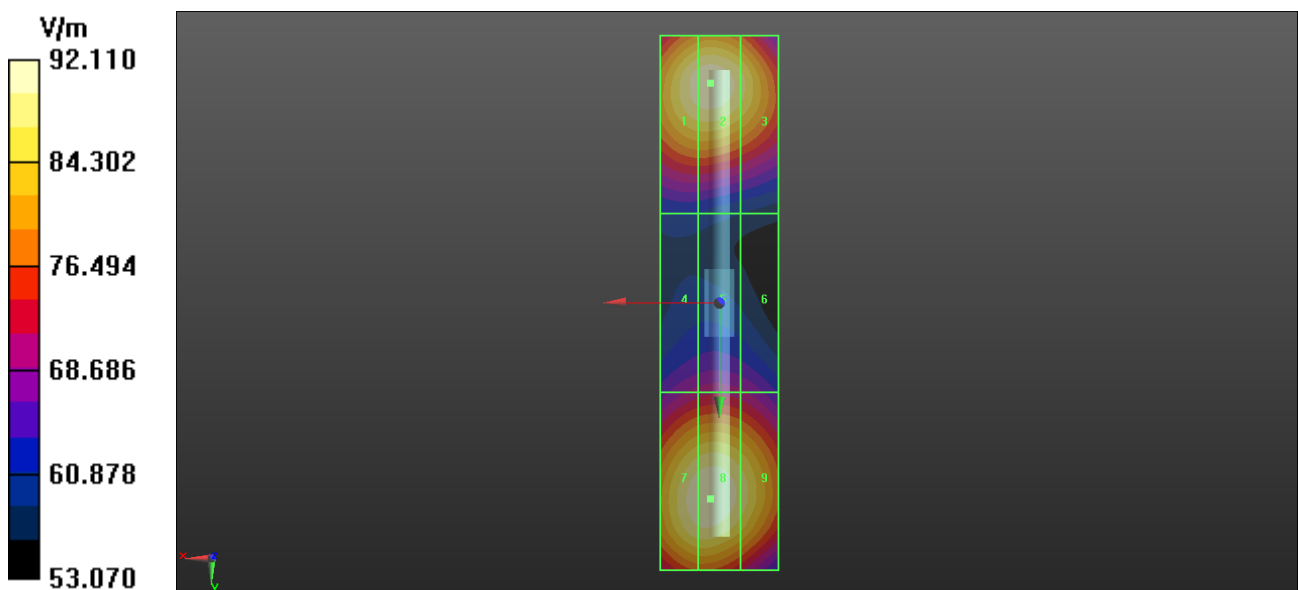



Appendix B. Plots of HAC RF Emission Measurement

The plots for HAC measurement are shown as follows.

P01 GSM850_GSM_Ch128_Sample 1_Ant 1

DUT: 131204C32

Communication System: GSM-FDD (TDMA, GMSK); Frequency: 824.2 MHz; Duty Cycle: 1:8.69

Medium: Air Medium parameters used: $\sigma = 0 \text{ S/m}$, $\epsilon_r = 1$; $\rho = 1000 \text{ kg/m}^3$

Ambient Temperature : 21.2 °C

DASY5 Configuration:

- Probe: ER3DV6 - SN2445; ConvF(1, 1, 1); Calibrated: 2013/02/18;
- Sensor-Surface: (Fix Surface)
- Electronics: DAE3 Sn510; Calibrated: 2013/09/25
- Phantom: HAC Test Arch with AMCC; Type: SD HAC P01 BA;
- Measurement SW: DASY52, Version 52.8 (7); SEMCAD X Version 14.6.10 (7164)

- Hearing Aid Compatibility (101x101x1): Interpolated grid: dx=0.5000 mm, dy=0.5000 mm

Device Reference Point: 0, 0, -6.3 mm

Reference Value = 37.08 V/m; Power Drift = -0.03 dB

Applied MIF = 3.63 dB

RF audio interference level = 33.89 dBV/m

Emission category: M4

Grid 1 M4 33.01 dBV/m	Grid 2 M4 34.15 dBV/m	Grid 3 M4 34.12 dBV/m
Grid 4 M4 32.06 dBV/m	Grid 5 M4 33.89 dBV/m	Grid 6 M4 33.9 dBV/m
Grid 7 M4 31.06 dBV/m	Grid 8 M4 33.27 dBV/m	Grid 9 M4 33.34 dBV/m

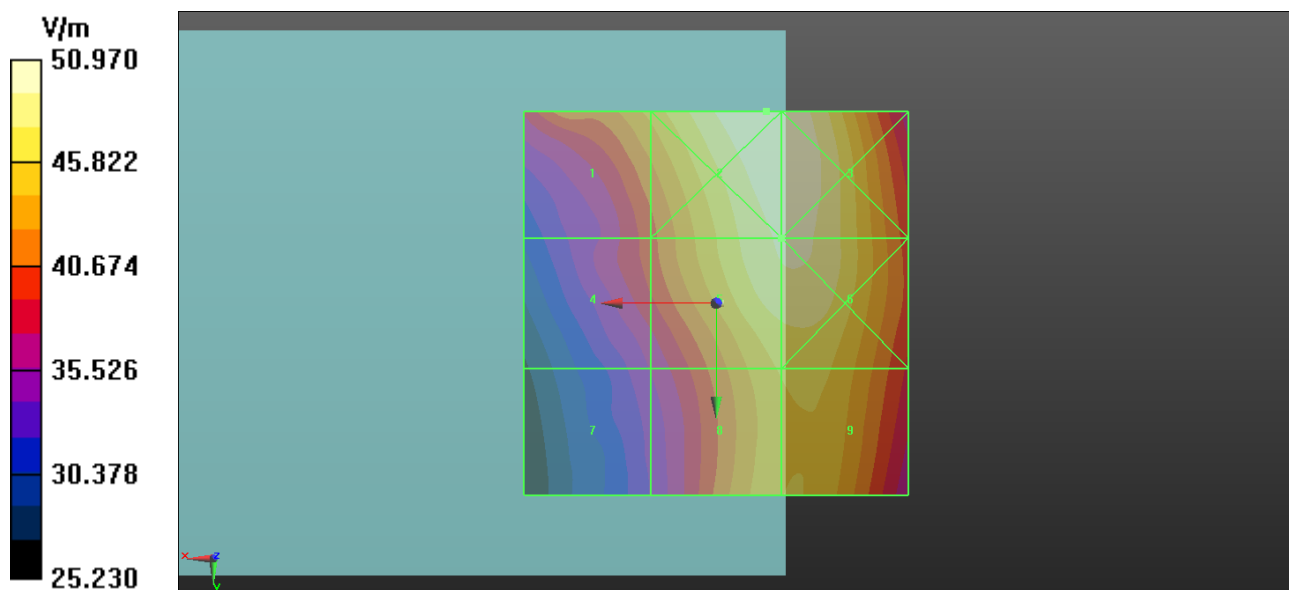

P02 GSM1900_GSM_Ch512_Sample 1_Ant 1

DUT: 131204C32

Communication System: GSM-FDD (TDMA, GMSK); Frequency: 1850.2 MHz; Duty Cycle: 1:8.69

Medium: Air Medium parameters used: $\sigma = 0 \text{ S/m}$, $\epsilon_r = 1$; $\rho = 1000 \text{ kg/m}^3$

Ambient Temperature : 21.2 °C

DASY5 Configuration:

- Probe: ER3DV6 - SN2445; ConvF(1, 1, 1); Calibrated: 2013/02/18;
- Sensor-Surface: (Fix Surface)
- Electronics: DAE3 Sn510; Calibrated: 2013/09/25
- Phantom: HAC Test Arch with AMCC; Type: SD HAC P01 BA;
- Measurement SW: DASY52, Version 52.8 (7); SEMCAD X Version 14.6.10 (7164)

- Hearing Aid Compatibility (101x101x1): Interpolated grid: dx=0.5000 mm, dy=0.5000 mm

Device Reference Point: 0, 0, -6.3 mm

Reference Value = 29.95 V/m; Power Drift = -0.03 dB

Applied MIF = 3.63 dB

RF audio interference level = 32.78 dBV/m

Emission category: M3

Grid 1 M3 34.57 dBV/m	Grid 2 M2 36.27 dBV/m	Grid 3 M2 35.08 dBV/m
Grid 4 M3 31.12 dBV/m	Grid 5 M3 32.78 dBV/m	Grid 6 M3 32.26 dBV/m
Grid 7 M4 25.83 dBV/m	Grid 8 M4 28.65 dBV/m	Grid 9 M4 28.75 dBV/m

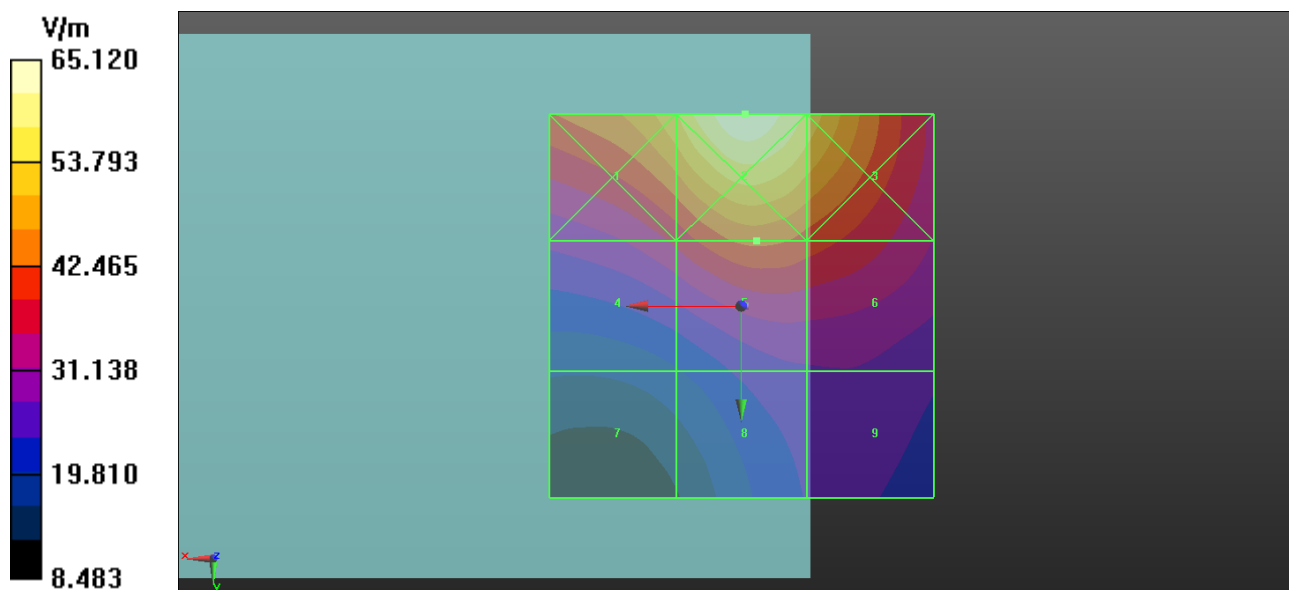

P03 WCDMA II_RMC12.2k_Ch9262_Sample 1_Ant 1

DUT: 131204C32

Communication System: UMTS-FDD (WCDMA); Frequency: 1852.4 MHz; Duty Cycle: 1:1.95

Medium: Air Medium parameters used: $\sigma = 0 \text{ S/m}$, $\epsilon_r = 1$; $\rho = 1000 \text{ kg/m}^3$

Ambient Temperature : 21.2 °C

DASY5 Configuration:

- Probe: ER3DV6 - SN2445; ConvF(1, 1, 1); Calibrated: 2013/02/18;
- Sensor-Surface: (Fix Surface)
- Electronics: DAE3 Sn510; Calibrated: 2013/09/25
- Phantom: HAC Test Arch with AMCC; Type: SD HAC P01 BA;
- Measurement SW: DASY52, Version 52.8 (7); SEMCAD X Version 14.6.10 (7164)

- Hearing Aid Compatibility (101x101x1): Interpolated grid: dx=0.5000 mm, dy=0.5000 mm

Device Reference Point: 0, 0, -6.3 mm

Reference Value = 45.17 V/m; Power Drift = -0.06 dB

Applied MIF = -27.23 dB

RF audio interference level = 5.28 dBV/m

Emission category: M4

Grid 1 M4 7.32 dBV/m	Grid 2 M4 8.8 dBV/m	Grid 3 M4 7.65 dBV/m
Grid 4 M4 3.8 dBV/m	Grid 5 M4 5.28 dBV/m	Grid 6 M4 4.76 dBV/m
Grid 7 M4 -1.41 dBV/m	Grid 8 M4 1.2 dBV/m	Grid 9 M4 1.29 dBV/m

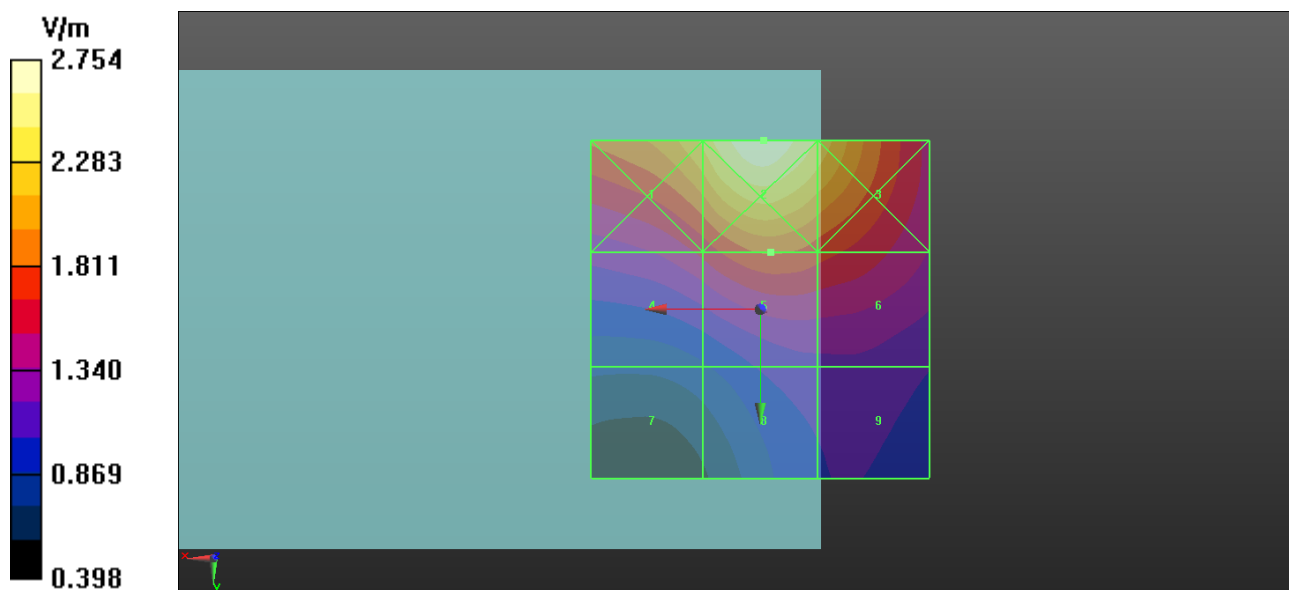

P04 WCDMA IV_RMC12.2k_Ch1413_Sample 1_Ant 1

DUT: 131204C32

Communication System: UMTS-FDD (WCDMA); Frequency: 1732.6 MHz; Duty Cycle: 1:1.95

Medium: Air Medium parameters used: $\sigma = 0 \text{ S/m}$, $\epsilon_r = 1$; $\rho = 1000 \text{ kg/m}^3$

Ambient Temperature : 21.2 °C

DASY5 Configuration:

- Probe: ER3DV6 - SN2445; ConvF(1, 1, 1); Calibrated: 2013/02/18;
- Sensor-Surface: (Fix Surface)
- Electronics: DAE3 Sn510; Calibrated: 2013/09/25
- Phantom: HAC Test Arch with AMCC; Type: SD HAC P01 BA;
- Measurement SW: DASY52, Version 52.8 (7); SEMCAD X Version 14.6.10 (7164)

- Hearing Aid Compatibility (101x101x1): Interpolated grid: dx=0.5000 mm, dy=0.5000 mm

Device Reference Point: 0, 0, -6.3 mm

Reference Value = 40.16 V/m; Power Drift = 0.03 dB

Applied MIF = -27.23 dB

RF audio interference level = 5.15 dBV/m

Emission category: M4

Grid 1 M4 7.79 dBV/m	Grid 2 M4 9.19 dBV/m	Grid 3 M4 7.83 dBV/m
Grid 4 M4 3.92 dBV/m	Grid 5 M4 5.15 dBV/m	Grid 6 M4 4.28 dBV/m
Grid 7 M4 -2.49 dBV/m	Grid 8 M4 0.33 dBV/m	Grid 9 M4 0.53 dBV/m

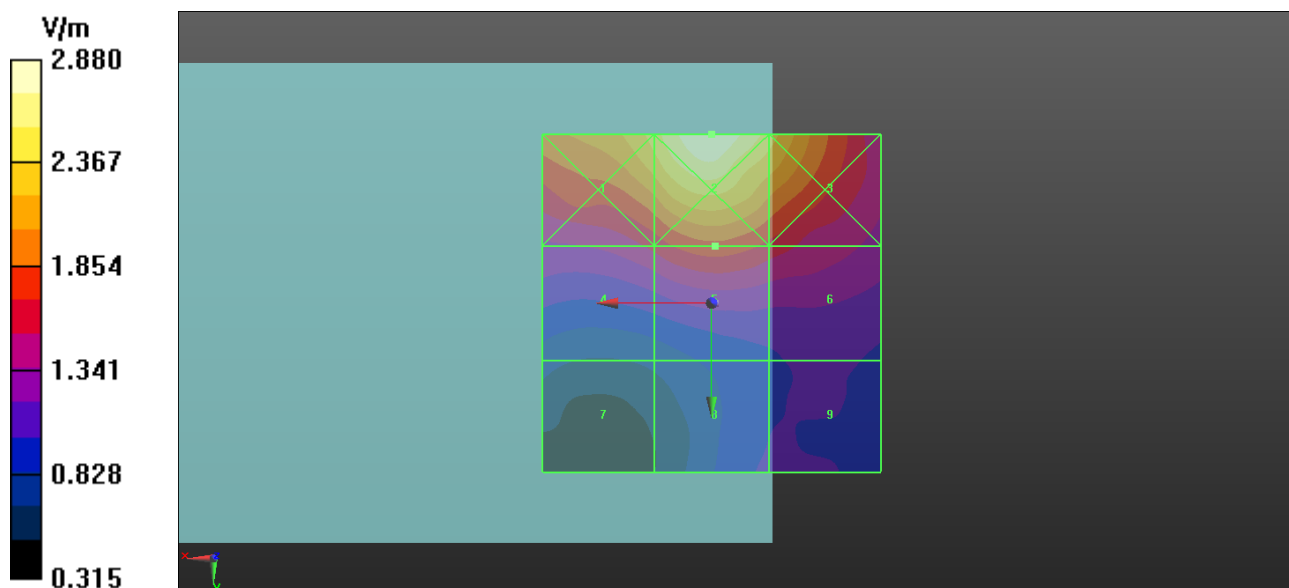

P05 WCDMA V_RMC12.2k_Ch4132_Sample 1_Ant 1

DUT: 131204C32

Communication System: UMTS-FDD (WCDMA); Frequency: 826.4 MHz; Duty Cycle: 1:1.95

Medium: Air Medium parameters used: $\sigma = 0 \text{ S/m}$, $\epsilon_r = 1$; $\rho = 1000 \text{ kg/m}^3$

Ambient Temperature : 21.2 °C

DASY5 Configuration:

- Probe: ER3DV6 - SN2445; ConvF(1, 1, 1); Calibrated: 2013/02/18;
- Sensor-Surface: (Fix Surface)
- Electronics: DAE3 Sn510; Calibrated: 2013/09/25
- Phantom: HAC Test Arch with AMCC; Type: SD HAC P01 BA;
- Measurement SW: DASY52, Version 52.8 (7); SEMCAD X Version 14.6.10 (7164)

- Hearing Aid Compatibility (101x101x1): Interpolated grid: dx=0.5000 mm, dy=0.5000 mm

Device Reference Point: 0, 0, -6.3 mm

Reference Value = 50.89 V/m; Power Drift = 0.05 dB

Applied MIF = -27.23 dB

RF audio interference level = 5.83 dBV/m

Emission category: M4

Grid 1 M4 5.29 dBV/m	Grid 2 M4 5.83 dBV/m	Grid 3 M4 4.05 dBV/m
Grid 4 M4 4.62 dBV/m	Grid 5 M4 5.05 dBV/m	Grid 6 M4 4.33 dBV/m
Grid 7 M4 6.58 dBV/m	Grid 8 M4 8.25 dBV/m	Grid 9 M4 7.35 dBV/m

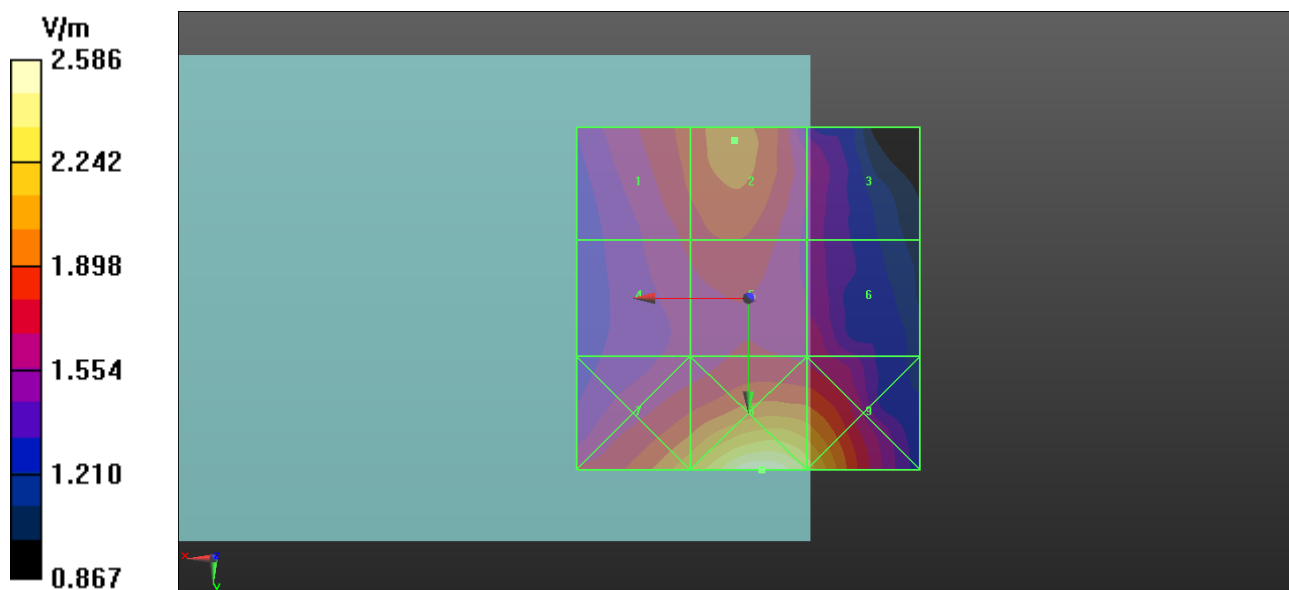



Appendix C. Calibration Certificate for Probe and Dipole

The SPEAG calibration certificates are shown as follows.



Accredited by the Swiss Accreditation Service (SAS)
The Swiss Accreditation Service is one of the signatories to the EA
Multilateral Agreement for the recognition of calibration certificates

Accreditation No.: **SCS 108**

Client **B.V. ADT (Auden)**

Certificate No: **CD835V3-1041_Mar13**

CALIBRATION CERTIFICATE

Object **CD835V3 - SN: 1041**

Calibration procedure(s) **QA CAL-20.v6
Calibration procedure for dipoles in air**

Calibration date: **March 15, 2013**

This calibration certificate documents the traceability to national standards, which realize the physical units of measurements (SI).
The measurements and the uncertainties with confidence probability are given on the following pages and are part of the certificate.

All calibrations have been conducted in the closed laboratory facility: environment temperature (22 ± 3)°C and humidity < 70%.

Calibration Equipment used (M&TE critical for calibration)

Primary Standards	ID #	Cal Date (Certificate No.)	Scheduled Calibration
Power meter EPM-442A	GB37480704	01-Nov-12 (No. 217-01640)	Oct-13
Power sensor HP 8481A	US37292783	01-Nov-12 (No. 217-01640)	Oct-13
Reference 10 dB Attenuator	SN: 5047.2 (10q)	27-Mar-12 (No. 217-01527)	Apr-13
Probe ER3DV6	SN: 2336	28-Dec-12 (No. ER3-2336_Dec12)	Dec-13
Probe H3DV6	SN: 6065	28-Dec-12 (No. H3-6065_Dec12)	Dec-13
DAE4	SN: 781	29-May-12 (No. DAE4-781_May12)	May-13

Secondary Standards	ID #	Check Date (in house)	Scheduled Check
Power meter Agilent 4419B	SN: GB42420191	09-Oct-09 (in house check Oct-12)	In house check: Oct-13
Power sensor HP E4412A	SN: MY41495277	01-Apr-08 (in house check Oct-12)	In house check: Oct-13
Power sensor HP 8482A	SN: US37295597	09-Oct-09 (in house check Oct-12)	In house check: Oct-13
Network Analyzer HP 8753E	US37390585	18-Oct-01 (in house check Oct-12)	In house check: Oct-13
RF generator R&S SMT-06	SN: 832283/011	27-Aug-12 (in house check Oct-12)	In house check: Oct-14

	Name	Function	Signature
Calibrated by:	Leif Klysner	Laboratory Technician	
Approved by:	Fin Bomholt	Deputy Technical Manager	

Issued: March 19, 2013

This calibration certificate shall not be reproduced except in full without written approval of the laboratory.



Accredited by the Swiss Accreditation Service (SAS)

The Swiss Accreditation Service is one of the signatories to the EA
Multilateral Agreement for the recognition of calibration certificates

Accreditation No.: **SCS 108**

References

- [1] ANSI-C63.19-2007
American National Standard for Methods of Measurement of Compatibility between Wireless Communications
Devices and Hearing Aids.

Methods Applied and Interpretation of Parameters:

- *Coordinate System:* y-axis is in the direction of the dipole arms. z-axis is from the basis of the antenna (mounted on the table) towards its feed point between the two dipole arms. x-axis is normal to the other axes. In coincidence with the standards [1], the measurement planes (probe sensor center) are selected to be at a distance of 10 mm above the top edge of the dipole arms.
- *Measurement Conditions:* Further details are available from the hardcopies at the end of the certificate. All figures stated in the certificate are valid at the frequency indicated. The forward power to the dipole connector is set with a calibrated power meter connected and monitored with an auxiliary power meter connected to a directional coupler. While the dipole under test is connected, the forward power is adjusted to the same level.
- *Antenna Positioning:* The dipole is mounted on a HAC Test Arch phantom using the matching dipole positioner with the arms horizontal and the feeding cable coming from the floor. The measurements are performed in a shielded room with absorbers around the setup to reduce the reflections. It is verified before the mounting of the dipole under the Test Arch phantom, that its arms are perfectly in a line. It is installed on the HAC dipole positioner with its arms parallel below the dielectric reference wire and able to move elastically in vertical direction without changing its relative position to the top center of the Test Arch phantom. The vertical distance to the probe is adjusted after dipole mounting with a DASY5 Surface Check job. Before the measurement, the distance between phantom surface and probe tip is verified. The proper measurement distance is selected by choosing the matching section of the HAC Test Arch phantom with the proper device reference point (upper surface of the dipole) and the matching grid reference point (tip of the probe) considering the probe sensor offset. The vertical distance to the probe is essential for the accuracy.
- *Feed Point Impedance and Return Loss:* These parameters are measured using a HP 8753E Vector Network Analyzer. The impedance is specified at the SMA connector of the dipole. The influence of reflections was eliminating by applying the averaging function while moving the dipole in the air, at least 70cm away from any obstacles.
- *E-field distribution:* E field is measured in the x-y-plane with an isotropic ER3D-field probe with 100 mW forward power to the antenna feed point. In accordance with [1], the scan area is 20mm wide, its length exceeds the dipole arm length (180 or 90mm). The sensor center is 10 mm (in z) above the top of the dipole arms. Two 3D maxima are available near the end of the dipole arms. Assuming the dipole arms are perfectly in one line, the average of these two maxima (in subgrid 2 and subgrid 8) is determined to compensate for any non-parallelity to the measurement plane as well as the sensor displacement. The E-field value stated as calibration value represents the maximum of the interpolated 3D-E-field, 10mm above the dipole surface.
- *H-field distribution:* H-field is measured with an isotropic H-field probe with 100mW forward power to the antenna feed point, in the x-y-plane. The scan area and sensor distance is equivalent to the E-field scan. The maximum of the field is available at the center (subgrid 5) above the feed point. The H-field value stated as calibration value represents the maximum of the interpolated H-field, 10mm above the dipole surface at the feed point.

The reported uncertainty of measurement is stated as the standard uncertainty of measurement multiplied by the coverage factor $k=2$, which for a normal distribution corresponds to a coverage probability of approximately 95%.

Measurement Conditions

DASY system configuration, as far as not given on page 1.

DASY Version	DASY5	V52.8.5
Extrapolation	Advanced Extrapolation	
Phantom	HAC Test Arch	
Distance Dipole Top - Probe Center	10mm	
Scan resolution	dx, dy = 5 mm	
Frequency	835 MHz \pm 1 MHz	
Input power drift	< 0.06 dB	

Maximum Field values at 835 MHz

H-field 10 mm above dipole surface	condition	interpolated maximum
Maximum measured	100 mW input power	0.466 A / m \pm 8.2 % (k=2)

E-field 10 mm above dipole surface	condition	Interpolated maximum
Maximum measured above high end	100 mW input power	167.1 V / m
Maximum measured above low end	100 mW input power	164.6 V / m
Averaged maximum above arm	100 mW input power	165.8 V / m \pm 12.8 % (k=2)

E-field 15 mm above dipole surface	condition	Interpolated maximum
Maximum measured above high end	100 mW input power	108.0 V / m
Maximum measured above low end	100 mW input power	107.9 V / m
Averaged maximum above arm	100 mW input power	108.0 V / m \pm 12.8 % (k=2)

Appendix

Antenna Parameters

Frequency	Return Loss	Impedance
800 MHz	16.3 dB	43.0 Ω - 12.5 j Ω
835 MHz	27.5 dB	47.6 Ω + 3.4 j Ω
900 MHz	18.0 dB	57.0 Ω - 11.7 j Ω
950 MHz	19.9 dB	47.7 Ω + 9.7 j Ω
960 MHz	14.6 dB	55.1 Ω + 19.2 j Ω

3.2 Antenna Design and Handling

The calibration dipole has a symmetric geometry with a built-in two stub matching network, which leads to the enhanced bandwidth.

The dipole is built of standard semirigid coaxial cable. The internal matching line is open ended. The antenna is therefore open for DC signals.

Do not apply force to dipole arms, as they are liable to bend. The soldered connections near the feedpoint may be damaged. After excessive mechanical stress or overheating, check the impedance characteristics to ensure that the internal matching network is not affected.

After long term use with 40W radiated power, only a slight warming of the dipole near the feedpoint can be measured.

Impedance Measurement Plot

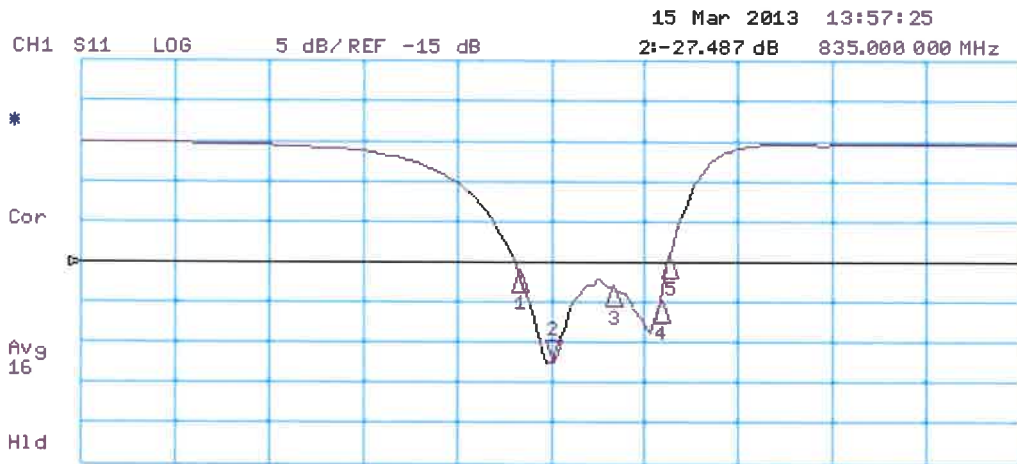

CH2 S11 1 U FS 2: 47.635 Ω 3: 3.3809 Ω 644.41 pF 835.000 000 MHz

De1
Cor
Avg 16
H1d

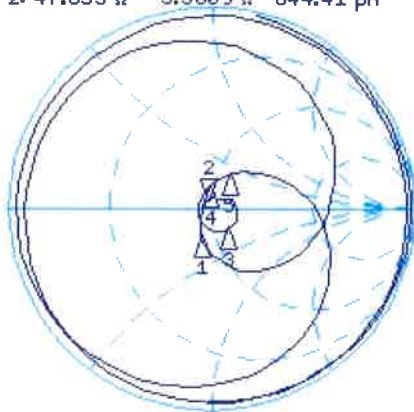

CH2 Markers

1:	42.986 Ω	-12.508 Ω	800.000 MHz
3:	56.959 Ω	-11.682 Ω	900.000 MHz
4:	47.672 Ω	9.6934 Ω	950.000 MHz
5:	55.104 Ω	19.195 Ω	960.000 MHz

START 335.000 000 MHz STOP 1 335.000 000 MHz

DASY5 H-field Result

Date: 15.03.2013

Test Laboratory: SPEAG Lab2

DUT: HAC-Dipole 835 MHz; Type: CD835V3; Serial: CD835V3 - SN: 1041

Communication System: CW; Frequency: 835 MHz
 Medium parameters used: $\sigma = 0$ S/m, $\epsilon_r = 1$; $\rho = 1$ kg/m³
 Phantom section: RF Section
 Measurement Standard: DASY5 (IEEE/IEC/ANSI C63.19-2007)

DASY52 Configuration:

- Probe: H3DV6 - SN6065; ; Calibrated: 28.12.2012
- Sensor-Surface: (Fix Surface)
- Electronics: DAE4 Sn781; Calibrated: 29.05.2012
- Phantom: HAC Test Arch with AMCC; Type: SD HAC P01 BA; Serial: 1070
- DASY52 52.8.5(1059); SEMCAD X 14.6.8(7028)

Dipole H-Field measurement @ 835MHz/H-Scan - 835MHz d=10mm/Hearing Aid Compatibility Test (41x361x1):

Interpolated grid: dx=0.5000 mm, dy=0.5000 mm

Device Reference Point: 0, 0, -6.3 mm

Reference Value = 0.4990 A/m; Power Drift = -0.05 dB

PMR not calibrated. PMF = 1.000 is applied.

H-field emissions = 0.4657 A/m

Near-field category: M4 (AWF 0 dB)

PMF scaled H-field

Grid 1 M4	Grid 2 M4	Grid 3 M4
0.382 A/m	0.405 A/m	0.383 A/m
Grid 4 M4	Grid 5 M4	Grid 6 M4
0.433 A/m	0.466 A/m	0.447 A/m
Grid 7 M4	Grid 8 M4	Grid 9 M4
0.376 A/m	0.412 A/m	0.399 A/m

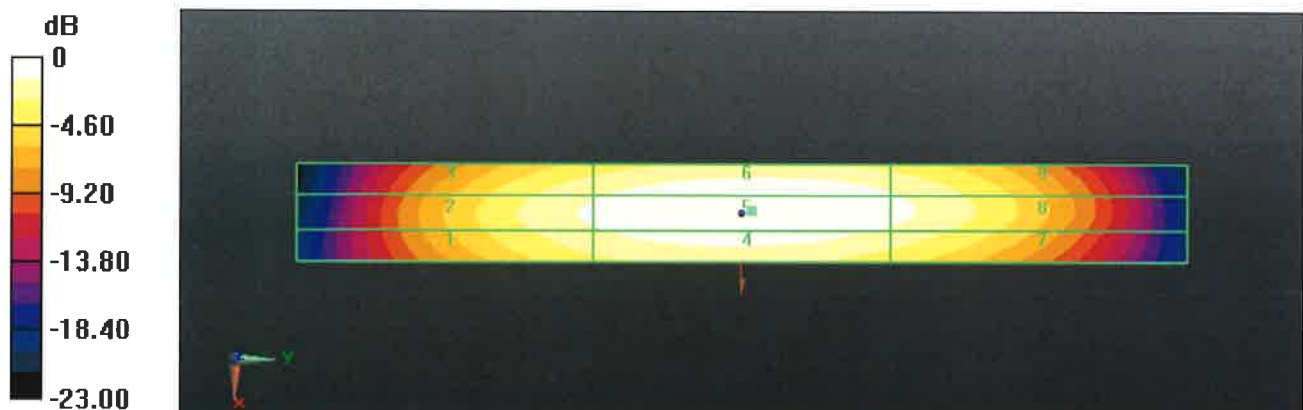

0 dB = 0.4657 A/m = -6.64 dBA/m

DASY5 E-field Result

Date: 15.03.2013

Test Laboratory: SPEAG Lab2

DUT: HAC-Dipole 835 MHz; Type: CD835V3; Serial: CD835V3 - SN: 1041

Communication System: CW; Frequency: 835 MHz

Medium parameters used: $\sigma = 0$ S/m, $\epsilon_r = 1$; $\rho = 1000$ kg/m³

Phantom section: RF Section

Measurement Standard: DASY5 (IEEE/IEC/ANSI C63.19-2007)

DASY52 Configuration:

- Probe: ER3DV6 - SN2336; ConvF(1, 1, 1); Calibrated: 28.12.2012;
- Sensor-Surface: (Fix Surface)
- Electronics: DAE4 Sn781; Calibrated: 29.05.2012
- Phantom: HAC Test Arch with AMCC; Type: SD HAC P01 BA; Serial: 1070
- DASY52 52.8.5(1059); SEMCAD X 14.6.8(7028)

Dipole E-Field measurement @ 835MHz/E-Scan - 835MHz d=10mm/Hearing Aid Compatibility Test (41x361x1):

Interpolated grid: dx=0.5000 mm, dy=0.5000 mm

Device Reference Point: 0, 0, -6.3 mm

Reference Value = 109.4 V/m; Power Drift = -0.01 dB

PMR not calibrated. PMF = 1.000 is applied.

E-field emissions = 167.1 V/m

Near-field category: M4 (AWF 0 dB)

PMF scaled E-field

Grid 1 M4 161.8 V/m	Grid 2 M4 164.6 V/m	Grid 3 M4 157.8 V/m
Grid 4 M4 89.77 V/m	Grid 5 M4 91.72 V/m	Grid 6 M4 88.33 V/m
Grid 7 M4 158.8 V/m	Grid 8 M4 167.1 V/m	Grid 9 M4 164.4 V/m

Dipole E-Field measurement @ 835MHz/E-Scan - 835MHz d=15mm/Hearing Aid Compatibility Test (41x361x1):
 Interpolated grid: dx=0.5000 mm, dy=0.5000 mm
 Device Reference Point: 0, 0, -6.3 mm
 Reference Value = 109.6 V/m; Power Drift = 0.00 dB
 PMR not calibrated. PMF = 1.000 is applied.
 E-field emissions = 108.0 V/m
Near-field category: M4 (AWF 0 dB)

PMF scaled E-field

Grid 1 M4 106.6 V/m	Grid 2 M4 107.9 V/m	Grid 3 M4 105.6 V/m
Grid 4 M4 65.13 V/m	Grid 5 M4 65.52 V/m	Grid 6 M4 64.28 V/m
Grid 7 M4 105.5 V/m	Grid 8 M4 108.0 V/m	Grid 9 M4 106.6 V/m

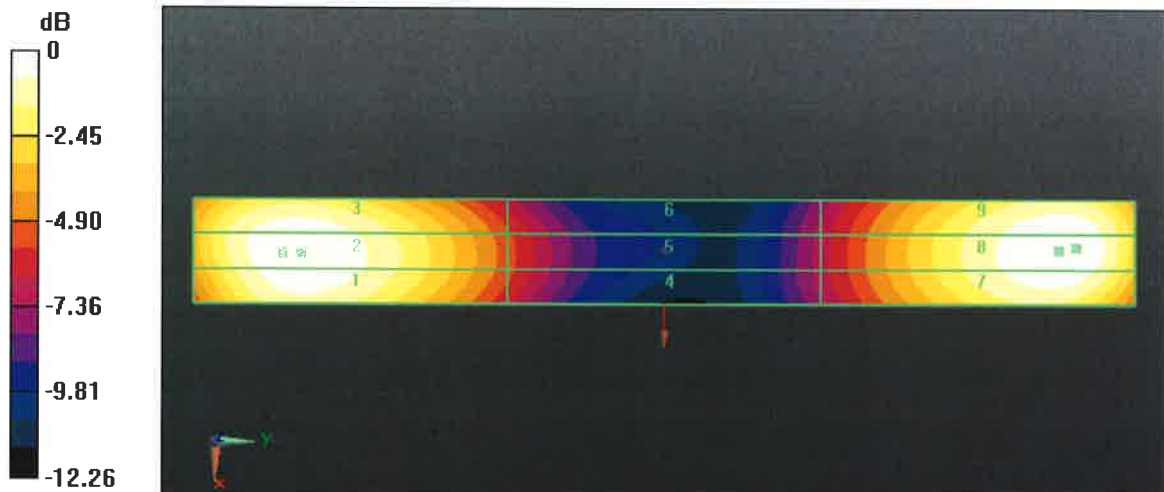

0 dB = 167.1 V/m = 44.46 dBV/m



Accredited by the Swiss Accreditation Service (SAS)

Accreditation No.: **SCS 108**

The Swiss Accreditation Service is one of the signatories to the EA
Multilateral Agreement for the recognition of calibration certificates

Client **B.V. ADT (Auden)**

Certificate No: **CD1880V3-1032_Apr13**

CALIBRATION CERTIFICATE

Object **CD1880V3 - SN: 1032**

Calibration procedure(s) **QA CAL-20.v6
Calibration procedure for dipoles in air**

Calibration date: **April 23, 2013**

This calibration certificate documents the traceability to national standards, which realize the physical units of measurements (SI).
The measurements and the uncertainties with confidence probability are given on the following pages and are part of the certificate.

All calibrations have been conducted in the closed laboratory facility: environment temperature (22 ± 3)°C and humidity < 70%.

Calibration Equipment used (M&TE critical for calibration)

Primary Standards	ID #	Cal Date (Certificate No.)	Scheduled Calibration
Power meter EPM-442A	GB37480704	01-Nov-12 (No. 217-01640)	Oct-13
Power sensor HP 8481A	US37292783	01-Nov-12 (No. 217-01640)	Oct-13
Reference 10 dB Attenuator	SN: 5047.2 (10q)	04-Apr-13 (No. 217-01731)	Apr-14
Probe ER3DV6	SN: 2336	28-Dec-12 (No. ER3-2336_Dec12)	Dec-13
Probe H3DV6	SN: 6065	28-Dec-12 (No. H3-6065_Dec12)	Dec-13
DAE4	SN: 781	29-May-12 (No. DAE4-781_May12)	May-13

Secondary Standards	ID #	Check Date (in house)	Scheduled Check
Power meter Agilent 4419B	SN: GB42420191	09-Oct-09 (in house check Oct-12)	In house check: Oct-13
Power sensor HP E4412A	SN: MY41495277	01-Apr-08 (in house check Oct-12)	In house check: Oct-13
Power sensor HP 8482A	SN: US37295597	09-Oct-09 (in house check Oct-12)	In house check: Oct-13
Network Analyzer HP 8753E	US37390585	18-Oct-01 (in house check Oct-12)	In house check: Oct-13
RF generator R&S SMT-06	SN: 832283/011	27-Aug-12 (in house check Oct-12)	In house check: Oct-14

	Name	Function	Signature
Calibrated by:	Dimce Iliev	Laboratory Technician	
Approved by:	Fin Bomholt	Deputy Technical Manager	

Issued: April 23, 2013

This calibration certificate shall not be reproduced except in full without written approval of the laboratory.



Accredited by the Swiss Accreditation Service (SAS)

The Swiss Accreditation Service is one of the signatories to the EA
Multilateral Agreement for the recognition of calibration certificates

Accreditation No.: **SCS 108**

References

- [1] ANSI-C63.19-2007
American National Standard for Methods of Measurement of Compatibility between Wireless Communications Devices and Hearing Aids.
- [2] ANSI-C63.19-2011
American National Standard, Methods of Measurement of Compatibility between Wireless Communications Devices and Hearing Aids.

Methods Applied and Interpretation of Parameters:

- *Coordinate System:* y-axis is in the direction of the dipole arms. z-axis is from the basis of the antenna (mounted on the table) towards its feed point between the two dipole arms. x-axis is normal to the other axes. In coincidence with the standards [1], the measurement planes (probe sensor center) are selected to be at a distance of 10 mm (15 mm for [2]) above the top metal edge of the dipole arms.
- *Measurement Conditions:* Further details are available from the hardcopies at the end of the certificate. All figures stated in the certificate are valid at the frequency indicated. The forward power to the dipole connector is set with a calibrated power meter connected and monitored with an auxiliary power meter connected to a directional coupler. While the dipole under test is connected, the forward power is adjusted to the same level.
- *Antenna Positioning:* The dipole is mounted on a HAC Test Arch phantom using the matching dipole positioner with the arms horizontal and the feeding cable coming from the floor. The measurements are performed in a shielded room with absorbers around the setup to reduce the reflections. It is verified before the mounting of the dipole under the Test Arch phantom, that its arms are perfectly in a line. It is installed on the HAC dipole positioner with its arms parallel below the dielectric reference wire and able to move elastically in vertical direction without changing its relative position to the top center of the Test Arch phantom. The vertical distance to the probe is adjusted after dipole mounting with a DASY5 Surface Check job. Before the measurement, the distance between phantom surface and probe tip is verified. The proper measurement distance is selected by choosing the matching section of the HAC Test Arch phantom with the proper device reference point (upper surface of the dipole) and the matching grid reference point (tip of the probe) considering the probe sensor offset. The vertical distance to the probe is essential for the accuracy.
- *Feed Point Impedance and Return Loss:* These parameters are measured using a HP 8753E Vector Network Analyzer. The impedance is specified at the SMA connector of the dipole. The influence of reflections was eliminated by applying the averaging function while moving the dipole in the air, at least 70cm away from any obstacles.
- *E-field distribution:* E field is measured in the x-y-plane with an isotropic ER3D-field probe with 100 mW forward power to the antenna feed point. In accordance with [1] and [2], the scan area is 20mm wide, its length exceeds the dipole arm length (180 or 90mm). The sensor center is 10 mm (15 mm for [2]) (in z) above the metal top of the dipole arms. Two 3D maxima are available near the end of the dipole arms. Assuming the dipole arms are perfectly in one line, the average of these two maxima (in subgrid 2 and subgrid 8) is determined to compensate for any non-parallelity to the measurement plane as well as the sensor displacement. The E-field value stated as calibration value represents the maximum of the interpolated 3D-E-field, in the plane above the dipole surface.
- *H-field distribution:* H-field is measured with an isotropic H-field probe with 100mW forward power to the antenna feed point, in the x-y-plane. The scan area and sensor distance is equivalent to the E-field scan. The maximum of the field is available at the center (subgrid 5) above the feed point. The H-field value stated as calibration value represents the maximum of the interpolated H-field, 10mm above the dipole surface at the feed point.

The reported uncertainty of measurement is stated as the standard uncertainty of measurement multiplied by the coverage factor $k=2$, which for a normal distribution corresponds to a coverage probability of approximately 95%.

Measurement Conditions

DASY system configuration, as far as not given on page 1.

DASY Version	DASY5	V52.8.6
Extrapolation	Advanced Extrapolation	
Phantom	HAC Test Arch	
Distance Dipole Top - Probe Center	10mm 15mm	
Scan resolution	dx, dy = 5 mm	
Frequency	1880 MHz \pm 1 MHz	
Input power drift	< 0.05 dB	

Maximum Field values at 1880 MHz

H-field 10 mm above dipole surface	condition	interpolated maximum
Maximum measured	100 mW input power	0.464 A / m \pm 8.2 % (k=2)

E-field 10 mm above dipole surface	condition	Interpolated maximum
Maximum measured above high end	100 mW input power	143.0 V / m
Maximum measured above low end	100 mW input power	140.3 V / m
Averaged maximum above arm	100 mW input power	141.7 V / m \pm 12.8 % (k=2)

E-field 15 mm above dipole surface	condition	Interpolated maximum
Maximum measured above high end	100 mW input power	92.7 V / m
Maximum measured above low end	100 mW input power	90.1 V / m
Averaged maximum above arm	100 mW input power	91.4 V / m \pm 12.8 % (k=2)

Appendix

Antenna Parameters

Frequency	Return Loss	Impedance
1730 MHz	25.0 dB	50.6 Ω + 5.6 j Ω
1880 MHz	19.9 dB	51.1 Ω + 10.2 j Ω
1900 MHz	20.3 dB	54.7 Ω + 9.0 j Ω
1950 MHz	26.5 dB	54.8 Ω + 1.1 j Ω
2000 MHz	22.2 dB	43.1 Ω + 2.0 j Ω

3.2 Antenna Design and Handling

The calibration dipole has a symmetric geometry with a built-in two stub matching network, which leads to the enhanced bandwidth.

The dipole is built of standard semirigid coaxial cable. The internal matching line is open ended. The antenna is therefore open for DC signals.

Do not apply force to dipole arms, as they are liable to bend. The soldered connections near the feedpoint may be damaged. After excessive mechanical stress or overheating, check the impedance characteristics to ensure that the internal matching network is not affected.

After long term use with 40W radiated power, only a slight warming of the dipole near the feedpoint can be measured.

Impedance Measurement Plot

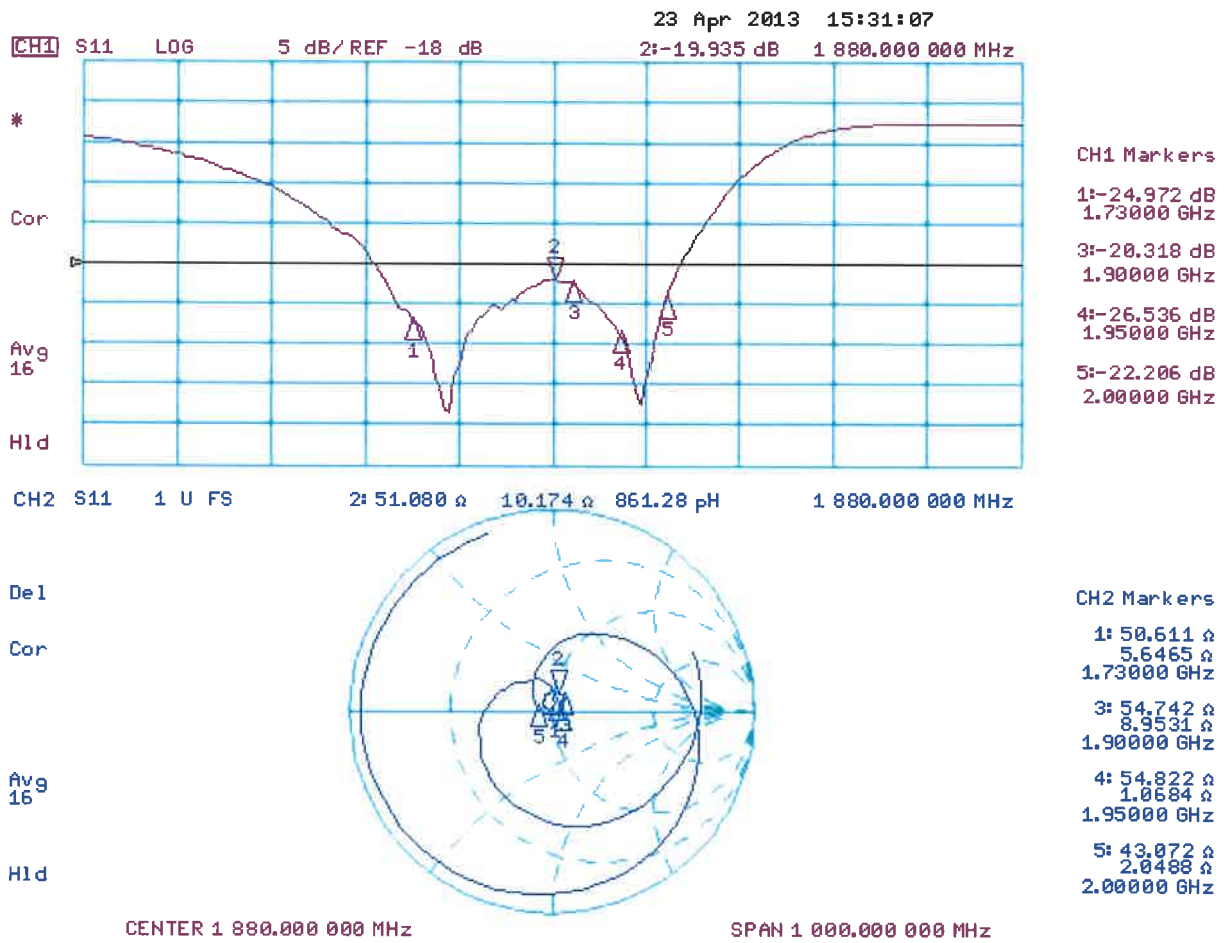

DASY5 H-field Result

Date: 23.04.2013

Test Laboratory: SPEAG Lab2

DUT: HAC Dipole 1880 MHz; Type: CD1880V3; Serial: CD1880V3 - SN: 1032

Communication System: UID 0 - CW; Frequency: 1880 MHz

Medium parameters used: $\sigma = 0$ S/m, $\epsilon_r = 1$; $\rho = 1$ kg/m³

Phantom section: RF Section

Measurement Standard: DASY5 (IEEE/IEC/ANSI C63.19-2007)

DASY52 Configuration:

- Probe: H3DV6 - SN6065; ; Calibrated: 28.12.2012
- Sensor-Surface: (Fix Surface)
- Electronics: DAE4 Sn781; Calibrated: 29.05.2012
- Phantom: HAC Test Arch with AMCC; Type: SD HAC P01 BA; Serial: 1070
- DASY52 52.8.6(1115); SEMCAD X 14.6.9(7117)

Dipole H-Field measurement @ 1880MHz/H-Scan - 1880MHz d=10mm/Hearing Aid Compatibility Test (41x181x1): Interpolated grid: dx=0.5000 mm, dy=0.5000 mm

Device Reference Point: 0, 0, -6.3 mm

Reference Value = 0.4920 A/m; Power Drift = -0.01 dB

PMR not calibrated. PMF = 1.000 is applied.

H-field emissions = 0.4642 A/m

Near-field category: M2 (AWF 0 dB)

PMF scaled H-field

Grid 1 M2 0.399 A/m	Grid 2 M2 0.420 A/m	Grid 3 M2 0.405 A/m
Grid 4 M2 0.437 A/m	Grid 5 M2 0.464 A/m	Grid 6 M2 0.449 A/m
Grid 7 M2 0.402 A/m	Grid 8 M2 0.432 A/m	Grid 9 M2 0.418 A/m

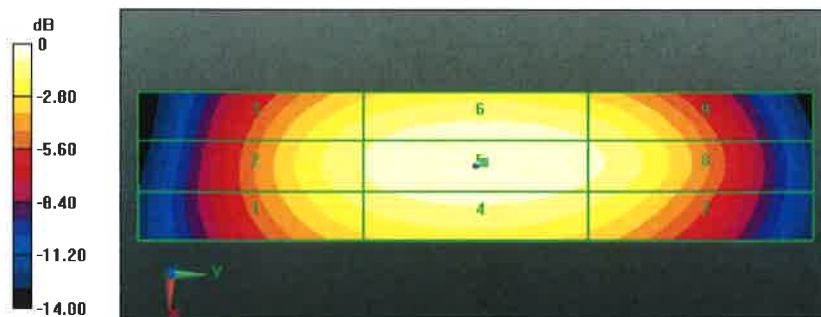

0 dB = 0.4642 A/m = -6.67 dBA/m

DASY5 E-field Result

Date: 23.04.2013

Test Laboratory: SPEAG Lab2

DUT: HAC Dipole 1880 MHz; Type: CD1880V3; Serial: CD1880V3 - SN: 1032

Communication System: UID 0 - CW; Frequency: 1880 MHz

Medium parameters used: $\sigma = 0$ S/m, $\epsilon_r = 1$; $\rho = 1000$ kg/m³

Phantom section: RF Section

Measurement Standard: DASY5 (IEEE/IEC/ANSI C63.19-2007)

DASY52 Configuration:

- Probe: ER3DV6 - SN2336; ConvF(1, 1, 1); Calibrated: 28.12.2012;
- Sensor-Surface: (Fix Surface)
- Electronics: DAE4 Sn781; Calibrated: 29.05.2012
- Phantom: HAC Test Arch with AMCC; Type: SD HAC P01 BA; Serial: 1070
- DASY52 52.8.6(1115); SEMCAD X 14.6.9(7117)

Dipole E-Field measurement @ 1880MHz/E-Scan - 1880MHz d=10mm/Hearing Aid Compatibility Test

(41x181x1): Interpolated grid: dx=0.5000 mm, dy=0.5000 mm

Device Reference Point: 0, 0, -6.3 mm

Reference Value = 161.6 V/m; Power Drift = -0.00 dB

PMR not calibrated. PMF = 1.000 is applied.

E-field emissions = 143.0 V/m

Near-field category: M2 (AWF 0 dB)

PMF scaled E-field

Grid 1 M2 135.7 V/m	Grid 2 M2 140.3 V/m	Grid 3 M2 137.0 V/m
Grid 4 M3 92.35 V/m	Grid 5 M3 94.76 V/m	Grid 6 M3 91.05 V/m
Grid 7 M2 133.2 V/m	Grid 8 M2 143.0 V/m	Grid 9 M2 141.5 V/m

Dipole E-Field measurement @ 1880MHz/E-Scan - 1880MHz d=15mm/Hearing Aid Compatibility Test (41x181x1): Interpolated grid: dx=0.5000 mm, dy=0.5000 mm
 Device Reference Point: 0, 0, -6.3 mm
 Reference Value = 160.9 V/m; Power Drift = 0.01 dB
 PMR not calibrated. PMF = 1.000 is applied.
 E-field emissions = 92.74 V/m
Near-field category: M3 (AWF 0 dB)

PMF scaled E-field

Grid 1 M3 90.77 V/m	Grid 2 M3 92.74 V/m	Grid 3 M3 91.42 V/m
Grid 4 M3 72.21 V/m	Grid 5 M3 73.10 V/m	Grid 6 M3 72.02 V/m
Grid 7 M3 87.31 V/m	Grid 8 M3 90.11 V/m	Grid 9 M3 89.51 V/m

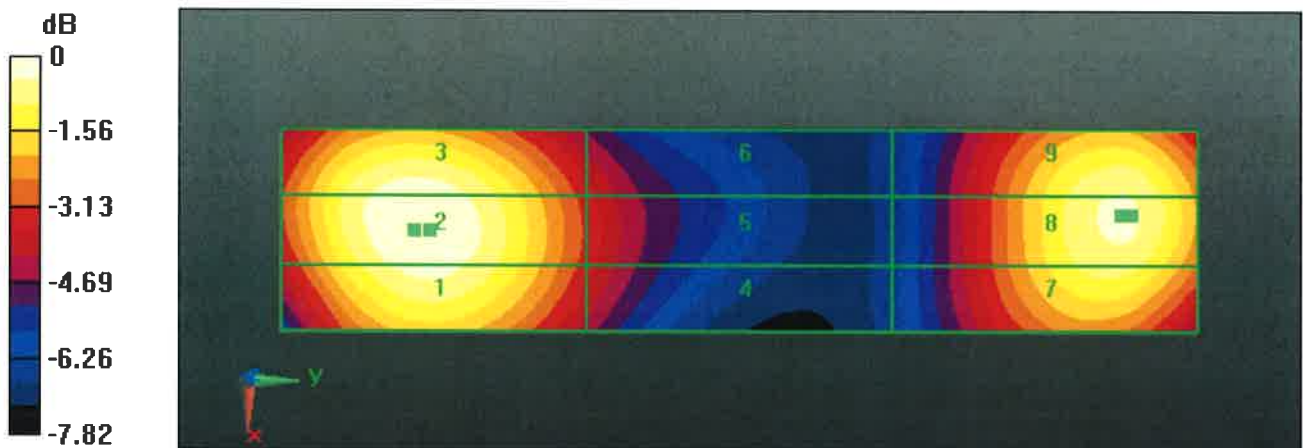

0 dB = 143.0 V/m = 43.11 dBV/m



Accredited by the Swiss Accreditation Service (SAS)
The Swiss Accreditation Service is one of the signatories to the EA
Multilateral Agreement for the recognition of calibration certificates

Accreditation No.: **SCS 108**

Client **B.V.ADT (Auden)**

Certificate No: **ER3-2445_Feb13**

CALIBRATION CERTIFICATE

Object **ER3DV6 - SN:2445**

Calibration procedure(s) **QA CAL-02.v6, QA CAL-25.v4
Calibration procedure for E-field probes optimized for close near field
evaluations in air**

Calibration date: **February 18, 2013**

This calibration certificate documents the traceability to national standards, which realize the physical units of measurements (SI).
The measurements and the uncertainties with confidence probability are given on the following pages and are part of the certificate.

All calibrations have been conducted in the closed laboratory facility: environment temperature (22 ± 3)°C and humidity < 70%.

Calibration Equipment used (M&TE critical for calibration)

Primary Standards	ID	Cal Date (Certificate No.)	Scheduled Calibration
Power meter E4419B	GB41293874	29-Mar-12 (No. 217-01508)	Apr-13
Power sensor E4412A	MY41498087	29-Mar-12 (No. 217-01508)	Apr-13
Reference 3 dB Attenuator	SN: S5054 (3c)	27-Mar-12 (No. 217-01531)	Apr-13
Reference 20 dB Attenuator	SN: S5086 (20b)	27-Mar-12 (No. 217-01529)	Apr-13
Reference 30 dB Attenuator	SN: S5129 (30b)	27-Mar-12 (No. 217-01532)	Apr-13
Reference Probe ER3DV6	SN: 2328	12-Oct-12 (No. ER3-2328_Oct12)	Oct-13
DAE4	SN: 789	18-Sep-12 (No. DAE4-789_Sep12)	Sep-13
Secondary Standards	ID	Check Date (in house)	Scheduled Check
RF generator HP 8648C	US3642U01700	4-Aug-99 (in house check Apr-11)	In house check: Apr-13
Network Analyzer HP 8753E	US37390585	18-Oct-01 (in house check Oct-12)	In house check: Oct-13

	Name	Function	Signature
Calibrated by:	Jeton Kastrati	Laboratory Technician	
Approved by:	Katja Pokovic	Technical Manager	

Issued: February 20, 2013

This calibration certificate shall not be reproduced except in full without written approval of the laboratory.



Accredited by the Swiss Accreditation Service (SAS)

Accreditation No.: **SCS 108**

The Swiss Accreditation Service is one of the signatories to the EA
Multilateral Agreement for the recognition of calibration certificates

Glossary:

NORM _{x,y,z}	sensitivity in free space
DCP	diode compression point
CF	crest factor (1/duty_cycle) of the RF signal
A, B, C, D	modulation dependent linearization parameters
Polarization ϕ	ϕ rotation around probe axis
Polarization ϑ	ϑ rotation around an axis that is in the plane normal to probe axis (at measurement center), i.e., $\vartheta = 0$ is normal to probe axis
Connector Angle	information used in DASY system to align probe sensor X to the robot coordinate system

Calibration is Performed According to the Following Standards:

- IEEE Std 1309-2005, "IEEE Standard for calibration of electromagnetic field sensors and probes, excluding antennas, from 9 kHz to 40 GHz", December 2005
- CTIA Test Plan for Hearing Aid Compatibility, April 2010.

Methods Applied and Interpretation of Parameters:

- NORM_{x,y,z}*: Assessed for E-field polarization $\vartheta = 0$ for XY sensors and $\vartheta = 90$ for Z sensor ($f \leq 900$ MHz in TEM-cell; $f > 1800$ MHz: R22 waveguide).
- NORM(f)_{x,y,z}* = *NORM_{x,y,z}* * *frequency_response* (see Frequency Response Chart).
- DCP_{x,y,z}*: DCP are numerical linearization parameters assessed based on the data of power sweep with CW signal (no uncertainty required). DCP does not depend on frequency nor media.
- PAR*: PAR is the Peak to Average Ratio that is not calibrated but determined based on the signal characteristics
- A_{x,y,z}; B_{x,y,z}; C_{x,y,z}; D_{x,y,z}; VR_{x,y,z}*; *A, B, C, D* are numerical linearization parameters assessed based on the data of power sweep for specific modulation signal. The parameters do not depend on frequency nor media. *VR* is the maximum calibration range expressed in RMS voltage across the diode.
- Spherical isotropy (3D deviation from isotropy)*: in a locally homogeneous field realized using an open waveguide setup.
- Sensor Offset*: The sensor offset corresponds to the offset of virtual measurement center from the probe tip (on probe axis). No tolerance required.
- Connector Angle*: The angle is assessed using the information gained by determining the *NORM_x* (no uncertainty required).

Probe ER3DV6

SN:2445

Manufactured: January 22, 2008
Calibrated: February 18, 2013

Calibrated for DASY/EASY Systems
(Note: non-compatible with DASY2 system!)

DASY/EASY - Parameters of Probe: ER3DV6 - SN:2445

Basic Calibration Parameters

	Sensor X	Sensor Y	Sensor Z	Unc (k=2)
Norm ($\mu\text{V}/(\text{V}/\text{m})^2$)	1.48	1.70	1.83	$\pm 10.1\%$
DCP (mV) ^B	97.7	99.7	101.0	

Modulation Calibration Parameters

UID	Communication System Name		A dB	B dB $\sqrt{\mu\text{V}}$	C	D dB	VR mV	Unc ^E (k=2)
0	CW	X	0.0	0.0	1.0	0.00	203.1	$\pm 3.3\%$
		Y	0.0	0.0	1.0		157.3	
		Z	0.0	0.0	1.0		204.2	
10011	UMTS-FDD (WCDMA)	X	3.15	65.9	18.2	2.91	121.0	$\pm 0.7\%$
		Y	3.28	67.1	19.1		126.3	
		Z	3.17	66.3	18.3		118.8	
10012	IEEE 802.11b WiFi 2.4 GHz (DSSS, 1 Mbps)	X	2.64	66.4	17.8	1.87	124.0	$\pm 0.7\%$
		Y	3.15	70.6	20.3		128.8	
		Z	2.95	68.6	18.8		121.7	
10021	GSM-FDD (TDMA, GMSK)	X	20.01	99.7	29.1	9.39	131.8	$\pm 1.4\%$
		Y	18.28	99.1	28.6		129.3	
		Z	24.77	99.7	28.8		98.6	
10039	CDMA2000 (1xRTT, RC1)	X	4.75	66.2	19.0	4.57	121.0	$\pm 0.9\%$
		Y	4.85	67.0	19.5		125.0	
		Z	4.66	66.2	18.9		119.2	
10081	CDMA2000 (1xRTT, RC3)	X	3.90	65.6	18.6	3.97	118.3	$\pm 0.7\%$
		Y	3.95	66.2	19.0		122.8	
		Z	3.84	65.6	18.5		117.4	
10148	LTE-FDD (SC-FDMA, 50% RB, 20 MHz, QPSK)	X	6.58	67.8	20.4	5.84	133.7	$\pm 1.9\%$
		Y	6.72	68.6	20.9		138.8	
		Z	6.48	67.6	20.1		132.4	
10154	LTE-FDD (SC-FDMA, 50% RB, 10 MHz, QPSK)	X	6.22	67.3	20.2	5.76	130.2	$\pm 1.9\%$
		Y	6.27	67.8	20.5		134.9	
		Z	6.05	66.9	19.7		128.4	
10156	LTE-FDD (SC-FDMA, 50% RB, 5 MHz, QPSK)	X	6.03	67.1	20.2	5.79	127.3	$\pm 1.9\%$
		Y	6.07	67.5	20.4		132.1	
		Z	5.82	66.5	19.6		125.0	
10160	LTE-FDD (SC-FDMA, 50% RB, 15 MHz, QPSK)	X	6.65	67.9	20.4	5.82	135.8	$\pm 2.2\%$
		Y	6.79	68.6	20.9		141.7	
		Z	6.49	67.4	20.0		132.9	
10163	LTE-FDD (SC-FDMA, 50% RB, 3 MHz, QPSK)	X	5.86	67.0	20.0	5.68	126.6	$\pm 1.9\%$
		Y	5.91	67.4	20.3		131.6	
		Z	5.66	66.4	19.5		123.0	
10166	LTE-FDD (SC-FDMA, 50% RB, 1.4 MHz, QPSK)	X	5.19	66.3	19.6	5.46	120.5	$\pm 1.4\%$
		Y	5.22	66.8	20.0		124.4	
		Z	5.05	65.9	19.2		117.6	

10169	LTE-FDD (SC-FDMA, 1 RB, 20 MHz, QPSK)	X	5.12	66.5	19.9	5.73	115.9	±1.4 %
		Y	5.15	67.0	20.3		119.8	
		Z	5.04	66.2	19.5		113.8	
10175	LTE-FDD (SC-FDMA, 1 RB, 10 MHz, QPSK)	X	5.12	66.5	19.8	5.73	115.6	±1.4 %
		Y	5.16	67.1	20.3		119.8	
		Z	5.01	66.0	19.3		117.0	
10177	LTE-FDD (SC-FDMA, 1 RB, 5 MHz, QPSK)	X	5.09	66.3	19.8	5.73	115.9	±1.4 %
		Y	5.18	67.2	20.4		119.9	
		Z	5.02	66.0	19.4		117.6	
10181	LTE-FDD (SC-FDMA, 1 RB, 15 MHz, QPSK)	X	5.14	66.6	19.9	5.73	115.6	±1.7 %
		Y	5.18	67.2	20.4		119.7	
		Z	5.02	66.0	19.4		117.8	
10184	LTE-FDD (SC-FDMA, 1 RB, 3 MHz, QPSK)	X	5.15	66.6	19.9	5.73	115.9	±1.7 %
		Y	5.16	67.0	20.3		119.9	
		Z	5.06	66.2	19.4		118.1	
10187	LTE-FDD (SC-FDMA, 1 RB, 1.4 MHz, QPSK)	X	5.14	66.6	19.9	5.73	116.3	±1.7 %
		Y	5.18	67.1	20.3		120.2	
		Z	5.03	66.1	19.4		118.4	
10276	CDMA2000 (1xRTT, RC1, 1/8 Rate)	X	8.87	75.7	29.1	12.97	53.6	±3.3 %
		Y	9.43	78.3	30.7		55.3	
		Z	8.67	73.7	27.2		55.9	

The reported uncertainty of measurement is stated as the standard uncertainty of measurement multiplied by the coverage factor $k=2$, which for a normal distribution corresponds to a coverage probability of approximately 95%.

^B Numerical linearization parameter: uncertainty not required.

^E Uncertainty is determined using the max. deviation from linear response applying rectangular distribution and is expressed for the square of the field value.

Frequency Response of E-Field (TEM-Cell:ifi110 EXX, Waveguide: R22)

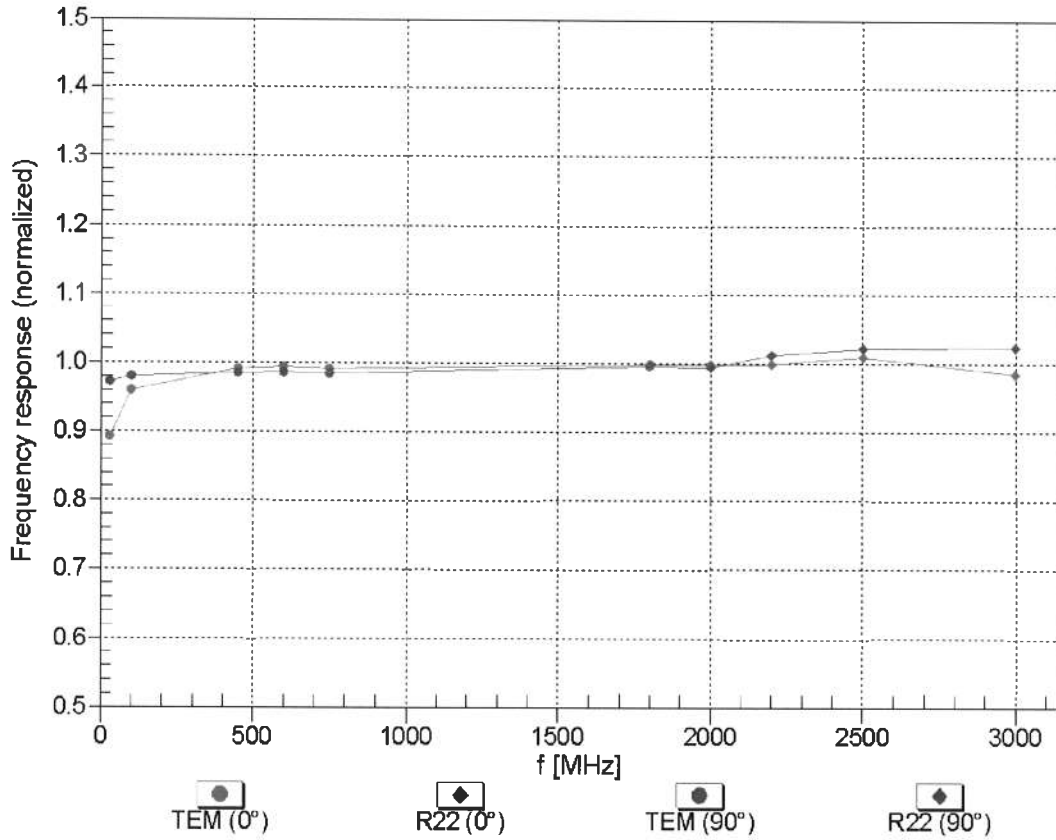

Uncertainty of Frequency Response of E-field: ± 6.3% (k=2)

Receiving Pattern (ϕ), $\vartheta = 0^\circ$

f=600 MHz,TEM,0°

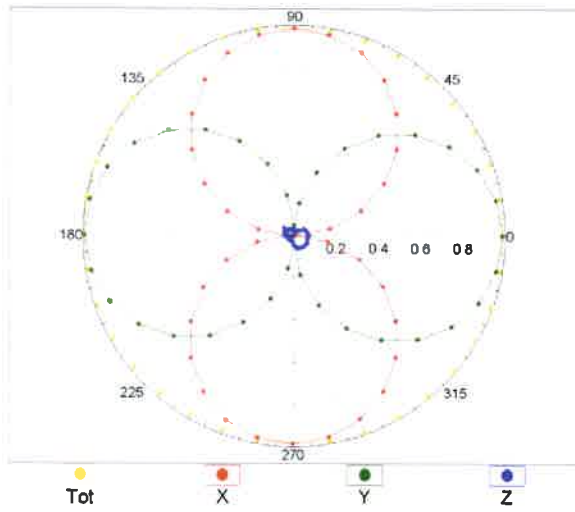

f=2500 MHz,R22,0°

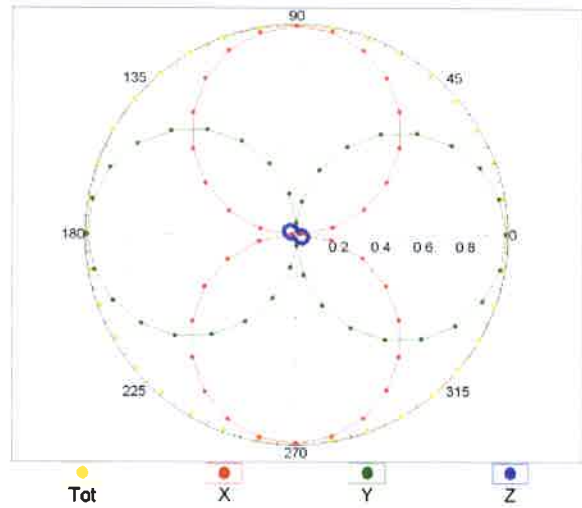

Receiving Pattern (ϕ), $\vartheta = 90^\circ$

f=600 MHz,TEM,90°

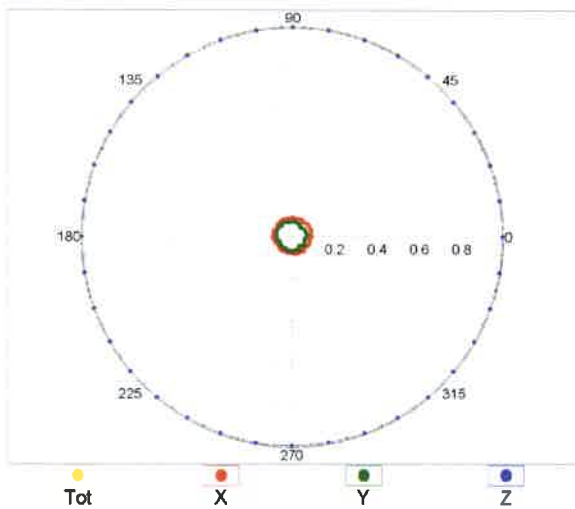

f=2500 MHz,R22,90°

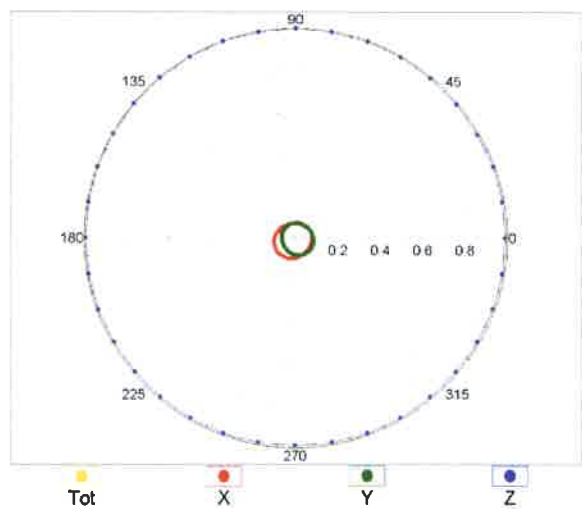

Receiving Pattern (ϕ), $\vartheta = 0^\circ$

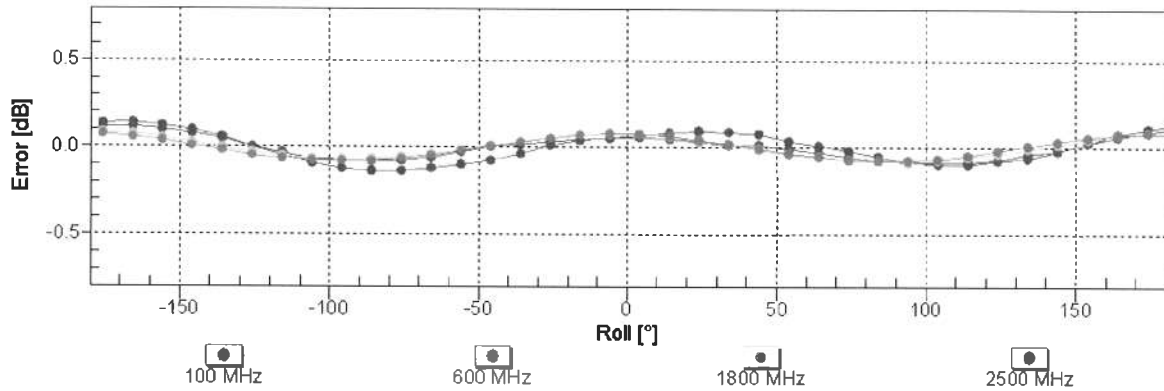

Uncertainty of Axial Isotropy Assessment: $\pm 0.5\%$ ($k=2$)

Receiving Pattern (ϕ), $\vartheta = 90^\circ$

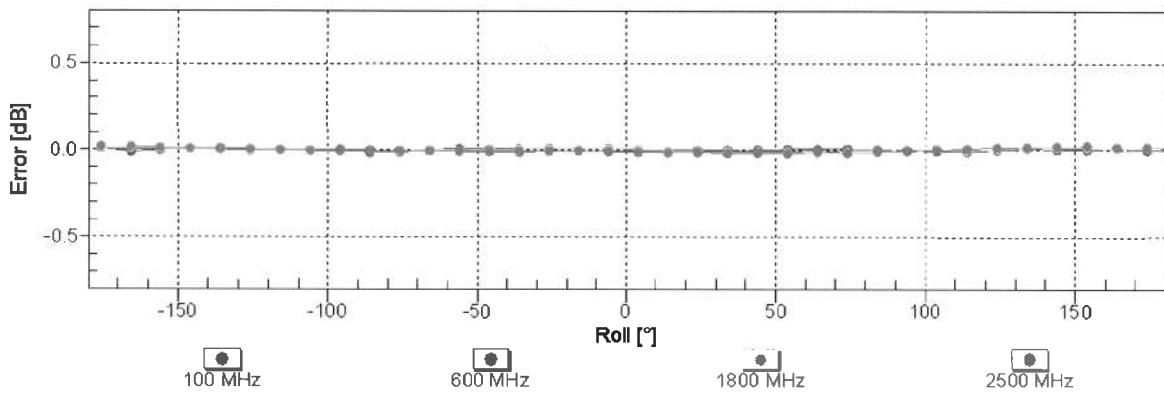

Uncertainty of Axial Isotropy Assessment: $\pm 0.5\%$ ($k=2$)

Dynamic Range f(E-field) (TEM cell , f = 900 MHz)

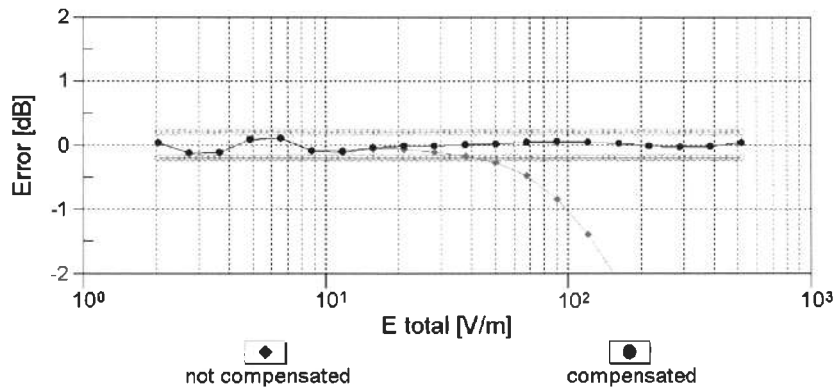
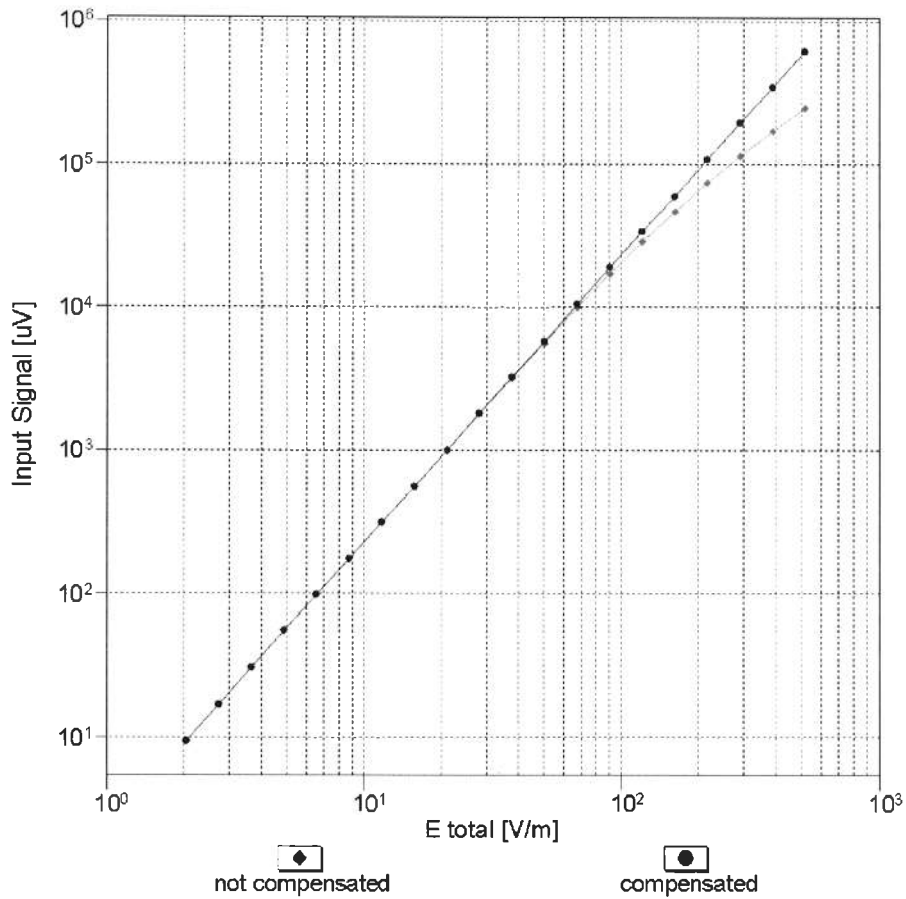

Uncertainty of Linearity Assessment: ± 0.6% (k=2)

Deviation from Isotropy in Air

Error (ϕ, θ), $f = 900$ MHz

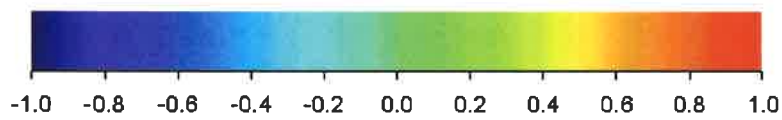
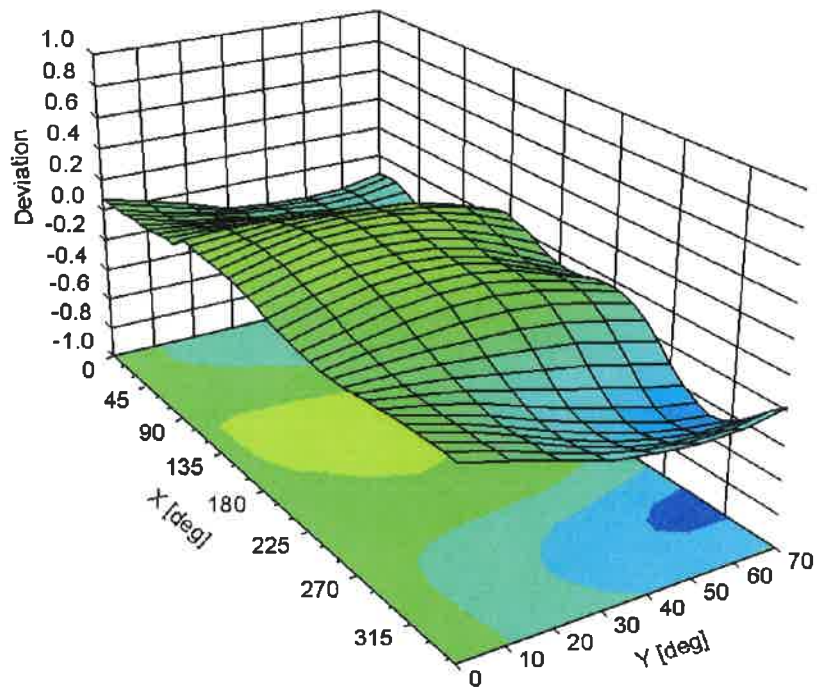

Uncertainty of Spherical Isotropy Assessment: $\pm 2.6\%$ ($k=2$)

DASY/EASY - Parameters of Probe: ER3DV6 - SN:2445

Other Probe Parameters

Sensor Arrangement	Rectangular
Connector Angle (°)	44.1
Mechanical Surface Detection Mode	enabled
Optical Surface Detection Mode	disabled
Probe Overall Length	337 mm
Probe Body Diameter	10 mm
Tip Length	10 mm
Tip Diameter	8 mm
Probe Tip to Sensor X Calibration Point	2.5 mm
Probe Tip to Sensor Y Calibration Point	2.5 mm
Probe Tip to Sensor Z Calibration Point	2.5 mm



Appendix D. Photographs of EUT and Setup