



FCC TEST REPORT (15.407)

REPORT NO.: RF131023C25-1
MODEL NO.: 0P6B120
FCC ID: NM80P6B120
RECEIVED: Oct. 23, 2013
TESTED: Nov. 19, 2013 ~ Jan. 03, 2014
ISSUED: Jan. 08, 2014

APPLICANT: HTC Corporation

ADDRESS: No. 23, Xinghua Rd., Taoyuan 330, Taiwan, R.O.C.

ISSUED BY: Bureau Veritas Consumer Products Services
(H.K.) Ltd., Taoyuan Branch

LAB ADDRESS: No. 47, 14th Ling, Chia Pau Vil., Lin Kou Dist.,
New Taipei City, Taiwan (R.O.C)

TEST LOCATION: No. 19, Hwa Ya 2nd Rd, Wen Hwa Tsuen, Kwei
Shan Hsiang, Taoyuan Hsien 333, Taiwan, R.O.C.

This report should not be used by the client to claim product certification, approval, or endorsement by TAF or any government agencies.



This report is for your exclusive use. Any copying or replication of this report to or for any other person or entity, or use of our name or trademark, is permitted only with our prior written permission. This report sets forth our findings solely with respect to the test samples identified herein. The results set forth in this report are not indicative or representative of the quality or characteristics of the lot from which a test sample was taken or any similar or identical product unless specifically and expressly noted. Our report includes all of the tests requested by you and the results thereof based upon the information that you provided to us. You have 60 days from date of issuance of this report to notify us of any material error or omission caused by our negligence, provided, however, that such notice shall be in writing and shall specifically address the issue you wish to raise. A failure to raise such issue within the prescribed time shall constitute your unqualified acceptance of the completeness of this report, the tests conducted and the correctness of the report contents. Unless specific mention, the uncertainty of measurement has been explicitly taken into account to declare the compliance or non-compliance to the specification.



TABLE OF CONTENTS

RELEASE CONTROL RECORD	4
1. CERTIFICATION.....	5
2. SUMMARY OF TEST RESULTS	6
2.1 MEASUREMENT UNCERTAINTY.....	6
3. GENERAL INFORMATION	7
3.1 GENERAL DESCRIPTION OF EUT	7
3.2 DESCRIPTION OF TEST MODES	8
3.2.1 TEST MODE APPLICABILITY AND TESTED CHANNEL DETAIL	10
3.3 DESCRIPTION OF SUPPORT UNITS	13
3.3.1 CONFIGURATION OF SYSTEM UNDER TEST	13
3.4 DUTY CYCLE TEST SIGNAL	14
3.5 GENERAL DESCRIPTION OF APPLIED STANDARDS	18
4. TEST TYPES AND RESULTS	19
4.1 RADIATED EMISSION AND BANDEDGE MEASUREMENT	19
4.1.1 LIMITS OF RADIATED EMISSION AND BANDEDGE MEASUREMENT	19
4.1.2 LIMITS OF UNWANTED EMISSION OUT OF THE RESTRICTED BANDS	19
4.1.3 TEST INSTRUMENTS	20
4.1.4 TEST PROCEDURES	21
4.1.5 DEVIATION FROM TEST STANDARD	21
4.1.6 TEST SETUP	22
4.1.7 EUT OPERATING CONDITIONS	23
4.1.8 TEST RESULTS.....	24
4.2 CONDUCTED EMISSION MEASUREMENT	57
4.2.1 LIMITS OF CONDUCTED EMISSION MEASUREMENT	57
4.2.2 TEST INSTRUMENTS.....	57
4.2.3 TEST PROCEDURES	58
4.2.4 DEVIATION FROM TEST STANDARD	58
4.2.5 TEST SETUP	59
4.2.6 EUT OPERATING CONDITIONS	59
4.2.7 TEST RESULTS.....	60
4.3 PEAK TRANSMIT POWER MEASUREMENT	62
4.3.1 LIMITS OF PEAK TRANSMIT POWER MEASUREMENT	62
4.3.2 TEST SETUP	62
4.3.3 TEST INSTRUMENTS.....	62
4.3.4 TEST PROCEDURE	63
4.3.5 DEVIATION FROM TEST STANDARD	63
4.3.6 EUT OPERATING CONDITIONS	63
4.3.7 TEST RESULTS.....	64
4.4 PEAK POWER SPECTRAL DENSITY MEASUREMENT	68
4.4.1 LIMITS OF PEAK POWER SPECTRAL DENSITY MEASUREMENT	68
4.4.2 TEST SETUP	68
4.4.3 TEST INSTRUMENTS.....	68
4.4.4 TEST PROCEDURES	68
4.4.5 DEVIATION FROM TEST STANDARD	68
4.4.6 EUT OPERATING CONDITIONS	68
4.4.7 TEST RESULTS.....	69
4.5 PEAK POWER EXCURSION MEASUREMENT	72
4.5.1 LIMITS OF POWER SPECTRAL DENSITY MEASUREMENT	72
4.5.2 TEST SETUP	72
4.5.3 TEST INSTRUMENTS.....	72
4.5.4 TEST PROCEDURE	72
4.5.5 DEVIATION FROM TEST STANDARD	72



A D T

4.5.6	EUT OPERATING CONDITION.....	72
4.5.7	TEST RESULTS.....	73
4.6	FREQUENCY STABILITY	74
4.6.1	LIMITS OF FREQUENCY STABILITY MEASUREMENT	74
4.6.2	TEST SETUP	74
4.6.3	TEST INSTRUMENTS	74
4.6.4	TEST PROCEDURE	75
4.6.5	DEVIATION FROM TEST STANDARD	75
4.6.6	EUT OPERATING CONDITION.....	75
4.6.7	TEST RESULTS.....	76
5.	PHOTOGRAPHS OF THE TEST CONFIGURATION.....	77
6.	INFORMATION ON THE TESTING LABORATORIES	78
7.	APPENDIX A - MODIFICATIONS RECORDERS FOR ENGINEERING CHANGES TO THE EUT BY THE LAB	79



A D T

RELEASE CONTROL RECORD

ISSUE NO.	REASON FOR CHANGE	DATE ISSUED
RF131023C25-1	Original release	Jan. 08, 2014



1. CERTIFICATION

PRODUCT: Smartphone
MODEL NO.: 0P6B120
BRAND: HTC
APPLICANT: HTC Corporation
TESTED: Nov. 19, 2013 ~ Jan. 03, 2014
TEST SAMPLE: PRODUCTION UNIT
STANDARDS: **FCC Part 15, Subpart E (Section 15.407)**
ANSI C63.10-2009

The above equipment (model: 0P6B120) has been tested by **Bureau Veritas Consumer Products Services (H.K.) Ltd., Taoyuan Branch**, and found compliance with the requirement of the above standards. The test record, data evaluation & Equipment Under Test (EUT) configurations represented herein are true and accurate accounts of the measurements of the sample's EMC characteristics under the conditions specified in this report.

PREPARED BY : Ivonne Wu , **DATE** : Jan. 08, 2014
Ivonne Wu / Supervisor

APPROVED BY : Sam Chen , **DATE** : Jan. 08, 2014
Sam Chen / Senior Project Engineer

2. SUMMARY OF TEST RESULTS

The EUT has been tested according to the following specifications:

APPLIED STANDARD: FCC PART 15, SUBPART E (SECTION 15.407)			
STANDARD SECTION	TEST TYPE	RESULT	REMARK
15.407(b)(6)	AC Power Conducted Emission	PASS	Meet the requirement of limit. Minimum passing margin is -12.64dB at 13.55859MHz.
15.407(b/1/2/3) (b)(6)	Spurious Emissions	PASS	Meet the requirement of limit. Minimum passing margin is -2.34dB at 5725.00MHz.
15.407(a/1/2)	Peak Transmit Power	PASS	Meet the requirement of limit.
15.407(a)(6)	Peak Power Excursion	PASS	Meet the requirement of limit.
15.407(a/1/2)	Peak Power Spectral Density	PASS	Meet the requirement of limit.
15.407(g)	Frequency Stability	PASS	Meet the requirement of limit.
15.203	Antenna Requirement	PASS	No antenna connector is used.

2.1 MEASUREMENT UNCERTAINTY

Where relevant, the following measurement uncertainty levels have been estimated for tests performed on the EUT as specified in CISPR 16-4-2:

MEASUREMENT	FREQUENCY	UNCERTAINTY
Conducted emissions	9kHz~30MHz	2.44 dB
Radiated emissions	30MHz ~ 200MHz	2.93 dB
	200MHz ~1000MHz	2.95 dB
	1GHz ~ 18GHz	2.26 dB
	18GHz ~ 40GHz	1.94 dB

This uncertainty represents an expanded uncertainty expressed at approximately the 95% confidence level using a coverage factor of $k = 2$.

3. GENERAL INFORMATION

3.1 GENERAL DESCRIPTION OF EUT

EUT	Smartphone
MODEL NO.	0P6B120
POWER SUPPLY	5.0Vdc (adapter or host equipment) 3.8Vdc (Li-ion battery)
MODULATION TYPE	256QAM, 64QAM, 16QAM, QPSK, BPSK
MODULATION TECHNOLOGY	OFDM
TRANSFER RATE	802.11a: 54.0/ 48.0/ 36.0/ 24.0/ 18.0/ 12.0/ 9.0/ 6.0Mbps 802.11n: up to 135Mbps 802.11ac: up to V9
OPERATING FREQUENCY	5180 ~ 5240MHz, 5260 ~ 5320MHz & 5500 ~ 5700MHz
NUMBER OF CHANNEL	5180 ~ 5240MHz: 4 for 802.11a, 802.11n (20MHz) 2 for 802.11n (40MHz) 1 for 802.11ac (80MHz) 5260 ~ 5320MHz: 4 for 802.11a, 802.11n (20MHz) 2 for 802.11n (40MHz) 1 for 802.11ac (80MHz) 5500 ~ 5700MHz: 8 for 802.11a, 802.11n (20MHz) 3 for 802.11n (40MHz) 1 for 802.11ac (80MHz)
OUTPUT POWER	43.251mW for 5180 ~ 5240MHz 52.240mW for 5260 ~ 5320MHz 54.702mW for 5500 ~ 5700MHz
ANTENNA TYPE	PIFA antenna with -3.5dBi gain (5180 ~ 5240MHz) PIFA antenna with -3dBi gain (5260 ~ 5320MHz) PIFA antenna with -3dBi gain (5500 ~ 5700MHz)
ANTENNA CONNECTOR	NA
DATA CABLE	Refer to Note as below
I/O PORTS	Refer to user's manual
ACCESSORY DEVICES	Refer to Note as below

NOTE:

- The EUT's accessories list refers to Ext. Pho.
- There're 2 configurations for the EUT listed as below.
Main Sample (A): Battery 1 + LCD Panel 1
2nd Sample (B): Battery 2 + LCD Panel 2
◇ Only the worst test data was presented in the report.
- The above EUT information is declared by the manufacturer and for more detailed features description, please refer to the manufacturer's specifications or User's Manual.



3.2 DESCRIPTION OF TEST MODES

FOR 5180 ~ 5240MHz

4 channels are provided for 802.11a, 802.11n (20MHz):

CHANNEL	FREQUENCY	CHANNEL	FREQUENCY
36	5180 MHz	44	5220 MHz
40	5200 MHz	48	5240 MHz

2 channels are provided for 802.11n (40MHz):

CHANNEL	FREQUENCY	CHANNEL	FREQUENCY
38	5190 MHz	46	5230 MHz

1 channel is provided for 802.11ac (80MHz):

CHANNEL	FREQUENCY
42	5210 MHz

FOR 5260 ~ 5320MHz

4 channels are provided for 802.11a, 802.11n (20MHz):

CHANNEL	FREQUENCY	CHANNEL	FREQUENCY
52	5260 MHz	60	5300 MHz
56	5280 MHz	64	5320 MHz

2 channels are provided for 802.11n (40MHz):

CHANNEL	FREQUENCY	CHANNEL	FREQUENCY
54	5270 MHz	62	5310 MHz

1 channel is provided for 802.11ac (80MHz):

CHANNEL	FREQUENCY
58	5290MHz



A D T

FOR 5500 ~ 5700MHz

8 channels are provided for 802.11a, 802.11n (20MHz):

CHANNEL	FREQUENCY	CHANNEL	FREQUENCY
100	5500MHz	116	5580MHz
104	5520MHz	132	5660MHz
108	5540MHz	136	5680MHz
112	5560MHz	140	5700MHz

3 channels are provided for 802.11n (40MHz):

CHANNEL	FREQUENCY	CHANNEL	FREQUENCY
102	5510MHz	134	5670MHz
110	5550MHz		

1 channel is provided for 802.11ac (80MHz):

CHANNEL	FREQUENCY
106	5530MHz

3.2.1 TEST MODE APPLICABILITY AND TESTED CHANNEL DETAIL

EUT CONFIGURE MODE	APPLICABLE TO				DESCRIPTION
	RE \geq 1G	RE<1G	PLC	APCM	
A	√	√	√	√	Main sample
B	√	√	-	-	2 nd sample

Where **RE \geq 1G**: Radiated Emission above 1GHz

RE<1G: Radiated Emission below 1GHz

PLC: Power Line Conducted Emission

APCM: Antenna Port Conducted Measurement

NOTE: The EUT had been pre-tested on the positioned of each 3 axis. The worst case was found when positioned on **Z-plane** for mode A and **X-plane** for mode B.

RADIATED EMISSION TEST (ABOVE 1GHz):

- Pre-Scan has been conducted to determine the worst-case mode from all possible combinations between available modulations, data rates and antenna ports (if EUT with antenna diversity architecture).
- Following channel(s) was (were) selected for the final test as listed below.

EUT CONFIGURE MODE	MODE	FREQ. BAND (MHz)	AVAILABLE CHANNEL	TESTED CHANNEL	MODULATION TECHNOLOGY	MODULATION TYPE	DATA RATE (Mbps)
A	802.11a	5180-5240	36 to 48	36, 44, 48	OFDM	BPSK	6.0
	802.11n (20MHz)		36 to 48	36, 44, 48	OFDM	BPSK	6.5
	802.11n (40MHz)		38 to 46	38, 46	OFDM	BPSK	13.5
	802.11ac (80MHz)		42	42	OFDM	BPSK	V0
	802.11a	5260-5320	52 to 64	52, 60, 64	OFDM	BPSK	6.0
	802.11n (20MHz)		52 to 64	52, 60, 64	OFDM	BPSK	6.5
	802.11n (40MHz)		54 to 62	54, 62	OFDM	BPSK	13.5
	802.11ac (80MHz)		58	58	OFDM	BPSK	V0
	802.11a	5500-5700	100 to 140	100, 116, 140	OFDM	BPSK	6.0
	802.11n (20MHz)		100 to 140	100, 116, 140	OFDM	BPSK	6.5
	802.11n (40MHz)		102 to 134	102, 110, 134	OFDM	BPSK	13.5
	802.11ac (80MHz)		106	106	OFDM	BPSK	V0
B	802.11n (20MHz)	5500-5700	100 to 140	140	OFDM	BPSK	6.5

RADIATED EMISSION TEST (BELOW 1GHz):

- Pre-Scan has been conducted to determine the worst-case mode from all possible combinations between available modulations, data rates and antenna ports (if EUT with antenna diversity architecture).
- Following channel(s) was (were) selected for the final test as listed below.

EUT CONFIGURE MODE	MODE	FREQ. BAND (MHz)	AVAILABLE CHANNEL	TESTED CHANNEL	MODULATION TECHNOLOGY	MODULATION TYPE	DATA RATE (Mbps)
A	802.11n (20MHz)	5180-5240	36 to 48	36	OFDM	BPSK	6.5
		5260-5320	52 to 64	64	OFDM	BPSK	6.5
		5500-5700	100 to 140	140	OFDM	BPSK	6.5
B	802.11n (20MHz)	5500-5700	100 to 140	140	OFDM	BPSK	6.5



A D T

POWER LINE CONDUCTED EMISSION TEST:

EUT CONFIGURE MODE	MODE	FREQ. BAND (MHz)	AVAILABLE CHANNEL	TESTED CHANNEL	MODULATION TECHNOLOGY	MODULATION TYPE	DATA RATE (Mbps)
A	802.11n (20MHz)	5500-5700	100 to 140	140	OFDM	BPSK	6.5

BANDEDGE MEASUREMENT:

- Pre-Scan has been conducted to determine the worst-case mode from all possible combinations between available modulations, data rates and antenna ports (if EUT with antenna diversity architecture).
- Following channel(s) was (were) selected for the final test as listed below.

EUT CONFIGURE MODE	MODE	FREQ. BAND (MHz)	AVAILABLE CHANNEL	TESTED CHANNEL	MODULATION TECHNOLOGY	MODULATION TYPE	DATA RATE (Mbps)
A	802.11a	5180-5240	36 to 48	36, 48	OFDM	BPSK	6.0
	802.11n (20MHz)		36 to 48	36, 48	OFDM	BPSK	6.5
	802.11n (40MHz)		38 to 46	38, 46	OFDM	BPSK	13.5
	802.11ac (80MHz)		42	42	OFDM	BPSK	V0
	802.11a	5260-5320	52 to 64	52, 64	OFDM	BPSK	6.0
	802.11n (20MHz)		52 to 64	52, 64	OFDM	BPSK	6.5
	802.11n (40MHz)		54 to 62	54, 62	OFDM	BPSK	13.5
	802.11ac (80MHz)		58	58	OFDM	BPSK	V0
	802.11a	5500-5700	100 to 140	100, 140	OFDM	BPSK	6.0
	802.11n (20MHz)		100 to 140	100, 140	OFDM	BPSK	6.5
	802.11n (40MHz)		102 to 134	102, 134	OFDM	BPSK	13.5
	802.11ac (80MHz)		106	106	OFDM	BPSK	V0



ANTENNA PORT CONDUCTED MEASUREMENT:

- This item includes all test value of each mode, but only includes spectrum plot of worst value of each mode.
- Pre-Scan has been conducted to determine the worst-case mode from all possible combinations between available modulations, data rates and antenna ports (if EUT with antenna diversity architecture).
- Following channel(s) was (were) selected for the final test as listed below.

EUT CONFIGURE MODE	MODE	FREQ. BAND (MHz)	AVAILABLE CHANNEL	TESTED CHANNEL	MODULATION TECHNOLOGY	MODULATION TYPE	DATA RATE (Mbps)
A	802.11a	5180-5240	36 to 48	36, 44, 48	OFDM	BPSK	6.0
	802.11n (20MHz)		36 to 48	36, 44, 48	OFDM	BPSK	6.5
	802.11n (40MHz)		38 to 46	38, 46	OFDM	BPSK	13.5
	802.11ac (80MHz)		42	42	OFDM	BPSK	V0
	802.11a	5260-5320	52 to 64	52, 60, 64	OFDM	BPSK	6.0
	802.11n (20MHz)		52 to 64	52, 60, 64	OFDM	BPSK	6.5
	802.11n (40MHz)		54 to 62	54, 62	OFDM	BPSK	13.5
	802.11ac (80MHz)		58	58	OFDM	BPSK	V0
	802.11a	5500-5700	100 to 140	100, 116, 140	OFDM	BPSK	6.0
	802.11n (20MHz)		100 to 140	100, 116, 140	OFDM	BPSK	6.5
	802.11n (40MHz)		102 to 134	102, 110, 134	OFDM	BPSK	13.5
	802.11ac (80MHz)		106	106	OFDM	BPSK	V0

TEST CONDITION:

APPLICABLE TO	ENVIRONMENTAL CONDITIONS	INPUT POWER	TESTED BY
RE≥1G	25deg. C, 65%RH	120Vac, 60Hz	Johnson Liao
RE<1G	25deg. C, 65%RH	120Vac, 60Hz	Johnson Liao
PLC	25deg. C, 65%RH	120Vac, 60Hz	Johnson Liao
APCM	25deg. C, 65%RH	120Vac, 60Hz	Demon Lin

3.3 DESCRIPTION OF SUPPORT UNITS

The EUT has been tested as an independent unit together with other necessary accessories or support units.

3.3.1 CONFIGURATION OF SYSTEM UNDER TEST

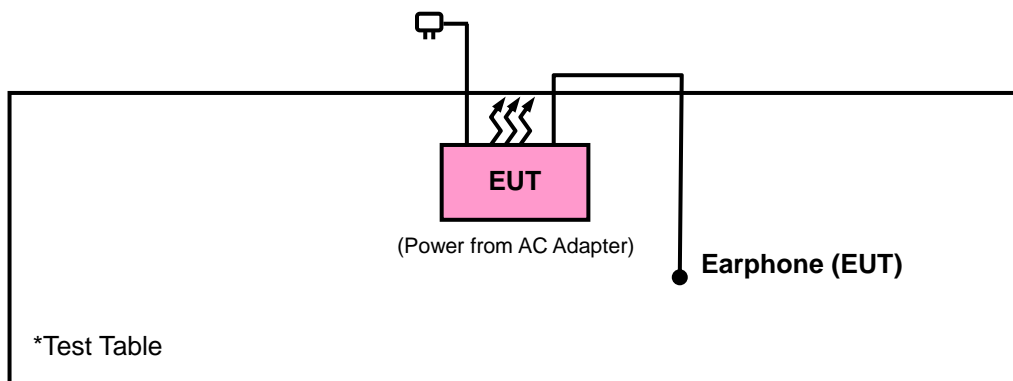



A D T

3.4 DUTY CYCLE TEST SIGNAL

MODULATION TYPE: BPSK

If duty cycle is < 98%, duty factor shall be considered.

802.11a: Duty cycle = $1.354/1.571 = 0.862$, Duty factor = $10 * \log(1/0.862) = 0.64$

802.11n (20MHz): Duty cycle = $1.258/1.474 = 0.853$, Duty factor = $10 * \log(1/0.853) = 0.69$

802.11n (40MHz): Duty cycle = $634.62/839.74 = 0.755$, Duty factor = $10 * \log(1/0.755) = 1.22$

802.11ac (80MHz): Duty cycle = $248.40/450.32 = 0.552$, Duty factor = $10 * \log(1/0.552) = 2.58$

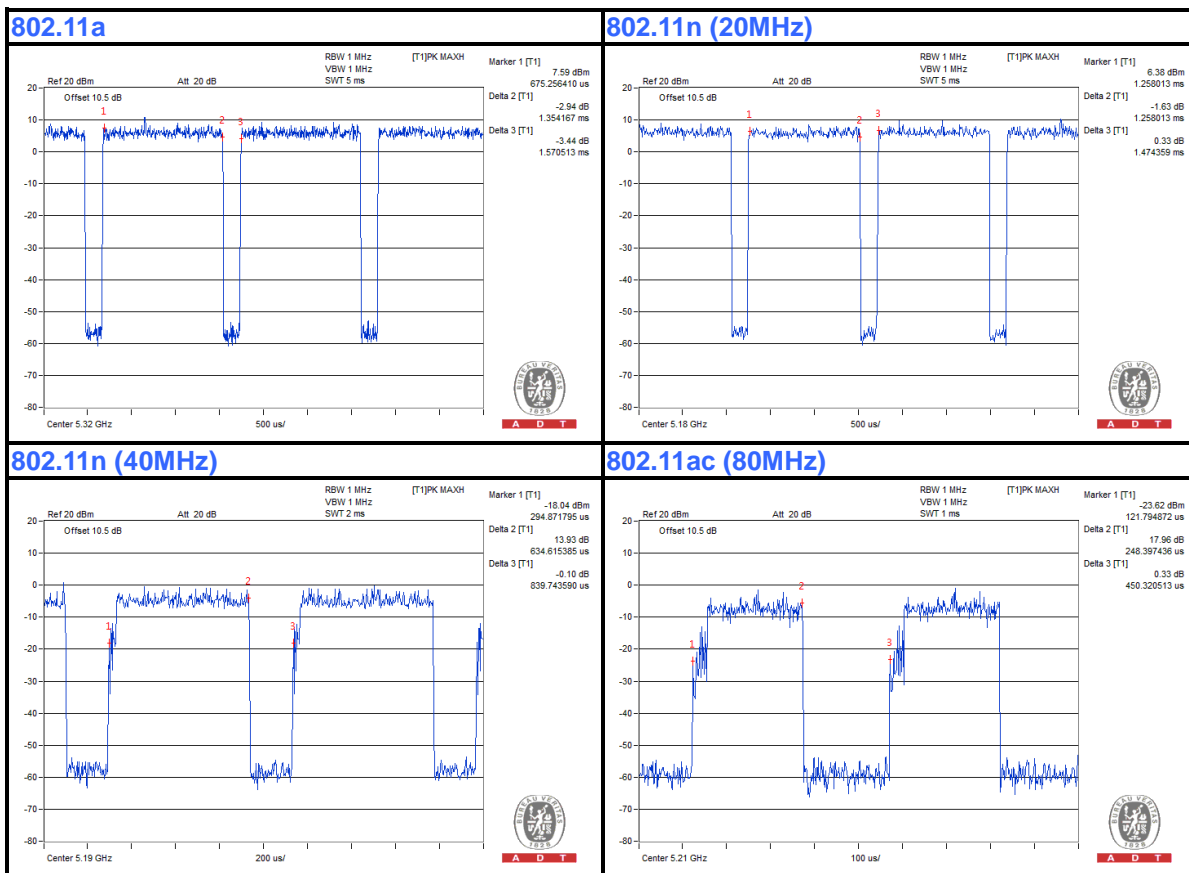



A D T

MODULATION TYPE: QPSK

If duty cycle is < 98%, duty factor shall be considered.

802.11a: Duty cycle = $680.51/895.25 = 0.760$, Duty factor = $10 * \log(1/0.760) = 1.19$

802.11n (20MHz): Duty cycle = $649.04/860.58 = 0.754$, Duty factor = $10 * \log(1/0.754) = 1.23$

802.11n (40MHz): Duty cycle = $339.74/538.46 = 0.631$, Duty factor = $10 * \log(1/0.631) = 2.00$

802.11ac (80MHz): Duty cycle = $144.23/344.55 = 0.419$, Duty factor = $10 * \log(1/0.419) = 3.78$

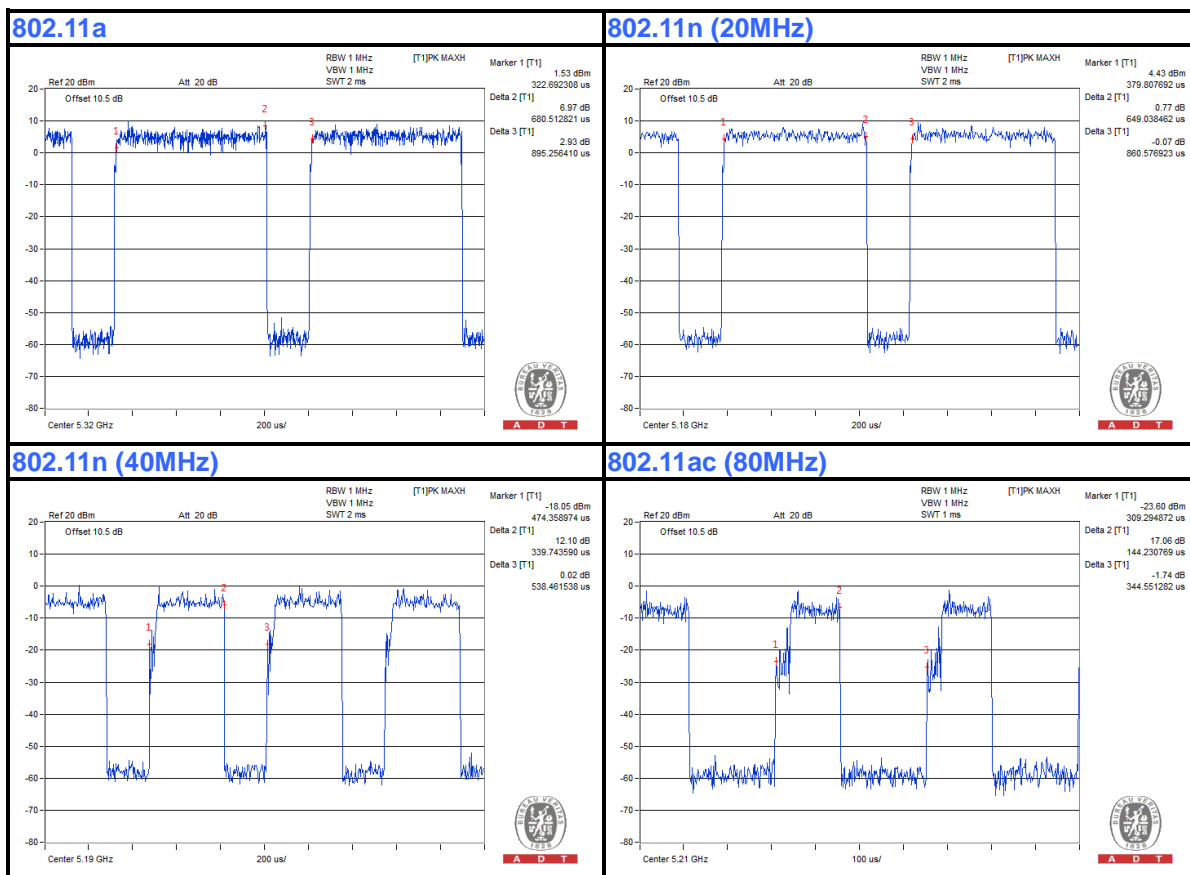



A D T

MODULATION TYPE: 16QAM

If duty cycle is < 98%, duty factor shall be considered.

802.11a: Duty cycle = 347.18/555.51 = 0.625, Duty factor = 10 * log(1/0.625) = 2.04

802.11n (20MHz): Duty cycle = 341.35/549.68 = 0.621, Duty factor = 10 * log(1/0.621) = 2.07

802.11n (40MHz): Duty cycle = 189.10/387.82 = 0.488, Duty factor = 10 * log(1/0.488) = 3.12

802.11ac (80MHz): Duty cycle = 94.55/293.27 = 0.322, Duty factor = 10 * log(1/0.322) = 4.92

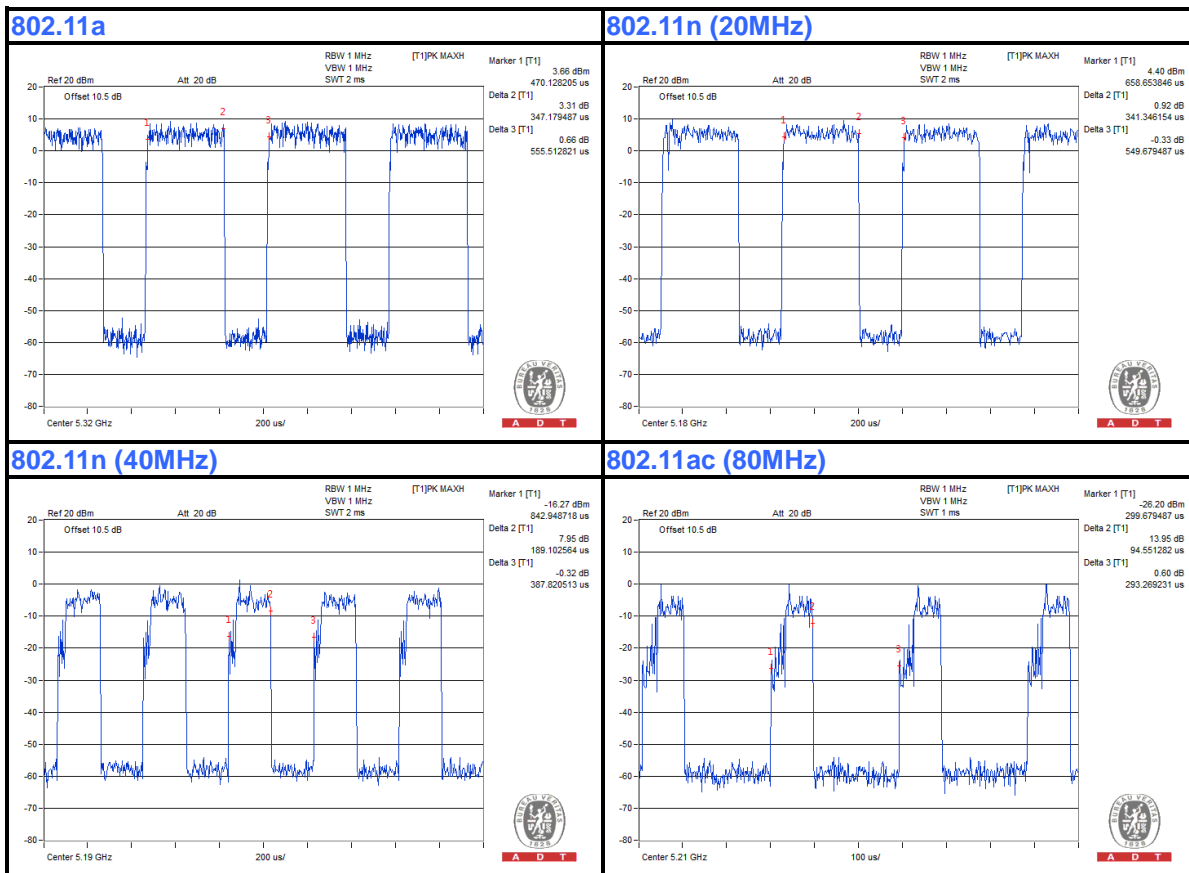



A D T

MODULATION TYPE: 64QAM

If duty cycle is < 98%, duty factor shall be considered.

802.11a: Duty cycle = $177.31/388.85 = 0.456$, Duty factor = $10 * \log(1/0.456) = 3.41$

802.11n (20MHz): Duty cycle = $181.09/389.42 = 0.465$, Duty factor = $10 * \log(1/0.465) = 3.33$

802.11n (40MHz): Duty cycle = $113.78/314.10 = 0.362$, Duty factor = $10 * \log(1/0.362) = 4.41$

802.11ac (80MHz): Duty cycle = $70.51/269.23 = 0.262$, Duty factor = $10 * \log(1/0.262) = 5.82$

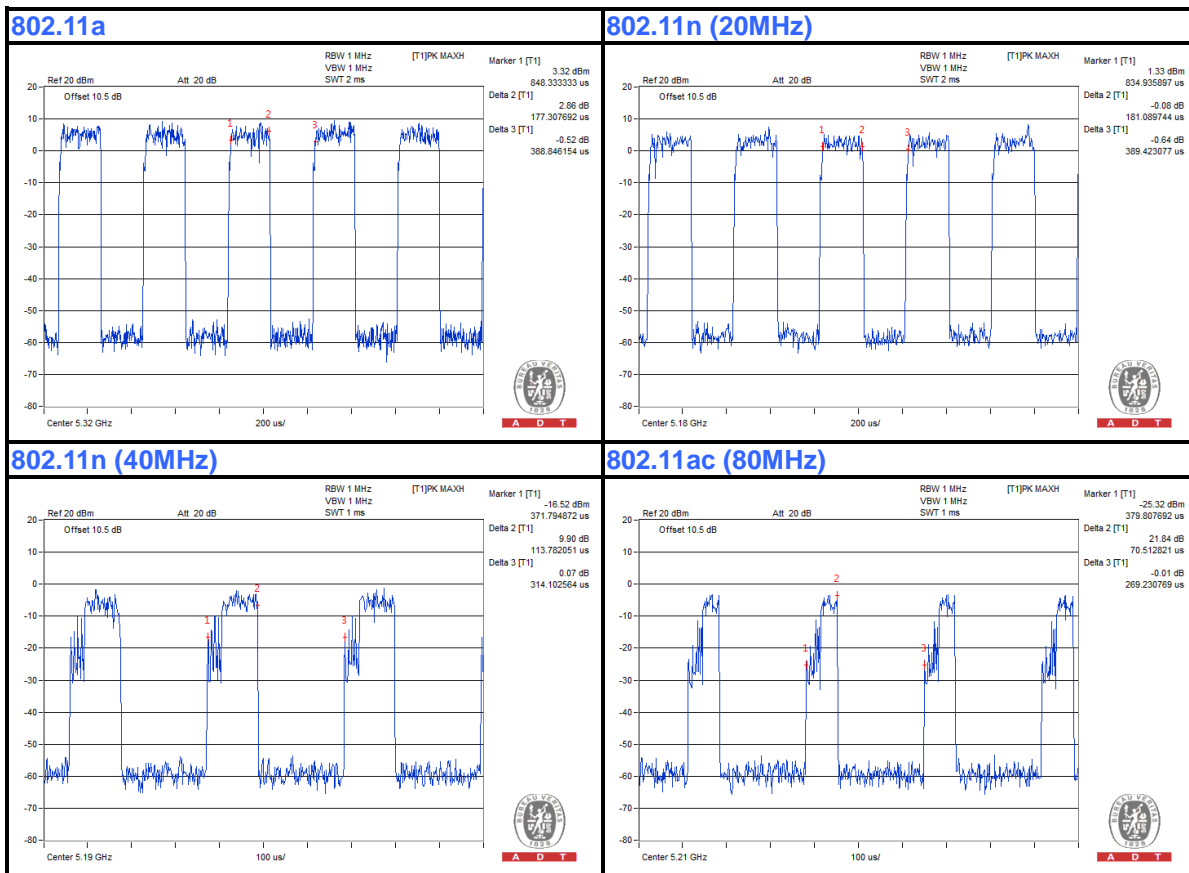

MODULATION TYPE: 256QAM

If duty cycle is < 98%, duty factor shall be considered.

802.11ac (80MHz): Duty cycle = $57.69/259.61 = 0.222$, Duty factor = $10 * \log(1/0.222) = 6.53$

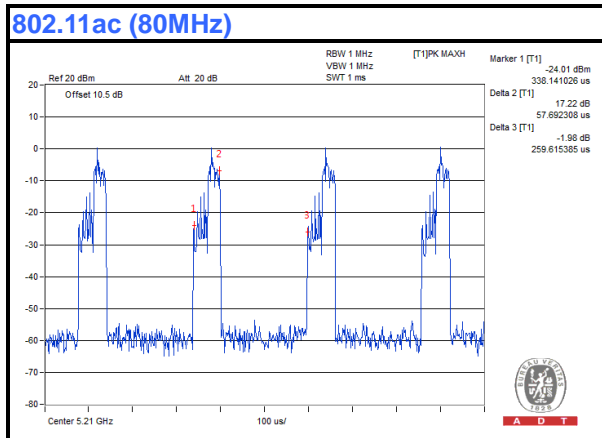

3.5 GENERAL DESCRIPTION OF APPLIED STANDARDS

The EUT is a RF Product. According to the specifications of the manufacturer, it must comply with the requirements of the following standards:

FCC Part 15, Subpart E (15.407)

ANSI C63.10-2009

KDB 789033 D01 General UNII Test Procedures v01r03

All test items have been performed and recorded as per the above standards.

NOTE: The EUT is also considered as a kind of computer peripheral, because the connection to computer is necessary for typical use. It has been verified to comply with the requirements of FCC Part 15, Subpart B, Class B (DoC). The test report has been issued separately.

4. TEST TYPES AND RESULTS

4.1 RADIATED EMISSION AND BANDEDGE MEASUREMENT

4.1.1 LIMITS OF RADIATED EMISSION AND BANDEDGE MEASUREMENT

Radiated emissions which fall in the restricted bands must comply with the radiated emission limits specified as below table:

FREQUENCIES (MHz)	FIELD STRENGTH (microvolts/meter)	MEASUREMENT DISTANCE (meters)
0.009 ~ 0.490	2400/F(kHz)	300
0.490 ~ 1.705	24000/F(kHz)	30
1.705 ~ 30.0	30	30
30 ~ 88	100	3
88 ~ 216	150	3
216 ~ 960	200	3
Above 960	500	3

NOTE:

1. The lower limit shall apply at the transition frequencies.
2. Emission level (dBuV/m) = 20 log Emission level (uV/m).
3. For frequencies above 1000MHz, the field strength limits are based on average detector, however, the peak field strength of any emission shall not exceed the maximum permitted average limits, specified above by more than 20dB under any condition of modulation.

4.1.2 LIMITS OF UNWANTED EMISSION OUT OF THE RESTRICTED BANDS

APPLICABLE TO	LIMIT	
	FIELD STRENGTH AT 3m (dBµV/m)	
	PK	AV
	74	54
√	EIRP LIMIT (dBm)	EQUIVALENT FIELD STRENGTH AT 3m (dBµV/m)
	PK	PK
	-27	68.3

NOTE: The following formula is used to convert the equipment isotropic radiated power (eirp) to field strength:

$$E = \frac{1000000 \sqrt{30P}}{3} \mu\text{V/m, where } P \text{ is the eirp (Watts).}$$



A D T

4.1.3 TEST INSTRUMENTS

DESCRIPTION & MANUFACTURER	MODEL NO.	SERIAL NO.	DATE OF CALIBRATION	DUE DATE OF CALIBRATION
Test Receiver ROHDE & SCHWARZ	ESCI	100744	Apr. 15, 2013	Apr. 14, 2014
Spectrum Analyzer ROHDE & SCHWARZ	FSU-26	101645	Jul. 16, 2013	Jul. 15, 2014
BILOG Antenna SCHWARZBECK	VULB9168	9168-472	Mar. 25, 2013	Mar. 24, 2014
HORN Antenna SCHWARZBECK	BBHA 9120 D	9120D-969	Jan. 07, 2013	Jan. 06, 2014
HORN Antenna SCHWARZBECK	BBHA 9170	9170-480	Jan. 07, 2013	Jan. 06, 2014
Loop Antenna	HFH2-Z2	100070	Jan. 31, 2012	Jan. 30, 2014
Preamplifier EMCI	EMC 330H	980112	Dec. 28, 2012	Dec. 26, 2014
RF signal cable HUBER+SUHNNER	SUCOFLEX 104	309219/4	Oct. 18, 2013	Oct. 17, 2014
RF signal cable HUBER+SUHNNER	SUCOFLEX 104	250130/4	Oct. 18, 2013	Oct. 17, 2014
RF signal cable Worken	RG-213	NA	Nov. 07, 2013	Nov. 06, 2014
Software BV ADT	E3 6.120103	NA	NA	NA
Antenna Tower MF	MFA-440H	NA	NA	NA
Turn Table MF	MFT-201SS	NA	NA	NA
Antenna Tower & Turn Table Controller MF	MF-7802	NA	NA	NA
Power Meter	ML2495A	1232002	Aug. 23, 2013	Aug. 22, 2014
Power Sensor	MA2411B	1207325	Aug. 23, 2013	Aug. 22, 2014

- NOTE:** 1. The calibration interval of the above test instruments is 12 months and the calibrations are traceable to NML/ROC and NIST/USA.
2. The calibration interval of the loop antenna is 24 months and the calibrations are traceable to NML/ROC and NIST/USA.
3. The test was performed in HwaYa Chamber 10.
4. The horn antenna and HP preamplifier (model: 8449B) are used only for the measurement of emission frequency above 1GHz if tested.
5. The FCC Site Registration No. is 690701.
6. The IC Site Registration No. is IC 7450F-10.

4.1.4 TEST PROCEDURES

- a. The EUT was placed on the top of a rotating table 0.8 meters above the ground at a 3 meters semi-anechoic chamber. The table was rotated 360 degrees to determine the position of the highest radiation.
- b. The EUT was set 3 meters away from the interference-receiving antenna, which was mounted on the top of a variable-height antenna tower.
- c. The antenna is a broadband antenna, and its height is varied from one meter to four meters above the ground to determine the maximum value of the field strength. Both horizontal and vertical polarizations of the antenna are set to make the measurement.
- d. For each suspected emission, the EUT was arranged to its worst case and then the antenna was tuned to heights from 1 meter to 4 meters and the rotatable table was turned from 0 degrees to 360 degrees to find the maximum reading.
- e. The test-receiver system was set to Peak Detect Function and Specified Bandwidth with Maximum Hold Mode.
- f. If the emission level of the EUT in peak mode was 10dB lower than the limit specified, then testing could be stopped and the peak values of the EUT would be reported. Otherwise the emissions that did not have 10dB margin would be re-tested one by one using peak, quasi-peak or average method as specified and then reported in a data sheet.

NOTE:

1. The resolution bandwidth and video bandwidth of test receiver/spectrum analyzer is 120kHz for Peak detection (PK) and Quasi-peak detection (QP) at frequency below 1GHz.
2. The resolution bandwidth of test receiver/spectrum analyzer is 1MHz and video bandwidth is 3MHz for Peak detection at frequency above 1GHz.
3. The resolution bandwidth of test receiver/spectrum analyzer is 1MHz and the video bandwidth is 1kHz (Duty cycle < 98%) or 10Hz (Duty cycle > 98%) for Average detection (AV) at frequency above 1GHz.
4. All modes of operation were investigated and the worst-case emissions are reported.

4.1.5 DEVIATION FROM TEST STANDARD

No deviation.

4.1.6 TEST SETUP

Frequency Range 30MHz ~ 1GHz

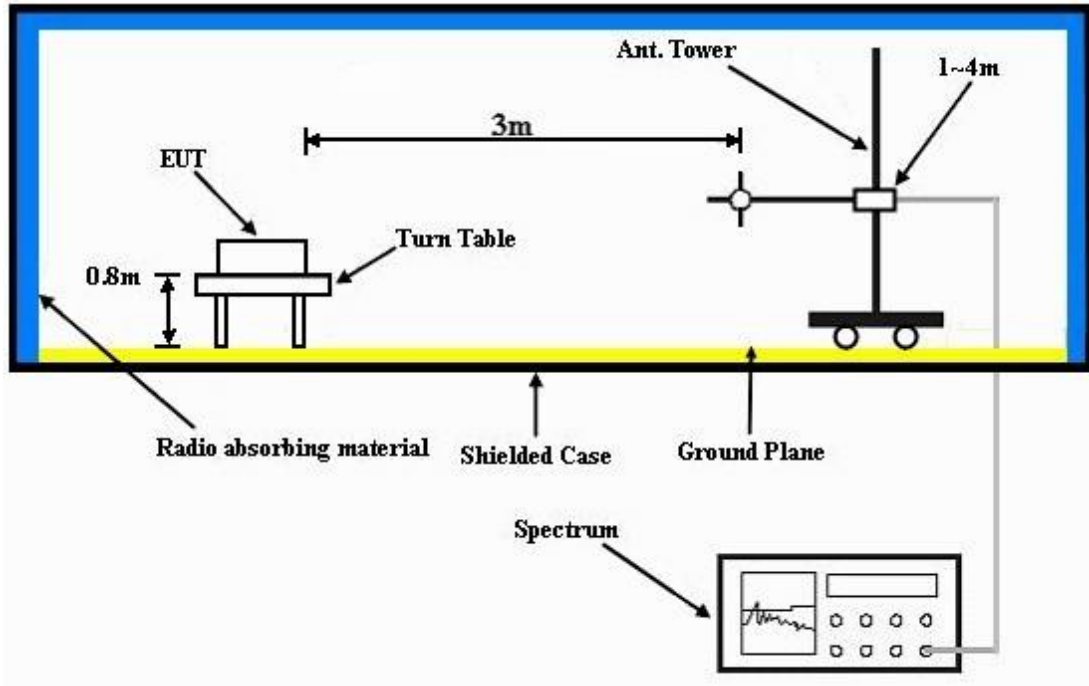

Frequency Range above 1GHz

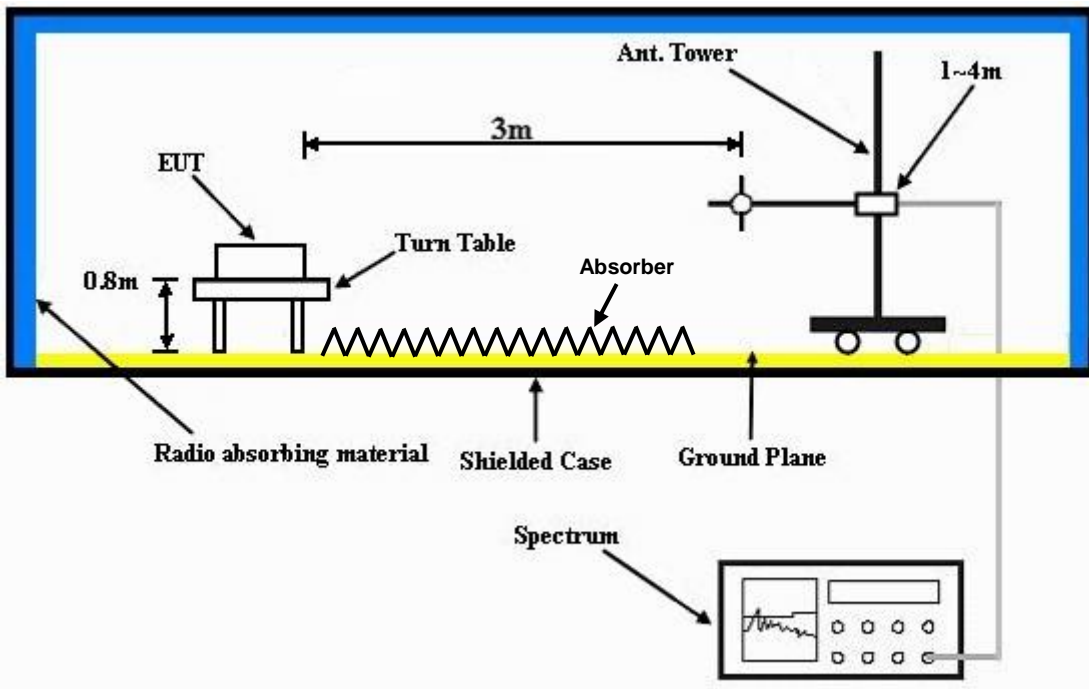

For the actual test configuration, please refer to the attached file (Test Setup Photo).



A D T

4.1.7 EUT OPERATING CONDITIONS

- a. Placed the EUT on a testing table.
- b. Use the software to control the EUT under transmission condition continuously at specific channel frequency.



A D T

4.1.8 TEST RESULTS

ABOVE 1GHz WORST-CASE DATA

TEST MODE A

802.11a

EUT TEST CONDITION		MEASUREMENT DETAIL	
CHANNEL	Channel 36	FREQUENCY RANGE	1GHz ~ 40GHz
INPUT POWER (SYSTEM)	120Vac, 60 Hz	DETECTOR FUNCTION	Peak (PK) Average (AV)
ENVIRONMENTAL CONDITIONS	25deg. C, 65%RH	TESTED BY	Johnson Liao

ANTENNA POLARITY & TEST DISTANCE: HORIZONTAL AT 3 M										
FREQ. (MHz)	EMISSION LEVEL (dBuV/m)	READ LEVEL (dBuV)	LIMIT (dBuV/m)	MARGIN (dB)	ANTENNA FACTOR (dB/m)	CABLE LOSS (dB)	PREAMP FACTOR (dB)	ANTENNA HEIGHT (cm)	TABLE ANGLE (Degree)	REMARK
5148	40.12	40.83	54	-13.88	31.32	5.29	37.32	102	309	Average
5148	58.17	58.88	74	-15.83	31.32	5.29	37.32	102	309	Peak
5180	91.27	91.95			31.35	5.31	37.34	102	309	Average
5180	100.47	101.15			31.35	5.31	37.34	102	309	Peak
5356	37.55	37.86	54	-16.45	31.48	5.39	37.18	102	309	Average
5356	54.17	54.48	74	-19.83	31.48	5.39	37.18	102	309	Peak
ANTENNA POLARITY & TEST DISTANCE: VERTICAL AT 3 M										
FREQ. (MHz)	EMISSION LEVEL (dBuV/m)	READ LEVEL (dBuV)	LIMIT (dBuV/m)	MARGIN (dB)	ANTENNA FACTOR (dB/m)	CABLE LOSS (dB)	PREAMP FACTOR (dB)	ANTENNA HEIGHT (cm)	TABLE ANGLE (Degree)	REMARK
5150	41.82	42.53	54	-12.18	31.32	5.29	37.32	100	48	Average
5150	61.18	61.89	74	-12.82	31.32	5.29	37.32	100	48	Peak
5180	94.71	95.39			31.35	5.31	37.34	100	48	Average
5180	103.47	104.15			31.35	5.31	37.34	100	48	Peak
5396	37.58	37.83	54	-16.42	31.52	5.41	37.18	100	48	Average
5396	53.02	53.27	74	-20.98	31.52	5.41	37.18	100	48	Peak

REMARKS:

- Emission Level = Read Level + Antenna Factor + Cable Loss - Preamp Factor
Margin value = Emission level – Limit value
- 5180MHz: Fundamental frequency.



A D T

EUT TEST CONDITION		MEASUREMENT DETAIL	
CHANNEL	Channel 44	FREQUENCY RANGE	1GHz ~ 40GHz
INPUT POWER (SYSTEM)	120Vac, 60 Hz	DETECTOR FUNCTION	Peak (PK) Average (AV)
ENVIRONMENTAL CONDITIONS	25deg. C, 65%RH	TESTED BY	Johnson Liao

ANTENNA POLARITY & TEST DISTANCE: HORIZONTAL AT 3 M										
FREQ. (MHz)	EMISSION LEVEL (dBuV/m)	READ LEVEL (dBuV)	LIMIT (dBuV/m)	MARGIN (dB)	ANTENNA FACTOR (dB/m)	CABLE LOSS (dB)	PREAMP FACTOR (dB)	ANTENNA HEIGHT (cm)	TABLE ANGLE (Degree)	REMARK
5020	37.49	38.28	54	-16.51	31.21	5.24	37.24	100	310	Average
5020	55.32	56.11	74	-18.68	31.21	5.24	37.24	100	310	Peak
5220	93.52	94.18			31.37	5.33	37.36	100	310	Average
5220	103.21	103.87			31.37	5.33	37.36	100	310	Peak
5430	37.78	37.94	54	-16.22	31.55	5.42	37.13	100	310	Average
5430	56.67	56.83	74	-17.33	31.55	5.42	37.13	100	310	Peak
ANTENNA POLARITY & TEST DISTANCE: VERTICAL AT 3 M										
FREQ. (MHz)	EMISSION LEVEL (dBuV/m)	READ LEVEL (dBuV)	LIMIT (dBuV/m)	MARGIN (dB)	ANTENNA FACTOR (dB/m)	CABLE LOSS (dB)	PREAMP FACTOR (dB)	ANTENNA HEIGHT (cm)	TABLE ANGLE (Degree)	REMARK
5098	37.75	38.48	54	-16.25	31.28	5.27	37.28	100	47	Average
5098	55.16	55.89	74	-18.84	31.28	5.27	37.28	100	47	Peak
5220	95.22	95.88			31.37	5.33	37.36	100	47	Average
5220	104.24	104.9			31.37	5.33	37.36	100	47	Peak
5402	37.74	37.99	54	-16.26	31.52	5.41	37.18	100	47	Average
5402	54.84	55.09	74	-19.16	31.52	5.41	37.18	100	47	Peak

REMARKS:

- Emission Level = Read Level + Antenna Factor + Cable Loss - Preamp Factor
Margin value = Emission level – Limit value
- 5220MHz: Fundamental frequency.



A D T

EUT TEST CONDITION		MEASUREMENT DETAIL	
CHANNEL	Channel 48	FREQUENCY RANGE	1GHz ~ 40GHz
INPUT POWER (SYSTEM)	120Vac, 60 Hz	DETECTOR FUNCTION	Peak (PK) Average (AV)
ENVIRONMENTAL CONDITIONS	25deg. C, 65%RH	TESTED BY	Johnson Liao

ANTENNA POLARITY & TEST DISTANCE: HORIZONTAL AT 3 M										
FREQ. (MHz)	EMISSION LEVEL (dBuV/m)	READ LEVEL (dBuV)	LIMIT (dBuV/m)	MARGIN (dB)	ANTENNA FACTOR (dB/m)	CABLE LOSS (dB)	PREAMP FACTOR (dB)	ANTENNA HEIGHT (cm)	TABLE ANGLE (Degree)	REMARK
5014	37.6	38.38	54	-16.4	31.21	5.24	37.23	100	311	Average
5014	55.53	56.31	74	-18.47	31.21	5.24	37.23	100	311	Peak
5240	92.99	93.58			31.39	5.34	37.32	100	311	Average
5240	103.6	104.19			31.39	5.34	37.32	100	311	Peak
5352	37.76	38.07	54	-16.24	31.48	5.39	37.18	100	311	Average
5352	55.1	55.41	74	-18.9	31.48	5.39	37.18	100	311	Peak
ANTENNA POLARITY & TEST DISTANCE: VERTICAL AT 3 M										
FREQ. (MHz)	EMISSION LEVEL (dBuV/m)	READ LEVEL (dBuV)	LIMIT (dBuV/m)	MARGIN (dB)	ANTENNA FACTOR (dB/m)	CABLE LOSS (dB)	PREAMP FACTOR (dB)	ANTENNA HEIGHT (cm)	TABLE ANGLE (Degree)	REMARK
5052	37.76	38.52	54	-16.24	31.24	5.25	37.25	100	46	Average
5052	55.08	55.84	74	-18.92	31.24	5.25	37.25	100	46	Peak
5240	95.43	96.02			31.39	5.34	37.32	100	46	Average
5240	105	105.59			31.39	5.34	37.32	100	46	Peak
5410	37.67	37.92	54	-16.33	31.52	5.41	37.18	100	46	Average
5410	55.27	55.52	74	-18.73	31.52	5.41	37.18	100	46	Peak

REMARKS:

- Emission Level = Read Level + Antenna Factor + Cable Loss - Preamp Factor
Margin value = Emission level – Limit value
- 5240MHz: Fundamental frequency.



A D T

EUT TEST CONDITION		MEASUREMENT DETAIL	
CHANNEL	Channel 52	FREQUENCY RANGE	1GHz ~ 40GHz
INPUT POWER (SYSTEM)	120Vac, 60 Hz	DETECTOR FUNCTION	Peak (PK) Average (AV)
ENVIRONMENTAL CONDITIONS	25deg. C, 65%RH	TESTED BY	Johnson Liao

ANTENNA POLARITY & TEST DISTANCE: HORIZONTAL AT 3 M										
FREQ. (MHz)	EMISSION LEVEL (dBuV/m)	READ LEVEL (dBuV)	LIMIT (dBuV/m)	MARGIN (dB)	ANTENNA FACTOR (dB/m)	CABLE LOSS (dB)	PREAMP FACTOR (dB)	ANTENNA HEIGHT (cm)	TABLE ANGLE (Degree)	REMARK
5142	37.63	38.32	54	-16.37	31.32	5.29	37.3	100	308	Average
5142	55.41	56.1	74	-18.59	31.32	5.29	37.3	100	308	Peak
5260	92.68	93.2			31.41	5.34	37.27	100	308	Average
5260	101.89	102.41			31.41	5.34	37.27	100	308	Peak
5420	37.85	38.08	54	-16.15	31.53	5.42	37.18	100	308	Average
5420	55.57	55.8	74	-18.43	31.53	5.42	37.18	100	308	Peak
ANTENNA POLARITY & TEST DISTANCE: VERTICAL AT 3 M										
FREQ. (MHz)	EMISSION LEVEL (dBuV/m)	READ LEVEL (dBuV)	LIMIT (dBuV/m)	MARGIN (dB)	ANTENNA FACTOR (dB/m)	CABLE LOSS (dB)	PREAMP FACTOR (dB)	ANTENNA HEIGHT (cm)	TABLE ANGLE (Degree)	REMARK
5018	37.18	37.97	54	-16.82	31.21	5.24	37.24	119	47	Average
5018	55.79	56.58	74	-18.21	31.21	5.24	37.24	119	47	Peak
5260	95.56	96.08			31.41	5.34	37.27	119	47	Average
5260	104.43	104.95			31.41	5.34	37.27	119	47	Peak
5446	37.74	37.87	54	-16.26	31.56	5.44	37.13	119	47	Average
5446	57.45	57.58	74	-16.55	31.56	5.44	37.13	119	47	Peak

REMARKS:

- Emission Level = Read Level + Antenna Factor + Cable Loss - Preamp Factor
Margin value = Emission level – Limit value
- 5260MHz: Fundamental frequency.



A D T

EUT TEST CONDITION		MEASUREMENT DETAIL	
CHANNEL	Channel 60	FREQUENCY RANGE	1GHz ~ 40GHz
INPUT POWER (SYSTEM)	120Vac, 60 Hz	DETECTOR FUNCTION	Peak (PK) Average (AV)
ENVIRONMENTAL CONDITIONS	25deg. C, 65%RH	TESTED BY	Johnson Liao

ANTENNA POLARITY & TEST DISTANCE: HORIZONTAL AT 3 M										
FREQ. (MHz)	EMISSION LEVEL (dBuV/m)	READ LEVEL (dBuV)	LIMIT (dBuV/m)	MARGIN (dB)	ANTENNA FACTOR (dB/m)	CABLE LOSS (dB)	PREAMP FACTOR (dB)	ANTENNA HEIGHT (cm)	TABLE ANGLE (Degree)	REMARK
5024	37.48	38.25	54	-16.52	31.23	5.24	37.24	100	306	Average
5024	54.79	55.56	74	-19.21	31.23	5.24	37.24	100	306	Peak
5300	93	93.38			31.44	5.37	37.19	100	306	Average
5300	102.21	102.59			31.44	5.37	37.19	100	306	Peak
5352	40.85	41.16	54	-13.15	31.48	5.39	37.18	100	306	Average
5352	56.8	57.11	74	-17.2	31.48	5.39	37.18	100	306	Peak
ANTENNA POLARITY & TEST DISTANCE: VERTICAL AT 3 M										
FREQ. (MHz)	EMISSION LEVEL (dBuV/m)	READ LEVEL (dBuV)	LIMIT (dBuV/m)	MARGIN (dB)	ANTENNA FACTOR (dB/m)	CABLE LOSS (dB)	PREAMP FACTOR (dB)	ANTENNA HEIGHT (cm)	TABLE ANGLE (Degree)	REMARK
5120	37.77	38.5	54	-16.23	31.29	5.28	37.3	109	41	Average
5120	55.12	55.85	74	-18.88	31.29	5.28	37.3	109	41	Peak
5300	95.2	95.58			31.44	5.37	37.19	109	41	Average
5300	104.36	104.74			31.44	5.37	37.19	109	41	Peak
5452	41.64	41.72	54	-12.36	31.56	5.44	37.08	109	41	Average
5452	56.15	56.23	74	-17.85	31.56	5.44	37.08	109	41	Peak

REMARKS:

- Emission Level = Read Level + Antenna Factor + Cable Loss - Preamp Factor
Margin value = Emission level – Limit value
- 5300MHz: Fundamental frequency.



A D T

EUT TEST CONDITION		MEASUREMENT DETAIL	
CHANNEL	Channel 64	FREQUENCY RANGE	1GHz ~ 40GHz
INPUT POWER (SYSTEM)	120Vac, 60 Hz	DETECTOR FUNCTION	Peak (PK) Average (AV)
ENVIRONMENTAL CONDITIONS	25deg. C, 65%RH	TESTED BY	Johnson Liao

ANTENNA POLARITY & TEST DISTANCE: HORIZONTAL AT 3 M										
FREQ. (MHz)	EMISSION LEVEL (dBuV/m)	READ LEVEL (dBuV)	LIMIT (dBuV/m)	MARGIN (dB)	ANTENNA FACTOR (dB/m)	CABLE LOSS (dB)	PREAMP FACTOR (dB)	ANTENNA HEIGHT (cm)	TABLE ANGLE (Degree)	REMARK
5056	37.51	38.26	54	-16.49	31.25	5.25	37.25	100	305	Average
5056	55	55.75	74	-19	31.25	5.25	37.25	100	305	Peak
5320	94.04	94.4			31.45	5.38	37.19	100	305	Average
5320	102.66	103.02			31.45	5.38	37.19	100	305	Peak
5348	42.04	42.35	54	-11.96	31.48	5.39	37.18	100	305	Average
5348	57.69	58	74	-16.31	31.48	5.39	37.18	100	305	Peak
ANTENNA POLARITY & TEST DISTANCE: VERTICAL AT 3 M										
FREQ. (MHz)	EMISSION LEVEL (dBuV/m)	READ LEVEL (dBuV)	LIMIT (dBuV/m)	MARGIN (dB)	ANTENNA FACTOR (dB/m)	CABLE LOSS (dB)	PREAMP FACTOR (dB)	ANTENNA HEIGHT (cm)	TABLE ANGLE (Degree)	REMARK
5134	37.71	38.42	54	-16.29	31.31	5.28	37.3	108	43	Average
5134	55.64	56.35	74	-18.36	31.31	5.28	37.3	108	43	Peak
5320	95.92	96.28			31.45	5.38	37.19	108	43	Average
5320	105.12	105.48			31.45	5.38	37.19	108	43	Peak
5350	42.85	43.16	54	-11.15	31.48	5.39	37.18	108	43	Average
5350	61.08	61.39	74	-12.92	31.48	5.39	37.18	108	43	Peak

REMARKS:

- Emission Level = Read Level + Antenna Factor + Cable Loss - Preamp Factor
Margin value = Emission level – Limit value
- 5320MHz: Fundamental frequency.



A D T

EUT TEST CONDITION		MEASUREMENT DETAIL	
CHANNEL	Channel 100	FREQUENCY RANGE	1GHz ~ 40GHz
INPUT POWER (SYSTEM)	120Vac, 60 Hz	DETECTOR FUNCTION	Peak (PK) Average (AV)
ENVIRONMENTAL CONDITIONS	25deg. C, 65%RH	TESTED BY	Johnson Liao

ANTENNA POLARITY & TEST DISTANCE: HORIZONTAL AT 3 M										
FREQ. (MHz)	EMISSION LEVEL (dBuV/m)	READ LEVEL (dBuV)	LIMIT (dBuV/m)	MARGIN (dB)	ANTENNA FACTOR (dB/m)	CABLE LOSS (dB)	PREAMP FACTOR (dB)	ANTENNA HEIGHT (cm)	TABLE ANGLE (Degree)	REMARK
5446	42.04	42.17	54	-11.96	31.56	5.44	37.13	100	310	Average
5446	56.3	56.43	74	-17.7	31.56	5.44	37.13	100	310	Peak
5470	59.53	59.59	68.3	-8.77	31.57	5.45	37.08	100	310	Peak
5500	94.72	94.69			31.6	5.46	37.03	100	310	Average
5500	104.01	103.98			31.6	5.46	37.03	100	310	Peak
5725	54.5	54.38	68.3	-13.8	31.96	5.59	37.43	100	310	Peak
ANTENNA POLARITY & TEST DISTANCE: VERTICAL AT 3 M										
FREQ. (MHz)	EMISSION LEVEL (dBuV/m)	READ LEVEL (dBuV)	LIMIT (dBuV/m)	MARGIN (dB)	ANTENNA FACTOR (dB/m)	CABLE LOSS (dB)	PREAMP FACTOR (dB)	ANTENNA HEIGHT (cm)	TABLE ANGLE (Degree)	REMARK
5460	42.96	43.04	54	-11.04	31.56	5.44	37.08	100	66	Average
5460	56.35	56.43	74	-17.65	31.56	5.44	37.08	100	66	Peak
5470	62.1	62.16	68.3	-6.2	31.57	5.45	37.08	100	66	Peak
5500	95.85	95.82			31.6	5.46	37.03	100	66	Average
5500	105.07	105.04			31.6	5.46	37.03	100	66	Peak
5725	54.09	53.97	68.3	-14.21	31.96	5.59	37.43	100	66	Peak

REMARKS:

- Emission Level = Read Level + Antenna Factor + Cable Loss - Preamp Factor
Margin value = Emission level – Limit value
- 5500MHz: Fundamental frequency.
- 5470MHz & 5725MHz: Out of restricted band



A D T

EUT TEST CONDITION		MEASUREMENT DETAIL	
CHANNEL	Channel 116	FREQUENCY RANGE	1GHz ~ 40GHz
INPUT POWER (SYSTEM)	120Vac, 60 Hz	DETECTOR FUNCTION	Peak (PK) Average (AV)
ENVIRONMENTAL CONDITIONS	25deg. C, 65%RH	TESTED BY	Johnson Liao

ANTENNA POLARITY & TEST DISTANCE: HORIZONTAL AT 3 M										
FREQ. (MHz)	EMISSION LEVEL (dBuV/m)	READ LEVEL (dBuV)	LIMIT (dBuV/m)	MARGIN (dB)	ANTENNA FACTOR (dB/m)	CABLE LOSS (dB)	PREAMP FACTOR (dB)	ANTENNA HEIGHT (cm)	TABLE ANGLE (Degree)	REMARK
5460	38.22	38.3	54	-15.78	31.56	5.44	37.08	100	310	Average
5460	55.39	55.47	74	-18.61	31.56	5.44	37.08	100	310	Peak
5470	54.45	54.51	68.3	-13.85	31.57	5.45	37.08	100	310	Peak
5580	95.71	95.66			31.71	5.5	37.16	100	310	Average
5580	105.18	105.13			31.71	5.5	37.16	100	310	Peak
5725	54.31	54.19	68.3	-13.99	31.96	5.59	37.43	100	310	Peak
ANTENNA POLARITY & TEST DISTANCE: VERTICAL AT 3 M										
FREQ. (MHz)	EMISSION LEVEL (dBuV/m)	READ LEVEL (dBuV)	LIMIT (dBuV/m)	MARGIN (dB)	ANTENNA FACTOR (dB/m)	CABLE LOSS (dB)	PREAMP FACTOR (dB)	ANTENNA HEIGHT (cm)	TABLE ANGLE (Degree)	REMARK
5458	37.75	37.83	54	-16.25	31.56	5.44	37.08	102	39	Average
5458	56.42	56.5	74	-17.58	31.56	5.44	37.08	102	39	Peak
5470	53.83	53.89	68.3	-14.47	31.57	5.45	37.08	102	39	Peak
5580	96.99	96.94			31.71	5.5	37.16	102	39	Average
5580	106.54	106.49			31.71	5.5	37.16	102	39	Peak
5725	54.1	53.98	68.3	-14.2	31.96	5.59	37.43	102	39	Peak

REMARKS:

- Emission Level = Read Level + Antenna Factor + Cable Loss - Preamp Factor
Margin value = Emission level – Limit value
- 5580MHz: Fundamental frequency.
- 5470MHz & 5725MHz: Out of restricted band



A D T

EUT TEST CONDITION		MEASUREMENT DETAIL	
CHANNEL	Channel 140	FREQUENCY RANGE	1GHz ~ 40GHz
INPUT POWER (SYSTEM)	120Vac, 60 Hz	DETECTOR FUNCTION	Peak (PK) Average (AV)
ENVIRONMENTAL CONDITIONS	25deg. C, 65%RH	TESTED BY	Johnson Liao

ANTENNA POLARITY & TEST DISTANCE: HORIZONTAL AT 3 M										
FREQ. (MHz)	EMISSION LEVEL (dBuV/m)	READ LEVEL (dBuV)	LIMIT (dBuV/m)	MARGIN (dB)	ANTENNA FACTOR (dB/m)	CABLE LOSS (dB)	PREAMP FACTOR (dB)	ANTENNA HEIGHT (cm)	TABLE ANGLE (Degree)	REMARK
5378	37.77	38.04	54	-16.23	31.51	5.4	37.18	100	312	Average
5378	55.86	56.13	74	-18.14	31.51	5.4	37.18	100	312	Peak
5470	54.57	54.63	68.3	-13.73	31.57	5.45	37.08	100	312	Peak
5700	95.12	95.05			31.9	5.57	37.4	100	312	Average
5700	104.32	104.25			31.9	5.57	37.4	100	312	Peak
5725	65.22	65.1	68.3	-3.08	31.96	5.59	37.43	100	312	Peak
ANTENNA POLARITY & TEST DISTANCE: VERTICAL AT 3 M										
FREQ. (MHz)	EMISSION LEVEL (dBuV/m)	READ LEVEL (dBuV)	LIMIT (dBuV/m)	MARGIN (dB)	ANTENNA FACTOR (dB/m)	CABLE LOSS (dB)	PREAMP FACTOR (dB)	ANTENNA HEIGHT (cm)	TABLE ANGLE (Degree)	REMARK
5460	38.58	38.66	54	-15.42	31.56	5.44	37.08	100	37	Average
5460	56.18	56.26	74	-17.82	31.56	5.44	37.08	100	37	Peak
5470	53.5	53.56	68.3	-14.8	31.57	5.45	37.08	100	37	Peak
5700	95.95	95.88			31.9	5.57	37.4	100	37	Average
5700	105.36	105.29			31.9	5.57	37.4	100	37	Peak
5725	64.79	64.67	68.3	-3.51	31.96	5.59	37.43	100	37	Peak

REMARKS:

- Emission Level = Read Level + Antenna Factor + Cable Loss - Preamp Factor
Margin value = Emission level – Limit value
- 5700MHz: Fundamental frequency.
- 5470MHz & 5725MHz: Out of restricted band



802.11n (20MHz)

EUT TEST CONDITION		MEASUREMENT DETAIL	
CHANNEL	Channel 36	FREQUENCY RANGE	1GHz ~ 40GHz
INPUT POWER (SYSTEM)	120Vac, 60 Hz	DETECTOR FUNCTION	Peak (PK) Average (AV)
ENVIRONMENTAL CONDITIONS	25deg. C, 65%RH	TESTED BY	Johnson Liao

ANTENNA POLARITY & TEST DISTANCE: HORIZONTAL AT 3 M										
FREQ. (MHz)	EMISSION LEVEL (dBuV/m)	READ LEVEL (dBuV)	LIMIT (dBuV/m)	MARGIN (dB)	ANTENNA FACTOR (dB/m)	CABLE LOSS (dB)	PREAMP FACTOR (dB)	ANTENNA HEIGHT (cm)	TABLE ANGLE (Degree)	REMARK
5150	41.75	42.46	54	-12.25	31.32	5.29	37.32	100	301	Average
5150	60.57	61.28	74	-13.43	31.32	5.29	37.32	100	301	Peak
5180	91.59	92.27			31.35	5.31	37.34	100	301	Average
5180	100.88	101.56			31.35	5.31	37.34	100	301	Peak
5362	37.72	38.02	54	-16.28	31.49	5.39	37.18	100	301	Average
5362	56.08	56.38	74	-17.92	31.49	5.39	37.18	100	301	Peak
ANTENNA POLARITY & TEST DISTANCE: VERTICAL AT 3 M										
FREQ. (MHz)	EMISSION LEVEL (dBuV/m)	READ LEVEL (dBuV)	LIMIT (dBuV/m)	MARGIN (dB)	ANTENNA FACTOR (dB/m)	CABLE LOSS (dB)	PREAMP FACTOR (dB)	ANTENNA HEIGHT (cm)	TABLE ANGLE (Degree)	REMARK
5144	42.93	43.64	54	-11.07	31.32	5.29	37.32	100	42	Average
5144	62.07	62.78	74	-11.93	31.32	5.29	37.32	100	42	Peak
5180	94.02	94.7			31.35	5.31	37.34	100	42	Average
5180	103.33	104.01			31.35	5.31	37.34	100	42	Peak
5430	37.86	38.02	54	-16.14	31.55	5.42	37.13	100	42	Average
5430	56.02	56.18	74	-17.98	31.55	5.42	37.13	100	42	Peak

REMARKS:

- Emission Level = Read Level + Antenna Factor + Cable Loss - Preamp Factor
Margin value = Emission level – Limit value
- 5180MHz: Fundamental frequency.



A D T

EUT TEST CONDITION		MEASUREMENT DETAIL	
CHANNEL	Channel 44	FREQUENCY RANGE	1GHz ~ 40GHz
INPUT POWER (SYSTEM)	120Vac, 60 Hz	DETECTOR FUNCTION	Peak (PK) Average (AV)
ENVIRONMENTAL CONDITIONS	25deg. C, 65%RH	TESTED BY	Johnson Liao

ANTENNA POLARITY & TEST DISTANCE: HORIZONTAL AT 3 M										
FREQ. (MHz)	EMISSION LEVEL (dBuV/m)	READ LEVEL (dBuV)	LIMIT (dBuV/m)	MARGIN (dB)	ANTENNA FACTOR (dB/m)	CABLE LOSS (dB)	PREAMP FACTOR (dB)	ANTENNA HEIGHT (cm)	TABLE ANGLE (Degree)	REMARK
5010	37.38	38.18	54	-16.62	31.21	5.22	37.23	100	294	Average
5010	55.7	56.5	74	-18.3	31.21	5.22	37.23	100	294	Peak
5220	92.33	92.99			31.37	5.33	37.36	100	294	Average
5220	101.84	102.5			31.37	5.33	37.36	100	294	Peak
5416	37.72	37.95	54	-16.28	31.53	5.42	37.18	100	294	Average
5416	56.26	56.49	74	-17.74	31.53	5.42	37.18	100	294	Peak
ANTENNA POLARITY & TEST DISTANCE: VERTICAL AT 3 M										
FREQ. (MHz)	EMISSION LEVEL (dBuV/m)	READ LEVEL (dBuV)	LIMIT (dBuV/m)	MARGIN (dB)	ANTENNA FACTOR (dB/m)	CABLE LOSS (dB)	PREAMP FACTOR (dB)	ANTENNA HEIGHT (cm)	TABLE ANGLE (Degree)	REMARK
5128	37.58	38.29	54	-16.42	31.31	5.28	37.3	100	42	Average
5128	55.84	56.55	74	-18.16	31.31	5.28	37.3	100	42	Peak
5220	94.44	95.1			31.37	5.33	37.36	100	42	Average
5220	103.58	104.24			31.37	5.33	37.36	100	42	Peak
5434	37.78	37.94	54	-16.22	31.55	5.42	37.13	100	42	Average
5434	55.33	55.49	74	-18.67	31.55	5.42	37.13	100	42	Peak

REMARKS:

- Emission Level = Read Level + Antenna Factor + Cable Loss - Preamp Factor
Margin value = Emission level – Limit value
- 5220MHz: Fundamental frequency.



A D T

EUT TEST CONDITION		MEASUREMENT DETAIL	
CHANNEL	Channel 48	FREQUENCY RANGE	1GHz ~ 40GHz
INPUT POWER (SYSTEM)	120Vac, 60 Hz	DETECTOR FUNCTION	Peak (PK) Average (AV)
ENVIRONMENTAL CONDITIONS	25deg. C, 65%RH	TESTED BY	Johnson Liao

ANTENNA POLARITY & TEST DISTANCE: HORIZONTAL AT 3 M										
FREQ. (MHz)	EMISSION LEVEL (dBuV/m)	READ LEVEL (dBuV)	LIMIT (dBuV/m)	MARGIN (dB)	ANTENNA FACTOR (dB/m)	CABLE LOSS (dB)	PREAMP FACTOR (dB)	ANTENNA HEIGHT (cm)	TABLE ANGLE (Degree)	REMARK
5076	37.49	38.23	54	-16.51	31.27	5.26	37.27	100	303	Average
5076	55.37	56.11	74	-18.63	31.27	5.26	37.27	100	303	Peak
5240	92.19	92.78			31.39	5.34	37.32	100	303	Average
5240	101.57	102.16			31.39	5.34	37.32	100	303	Peak
5420	37.94	38.17	54	-16.06	31.53	5.42	37.18	100	303	Average
5420	56.21	56.44	74	-17.79	31.53	5.42	37.18	100	303	Peak

ANTENNA POLARITY & TEST DISTANCE: VERTICAL AT 3 M										
FREQ. (MHz)	EMISSION LEVEL (dBuV/m)	READ LEVEL (dBuV)	LIMIT (dBuV/m)	MARGIN (dB)	ANTENNA FACTOR (dB/m)	CABLE LOSS (dB)	PREAMP FACTOR (dB)	ANTENNA HEIGHT (cm)	TABLE ANGLE (Degree)	REMARK
5042	37.49	38.25	54	-16.51	31.24	5.25	37.25	100	49	Average
5042	56.77	57.53	74	-17.23	31.24	5.25	37.25	100	49	Peak
5240	94.7	95.29			31.39	5.34	37.32	100	49	Average
5240	104.76	105.35			31.39	5.34	37.32	100	49	Peak
5438	37.73	37.87	54	-16.27	31.55	5.44	37.13	100	49	Average
5438	57.63	57.77	74	-16.37	31.55	5.44	37.13	100	49	Peak

REMARKS:

1. Emission Level = Read Level + Antenna Factor + Cable Loss - Preamp Factor
Margin value = Emission level – Limit value
2. 5240MHz: Fundamental frequency.



A D T

EUT TEST CONDITION		MEASUREMENT DETAIL	
CHANNEL	Channel 52	FREQUENCY RANGE	1GHz ~ 40GHz
INPUT POWER (SYSTEM)	120Vac, 60 Hz	DETECTOR FUNCTION	Peak (PK) Average (AV)
ENVIRONMENTAL CONDITIONS	25deg. C, 65%RH	TESTED BY	Johnson Liao

ANTENNA POLARITY & TEST DISTANCE: HORIZONTAL AT 3 M										
FREQ. (MHz)	EMISSION LEVEL (dBuV/m)	READ LEVEL (dBuV)	LIMIT (dBuV/m)	MARGIN (dB)	ANTENNA FACTOR (dB/m)	CABLE LOSS (dB)	PREAMP FACTOR (dB)	ANTENNA HEIGHT (cm)	TABLE ANGLE (Degree)	REMARK
5048	37.52	38.28	54	-16.48	31.24	5.25	37.25	100	293	Average
5048	55.19	55.95	74	-18.81	31.24	5.25	37.25	100	293	Peak
5260	92.77	93.29			31.41	5.34	37.27	100	293	Average
5260	102.18	102.7			31.41	5.34	37.27	100	293	Peak
5428	37.83	38.01	54	-16.17	31.53	5.42	37.13	100	293	Average
5428	56.63	56.81	74	-17.37	31.53	5.42	37.13	100	293	Peak
ANTENNA POLARITY & TEST DISTANCE: VERTICAL AT 3 M										
FREQ. (MHz)	EMISSION LEVEL (dBuV/m)	READ LEVEL (dBuV)	LIMIT (dBuV/m)	MARGIN (dB)	ANTENNA FACTOR (dB/m)	CABLE LOSS (dB)	PREAMP FACTOR (dB)	ANTENNA HEIGHT (cm)	TABLE ANGLE (Degree)	REMARK
5036	37.73	38.5	54	-16.27	31.23	5.24	37.24	100	48	Average
5036	55.75	56.52	74	-18.25	31.23	5.24	37.24	100	48	Peak
5260	94.57	95.09			31.41	5.34	37.27	100	48	Average
5260	103.58	104.1			31.41	5.34	37.27	100	48	Peak
5412	37.7	37.94	54	-16.3	31.53	5.41	37.18	100	48	Average
5412	55.73	55.97	74	-18.27	31.53	5.41	37.18	100	48	Peak

REMARKS:

- Emission Level = Read Level + Antenna Factor + Cable Loss - Preamp Factor
Margin value = Emission level – Limit value
- 5260MHz: Fundamental frequency.



A D T

EUT TEST CONDITION		MEASUREMENT DETAIL	
CHANNEL	Channel 60	FREQUENCY RANGE	1GHz ~ 40GHz
INPUT POWER (SYSTEM)	120Vac, 60 Hz	DETECTOR FUNCTION	Peak (PK) Average (AV)
ENVIRONMENTAL CONDITIONS	25deg. C, 65%RH	TESTED BY	Johnson Liao

ANTENNA POLARITY & TEST DISTANCE: HORIZONTAL AT 3 M										
FREQ. (MHz)	EMISSION LEVEL (dBuV/m)	READ LEVEL (dBuV)	LIMIT (dBuV/m)	MARGIN (dB)	ANTENNA FACTOR (dB/m)	CABLE LOSS (dB)	PREAMP FACTOR (dB)	ANTENNA HEIGHT (cm)	TABLE ANGLE (Degree)	REMARK
5040	37.41	38.16	54	-16.59	31.24	5.25	37.24	100	301	Average
5040	55.79	56.54	74	-18.21	31.24	5.25	37.24	100	301	Peak
5300	93.58	93.96			31.44	5.37	37.19	100	301	Average
5300	102.73	103.11			31.44	5.37	37.19	100	301	Peak
5414	41.95	42.18	54	-12.05	31.53	5.42	37.18	100	301	Average
5414	55.95	56.18	74	-18.05	31.53	5.42	37.18	100	301	Peak
ANTENNA POLARITY & TEST DISTANCE: VERTICAL AT 3 M										
FREQ. (MHz)	EMISSION LEVEL (dBuV/m)	READ LEVEL (dBuV)	LIMIT (dBuV/m)	MARGIN (dB)	ANTENNA FACTOR (dB/m)	CABLE LOSS (dB)	PREAMP FACTOR (dB)	ANTENNA HEIGHT (cm)	TABLE ANGLE (Degree)	REMARK
5106	37.42	38.14	54	-16.58	31.29	5.27	37.28	108	40	Average
5106	54.98	55.7	74	-19.02	31.29	5.27	37.28	108	40	Peak
5300	95.99	96.37			31.44	5.37	37.19	108	40	Average
5300	105.36	105.74			31.44	5.37	37.19	108	40	Peak
5352	43.8	44.11	54	-10.2	31.48	5.39	37.18	108	40	Average
5352	55.55	55.86	74	-18.45	31.48	5.39	37.18	108	40	Peak

REMARKS:

- Emission Level = Read Level + Antenna Factor + Cable Loss - Preamp Factor
Margin value = Emission level – Limit value
- 5300MHz: Fundamental frequency.



A D T

EUT TEST CONDITION		MEASUREMENT DETAIL	
CHANNEL	Channel 64	FREQUENCY RANGE	1GHz ~ 40GHz
INPUT POWER (SYSTEM)	120Vac, 60 Hz	DETECTOR FUNCTION	Peak (PK) Average (AV)
ENVIRONMENTAL CONDITIONS	25deg. C, 65%RH	TESTED BY	Johnson Liao

ANTENNA POLARITY & TEST DISTANCE: HORIZONTAL AT 3 M										
FREQ. (MHz)	EMISSION LEVEL (dBuV/m)	READ LEVEL (dBuV)	LIMIT (dBuV/m)	MARGIN (dB)	ANTENNA FACTOR (dB/m)	CABLE LOSS (dB)	PREAMP FACTOR (dB)	ANTENNA HEIGHT (cm)	TABLE ANGLE (Degree)	REMARK
5072	37.6	38.34	54	-16.4	31.27	5.26	37.27	100	308	Average
5072	55.01	55.75	74	-18.99	31.27	5.26	37.27	100	308	Peak
5320	94.18	94.54			31.45	5.38	37.19	100	308	Average
5320	103.27	103.63			31.45	5.38	37.19	100	308	Peak
5350	42.96	43.27	54	-11.04	31.48	5.39	37.18	100	308	Average
5350	60.92	61.23	74	-13.08	31.48	5.39	37.18	100	308	Peak
ANTENNA POLARITY & TEST DISTANCE: VERTICAL AT 3 M										
FREQ. (MHz)	EMISSION LEVEL (dBuV/m)	READ LEVEL (dBuV)	LIMIT (dBuV/m)	MARGIN (dB)	ANTENNA FACTOR (dB/m)	CABLE LOSS (dB)	PREAMP FACTOR (dB)	ANTENNA HEIGHT (cm)	TABLE ANGLE (Degree)	REMARK
5034	37.51	38.28	54	-16.49	31.23	5.24	37.24	117	48	Average
5034	55.38	56.15	74	-18.62	31.23	5.24	37.24	117	48	Peak
5320	95.96	96.32			31.45	5.38	37.19	117	48	Average
5320	104.87	105.23			31.45	5.38	37.19	117	48	Peak
5350	45.03	45.34	54	-8.97	31.48	5.39	37.18	117	48	Average
5350	62.69	63	74	-11.31	31.48	5.39	37.18	117	48	Peak

REMARKS:

- Emission Level = Read Level + Antenna Factor + Cable Loss - Preamp Factor
Margin value = Emission level – Limit value
- 5320MHz: Fundamental frequency.



A D T

EUT TEST CONDITION		MEASUREMENT DETAIL	
CHANNEL	Channel 100	FREQUENCY RANGE	1GHz ~ 40GHz
INPUT POWER (SYSTEM)	120Vac, 60 Hz	DETECTOR FUNCTION	Peak (PK) Average (AV)
ENVIRONMENTAL CONDITIONS	25deg. C, 65%RH	TESTED BY	Johnson Liao

ANTENNA POLARITY & TEST DISTANCE: HORIZONTAL AT 3 M										
FREQ. (MHz)	EMISSION LEVEL (dBuV/m)	READ LEVEL (dBuV)	LIMIT (dBuV/m)	MARGIN (dB)	ANTENNA FACTOR (dB/m)	CABLE LOSS (dB)	PREAMP FACTOR (dB)	ANTENNA HEIGHT (cm)	TABLE ANGLE (Degree)	REMARK
5458	43.04	43.12	54	-10.96	31.56	5.44	37.08	100	309	Average
5458	57	57.08	74	-17	31.56	5.44	37.08	100	309	Peak
5470	62.82	62.88	68.3	-5.48	31.57	5.45	37.08	100	309	Peak
5500	95.36	95.33			31.6	5.46	37.03	100	309	Average
5500	104.64	104.61			31.6	5.46	37.03	100	309	Peak
5725	54.15	54.03	68.3	-14.15	31.96	5.59	37.43	100	309	Peak
ANTENNA POLARITY & TEST DISTANCE: VERTICAL AT 3 M										
FREQ. (MHz)	EMISSION LEVEL (dBuV/m)	READ LEVEL (dBuV)	LIMIT (dBuV/m)	MARGIN (dB)	ANTENNA FACTOR (dB/m)	CABLE LOSS (dB)	PREAMP FACTOR (dB)	ANTENNA HEIGHT (cm)	TABLE ANGLE (Degree)	REMARK
5460	43.67	43.75	54	-10.33	31.56	5.44	37.08	100	69	Average
5460	58.54	58.62	74	-15.46	31.56	5.44	37.08	100	69	Peak
5470	61.72	61.78	68.3	-6.58	31.57	5.45	37.08	100	69	Peak
5500	96.45	96.42			31.6	5.46	37.03	100	69	Average
5500	105.97	105.94			31.6	5.46	37.03	100	69	Peak
5725	53.8	53.68	68.3	-14.5	31.96	5.59	37.43	100	69	Peak

REMARKS:

- Emission Level = Read Level + Antenna Factor + Cable Loss - Preamp Factor
Margin value = Emission level – Limit value
- 5500MHz: Fundamental frequency.
- 5470MHz & 5725MHz: Out of restricted band



A D T

EUT TEST CONDITION		MEASUREMENT DETAIL	
CHANNEL	Channel 116	FREQUENCY RANGE	1GHz ~ 40GHz
INPUT POWER (SYSTEM)	120Vac, 60 Hz	DETECTOR FUNCTION	Peak (PK) Average (AV)
ENVIRONMENTAL CONDITIONS	25deg. C, 65%RH	TESTED BY	Johnson Liao

ANTENNA POLARITY & TEST DISTANCE: HORIZONTAL AT 3 M										
FREQ. (MHz)	EMISSION LEVEL (dBuV/m)	READ LEVEL (dBuV)	LIMIT (dBuV/m)	MARGIN (dB)	ANTENNA FACTOR (dB/m)	CABLE LOSS (dB)	PREAMP FACTOR (dB)	ANTENNA HEIGHT (cm)	TABLE ANGLE (Degree)	REMARK
5418	38.2	38.43	54	-15.8	31.53	5.42	37.18	100	312	Average
5418	55.95	56.18	74	-18.05	31.53	5.42	37.18	100	312	Peak
5470	54.15	54.21	68.3	-14.15	31.57	5.45	37.08	100	312	Peak
5580	94.98	94.93			31.71	5.5	37.16	100	312	Average
5580	104.52	104.47			31.71	5.5	37.16	100	312	Peak
5725	55.19	55.07	68.3	-13.11	31.96	5.59	37.43	100	312	Peak
ANTENNA POLARITY & TEST DISTANCE: VERTICAL AT 3 M										
FREQ. (MHz)	EMISSION LEVEL (dBuV/m)	READ LEVEL (dBuV)	LIMIT (dBuV/m)	MARGIN (dB)	ANTENNA FACTOR (dB/m)	CABLE LOSS (dB)	PREAMP FACTOR (dB)	ANTENNA HEIGHT (cm)	TABLE ANGLE (Degree)	REMARK
5382	38.35	38.62	54	-15.65	31.51	5.4	37.18	100	58	Average
5382	55.22	55.49	74	-18.78	31.51	5.4	37.18	100	58	Peak
5470	55.29	55.35	68.3	-13.01	31.57	5.45	37.08	100	58	Peak
5580	96.11	96.06			31.71	5.5	37.16	100	58	Average
5580	105.19	105.14			31.71	5.5	37.16	100	58	Peak
5724	55.67	55.55	68.3	-12.63	31.96	5.59	37.43	100	58	Peak

REMARKS:

- Emission Level = Read Level + Antenna Factor + Cable Loss - Preamp Factor
Margin value = Emission level – Limit value
- 5580MHz: Fundamental frequency.
- 5470MHz & 5725MHz: Out of restricted band



A D T

EUT TEST CONDITION		MEASUREMENT DETAIL	
CHANNEL	Channel 140	FREQUENCY RANGE	1GHz ~ 40GHz
INPUT POWER (SYSTEM)	120Vac, 60 Hz	DETECTOR FUNCTION	Peak (PK) Average (AV)
ENVIRONMENTAL CONDITIONS	25deg. C, 65%RH	TESTED BY	Johnson Liao

ANTENNA POLARITY & TEST DISTANCE: HORIZONTAL AT 3 M										
FREQ. (MHz)	EMISSION LEVEL (dBuV/m)	READ LEVEL (dBuV)	LIMIT (dBuV/m)	MARGIN (dB)	ANTENNA FACTOR (dB/m)	CABLE LOSS (dB)	PREAMP FACTOR (dB)	ANTENNA HEIGHT (cm)	TABLE ANGLE (Degree)	REMARK
5460	38	38.08	54	-16	31.56	5.44	37.08	100	305	Average
5460	55.34	55.42	74	-18.66	31.56	5.44	37.08	100	305	Peak
5470	54.58	54.64	68.3	-13.72	31.57	5.45	37.08	100	305	Peak
5700	94.37	94.3			31.9	5.57	37.4	100	305	Average
5700	103.59	103.52			31.9	5.57	37.4	100	305	Peak
5725	65.96	65.84	68.3	-2.34	31.96	5.59	37.43	100	305	Peak
ANTENNA POLARITY & TEST DISTANCE: VERTICAL AT 3 M										
FREQ. (MHz)	EMISSION LEVEL (dBuV/m)	READ LEVEL (dBuV)	LIMIT (dBuV/m)	MARGIN (dB)	ANTENNA FACTOR (dB/m)	CABLE LOSS (dB)	PREAMP FACTOR (dB)	ANTENNA HEIGHT (cm)	TABLE ANGLE (Degree)	REMARK
5426	37.98	38.16	54	-16.02	31.53	5.42	37.13	100	40	Average
5426	54.67	54.85	74	-19.33	31.53	5.42	37.13	100	40	Peak
5470	53.6	53.66	68.3	-14.7	31.57	5.45	37.08	100	40	Peak
5700	95.12	95.05			31.9	5.57	37.4	100	40	Average
5700	104.68	104.61			31.9	5.57	37.4	100	40	Peak
5725	64.94	64.82	68.3	-3.36	31.96	5.59	37.43	100	40	Peak

REMARKS:

1. Emission Level = Read Level + Antenna Factor + Cable Loss - Preamp Factor
Margin value = Emission level – Limit value
2. 5700MHz: Fundamental frequency.
3. 5470MHz & 5725MHz: Out of restricted band



A D T

802.11n (40MHz)

EUT TEST CONDITION		MEASUREMENT DETAIL	
CHANNEL	Channel 38	FREQUENCY RANGE	1GHz ~ 40GHz
INPUT POWER (SYSTEM)	120Vac, 60 Hz	DETECTOR FUNCTION	Peak (PK) Average (AV)
ENVIRONMENTAL CONDITIONS	25deg. C, 65%RH	TESTED BY	Johnson Liao

ANTENNA POLARITY & TEST DISTANCE: HORIZONTAL AT 3 M

FREQ. (MHz)	EMISSION LEVEL (dBuV/m)	READ LEVEL (dBuV)	LIMIT (dBuV/m)	MARGIN (dB)	ANTENNA FACTOR (dB/m)	CABLE LOSS (dB)	PREAMP FACTOR (dB)	ANTENNA HEIGHT (cm)	TABLE ANGLE (Degree)	REMARK
5146	39.18	39.89	54	-14.82	31.32	5.29	37.32	100	295	Average
5146	55.37	56.08	74	-18.63	31.32	5.29	37.32	100	295	Peak
5190	86.97	87.64			31.35	5.32	37.34	100	295	Average
5190	95.72	96.39			31.35	5.32	37.34	100	295	Peak
5424	38.03	38.26	54	-15.97	31.53	5.42	37.18	100	295	Average
5424	55.85	56.08	74	-18.15	31.53	5.42	37.18	100	295	Peak

ANTENNA POLARITY & TEST DISTANCE: VERTICAL AT 3 M

FREQ. (MHz)	EMISSION LEVEL (dBuV/m)	READ LEVEL (dBuV)	LIMIT (dBuV/m)	MARGIN (dB)	ANTENNA FACTOR (dB/m)	CABLE LOSS (dB)	PREAMP FACTOR (dB)	ANTENNA HEIGHT (cm)	TABLE ANGLE (Degree)	REMARK
5122	39.28	40.01	54	-14.72	31.29	5.28	37.3	100	44	Average
5122	54.99	55.72	74	-19.01	31.29	5.28	37.3	100	44	Peak
5190	88.48	89.15			31.35	5.32	37.34	100	44	Average
5190	97.9	98.57			31.35	5.32	37.34	100	44	Peak
5460	37.55	37.63	54	-16.45	31.56	5.44	37.08	100	44	Average
5460	56.2	56.28	74	-17.8	31.56	5.44	37.08	100	44	Peak

REMARKS:

- Emission Level = Read Level + Antenna Factor + Cable Loss - Preamp Factor
Margin value = Emission level – Limit value
- 5190MHz: Fundamental frequency.



A D T

EUT TEST CONDITION		MEASUREMENT DETAIL	
CHANNEL	Channel 46	FREQUENCY RANGE	1GHz ~ 40GHz
INPUT POWER (SYSTEM)	120Vac, 60 Hz	DETECTOR FUNCTION	Peak (PK) Average (AV)
ENVIRONMENTAL CONDITIONS	25deg. C, 65%RH	TESTED BY	Johnson Liao

ANTENNA POLARITY & TEST DISTANCE: HORIZONTAL AT 3 M										
FREQ. (MHz)	EMISSION LEVEL (dBuV/m)	READ LEVEL (dBuV)	LIMIT (dBuV/m)	MARGIN (dB)	ANTENNA FACTOR (dB/m)	CABLE LOSS (dB)	PREAMP FACTOR (dB)	ANTENNA HEIGHT (cm)	TABLE ANGLE (Degree)	REMARK
5018	37.99	38.78	54	-16.01	31.21	5.24	37.24	100	295	Average
5018	56.4	57.19	74	-17.6	31.21	5.24	37.24	100	295	Peak
5230	87.67	88.27			31.39	5.33	37.32	100	295	Average
5230	96.07	96.67			31.39	5.33	37.32	100	295	Peak
5414	37.98	38.21	54	-16.02	31.53	5.42	37.18	100	295	Average
5414	55.84	56.07	74	-18.16	31.53	5.42	37.18	100	295	Peak
ANTENNA POLARITY & TEST DISTANCE: VERTICAL AT 3 M										
FREQ. (MHz)	EMISSION LEVEL (dBuV/m)	READ LEVEL (dBuV)	LIMIT (dBuV/m)	MARGIN (dB)	ANTENNA FACTOR (dB/m)	CABLE LOSS (dB)	PREAMP FACTOR (dB)	ANTENNA HEIGHT (cm)	TABLE ANGLE (Degree)	REMARK
5050	38.57	39.33	54	-15.43	31.24	5.25	37.25	100	43	Average
5050	55.6	56.36	74	-18.4	31.24	5.25	37.25	100	43	Peak
5230	88.88	89.48			31.39	5.33	37.32	100	43	Average
5230	97.62	98.22			31.39	5.33	37.32	100	43	Peak
5444	38.03	38.17	54	-15.97	31.55	5.44	37.13	100	43	Average
5444	54.43	54.57	74	-19.57	31.55	5.44	37.13	100	43	Peak

REMARKS:

- Emission Level = Read Level + Antenna Factor + Cable Loss - Preamp Factor
Margin value = Emission level – Limit value
- 5230MHz: Fundamental frequency.



A D T

EUT TEST CONDITION		MEASUREMENT DETAIL	
CHANNEL	Channel 54	FREQUENCY RANGE	1GHz ~ 40GHz
INPUT POWER (SYSTEM)	120Vac, 60 Hz	DETECTOR FUNCTION	Peak (PK) Average (AV)
ENVIRONMENTAL CONDITIONS	25deg. C, 65%RH	TESTED BY	Johnson Liao

ANTENNA POLARITY & TEST DISTANCE: HORIZONTAL AT 3 M										
FREQ. (MHz)	EMISSION LEVEL (dBuV/m)	READ LEVEL (dBuV)	LIMIT (dBuV/m)	MARGIN (dB)	ANTENNA FACTOR (dB/m)	CABLE LOSS (dB)	PREAMP FACTOR (dB)	ANTENNA HEIGHT (cm)	TABLE ANGLE (Degree)	REMARK
5100	37.81	38.54	54	-16.19	31.28	5.27	37.28	100	307	Average
5100	55.29	56.02	74	-18.71	31.28	5.27	37.28	100	307	Peak
5270	86.94	87.45			31.41	5.35	37.27	100	307	Average
5270	95.76	96.27			31.41	5.35	37.27	100	307	Peak
5454	38.41	38.49	54	-15.59	31.56	5.44	37.08	100	307	Average
5454	55.88	55.96	74	-18.12	31.56	5.44	37.08	100	307	Peak
ANTENNA POLARITY & TEST DISTANCE: VERTICAL AT 3 M										
FREQ. (MHz)	EMISSION LEVEL (dBuV/m)	READ LEVEL (dBuV)	LIMIT (dBuV/m)	MARGIN (dB)	ANTENNA FACTOR (dB/m)	CABLE LOSS (dB)	PREAMP FACTOR (dB)	ANTENNA HEIGHT (cm)	TABLE ANGLE (Degree)	REMARK
5022	37.65	38.42	54	-16.35	31.23	5.24	37.24	108	43	Average
5022	56.11	56.88	74	-17.89	31.23	5.24	37.24	108	43	Peak
5270	89.06	89.57			31.41	5.35	37.27	108	43	Average
5270	97.88	98.39			31.41	5.35	37.27	108	43	Peak
5366	38.88	39.17	54	-15.12	31.49	5.4	37.18	108	43	Average
5366	55.17	55.46	74	-18.83	31.49	5.4	37.18	108	43	Peak

REMARKS:

- Emission Level = Read Level + Antenna Factor + Cable Loss - Preamp Factor
Margin value = Emission level – Limit value
- 5270MHz: Fundamental frequency.



A D T

EUT TEST CONDITION		MEASUREMENT DETAIL	
CHANNEL	Channel 62	FREQUENCY RANGE	1GHz ~ 40GHz
INPUT POWER (SYSTEM)	120Vac, 60 Hz	DETECTOR FUNCTION	Peak (PK) Average (AV)
ENVIRONMENTAL CONDITIONS	25deg. C, 65%RH	TESTED BY	Johnson Liao

ANTENNA POLARITY & TEST DISTANCE: HORIZONTAL AT 3 M										
FREQ. (MHz)	EMISSION LEVEL (dBuV/m)	READ LEVEL (dBuV)	LIMIT (dBuV/m)	MARGIN (dB)	ANTENNA FACTOR (dB/m)	CABLE LOSS (dB)	PREAMP FACTOR (dB)	ANTENNA HEIGHT (cm)	TABLE ANGLE (Degree)	REMARK
5144	37.8	38.51	54	-16.2	31.32	5.29	37.32	100	308	Average
5144	56.16	56.87	74	-17.84	31.32	5.29	37.32	100	308	Peak
5310	87.77	88.14			31.45	5.37	37.19	100	308	Average
5310	96.86	97.23			31.45	5.37	37.19	100	308	Peak
5352	38.85	39.16	54	-15.15	31.48	5.39	37.18	100	308	Average
5352	55.83	56.14	74	-18.17	31.48	5.39	37.18	100	308	Peak
ANTENNA POLARITY & TEST DISTANCE: VERTICAL AT 3 M										
FREQ. (MHz)	EMISSION LEVEL (dBuV/m)	READ LEVEL (dBuV)	LIMIT (dBuV/m)	MARGIN (dB)	ANTENNA FACTOR (dB/m)	CABLE LOSS (dB)	PREAMP FACTOR (dB)	ANTENNA HEIGHT (cm)	TABLE ANGLE (Degree)	REMARK
5140	38.07	38.76	54	-15.93	31.32	5.29	37.3	108	41	Average
5140	55.37	56.06	74	-18.63	31.32	5.29	37.3	108	41	Peak
5310	89.45	89.82			31.45	5.37	37.19	108	41	Average
5310	98.84	99.21			31.45	5.37	37.19	108	41	Peak
5350	39.98	40.29	54	-14.02	31.48	5.39	37.18	108	41	Average
5350	56.63	56.94	74	-17.37	31.48	5.39	37.18	108	41	Peak

REMARKS:

- Emission Level = Read Level + Antenna Factor + Cable Loss - Preamp Factor
Margin value = Emission level – Limit value
- 5310MHz: Fundamental frequency.



A D T

EUT TEST CONDITION		MEASUREMENT DETAIL	
CHANNEL	Channel 102	FREQUENCY RANGE	1GHz ~ 40GHz
INPUT POWER (SYSTEM)	120Vac, 60 Hz	DETECTOR FUNCTION	Peak (PK) Average (AV)
ENVIRONMENTAL CONDITIONS	25deg. C, 65%RH	TESTED BY	Johnson Liao

ANTENNA POLARITY & TEST DISTANCE: HORIZONTAL AT 3 M										
FREQ. (MHz)	EMISSION LEVEL (dBuV/m)	READ LEVEL (dBuV)	LIMIT (dBuV/m)	MARGIN (dB)	ANTENNA FACTOR (dB/m)	CABLE LOSS (dB)	PREAMP FACTOR (dB)	ANTENNA HEIGHT (cm)	TABLE ANGLE (Degree)	REMARK
5450	38.69	38.77	54	-15.31	31.56	5.44	37.08	100	311	Average
5450	56.16	56.24	74	-17.84	31.56	5.44	37.08	100	311	Peak
5470	55.66	55.72	68.3	-12.64	31.57	5.45	37.08	100	311	Peak
5510	89.57	89.57			31.6	5.46	37.06	100	311	Average
5510	98.76	98.76			31.6	5.46	37.06	100	311	Peak
5725	55.21	55.09	68.3	-13.09	31.96	5.59	37.43	100	311	Peak
ANTENNA POLARITY & TEST DISTANCE: VERTICAL AT 3 M										
FREQ. (MHz)	EMISSION LEVEL (dBuV/m)	READ LEVEL (dBuV)	LIMIT (dBuV/m)	MARGIN (dB)	ANTENNA FACTOR (dB/m)	CABLE LOSS (dB)	PREAMP FACTOR (dB)	ANTENNA HEIGHT (cm)	TABLE ANGLE (Degree)	REMARK
5458	39.4	39.48	54	-14.6	31.56	5.44	37.08	109	65	Average
5458	55.85	55.93	74	-18.15	31.56	5.44	37.08	109	65	Peak
5470	57.73	57.79	68.3	-10.57	31.57	5.45	37.08	109	65	Peak
5510	90.44	90.44			31.6	5.46	37.06	109	65	Average
5510	99.84	99.84			31.6	5.46	37.06	109	65	Peak
5725	53.84	53.72	68.3	-14.46	31.96	5.59	37.43	109	65	Peak

REMARKS:

- Emission Level = Read Level + Antenna Factor + Cable Loss - Preamp Factor
Margin value = Emission level – Limit value
- 5510MHz: Fundamental frequency.
- 5470MHz & 5725MHz: Out of restricted band



A D T

EUT TEST CONDITION		MEASUREMENT DETAIL	
CHANNEL	Channel 110	FREQUENCY RANGE	1GHz ~ 40GHz
INPUT POWER (SYSTEM)	120Vac, 60 Hz	DETECTOR FUNCTION	Peak (PK) Average (AV)
ENVIRONMENTAL CONDITIONS	25deg. C, 65%RH	TESTED BY	Johnson Liao

ANTENNA POLARITY & TEST DISTANCE: HORIZONTAL AT 3 M										
FREQ. (MHz)	EMISSION LEVEL (dBuV/m)	READ LEVEL (dBuV)	LIMIT (dBuV/m)	MARGIN (dB)	ANTENNA FACTOR (dB/m)	CABLE LOSS (dB)	PREAMP FACTOR (dB)	ANTENNA HEIGHT (cm)	TABLE ANGLE (Degree)	REMARK
5370	38.72	39.01	54	-15.28	31.49	5.4	37.18	100	312	Average
5370	55.22	55.51	74	-18.78	31.49	5.4	37.18	100	312	Peak
5470	54.97	55.03	68.3	-13.33	31.57	5.45	37.08	100	312	Peak
5550	90.01	89.93			31.68	5.49	37.09	100	312	Average
5550	99.63	99.55			31.68	5.49	37.09	100	312	Peak
5725	53.86	53.74	68.3	-14.44	31.96	5.59	37.43	100	312	Peak
ANTENNA POLARITY & TEST DISTANCE: VERTICAL AT 3 M										
FREQ. (MHz)	EMISSION LEVEL (dBuV/m)	READ LEVEL (dBuV)	LIMIT (dBuV/m)	MARGIN (dB)	ANTENNA FACTOR (dB/m)	CABLE LOSS (dB)	PREAMP FACTOR (dB)	ANTENNA HEIGHT (cm)	TABLE ANGLE (Degree)	REMARK
5452	38.99	39.07	54	-15.01	31.56	5.44	37.08	100	58	Average
5452	54.91	54.99	74	-19.09	31.56	5.44	37.08	100	58	Peak
5470	53.4	53.46	68.3	-14.9	31.57	5.45	37.08	100	58	Peak
5550	90.75	90.67			31.68	5.49	37.09	100	58	Average
5550	99.91	99.83			31.68	5.49	37.09	100	58	Peak
5725	54.61	54.49	68.3	-13.69	31.96	5.59	37.43	100	58	Peak

REMARKS:

- Emission Level = Read Level + Antenna Factor + Cable Loss - Preamp Factor
Margin value = Emission level – Limit value
- 5550MHz: Fundamental frequency.
- 5470MHz & 5725MHz: Out of restricted band



A D T

EUT TEST CONDITION		MEASUREMENT DETAIL	
CHANNEL	Channel 134	FREQUENCY RANGE	1GHz ~ 40GHz
INPUT POWER (SYSTEM)	120Vac, 60 Hz	DETECTOR FUNCTION	Peak (PK) Average (AV)
ENVIRONMENTAL CONDITIONS	25deg. C, 65%RH	TESTED BY	Johnson Liao

ANTENNA POLARITY & TEST DISTANCE: HORIZONTAL AT 3 M										
FREQ. (MHz)	EMISSION LEVEL (dBuV/m)	READ LEVEL (dBuV)	LIMIT (dBuV/m)	MARGIN (dB)	ANTENNA FACTOR (dB/m)	CABLE LOSS (dB)	PREAMP FACTOR (dB)	ANTENNA HEIGHT (cm)	TABLE ANGLE (Degree)	REMARK
5418	38.15	38.38	54	-15.85	31.53	5.42	37.18	100	308	Average
5418	55.79	56.02	74	-18.21	31.53	5.42	37.18	100	308	Peak
5470	54.57	54.63	68.3	-13.73	31.57	5.45	37.08	100	308	Peak
5670	89.89	89.79			31.88	5.56	37.34	100	308	Average
5670	98.15	98.05			31.88	5.56	37.34	100	308	Peak
5725	55.35	55.23	68.3	-12.95	31.96	5.59	37.43	100	308	Peak
ANTENNA POLARITY & TEST DISTANCE: VERTICAL AT 3 M										
FREQ. (MHz)	EMISSION LEVEL (dBuV/m)	READ LEVEL (dBuV)	LIMIT (dBuV/m)	MARGIN (dB)	ANTENNA FACTOR (dB/m)	CABLE LOSS (dB)	PREAMP FACTOR (dB)	ANTENNA HEIGHT (cm)	TABLE ANGLE (Degree)	REMARK
5460	38.14	38.22	54	-15.86	31.56	5.44	37.08	100	38	Average
5460	55.29	55.37	74	-18.71	31.56	5.44	37.08	100	38	Peak
5470	54.4	54.46	68.3	-13.9	31.57	5.45	37.08	100	38	Peak
5670	90.58	90.48			31.88	5.56	37.34	100	38	Average
5670	99.41	99.31			31.88	5.56	37.34	100	38	Peak
5725	54.49	54.37	68.3	-13.81	31.96	5.59	37.43	100	38	Peak

REMARKS:

- Emission Level = Read Level + Antenna Factor + Cable Loss - Preamp Factor
Margin value = Emission level – Limit value
- 5670MHz: Fundamental frequency.
- 5470MHz & 5725MHz: Out of restricted band



A D T

802.11ac (80MHz)

EUT TEST CONDITION		MEASUREMENT DETAIL	
CHANNEL	Channel 42	FREQUENCY RANGE	1GHz ~ 40GHz
INPUT POWER (SYSTEM)	120Vac, 60 Hz	DETECTOR FUNCTION	Peak (PK) Average (AV)
ENVIRONMENTAL CONDITIONS	25deg. C, 65%RH	TESTED BY	Johnson Liao

ANTENNA POLARITY & TEST DISTANCE: HORIZONTAL AT 3 M										
FREQ. (MHz)	EMISSION LEVEL (dBuV/m)	READ LEVEL (dBuV)	LIMIT (dBuV/m)	MARGIN (dB)	ANTENNA FACTOR (dB/m)	CABLE LOSS (dB)	PREAMP FACTOR (dB)	ANTENNA HEIGHT (cm)	TABLE ANGLE (Degree)	REMARK
5148	41.67	42.38	54	-12.33	31.32	5.29	37.32	100	309	Average
5148	56.48	57.19	74	-17.52	31.32	5.29	37.32	100	309	Peak
5210	85.07	85.74			31.37	5.32	37.36	100	309	Average
5210	94.6	95.27			31.37	5.32	37.36	100	309	Peak
5366	38.67	38.96	54	-15.33	31.49	5.4	37.18	100	309	Average
5366	55.43	55.72	74	-18.57	31.49	5.4	37.18	100	309	Peak
ANTENNA POLARITY & TEST DISTANCE: VERTICAL AT 3 M										
FREQ. (MHz)	EMISSION LEVEL (dBuV/m)	READ LEVEL (dBuV)	LIMIT (dBuV/m)	MARGIN (dB)	ANTENNA FACTOR (dB/m)	CABLE LOSS (dB)	PREAMP FACTOR (dB)	ANTENNA HEIGHT (cm)	TABLE ANGLE (Degree)	REMARK
5150	42.33	43.04	54	-11.67	31.32	5.29	37.32	100	50	Average
5150	58.17	58.88	74	-15.83	31.32	5.29	37.32	100	50	Peak
5210	87.4	88.07			31.37	5.32	37.36	100	50	Average
5210	96.15	96.82			31.37	5.32	37.36	100	50	Peak
5458	38.94	39.02	54	-15.06	31.56	5.44	37.08	100	50	Average
5458	55.6	55.68	74	-18.4	31.56	5.44	37.08	100	50	Peak

REMARKS:

- Emission Level = Read Level + Antenna Factor + Cable Loss - Preamp Factor
Margin value = Emission level – Limit value
- 5210MHz: Fundamental frequency.



A D T

EUT TEST CONDITION		MEASUREMENT DETAIL	
CHANNEL	Channel 58	FREQUENCY RANGE	1GHz ~ 40GHz
INPUT POWER (SYSTEM)	120Vac, 60 Hz	DETECTOR FUNCTION	Peak (PK) Average (AV)
ENVIRONMENTAL CONDITIONS	25deg. C, 65%RH	TESTED BY	Johnson Liao

ANTENNA POLARITY & TEST DISTANCE: HORIZONTAL AT 3 M										
FREQ. (MHz)	EMISSION LEVEL (dBuV/m)	READ LEVEL (dBuV)	LIMIT (dBuV/m)	MARGIN (dB)	ANTENNA FACTOR (dB/m)	CABLE LOSS (dB)	PREAMP FACTOR (dB)	ANTENNA HEIGHT (cm)	TABLE ANGLE (Degree)	REMARK
5034	38.5	39.27	54	-15.5	31.23	5.24	37.24	100	308	Average
5034	55.16	55.93	74	-18.84	31.23	5.24	37.24	100	308	Peak
5290	85.25	85.68			31.43	5.37	37.23	100	308	Average
5290	94.5	94.93			31.43	5.37	37.23	100	308	Peak
5366	40.12	40.41	54	-13.88	31.49	5.4	37.18	100	308	Average
5366	57.47	57.76	74	-16.53	31.49	5.4	37.18	100	308	Peak
ANTENNA POLARITY & TEST DISTANCE: VERTICAL AT 3 M										
FREQ. (MHz)	EMISSION LEVEL (dBuV/m)	READ LEVEL (dBuV)	LIMIT (dBuV/m)	MARGIN (dB)	ANTENNA FACTOR (dB/m)	CABLE LOSS (dB)	PREAMP FACTOR (dB)	ANTENNA HEIGHT (cm)	TABLE ANGLE (Degree)	REMARK
5040	38.6	39.35	54	-15.4	31.24	5.25	37.24	108	48	Average
5040	55.2	55.95	74	-18.8	31.24	5.25	37.24	108	48	Peak
5290	87.35	87.78			31.43	5.37	37.23	108	48	Average
5290	96.12	96.55			31.43	5.37	37.23	108	48	Peak
5368	41.92	42.21	54	-12.08	31.49	5.4	37.18	108	48	Average
5368	57.89	58.18	74	-16.11	31.49	5.4	37.18	108	48	Peak

REMARKS:

- Emission Level = Read Level + Antenna Factor + Cable Loss - Preamp Factor
Margin value = Emission level – Limit value
- 5290MHz: Fundamental frequency.



A D T

EUT TEST CONDITION		MEASUREMENT DETAIL	
CHANNEL	Channel 106	FREQUENCY RANGE	1GHz ~ 40GHz
INPUT POWER (SYSTEM)	120Vac, 60 Hz	DETECTOR FUNCTION	Peak (PK) Average (AV)
ENVIRONMENTAL CONDITIONS	25deg. C, 65%RH	TESTED BY	Johnson Liao

ANTENNA POLARITY & TEST DISTANCE: HORIZONTAL AT 3 M										
FREQ. (MHz)	EMISSION LEVEL (dBuV/m)	READ LEVEL (dBuV)	LIMIT (dBuV/m)	MARGIN (dB)	ANTENNA FACTOR (dB/m)	CABLE LOSS (dB)	PREAMP FACTOR (dB)	ANTENNA HEIGHT (cm)	TABLE ANGLE (Degree)	REMARK
5452	41.51	41.59	54	-12.49	31.56	5.44	37.08	100	311	Average
5452	56.68	56.76	74	-17.32	31.56	5.44	37.08	100	311	Peak
5470	60.74	60.8	68.3	-7.56	31.57	5.45	37.08	100	311	Peak
5530	87.77	87.76			31.63	5.47	37.09	100	311	Average
5530	96.95	96.94			31.63	5.47	37.09	100	311	Peak
5725	55.7	55.58	68.3	-12.6	31.96	5.59	37.43	100	311	Peak
ANTENNA POLARITY & TEST DISTANCE: VERTICAL AT 3 M										
FREQ. (MHz)	EMISSION LEVEL (dBuV/m)	READ LEVEL (dBuV)	LIMIT (dBuV/m)	MARGIN (dB)	ANTENNA FACTOR (dB/m)	CABLE LOSS (dB)	PREAMP FACTOR (dB)	ANTENNA HEIGHT (cm)	TABLE ANGLE (Degree)	REMARK
5460	42.17	42.25	54	-11.83	31.56	5.44	37.08	100	67	Average
5460	57.66	57.74	74	-16.34	31.56	5.44	37.08	100	67	Peak
5470	62.29	62.35	68.3	-6.01	31.57	5.45	37.08	100	67	Peak
5530	88.67	88.66			31.63	5.47	37.09	100	67	Average
5530	97.26	97.25			31.63	5.47	37.09	100	67	Peak
5725	54.19	54.07	68.3	-14.11	31.96	5.59	37.43	100	67	Peak

REMARKS:

- Emission Level = Read Level + Antenna Factor + Cable Loss - Preamp Factor
Margin value = Emission level – Limit value
- 5530MHz: Fundamental frequency.
- 5470MHz & 5725MHz: Out of restricted band



A D T

TEST MODE B**802.11n (20MHz)**

EUT TEST CONDITION		MEASUREMENT DETAIL	
CHANNEL	Channel 140	FREQUENCY RANGE	1GHz ~ 40GHz
INPUT POWER (SYSTEM)	120Vac, 60 Hz	DETECTOR FUNCTION	Peak (PK) Average (AV)
ENVIRONMENTAL CONDITIONS	25deg. C, 65%RH	TESTED BY	Johnson Liao

ANTENNA POLARITY & TEST DISTANCE: HORIZONTAL AT 3 M										
FREQ. (MHz)	EMISSION LEVEL (dBuV/m)	READ LEVEL (dBuV)	LIMIT (dBuV/m)	MARGIN (dB)	ANTENNA FACTOR (dB/m)	CABLE LOSS (dB)	PREAMP FACTOR (dB)	ANTENNA HEIGHT (cm)	TABLE ANGLE (Degree)	REMARK
5418	37.65	37.83	54	-16.35	31.53	5.42	37.13	105	114	Average
5418	54.48	54.66	74	-19.52	31.53	5.42	37.13	105	114	Peak
5470	53.32	53.38	68.3	-14.98	31.57	5.45	37.08	105	114	Peak
5700	93.3	93.23			31.9	5.57	37.4	105	114	Average
5700	102.1	102.03			31.9	5.57	37.4	105	114	Peak
5725	63.22	63.1	68.3	-5.08	31.96	5.59	37.43	105	114	Peak
ANTENNA POLARITY & TEST DISTANCE: VERTICAL AT 3 M										
FREQ. (MHz)	EMISSION LEVEL (dBuV/m)	READ LEVEL (dBuV)	LIMIT (dBuV/m)	MARGIN (dB)	ANTENNA FACTOR (dB/m)	CABLE LOSS (dB)	PREAMP FACTOR (dB)	ANTENNA HEIGHT (cm)	TABLE ANGLE (Degree)	REMARK
5418	37.65	37.83	54	-16.35	31.53	5.42	37.13	105	114	Average
5418	54.48	54.66	74	-19.52	31.53	5.42	37.13	105	114	Peak
5470	53.32	53.38	68.3	-14.98	31.57	5.45	37.08	105	114	Peak
5700	93.3	93.23			31.9	5.57	37.4	105	114	Average
5700	102.1	102.03			31.9	5.57	37.4	105	114	Peak
5725	63.22	63.1	68.3	-5.08	31.96	5.59	37.43	105	114	Peak

REMARKS:

- Emission Level = Read Level + Antenna Factor + Cable Loss - Preamp Factor
Margin value = Emission level – Limit value
- 5700MHz: Fundamental frequency.
- 5470MHz & 5725MHz: Out of restricted band



A D T

BELOW 1GHz WORST-CASE DATA:

TEST MODE A

802.11n (20MHz)

EUT TEST CONDITION		MEASUREMENT DETAIL	
CHANNEL	Channel 36	FREQUENCY RANGE	30MHz ~ 1GHz
INPUT POWER (SYSTEM)	120Vac, 60 Hz	DETECTOR FUNCTION	Peak (PK)
ENVIRONMENTAL CONDITIONS	25deg. C, 65%RH	TESTED BY	Johnson Liao

ANTENNA POLARITY & TEST DISTANCE: HORIZONTAL AT 3 M										
FREQ. (MHz)	EMISSION LEVEL (dBuV/m)	READ LEVEL (dBuV)	LIMIT (dBuV/m)	MARGIN (dB)	ANTENNA FACTOR (dB/m)	CABLE LOSS (dB)	PREAMP FACTOR (dB)	ANTENNA HEIGHT (cm)	TABLE ANGLE (Degree)	REMARK
57.27	27.38	45.67	40	-12.62	12.25	0.81	31.35	101	320	Peak
108.84	25.96	46.79	43.5	-17.54	9.9	1.12	31.85	100	124	Peak
183.09	34.32	54.07	43.5	-9.18	10.53	1.51	31.79	100	288	Peak
314.7	20.96	37.46	46	-25.04	13.31	2.11	31.92	100	177	Peak
502.3	21.19	32.64	46	-24.81	17.37	2.79	31.61	100	111	Peak
705.3	26	33.42	46	-20	20.89	3.45	31.76	100	252	Peak

ANTENNA POLARITY & TEST DISTANCE: VERTICAL AT 3 M										
FREQ. (MHz)	EMISSION LEVEL (dBuV/m)	READ LEVEL (dBuV)	LIMIT (dBuV/m)	MARGIN (dB)	ANTENNA FACTOR (dB/m)	CABLE LOSS (dB)	PREAMP FACTOR (dB)	ANTENNA HEIGHT (cm)	TABLE ANGLE (Degree)	REMARK
57.54	33.96	52.25	40	-6.04	12.25	0.81	31.35	102	132	Peak
158.52	25.15	42.87	43.5	-18.35	12.73	1.38	31.83	100	44	Peak
183.9	26.68	46.47	43.5	-16.82	10.46	1.52	31.77	100	216	Peak
378.4	18.51	33.29	46	-27.49	14.82	2.34	31.94	100	176	Peak
558.3	22.1	32.52	46	-23.9	18.66	2.97	32.05	100	132	Peak
681.5	25.07	32.95	46	-20.93	20.6	3.36	31.84	100	76	Peak

REMARKS: Emission Level = Read Level + Antenna Factor + Cable Loss - Preamp Factor
 Margin value = Emission level – Limit value



A D T

802.11n (20MHz)

EUT TEST CONDITION		MEASUREMENT DETAIL	
CHANNEL	Channel 64	FREQUENCY RANGE	30MHz ~ 1GHz
INPUT POWER (SYSTEM)	120Vac, 60 Hz	DETECTOR FUNCTION	Peak (PK)
ENVIRONMENTAL CONDITIONS	25deg. C, 65%RH	TESTED BY	Johnson Liao

ANTENNA POLARITY & TEST DISTANCE: HORIZONTAL AT 3 M										
FREQ. (MHz)	EMISSION LEVEL (dBuV/m)	READ LEVEL (dBuV)	LIMIT (dBuV/m)	MARGIN (dB)	ANTENNA FACTOR (dB/m)	CABLE LOSS (dB)	PREAMP FACTOR (dB)	ANTENNA HEIGHT (cm)	TABLE ANGLE (Degree)	REMARK
57.81	27.15	45.54	40	-12.85	12.15	0.81	31.35	100	268	Peak
108.3	26.24	47.07	43.5	-17.26	9.9	1.12	31.85	100	231	Peak
183.63	34.16	53.91	43.5	-9.34	10.53	1.51	31.79	100	303	Peak
321	20.62	36.92	46	-25.38	13.45	2.13	31.88	100	280	Peak
521.9	21.73	32.65	46	-24.27	17.82	2.85	31.59	100	172	Peak
665.4	25.2	33.37	46	-20.8	20.4	3.3	31.87	100	125	Peak
ANTENNA POLARITY & TEST DISTANCE: VERTICAL AT 3 M										
FREQ. (MHz)	EMISSION LEVEL (dBuV/m)	READ LEVEL (dBuV)	LIMIT (dBuV/m)	MARGIN (dB)	ANTENNA FACTOR (dB/m)	CABLE LOSS (dB)	PREAMP FACTOR (dB)	ANTENNA HEIGHT (cm)	TABLE ANGLE (Degree)	REMARK
57	33.18	51.47	40	-6.82	12.25	0.81	31.35	100	263	Peak
105.87	20.69	41.86	43.5	-22.81	9.62	1.1	31.89	100	203	Peak
183.63	26.7	46.45	43.5	-16.8	10.53	1.51	31.79	100	194	Peak
326.6	18.85	34.94	46	-27.15	13.59	2.15	31.83	100	12	Peak
439.3	20.22	33.52	46	-25.78	16.12	2.58	32	100	170	Peak
575.1	22.83	32.88	46	-23.17	19.03	3.02	32.1	100	122	Peak

REMARKS: Emission Level = Read Level + Antenna Factor + Cable Loss - Preamp Factor
 Margin value = Emission level – Limit value



A D T

802.11n (20MHz)

EUT TEST CONDITION		MEASUREMENT DETAIL	
CHANNEL	Channel 140	FREQUENCY RANGE	30MHz ~ 1GHz
INPUT POWER (SYSTEM)	120Vac, 60 Hz	DETECTOR FUNCTION	Peak (PK)
ENVIRONMENTAL CONDITIONS	25deg. C, 65%RH	TESTED BY	Johnson Liao

ANTENNA POLARITY & TEST DISTANCE: HORIZONTAL AT 3 M										
FREQ. (MHz)	EMISSION LEVEL (dBuV/m)	READ LEVEL (dBuV)	LIMIT (dBuV/m)	MARGIN (dB)	ANTENNA FACTOR (dB/m)	CABLE LOSS (dB)	PREAMP FACTOR (dB)	ANTENNA HEIGHT (cm)	TABLE ANGLE (Degree)	REMARK
57.27	27.15	45.44	40	-12.85	12.25	0.81	31.35	100	264	Peak
108.3	25.75	46.58	43.5	-17.75	9.9	1.12	31.85	100	168	Peak
189.3	34.22	54.25	43.5	-9.28	10.12	1.54	31.69	100	239	Peak
318.2	21.27	37.67	46	-24.73	13.38	2.12	31.9	100	279	Peak
506.5	21.59	32.93	46	-24.41	17.46	2.8	31.6	100	23	Peak
661.2	24.5	32.78	46	-21.5	20.35	3.29	31.92	100	130	Peak
ANTENNA POLARITY & TEST DISTANCE: VERTICAL AT 3 M										
FREQ. (MHz)	EMISSION LEVEL (dBuV/m)	READ LEVEL (dBuV)	LIMIT (dBuV/m)	MARGIN (dB)	ANTENNA FACTOR (dB/m)	CABLE LOSS (dB)	PREAMP FACTOR (dB)	ANTENNA HEIGHT (cm)	TABLE ANGLE (Degree)	REMARK
57.27	33.52	51.81	40	-6.48	12.25	0.81	31.35	100	135	Peak
183.09	26.77	46.52	43.5	-16.73	10.53	1.51	31.79	100	235	Peak
219.54	23.13	42.96	46	-22.87	10.18	1.69	31.7	100	119	Peak
412.7	19.01	32.94	46	-26.99	15.6	2.48	32.01	100	247	Peak
600.3	23.03	32.58	46	-22.97	19.61	3.09	32.25	100	155	Peak
731.9	25.69	32.47	46	-20.31	21.27	3.52	31.57	100	130	Peak

REMARKS: Emission Level = Read Level + Antenna Factor + Cable Loss - Preamp Factor
Margin value = Emission level – Limit value



A D T

TEST MODE B

802.11n (20MHz)

EUT TEST CONDITION		MEASUREMENT DETAIL	
CHANNEL	Channel 140	FREQUENCY RANGE	30MHz ~ 1GHz
INPUT POWER (SYSTEM)	120Vac, 60 Hz	DETECTOR FUNCTION	Peak (PK)
ENVIRONMENTAL CONDITIONS	25deg. C, 65%RH	TESTED BY	Johnson Liao

ANTENNA POLARITY & TEST DISTANCE: HORIZONTAL AT 3 M										
FREQ. (MHz)	EMISSION LEVEL (dBuV/m)	READ LEVEL (dBuV)	LIMIT (dBuV/m)	MARGIN (dB)	ANTENNA FACTOR (dB/m)	CABLE LOSS (dB)	PREAMP FACTOR (dB)	ANTENNA HEIGHT (cm)	TABLE ANGLE (Degree)	REMARK
69.96	23.85	44	40	-16.15	10.77	0.9	31.82	101	214	Peak
127.2	24.26	43.45	43.5	-19.24	11.48	1.22	31.89	100	313	Peak
194.7	32.9	53.35	43.5	-10.6	9.7	1.57	31.72	100	178	Peak
345.5	18.42	34.01	46	-27.58	14.03	2.21	31.83	100	153	Peak
552.7	22.31	32.8	46	-23.69	18.53	2.96	31.98	100	66	Peak
706.7	24.63	32.02	46	-21.37	20.92	3.45	31.76	100	273	Peak
ANTENNA POLARITY & TEST DISTANCE: VERTICAL AT 3 M										
FREQ. (MHz)	EMISSION LEVEL (dBuV/m)	READ LEVEL (dBuV)	LIMIT (dBuV/m)	MARGIN (dB)	ANTENNA FACTOR (dB/m)	CABLE LOSS (dB)	PREAMP FACTOR (dB)	ANTENNA HEIGHT (cm)	TABLE ANGLE (Degree)	REMARK
31.08	30.38	48.79	40	-9.62	12.14	0.57	31.12	100	62	Peak
147.99	23.35	41	43.5	-20.15	12.64	1.33	31.62	102	108	Peak
231.96	20.53	39.91	46	-25.47	10.71	1.75	31.84	100	96	Peak
342	17.07	32.73	46	-28.93	13.96	2.2	31.82	100	152	Peak
537.3	21.83	32.47	46	-24.17	18.17	2.91	31.72	100	269	Peak
669.6	24.4	32.47	46	-21.6	20.44	3.31	31.82	100	70	Peak

REMARKS: Emission Level = Read Level + Antenna Factor + Cable Loss - Preamp Factor
Margin value = Emission level – Limit value

4.2 CONDUCTED EMISSION MEASUREMENT

4.2.1 LIMITS OF CONDUCTED EMISSION MEASUREMENT

FREQUENCY OF EMISSION (MHz)	CONDUCTED LIMIT (dB μ V)	
	Quasi-peak	Average
0.15 ~ 0.5	66 to 56	56 to 46
0.5 ~ 5	56	46
5 ~ 30	60	50

- NOTE:** 1. The lower limit shall apply at the transition frequencies.
2. The limit decreases in line with the logarithm of the frequency in the range of 0.15 to 0.50MHz.
3. All emanations from a class A/B digital device or system, including any network of conductors and apparatus connected thereto, shall not exceed the level of field strengths specified above.

4.2.2 TEST INSTRUMENTS

Tested Date: Nov. 21, 2013

DESCRIPTION & MANUFACTURER	MODEL NO.	SERIAL NO.	DATE OF CALIBRATION	DUE DATE OF CALIBRATION
Test Receiver ROHDE & SCHWARZ	ESCS30	100288	Nov. 17, 2013	Nov. 16, 2014
RF signal cable Woken	5D-FB	Cable-HYCO2-01	Dec. 28, 2012	Dec. 27, 2013
LISN ROHDE & SCHWARZ (EUT)	ESH2-Z5	100100	Dec. 21, 2012	Dec. 20, 2013
LISN ROHDE & SCHWARZ (Peripheral)	ESH3-Z5	100312	Jul. 08, 2013	Jul. 07, 2014
Software ADT	BV ADT_Cond_ V7.3.7.3	NA	NA	NA

- NOTE:** 1. The calibration interval of the above test instruments is 12 months and the calibrations are traceable to NML/ROC and NIST/USA.
2. The test was performed in HwaYa Shielded Room 2.
3. The VCCI Site Registration No. is C-2047.



A D T

4.2.3 TEST PROCEDURES

- a. The EUT was placed 0.4 meters from the conducting wall of the shielded room with EUT being connected to the power mains through a line impedance stabilization network (LISN). Other support units were connected to the power mains through another LISN. The two LISNs provide 50 ohm/ 50uH of coupling impedance for the measuring instrument.
- b. Both lines of the power mains connected to the EUT were checked for maximum conducted interference.
- c. The frequency range from 150kHz to 30MHz was searched. Emission levels under (Limit - 20dB) was not recorded.

NOTE: All modes of operation were investigated and the worst-case emissions are reported.

4.2.4 DEVIATION FROM TEST STANDARD

No deviation.

4.2.5 TEST SETUP

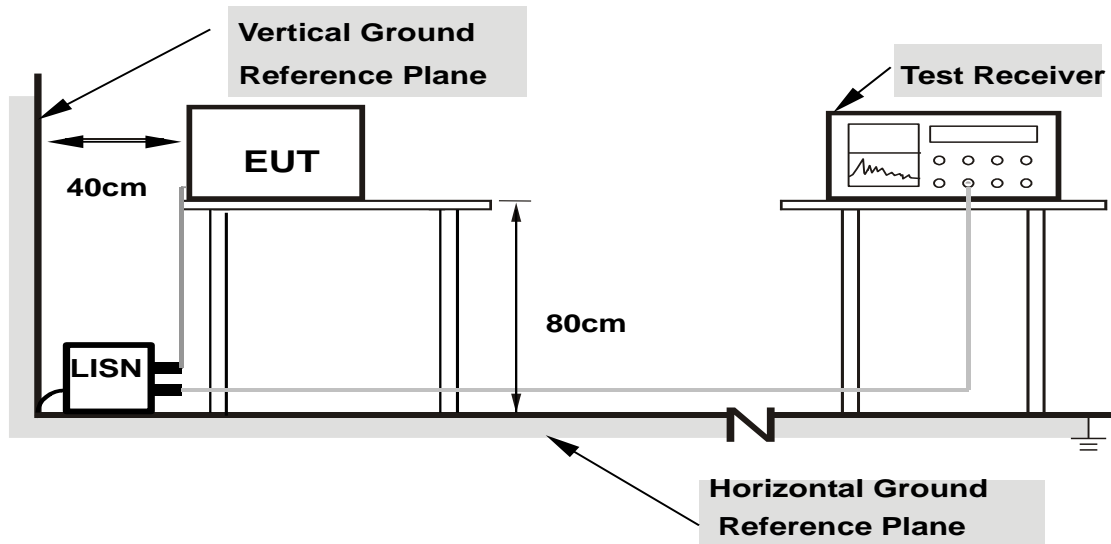

- Note:**
- 1.Support units were connected to second LISN.
 - 2.Both of LISNs (AMN) are 80 cm from EUT and at least 80 from other units and other metal planes

For the actual test configuration, please refer to the attached file (Test Setup Photo).

4.2.6 EUT OPERATING CONDITIONS

Same as 4.1.6.

4.2.7 TEST RESULTS

CONDUCTED WORST-CASE DATA :

PHASE	Line 1	6dB BANDWIDTH	9kHz
--------------	--------	----------------------	------

No	Freq.	Corr. Factor	Reading Value		Emission Level		Limit		Margin	
	[MHz]		[dB (uV)]		[dB (uV)]		[dB (uV)]		(dB)	
			Q.P.	AV.	Q.P.	AV.	Q.P.	AV.	Q.P.	AV.
1	0.17344	0.17	37.37	28.50	37.54	28.67	64.79	54.79	-27.25	-26.12
2	0.43125	0.21	31.30	22.36	31.51	22.57	57.23	47.23	-25.72	-24.66
3	0.70469	0.24	31.70	22.56	31.94	22.80	56.00	46.00	-24.06	-23.20
4	1.29688	0.27	28.25	18.13	28.52	18.40	56.00	46.00	-27.48	-27.60
5	13.55859	0.50	39.01	36.86	39.51	37.36	60.00	50.00	-20.49	-12.64
6	20.51172	0.64	22.19	15.95	22.83	16.59	60.00	50.00	-37.17	-33.41

REMARKS:

1. Q.P. and AV. are abbreviations of quasi-peak and average individually.
2. The emission levels of other frequencies were very low against the limit.
3. Margin value = Emission level - Limit value
4. Correction factor = Insertion loss + Cable loss
5. Emission Level = Correction Factor + Reading Value

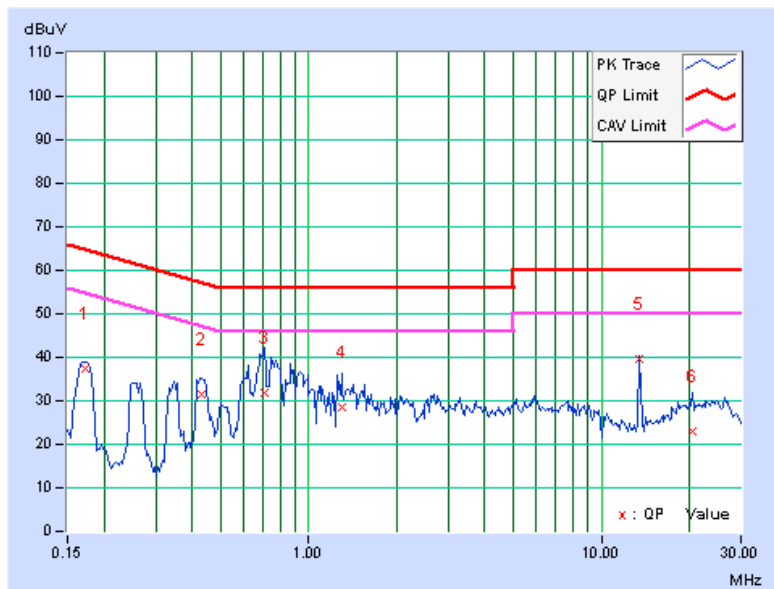

PHASE	Line 2	6dB BANDWIDTH	9kHz
-------	--------	---------------	------

No	Freq. [MHz]	Corr. Factor (dB)	Reading Value [dB (uV)]		Emission Level [dB (uV)]		Limit [dB (uV)]		Margin (dB)	
			Q.P.	AV.	Q.P.	AV.	Q.P.	AV.	Q.P.	AV.
			1	0.25938	0.20	34.84	22.93	35.04	23.13	61.45
2	0.42344	0.25	33.71	21.15	33.96	21.40	57.38	47.38	-23.42	-25.98
3	0.77109	0.24	33.99	21.88	34.23	22.12	56.00	46.00	-21.77	-23.88
4	1.52344	0.26	27.22	16.00	27.48	16.26	56.00	46.00	-28.52	-29.74
5	7.01563	0.44	23.42	13.47	23.86	13.91	60.00	50.00	-36.14	-36.09
6	13.55859	0.57	39.60	35.02	40.17	35.59	60.00	50.00	-19.83	-14.41

REMARKS:

1. Q.P. and AV. are abbreviations of quasi-peak and average individually.
2. The emission levels of other frequencies were very low against the limit.
3. Margin value = Emission level - Limit value
4. Correction factor = Insertion loss + Cable loss
5. Emission Level = Correction Factor + Reading Value

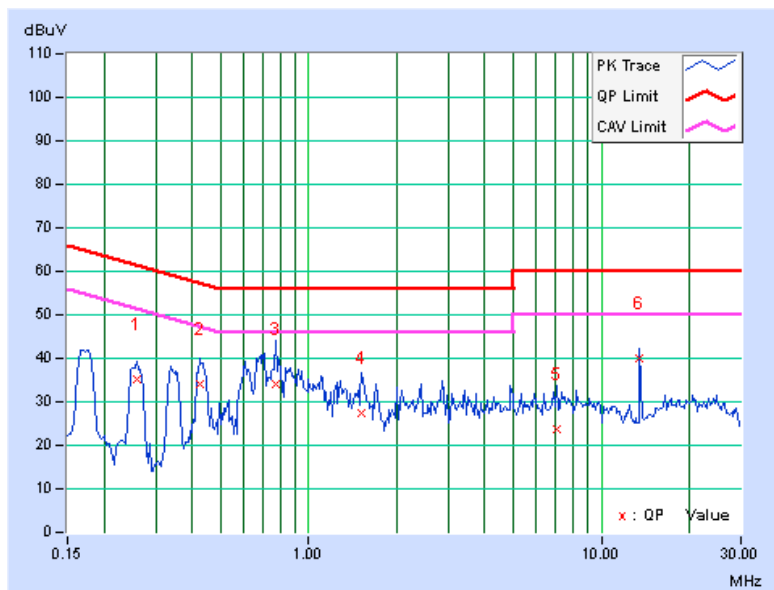

4.3 PEAK TRANSMIT POWER MEASUREMENT

4.3.1 LIMITS OF PEAK TRANSMIT POWER MEASUREMENT

FREQUENCY BAND	LIMIT
5.150 ~ 5.250GHz	The lesser of 50mW (17dBm) or 4dBm + 10logB
5.250 ~ 5.350GHz	The lesser of 250mW (24dBm) or 11dBm + 10logB
5.470 ~ 5.725GHz	The lesser of 250mW (24dBm) or 11dBm + 10logB

NOTE: Where B is the 26dB emission bandwidth in MHz.

4.3.2 TEST SETUP

FOR POWER OUTPUT MEASUREMENT

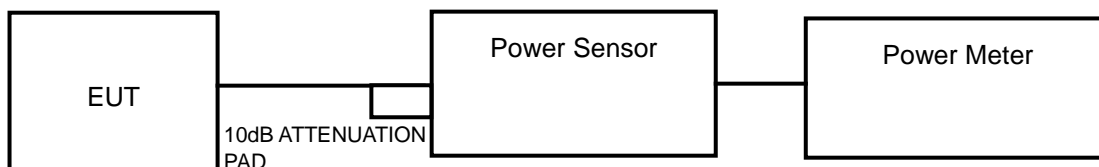

or

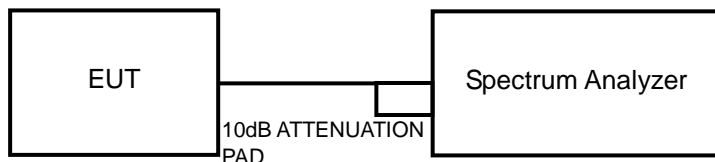

FOR 26dB BANDWIDTH

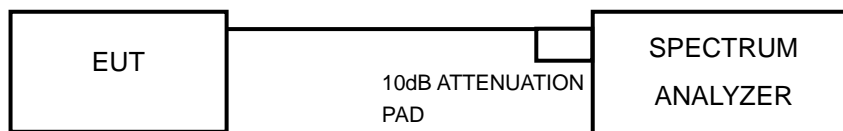

4.3.3 TEST INSTRUMENTS

Refer to section 4.1.3 to get information of above instrument.

4.3.4 TEST PROCEDURE

FOR AVERAGE POWER MEASUREMENT

<802.11a, 802.11n (20MHz), 802.11n (40MHz)>

Method PM is used to perform output power measurement, trigger and gating function of wide band power meter is enabled to measure max output power of TX on burst.

Duty factor is not added to measured value.

<802.11ac (80MHz)>

Method SA-1 is used to perform output power measurement, trigger and gating function of spectrum analyzer is enabled to measure max output power of TX on burst.

Duty factor is not added to measured value.

FOR 26dB BANDWIDTH

- 1) Set RBW = approximately 1% of the emission bandwidth.
- 2) Set the VBW > RBW.
- 3) Detector = Peak.
- 4) Trace mode = max hold.
- 5) Measure the maximum width of the emission that is 26 dB down from the peak of the emission. Compare this with the RBW setting of the analyzer. Readjust RBW and repeat measurement as needed until the RBW/EBW ratio is approximately 1%.

4.3.5 DEVIATION FROM TEST STANDARD

No deviation.

4.3.6 EUT OPERATING CONDITIONS

The software provided by client to enable the EUT under transmission condition continuously at specific channel frequencies individually.



A D T

4.3.7 TEST RESULTS

POWER OUTPUT: 802.11a

CHANNEL	CHANNEL FREQUENCY (MHz)	AVERAGE POWER (mW)	AVERAGE POWER (dBm)	POWER LIMIT (dBm)	PASS/FAIL
36	5180	42.364	16.27	17	PASS
44	5220	42.756	16.31	17	PASS
48	5240	40.926	16.12	17	PASS
52	5260	42.073	16.24	24	PASS
60	5300	42.462	16.28	24	PASS
64	5320	43.451	16.38	24	PASS
100	5500	42.954	16.33	24	PASS
116	5580	41.976	16.23	24	PASS
140	5700	41.210	16.15	24	PASS

802.11n (20MHz)

CHANNEL	CHANNEL FREQUENCY (MHz)	AVERAGE POWER (mW)	AVERAGE POWER (dBm)	POWER LIMIT (dBm)	PASS/FAIL
36	5180	43.152	16.35	17	PASS
44	5220	41.305	16.16	17	PASS
48	5240	43.251	16.36	17	PASS
52	5260	50.699	17.05	24	PASS
60	5300	52.240	17.18	24	PASS
64	5320	50.699	17.05	24	PASS
100	5500	54.702	17.38	24	PASS
116	5580	51.880	17.15	24	PASS
140	5700	51.523	17.12	24	PASS



A D T

802.11n (40MHz)

CHANNEL	CHANNEL FREQUENCY (MHz)	AVERAGE POWER (mW)	AVERAGE POWER (dBm)	POWER LIMIT (dBm)	PASS/FAIL
38	5190	21.478	13.32	17	PASS
46	5230	21.577	13.34	17	PASS
54	5270	21.777	13.38	24	PASS
62	5310	21.928	13.41	24	PASS
102	5510	22.029	13.43	24	PASS
110	5550	21.577	13.34	24	PASS
134	5670	22.131	13.45	24	PASS

802.11ac (80MHz)

CHANNEL	CHANNEL FREQUENCY (MHz)	AVERAGE POWER (mW)	AVERAGE POWER (dBm)	POWER LIMIT (dBm)	PASS/FAIL
42	5210	19.999	13.01	17	PASS
58	5290	20.137	13.04	24	PASS
106	5530	19.861	12.98	24	PASS



26dB BANDWIDTH: 802.11a

CHANNEL	CHANNEL FREQUENCY (MHz)	26dBc BANDWIDTH (MHz)	PASS / FAIL
36	5180	26.99	PASS
44	5220	27.75	PASS
48	5240	22.68	PASS
52	5260	22.63	PASS
60	5300	23.10	PASS
64	5320	24.97	PASS
100	5500	24.12	PASS
116	5580	23.78	PASS
140	5700	22.40	PASS

802.11n (20MHz)

CHANNEL	CHANNEL FREQUENCY (MHz)	26dBc BANDWIDTH (MHz)	PASS / FAIL
36	5180	26.39	PASS
44	5220	29.73	PASS
48	5240	27.81	PASS
52	5260	27.14	PASS
60	5300	26.08	PASS
64	5320	27.73	PASS
100	5500	25.92	PASS
116	5580	27.51	PASS
140	5700	28.27	PASS

802.11n (40MHz)

CHANNEL	CHANNEL FREQUENCY (MHz)	26dBc BANDWIDTH (MHz)	PASS / FAIL
38	5190	45.16	PASS
46	5230	46.11	PASS
54	5270	45.39	PASS
62	5310	46.58	PASS
102	5510	45.63	PASS
110	5550	46.05	PASS
134	5670	45.12	PASS



A D T

802.11ac (80MHz)

CHANNEL	CHANNEL FREQUENCY (MHz)	26dBc BANDWIDTH (MHz)	PASS / FAIL
42	5210	83.56	PASS
58	5290	83.43	PASS
106	5530	83.44	PASS

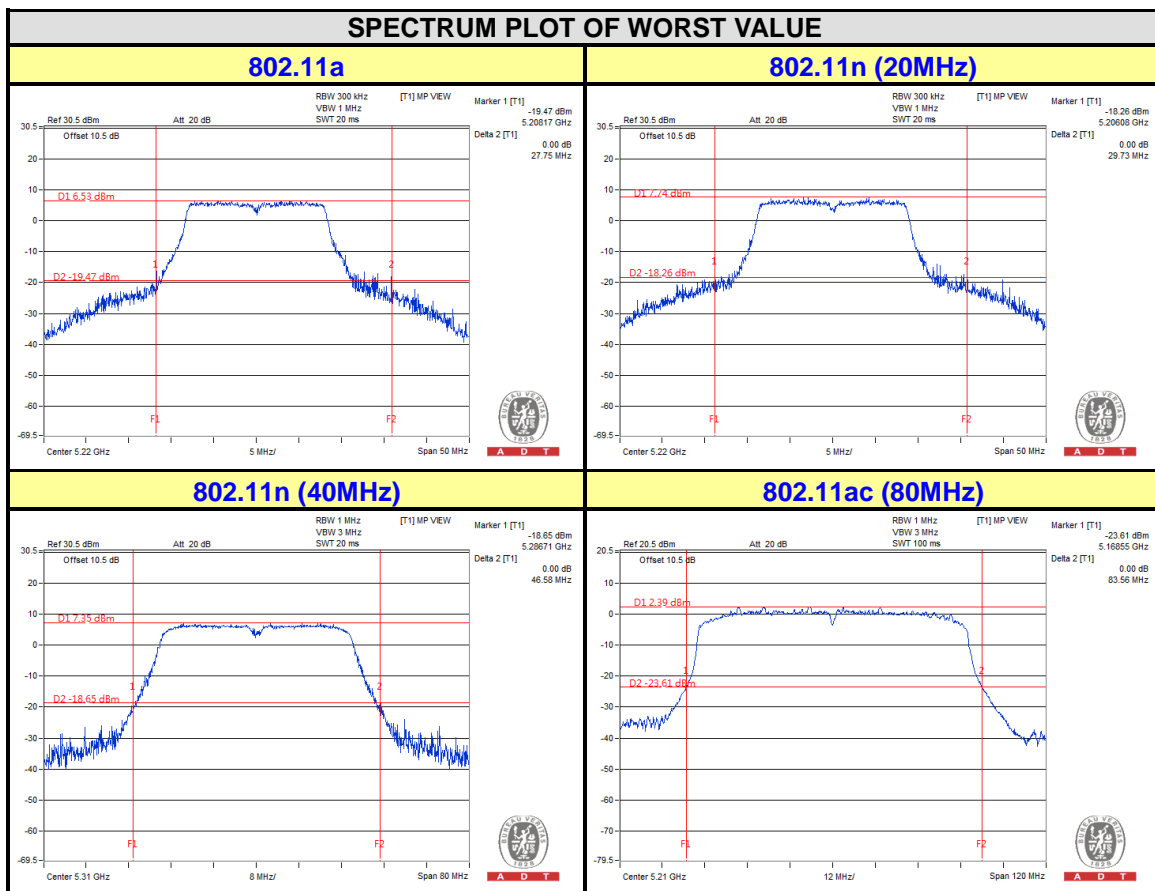

4.4 PEAK POWER SPECTRAL DENSITY MEASUREMENT

4.4.1 LIMITS OF PEAK POWER SPECTRAL DENSITY MEASUREMENT

FREQUENCY BAND	LIMIT
5.150 ~ 5.250GHz	4dBm
5.250 ~ 5.350GHz	11dBm
5.470 ~ 5.725GHz	11dBm

4.4.2 TEST SETUP

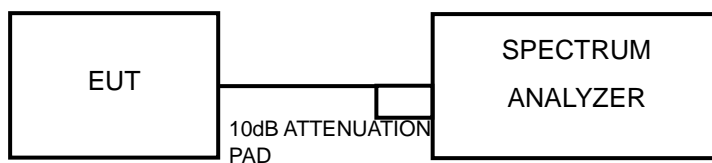

4.4.3 TEST INSTRUMENTS

Refer to section 4.1.3 to get information of above instrument.

4.4.4 TEST PROCEDURES

<802.11a, 802.11n (20MHz), 802.11n (40MHz), 802.11ac (80MHz)>

Using method SA-2 alternative

- 1) Set span to encompass the entire emission bandwidth (EBW) of the signal.
- 2) Set RBW = 1 MHz, Set VBW \geq 3 MHz, Detector = RMS
- 3) Sweep time = 4second.
- 4) Perform a single sweep.
- 5) Record the max value and add 10 log (1/duty cycle)

4.4.5 DEVIATION FROM TEST STANDARD

No deviation.

4.4.6 EUT OPERATING CONDITIONS

Same as Item 4.3.6.



4.4.7 TEST RESULTS

802.11a

CHANNEL	FREQUENCY (MHz)	PSD W/O DUTY FACTOR (dBm)	DUTY FACTOR	PSD WITH DUTY FACTOR (dBm)	MAXIMUM LIMIT (dBm)	PASS/FAIL
36	5180	3.04	0.64	3.68	4	PASS
44	5220	2.98	0.64	3.62	4	PASS
48	5240	3.14	0.64	3.78	4	PASS
52	5260	4.36	0.64	5.00	11	PASS
60	5300	5.33	0.64	5.97	11	PASS
64	5320	4.39	0.64	5.03	11	PASS
100	5500	4.16	0.64	4.80	11	PASS
116	5580	4.14	0.64	4.78	11	PASS
140	5700	4.67	0.64	5.31	11	PASS

NOTE: Refer to section 3.3 for duty cycle spectrum plot.

802.11n (20MHz)

CHANNEL	FREQUENCY (MHz)	PSD W/O DUTY FACTOR (dBm)	DUTY FACTOR	PSD WITH DUTY FACTOR (dBm)	MAXIMUM LIMIT (dBm)	PASS/FAIL
36	5180	3.06	0.69	3.75	4	PASS
44	5220	3.22	0.69	3.91	4	PASS
48	5240	3.30	0.69	3.99	4	PASS
52	5260	6.13	0.69	6.82	11	PASS
60	5300	4.67	0.69	5.36	11	PASS
64	5320	6.72	0.69	7.41	11	PASS
100	5500	6.26	0.69	6.95	11	PASS
116	5580	6.66	0.69	7.35	11	PASS
140	5700	5.66	0.69	6.35	11	PASS

NOTE: Refer to section 3.3 for duty cycle spectrum plot.



802.11n (40MHz)

CHANNEL	FREQUENCY (MHz)	PSD W/O DUTY FACTOR (dBm)	DUTY FACTOR	PSD WITH DUTY FACTOR (dBm)	MAXIMUM LIMIT (dBm)	PASS/FAIL
38	5190	-3.89	1.22	-2.67	4	PASS
46	5230	-3.38	1.22	-2.16	4	PASS
54	5270	-3.61	1.22	-2.39	11	PASS
62	5310	-3.31	1.22	-2.09	11	PASS
102	5510	-2.50	1.22	-1.28	11	PASS
110	5550	-2.67	1.22	-1.45	11	PASS
134	5670	-3.51	1.22	-2.29	11	PASS

NOTE: Refer to section 3.3 for duty cycle spectrum plot.

802.11ac (80MHz)

CHANNEL	FREQUENCY (MHz)	PSD W/O DUTY FACTOR (dBm)	DUTY FACTOR	PSD WITH DUTY FACTOR (dBm)	MAXIMUM LIMIT (dBm)	PASS/FAIL
42	5210	-6.51	2.58	-3.93	4	PASS
58	5290	-6.19	2.58	-3.61	11	PASS
106	5530	-6.14	2.58	-3.56	11	PASS

NOTE: Refer to section 3.3 for duty cycle spectrum plot.



A D T

SPECTRUM PLOT OF WORST VALUE

802.11a

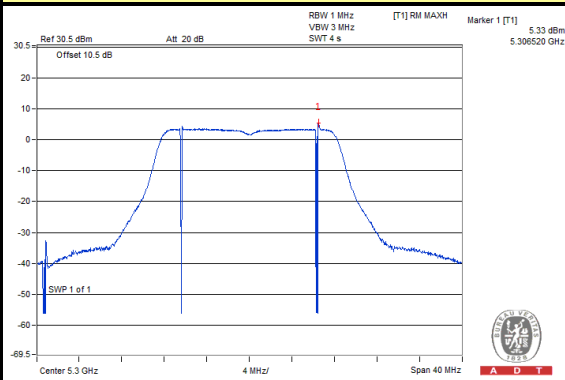

802.11n (20MHz)

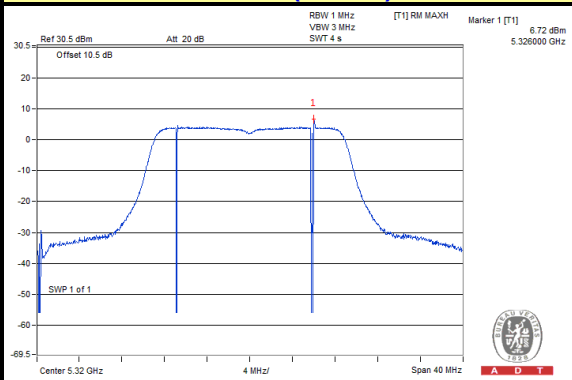

802.11n (40MHz)

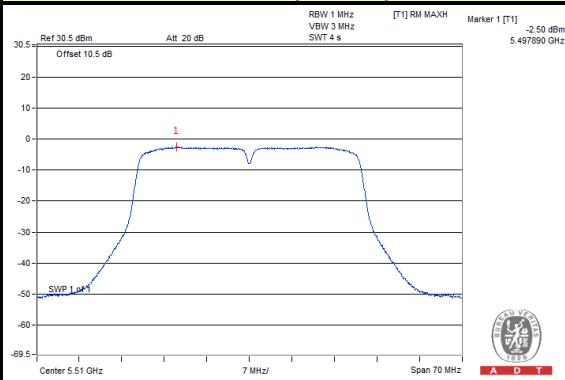

802.11ac (80MHz)

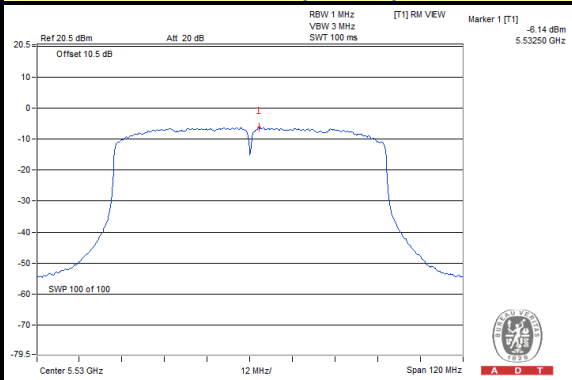

4.5 PEAK POWER EXCURSION MEASUREMENT

4.5.1 LIMITS OF POWER SPECTRAL DENSITY MEASUREMENT

Shall not exceed 13 dB.

4.5.2 TEST SETUP

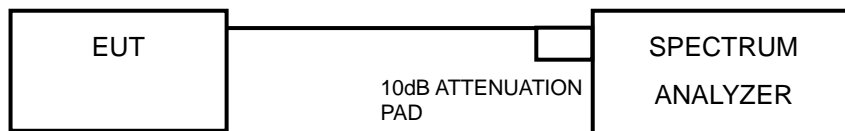

4.5.3 TEST INSTRUMENTS

Refer to section 4.1.3 to get information of above instrument.

4.5.4 TEST PROCEDURE

- a. Set the RBW = 1 kHz, VBW \geq 3 MHz, Detector = peak.
- b. Trace mode = max-hold. Allow the sweeps to continue until the trace stabilizes.
- c. Use the peak search function to find the peak of the spectrum.
- d. Measure the PPSD.
- e. Compute the ratio of the maximum of the peak-max-hold spectrum to the PPSD.

Find the worst channel and modulation mode as above test procedure, and follow KDB 789033 D01 General UNII Test Procedures v01r03 and repeat step 1 to 5 for final testing of each modulation mode on a single channel (all modulation types) in a single operating band to compliance with the peak excursion requirement.

4.5.5 DEVIATION FROM TEST STANDARD

No deviation.

4.5.6 EUT OPERATING CONDITION

Same as Item 4.3.6



A D T

4.5.7 TEST RESULTS

MODULATION MODE	MODULATION TYPE	CHAN. FREQ. (MHz)	PEAK VALUE (dBm)	PPSD WITHOUT DUTY FACTOR (dBm)	PPSD WITH DUTY FACTOR (dBm)	PEAK EXCURSION (dB)	LIMIT (dB)	PASS /FAIL
802.11a	BPSK	5320	14.30	4.39	5.03	9.27	13	PASS
	QPSK		14.45	4.03	5.22	9.23	13	PASS
	16QAM		18.52	4.67	6.71	11.81	13	PASS
	64QAM		18.89	4.04	7.45	11.44	13	PASS
802.11n (20MHz)	BPSK	5500	14.84	6.26	7.49	7.35	13	PASS
	QPSK		15.74	5.53	6.22	9.52	13	PASS
	16QAM		16.98	7.79	9.86	7.12	13	PASS
	64QAM		16.89	4.39	7.72	9.17	13	PASS
802.11n (40MHz)	BPSK	5670	7.04	-3.51	-2.29	9.33	13	PASS
	QPSK		7.31	-4.20	-2.20	9.51	13	PASS
	16QAM		7.82	-5.18	-2.06	9.88	13	PASS
	64QAM		7.96	-6.26	-1.85	9.81	13	PASS
802.11ac (80MHz)	BPSK	5290	2.49	-6.19	-3.61	6.10	13	PASS
	QPSK		2.49	-6.24	-2.46	4.95	13	PASS
	16QAM		2.54	-5.96	-1.04	3.58	13	PASS
	64QAM		2.49	-5.75	0.07	2.42	13	PASS
	256QAM		2.63	-5.94	0.59	2.04	13	PASS

NOTE: Refer to section 3.3 for duty cycle spectrum plot.

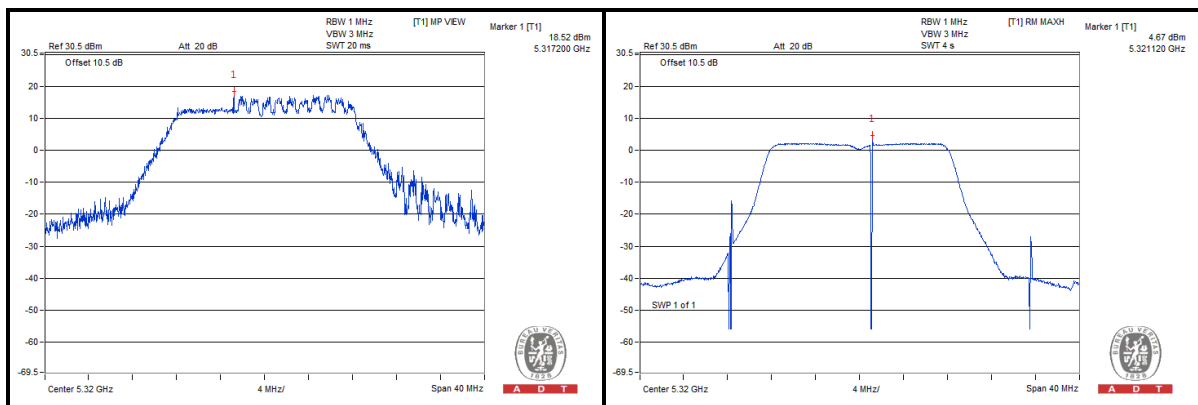

4.6 FREQUENCY STABILITY

4.6.1 LIMITS OF FREQUENCY STABILITY MEASUREMENT

The frequency of the carrier signal shall be maintained within band of operation.

4.6.2 TEST SETUP

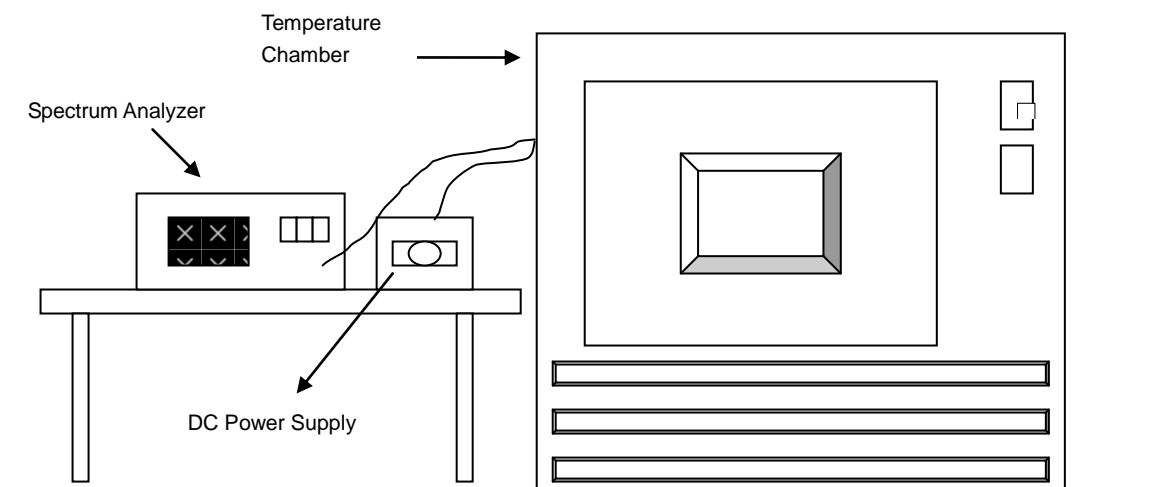

4.6.3 TEST INSTRUMENTS

Refer to section 4.1.3 to get information of above instrument.

4.6.4 TEST PROCEDURE

- a. To ensure emission at the band edge is maintained within the authorized band, those values shall be measured by radiation emissions at upper and lower frequency points, and finally compensated by frequency deviation as procedures below.
- b. The EUT was operated at the maximum output power, and connected to the spectrum analyzer, which is set to maximum hold function and peak detector. The peak value of the power envelope was measured and noted. The upper and lower frequency points were respectively measured relatively 10dB lower than the measured peak value.
- c. The frequency deviation was calculated by adding the upper frequency point and the lower frequency point divided by two. Those detailed values of frequency deviation are provided in table below.

4.6.5 DEVIATION FROM TEST STANDARD

No deviation.

4.6.6 EUT OPERATING CONDITION

Set the EUT transmit at un-modulation mode to test frequency stability.



4.6.7 TEST RESULTS

FREQUENCY STABILITY VERSUS TEMP.									
OPERATING FREQUENCY: 5320MHz									
TEMP. (°C)	POWER SUPPLY (Vdc)	0 MINUTE		2 MINUTE		5 MINUTE		10 MINUTE	
		Measured Frequency (MHz)	Frequency Drift (ppm)	Measured Frequency (MHz)	Frequency Drift (ppm)	Measured Frequency (MHz)	Frequency Drift (ppm)	Measured Frequency (MHz)	Frequency Drift (ppm)
50	3.8	5320.014863	2.794	5320.015652	2.942	5320.015058	2.830	5320.015033	2.826
40	3.8	5320.016144	3.035	5320.016140	3.034	5320.015730	2.957	5320.016192	3.044
30	3.8	5320.017462	3.282	5320.017403	3.271	5320.017183	3.230	5320.017415	3.273
20	3.8	5320.017946	3.373	5320.018304	3.441	5320.017916	3.368	5320.018164	3.414
10	3.8	5320.019646	3.693	5320.019384	3.644	5320.019739	3.710	5320.019659	3.695
0	3.8	5320.018380	3.455	5320.017947	3.373	5320.018113	3.405	5320.018377	3.454
-10	3.8	5320.016385	3.080	5320.016409	3.084	5320.016357	3.075	5320.016486	3.099
-20	3.8	5320.015884	2.986	5320.016420	3.086	5320.016020	3.011	5320.015917	2.992
-30	3.8	5320.015252	2.867	5320.014698	2.763	5320.015199	2.857	5320.015277	2.872

FREQUENCY STABILITY VERSUS VOLTAGE									
OPERATING FREQUENCY: 5320MHz									
TEMP. (°C)	POWER SUPPLY (Vdc)	0 MINUTE		2 MINUTE		5 MINUTE		10 MINUTE	
		Measured Frequency (MHz)	Frequency Drift (ppm)	Measured Frequency (MHz)	Frequency Drift (ppm)	Measured Frequency (MHz)	Frequency Drift (ppm)	Measured Frequency (MHz)	Frequency Drift (ppm)
20	3.6	5320.017416	3.274	5320.017979	3.380	5320.018180	3.417	5320.017974	3.379
	3.8	5320.017946	3.373	5320.018304	3.441	5320.017916	3.368	5320.018164	3.414
	4.35	5320.019270	3.622	5320.019127	3.595	5320.019408	3.648	5320.019215	3.612



A D T

5. PHOTOGRAPHS OF THE TEST CONFIGURATION

Please refer to the attached file (Test Setup Photo).



6. INFORMATION ON THE TESTING LABORATORIES

We, Bureau Veritas Consumer Products Services (H.K.) Ltd., Taoyuan Branch, were founded in 1988 to provide our best service in EMC, Radio, Telecom and Safety consultation. Our laboratories are accredited and approved according to ISO/IEC 17025.

If you have any comments, please feel free to contact us at the following:

Linko EMC/RF Lab:

Tel: 886-2-26052180

Fax: 886-2-26051924

Hsin Chu EMC/RF Lab:

Tel: 886-3-5935343

Fax: 886-3-5935342

Hwa Ya EMC/RF/Safety Telecom Lab:

Tel: 886-3-3183232

Fax: 886-3-3270892

Email: service.adt@tw.bureauveritas.com

Web Site: www.bureauveritas-adt.com

The address and road map of all our labs can be found in our web site also.



A D T

7. APPENDIX A - MODIFICATIONS RECORDERS FOR ENGINEERING CHANGES TO THE EUT BY THE LAB

No any modifications are made to the EUT by the lab during the test.

---END---