



FCC TEST REPORT (15.407)

REPORT NO.: RF130716C20-7
MODEL NO.: 0P4E200
FCC ID: NM80P4E200
RECEIVED: Jul. 16, 2013
TESTED: Jul. 30, 2013 ~ Aug. 01, 2013
ISSUED: Aug. 16, 2013

APPLICANT: HTC Corporation

ADDRESS: No. 23, Xinghua Rd., Taoyuan City, Taiwan

ISSUED BY: Bureau Veritas Consumer Products Services
(H.K.) Ltd., Taoyuan Branch

LAB ADDRESS: No. 47, 14th Ling, Chia Pau Vil., Lin Kou Dist.,
New Taipei City, Taiwan (R.O.C)

TEST LOCATION: No. 19, Hwa Ya 2nd Rd, Wen Hwa Tsuen, Kwei
Shan Hsiang, Taoyuan Hsien 333, Taiwan, R.O.C.

This report should not be used by the client to claim product certification, approval, or endorsement by TAF or any government agencies.



This report is for your exclusive use. Any copying or replication of this report to or for any other person or entity, or use of our name or trademark, is permitted only with our prior written permission. This report sets forth our findings solely with respect to the test samples identified herein. The results set forth in this report are not indicative or representative of the quality or characteristics of the lot from which a test sample was taken or any similar or identical product unless specifically and expressly noted. Our report includes all of the tests requested by you and the results thereof based upon the information that you provided to us. You have 60 days from date of issuance of this report to notify us of any material error or omission caused by our negligence, provided, however, that such notice shall be in writing and shall specifically address the issue you wish to raise. A failure to raise such issue within the prescribed time shall constitute your unqualified acceptance of the completeness of this report, the tests conducted and the correctness of the report contents. Unless specific mention, the uncertainty of measurement has been explicitly taken into account to declare the compliance or non-compliance to the specification

TABLE OF CONTENTS

RELEASE CONTROL RECORD	4
1. CERTIFICATION	5
2. SUMMARY OF TEST RESULTS	6
2.1 MEASUREMENT UNCERTAINTY	6
3. GENERAL INFORMATION.....	7
3.1 GENERAL DESCRIPTION OF EUT.....	7
3.2 DESCRIPTION OF TEST MODES.....	8
3.2.1 TEST MODE APPLICABILITY AND TESTED CHANNEL DETAIL	9
3.3 DESCRIPTION OF SUPPORT UNITS.....	11
3.3.1 CONFIGURATION OF SYSTEM UNDER TEST.....	11
3.4 DUTY CYCLE OF TEST SIGNAL.....	12
3.5 GENERAL DESCRIPTION OF APPLIED STANDARDS.....	13
4. TEST TYPES AND RESULTS.....	14
4.1 RADIATED EMISSION AND BANDEDGE MEASUREMENT	14
4.1.1 LIMITS OF RADIATED EMISSION AND BANDEDGE MEASUREMENT	14
4.1.2 LIMITS OF UNWANTED EMISSION OUT OF THE RESTRICTED BANDS	14
4.1.3 TEST INSTRUMENTS	15
4.1.4 TEST PROCEDURES	16
4.1.5 DEVIATION FROM TEST STANDARD	16
4.1.6 TEST SETUP.....	17
4.1.7 EUT OPERATING CONDITION	17
4.1.8 TEST RESULTS	18
4.2 CONDUCTED EMISSION MEASUREMENT	46
4.2.1 LIMITS OF CONDUCTED EMISSION MEASUREMENT	46
4.2.2 TEST INSTRUMENTS	46
4.2.3 TEST PROCEDURES	47
4.2.4 DEVIATION FROM TEST STANDARD	47
4.2.5 TEST SETUP.....	47
4.2.6 EUT OPERATING CONDITIONS.....	47
4.2.7 TEST RESULTS	48
4.3 PEAK TRANSMIT POWER MEASUREMENT	50
4.3.1 LIMITS OF PEAK TRANSMIT POWER MEASUREMENT	50
4.3.2 TEST SETUP.....	50
4.3.3 TEST INSTRUMENTS	50
4.3.4 TEST PROCEDURE.....	51
4.3.5 DEVIATION FROM TEST STANDARD	51
4.3.6 EUT OPERATING CONDITIONS.....	51
4.3.7 TEST RESULTS	52
4.4 PEAK POWER SPECTRAL DENSITY MEASUREMENT.....	55
4.4.1 LIMITS OF PEAK POWER SPECTRAL DENSITY MEASUREMENT	55
4.4.2 TEST SETUP.....	55
4.4.3 TEST INSTRUMENTS	55
4.4.4 TEST PROCEDURES	55
4.4.5 DEVIATION FROM TEST STANDARD	55
4.4.6 EUT OPERATING CONDITIONS.....	55
4.4.7 TEST RESULTS	56
4.5 PEAK POWER EXCURSION MEASUREMENT	58



A D T

4.5.1	LIMITS OF PEAK POWER EXCURSION MEASUREMENT	58
4.5.2	TEST SETUP.....	58
4.5.3	TEST INSTRUMENTS	58
4.5.4	TEST PROCEDURE.....	58
4.5.5	DEVIATION FROM TEST STANDARD	58
4.5.6	EUT OPERATING CONDITIONS.....	58
4.5.7	TEST RESULTS	59
4.6	FREQUENCY STABILITY	60
4.6.1	LIMITS OF FREQUENCY STABILITY MEASUREMENT	60
4.6.2	TEST SETUP.....	60
4.6.3	TEST INSTRUMENTS	60
4.6.4	TEST PROCEDURE.....	61
4.6.5	DEVIATION FROM TEST STANDARD	61
4.6.6	EUT OPERATING CONDITION	61
4.6.7	TEST RESULTS	62
5.	PHOTOGRAPHS OF THE TEST CONFIGURATION	63
6.	INFORMATION ON THE TESTING LABORATORIES.....	64
7.	APPENDIX A - MODIFICATIONS RECORDERS FOR ENGINEERING CHANGES TO THE EUT BY THE LAB	65



A D T

RELEASE CONTROL RECORD

ISSUE NO.	REASON FOR CHANGE	DATE ISSUED
RF130716C20-7	Original release	Aug. 16, 2013



1. CERTIFICATION

PRODUCT: Smartphone
MODEL NO.: 0P4E200
BRAND: HTC
APPLICANT: HTC Corporation
TESTED: Jul. 30, 2013 ~ Aug. 01, 2013
TEST SAMPLE: ENGINEERING SAMPLE
STANDARDS: **FCC Part 15, Subpart E (Section 15.407)**
ANSI C63.10-2009

The above equipment (model: 0P4E200) has been tested by **Bureau Veritas Consumer Products Services (H.K.) Ltd., Taoyuan Branch**, and found compliance with the requirement of the above standards. The test record, data evaluation & Equipment Under Test (EUT) configurations represented herein are true and accurate accounts of the measurements of the sample's EMC characteristics under the conditions specified in this report.

PREPARED BY : Ivonne Wu , **DATE** : Aug. 16, 2013
Ivonne Wu / Senior Specialist

APPROVED BY : Sam Chen , **DATE** : Aug. 16, 2013
Sam Chen / Assistant Manager

2. SUMMARY OF TEST RESULTS

The EUT has been tested according to the following specifications:

APPLIED STANDARD: FCC PART 15, SUBPART E (SECTION 15.407)			
STANDARD SECTION	TEST TYPE	RESULT	REMARK
15.407(b)(6)	AC Power Conducted Emission	PASS	Meet the requirement of limit. Minimum passing margin is -7.19dB at 0.4688MHz.
15.407(b/1/2/3)(b)(6)	Spurious Emissions	PASS	Meet the requirement of limit. Minimum passing margin is -3.46dB at 5150.00MHz.
15.407(a/1/2)	Peak Transmit Power	PASS	Meet the requirement of limit.
15.407(a)(6)	Peak Power Excursion	PASS	Meet the requirement of limit.
15.407(a/1/2)	Peak Power Spectral Density	PASS	Meet the requirement of limit.
15.407(g)	Frequency Stability	PASS	Meet the requirement of limit.
15.203	Antenna Requirement	PASS	No antenna connector is used.

2.1 MEASUREMENT UNCERTAINTY

Where relevant, the following measurement uncertainty levels have been estimated for tests performed on the EUT as specified in CISPR 16-4-2:

MEASUREMENT	FREQUENCY	UNCERTAINTY
Conducted emissions	9kHz~30MHz	2.44 dB
Radiated emissions	30MHz ~ 200MHz	2.93 dB
	200MHz ~1000MHz	2.95 dB
	1GHz ~ 18GHz	2.26 dB
	18GHz ~ 40GHz	1.94 dB

This uncertainty represents an expanded uncertainty expressed at approximately the 95% confidence level using a coverage factor of $k = 2$.

3. GENERAL INFORMATION

3.1 GENERAL DESCRIPTION OF EUT

EUT	Smartphone
MODEL NO.	0P4E200
POWER SUPPLY	5.0Vdc (adapter or host equipment) 3.8Vdc (Li-ion battery)
MODULATION TYPE	64QAM, 16QAM, QPSK, BPSK
MODULATION TECHNOLOGY	OFDM
TRANSFER RATE	802.11a: 54.0/ 48.0/ 36.0/ 24.0/ 18.0/ 12.0/ 9.0/ 6.0Mbps 802.11n: up to MCS7
OPERATING FREQUENCY	5180 ~ 5240MHz, 5260 ~ 5320MHz & 5500 ~ 5700MHz
NUMBER OF CHANNEL	5180 ~ 5240MHz: 4 for 802.11a, 802.11n (20MHz) 2 for 802.11n (40MHz) 5260 ~ 5320MHz: 4 for 802.11a, 802.11n (20MHz) 2 for 802.11n (40MHz) 5500 ~ 5700MHz: 8 for 802.11a, 802.11n (20MHz) 3 for 802.11n (40MHz)
OUTPUT POWER	21.727mW for 5180 ~ 5240MHz 22.182mW for 5260 ~ 5320MHz 21.577mW for 5500 ~ 5700MHz
ANTENNA TYPE	PIFA antenna with -4dBi gain
ANTENNA CONNECTOR	NA
DATA CABLE	Refer to Note as below
I/O PORTS	Refer to user's manual
ACCESSORY DEVICES	Refer to Note as below

NOTE:

1. The EUT's accessories list refers to Ext. Pho.
2. The above EUT information is declared by the manufacturer and for more detailed features description, please refer to the manufacturer's specifications or User's Manual.

3.2 DESCRIPTION OF TEST MODES

FOR 5180 ~ 5240MHz

4 channels are provided for 802.11a, 802.11n (20MHz):

CHANNEL	FREQUENCY	CHANNEL	FREQUENCY
36	5180 MHz	44	5220 MHz
40	5200 MHz	48	5240 MHz

2 channels are provided for 802.11n (40MHz):

CHANNEL	FREQUENCY	CHANNEL	FREQUENCY
38	5190 MHz	46	5230 MHz

FOR 5260 ~ 5320MHz

4 channels are provided for 802.11a, 802.11n (20MHz):

CHANNEL	FREQUENCY	CHANNEL	FREQUENCY
52	5260 MHz	60	5300 MHz
56	5280 MHz	64	5320 MHz

2 channels are provided for 802.11n (40MHz):

CHANNEL	FREQUENCY	CHANNEL	FREQUENCY
54	5270 MHz	62	5310 MHz

FOR 5500 ~ 5700MHz

8 channels are provided for 802.11a, 802.11n (20MHz):

CHANNEL	FREQUENCY	CHANNEL	FREQUENCY
100	5500MHz	116	5580MHz
104	5520MHz	132	5660MHz
108	5540MHz	136	5680MHz
112	5560MHz	140	5700MHz

3 channels are provided for 802.11n (40MHz):

CHANNEL	FREQUENCY	CHANNEL	FREQUENCY
102	5510MHz	134	5670MHz
110	5550MHz		

3.2.1 TEST MODE APPLICABILITY AND TESTED CHANNEL DETAIL

EUT CONFIGURE MODE	APPLICABLE TO				DESCRIPTION
	RE \geq 1G	RE<1G	PLC	APCM	
-	√	√	√	√	-

Where **RE \geq 1G**: Radiated Emission above 1GHz **RE<1G**: Radiated Emission below 1GHz
PLC: Power Line Conducted Emission **APCM**: Antenna Port Conducted Measurement

NOTE: The EUT had been pre-tested on the positioned of each 3 axis. The worst case was found when positioned on **Z-plane**.

RADIATED EMISSION TEST (ABOVE 1GHz):

- Pre-Scan has been conducted to determine the worst-case mode from all possible combinations between available modulations, data rates and antenna ports (if EUT with antenna diversity architecture).
- Following channel(s) was (were) selected for the final test as listed below.

MODE	FREQ. BAND (MHz)	AVAILABLE CHANNEL	TESTED CHANNEL	MODULATION TECHNOLOGY	MODULATION TYPE	DATA RATE (Mbps)
802.11a	5180-5240	36 to 48	36, 44, 48	OFDM	BPSK	6.0
802.11n (20MHz)		36 to 48	36, 44, 48	OFDM	BPSK	MCS0
802.11n (40MHz)		38 to 46	38, 46	OFDM	BPSK	MCS0
802.11a	5260-5320	52 to 64	52, 60, 64	OFDM	BPSK	6.0
802.11n (20MHz)		52 to 64	52, 60, 64	OFDM	BPSK	MCS0
802.11n (40MHz)		54 to 62	54, 62	OFDM	BPSK	MCS0
802.11a	5500-5700	100 to 140	100, 116, 140	OFDM	BPSK	6.0
802.11n (20MHz)		100 to 140	100, 116, 140	OFDM	BPSK	MCS0
802.11n (40MHz)		102 to 134	102, 110, 134	OFDM	BPSK	MCS0

RADIATED EMISSION TEST (BELOW 1GHz):

- Pre-Scan has been conducted to determine the worst-case mode from all possible combinations between available modulations, data rates and antenna ports (if EUT with antenna diversity architecture).
- Following channel(s) was (were) selected for the final test as listed below.

MODE	FREQ. BAND (MHz)	AVAILABLE CHANNEL	TESTED CHANNEL	MODULATION TECHNOLOGY	MODULATION TYPE	DATA RATE (Mbps)
802.11n (40MHz)	5180-5240	38 to 46	46	OFDM	BPSK	MCS0
	5260-5320	54 to 62	62	OFDM	BPSK	MCS0
	5500-5700	102 to 134	102	OFDM	BPSK	MCS0

POWER LINE CONDUCTED EMISSION TEST:

TEST CONDITION
BT Link + WLAN (5G) Link + Earphone + USB Cable + Adapter

BANDEDGE MEASUREMENT:

- Pre-Scan has been conducted to determine the worst-case mode from all possible combinations between available modulations, data rates and antenna ports (if EUT with antenna diversity architecture).
- Following channel(s) was (were) selected for the final test as listed below.

MODE	FREQ. BAND (MHz)	AVAILABLE CHANNEL	TESTED CHANNEL	MODULATION TECHNOLOGY	MODULATION TYPE	DATA RATE (Mbps)
802.11a	5180-5240	36 to 48	36, 48	OFDM	BPSK	6.0
802.11n (20MHz)		36 to 48	36, 48	OFDM	BPSK	MCS0
802.11n (40MHz)		38 to 46	38, 46	OFDM	BPSK	MCS0
802.11a	5260-5320	52 to 64	52, 64	OFDM	BPSK	6.0
802.11n (20MHz)		52 to 64	52, 64	OFDM	BPSK	MCS0
802.11n (40MHz)		54 to 62	54, 62	OFDM	BPSK	MCS0
802.11a	5500-5700	100 to 140	100, 140	OFDM	BPSK	6.0
802.11n (20MHz)		100 to 140	100, 140	OFDM	BPSK	MCS0
802.11n (40MHz)		102 to 134	102, 134	OFDM	BPSK	MCS0

ANTENNA PORT CONDUCTED MEASUREMENT:

- This item includes all test value of each mode, but only includes spectrum plot of worst value of each mode.
- Pre-Scan has been conducted to determine the worst-case mode from all possible combinations between available modulations, data rates and antenna ports (if EUT with antenna diversity architecture).
- Following channel(s) was (were) selected for the final test as listed below.

MODE	FREQ. BAND (MHz)	AVAILABLE CHANNEL	TESTED CHANNEL	MODULATION TECHNOLOGY	MODULATION TYPE	DATA RATE (Mbps)
802.11a	5180-5240	36 to 48	36, 44, 48	OFDM	BPSK	6.0
802.11n (20MHz)		36 to 48	36, 44, 48	OFDM	BPSK	MCS0
802.11n (40MHz)		38 to 46	38, 46	OFDM	BPSK	MCS0
802.11a	5260-5320	52 to 64	52, 60, 64	OFDM	BPSK	6.0
802.11n (20MHz)		52 to 64	52, 60, 64	OFDM	BPSK	MCS0
802.11n (40MHz)		54 to 62	54, 62	OFDM	BPSK	MCS0
802.11a	5500-5700	100 to 140	100, 116, 140	OFDM	BPSK	6.0
802.11n (20MHz)		100 to 140	100, 116, 140	OFDM	BPSK	MCS0
802.11n (40MHz)		102 to 134	102, 110, 134	OFDM	BPSK	MCS0

TEST CONDITION:

APPLICABLE TO	ENVIRONMENTAL CONDITIONS	INPUT POWER	TESTED BY
RE≥1G	25deg. C, 65%RH	120Vac, 60Hz	Johnson Liao
RE<1G	25deg. C, 65%RH	120Vac, 60Hz	Johnson Liao
PLC	25deg. C, 65%RH	120Vac, 60Hz	Johnson Liao
APCM	25deg. C, 65%RH	120Vac, 60Hz	Howard Kao

3.3 DESCRIPTION OF SUPPORT UNITS

The EUT has been tested as an independent unit together with other necessary accessories or support units.

3.3.1 CONFIGURATION OF SYSTEM UNDER TEST

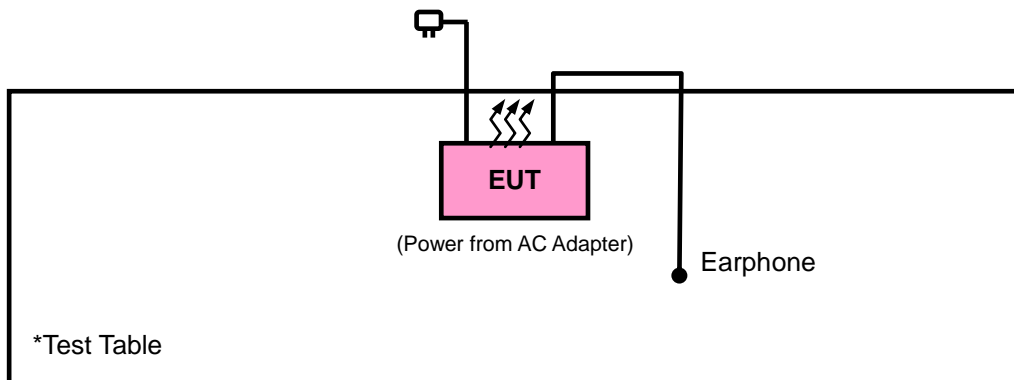

3.4 DUTY CYCLE OF TEST SIGNAL

If duty cycle is < 98%, duty factor shall be considered.

802.11a: Duty cycle = $2.059/2.171 = 0.948$, Duty factor = $10 * \log(1/0.948) = 0.23$

802.11n (20MHz): Duty cycle = $1.915/2.027 = 0.945$, Duty factor = $10 * \log(1/0.945) = 0.25$

802.11n (40MHz): Duty cycle = $913.46/1041.67 = 0.877$, Duty factor = $10 * \log(1/0.877) = 0.57$

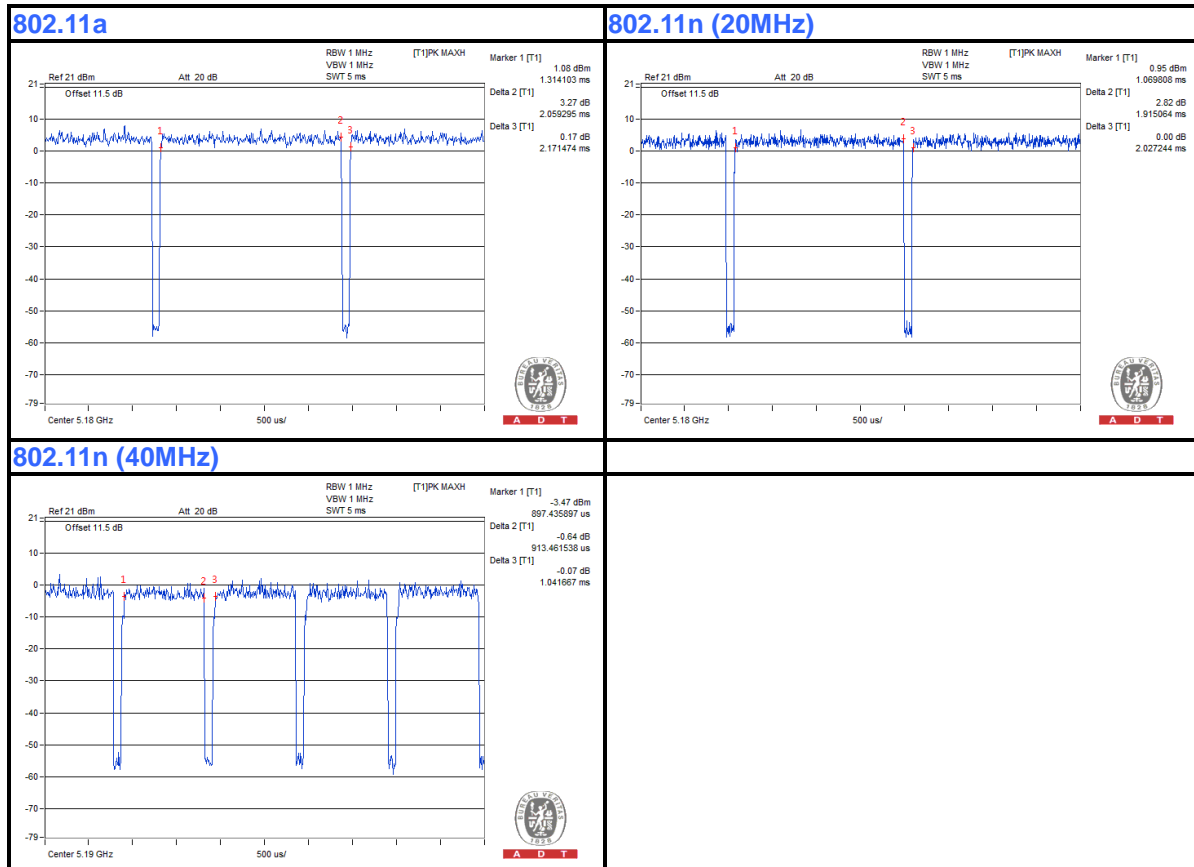

3.5 GENERAL DESCRIPTION OF APPLIED STANDARDS

The EUT is a RF Product. According to the specifications of the manufacturer, it must comply with the requirements of the following standards:

FCC Part 15, Subpart E (15.407)

ANSI C63.10-2009

KDB 789033 D01 General UNII Test Procedures v01r03

All test items have been performed and recorded as per the above standards.

NOTE: The EUT is also considered as a kind of computer peripheral, because the connection to computer is necessary for typical use. It has been verified to comply with the requirements of FCC Part 15, Subpart B, Class B (DoC). The test report has been issued separately.

4. TEST TYPES AND RESULTS

4.1 RADIATED EMISSION AND BANDEDGE MEASUREMENT

4.1.1 LIMITS OF RADIATED EMISSION AND BANDEDGE MEASUREMENT

Radiated emissions which fall in the restricted bands must comply with the radiated emission limits specified as below table:

FREQUENCIES (MHz)	FIELD STRENGTH (microvolts/meter)	MEASUREMENT DISTANCE (meters)
0.009 ~ 0.490	2400/F(kHz)	300
0.490 ~ 1.705	24000/F(kHz)	30
1.705 ~ 30.0	30	30
30 ~ 88	100	3
88 ~ 216	150	3
216 ~ 960	200	3
Above 960	500	3

NOTE:

1. The lower limit shall apply at the transition frequencies.
2. Emission level (dBuV/m) = 20 log Emission level (uV/m).
3. For frequencies above 1000MHz, the field strength limits are based on average detector, however, the peak field strength of any emission shall not exceed the maximum permitted average limits, specified above by more than 20dB under any condition of modulation.

4.1.2 LIMITS OF UNWANTED EMISSION OUT OF THE RESTRICTED BANDS

APPLICABLE TO	LIMIT	
	FIELD STRENGTH AT 3m (dBµV/m)	
	PK	AV
	74	54
√	EIRP LIMIT (dBm)	EQUIVALENT FIELD STRENGTH AT 3m (dBµV/m)
	PK	PK
	-27	68.3

NOTE: The following formula is used to convert the equipment isotropic radiated power (eirp) to field strength:

$$E = \frac{1000000\sqrt{30P}}{3} \mu\text{V/m, where P is the eirp (Watts).}$$



4.1.3 TEST INSTRUMENTS

DESCRIPTION & MANUFACTURER	MODEL NO.	SERIAL NO.	DATE OF CALIBRATION	DUE DATE OF CALIBRATION
Test Receiver ROHDE & SCHWARZ	ESCI	100744	Apr. 15, 2013	Apr. 14, 2014
Spectrum Analyzer ROHDE & SCHWARZ	FSU43	101261	Dec. 17, 2012	Dec. 16, 2013
BILOG Antenna SCHWARZBECK	VULB9168	9168-472	Mar. 25, 2013	Mar. 24, 2014
HORN Antenna SCHWARZBECK	BBHA 9120 D	9120D-969	Jan. 07, 2013	Jan. 06, 2014
HORN Antenna SCHWARZBECK	BBHA 9170	9170-480	Dec. 25, 2012	Dec. 24, 2013
Loop Antenna	HFH2-Z2	100070	Jan. 31, 2012	Jan. 30, 2014
Preamplifier EMCI	EMC 012645	980115	Dec. 28, 2012	Dec. 27, 2013
Preamplifier EMCI	EMC 184045	980116	Dec. 28, 2012	Dec. 27, 2013
Preamplifier EMCI	EMC 330H	980112	Dec. 28, 2012	Dec. 27, 2013
RF signal cable HUBER+SUHNNER	SUCOFLEX 104	309219/4	Oct. 19, 2012	Oct. 18, 2013
RF signal cable HUBER+SUHNNER	SUCOFLEX 104	250130/4	Oct. 19, 2012	Oct. 18, 2013
RF signal cable Worken	RG-213	NA	Dec. 29, 2012	Dec. 28, 2013
Software BV ADT	E3 6.120103	NA	NA	NA
Antenna Tower MF	MFA-440H	NA	NA	NA
Turn Table MF	MFT-201SS	NA	NA	NA
Antenna Tower & Turn Table Controller MF	MF-7802	NA	NA	NA
Power Meter	ML2495A	1232002	Aug. 10, 2012	Aug. 09, 2013
Power Sensor	MA2411B	1207325	Aug. 15, 2012	Aug. 14, 2013

- NOTE:**
1. The calibration interval of the above test instruments is 12 months and the calibrations are traceable to NML/ROC and NIST/USA.
 2. The calibration interval of the loop antenna is 24 months and the calibrations are traceable to NML/ROC and NIST/USA.
 3. The test was performed in HwaYa Chamber 10.
 4. The horn antenna and HP preamplifier (model: 8449B) are used only for the measurement of emission frequency above 1GHz if tested.
 5. The FCC Site Registration No. is 690701.
 6. The IC Site Registration No. is IC 7450F-10.

4.1.4 TEST PROCEDURES

- a. The EUT was placed on the top of a rotating table 0.8 meters above the ground at a 3 meter semi-anechoic chamber. The table was rotated 360 degrees to determine the position of the highest radiation.
- b. The EUT was set 3 meters away from the interference-receiving antenna, which was mounted on the top of a variable-height antenna tower.
- c. The antenna is a broadband antenna, and its height is varied from one meter to four meters above the ground to determine the maximum value of the field strength. Both horizontal and vertical polarizations of the antenna are set to make the measurement.
- d. For each suspected emission, the EUT was arranged to its worst case and then the antenna was tuned to heights from 1 meter to 4 meters and the rotatable table was turned from 0 degrees to 360 degrees to find the maximum reading.
- e. The test-receiver system was set to Peak Detect Function and Specified Bandwidth with Maximum Hold Mode.
- f. If the emission level of the EUT in peak mode was 10dB lower than the limit specified, then testing could be stopped and the peak values of the EUT would be reported. Otherwise the emissions that did not have 10dB margin would be re-tested one by one using peak, quasi-peak or average method as specified and then reported in a data sheet.

NOTE:

1. The resolution bandwidth and video bandwidth of test receiver/spectrum analyzer is 120kHz for Peak detection (PK) and Quasi-peak detection (QP) at frequency below 1GHz.
2. The resolution bandwidth of test receiver/spectrum analyzer is 1MHz and video bandwidth is 3MHz for Peak detection at frequency above 1GHz.
3. The resolution bandwidth of test receiver/spectrum analyzer is 1MHz and the video bandwidth is 1kHz (Duty cycle < 98%) or 10Hz (Duty cycle > 98%) for Average detection (AV) at frequency above 1GHz.
4. All modes of operation were investigated and the worst-case emissions are reported.

4.1.5 DEVIATION FROM TEST STANDARD

No deviation.

4.1.6 TEST SETUP

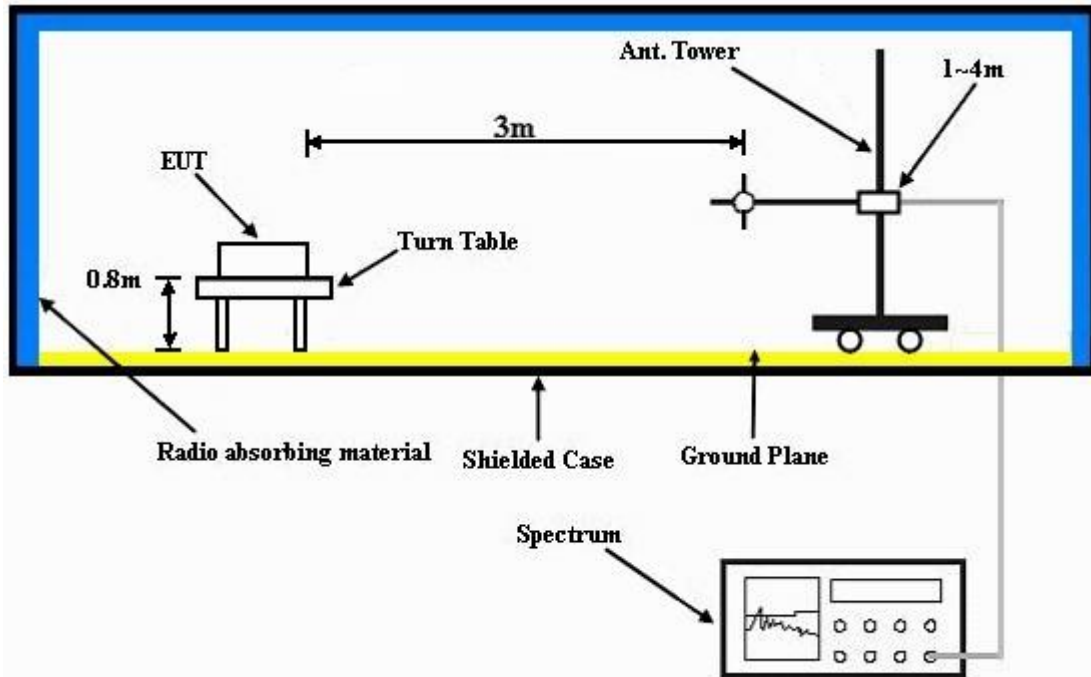

For the actual test configuration, please refer to the attached file (Test Setup Photo).

4.1.7 EUT OPERATING CONDITION

- Placed the EUT on a testing table.
- Use the software to control the EUT under transmission condition continuously at specific channel frequency.



A D T

4.1.8 TEST RESULTS

ABOVE 1GHz DATA: 802.11a

EUT TEST CONDITION		MEASUREMENT DETAIL	
CHANNEL	Channel 36	FREQUENCY RANGE	1GHz ~ 40GHz
INPUT POWER (SYSTEM)	120Vac, 60 Hz	DETECTOR FUNCTION	Peak (PK) Average (AV)
ENVIRONMENTAL CONDITIONS	25deg. C, 65%RH	TESTED BY	Johnson Liao

ANTENNA POLARITY & TEST DISTANCE: HORIZONTAL AT 3 M										
FREQ. (MHz)	EMISSION LEVEL (dBuV/m)	READ LEVEL (dBuV)	LIMIT (dBuV/m)	MARGIN (dB)	ANTENNA FACTOR (dB/m)	CABLE LOSS (dB)	PREAMP FACTOR (dB)	ANTENNA HEIGHT (cm)	TABLE ANGLE (Degree)	REMARK
5138	39.58	40.28	54	-14.42	31.31	5.29	37.3	100	324	Average
5138	53.68	54.38	74	-20.32	31.31	5.29	37.3	100	324	Peak
5180	89.05	89.73			31.35	5.31	37.34	100	324	Average
5180	98.06	98.74			31.35	5.31	37.34	100	324	Peak
5442	38.16	38.3	54	-15.84	31.55	5.44	37.13	100	324	Average
5442	54.51	54.65	74	-19.49	31.55	5.44	37.13	100	324	Peak
ANTENNA POLARITY & TEST DISTANCE: VERTICAL AT 3 M										
FREQ. (MHz)	EMISSION LEVEL (dBuV/m)	READ LEVEL (dBuV)	LIMIT (dBuV/m)	MARGIN (dB)	ANTENNA FACTOR (dB/m)	CABLE LOSS (dB)	PREAMP FACTOR (dB)	ANTENNA HEIGHT (cm)	TABLE ANGLE (Degree)	REMARK
5066	40.64	41.38	54	-13.36	31.25	5.26	37.25	112	99	Average
5066	53.94	54.68	74	-20.06	31.25	5.26	37.25	112	99	Peak
5180	91.02	91.7			31.35	5.31	37.34	112	99	Average
5180	100.11	100.79			31.35	5.31	37.34	112	99	Peak
5456	38.31	38.39	54	-15.69	31.56	5.44	37.08	112	99	Average
5456	53.82	53.9	74	-20.18	31.56	5.44	37.08	112	99	Peak

REMARKS:

1. Emission Level = Read Level + Antenna Factor + Cable Loss - Preamp Factor
2. 5180MHz: Fundamental frequency.



A D T

EUT TEST CONDITION		MEASUREMENT DETAIL	
CHANNEL	Channel 44	FREQUENCY RANGE	1GHz ~ 40GHz
INPUT POWER (SYSTEM)	120Vac, 60 Hz	DETECTOR FUNCTION	Peak (PK) Average (AV)
ENVIRONMENTAL CONDITIONS	25deg. C, 65%RH	TESTED BY	Johnson Liao

ANTENNA POLARITY & TEST DISTANCE: HORIZONTAL AT 3 M										
FREQ. (MHz)	EMISSION LEVEL (dBuV/m)	READ LEVEL (dBuV)	LIMIT (dBuV/m)	MARGIN (dB)	ANTENNA FACTOR (dB/m)	CABLE LOSS (dB)	PREAMP FACTOR (dB)	ANTENNA HEIGHT (cm)	TABLE ANGLE (Degree)	REMARK
5028	37.84	38.61	54	-16.16	31.23	5.24	37.24	100	15	Average
5028	54.04	54.81	74	-19.96	31.23	5.24	37.24	100	15	Peak
5220	90.1	90.76			31.37	5.33	37.36	100	15	Average
5220	99.75	100.41			31.37	5.33	37.36	100	15	Peak
5348	38.51	38.82	54	-15.49	31.48	5.39	37.18	100	15	Average
5348	53.85	54.16	74	-20.15	31.48	5.39	37.18	100	15	Peak
ANTENNA POLARITY & TEST DISTANCE: VERTICAL AT 3 M										
FREQ. (MHz)	EMISSION LEVEL (dBuV/m)	READ LEVEL (dBuV)	LIMIT (dBuV/m)	MARGIN (dB)	ANTENNA FACTOR (dB/m)	CABLE LOSS (dB)	PREAMP FACTOR (dB)	ANTENNA HEIGHT (cm)	TABLE ANGLE (Degree)	REMARK
5036	38.2	38.97	54	-15.8	31.23	5.24	37.24	100	100	Average
5036	54.37	55.14	74	-19.63	31.23	5.24	37.24	100	100	Peak
5220	92.04	92.7			31.37	5.33	37.36	100	100	Average
5220	101.04	101.7			31.37	5.33	37.36	100	100	Peak
5426	38.12	38.3	54	-15.88	31.53	5.42	37.13	100	100	Average
5426	53.58	53.76	74	-20.42	31.53	5.42	37.13	100	100	Peak

REMARKS:

1. Emission Level = Read Level + Antenna Factor + Cable Loss - Preamp Factor
2. 5220MHz: Fundamental frequency.



A D T

EUT TEST CONDITION		MEASUREMENT DETAIL	
CHANNEL	Channel 48	FREQUENCY RANGE	1GHz ~ 40GHz
INPUT POWER (SYSTEM)	120Vac, 60 Hz	DETECTOR FUNCTION	Peak (PK) Average (AV)
ENVIRONMENTAL CONDITIONS	25deg. C, 65%RH	TESTED BY	Johnson Liao

ANTENNA POLARITY & TEST DISTANCE: HORIZONTAL AT 3 M										
FREQ. (MHz)	EMISSION LEVEL (dBuV/m)	READ LEVEL (dBuV)	LIMIT (dBuV/m)	MARGIN (dB)	ANTENNA FACTOR (dB/m)	CABLE LOSS (dB)	PREAMP FACTOR (dB)	ANTENNA HEIGHT (cm)	TABLE ANGLE (Degree)	REMARK
5004	37.47	38.27	54	-16.53	31.21	5.22	37.23	100	327	Average
5004	53.08	53.88	74	-20.92	31.21	5.22	37.23	100	327	Peak
5240	90.61	91.2			31.39	5.34	37.32	100	327	Average
5240	99.66	100.25			31.39	5.34	37.32	100	327	Peak
5362	38.12	38.42	54	-15.88	31.49	5.39	37.18	100	327	Average
5362	53.84	54.14	74	-20.16	31.49	5.39	37.18	100	327	Peak
ANTENNA POLARITY & TEST DISTANCE: VERTICAL AT 3 M										
FREQ. (MHz)	EMISSION LEVEL (dBuV/m)	READ LEVEL (dBuV)	LIMIT (dBuV/m)	MARGIN (dB)	ANTENNA FACTOR (dB/m)	CABLE LOSS (dB)	PREAMP FACTOR (dB)	ANTENNA HEIGHT (cm)	TABLE ANGLE (Degree)	REMARK
5028	38.24	39.01	54	-15.76	31.23	5.24	37.24	111	99	Average
5028	53.09	53.86	74	-20.91	31.23	5.24	37.24	111	99	Peak
5240	92.52	93.11			31.39	5.34	37.32	111	99	Average
5240	101.94	102.53			31.39	5.34	37.32	111	99	Peak
5456	41.06	41.14	54	-12.94	31.56	5.44	37.08	111	99	Average
5456	54.24	54.32	74	-19.76	31.56	5.44	37.08	111	99	Peak

REMARKS:

1. Emission Level = Read Level + Antenna Factor + Cable Loss - Preamp Factor
2. 5240MHz: Fundamental frequency.



A D T

EUT TEST CONDITION		MEASUREMENT DETAIL	
CHANNEL	Channel 52	FREQUENCY RANGE	1GHz ~ 40GHz
INPUT POWER (SYSTEM)	120Vac, 60 Hz	DETECTOR FUNCTION	Peak (PK) Average (AV)
ENVIRONMENTAL CONDITIONS	25deg. C, 65%RH	TESTED BY	Johnson Liao

ANTENNA POLARITY & TEST DISTANCE: HORIZONTAL AT 3 M										
FREQ. (MHz)	EMISSION LEVEL (dBuV/m)	READ LEVEL (dBuV)	LIMIT (dBuV/m)	MARGIN (dB)	ANTENNA FACTOR (dB/m)	CABLE LOSS (dB)	PREAMP FACTOR (dB)	ANTENNA HEIGHT (cm)	TABLE ANGLE (Degree)	REMARK
5150	37.81	38.52	54	-16.19	31.32	5.29	37.32	100	32	Average
5150	56.76	57.47	74	-17.24	31.32	5.29	37.32	100	32	Peak
5260	90.97	91.49			31.41	5.34	37.27	100	32	Average
5260	99.85	100.37			31.41	5.34	37.27	100	32	Peak
5350	37.9	38.21	54	-16.1	31.48	5.39	37.18	100	32	Average
5350	57.95	58.26	74	-16.05	31.48	5.39	37.18	100	32	Peak

ANTENNA POLARITY & TEST DISTANCE: VERTICAL AT 3 M										
FREQ. (MHz)	EMISSION LEVEL (dBuV/m)	READ LEVEL (dBuV)	LIMIT (dBuV/m)	MARGIN (dB)	ANTENNA FACTOR (dB/m)	CABLE LOSS (dB)	PREAMP FACTOR (dB)	ANTENNA HEIGHT (cm)	TABLE ANGLE (Degree)	REMARK
5150	38.22	38.93	54	-15.78	31.32	5.29	37.32	103	180	Average
5150	57	57.71	74	-17	31.32	5.29	37.32	103	180	Peak
5260	96	96.52			31.41	5.34	37.27	103	180	Average
5260	105.05	105.57			31.41	5.34	37.27	103	180	Peak
5350	38.13	38.44	54	-15.87	31.48	5.39	37.18	103	180	Average
5350	58.01	58.32	74	-15.99	31.48	5.39	37.18	103	180	Peak

REMARKS:

1. Emission Level = Read Level + Antenna Factor + Cable Loss - Preamp Factor
2. 5260MHz: Fundamental frequency.



A D T

EUT TEST CONDITION		MEASUREMENT DETAIL	
CHANNEL	Channel 60	FREQUENCY RANGE	1GHz ~ 40GHz
INPUT POWER (SYSTEM)	120Vac, 60 Hz	DETECTOR FUNCTION	Peak (PK) Average (AV)
ENVIRONMENTAL CONDITIONS	25deg. C, 65%RH	TESTED BY	Johnson Liao

ANTENNA POLARITY & TEST DISTANCE: HORIZONTAL AT 3 M										
FREQ. (MHz)	EMISSION LEVEL (dBuV/m)	READ LEVEL (dBuV)	LIMIT (dBuV/m)	MARGIN (dB)	ANTENNA FACTOR (dB/m)	CABLE LOSS (dB)	PREAMP FACTOR (dB)	ANTENNA HEIGHT (cm)	TABLE ANGLE (Degree)	REMARK
5150	37.73	38.44	54	-16.27	31.32	5.29	37.32	100	111	Average
5150	56.85	57.56	74	-17.15	31.32	5.29	37.32	100	111	Peak
5300	91.07	91.45			31.44	5.37	37.19	100	111	Average
5300	100.14	100.52			31.44	5.37	37.19	100	111	Peak
5350	37.91	38.22	54	-16.09	31.48	5.39	37.18	100	111	Average
5350	56	56.31	74	-18	31.48	5.39	37.18	100	111	Peak
ANTENNA POLARITY & TEST DISTANCE: VERTICAL AT 3 M										
FREQ. (MHz)	EMISSION LEVEL (dBuV/m)	READ LEVEL (dBuV)	LIMIT (dBuV/m)	MARGIN (dB)	ANTENNA FACTOR (dB/m)	CABLE LOSS (dB)	PREAMP FACTOR (dB)	ANTENNA HEIGHT (cm)	TABLE ANGLE (Degree)	REMARK
5150	37.73	38.44	54	-16.27	31.32	5.29	37.32	103	174	Average
5150	56.75	57.46	74	-17.25	31.32	5.29	37.32	103	174	Peak
5300	94.27	94.65			31.44	5.37	37.19	103	174	Average
5300	103.32	103.7			31.44	5.37	37.19	103	174	Peak
5350	37.88	38.19	54	-16.12	31.48	5.39	37.18	103	174	Average
5350	58.33	58.64	74	-15.67	31.48	5.39	37.18	103	174	Peak

REMARKS:

1. Emission Level = Read Level + Antenna Factor + Cable Loss - Preamp Factor
2. 5300MHz: Fundamental frequency.



A D T

EUT TEST CONDITION		MEASUREMENT DETAIL	
CHANNEL	Channel 64	FREQUENCY RANGE	1GHz ~ 40GHz
INPUT POWER (SYSTEM)	120Vac, 60 Hz	DETECTOR FUNCTION	Peak (PK) Average (AV)
ENVIRONMENTAL CONDITIONS	25deg. C, 65%RH	TESTED BY	Johnson Liao

ANTENNA POLARITY & TEST DISTANCE: HORIZONTAL AT 3 M										
FREQ. (MHz)	EMISSION LEVEL (dBuV/m)	READ LEVEL (dBuV)	LIMIT (dBuV/m)	MARGIN (dB)	ANTENNA FACTOR (dB/m)	CABLE LOSS (dB)	PREAMP FACTOR (dB)	ANTENNA HEIGHT (cm)	TABLE ANGLE (Degree)	REMARK
5150	37.67	38.38	54	-16.33	31.32	5.29	37.32	100	42	Average
5150	56.83	57.54	74	-17.17	31.32	5.29	37.32	100	42	Peak
5320	91.58	91.94			31.45	5.38	37.19	100	42	Average
5320	101.9	102.26			31.45	5.38	37.19	100	42	Peak
5350	40.39	40.7	54	-13.61	31.48	5.39	37.18	100	42	Average
5350	57.26	57.57	74	-16.74	31.48	5.39	37.18	100	42	Peak
ANTENNA POLARITY & TEST DISTANCE: VERTICAL AT 3 M										
FREQ. (MHz)	EMISSION LEVEL (dBuV/m)	READ LEVEL (dBuV)	LIMIT (dBuV/m)	MARGIN (dB)	ANTENNA FACTOR (dB/m)	CABLE LOSS (dB)	PREAMP FACTOR (dB)	ANTENNA HEIGHT (cm)	TABLE ANGLE (Degree)	REMARK
5150	37.73	38.44	54	-16.27	31.32	5.29	37.32	112	167	Average
5150	57.52	58.23	74	-16.48	31.32	5.29	37.32	112	167	Peak
5320	94.81	95.17			31.45	5.38	37.19	112	167	Average
5320	104.03	104.39			31.45	5.38	37.19	112	167	Peak
5350	42.56	42.87	54	-11.44	31.48	5.39	37.18	112	167	Average
5350	59.04	59.35	74	-14.96	31.48	5.39	37.18	112	167	Peak

REMARKS:

1. Emission Level = Read Level + Antenna Factor + Cable Loss - Preamp Factor
2. 5320MHz: Fundamental frequency.



A D T

EUT TEST CONDITION		MEASUREMENT DETAIL	
CHANNEL	Channel 100	FREQUENCY RANGE	1GHz ~ 40GHz
INPUT POWER (SYSTEM)	120Vac, 60 Hz	DETECTOR FUNCTION	Peak (PK) Average (AV)
ENVIRONMENTAL CONDITIONS	25deg. C, 65%RH	TESTED BY	Johnson Liao

ANTENNA POLARITY & TEST DISTANCE: HORIZONTAL AT 3 M										
FREQ. (MHz)	EMISSION LEVEL (dBuV/m)	READ LEVEL (dBuV)	LIMIT (dBuV/m)	MARGIN (dB)	ANTENNA FACTOR (dB/m)	CABLE LOSS (dB)	PREAMP FACTOR (dB)	ANTENNA HEIGHT (cm)	TABLE ANGLE (Degree)	REMARK
5458	41.29	41.37	54	-12.71	31.56	5.44	37.08	100	98	Average
5458	55.05	55.13	74	-18.95	31.56	5.44	37.08	100	98	Peak
5470	54.35	54.41	68.3	-13.95	31.57	5.45	37.08	100	98	Peak
5500	91.16	91.13			31.6	5.46	37.03	100	98	Average
5500	101.44	101.41			31.6	5.46	37.03	100	98	Peak
5725	53.55	53.43	68.3	-14.75	31.96	5.59	37.43	100	98	Peak
ANTENNA POLARITY & TEST DISTANCE: VERTICAL AT 3 M										
FREQ. (MHz)	EMISSION LEVEL (dBuV/m)	READ LEVEL (dBuV)	LIMIT (dBuV/m)	MARGIN (dB)	ANTENNA FACTOR (dB/m)	CABLE LOSS (dB)	PREAMP FACTOR (dB)	ANTENNA HEIGHT (cm)	TABLE ANGLE (Degree)	REMARK
5456	42.71	42.79	54	-11.29	31.56	5.44	37.08	100	154	Average
5456	55.43	55.51	74	-18.57	31.56	5.44	37.08	100	154	Peak
5470	54.55	54.61	68.3	-13.75	31.57	5.45	37.08	100	154	Peak
5500	93.83	93.8			31.6	5.46	37.03	100	154	Average
5500	103.07	103.04			31.6	5.46	37.03	100	154	Peak
5725	53.29	53.17	68.3	-15.01	31.96	5.59	37.43	100	154	Peak

REMARKS:

1. Emission Level = Read Level + Antenna Factor + Cable Loss - Preamp Factor
2. 5500MHz: Fundamental frequency.
3. 5470MHz & 5725MHz: Out of restricted band



A D T

EUT TEST CONDITION		MEASUREMENT DETAIL	
CHANNEL	Channel 116	FREQUENCY RANGE	1GHz ~ 40GHz
INPUT POWER (SYSTEM)	120Vac, 60 Hz	DETECTOR FUNCTION	Peak (PK) Average (AV)
ENVIRONMENTAL CONDITIONS	25deg. C, 65%RH	TESTED BY	Johnson Liao

ANTENNA POLARITY & TEST DISTANCE: HORIZONTAL AT 3 M										
FREQ. (MHz)	EMISSION LEVEL (dBuV/m)	READ LEVEL (dBuV)	LIMIT (dBuV/m)	MARGIN (dB)	ANTENNA FACTOR (dB/m)	CABLE LOSS (dB)	PREAMP FACTOR (dB)	ANTENNA HEIGHT (cm)	TABLE ANGLE (Degree)	REMARK
5430	38.59	38.75	54	-15.41	31.55	5.42	37.13	100	85	Average
5430	55.63	55.79	74	-18.37	31.55	5.42	37.13	100	85	Peak
5470	52.2	52.26	68.3	-16.1	31.57	5.45	37.08	100	85	Peak
5580	90.26	90.21			31.71	5.5	37.16	100	85	Average
5580	99.67	99.62			31.71	5.5	37.16	100	85	Peak
5725	52.67	52.55	68.3	-15.63	31.96	5.59	37.43	100	85	Peak

ANTENNA POLARITY & TEST DISTANCE: VERTICAL AT 3 M										
FREQ. (MHz)	EMISSION LEVEL (dBuV/m)	READ LEVEL (dBuV)	LIMIT (dBuV/m)	MARGIN (dB)	ANTENNA FACTOR (dB/m)	CABLE LOSS (dB)	PREAMP FACTOR (dB)	ANTENNA HEIGHT (cm)	TABLE ANGLE (Degree)	REMARK
5436	38.12	38.28	54	-15.88	31.55	5.42	37.13	101	112	Average
5436	53.17	53.33	74	-20.83	31.55	5.42	37.13	101	112	Peak
5470	52.1	52.16	68.3	-16.2	31.57	5.45	37.08	101	112	Peak
5580	92.3	92.25			31.71	5.5	37.16	101	112	Average
5580	101.54	101.49			31.71	5.5	37.16	101	112	Peak
5725	52.74	52.62	68.3	-15.56	31.96	5.59	37.43	101	112	Peak

REMARKS:

1. Emission Level = Read Level + Antenna Factor + Cable Loss - Preamp Factor
2. 5580MHz: Fundamental frequency.
3. 5470MHz & 5725MHz: Out of restricted band



A D T

EUT TEST CONDITION		MEASUREMENT DETAIL	
CHANNEL	Channel 140	FREQUENCY RANGE	1GHz ~ 40GHz
INPUT POWER (SYSTEM)	120Vac, 60 Hz	DETECTOR FUNCTION	Peak (PK) Average (AV)
ENVIRONMENTAL CONDITIONS	25deg. C, 65%RH	TESTED BY	Johnson Liao

ANTENNA POLARITY & TEST DISTANCE: HORIZONTAL AT 3 M										
FREQ. (MHz)	EMISSION LEVEL (dBuV/m)	READ LEVEL (dBuV)	LIMIT (dBuV/m)	MARGIN (dB)	ANTENNA FACTOR (dB/m)	CABLE LOSS (dB)	PREAMP FACTOR (dB)	ANTENNA HEIGHT (cm)	TABLE ANGLE (Degree)	REMARK
5432	38.17	38.33	54	-15.83	31.55	5.42	37.13	100	76	Average
5432	54.54	54.7	74	-19.46	31.55	5.42	37.13	100	76	Peak
5470	52.54	52.6	68.3	-15.76	31.57	5.45	37.08	100	76	Peak
5700	91.63	91.56			31.9	5.57	37.4	100	76	Average
5700	100.55	100.48			31.9	5.57	37.4	100	76	Peak
5725	57.08	56.96	68.3	-11.22	31.96	5.59	37.43	100	76	Peak
ANTENNA POLARITY & TEST DISTANCE: VERTICAL AT 3 M										
FREQ. (MHz)	EMISSION LEVEL (dBuV/m)	READ LEVEL (dBuV)	LIMIT (dBuV/m)	MARGIN (dB)	ANTENNA FACTOR (dB/m)	CABLE LOSS (dB)	PREAMP FACTOR (dB)	ANTENNA HEIGHT (cm)	TABLE ANGLE (Degree)	REMARK
5434	38.06	38.22	54	-15.94	31.55	5.42	37.13	121	124	Average
5434	54.99	55.15	74	-19.01	31.55	5.42	37.13	121	124	Peak
5470	52.9	52.96	68.3	-15.4	31.57	5.45	37.08	121	124	Peak
5700	94.36	94.29			31.9	5.57	37.4	121	124	Average
5700	103.48	103.41			31.9	5.57	37.4	121	124	Peak
5725	57.93	57.81	68.3	-10.37	31.96	5.59	37.43	121	124	Peak

REMARKS:

1. Emission Level = Read Level + Antenna Factor + Cable Loss - Preamp Factor
2. 5700MHz: Fundamental frequency.
3. 5470MHz & 5725MHz: Out of restricted band



802.11n (20MHz)

EUT TEST CONDITION		MEASUREMENT DETAIL	
CHANNEL	Channel 36	FREQUENCY RANGE	1GHz ~ 40GHz
INPUT POWER (SYSTEM)	120Vac, 60 Hz	DETECTOR FUNCTION	Peak (PK) Average (AV)
ENVIRONMENTAL CONDITIONS	25deg. C, 65%RH	TESTED BY	Johnson Liao

ANTENNA POLARITY & TEST DISTANCE: HORIZONTAL AT 3 M										
FREQ. (MHz)	EMISSION LEVEL (dBuV/m)	READ LEVEL (dBuV)	LIMIT (dBuV/m)	MARGIN (dB)	ANTENNA FACTOR (dB/m)	CABLE LOSS (dB)	PREAMP FACTOR (dB)	ANTENNA HEIGHT (cm)	TABLE ANGLE (Degree)	REMARK
5142	40.47	41.16	54	-13.53	31.32	5.29	37.3	123	241	Average
5142	54.56	55.25	74	-19.44	31.32	5.29	37.3	123	241	Peak
5180	90.73	91.41			31.35	5.31	37.34	123	241	Average
5180	99.45	100.13			31.35	5.31	37.34	123	241	Peak
5452	38.01	38.09	54	-15.99	31.56	5.44	37.08	123	241	Average
5452	54.15	54.23	74	-19.85	31.56	5.44	37.08	123	241	Peak
ANTENNA POLARITY & TEST DISTANCE: VERTICAL AT 3 M										
FREQ. (MHz)	EMISSION LEVEL (dBuV/m)	READ LEVEL (dBuV)	LIMIT (dBuV/m)	MARGIN (dB)	ANTENNA FACTOR (dB/m)	CABLE LOSS (dB)	PREAMP FACTOR (dB)	ANTENNA HEIGHT (cm)	TABLE ANGLE (Degree)	REMARK
5138	40.66	41.36	54	-13.34	31.31	5.29	37.3	123	120	Average
5138	55.04	55.74	74	-18.96	31.31	5.29	37.3	123	120	Peak
5180	91.73	92.41			31.35	5.31	37.34	123	120	Average
5180	101.27	101.95			31.35	5.31	37.34	123	120	Peak
5456	38.12	38.2	54	-15.88	31.56	5.44	37.08	123	120	Average
5456	54.95	55.03	74	-19.05	31.56	5.44	37.08	123	120	Peak

REMARKS:

1. Emission Level = Read Level + Antenna Factor + Cable Loss - Preamp Factor
2. 5180MHz: Fundamental frequency.



A D T

EUT TEST CONDITION		MEASUREMENT DETAIL	
CHANNEL	Channel 44	FREQUENCY RANGE	1GHz ~ 40GHz
INPUT POWER (SYSTEM)	120Vac, 60 Hz	DETECTOR FUNCTION	Peak (PK) Average (AV)
ENVIRONMENTAL CONDITIONS	25deg. C, 65%RH	TESTED BY	Johnson Liao

ANTENNA POLARITY & TEST DISTANCE: HORIZONTAL AT 3 M										
FREQ. (MHz)	EMISSION LEVEL (dBuV/m)	READ LEVEL (dBuV)	LIMIT (dBuV/m)	MARGIN (dB)	ANTENNA FACTOR (dB/m)	CABLE LOSS (dB)	PREAMP FACTOR (dB)	ANTENNA HEIGHT (cm)	TABLE ANGLE (Degree)	REMARK
5130	38.07	38.78	54	-15.93	31.31	5.28	37.3	100	14	Average
5130	53.42	54.13	74	-20.58	31.31	5.28	37.3	100	14	Peak
5220	91.5	92.16			31.37	5.33	37.36	100	14	Average
5220	100.27	100.93			31.37	5.33	37.36	100	14	Peak
5380	40.82	41.09	54	-13.18	31.51	5.4	37.18	100	14	Average
5380	53.5	53.77	74	-20.5	31.51	5.4	37.18	100	14	Peak

ANTENNA POLARITY & TEST DISTANCE: VERTICAL AT 3 M										
FREQ. (MHz)	EMISSION LEVEL (dBuV/m)	READ LEVEL (dBuV)	LIMIT (dBuV/m)	MARGIN (dB)	ANTENNA FACTOR (dB/m)	CABLE LOSS (dB)	PREAMP FACTOR (dB)	ANTENNA HEIGHT (cm)	TABLE ANGLE (Degree)	REMARK
5148	39.27	39.98	54	-14.73	31.32	5.29	37.32	103	161	Average
5148	54.45	55.16	74	-19.55	31.32	5.29	37.32	103	161	Peak
5220	96.19	96.85			31.37	5.33	37.36	103	161	Average
5220	104.57	105.23			31.37	5.33	37.36	103	161	Peak
5354	40.35	40.66	54	-13.65	31.48	5.39	37.18	103	161	Average
5354	54.8	55.11	74	-19.2	31.48	5.39	37.18	103	161	Peak

REMARKS:

1. Emission Level = Read Level + Antenna Factor + Cable Loss - Preamp Factor
2. 5220MHz: Fundamental frequency.



A D T

EUT TEST CONDITION		MEASUREMENT DETAIL	
CHANNEL	Channel 48	FREQUENCY RANGE	1GHz ~ 40GHz
INPUT POWER (SYSTEM)	120Vac, 60 Hz	DETECTOR FUNCTION	Peak (PK) Average (AV)
ENVIRONMENTAL CONDITIONS	25deg. C, 65%RH	TESTED BY	Johnson Liao

ANTENNA POLARITY & TEST DISTANCE: HORIZONTAL AT 3 M										
FREQ. (MHz)	EMISSION LEVEL (dBuV/m)	READ LEVEL (dBuV)	LIMIT (dBuV/m)	MARGIN (dB)	ANTENNA FACTOR (dB/m)	CABLE LOSS (dB)	PREAMP FACTOR (dB)	ANTENNA HEIGHT (cm)	TABLE ANGLE (Degree)	REMARK
5090	37.71	38.43	54	-16.29	31.28	5.27	37.27	100	20	Average
5090	54.08	54.8	74	-19.92	31.28	5.27	37.27	100	20	Peak
5240	91.98	92.57			31.39	5.34	37.32	100	20	Average
5240	101.15	101.74			31.39	5.34	37.32	100	20	Peak
5448	41	41.13	54	-13	31.56	5.44	37.13	100	20	Average
5448	54.16	54.29	74	-19.84	31.56	5.44	37.13	100	20	Peak
ANTENNA POLARITY & TEST DISTANCE: VERTICAL AT 3 M										
FREQ. (MHz)	EMISSION LEVEL (dBuV/m)	READ LEVEL (dBuV)	LIMIT (dBuV/m)	MARGIN (dB)	ANTENNA FACTOR (dB/m)	CABLE LOSS (dB)	PREAMP FACTOR (dB)	ANTENNA HEIGHT (cm)	TABLE ANGLE (Degree)	REMARK
5120	38.45	39.18	54	-15.55	31.29	5.28	37.3	103	163	Average
5120	53.7	54.43	74	-20.3	31.29	5.28	37.3	103	163	Peak
5240	96.29	96.88			31.39	5.34	37.32	103	163	Average
5240	105.1	105.69			31.39	5.34	37.32	103	163	Peak
5380	42.09	42.36	54	-11.91	31.51	5.4	37.18	103	163	Average
5380	54.61	54.88	74	-19.39	31.51	5.4	37.18	103	163	Peak

REMARKS:

1. Emission Level = Read Level + Antenna Factor + Cable Loss - Preamp Factor
2. 5240MHz: Fundamental frequency.



A D T

EUT TEST CONDITION		MEASUREMENT DETAIL	
CHANNEL	Channel 52	FREQUENCY RANGE	1GHz ~ 40GHz
INPUT POWER (SYSTEM)	120Vac, 60 Hz	DETECTOR FUNCTION	Peak (PK) Average (AV)
ENVIRONMENTAL CONDITIONS	25deg. C, 65%RH	TESTED BY	Johnson Liao

ANTENNA POLARITY & TEST DISTANCE: HORIZONTAL AT 3 M										
FREQ. (MHz)	EMISSION LEVEL (dBuV/m)	READ LEVEL (dBuV)	LIMIT (dBuV/m)	MARGIN (dB)	ANTENNA FACTOR (dB/m)	CABLE LOSS (dB)	PREAMP FACTOR (dB)	ANTENNA HEIGHT (cm)	TABLE ANGLE (Degree)	REMARK
5128	37.77	38.48	54	-16.23	31.31	5.28	37.3	100	14	Average
5128	54.2	54.91	74	-19.8	31.31	5.28	37.3	100	14	Peak
5260	92.03	92.55			31.41	5.34	37.27	100	14	Average
5260	101.14	101.66			31.41	5.34	37.27	100	14	Peak
5358	38.58	38.89	54	-15.42	31.48	5.39	37.18	100	14	Average
5358	54.6	54.91	74	-19.4	31.48	5.39	37.18	100	14	Peak
ANTENNA POLARITY & TEST DISTANCE: VERTICAL AT 3 M										
FREQ. (MHz)	EMISSION LEVEL (dBuV/m)	READ LEVEL (dBuV)	LIMIT (dBuV/m)	MARGIN (dB)	ANTENNA FACTOR (dB/m)	CABLE LOSS (dB)	PREAMP FACTOR (dB)	ANTENNA HEIGHT (cm)	TABLE ANGLE (Degree)	REMARK
5148	38.43	39.14	54	-15.57	31.32	5.29	37.32	103	161	Average
5148	56.05	56.76	74	-17.95	31.32	5.29	37.32	103	161	Peak
5260	96.31	96.83			31.41	5.34	37.27	103	161	Average
5260	105.28	105.8			31.41	5.34	37.27	103	161	Peak
5416	39.52	39.75	54	-14.48	31.53	5.42	37.18	103	161	Average
5416	55.17	55.4	74	-18.83	31.53	5.42	37.18	103	161	Peak

REMARKS:

1. Emission Level = Read Level + Antenna Factor + Cable Loss - Preamp Factor
2. 5260MHz: Fundamental frequency.



A D T

EUT TEST CONDITION		MEASUREMENT DETAIL	
CHANNEL	Channel 60	FREQUENCY RANGE	1GHz ~ 40GHz
INPUT POWER (SYSTEM)	120Vac, 60 Hz	DETECTOR FUNCTION	Peak (PK) Average (AV)
ENVIRONMENTAL CONDITIONS	25deg. C, 65%RH	TESTED BY	Johnson Liao

ANTENNA POLARITY & TEST DISTANCE: HORIZONTAL AT 3 M										
FREQ. (MHz)	EMISSION LEVEL (dBuV/m)	READ LEVEL (dBuV)	LIMIT (dBuV/m)	MARGIN (dB)	ANTENNA FACTOR (dB/m)	CABLE LOSS (dB)	PREAMP FACTOR (dB)	ANTENNA HEIGHT (cm)	TABLE ANGLE (Degree)	REMARK
5020	37.41	38.2	54	-16.59	31.21	5.24	37.24	100	23	Average
5020	53.4	54.19	74	-20.6	31.21	5.24	37.24	100	23	Peak
5300	91.89	92.27			31.44	5.37	37.19	100	23	Average
5300	100.9	101.28			31.44	5.37	37.19	100	23	Peak
5370	39.82	40.11	54	-14.18	31.49	5.4	37.18	100	23	Average
5370	54.14	54.43	74	-19.86	31.49	5.4	37.18	100	23	Peak
ANTENNA POLARITY & TEST DISTANCE: VERTICAL AT 3 M										
FREQ. (MHz)	EMISSION LEVEL (dBuV/m)	READ LEVEL (dBuV)	LIMIT (dBuV/m)	MARGIN (dB)	ANTENNA FACTOR (dB/m)	CABLE LOSS (dB)	PREAMP FACTOR (dB)	ANTENNA HEIGHT (cm)	TABLE ANGLE (Degree)	REMARK
5104	38.2	38.93	54	-15.8	31.28	5.27	37.28	103	174	Average
5104	53.73	54.46	74	-20.27	31.28	5.27	37.28	103	174	Peak
5300	96.52	96.9			31.44	5.37	37.19	103	174	Average
5300	104.62	105			31.44	5.37	37.19	103	174	Peak
5348	41.76	42.07	54	-12.24	31.48	5.39	37.18	103	174	Average
5348	54.62	54.93	74	-19.38	31.48	5.39	37.18	103	174	Peak

REMARKS:

1. Emission Level = Read Level + Antenna Factor + Cable Loss - Preamp Factor
2. 5300MHz: Fundamental frequency.



A D T

EUT TEST CONDITION		MEASUREMENT DETAIL	
CHANNEL	Channel 64	FREQUENCY RANGE	1GHz ~ 40GHz
INPUT POWER (SYSTEM)	120Vac, 60 Hz	DETECTOR FUNCTION	Peak (PK) Average (AV)
ENVIRONMENTAL CONDITIONS	25deg. C, 65%RH	TESTED BY	Johnson Liao

ANTENNA POLARITY & TEST DISTANCE: HORIZONTAL AT 3 M										
FREQ. (MHz)	EMISSION LEVEL (dBuV/m)	READ LEVEL (dBuV)	LIMIT (dBuV/m)	MARGIN (dB)	ANTENNA FACTOR (dB/m)	CABLE LOSS (dB)	PREAMP FACTOR (dB)	ANTENNA HEIGHT (cm)	TABLE ANGLE (Degree)	REMARK
5038	37.27	38.02	54	-16.73	31.24	5.25	37.24	109	18	Average
5038	53.37	54.12	74	-20.63	31.24	5.25	37.24	109	18	Peak
5320	92.24	92.6			31.45	5.38	37.19	109	18	Average
5320	101.39	101.75			31.45	5.38	37.19	109	18	Peak
5350	41.47	41.78	54	-12.53	31.48	5.39	37.18	109	18	Average
5350	55.34	55.65	74	-18.66	31.48	5.39	37.18	109	18	Peak
ANTENNA POLARITY & TEST DISTANCE: VERTICAL AT 3 M										
FREQ. (MHz)	EMISSION LEVEL (dBuV/m)	READ LEVEL (dBuV)	LIMIT (dBuV/m)	MARGIN (dB)	ANTENNA FACTOR (dB/m)	CABLE LOSS (dB)	PREAMP FACTOR (dB)	ANTENNA HEIGHT (cm)	TABLE ANGLE (Degree)	REMARK
5104	37.57	38.3	54	-16.43	31.28	5.27	37.28	102	164	Average
5104	53.34	54.07	74	-20.66	31.28	5.27	37.28	102	164	Peak
5320	95.44	95.8			31.45	5.38	37.19	102	164	Average
5320	104.26	104.62			31.45	5.38	37.19	102	164	Peak
5350	44.18	44.49	54	-9.82	31.48	5.39	37.18	102	164	Average
5350	56.97	57.28	74	-17.03	31.48	5.39	37.18	102	164	Peak

REMARKS:

1. Emission Level = Read Level + Antenna Factor + Cable Loss - Preamp Factor
2. 5320MHz: Fundamental frequency.



A D T

EUT TEST CONDITION		MEASUREMENT DETAIL	
CHANNEL	Channel 100	FREQUENCY RANGE	1GHz ~ 40GHz
INPUT POWER (SYSTEM)	120Vac, 60 Hz	DETECTOR FUNCTION	Peak (PK) Average (AV)
ENVIRONMENTAL CONDITIONS	25deg. C, 65%RH	TESTED BY	Johnson Liao

ANTENNA POLARITY & TEST DISTANCE: HORIZONTAL AT 3 M										
FREQ. (MHz)	EMISSION LEVEL (dBuV/m)	READ LEVEL (dBuV)	LIMIT (dBuV/m)	MARGIN (dB)	ANTENNA FACTOR (dB/m)	CABLE LOSS (dB)	PREAMP FACTOR (dB)	ANTENNA HEIGHT (cm)	TABLE ANGLE (Degree)	REMARK
5454	41.53	41.61	54	-12.47	31.56	5.44	37.08	111	83	Average
5454	55.67	55.75	74	-18.33	31.56	5.44	37.08	111	83	Peak
5470	54.6	54.66	68.3	-13.7	31.57	5.45	37.08	111	83	Peak
5500	92.53	92.5			31.6	5.46	37.03	111	83	Average
5500	101.91	101.88			31.6	5.46	37.03	111	83	Peak
5725	54.59	54.47	68.3	-13.71	31.96	5.59	37.43	111	83	Peak
ANTENNA POLARITY & TEST DISTANCE: VERTICAL AT 3 M										
FREQ. (MHz)	EMISSION LEVEL (dBuV/m)	READ LEVEL (dBuV)	LIMIT (dBuV/m)	MARGIN (dB)	ANTENNA FACTOR (dB/m)	CABLE LOSS (dB)	PREAMP FACTOR (dB)	ANTENNA HEIGHT (cm)	TABLE ANGLE (Degree)	REMARK
5458	43.64	43.72	54	-10.36	31.56	5.44	37.08	100	164	Average
5458	56.17	56.25	74	-17.83	31.56	5.44	37.08	100	164	Peak
5470	55.07	55.13	68.3	-13.23	31.57	5.45	37.08	100	164	Peak
5500	94.18	94.15			31.6	5.46	37.03	100	164	Average
5500	103.35	103.32			31.6	5.46	37.03	100	164	Peak
5725	52.59	52.47	68.3	-15.71	31.96	5.59	37.43	100	164	Peak

REMARKS:

1. Emission Level = Read Level + Antenna Factor + Cable Loss - Preamp Factor
2. 5500MHz: Fundamental frequency.
3. 5470MHz & 5725MHz: Out of restricted band



A D T

EUT TEST CONDITION		MEASUREMENT DETAIL	
CHANNEL	Channel 116	FREQUENCY RANGE	1GHz ~ 40GHz
INPUT POWER (SYSTEM)	120Vac, 60 Hz	DETECTOR FUNCTION	Peak (PK) Average (AV)
ENVIRONMENTAL CONDITIONS	25deg. C, 65%RH	TESTED BY	Johnson Liao

ANTENNA POLARITY & TEST DISTANCE: HORIZONTAL AT 3 M										
FREQ. (MHz)	EMISSION LEVEL (dBuV/m)	READ LEVEL (dBuV)	LIMIT (dBuV/m)	MARGIN (dB)	ANTENNA FACTOR (dB/m)	CABLE LOSS (dB)	PREAMP FACTOR (dB)	ANTENNA HEIGHT (cm)	TABLE ANGLE (Degree)	REMARK
5438	38.6	38.74	54	-15.4	31.55	5.44	37.13	100	101	Average
5438	54.75	54.89	74	-19.25	31.55	5.44	37.13	100	101	Peak
5470	53.11	53.17	68.3	-15.19	31.57	5.45	37.08	100	101	Peak
5580	92.19	92.14			31.71	5.5	37.16	100	101	Average
5580	101.62	101.57			31.71	5.5	37.16	100	101	Peak
5725	53.11	52.99	68.3	-15.19	31.96	5.59	37.43	100	101	Peak
ANTENNA POLARITY & TEST DISTANCE: VERTICAL AT 3 M										
FREQ. (MHz)	EMISSION LEVEL (dBuV/m)	READ LEVEL (dBuV)	LIMIT (dBuV/m)	MARGIN (dB)	ANTENNA FACTOR (dB/m)	CABLE LOSS (dB)	PREAMP FACTOR (dB)	ANTENNA HEIGHT (cm)	TABLE ANGLE (Degree)	REMARK
5452	38.5	38.58	54	-15.5	31.56	5.44	37.08	107	158	Average
5452	53.87	53.95	74	-20.13	31.56	5.44	37.08	107	158	Peak
5470	51.61	51.67	68.3	-16.69	31.57	5.45	37.08	107	158	Peak
5580	94.4	94.35			31.71	5.5	37.16	107	158	Average
5580	103.39	103.34			31.71	5.5	37.16	107	158	Peak
5725	53.33	53.21	68.3	-14.97	31.96	5.59	37.43	107	158	Peak

REMARKS:

1. Emission Level = Read Level + Antenna Factor + Cable Loss - Preamp Factor
2. 5580MHz: Fundamental frequency.
3. 5470MHz & 5725MHz: Out of restricted band



A D T

EUT TEST CONDITION		MEASUREMENT DETAIL	
CHANNEL	Channel 140	FREQUENCY RANGE	1GHz ~ 40GHz
INPUT POWER (SYSTEM)	120Vac, 60 Hz	DETECTOR FUNCTION	Peak (PK) Average (AV)
ENVIRONMENTAL CONDITIONS	25deg. C, 65%RH	TESTED BY	Johnson Liao

ANTENNA POLARITY & TEST DISTANCE: HORIZONTAL AT 3 M										
FREQ. (MHz)	EMISSION LEVEL (dBuV/m)	READ LEVEL (dBuV)	LIMIT (dBuV/m)	MARGIN (dB)	ANTENNA FACTOR (dB/m)	CABLE LOSS (dB)	PREAMP FACTOR (dB)	ANTENNA HEIGHT (cm)	TABLE ANGLE (Degree)	REMARK
5428	38.2	38.38	54	-15.8	31.53	5.42	37.13	109	52	Average
5428	53.94	54.12	74	-20.06	31.53	5.42	37.13	109	52	Peak
5470	53.2	53.26	68.3	-15.1	31.57	5.45	37.08	109	52	Peak
5700	92.35	92.28			31.9	5.57	37.4	109	52	Average
5700	101.85	101.78			31.9	5.57	37.4	109	52	Peak
5725	59.45	59.33	68.3	-8.85	31.96	5.59	37.43	109	52	Peak
ANTENNA POLARITY & TEST DISTANCE: VERTICAL AT 3 M										
FREQ. (MHz)	EMISSION LEVEL (dBuV/m)	READ LEVEL (dBuV)	LIMIT (dBuV/m)	MARGIN (dB)	ANTENNA FACTOR (dB/m)	CABLE LOSS (dB)	PREAMP FACTOR (dB)	ANTENNA HEIGHT (cm)	TABLE ANGLE (Degree)	REMARK
5412	38.05	38.29	54	-15.95	31.53	5.41	37.18	112	140	Average
5412	54.3	54.54	74	-19.7	31.53	5.41	37.18	112	140	Peak
5470	53.46	53.52	68.3	-14.84	31.57	5.45	37.08	112	140	Peak
5700	94.76	94.69			31.9	5.57	37.4	112	140	Average
5700	104.02	103.95			31.9	5.57	37.4	112	140	Peak
5725	61.38	61.26	68.3	-6.92	31.96	5.59	37.43	112	140	Peak

REMARKS:

1. Emission Level = Read Level + Antenna Factor + Cable Loss - Preamp Factor
2. 5700MHz: Fundamental frequency.
3. 5470MHz & 5725MHz: Out of restricted band

802.11n (40MHz)

EUT TEST CONDITION		MEASUREMENT DETAIL	
CHANNEL	Channel 38	FREQUENCY RANGE	1GHz ~ 40GHz
INPUT POWER (SYSTEM)	120Vac, 60 Hz	DETECTOR FUNCTION	Peak (PK) Average (AV)
ENVIRONMENTAL CONDITIONS	25deg. C, 65%RH	TESTED BY	Johnson Liao

ANTENNA POLARITY & TEST DISTANCE: HORIZONTAL AT 3 M										
FREQ. (MHz)	EMISSION LEVEL (dBuV/m)	READ LEVEL (dBuV)	LIMIT (dBuV/m)	MARGIN (dB)	ANTENNA FACTOR (dB/m)	CABLE LOSS (dB)	PREAMP FACTOR (dB)	ANTENNA HEIGHT (cm)	TABLE ANGLE (Degree)	REMARK
5146	46.75	47.46	54	-7.25	31.32	5.29	37.32	100	15	Average
5146	59.83	60.54	74	-14.17	31.32	5.29	37.32	100	15	Peak
5190	88.41	89.08			31.35	5.32	37.34	100	15	Average
5190	97.9	98.57			31.35	5.32	37.34	100	15	Peak
5410	38.79	39.04	54	-15.21	31.52	5.41	37.18	100	15	Average
5410	54.22	54.47	74	-19.78	31.52	5.41	37.18	100	15	Peak
ANTENNA POLARITY & TEST DISTANCE: VERTICAL AT 3 M										
FREQ. (MHz)	EMISSION LEVEL (dBuV/m)	READ LEVEL (dBuV)	LIMIT (dBuV/m)	MARGIN (dB)	ANTENNA FACTOR (dB/m)	CABLE LOSS (dB)	PREAMP FACTOR (dB)	ANTENNA HEIGHT (cm)	TABLE ANGLE (Degree)	REMARK
5150	50.54	51.25	54	-3.46	31.32	5.29	37.32	104	154	Average
5150	63.75	64.46	74	-10.25	31.32	5.29	37.32	104	154	Peak
5190	92.71	93.38			31.35	5.32	37.34	104	154	Average
5190	101.46	102.13			31.35	5.32	37.34	104	154	Peak
5404	39.09	39.34	54	-14.91	31.52	5.41	37.18	104	154	Average
5404	53.75	54	74	-20.25	31.52	5.41	37.18	104	154	Peak

REMARKS:

1. Emission Level = Read Level + Antenna Factor + Cable Loss - Preamp Factor
2. 5190MHz: Fundamental frequency.



A D T

EUT TEST CONDITION		MEASUREMENT DETAIL	
CHANNEL	Channel 46	FREQUENCY RANGE	1GHz ~ 40GHz
INPUT POWER (SYSTEM)	120Vac, 60 Hz	DETECTOR FUNCTION	Peak (PK) Average (AV)
ENVIRONMENTAL CONDITIONS	25deg. C, 65%RH	TESTED BY	Johnson Liao

ANTENNA POLARITY & TEST DISTANCE: HORIZONTAL AT 3 M										
FREQ. (MHz)	EMISSION LEVEL (dBuV/m)	READ LEVEL (dBuV)	LIMIT (dBuV/m)	MARGIN (dB)	ANTENNA FACTOR (dB/m)	CABLE LOSS (dB)	PREAMP FACTOR (dB)	ANTENNA HEIGHT (cm)	TABLE ANGLE (Degree)	REMARK
5132	38.32	39.03	54	-15.68	31.31	5.28	37.3	100	25	Average
5132	53.3	54.01	74	-20.7	31.31	5.28	37.3	100	25	Peak
5230	88.83	89.43			31.39	5.33	37.32	100	25	Average
5230	97.84	98.44			31.39	5.33	37.32	100	25	Peak
5434	38.62	38.78	54	-15.38	31.55	5.42	37.13	100	25	Average
5434	53.75	53.91	74	-20.25	31.55	5.42	37.13	100	25	Peak
ANTENNA POLARITY & TEST DISTANCE: VERTICAL AT 3 M										
FREQ. (MHz)	EMISSION LEVEL (dBuV/m)	READ LEVEL (dBuV)	LIMIT (dBuV/m)	MARGIN (dB)	ANTENNA FACTOR (dB/m)	CABLE LOSS (dB)	PREAMP FACTOR (dB)	ANTENNA HEIGHT (cm)	TABLE ANGLE (Degree)	REMARK
5126	39.65	40.36	54	-14.35	31.31	5.28	37.3	116	176	Average
5126	54.57	55.28	74	-19.43	31.31	5.28	37.3	116	176	Peak
5230	93.84	94.44			31.39	5.33	37.32	116	176	Average
5230	103.23	103.83			31.39	5.33	37.32	116	176	Peak
5450	39.17	39.25	54	-14.83	31.56	5.44	37.08	116	176	Average
5450	55.48	55.56	74	-18.52	31.56	5.44	37.08	116	176	Peak

REMARKS:

1. Emission Level = Read Level + Antenna Factor + Cable Loss - Preamp Factor
2. 5230MHz: Fundamental frequency.



A D T

EUT TEST CONDITION		MEASUREMENT DETAIL	
CHANNEL	Channel 54	FREQUENCY RANGE	1GHz ~ 40GHz
INPUT POWER (SYSTEM)	120Vac, 60 Hz	DETECTOR FUNCTION	Peak (PK) Average (AV)
ENVIRONMENTAL CONDITIONS	25deg. C, 65%RH	TESTED BY	Johnson Liao

ANTENNA POLARITY & TEST DISTANCE: HORIZONTAL AT 3 M										
FREQ. (MHz)	EMISSION LEVEL (dBuV/m)	READ LEVEL (dBuV)	LIMIT (dBuV/m)	MARGIN (dB)	ANTENNA FACTOR (dB/m)	CABLE LOSS (dB)	PREAMP FACTOR (dB)	ANTENNA HEIGHT (cm)	TABLE ANGLE (Degree)	REMARK
5056	38.09	38.84	54	-15.91	31.25	5.25	37.25	100	22	Average
5056	53.37	54.12	74	-20.63	31.25	5.25	37.25	100	22	Peak
5270	88.57	89.08			31.41	5.35	37.27	100	22	Average
5270	98.17	98.68			31.41	5.35	37.27	100	22	Peak
5430	39.25	39.41	54	-14.75	31.55	5.42	37.13	100	22	Average
5430	53.66	53.82	74	-20.34	31.55	5.42	37.13	100	22	Peak
ANTENNA POLARITY & TEST DISTANCE: VERTICAL AT 3 M										
FREQ. (MHz)	EMISSION LEVEL (dBuV/m)	READ LEVEL (dBuV)	LIMIT (dBuV/m)	MARGIN (dB)	ANTENNA FACTOR (dB/m)	CABLE LOSS (dB)	PREAMP FACTOR (dB)	ANTENNA HEIGHT (cm)	TABLE ANGLE (Degree)	REMARK
5150	38.64	39.35	54	-15.36	31.32	5.29	37.32	103	167	Average
5150	54.6	55.31	74	-19.4	31.32	5.29	37.32	103	167	Peak
5270	93.83	94.34			31.41	5.35	37.27	103	167	Average
5270	102.74	103.25			31.41	5.35	37.27	103	167	Peak
5350	41.15	41.46	54	-12.85	31.48	5.39	37.18	103	167	Average
5350	55.76	56.07	74	-18.24	31.48	5.39	37.18	103	167	Peak

REMARKS:

1. Emission Level = Read Level + Antenna Factor + Cable Loss - Preamp Factor
2. 5270MHz: Fundamental frequency.



A D T

EUT TEST CONDITION		MEASUREMENT DETAIL	
CHANNEL	Channel 62	FREQUENCY RANGE	1GHz ~ 40GHz
INPUT POWER (SYSTEM)	120Vac, 60 Hz	DETECTOR FUNCTION	Peak (PK) Average (AV)
ENVIRONMENTAL CONDITIONS	25deg. C, 65%RH	TESTED BY	Johnson Liao

ANTENNA POLARITY & TEST DISTANCE: HORIZONTAL AT 3 M										
FREQ. (MHz)	EMISSION LEVEL (dBuV/m)	READ LEVEL (dBuV)	LIMIT (dBuV/m)	MARGIN (dB)	ANTENNA FACTOR (dB/m)	CABLE LOSS (dB)	PREAMP FACTOR (dB)	ANTENNA HEIGHT (cm)	TABLE ANGLE (Degree)	REMARK
5084	38.01	38.75	54	-15.99	31.27	5.26	37.27	100	16	Average
5084	53.9	54.64	74	-20.1	31.27	5.26	37.27	100	16	Peak
5310	88.41	88.78			31.45	5.37	37.19	100	16	Average
5310	97.39	97.76			31.45	5.37	37.19	100	16	Peak
5352	45.07	45.38	54	-8.93	31.48	5.39	37.18	100	16	Average
5352	57.35	57.66	74	-16.65	31.48	5.39	37.18	100	16	Peak
ANTENNA POLARITY & TEST DISTANCE: VERTICAL AT 3 M										
FREQ. (MHz)	EMISSION LEVEL (dBuV/m)	READ LEVEL (dBuV)	LIMIT (dBuV/m)	MARGIN (dB)	ANTENNA FACTOR (dB/m)	CABLE LOSS (dB)	PREAMP FACTOR (dB)	ANTENNA HEIGHT (cm)	TABLE ANGLE (Degree)	REMARK
5116	38.03	38.74	54	-15.97	31.29	5.28	37.28	114	170	Average
5116	52.88	53.59	74	-21.12	31.29	5.28	37.28	114	170	Peak
5310	93.31	93.68			31.45	5.37	37.19	114	170	Average
5310	102.55	102.92			31.45	5.37	37.19	114	170	Peak
5348	49.32	49.63	54	-4.68	31.48	5.39	37.18	114	170	Average
5348	63.69	64	74	-10.31	31.48	5.39	37.18	114	170	Peak

REMARKS:

1. Emission Level = Read Level + Antenna Factor + Cable Loss - Preamp Factor
2. 5310MHz: Fundamental frequency.



A D T

EUT TEST CONDITION		MEASUREMENT DETAIL	
CHANNEL	Channel 102	FREQUENCY RANGE	1GHz ~ 40GHz
INPUT POWER (SYSTEM)	120Vac, 60 Hz	DETECTOR FUNCTION	Peak (PK) Average (AV)
ENVIRONMENTAL CONDITIONS	25deg. C, 65%RH	TESTED BY	Johnson Liao

ANTENNA POLARITY & TEST DISTANCE: HORIZONTAL AT 3 M										
FREQ. (MHz)	EMISSION LEVEL (dBuV/m)	READ LEVEL (dBuV)	LIMIT (dBuV/m)	MARGIN (dB)	ANTENNA FACTOR (dB/m)	CABLE LOSS (dB)	PREAMP FACTOR (dB)	ANTENNA HEIGHT (cm)	TABLE ANGLE (Degree)	REMARK
5460	42.45	42.53	54	-11.55	31.56	5.44	37.08	100	102	Average
5460	55.09	55.17	74	-18.91	31.56	5.44	37.08	100	102	Peak
5470	59.23	59.29	68.3	-9.07	31.57	5.45	37.08	100	102	Peak
5510	89.49	89.49			31.6	5.46	37.06	100	102	Average
5510	98.24	98.24			31.6	5.46	37.06	100	102	Peak
5725	52.12	52	68.3	-16.18	31.96	5.59	37.43	100	102	Peak
ANTENNA POLARITY & TEST DISTANCE: VERTICAL AT 3 M										
FREQ. (MHz)	EMISSION LEVEL (dBuV/m)	READ LEVEL (dBuV)	LIMIT (dBuV/m)	MARGIN (dB)	ANTENNA FACTOR (dB/m)	CABLE LOSS (dB)	PREAMP FACTOR (dB)	ANTENNA HEIGHT (cm)	TABLE ANGLE (Degree)	REMARK
5460	43.39	43.47	54	-10.61	31.56	5.44	37.08	109	153	Average
5460	55.77	55.85	74	-18.23	31.56	5.44	37.08	109	153	Peak
5470	61.44	61.5	68.3	-6.86	31.57	5.45	37.08	109	153	Peak
5510	91.43	91.43			31.6	5.46	37.06	109	153	Average
5510	100.63	100.63			31.6	5.46	37.06	109	153	Peak
5725	52.2	52.08	68.3	-16.1	31.96	5.59	37.43	109	153	Peak

REMARKS:

1. Emission Level = Read Level + Antenna Factor + Cable Loss - Preamp Factor
2. 5510MHz: Fundamental frequency.
3. 5470MHz & 5725MHz: Out of restricted band



A D T

EUT TEST CONDITION		MEASUREMENT DETAIL	
CHANNEL	Channel 110	FREQUENCY RANGE	1GHz ~ 40GHz
INPUT POWER (SYSTEM)	120Vac, 60 Hz	DETECTOR FUNCTION	Peak (PK) Average (AV)
ENVIRONMENTAL CONDITIONS	25deg. C, 65%RH	TESTED BY	Johnson Liao

ANTENNA POLARITY & TEST DISTANCE: HORIZONTAL AT 3 M										
FREQ. (MHz)	EMISSION LEVEL (dBuV/m)	READ LEVEL (dBuV)	LIMIT (dBuV/m)	MARGIN (dB)	ANTENNA FACTOR (dB/m)	CABLE LOSS (dB)	PREAMP FACTOR (dB)	ANTENNA HEIGHT (cm)	TABLE ANGLE (Degree)	REMARK
5426	39.19	39.37	54	-14.81	31.53	5.42	37.13	100	102	Average
5426	53.91	54.09	74	-20.09	31.53	5.42	37.13	100	102	Peak
5470	52.95	53.01	68.3	-15.35	31.57	5.45	37.08	100	102	Peak
5550	89.28	89.2			31.68	5.49	37.09	100	102	Average
5550	98.44	98.36			31.68	5.49	37.09	100	102	Peak
5725	52.43	52.31	68.3	-15.87	31.96	5.59	37.43	100	102	Peak
ANTENNA POLARITY & TEST DISTANCE: VERTICAL AT 3 M										
FREQ. (MHz)	EMISSION LEVEL (dBuV/m)	READ LEVEL (dBuV)	LIMIT (dBuV/m)	MARGIN (dB)	ANTENNA FACTOR (dB/m)	CABLE LOSS (dB)	PREAMP FACTOR (dB)	ANTENNA HEIGHT (cm)	TABLE ANGLE (Degree)	REMARK
5430	39.42	39.58	54	-14.58	31.55	5.42	37.13	108	163	Average
5430	54	54.16	74	-20	31.55	5.42	37.13	108	163	Peak
5470	52.89	52.95	68.3	-15.41	31.57	5.45	37.08	108	163	Peak
5550	91.93	91.85			31.68	5.49	37.09	108	163	Average
5550	101.11	101.03			31.68	5.49	37.09	108	163	Peak
5725	53.2	53.08	68.3	-15.1	31.96	5.59	37.43	108	163	Peak

REMARKS:

1. Emission Level = Read Level + Antenna Factor + Cable Loss - Preamp Factor
2. 5550MHz: Fundamental frequency.
3. 5470MHz & 5725MHz: Out of restricted band



A D T

EUT TEST CONDITION		MEASUREMENT DETAIL	
CHANNEL	Channel 134	FREQUENCY RANGE	1GHz ~ 40GHz
INPUT POWER (SYSTEM)	120Vac, 60 Hz	DETECTOR FUNCTION	Peak (PK) Average (AV)
ENVIRONMENTAL CONDITIONS	25deg. C, 65%RH	TESTED BY	Johnson Liao

ANTENNA POLARITY & TEST DISTANCE: HORIZONTAL AT 3 M										
FREQ. (MHz)	EMISSION LEVEL (dBuV/m)	READ LEVEL (dBuV)	LIMIT (dBuV/m)	MARGIN (dB)	ANTENNA FACTOR (dB/m)	CABLE LOSS (dB)	PREAMP FACTOR (dB)	ANTENNA HEIGHT (cm)	TABLE ANGLE (Degree)	REMARK
5448	39.85	39.98	54	-14.15	31.56	5.44	37.13	118	103	Average
5448	53.94	54.07	74	-20.06	31.56	5.44	37.13	118	103	Peak
5470	51.57	51.63	68.3	-16.73	31.57	5.45	37.08	118	103	Peak
5670	90.03	89.93			31.88	5.56	37.34	118	103	Average
5670	99.59	99.49			31.88	5.56	37.34	118	103	Peak
5725	54.43	54.31	68.3	-13.87	31.96	5.59	37.43	118	103	Peak
ANTENNA POLARITY & TEST DISTANCE: VERTICAL AT 3 M										
FREQ. (MHz)	EMISSION LEVEL (dBuV/m)	READ LEVEL (dBuV)	LIMIT (dBuV/m)	MARGIN (dB)	ANTENNA FACTOR (dB/m)	CABLE LOSS (dB)	PREAMP FACTOR (dB)	ANTENNA HEIGHT (cm)	TABLE ANGLE (Degree)	REMARK
5392	38.34	38.6	54	-15.66	31.51	5.41	37.18	105	184	Average
5392	53.55	53.81	74	-20.45	31.51	5.41	37.18	105	184	Peak
5470	53.28	53.34	68.3	-15.02	31.57	5.45	37.08	105	184	Peak
5670	92.09	91.99			31.88	5.56	37.34	105	184	Average
5670	101.21	101.11			31.88	5.56	37.34	105	184	Peak
5724	56.4	56.28	68.3	-11.9	31.96	5.59	37.43	105	184	Peak

REMARKS:

1. Emission Level = Read Level + Antenna Factor + Cable Loss - Preamp Factor
2. 5670MHz: Fundamental frequency.
3. 5470MHz & 5725MHz: Out of restricted band

BELOW 1GHz WORST-CASE DATA :

802.11n (40MHz)

EUT TEST CONDITION		MEASUREMENT DETAIL	
CHANNEL	Channel 46	FREQUENCY RANGE	30MHz ~ 1GHz
INPUT POWER (SYSTEM)	120Vac, 60 Hz	DETECTOR FUNCTION	Peak (PK) Quasi-peak (QP)
ENVIRONMENTAL CONDITIONS	25deg. C, 65%RH	TESTED BY	Johnson Liao

ANTENNA POLARITY & TEST DISTANCE: HORIZONTAL AT 3 M										
FREQ. (MHz)	EMISSION LEVEL (dBuV/m)	READ LEVEL (dBuV)	LIMIT (dBuV/m)	MARGIN (dB)	ANTENNA FACTOR (dB/m)	CABLE LOSS (dB)	PREAMP FACTOR (dB)	ANTENNA HEIGHT (cm)	TABLE ANGLE (Degree)	REMARK
55.95	29.56	47.75	40	-10.44	12.35	0.8	31.34	100	162	QP
170.4	17.66	36.28	43.5	-25.84	11.67	1.45	31.74	100	176	Peak
273	20.32	38.17	46	-25.68	12.17	1.93	31.95	100	165	Peak
376.3	18.53	33.37	46	-27.47	14.77	2.33	31.94	100	154	Peak
629	23.44	32.44	46	-22.56	19.96	3.18	32.14	100	175	Peak
959.4	28.27	32.26	46	-17.73	23.84	4.09	31.92	100	295	Peak
ANTENNA POLARITY & TEST DISTANCE: VERTICAL AT 3 M										
FREQ. (MHz)	EMISSION LEVEL (dBuV/m)	READ LEVEL (dBuV)	LIMIT (dBuV/m)	MARGIN (dB)	ANTENNA FACTOR (dB/m)	CABLE LOSS (dB)	PREAMP FACTOR (dB)	ANTENNA HEIGHT (cm)	TABLE ANGLE (Degree)	REMARK
39.99	32.13	48.93	40	-7.87	13.54	0.65	30.99	100	291	QP
56.19	30.65	48.84	40	-9.35	12.35	0.8	31.34	100	163	QP
142.86	24.09	41.97	43.5	-19.41	12.44	1.31	31.63	100	249	Peak
348.3	18.07	33.59	46	-27.93	14.1	2.22	31.84	100	186	Peak
638.1	23.72	32.55	46	-22.28	20.07	3.2	32.1	100	274	Peak
958	28.16	32.14	46	-17.84	23.84	4.09	31.91	100	182	Peak

REMARKS: Emission Level = Read Level + Antenna Factor + Cable Loss - Preamp Factor



A D T

EUT TEST CONDITION		MEASUREMENT DETAIL	
CHANNEL	Channel 62	FREQUENCY RANGE	30MHz ~ 1GHz
INPUT POWER (SYSTEM)	120Vac, 60 Hz	DETECTOR FUNCTION	Peak (PK) Quasi-peak (QP)
ENVIRONMENTAL CONDITIONS	25deg. C, 65%RH	TESTED BY	Johnson Liao

ANTENNA POLARITY & TEST DISTANCE: HORIZONTAL AT 3 M										
FREQ. (MHz)	EMISSION LEVEL (dBuV/m)	READ LEVEL (dBuV)	LIMIT (dBuV/m)	MARGIN (dB)	ANTENNA FACTOR (dB/m)	CABLE LOSS (dB)	PREAMP FACTOR (dB)	ANTENNA HEIGHT (cm)	TABLE ANGLE (Degree)	REMARK
55.65	29.46	47.54	40	-10.54	12.45	0.8	31.33	100	159	QP
170.67	17.19	35.81	43.5	-26.31	11.67	1.45	31.74	100	163	Peak
276.78	20.52	38.23	46	-25.48	12.25	1.94	31.9	100	185	Peak
360.9	18.39	33.69	46	-27.61	14.4	2.27	31.97	100	184	Peak
678.7	26.04	33.97	46	-19.96	20.56	3.35	31.84	100	264	Peak
923	27.87	32.21	46	-18.13	23.64	4.02	32	100	194	Peak
ANTENNA POLARITY & TEST DISTANCE: VERTICAL AT 3 M										
FREQ. (MHz)	EMISSION LEVEL (dBuV/m)	READ LEVEL (dBuV)	LIMIT (dBuV/m)	MARGIN (dB)	ANTENNA FACTOR (dB/m)	CABLE LOSS (dB)	PREAMP FACTOR (dB)	ANTENNA HEIGHT (cm)	TABLE ANGLE (Degree)	REMARK
40.53	32.11	48.91	40	-7.89	13.55	0.67	31.02	100	241	QP
55.95	31.98	50.17	40	-8.02	12.35	0.8	31.34	100	229	QP
196.59	15.56	36.15	43.5	-27.94	9.57	1.58	31.74	100	156	Peak
379.1	18.43	33.2	46	-27.57	14.84	2.34	31.95	100	255	Peak
616.4	23.32	32.51	46	-22.68	19.81	3.14	32.14	100	186	Peak
907.6	27.73	32.24	46	-18.27	23.55	3.98	32.04	100	263	Peak

REMARKS: Emission Level = Read Level + Antenna Factor + Cable Loss - Preamp Factor



A D T

EUT TEST CONDITION		MEASUREMENT DETAIL	
CHANNEL	Channel 102	FREQUENCY RANGE	30MHz ~ 1GHz
INPUT POWER (SYSTEM)	120Vac, 60 Hz	DETECTOR FUNCTION	Peak (PK) Quasi-peak (QP)
ENVIRONMENTAL CONDITIONS	25deg. C, 65%RH	TESTED BY	Johnson Liao

ANTENNA POLARITY & TEST DISTANCE: HORIZONTAL AT 3 M										
FREQ. (MHz)	EMISSION LEVEL (dBuV/m)	READ LEVEL (dBuV)	LIMIT (dBuV/m)	MARGIN (dB)	ANTENNA FACTOR (dB/m)	CABLE LOSS (dB)	PREAMP FACTOR (dB)	ANTENNA HEIGHT (cm)	TABLE ANGLE (Degree)	REMARK
55.92	28.94	47.13	40	-11.06	12.35	0.8	31.34	100	154	QP
158.52	16.89	34.61	43.5	-26.61	12.73	1.38	31.83	100	268	Peak
263.55	21.15	39.31	46	-24.85	11.88	1.88	31.92	100	245	Peak
426	19	32.66	46	-27	15.85	2.52	32.03	100	192	Peak
639.5	24.2	33.01	46	-21.8	20.08	3.21	32.1	100	341	Peak
916	27.91	32.33	46	-18.09	23.6	4	32.02	100	239	Peak
ANTENNA POLARITY & TEST DISTANCE: VERTICAL AT 3 M										
FREQ. (MHz)	EMISSION LEVEL (dBuV/m)	READ LEVEL (dBuV)	LIMIT (dBuV/m)	MARGIN (dB)	ANTENNA FACTOR (dB/m)	CABLE LOSS (dB)	PREAMP FACTOR (dB)	ANTENNA HEIGHT (cm)	TABLE ANGLE (Degree)	REMARK
41.34	32.83	49.64	40	-7.17	13.56	0.68	31.05	100	152	QP
56.46	31.93	50.12	40	-8.07	12.35	0.8	31.34	100	163	QP
283.8	15.85	33.15	46	-30.15	12.48	1.98	31.76	100	284	Peak
394.5	18.37	32.84	46	-27.63	15.21	2.4	32.08	100	182	Peak
638.8	23.96	32.77	46	-22.04	20.08	3.21	32.1	100	268	Peak
939.1	27.98	32.14	46	-18.02	23.73	4.05	31.94	100	139	Peak

REMARKS: Emission Level = Read Level + Antenna Factor + Cable Loss - Preamp Factor

4.2 CONDUCTED EMISSION MEASUREMENT

4.2.1 LIMITS OF CONDUCTED EMISSION MEASUREMENT

FREQUENCY OF EMISSION (MHz)	CONDUCTED LIMIT (dB μ V)	
	Quasi-peak	Average
0.15 ~ 0.5	66 to 56	56 to 46
0.5 ~ 5	56	46
5 ~ 30	60	50

- NOTE:** 1. The lower limit shall apply at the transition frequencies.
 2. The limit decreases in line with the logarithm of the frequency in the range of 0.15 to 0.50MHz.
 3. All emanations from a class A/B digital device or system, including any network of conductors and apparatus connected thereto, shall not exceed the level of field strengths specified above.

4.2.2 TEST INSTRUMENTS

DESCRIPTION & MANUFACTURER	MODEL NO.	SERIAL NO.	DATE OF CALIBRATION	DUE DATE OF CALIBRATION
Test Receiver ROHDE & SCHWARZ	ESCS30	100288	Nov. 09, 2012	Nov. 08, 2013
RF signal cable Woken	5D-FB	Cable-HYCO2-01	Dec. 28, 2012	Dec. 27, 2013
LISN ROHDE & SCHWARZ (EUT)	ESH2-Z5	100100	Dec. 21, 2012	Dec. 20, 2013
LISN ROHDE & SCHWARZ (Peripheral)	ESH3-Z5	100312	Jul. 02, 2013	Jul. 01, 2014
Software ADT	BV ADT_Cond_ V7.3.7.3	NA	NA	NA

- NOTE:** 1. The calibration interval of the above test instruments is 12 months and the calibrations are traceable to NML/ROC and NIST/USA.
 2. The test was performed in HwaYa Shielded Room 2.
 3. The VCCI Site Registration No. is C-2047.

4.2.3 TEST PROCEDURES

- a. The EUT was placed 0.4 meters from the conducting wall of the shielded room with EUT being connected to the power mains through a line impedance stabilization network (LISN). Other support units were connected to the power mains through another LISN. The two LISNs provide 50 ohm/ 50uH of coupling impedance for the measuring instrument.
- b. Both lines of the power mains connected to the EUT were checked for maximum conducted interference.
- c. The frequency range from 150kHz to 30MHz was searched. Emission levels under (Limit - 20dB) was not recorded.

NOTE: All modes of operation were investigated and the worst-case emissions are reported.

4.2.4 DEVIATION FROM TEST STANDARD

No deviation.

4.2.5 TEST SETUP

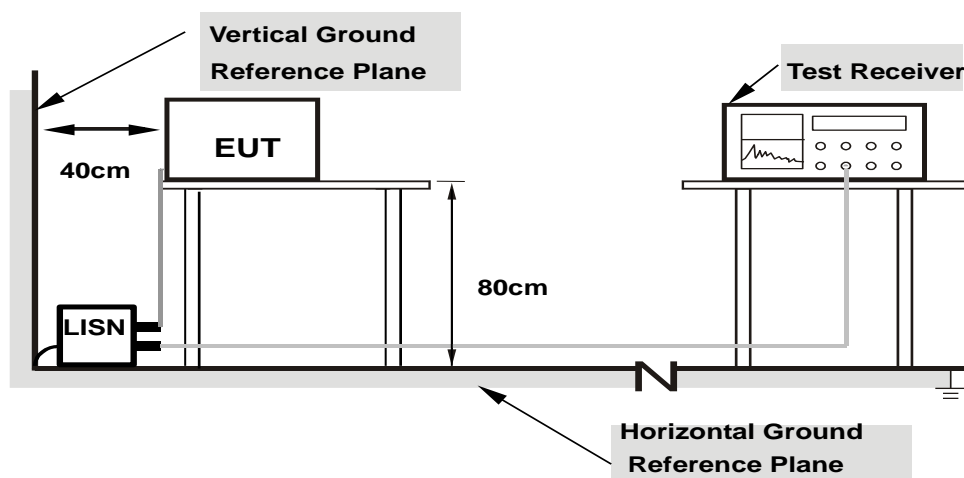

- Note:**
1. Support units were connected to second LISN.
 2. Both of LISNs (AMN) are 80 cm from EUT and at least 80 from other units and other metal planes

For the actual test configuration, please refer to the attached file (Test Setup Photo).

4.2.6 EUT OPERATING CONDITIONS

Same as 4.1.6.

4.2.7 TEST RESULTS

CONDUCTED WORST-CASE DATA :

PHASE	Line 1	6dB BANDWIDTH	9kHz
-------	--------	---------------	------

No	Freq. [MHz]	Corr. Factor (dB)	Reading Value [dB (uV)]		Emission Level [dB (uV)]		Limit [dB (uV)]		Margin (dB)	
			Q.P.	AV.	Q.P.	AV.	Q.P.	AV.	Q.P.	AV.
			1	0.28672	0.19	36.50	29.09	36.69	29.28	60.62
2	0.42344	0.21	46.58	38.75	46.79	38.96	57.38	47.38	-10.59	-8.42
3	0.98984	0.27	44.79	36.01	45.06	36.28	56.00	46.00	-10.94	-9.72
4	2.33984	0.30	41.80	34.12	42.10	34.42	56.00	46.00	-13.90	-11.58
5	6.51563	0.40	35.87	27.75	36.27	28.15	60.00	50.00	-23.73	-21.85
6	13.55859	0.50	39.93	38.06	40.43	38.56	60.00	50.00	-19.57	-11.44

REMARKS:

1. Q.P. and AV. are abbreviations of quasi-peak and average individually.
2. The emission levels of other frequencies were very low against the limit.
3. Margin value = Emission level - Limit value
4. Correction factor = Insertion loss + Cable loss
5. Emission Level = Correction Factor + Reading Value

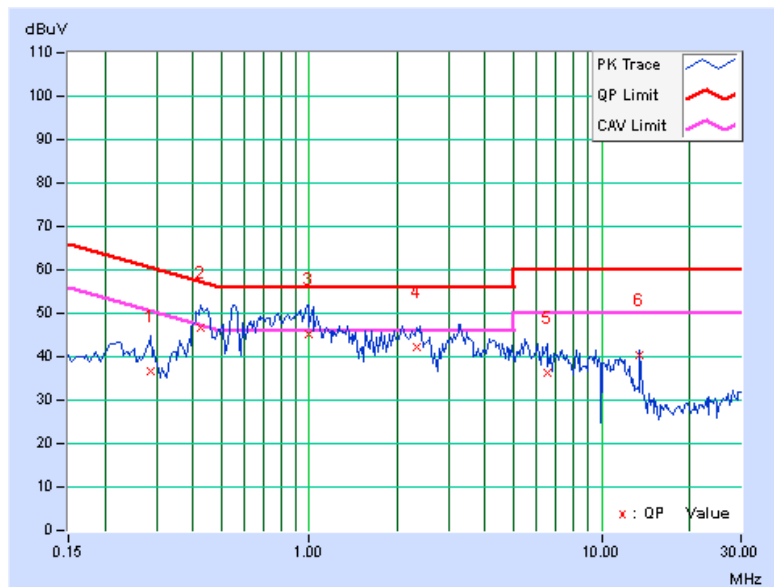



A D T

PHASE	Line 2	6dB BANDWIDTH	9kHz
-------	--------	---------------	------

No	Freq. [MHz]	Corr. Factor (dB)	Reading Value [dB (uV)]		Emission Level [dB (uV)]		Limit [dB (uV)]		Margin (dB)	
			Q.P.	AV.	Q.P.	AV.	Q.P.	AV.	Q.P.	AV.
			1	0.28281	0.21	37.52	30.47	37.73	30.68	60.73
2	0.44688	0.25	45.44	39.49	45.69	39.74	56.93	46.93	-11.24	-7.19
3	0.95078	0.23	40.26	31.80	40.49	32.03	56.00	46.00	-15.51	-13.97
4	2.15234	0.29	42.46	35.00	42.75	35.29	56.00	46.00	-13.25	-10.71
5	7.35938	0.44	32.68	24.81	33.12	25.25	60.00	50.00	-26.88	-24.75
6	13.56250	0.57	36.47	35.57	37.04	36.14	60.00	50.00	-22.96	-13.86

REMARKS:

1. Q.P. and AV. are abbreviations of quasi-peak and average individually.
2. The emission levels of other frequencies were very low against the limit.
3. Margin value = Emission level - Limit value
4. Correction factor = Insertion loss + Cable loss
5. Emission Level = Correction Factor + Reading Value

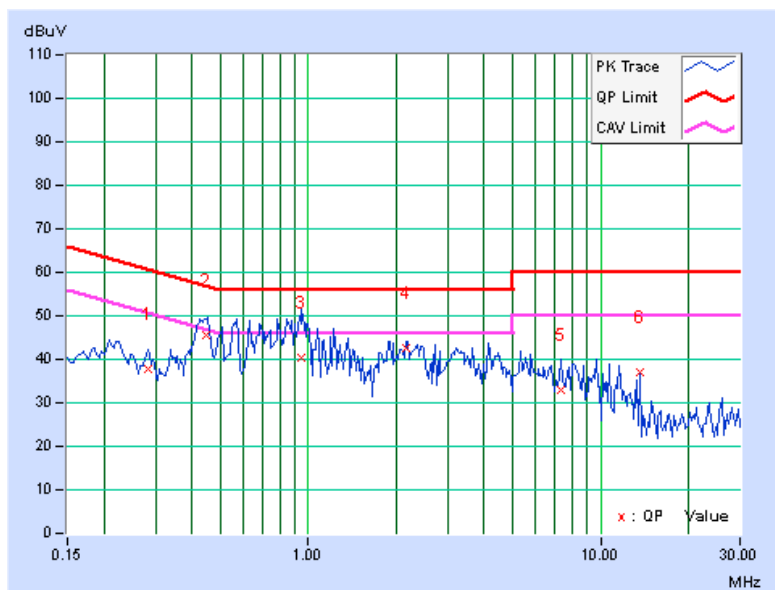

4.3 PEAK TRANSMIT POWER MEASUREMENT

4.3.1 LIMITS OF PEAK TRANSMIT POWER MEASUREMENT

FREQUENCY BAND	LIMIT
5.150 ~ 5.250GHz	The lesser of 50mW (17dBm) or 4dBm + 10logB
5.250 ~ 5.350GHz	The lesser of 250mW (24dBm) or 11dBm + 10logB
5.470 ~ 5.725GHz	The lesser of 250mW (24dBm) or 11dBm + 10logB

NOTE: Where B is the 26dB emission bandwidth in MHz.

4.3.2 TEST SETUP

FOR POWER OUTPUT MEASUREMENT

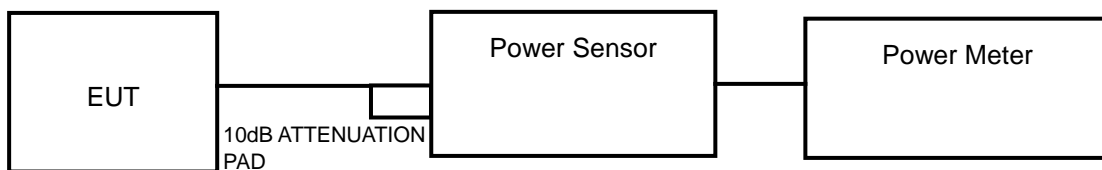

FOR 26dB BANDWIDTH

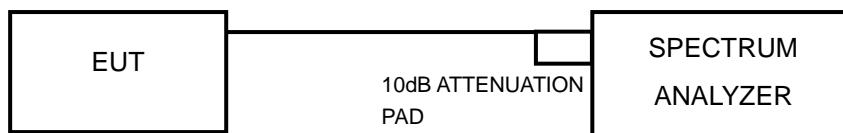

4.3.3 TEST INSTRUMENTS

Refer to section 4.1.3 to get information of above instrument.

4.3.4 TEST PROCEDURE

FOR AVERAGE POWER MEASUREMENT

<802.11a, 802.11n (20MHz), 802.11n (40MHz)>

Method PM is used to perform output power measurement, trigger and gating function of wide band power meter is enabled to measure max output power of TX on burst. Duty factor is added to measured value.

FOR 26dB BANDWIDTH

- 1) Set RBW = approximately 1% of the emission bandwidth.
- 2) Set the VBW > RBW.
- 3) Detector = Peak.
- 4) Trace mode = max hold.
- 5) Measure the maximum width of the emission that is 26 dB down from the peak of the emission. Compare this with the RBW setting of the analyzer. Readjust RBW and repeat measurement as needed until the RBW/EBW ratio is approximately 1%.

4.3.5 DEVIATION FROM TEST STANDARD

No deviation.

4.3.6 EUT OPERATING CONDITIONS

The software provided by client to enable the EUT under transmission condition continuously at specific channel frequencies individually.

4.3.7 TEST RESULTS

POWER OUTPUT: 802.11a

CHANNEL	CHANNEL FREQUENCY (MHz)	AVERAGE POWER (mW)	AVERAGE POWER (dBm)	POWER LIMIT (dBm)	PASS/FAIL
36	5180	18.113	12.58	17	PASS
44	5220	19.143	12.82	17	PASS
48	5240	19.187	12.83	17	PASS
52	5260	18.923	12.77	24	PASS
60	5300	18.836	12.75	24	PASS
64	5320	19.011	12.79	24	PASS
100	5500	18.408	12.65	24	PASS
116	5580	18.030	12.56	24	PASS
140	5700	17.947	12.54	24	PASS

802.11n (20MHz)

CHANNEL	CHANNEL FREQUENCY (MHz)	AVERAGE POWER (mW)	AVERAGE POWER (dBm)	POWER LIMIT (dBm)	PASS/FAIL
36	5180	18.365	12.64	17	PASS
44	5220	18.967	12.78	17	PASS
48	5240	18.793	12.74	17	PASS
52	5260	18.793	12.74	24	PASS
60	5300	18.707	12.72	24	PASS
64	5320	19.011	12.79	24	PASS
100	5500	18.664	12.71	24	PASS
116	5580	18.365	12.64	24	PASS
140	5700	18.450	12.66	24	PASS

802.11n (40MHz)

CHANNEL	CHANNEL FREQUENCY (MHz)	AVERAGE POWER (mW)	AVERAGE POWER (dBm)	POWER LIMIT (dBm)	PASS/FAIL
38	5190	21.232	13.27	17	PASS
46	5230	21.727	13.37	17	PASS
54	5270	21.429	13.31	24	PASS
62	5310	22.182	13.46	24	PASS
102	5510	21.577	13.34	24	PASS
110	5550	21.038	13.23	24	PASS
134	5670	21.380	13.30	24	PASS

**26dB BANDWIDTH: 802.11a**

CHANNEL	CHANNEL FREQUENCY (MHz)	26dBc BANDWIDTH (MHz)	PASS / FAIL
36	5180	23.78	PASS
44	5220	23.77	PASS
48	5240	23.74	PASS
52	5260	23.48	PASS
60	5300	23.94	PASS
64	5320	23.74	PASS
100	5500	23.88	PASS
116	5580	23.76	PASS
140	5700	23.44	PASS

802.11n (20MHz)

CHANNEL	CHANNEL FREQUENCY (MHz)	26dBc BANDWIDTH (MHz)	PASS / FAIL
36	5180	23.77	PASS
44	5220	23.58	PASS
48	5240	23.84	PASS
52	5260	24.05	PASS
60	5300	23.79	PASS
64	5320	24.06	PASS
100	5500	24.32	PASS
116	5580	24.12	PASS
140	5700	24.05	PASS

802.11n (40MHz)

CHANNEL	CHANNEL FREQUENCY (MHz)	26dBc BANDWIDTH (MHz)	PASS / FAIL
38	5190	54.29	PASS
46	5230	52.42	PASS
54	5270	53.20	PASS
62	5310	51.43	PASS
102	5510	53.60	PASS
110	5550	54.09	PASS
134	5670	52.54	PASS



A D T

SPECTRUM PLOT OF WORST VALUE

802.11a

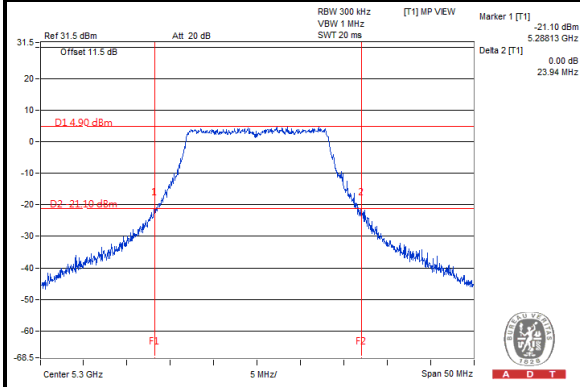

802.11n (20MHz)

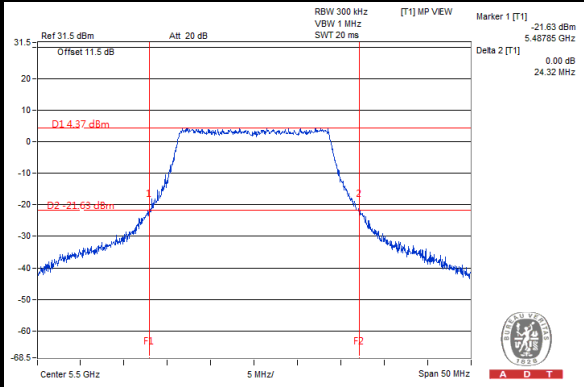

802.11n (40MHz)

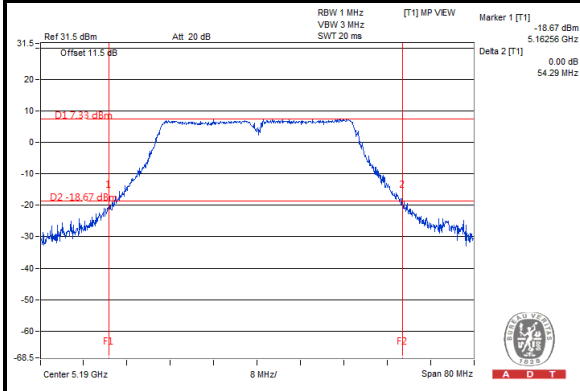

4.4 PEAK POWER SPECTRAL DENSITY MEASUREMENT

4.4.1 LIMITS OF PEAK POWER SPECTRAL DENSITY MEASUREMENT

FREQUENCY BAND	LIMIT
5.150 ~ 5.250GHz	4dBm
5.250 ~ 5.350GHz	11dBm
5.470 ~ 5.725GHz	11dBm

4.4.2 TEST SETUP

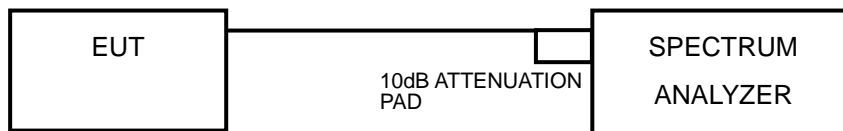

4.4.3 TEST INSTRUMENTS

Refer to section 4.1.3 to get information of above instrument.

4.4.4 TEST PROCEDURES

<802.11a, 802.11n (20MHz), 802.11n (40MHz)>

Using method SA-2 alternative

- 1) Set span to encompass the entire emission bandwidth (EBW) of the signal.
- 2) Set RBW = 1 MHz, Set VBW \geq 3 MHz, Detector = RMS
- 3) Sweep time = 4second.
- 4) Perform a single sweep.
- 5) Record the max value and add 10 log (1/duty cycle)

4.4.5 DEVIATION FROM TEST STANDARD

No deviation.

4.4.6 EUT OPERATING CONDITIONS

Same as 4.3.6.

4.4.7 TEST RESULTS

802.11a

CHANNEL	FREQUENCY (MHz)	PSD W/O DUTY FACTOR (dBm)	DUTY FACTOR	PSD WITH DUTY FACTOR (dBm)	MAXIMUM LIMIT (dBm)	PASS/FAIL
36	5180	0.74	0.23	0.97	4	PASS
44	5220	0.92	0.23	1.15	4	PASS
48	5240	1.10	0.23	1.33	4	PASS
52	5260	1.30	0.23	1.53	11	PASS
60	5300	1.50	0.23	1.73	11	PASS
64	5320	1.45	0.23	1.68	11	PASS
100	5500	1.31	0.23	1.54	11	PASS
116	5580	1.37	0.23	1.60	11	PASS
140	5700	1.16	0.23	1.39	11	PASS

NOTE: Refer to section 3.3 for duty cycle spectrum plot.

802.11n (20MHz)

CHANNEL	FREQUENCY (MHz)	PSD W/O DUTY FACTOR (dBm)	DUTY FACTOR	PSD WITH DUTY FACTOR (dBm)	MAXIMUM LIMIT (dBm)	PASS/FAIL
36	5180	0.57	0.25	0.82	4	PASS
44	5220	0.83	0.25	1.08	4	PASS
48	5240	0.84	0.25	1.09	4	PASS
52	5260	1.00	0.25	1.25	11	PASS
60	5300	1.22	0.25	1.47	11	PASS
64	5320	1.36	0.25	1.61	11	PASS
100	5500	1.30	0.25	1.55	11	PASS
116	5580	1.30	0.25	1.55	11	PASS
140	5700	0.87	0.25	1.12	11	PASS

NOTE: Refer to section 3.3 for duty cycle spectrum plot.



802.11n (40MHz)

CHANNEL	FREQUENCY (MHz)	PSD W/O DUTY FACTOR (dBm)	DUTY FACTOR	PSD WITH DUTY FACTOR (dBm)	MAXIMUM LIMIT (dBm)	PASS/FAIL
38	5190	-1.98	0.57	-1.41	4	PASS
46	5230	-1.62	0.57	-1.05	4	PASS
54	5270	-1.40	0.57	-0.83	11	PASS
62	5310	-1.12	0.57	-0.55	11	PASS
102	5510	-1.33	0.57	-0.76	11	PASS
110	5550	-1.35	0.57	-0.78	11	PASS
134	5670	-1.61	0.57	-1.04	11	PASS

NOTE: Refer to section 3.3 for duty cycle spectrum plot.

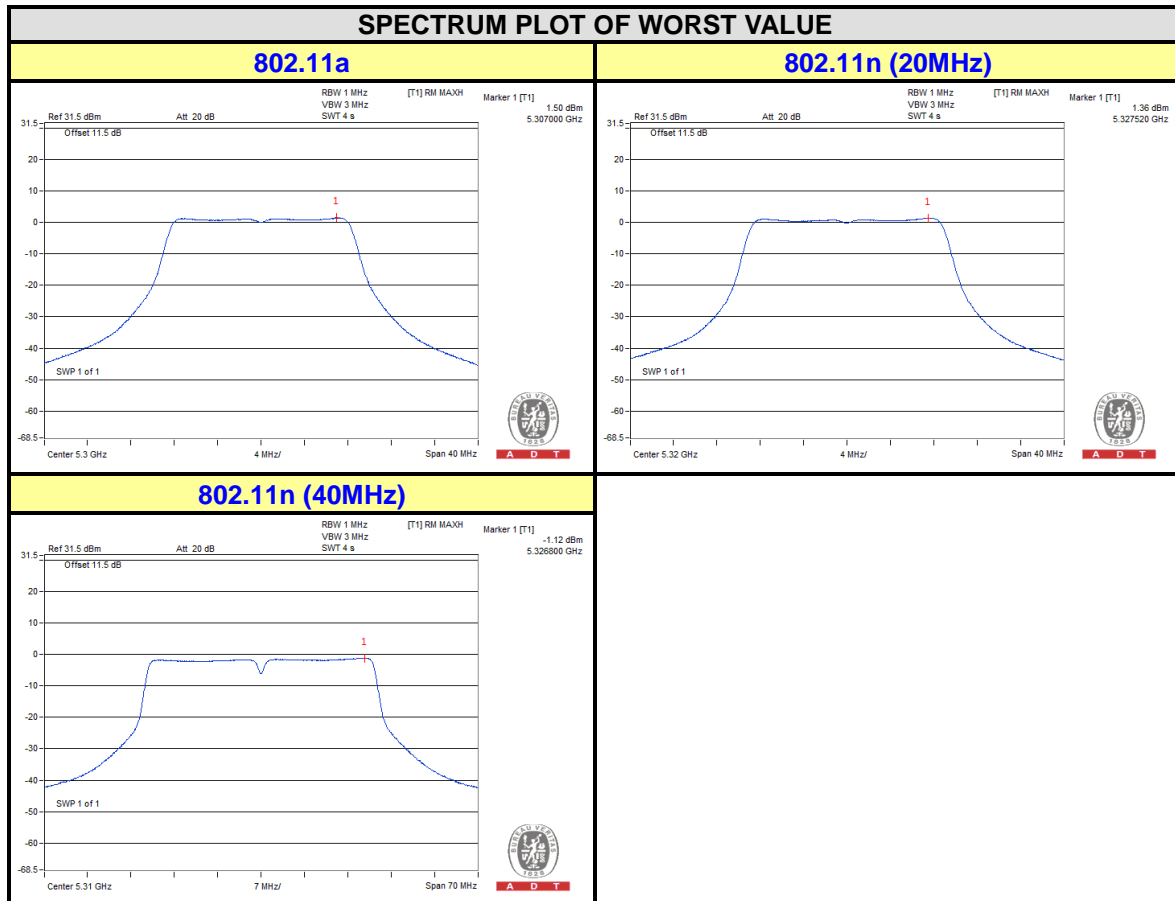

4.5 PEAK POWER EXCURSION MEASUREMENT

4.5.1 LIMITS OF PEAK POWER EXCURSION MEASUREMENT

Shall not exceed 13 dB.

4.5.2 TEST SETUP

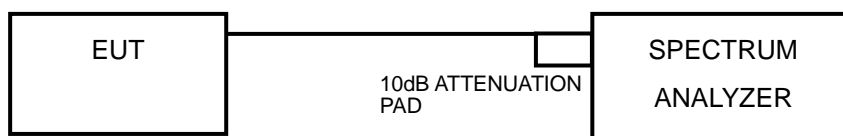

4.5.3 TEST INSTRUMENTS

Refer to section 4.1.3 to get information of above instrument.

4.5.4 TEST PROCEDURE

- 1) Set RBW = 1 MHz, VBW \geq 3 MHz, Detector = peak.
- 2) Trace mode = max-hold. Allow the sweeps to continue until the trace stabilizes.
- 3) Use the peak search function to find the peak of the spectrum.
- 4) Measure the PPSD.
- 5) Compute the ratio of the maximum of the peak-max-hold spectrum to the PPSD.

4.5.5 DEVIATION FROM TEST STANDARD

No deviation.

4.5.6 EUT OPERATING CONDITIONS

Same as 4.2.6



4.5.7 TEST RESULTS

MODULATION MODE	MODULATION TYPE	CHAN. FREQ. (MHz)	PEAK VALUE (dBm)	PPSD WITHOUT DUTY FACTOR (dBm)	PPSD WITH DUTY FACTOR (dBm)	PEAK EXCURSION (dB)	LIMIT (dB)	PASS /FAIL
802.11a	BPSK	5240	10.59	1.10	1.33	9.26	13	PASS
	QPSK		11.53	0.89	1.12	10.41	13	PASS
	16QAM		10.17	-0.16	0.07	10.10	13	PASS
	64QAM		8.67	-2.50	-2.27	10.94	13	PASS
802.11n (20MHz)	BPSK	5320	10.70	1.36	1.61	9.09	13	PASS
	QPSK		10.24	1.38	1.63	8.61	13	PASS
	16QAM		10.63	0.15	0.40	10.23	13	PASS
	64QAM		10.56	-0.28	-0.03	10.59	13	PASS
802.11n (40MHz)	BPSK	5310	8.53	-1.12	-0.55	9.08	13	PASS
	QPSK		8.99	-1.51	-0.94	9.93	13	PASS
	16QAM		7.01	-3.78	-3.21	10.22	13	PASS
	64QAM		7.55	-4.55	-3.98	11.53	13	PASS

NOTE: Refer to section 3.3 for duty cycle spectrum plot.

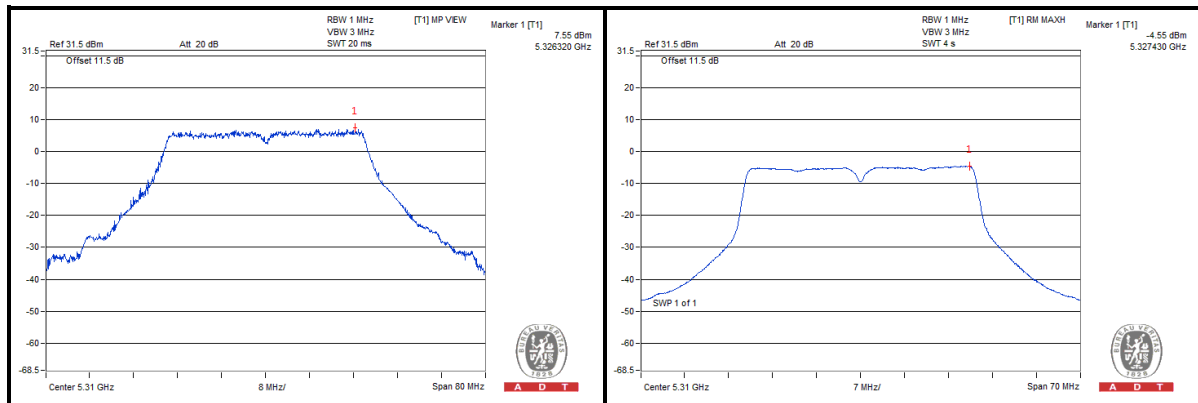

4.6 FREQUENCY STABILITY

4.6.1 LIMITS OF FREQUENCY STABILITY MEASUREMENT

The frequency of the carrier signal shall be maintained within band of operation

4.6.2 TEST SETUP

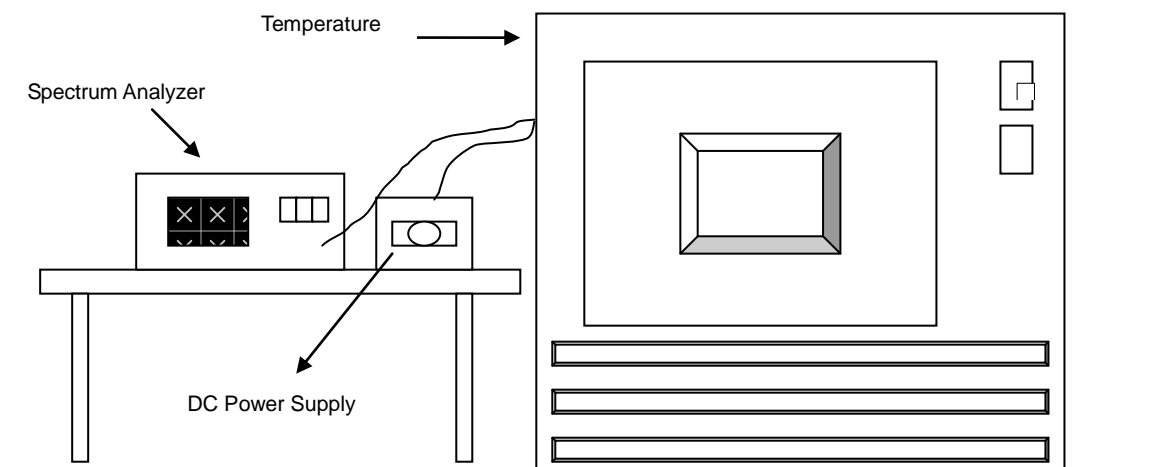

4.6.3 TEST INSTRUMENTS

Refer to section 4.1.3 to get information of above instrument.

4.6.4 TEST PROCEDURE

- a. To ensure emission at the band edge is maintained within the authorized band, those values shall be measured by radiation emissions at upper and lower frequency points, and finally compensated by frequency deviation as procedures below.
- b. The EUT was operated at the maximum output power, and connected to the spectrum analyzer, which is set to maximum hold function and peak detector. The peak value of the power envelope was measured and noted. The upper and lower frequency points were respectively measured relatively 10dB lower than the measured peak value.
- c. The frequency deviation was calculated by adding the upper frequency point and the lower frequency point divided by two. Those detailed values of frequency deviation are provided in table below.

4.6.5 DEVIATION FROM TEST STANDARD

No deviation.

4.6.6 EUT OPERATING CONDITION

Set the EUT transmit at un-modulation mode to test frequency stability.

4.6.7 TEST RESULTS

FREQUENCY STABILITY VERSUS TEMP.									
OPERATING FREQUENCY: 5320MHz									
TEMP. (°C)	POWER SUPPLY (Vdc)	0 MINUTE		2 MINUTE		5 MINUTE		10 MINUTE	
		Measured Frequency (MHz)	Frequency Drift (ppm)	Measured Frequency (MHz)	Frequency Drift (ppm)	Measured Frequency (MHz)	Frequency Drift (ppm)	Measured Frequency (MHz)	Frequency Drift (ppm)
60	3.8	5320.041290	7.761	5320.041531	7.807	5320.041014	7.709	5320.041597	7.819
50	3.8	5320.041733	7.845	5320.041767	7.851	5320.042048	7.904	5320.041963	7.888
40	3.8	5320.042302	7.952	5320.041589	7.817	5320.041917	7.879	5320.042042	7.903
30	3.8	5320.043487	8.174	5320.043348	8.148	5320.042881	8.060	5320.043281	8.136
20	3.8	5320.045249	8.505	5320.044957	8.451	5320.045079	8.473	5320.045075	8.473
10	3.8	5320.045427	8.539	5320.045831	8.615	5320.045651	8.581	5320.045661	8.583
0	3.8	5320.043951	8.261	5320.043693	8.213	5320.043996	8.270	5320.044428	8.351
-10	3.8	5320.042177	7.928	5320.042488	7.986	5320.042720	8.030	5320.042688	8.024
-20	3.8	5320.041681	7.835	5320.042183	7.929	5320.041952	7.886	5320.041799	7.857
-30	3.8	5320.041404	7.783	5320.041058	7.718	5320.040953	7.698	5320.040819	7.673

FREQUENCY STABILITY VERSUS VOLTAGE									
OPERATING FREQUENCY: 5320MHz									
TEMP. (°C)	POWER SUPPLY (Vac)	0 MINUTE		2 MINUTE		5 MINUTE		10 MINUTE	
		Measured Frequency (MHz)	Frequency Drift (ppm)	Measured Frequency (MHz)	Frequency Drift (ppm)	Measured Frequency (MHz)	Frequency Drift (ppm)	Measured Frequency (MHz)	Frequency Drift (ppm)
20	3.6	5320.044778	8.417	5320.044582	8.380	5320.045115	8.480	5320.045040	8.466
	3.8	5320.045249	8.505	5320.044957	8.451	5320.045079	8.473	5320.045075	8.473
	4.34	5320.046055	8.657	5320.046328	8.708	5320.046108	8.667	5320.046452	8.732

5. PHOTOGRAPHS OF THE TEST CONFIGURATION

Please refer to the attached file (Test Setup Photo).



6. INFORMATION ON THE TESTING LABORATORIES

We, Bureau Veritas Consumer Products Services (H.K.) Ltd., Taoyuan Branch, were founded in 1988 to provide our best service in EMC, Radio, Telecom and Safety consultation. Our laboratories are accredited and approved according to ISO/IEC 17025.

If you have any comments, please feel free to contact us at the following:

Linko EMC/RF Lab:

Tel: 886-2-26052180

Fax: 886-2-26051924

Hsin Chu EMC/RF Lab:

Tel: 886-3-5935343

Fax: 886-3-5935342

Hwa Ya EMC/RF/Safety Telecom Lab:

Tel: 886-3-3183232

Fax: 886-3-3270892

Email: service.adt@tw.bureauveritas.com

Web Site: www.bureauveritas-adt.com

The address and road map of all our labs can be found in our web site also.

7. APPENDIX A - MODIFICATIONS RECORDERS FOR ENGINEERING CHANGES TO THE EUT BY THE LAB

No modifications were made to the EUT by the lab during the test.

---END---