



A D T

FCC HAC (RF Emission) Test Report

Report No. : SA130716C14-1
Applicant : HTC Corporation
Address : No. 23, Xinghua Rd., Taoyuan City, Taiwan
Product : Smartphone
FCC ID : NM80P4E100
Brand : HTC
Model No. : 0P4E100
Standards : FCC 47 CFR Part 20.19
ANSI C63.19-2007
Date of Testing : Jul. 22, 2013 ~ Jul. 25, 2013
Summary M-Rating : M3

CERTIFICATION: The above equipment have been tested by **Bureau Veritas Consumer Products Services (H.K.) Ltd., Taoyuan Branch - Taiwan HwaYa Lab**, and found compliance with the requirement of the above standards. The test record, data evaluation & Equipment Under Test (EUT) configurations represented herein are true and accurate accounts of the measurements of the sample's HAC characteristics under the conditions specified in this report. It should not be reproduced except in full, without the written approval of our laboratory. The client should not use it to claim product certification, approval, or endorsement by TAF or any government agencies.

Prepared By : Ivonne Wu
Ivonne Wu / Senior Specialist

Approved By : Roy Wu
Roy Wu / Manager



This report is for your exclusive use. Any copying or replication of this report to or for any other person or entity, or use of our name or trademark, is permitted only with our prior written permission. This report sets forth our findings solely with respect to the test samples identified herein. The results set forth in this report are not indicative or representative of the quality or characteristics of the lot from which a test sample was taken or any similar or identical product unless specifically and expressly noted. Our report includes all of the tests requested by you and the results thereof based upon the information that you provided to us. You have 60 days from date of issuance of this report to notify us of any material error or omission caused by our negligence, provided, however, that such notice shall be in writing and shall specifically address the issue you wish to raise. A failure to raise such issue within the prescribed time shall constitute your unqualified acceptance of the completeness of this report, the tests conducted and the correctness of the report contents. Unless specific mention, the uncertainty of measurement has been explicitly taken into account to declare the compliance or non-compliance to the specification.



Table of Contents

Release Control Record	3
1. Summary of Maximum M-Rating	4
2. Description of Equipment Under Test	5
3. HAC RF Emission Measurement System	6
3.1 SPEAG DASYS System	6
3.1.1 Robot.....	7
3.1.2 Probes.....	7
3.1.3 Data Acquisition Electronics (DAE)	8
3.1.4 Phantoms.....	8
3.1.5 Device Holder.....	8
3.1.6 RF Emission Calibration Dipoles.....	8
3.2 DASYS System Verification.....	9
3.3 EUT Measurements Reference and Plane.....	10
3.4 HAC RF Emission Measurement Procedure.....	11
3.5 Probe Modulation Factor.....	13
4. HAC Measurement Evaluation.....	15
4.1 M-Rating Category	15
4.2 EUT Configuration and Setting.....	16
4.3 System Verification.....	16
4.4 Conducted Power Results.....	16
4.5 HAC RF Emission Testing Results	17
4.5.1 E-Field Emissions	17
4.5.2 H-Field Emissions	17
5. Calibration of Test Equipment.....	18
6. Measurement Uncertainty.....	19
7. Information on the Testing Laboratories.....	20
Appendix A. Plots of System Verification	
Appendix B. Plots of HAC RF Emission Measurement	
Appendix C. Calibration Certificate for Probe and Dipole	
Appendix D. Photographs of EUT and Setup	



Release Control Record

Issue No.	Reason for Change	Date Issued
R01	Initial release	Aug. 08, 2013



1. Summary of Maximum M-Rating

Mode / Band	Maximum Field		M-Rating
CDMA2000 BC0	E-Field (V/m)	203.4	M3
	H-Field (A/m)	0.358	M4
CDMA2000 BC1	E-Field (V/m)	36.44	M4
	H-Field (A/m)	0.249	M3
CDMA2000 BC10	E-Field (V/m)	80.55	M4
	H-Field (A/m)	0.366	M4
Summary			M3

Note:

1. The HAC RF emission limit (**M-rating Category M3**) is specified in FCC 47 CFR part 20.19 and ANSI C63.19.
2. The device RF emission rating is determined by the minimum rating.

FCC HAC (RF Emission) Test Report

2. Description of Equipment Under Test

EUT Type	Smartphone
FCC ID	NM80P4E100
Brand Name	HTC
Model Name	0P4E100
Tx Frequency Bands (Unit: MHz)	CDMA BC0 : 824 ~ 849 CDMA BC1 : 1850 ~ 1910 CDMA BC10 : 806 ~ 901
Uplink Modulations	CDMA : QPSK
Maximum AVG Conducted Power (Unit: dBm)	CDMA BC0 : 24.92 CDMA BC1 : 24.99 CDMA BC10 : 24.79
Antenna Type	Fixed Internal Antenna
EUT Stage	Identical Prototype

Note:

- The above EUT information is declared by manufacturer and for more detailed features description please refers to the manufacturer's specifications or User's Manual.

Air Interfaces/Bands List						
Air Interface	Band	Type	C63.19 Tested	Simultaneous Transmissions	Reduced Power	VOIP
CDMA	BC0	Voice	Yes	LTE/WLAN/BT	N/A	N/A
		Data	N/A	WLAN/BT	N/A	Yes
	BC1	Voice	Yes	LTE/WLAN/BT	N/A	N/A
		Data	N/A	WLAN/BT	N/A	Yes
	BC10	Voice	Yes	LTE/WLAN/BT	N/A	N/A
		Data	N/A	WLAN/BT	N/A	Yes
LTE	25	Data	N/A	CDMA/WLAN/BT	N/A	Yes
WLAN	2.4G	Data	N/A	WWAN	N/A	Yes
	5G	Data	N/A	WWAN	N/A	Yes
Bluetooth	2450	Data	N/A	WWAN	N/A	N/A

Note: The HAC rating was evaluated for voice mode only.

3. HAC RF Emission Measurement System

3.1 SPEAG DASY System

DASY system consists of high precision robot, probe alignment sensor, phantom, robot controller, controlled measurement server and near-field probe. The robot includes six axes that can move to the precision position of the DASY4/5 software defined. The DASY software can define the area that is detected by the probe. The robot is connected to controlled box. Controlled measurement server is connected to the controlled robot box. The DAE includes amplifier, signal multiplexing, AD converter, offset measurement and surface detection. It is connected to the Electro-optical coupler (ECO). The ECO performs the conversion from the optical into digital electric signal of the DAE and transfers data to the PC.

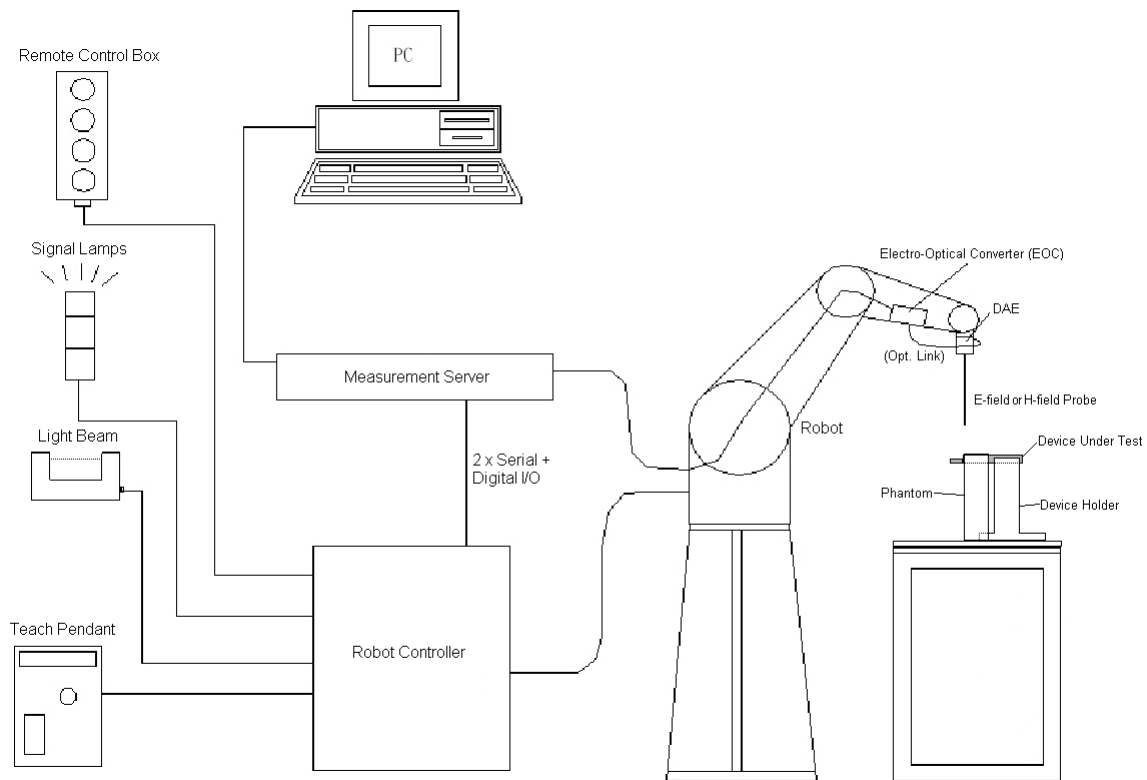

Fig-3.1 DASY System Setup

FCC HAC (RF Emission) Test Report

3.1.1 Robot

The DASY system uses the high precision robots from Stäubli SA (France). For the 6-axis controller system, the robot controller version (DASY4: CS7MB; DASY5: CS8c) from Stäubli is used. The Stäubli robot series have many features that are important for our application:

- High precision (repeatability ± 0.035 mm)
- High reliability (industrial design)
- Jerk-free straight movements
- Low ELF interference (the closed metallic construction shields against motor control fields)





Fig-3.2 DASY4



Fig-3.3 DASY5

3.1.2 Probes

Model	ER3DV6	
Construction	One dipole parallel, two dipoles normal to probe axis Built-in shielding against static charges	
Frequency	40 MHz to 6 GHz Linearity: ± 0.2 dB	
Directivity	± 0.2 dB in air (rotation around probe axis) ± 0.4 dB in air (rotation normal to probe axis)	
Dynamic Range	2 V/m to 1000 V/m Linearity: ± 0.2 dB	
Dimensions	Overall length: 337 mm (Tip: 16 mm) Tip diameter: 8 mm (Body: 12 mm) Distance from probe tip to dipole centers: 2.5 mm	

Model	H3DV6	
Construction	Three concentric loop sensors with 3.8 mm loop diameters Resistively loaded detector diodes for linear response Built-in shielding against static charges	
Frequency	200 MHz to 3 GHz Output Linearized	
Directivity	± 0.2 dB (spherical isotropy error)	
Dynamic Range	10 mA/m to 2 A/m at 1GHz	
E-Field Interference	< 10 % at 3 GHz (for plane wave)	
Dimensions	Overall length: 337 mm (Tip: 40 mm) Tip diameter: 6 mm (Body: 12 mm) Distance from probe tip to dipole centers: 3 mm	

FCC HAC (RF Emission) Test Report

3.1.3 Data Acquisition Electronics (DAE)

Model	DAE3, DAE4	
Construction	Signal amplifier, multiplexer, A/D converter and control logic. Serial optical link for communication with DASY4/5 embedded system (fully remote controlled). Two step probe touch detector for mechanical surface detection and emergency robot stop.	
Measurement Range	-100 to +300 mV (16 bit resolution and two range settings: 4mV, 400mV)	
Input Offset Voltage	< 5µV (with auto zero)	
Input Bias Current	< 50 fA	
Dimensions	60 x 60 x 68 mm	

3.1.4 Phantoms

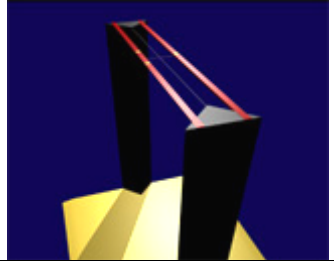
Model	Test Arch	
Construction	Enables easy and well defined positioning of the phone and validation dipoles as well as simple teaching of the robot.	
Dimensions	Length : 370 mm Width : 370 mm Height : 370 mm	

3.1.5 Device Holder

Model	Mounting Device	
Construction	The Mounting Device enables the rotation of the mounted transmitter device in spherical coordinates. Rotation point is the ear opening point. Transmitter devices can be easily and accurately positioned according to ANSI C63.19.	
Material	POM	

3.1.6 RF Emission Calibration Dipoles

Model	CD-Serial	
Construction	Free space antenna Hearing Aid susceptibility measurements according to ANSI C63.19. Validation of Hearing Aid RF setup for wireless device emission measurements according to ANSI C63.19	
Frequency	CD835V3 : 800 ~ 960 MHz CD1880V3 : 1710 ~ 2000 MHz CD2450 : 2250 ~ 2650 MHz	
Return Loss	CD835V3 : > 15 dB (835 MHz > 25 dB) CD1880V3 : > 18 dB (1880 MHz > 20 dB) CD2450V3 : > 18 dB (2450 MHz > 25 dB)	
Power Capability	> 40 W continuous	

FCC HAC (RF Emission) Test Report

3.2 DASYS System Verification

The system check verifies that the system operates within its specifications. It is performed before every E-field or H-field measurement. The system check uses normal measurements in the center section of the arch phantom with a matched dipole at a specified distance. The system verification setup is shown as below.

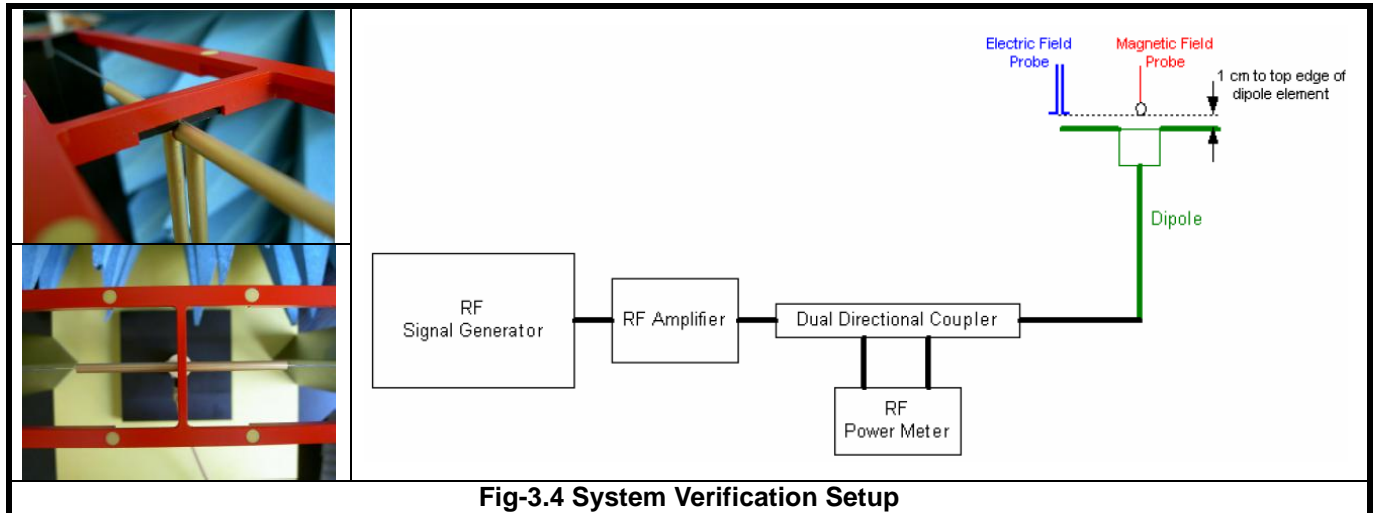

The validation dipole is placed beneath the center of arch phantom. The power meter measures the forward power at the location of the system check dipole connector. The signal generator is adjusted for the desired forward power, 100 mW (20 dBm) at the dipole connector and the RF power meter is read at that level. After connecting the cable to the dipole, the signal generator is readjusted for the same reading at RF power meter.

After system check testing, the E-field or H-field result will be compared with the reference value derived from validation dipole certificate report. The deviation of system check should be within 25 %.

The result of system verification is shown in section 4.3 of this report.

FCC HAC (RF Emission) Test Report

3.3 EUT Measurements Reference and Plane

The EUT is mounted in the device holder. The acoustic output of the EUT will coincide with the center point of the area formed by the dielectric wire and the middle bar of the arch's top frame. Then EUT will be moved vertically upwards until it touches the frame.

Fig-3.5 and Fig-3.6 illustrate the references and reference plane that is used in the RF emissions measurement.

- (a) The grid is 50 mm by 50 mm area that is divided into nine evenly sized blocks or sub-grids.
- (b) The grid is centered on the audio frequency output transducer of the EUT.
- (c) The grid is in a reference plane, which is defined as the planar area that contains the highest point in the area of the phone that normally rests against the user's ear. It is parallel to the centerline of the receiver area of the phone and is defined by the points of the receiver-end of the EUT handset, which in normal handset use rest against the ear.
- (d) The measurement plane is parallel to and 15 mm in front of the reference plane.



Fig-3.5 EUT Reference and Plane

FCC HAC (RF Emission) Test Report

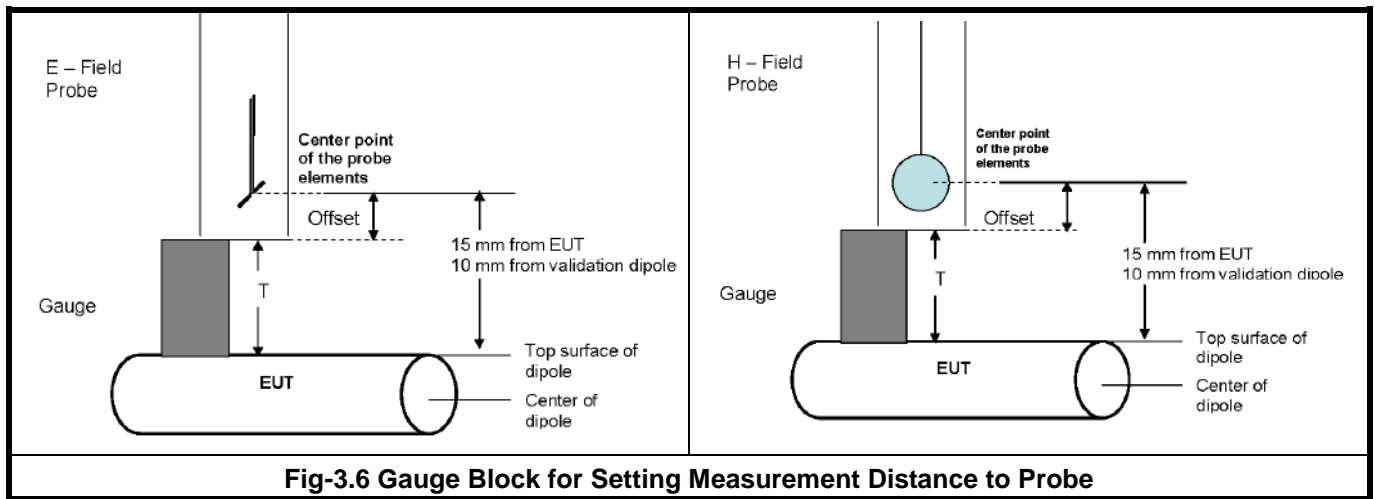

3.4 HAC RF Emission Measurement Procedure

The RF emissions test procedure for wireless communications device is as below.

1. Position the EUT in its intended test position.
2. Configure the EUT normal operation for maximum rated RF output power, at the desired channel and other operating parameters as intended for the test.
3. The center sub-grid shall center on the center of the acoustic output. Locate the field probe at the initial test position in the 50 mm by 50 mm grid, which is contained in the measurement plane.
4. Record the reading.
5. Scan the entire 50 mm by 50 mm region in equally spaced increments and record the reading at each measurement point. The distance between measurement points shall be sufficient to assure the identification of the maximum reading.
6. Identify the five contiguous sub-grids around the center sub-grid with the lowest maximum field strength readings. Thus the six areas to be used to determine the EUT's highest emissions are identified and outlined for the final manual scan. Please note that a maximum of five blocks can be excluded for both E-field and H-field measurements for the EUT output being measured. Stated another way, the center sub-grid and three others must be common to both the E-field and H-field measurements.
7. Identify the maximum field reading within the non-excluded sub-grids identified in Step 6.
8. Convert the maximum field strength reading identified in Step 7 to V/m or A/m as appropriate. For probes which require a probe modulation factor, this conversion shall be done using the appropriate probe modulation factor.
9. Repeat step 1 through step 9 for both the E-field and H-field measurements.
10. Compare this reading to the categories and record the resulting category.

FCC HAC (RF Emission) Test Report

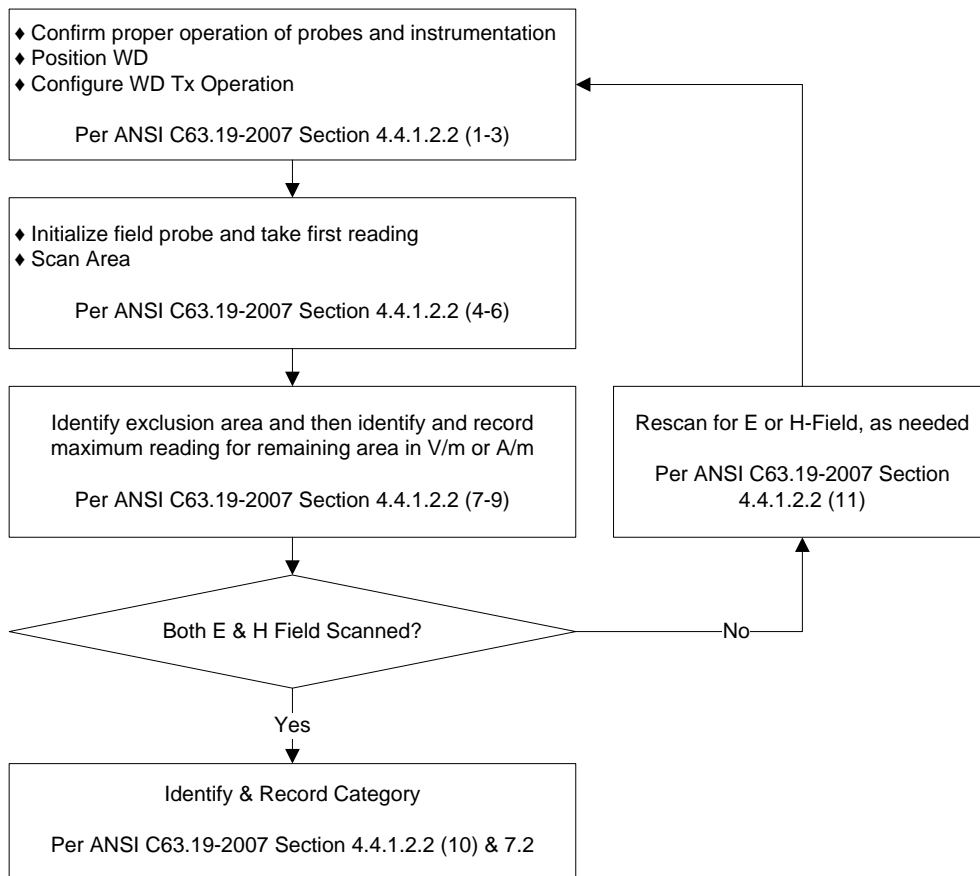

Fig-3.7 WD Near-Field Emission Test Flowchart

FCC HAC (RF Emission) Test Report

3.5 Probe Modulation Factor

The HAC standard ANSI C63.19-2007 requires measurement of the peak envelope E-field and H-field of the wireless device. Paragraph 4.2.2.1 and C.3.1 of that standard describes the probe modulation factor that shall be applied to convert the probe reading to peak envelope field.

The PMF measurement procedure is as follows.

1. Install a validation dipole for the appropriate frequency band under the Test Arch Phantom and select the proper phantom section according to the probe type installed (E-field or H-field). Move the probe to the point with the highest field, with very similar field contributions from all channels. Switch the arm power off and do not move the probe between the subsequent CW and modulated measurement.
2. The modulated signal to the dipole must be monitored to record peak amplitude and compared to a CW signal with the same peak envelope level.
3. Do not move the setup after the coupler between the modulated and the CW measurement.
4. For modulated signal measurement, connect the modulated signal using the appropriate frequency via the cable to the dipole.
5. Run the multi-meter in the procedure with the corresponding modulation setting in continuous mode.
6. Adjust the signal amplitude to achieve the same field level display in the multi-meter as during the WD field scan. Read the multi-meter display and note it together with the probe ID, modulation type and frequency.
7. Read the envelope peak on the monitor in order to adjust the CW signal later to the same level.
8. Switch the signal source off and verify that the ambient and instrumentation noise level is at least 10 dB lower.
9. For CW measurement, change the signal to CW at the same center frequency, without touching or moving the dipole or probe in the setup.
10. Adjust the CW signal amplitude to the same peak level on the spectrum analyzer.
11. Run the multi-meter in the CW procedure in continuous mode.
12. Read the multi-meter total field display and note it together with the probe ID, modulation type and frequency.
13. Calculate the PMF as the ratio between the CW multi-meter field reading and the reading for the applicable modulation.

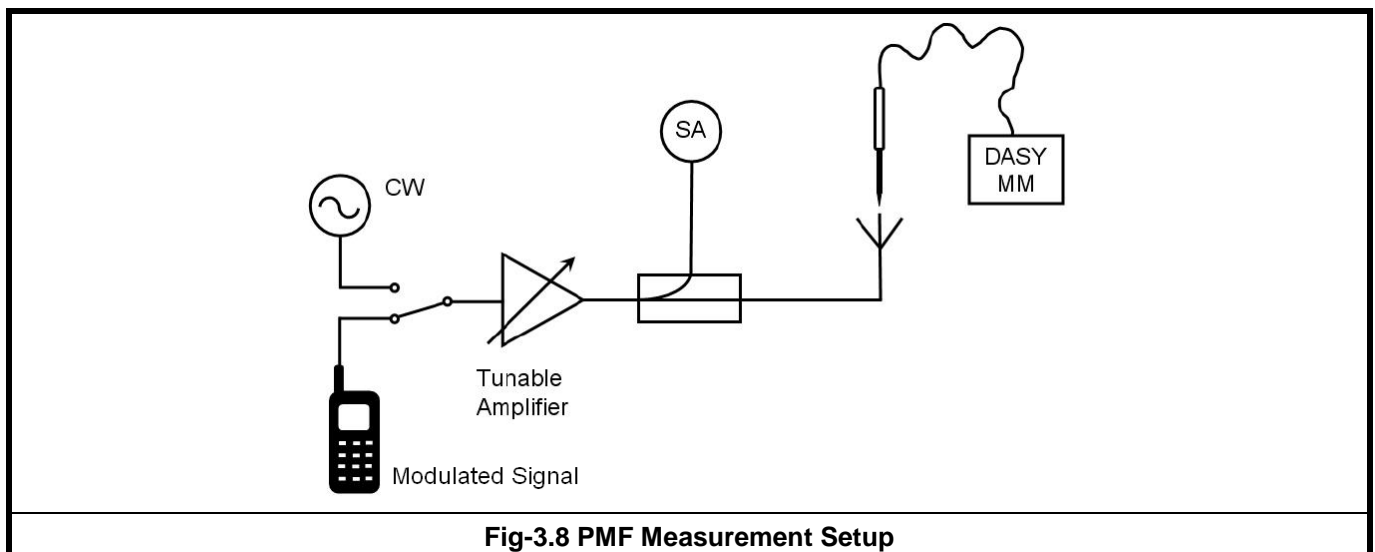

Fig-3.8 PMF Measurement Setup



FCC HAC (RF Emission) Test Report

The probe modulation factor has been calibrated by DASY manufacturer (SPEAG) in annual probe calibration and the test result will be calculated with the PMF parameter automatically. The detailed parameter can be found in the probe calibration report in appendix C.

Modulation Type	PMF
CDMA2000	2.911



FCC HAC (RF Emission) Test Report

4. HAC Measurement Evaluation

4.1 M-Rating Category

The HAC Standard ANSI C63.19-2007 represents performance requirements for acceptable interoperability of hearing aids with wireless communications devices. When these parameters are met, a hearing aid operates acceptably in close proximity to a wireless communications device.

The following AWF (Articulation Weighting Factor) factors shall be used for the standard transmission protocols.

Standard	Technology	AWF (dB)
TIA/EIA/IS-2000	CDMA	0
TIA/EIA-136	TDMA (50 Hz)	0
J-STD-007	GSM	-5
T1/T1P1/3GPP	UMTS (WCDMA)	0
iDEN	TDMA (22 and 11 Hz)	0

Category		Telephone RF Parameters < 960 MHz	
Near Field	AWF	E-Field Emissions (V/m)	H-Field Emissions (A/m)
Category M1	0	631.0 – 1122.0	1.91 – 3.39
	-5	473.2 – 841.4	1.43 – 2.54
Category M2	0	354.8 – 631.0	1.07 – 1.91
	-5	266.1 – 473.2	0.80 – 1.43
Category M3	0	199.5 – 354.8	0.60 – 1.07
	-5	149.6 – 266.1	0.45 – 0.80
Category M4	0	< 199.5	< 0.60
	-5	< 149.6	< 0.45

Category		Telephone RF Parameters > 960 MHz	
Near Field	AWF	E-Field Emissions (V/m)	H-Field Emissions (A/m)
Category M1	0	199.5 – 354.8	0.60 – 1.07
	-5	149.6 – 266.1	0.45 – 0.80
Category M2	0	112.2 – 199.5	0.34 – 0.60
	-5	84.1 – 149.6	0.25 – 0.45
Category M3	0	63.1 – 112.2	0.19 – 0.34
	-5	47.3 – 84.1	0.14 – 0.25
Category M4	0	< 63.1	< 0.19
	-5	< 47.3	< 0.14



FCC HAC (RF Emission) Test Report

4.2 EUT Configuration and Setting

For HAC RF emission testing, the EUT was linked and controlled by base station emulator. Communication between the EUT and the emulator was established by air link. The distance between the EUT and the communicating antenna of the emulator is larger than 50 cm and the output power radiated from the emulator antenna is at least 30 dB smaller than the output power of EUT. The EUT was set from the emulator to radiate maximum output power during HAC testing.

4.3 System Verification

The measuring results for system check are shown as below.

Frequency (MHz)	Input Power (dBm)	Target Value (V/m)	E-Field 1 (V/m)	E-Field 2 (V/m)	Average E-Field (V/m)	Deviation (%)	Test Date
835	20	165.8	170.1	169.1	169.6	2.29	Jul. 22, 2013
1880	20	141.7	150.7	145.3	148.0	4.45	Jul. 22, 2013
Frequency (MHz)	Input Power (dBm)	Target Value (A/m)	H-Field (A/m)		Deviation (%)	Test Date	
835	20	0.466	0.460		-1.29	Jul. 25, 2013	
1880	20	0.464	0.469		1.08	Jul. 25, 2013	

Note:

1. Comparing to the reference target value provided by SPEAG, the validation data should be within its specification of 25 %. The result indicates the system check can meet the variation criterion and the plots can be referred to Appendix A of this report.
2. For E-Field, the deviation is $[(E\text{-Field 1} + E\text{-Field 2}) / 2 - \text{Target Value}] / \text{Target Value} \times 100\%$
3. For H-Field, the deviation is $(H\text{-Field} - \text{Target Value}) / \text{Target Value} \times 100\%$

4.4 Conducted Power Results

The measuring conducted power (Unit: dBm) are shown as below.

Band	CDMA BC0			CDMA BC1		
	Channel	1013	384	777	25	600
Frequency (MHz)	824.70	836.52	848.31	1851.25	1880.00	1908.75
1xRTT RC1+SO55	24.15	24.75	24.44	24.69	24.98	24.20
1xRTT RC3+SO55	24.21	24.92	24.46	24.70	24.99	24.21
1xRTT RC3+SO32 (FCH)	24.18	24.83	24.41	24.66	24.95	24.17
1xRTT RC3+SO32 (SCH)	24.19	24.83	24.45	24.62	24.91	24.13

Band	CDMA BC10		
	Channel	476	580
Frequency (MHz)	817.9	820.5	823.1
1xRTT RC1+SO55	24.39	24.70	24.54
1xRTT RC3+SO55	24.48	24.79	24.63
1xRTT RC3+SO32 (FCH)	24.44	24.75	24.59
1xRTT RC3+SO32 (SCH)	24.41	24.72	24.56



FCC HAC (RF Emission) Test Report

4.5 HAC RF Emission Testing Results

4.5.1 E-Field Emissions

Plot No.	Band	Mode	Channel	Peak E-Field (V/m)	M-Rating
01	CDMA2000 BC0	RC1+SO55	1013	188.6	M4
	CDMA2000 BC0	RC1+SO55	384	203.4	M3
	CDMA2000 BC0	RC1+SO55	777	178.6	M4
02	CDMA2000 BC1	RC1+SO55	25	36.44	M4
	CDMA2000 BC1	RC1+SO55	600	33.33	M4
	CDMA2000 BC1	RC1+SO55	1175	29.52	M4
03	CDMA2000 BC10	RC1+SO55	476	78.64	M4
	CDMA2000 BC10	RC1+SO55	580	80.55	M4
	CDMA2000 BC10	RC1+SO55	684	75.84	M4

Note: Per pre-scan for CDMA2000, the RC1+SO55 is the worst mode which is used for HAC test.

4.5.2 H-Field Emissions

Plot No.	Band	Mode	Channel	Peak H-Field (A/m)	M-Rating
04	CDMA2000 BC0	RC1+SO55	1013	0.348	M4
	CDMA2000 BC0	RC1+SO55	384	0.358	M4
	CDMA2000 BC0	RC1+SO55	777	0.327	M4
05	CDMA2000 BC1	RC1+SO55	25	0.249	M3
	CDMA2000 BC1	RC1+SO55	600	0.241	M3
	CDMA2000 BC1	RC1+SO55	1175	0.211	M3
06	CDMA2000 BC10	RC1+SO55	476	0.256	M4
	CDMA2000 BC10	RC1+SO55	580	0.366	M4
	CDMA2000 BC10	RC1+SO55	684	0.363	M4

Note: Per pre-scan for CDMA2000, the RC1+SO55 is the worst mode which is used for HAC test.

Test Engineer : Morrison Huang, and Isaac Liao



5. Calibration of Test Equipment

Equipment	Manufacturer	Model	SN	Cal. Date	Cal. Interval
835MHz Calibration Dipole	SPEAG	CD835V3	1041	Mar. 15, 2013	Annual
1880MHz Calibration Dipole	SPEAG	CD1880V3	1032	Apr. 23, 2013	Annual
Isotropic E-Field Probe	SPEAG	ER3DV6	2445	Feb. 18, 2013	Annual
Isotropic H-Field Probe	SPEAG	H3DV6	6274	Feb. 15, 2013	Annual
Data Acquisition Electronics	SPEAG	DAE3	579	Apr. 24, 2013	Annual
Data Acquisition Electronics	SPEAG	DAE4	914	Jan. 16, 2013	Annual
Test Arch Phantom	SPEAG	Arch	N/A	N/A	N/A
Radio Communication Tester	Agilent	E5515C	MY50266628	Nov. 22, 2012	Biennial
MXG Analog Signal Generator	Agilent	N5181A	MY50143868	Jun. 06, 2013	Annual
Power Meter	Anritsu	ML2495A	1218009	Jun. 11, 2013	Annual
Power Sensor	Anritsu	MA2411B	1207252	Jun. 11, 2013	Annual
EXA Spectrum Analyzer	Agilent	N9010A	MY52100136	Jun. 26, 2013	Annual
Directional Coupler	Woken	0110A05602O-10	11122702	Apr. 18, 2013	Annual
Power Amplifier	AR	5S1G4	0339656	Apr. 18, 2013	Annual
Attenuator	Woken	00800A1G01L-03	N/A	Apr. 18, 2013	Annual

6. Measurement Uncertainty

Error Description	Uncertainty Value (±%)	Probability Distribution	Divisor	Ci (E)	Ci (H)	Standard Uncertainty (E)	Standard Uncertainty (H)
Measurement System							
Probe Calibration	5.1	Normal	1	1	1	± 5.1 %	± 5.1 %
Axial Isotropy	4.7	Rectangular	√3	1	1	± 2.7 %	± 2.7 %
Sensor Displacement	16.5	Rectangular	√3	1	0.145	± 9.5 %	± 1.4 %
Boundary Effects	2.4	Rectangular	√3	1	1	± 1.4 %	± 1.4 %
Phantom Boundary Effect	7.2	Rectangular	√3	1	0	± 4.1 %	± 0.0 %
Linearity	4.7	Rectangular	√3	1	1	± 2.7 %	± 2.7 %
Scaling with PMR Calibration	10.0	Rectangular	√3	1	1	± 5.8 %	± 5.8 %
System Detection Limit	1.0	Rectangular	√3	1	1	± 0.6 %	± 0.6 %
Readout Electronics	0.3	Normal	1	1	1	± 0.3 %	± 0.3 %
Response Time	0.8	Rectangular	√3	1	1	± 0.5 %	± 0.5 %
Integration Time	2.6	Rectangular	√3	1	1	± 1.5 %	± 1.5 %
RF Ambient Conditions	3.0	Rectangular	√3	1	1	± 1.7 %	± 1.7 %
RF Reflections	12.0	Rectangular	√3	1	1	± 6.9 %	± 6.9 %
Probe Positioner	1.2	Rectangular	√3	1	0.67	± 0.7 %	± 0.5 %
Probe Positioning	4.7	Rectangular	√3	1	0.67	± 2.7 %	± 1.8 %
Extrap. and Interpolation	1.0	Rectangular	√3	1	1	± 0.6 %	± 0.6 %
Test Sample Related							
Device Positioning Vertical	4.7	Rectangular	√3	1	0.67	± 2.7 %	± 1.8 %
Device Positioning Lateral	1.0	Rectangular	√3	1	1	± 0.6 %	± 0.6 %
Device Holder and Phantom	2.4	Rectangular	√3	1	1	± 1.4 %	± 1.4 %
Power Drift	5.0	Rectangular	√3	1	1	± 2.9 %	± 2.9 %
Phantom and Setup Related							
Phantom Thickness	2.4	Rectangular	√3	1	0.67	± 1.4 %	± 0.9 %
Combined Standard Uncertainty						± 16.3 %	± 12.3 %
Coverage Factor for 95 %						K = 2	
Expanded Uncertainty						± 32.6 %	± 24.6 %

Uncertainty budget for HAC RF Emission



FCC HAC (RF Emission) Test Report

7. Information on the Testing Laboratories

We, Bureau Veritas Consumer Products Services (H.K.) Ltd., Taoyuan Branch, were founded in 1988 to provide our best service in EMC, Radio, Telecom and Safety consultation. Our laboratories are accredited and approved according to ISO/IEC 17025.

If you have any comments, please feel free to contact us at the following:

Taiwan HwaYa EMC/RF/Safety/Telecom Lab:

Add: No. 19, Hwa Ya 2nd Rd, Wen Hwa Vil., Kwei Shan Hsiang, Taoyuan Hsien 333, Taiwan, R.O.C.
Tel: 886-3-318-3232
Fax: 886-3-327-0892

Taiwan LinKo EMC/RF Lab:

Add: No. 47, 14th Ling, Chia Pau Vil., Linkou Dist., New Taipei City 244, Taiwan, R.O.C.
Tel: 886-2-2605-2180
Fax: 886-2-2605-1924

Taiwan HsinChu EMC/RF Lab:

Add: No. 81-1, Lu Liao Keng, 9th Ling, Wu Lung Vil., Chiung Lin Township, Hsinchu County 307, Taiwan, R.O.C.
Tel: 886-3-593-5343
Fax: 886-3-593-5342

Email: service.adt@tw.bureauveritas.com

Web Site: www.adt.com.tw

The road map of all our labs can be found in our web site also.

---END---



Appendix A. Plots of System Verification

The plots for system verification are shown as follows.

System Check_E-Field_835_130722

DUT: HAC Dipole 835 MHz; Type: CD835V3; SN: 1041

Communication System: CW; Frequency: 835 MHz; Duty Cycle: 1:1

Medium: Air Medium parameters used: $\sigma = 0 \text{ S/m}$, $\epsilon_r = 1$; $\rho = 1000 \text{ kg/m}^3$

Ambient Temperature : 21.6 °C

DASY5 Configuration:

- Probe: ER3DV6 - SN2445; ConvF(1, 1, 1); Calibrated: 2013/02/18;
- Sensor-Surface: (Fix Surface)
- Electronics: DAE4 Sn914; Calibrated: 2013/01/16
- Phantom: HAC Test Arch with AMCC; Type: SD HAC P01 BA;
- Measurement SW: DASY52, Version 52.8 (4); SEMCAD X Version 14.6.10 (7164)

- Hearing Aid Compatibility Test (41x361x1): Interpolated grid: dx=0.5000 mm, dy=0.5000 mm

Device Reference Point: 0, 0, -6.3 mm

Reference Value = 127.7 V/m; Power Drift = -0.02 dB

PMF = 1.000

E-field emissions = 170.1 V/m

Grid 1 M4 167.7 V/m	Grid 2 M4 170.1 V/m	Grid 3 M4 158.3 V/m
Grid 4 M4 88.81 V/m	Grid 5 M4 91.98 V/m	Grid 6 M4 88.20 V/m
Grid 7 M4 163.6 V/m	Grid 8 M4 169.1 V/m	Grid 9 M4 161.2 V/m

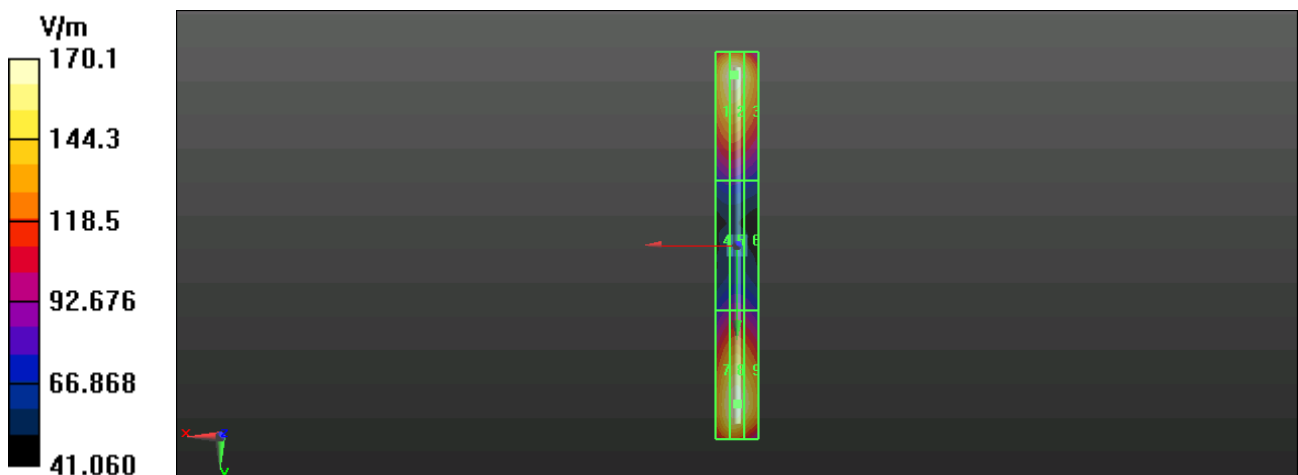

System Check_E-Field_1880_130722

DUT: HAC Dipole 1880 MHz; Type: CD1880V3; SN: 1032

Communication System: CW; Frequency: 1880 MHz; Duty Cycle: 1:1

Medium: Air Medium parameters used: $\sigma = 0 \text{ S/m}$, $\epsilon_r = 1$; $\rho = 1000 \text{ kg/m}^3$

Ambient Temperature : 21.6 °C

DASY5 Configuration:

- Probe: ER3DV6 - SN2445; ConvF(1, 1, 1); Calibrated: 2013/02/18;
- Sensor-Surface: (Fix Surface)
- Electronics: DAE4 Sn914; Calibrated: 2013/01/16
- Phantom: HAC Test Arch with AMCC; Type: SD HAC P01 BA;
- Measurement SW: DASY52, Version 52.8 (4); SEMCAD X Version 14.6.10 (7164)

- Hearing Aid Compatibility Test (41x181x1): Interpolated grid: dx=0.5000 mm, dy=0.5000 mm

Device Reference Point: 0, 0, -6.3 mm

Reference Value = 152.2 V/m; Power Drift = -0.09 dB

PMF = 1.000

E-field emissions = 150.7 V/m

Grid 1 M2 146.7 V/m	Grid 2 M2 150.7 V/m	Grid 3 M2 139.8 V/m
Grid 4 M3 90.33 V/m	Grid 5 M3 94.00 V/m	Grid 6 M3 90.90 V/m
Grid 7 M2 142.5 V/m	Grid 8 M2 145.3 V/m	Grid 9 M2 136.4 V/m

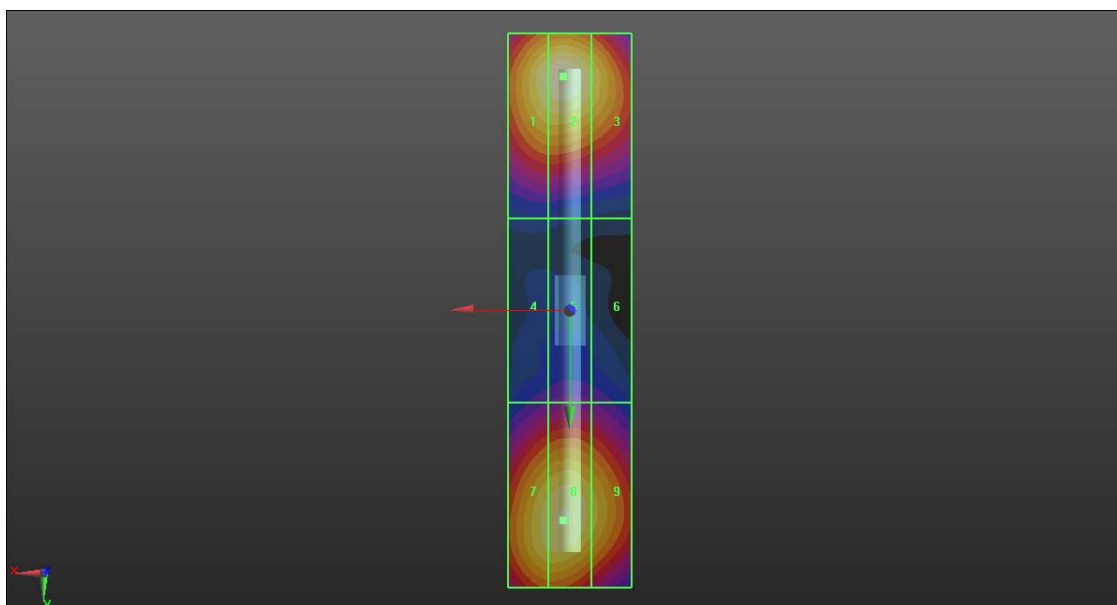
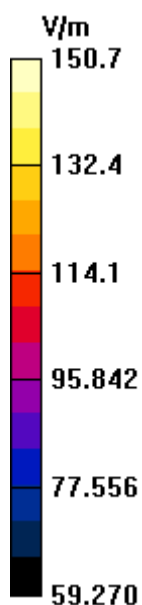

System Check_H-Field_835_130725

DUT: HAC Dipole 835 MHz; Type: CD835V3; SN: 1041

Communication System: CW; Frequency: 835 MHz; Duty Cycle: 1:1

Medium: Air Medium parameters used: $\sigma = 0 \text{ S/m}$, $\epsilon_r = 1$; $\rho = 1 \text{ kg/m}^3$

Ambient Temperature : 21.3 °C

DASY5 Configuration:

- Probe: H3DV6 - SN6274; ; Calibrated: 2013/02/15
- Sensor-Surface: (Fix Surface)
- Electronics: DAE3 Sn579; Calibrated: 2013/04/24
- Phantom: HAC Test Arch with AMCC; Type: SD HAC P01 BA;
- Measurement SW: DASY52, Version 52.8 (4); SEMCAD X Version 14.6.10 (7164)

- Hearing Aid Compatibility Test (41x361x1): Interpolated grid: dx=0.5000 mm, dy=0.5000 mm

Device Reference Point: 0, 0, -6.3 mm

Reference Value = 0.4870 A/m; Power Drift = -0.00 dB

PMF = 1.000

H-field emissions = 0.4596 A/m

PMF scaled H-field

Grid 1 M4 0.385 A/m	Grid 2 M4 0.400 A/m	Grid 3 M4 0.380 A/m
Grid 4 M4 0.439 A/m	Grid 5 M4 0.460 A/m	Grid 6 M4 0.439 A/m
Grid 7 M4 0.387 A/m	Grid 8 M4 0.405 A/m	Grid 9 M4 0.383 A/m

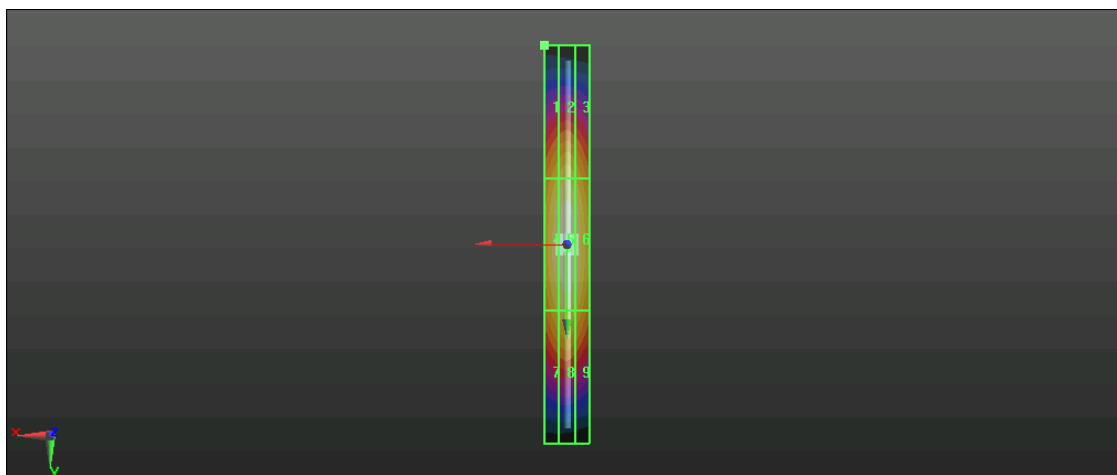
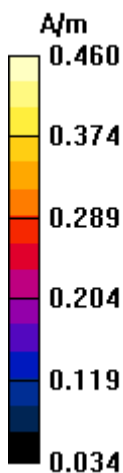

System Check_H-Field_1880_130725

DUT: HAC Dipole 1880 MHz; Type: CD1880V3; SN: 1032

Communication System: CW; Frequency: 1880 MHz; Duty Cycle: 1:1

Medium: Air Medium parameters used: $\sigma = 0 \text{ S/m}$, $\epsilon_r = 1$; $\rho = 1 \text{ kg/m}^3$

Ambient Temperature : 21.3 °C

DASY5 Configuration:

- Probe: H3DV6 - SN6274; ; Calibrated: 2013/02/15
- Sensor-Surface: (Fix Surface)
- Electronics: DAE3 Sn579; Calibrated: 2013/04/24
- Phantom: HAC Test Arch with AMCC; Type: SD HAC P01 BA;
- Measurement SW: DASY52, Version 52.8 (4); SEMCAD X Version 14.6.10 (7164)

- Hearing Aid Compatibility Test (41x181x1): Interpolated grid: dx=0.5000 mm, dy=0.5000 mm

Device Reference Point: 0, 0, -6.3 mm

Reference Value = 0.4930 A/m; Power Drift = 0.00 dB

PMF = 1.000

H-field emissions = 0.4694 A/m

Grid 1 M2 0.414 A/m	Grid 2 M2 0.427 A/m	Grid 3 M2 0.405 A/m
Grid 4 M2 0.453 A/m	Grid 5 M2 0.469 A/m	Grid 6 M2 0.447 A/m
Grid 7 M2 0.419 A/m	Grid 8 M2 0.437 A/m	Grid 9 M2 0.416 A/m

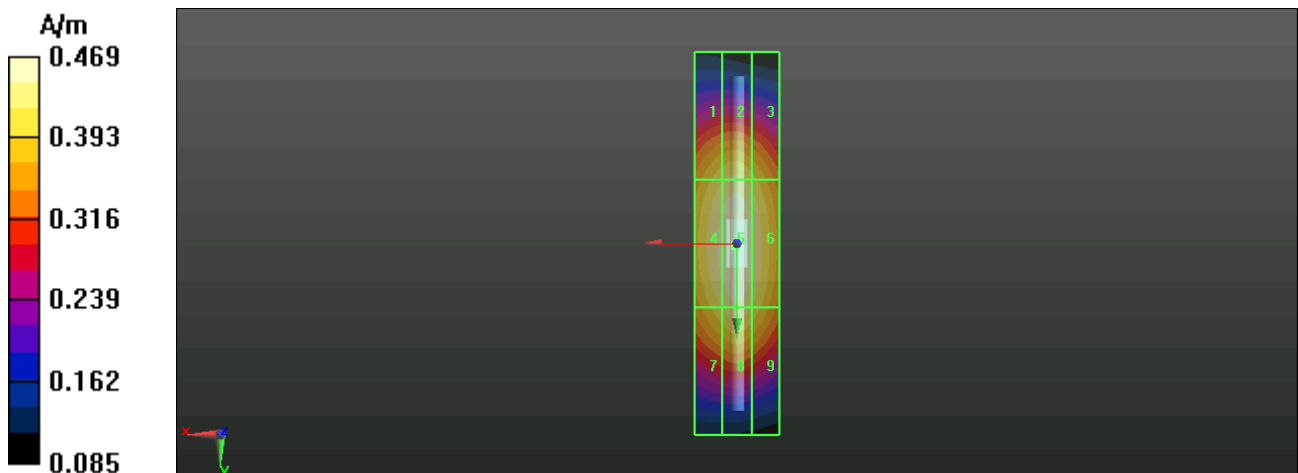



Appendix B. Plots of HAC RF Emission Measurement

The plots for HAC measurement are shown as follows.

P01 E-Field_CDMA BC0_RC1+SO55_Ch384

DUT: 130716C14

Communication System: CDMA2000 (1xRTT, RC1, 1/8 Rate); Frequency: 836.52 MHz; Duty Cycle: 1:19.81

Medium: Air Medium parameters used: $\sigma = 0$ S/m, $\epsilon_r = 1$; $\rho = 1000$ kg/m³

Ambient Temperature : 21.6 °C

DASY5 Configuration:

- Probe: ER3DV6 - SN2445; ConvF(1, 1, 1); Calibrated: 2013/02/18;
- Sensor-Surface: (Fix Surface)
- Electronics: DAE4 Sn914; Calibrated: 2013/01/16
- Phantom: HAC Test Arch with AMCC; Type: SD HAC P01 BA;
- Measurement SW: DASY52, Version 52.8 (4); SEMCAD X Version 14.6.10 (7164)

- Hearing Aid Compatibility Test (101x101x1): Interpolated grid: dx=0.5000 mm, dy=0.5000 mm

Device Reference Point: 0, 0, -6.3 mm

Reference Value = 95.02 V/m; Power Drift = -0.03 dB

PMF = 2.911

E-field emissions = 203.4 V/m

Near-field category: M3 (AWF 0 dB)

Grid 1 M4 178.8 V/m	Grid 2 M4 191.9 V/m	Grid 3 M4 187.1 V/m
Grid 4 M4 192.5 V/m	Grid 5 M3 203.4 V/m	Grid 6 M4 196.4 V/m
Grid 7 M3 201.9 V/m	Grid 8 M3 206.3 V/m	Grid 9 M4 196.1 V/m

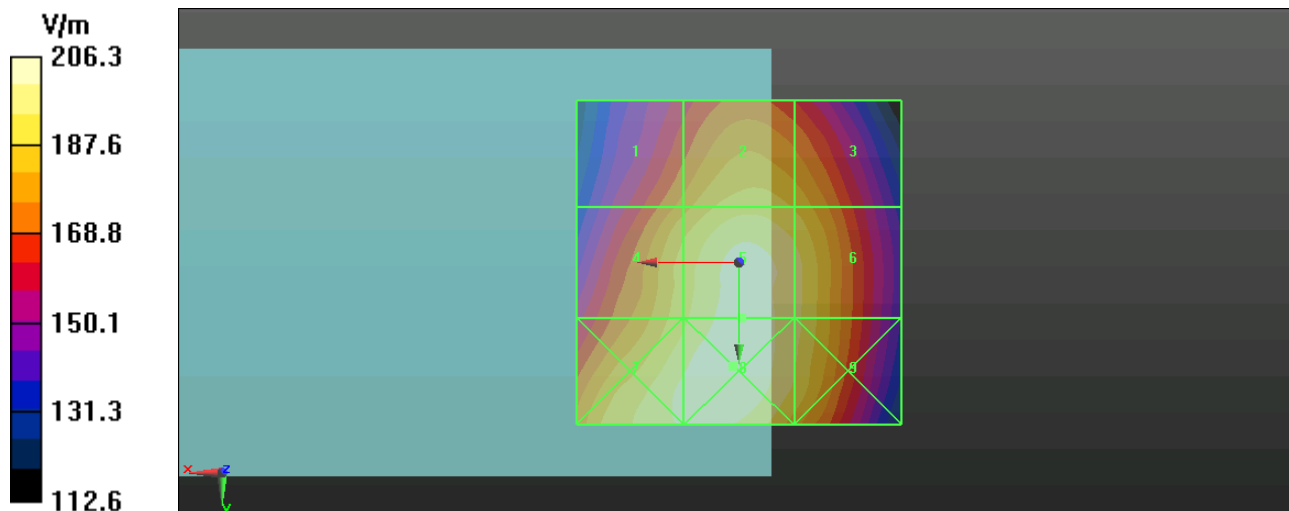

P02 E-Field_CDMA BC1_RC1+SO55_Ch25

DUT: 130716C14

Communication System: CDMA2000 (1xRTT, RC1, 1/8 Rate); Frequency: 1851.25 MHz; Duty Cycle: 1:19.81

Medium: Air Medium parameters used: $\sigma = 0$ S/m, $\epsilon_r = 1$; $\rho = 1000$ kg/m³

Ambient Temperature : 21.6 °C

DASY5 Configuration:

- Probe: ER3DV6 - SN2445; ConvF(1, 1, 1); Calibrated: 2013/02/18;
- Sensor-Surface: (Fix Surface)
- Electronics: DAE4 Sn914; Calibrated: 2013/01/16
- Phantom: HAC Test Arch with AMCC; Type: SD HAC P01 BA;
- Measurement SW: DASY52, Version 52.8 (4); SEMCAD X Version 14.6.10 (7164)

- Hearing Aid Compatibility Test (101x101x1): Interpolated grid: dx=0.5000 mm, dy=0.5000 mm

Device Reference Point: 0, 0, -6.3 mm

Reference Value = 8.021 V/m; Power Drift = 0.16 dB

PMF = 2.911

E-field emissions = 36.44 V/m

Near-field category: M4 (AWF 0 dB)

Grid 1 M4 36.44 V/m	Grid 2 M4 31.22 V/m	Grid 3 M4 29.17 V/m
Grid 4 M4 22.74 V/m	Grid 5 M4 31.72 V/m	Grid 6 M4 30.81 V/m
Grid 7 M4 38.25 V/m	Grid 8 M4 43.42 V/m	Grid 9 M4 37.79 V/m

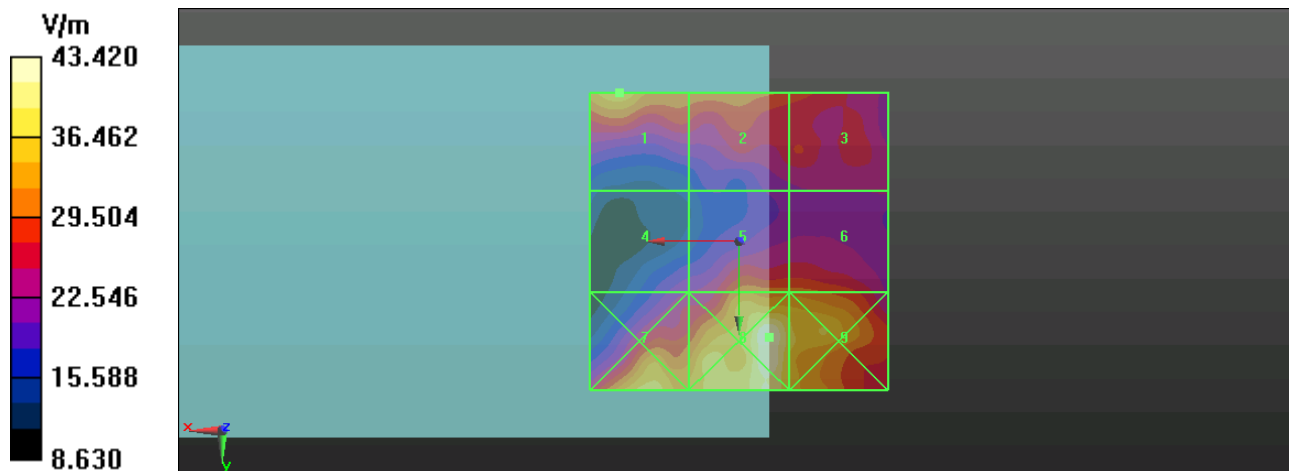

P03 E-Field_CDMA BC10_RC1+SO55_Ch580

DUT: 130716C14

Communication System: CDMA2000 (1xRTT, RC1, 1/8 Rate); Frequency: 820.5 MHz; Duty Cycle: 1:19.81

Medium: Air Medium parameters used: $\sigma = 0$ S/m, $\epsilon_r = 1$; $\rho = 1000$ kg/m³

Ambient Temperature : 21.6 °C

DASY5 Configuration:

- Probe: ER3DV6 - SN2445; ConvF(1, 1, 1); Calibrated: 2013/02/18;
- Sensor-Surface: (Fix Surface)
- Electronics: DAE4 Sn914; Calibrated: 2013/01/16
- Phantom: HAC Test Arch with AMCC; Type: SD HAC P01 BA;
- Measurement SW: DASY52, Version 52.8 (4); SEMCAD X Version 14.6.10 (7164)

- Hearing Aid Compatibility Test (101x101x1): Interpolated grid: dx=0.5000 mm, dy=0.5000 mm

Device Reference Point: 0, 0, -6.3 mm

Reference Value = 27.28 V/m; Power Drift = 0.09 dB

PMF = 2.911

E-field emissions = 80.55 V/m

Near-field category: M4 (AWF 0 dB)

Grid 1 M4 61.04 V/m	Grid 2 M4 70.52 V/m	Grid 3 M4 66.36 V/m
Grid 4 M4 66.93 V/m	Grid 5 M4 80.55 V/m	Grid 6 M4 76.84 V/m
Grid 7 M4 73.07 V/m	Grid 8 M4 72.86 V/m	Grid 9 M4 69.64 V/m

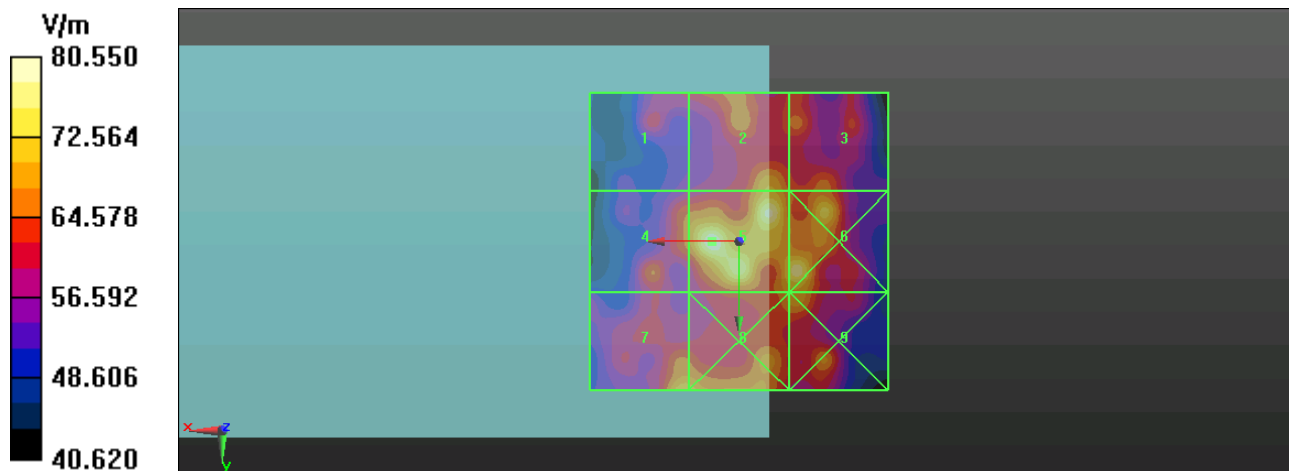

P04 H-Field_CDMA BC0_RC1+SO55_Ch384

DUT: 130716C14

Communication System: CDMA2000 (1xRTT, RC1, 1/8 Rate); Frequency: 836.52 MHz; Duty Cycle: 1:19.81
 Medium: Air Medium parameters used: $\sigma = 0$ S/m, $\epsilon_r = 1$; $\rho = 1$ kg/m³
 Ambient Temperature : 21.3 °C

DASY5 Configuration:

- Probe: H3DV6 - SN6274; ; Calibrated: 2013/02/15
- Sensor-Surface: (Fix Surface)
- Electronics: DAE3 Sn579; Calibrated: 2013/04/24
- Phantom: HAC Test Arch with AMCC; Type: SD HAC P01 BA;
- Measurement SW: DASY52, Version 52.8 (7); SEMCAD X Version 14.6.10 (7164)

- Hearing Aid Compatibility Test (101x101x1): Interpolated grid: dx=0.5000 mm, dy=0.5000 mm
 Device Reference Point: 0, 0, -6.3 mm
 Reference Value = 0.06800 A/m; Power Drift = -0.06 dB
 PMF = 2.911
 H-field emissions = 0.358 A/m
Near-field category: M4 (AWF 0 dB)

Grid 1 M4 0.358 A/m	Grid 2 M4 0.266 A/m	Grid 3 M4 0.180 A/m
Grid 4 M4 0.329 A/m	Grid 5 M4 0.245 A/m	Grid 6 M4 0.161 A/m
Grid 7 M4 0.357 A/m	Grid 8 M4 0.244 A/m	Grid 9 M4 0.150 A/m

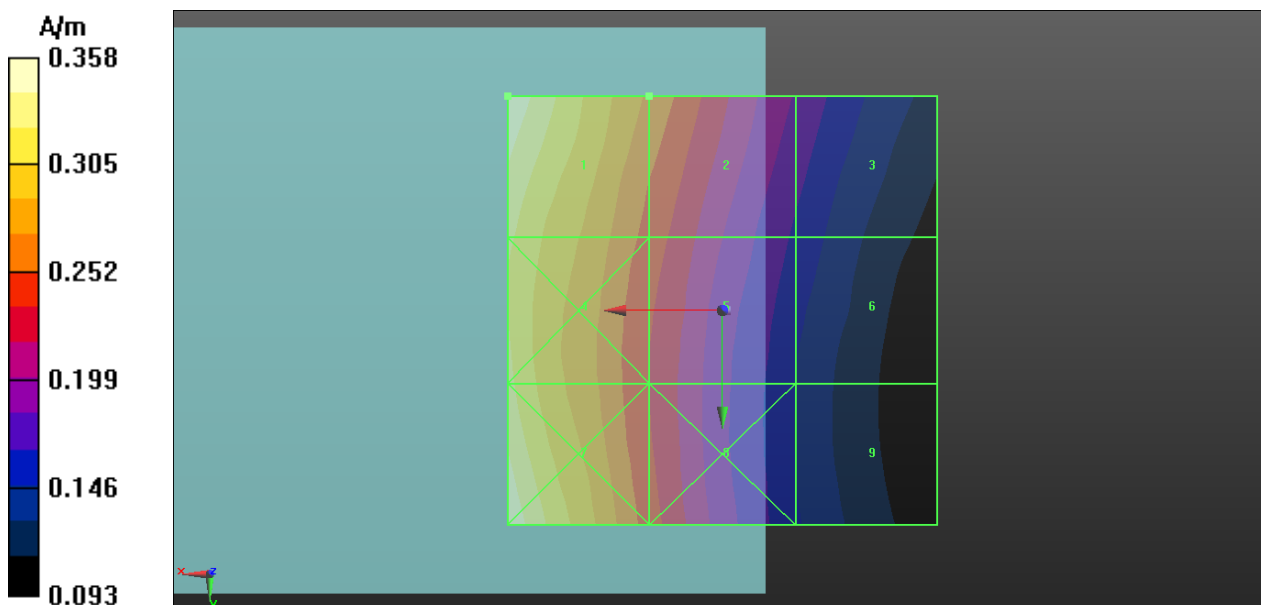

P05 H-Field_CDMA BC1_RC1+SO55_Ch25

DUT: 130716C14

Communication System: CDMA2000 (1xRTT, RC1, 1/8 Rate); Frequency: 1851.25 MHz; Duty Cycle: 1:19.81
 Medium: Air Medium parameters used: $\sigma = 0 \text{ S/m}$, $\epsilon_r = 1$; $\rho = 1 \text{ kg/m}^3$
 Ambient Temperature : 21.3 °C

DASY5 Configuration:

- Probe: H3DV6 - SN6274; ; Calibrated: 2013/02/15
- Sensor-Surface: (Fix Surface)
- Electronics: DAE3 Sn579; Calibrated: 2013/04/24
- Phantom: HAC Test Arch with AMCC; Type: SD HAC P01 BA;
- Measurement SW: DASY52, Version 52.8 (7); SEMCAD X Version 14.6.10 (7164)

- Hearing Aid Compatibility Test (101x101x1): Interpolated grid: dx=0.5000 mm, dy=0.5000 mm
 Device Reference Point: 0, 0, -6.3 mm
 Reference Value = 0.08700 A/m; Power Drift = 0.13 dB
 PMF = 2.911
 H-field emissions = 0.249 A/m
Near-field category: M3 (AWF 0 dB)

Grid 1 M3 0.273 A/m	Grid 2 M3 0.249 A/m	Grid 3 M3 0.235 A/m
Grid 4 M3 0.236 A/m	Grid 5 M3 0.242 A/m	Grid 6 M3 0.233 A/m
Grid 7 M3 0.252 A/m	Grid 8 M3 0.209 A/m	Grid 9 M4 0.183 A/m

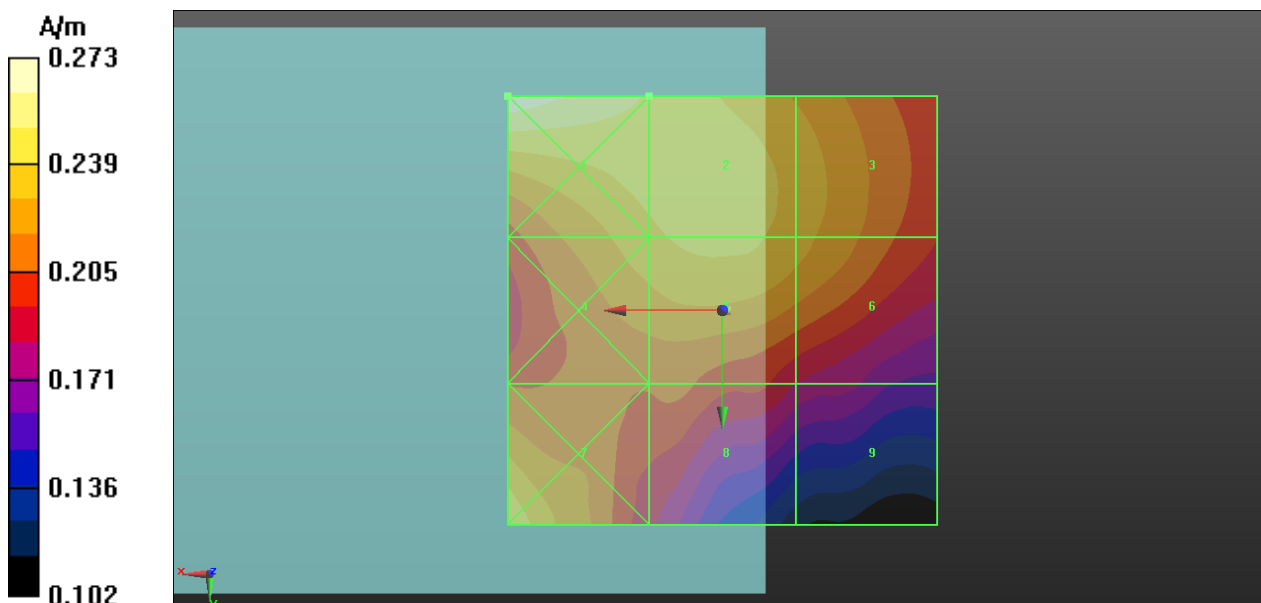

P06 H-Field_CDMA BC10_RC1+SO55_Ch580

DUT: 130716C14

Communication System: CDMA2000 (1xRTT, RC1, 1/8 Rate); Frequency: 820.5 MHz; Duty Cycle: 1:19.81
 Medium: Air Medium parameters used: $\sigma = 0 \text{ S/m}$, $\epsilon_r = 1$; $\rho = 1 \text{ kg/m}^3$
 Ambient Temperature : 21.3 °C

DASY5 Configuration:

- Probe: H3DV6 - SN6274; ; Calibrated: 2013/02/15
- Sensor-Surface: (Fix Surface)
- Electronics: DAE3 Sn579; Calibrated: 2013/04/24
- Phantom: HAC Test Arch with AMCC; Type: SD HAC P01 BA;
- Measurement SW: DASY52, Version 52.8 (7); SEMCAD X Version 14.6.10 (7164)

- Hearing Aid Compatibility Test (101x101x1): Interpolated grid: dx=0.5000 mm, dy=0.5000 mm
 Device Reference Point: 0, 0, -6.3 mm
 Reference Value = 0.06800 A/m; Power Drift = 0.15 dB
 PMF = 2.911
 H-field emissions = 0.366 A/m
Near-field category: M4 (AWF 0 dB)

Grid 1 M4 0.366 A/m	Grid 2 M4 0.264 A/m	Grid 3 M4 0.165 A/m
Grid 4 M4 0.341 A/m	Grid 5 M4 0.248 A/m	Grid 6 M4 0.154 A/m
Grid 7 M4 0.370 A/m	Grid 8 M4 0.261 A/m	Grid 9 M4 0.165 A/m

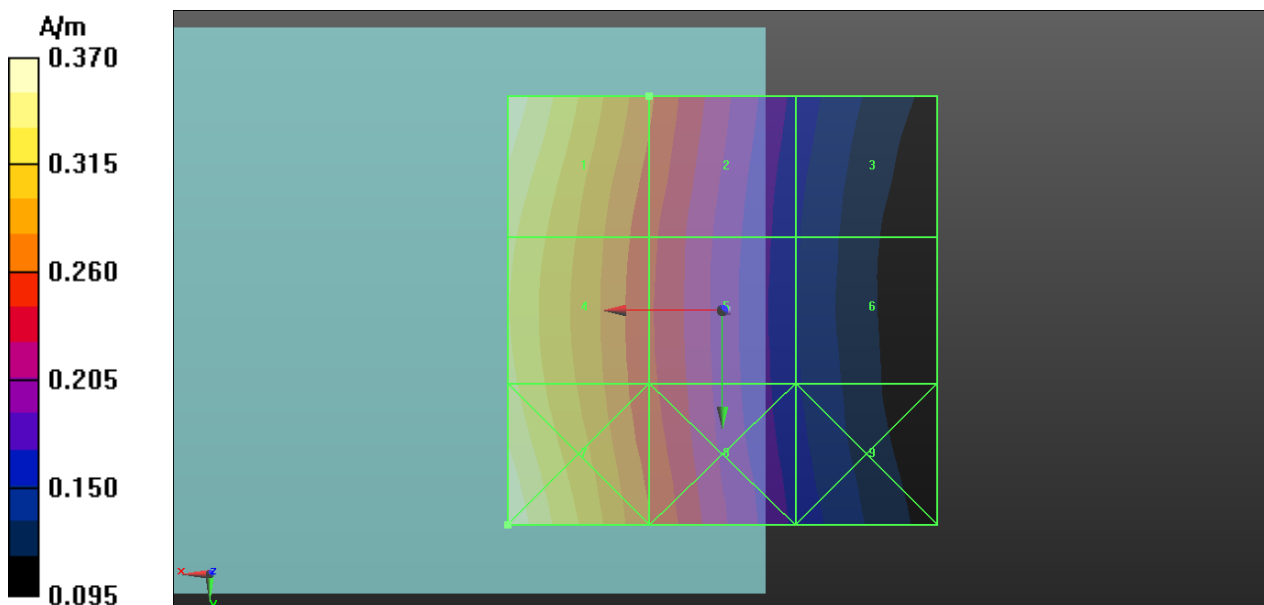



Appendix C. Calibration Certificate for Probe and Dipole

The SPEAG calibration certificates are shown as follows.



Accredited by the Swiss Accreditation Service (SAS)
The Swiss Accreditation Service is one of the signatories to the EA
Multilateral Agreement for the recognition of calibration certificates

Accreditation No.: **SCS 108**

Client **B.V. ADT (Auden)**

Certificate No: **CD835V3-1041_Mar13**

CALIBRATION CERTIFICATE

Object **CD835V3 - SN: 1041**

Calibration procedure(s) **QA CAL-20.v6
Calibration procedure for dipoles in air**

Calibration date: **March 15, 2013**

This calibration certificate documents the traceability to national standards, which realize the physical units of measurements (SI).
The measurements and the uncertainties with confidence probability are given on the following pages and are part of the certificate.

All calibrations have been conducted in the closed laboratory facility: environment temperature (22 ± 3)°C and humidity < 70%.

Calibration Equipment used (M&TE critical for calibration)

Primary Standards	ID #	Cal Date (Certificate No.)	Scheduled Calibration
Power meter EPM-442A	GB37480704	01-Nov-12 (No. 217-01640)	Oct-13
Power sensor HP 8481A	US37292783	01-Nov-12 (No. 217-01640)	Oct-13
Reference 10 dB Attenuator	SN: 5047.2 (10q)	27-Mar-12 (No. 217-01527)	Apr-13
Probe ER3DV6	SN: 2336	28-Dec-12 (No. ER3-2336_Dec12)	Dec-13
Probe H3DV6	SN: 6065	28-Dec-12 (No. H3-6065_Dec12)	Dec-13
DAE4	SN: 781	29-May-12 (No. DAE4-781_May12)	May-13

Secondary Standards	ID #	Check Date (in house)	Scheduled Check
Power meter Agilent 4419B	SN: GB42420191	09-Oct-09 (in house check Oct-12)	In house check: Oct-13
Power sensor HP E4412A	SN: MY41495277	01-Apr-08 (in house check Oct-12)	In house check: Oct-13
Power sensor HP 8482A	SN: US37295597	09-Oct-09 (in house check Oct-12)	In house check: Oct-13
Network Analyzer HP 8753E	US37390585	18-Oct-01 (in house check Oct-12)	In house check: Oct-13
RF generator R&S SMT-06	SN: 832283/011	27-Aug-12 (in house check Oct-12)	In house check: Oct-14

	Name	Function	Signature
Calibrated by:	Leif Klysner	Laboratory Technician	
Approved by:	Fin Bomholt	Deputy Technical Manager	

Issued: March 19, 2013

This calibration certificate shall not be reproduced except in full without written approval of the laboratory.



Accredited by the Swiss Accreditation Service (SAS)

The Swiss Accreditation Service is one of the signatories to the EA
Multilateral Agreement for the recognition of calibration certificates

Accreditation No.: **SCS 108**

References

- [1] ANSI-C63.19-2007
American National Standard for Methods of Measurement of Compatibility between Wireless Communications
Devices and Hearing Aids.

Methods Applied and Interpretation of Parameters:

- *Coordinate System:* y-axis is in the direction of the dipole arms. z-axis is from the basis of the antenna (mounted on the table) towards its feed point between the two dipole arms. x-axis is normal to the other axes. In coincidence with the standards [1], the measurement planes (probe sensor center) are selected to be at a distance of 10 mm above the top edge of the dipole arms.
- *Measurement Conditions:* Further details are available from the hardcopies at the end of the certificate. All figures stated in the certificate are valid at the frequency indicated. The forward power to the dipole connector is set with a calibrated power meter connected and monitored with an auxiliary power meter connected to a directional coupler. While the dipole under test is connected, the forward power is adjusted to the same level.
- *Antenna Positioning:* The dipole is mounted on a HAC Test Arch phantom using the matching dipole positioner with the arms horizontal and the feeding cable coming from the floor. The measurements are performed in a shielded room with absorbers around the setup to reduce the reflections. It is verified before the mounting of the dipole under the Test Arch phantom, that its arms are perfectly in a line. It is installed on the HAC dipole positioner with its arms parallel below the dielectric reference wire and able to move elastically in vertical direction without changing its relative position to the top center of the Test Arch phantom. The vertical distance to the probe is adjusted after dipole mounting with a DASY5 Surface Check job. Before the measurement, the distance between phantom surface and probe tip is verified. The proper measurement distance is selected by choosing the matching section of the HAC Test Arch phantom with the proper device reference point (upper surface of the dipole) and the matching grid reference point (tip of the probe) considering the probe sensor offset. The vertical distance to the probe is essential for the accuracy.
- *Feed Point Impedance and Return Loss:* These parameters are measured using a HP 8753E Vector Network Analyzer. The impedance is specified at the SMA connector of the dipole. The influence of reflections was eliminating by applying the averaging function while moving the dipole in the air, at least 70cm away from any obstacles.
- *E-field distribution:* E field is measured in the x-y-plane with an isotropic ER3D-field probe with 100 mW forward power to the antenna feed point. In accordance with [1], the scan area is 20mm wide, its length exceeds the dipole arm length (180 or 90mm). The sensor center is 10 mm (in z) above the top of the dipole arms. Two 3D maxima are available near the end of the dipole arms. Assuming the dipole arms are perfectly in one line, the average of these two maxima (in subgrid 2 and subgrid 8) is determined to compensate for any non-parallelity to the measurement plane as well as the sensor displacement. The E-field value stated as calibration value represents the maximum of the interpolated 3D-E-field, 10mm above the dipole surface.
- *H-field distribution:* H-field is measured with an isotropic H-field probe with 100mW forward power to the antenna feed point, in the x-y-plane. The scan area and sensor distance is equivalent to the E-field scan. The maximum of the field is available at the center (subgrid 5) above the feed point. The H-field value stated as calibration value represents the maximum of the interpolated H-field, 10mm above the dipole surface at the feed point.

The reported uncertainty of measurement is stated as the standard uncertainty of measurement multiplied by the coverage factor $k=2$, which for a normal distribution corresponds to a coverage probability of approximately 95%.

Measurement Conditions

DASY system configuration, as far as not given on page 1.

DASY Version	DASY5	V52.8.5
Extrapolation	Advanced Extrapolation	
Phantom	HAC Test Arch	
Distance Dipole Top - Probe Center	10mm	
Scan resolution	dx, dy = 5 mm	
Frequency	835 MHz \pm 1 MHz	
Input power drift	< 0.06 dB	

Maximum Field values at 835 MHz

H-field 10 mm above dipole surface	condition	interpolated maximum
Maximum measured	100 mW input power	0.466 A / m \pm 8.2 % (k=2)

E-field 10 mm above dipole surface	condition	Interpolated maximum
Maximum measured above high end	100 mW input power	167.1 V / m
Maximum measured above low end	100 mW input power	164.6 V / m
Averaged maximum above arm	100 mW input power	165.8 V / m \pm 12.8 % (k=2)

E-field 15 mm above dipole surface	condition	Interpolated maximum
Maximum measured above high end	100 mW input power	108.0 V / m
Maximum measured above low end	100 mW input power	107.9 V / m
Averaged maximum above arm	100 mW input power	108.0 V / m \pm 12.8 % (k=2)

Appendix

Antenna Parameters

Frequency	Return Loss	Impedance
800 MHz	16.3 dB	43.0 Ω - 12.5 j Ω
835 MHz	27.5 dB	47.6 Ω + 3.4 j Ω
900 MHz	18.0 dB	57.0 Ω - 11.7 j Ω
950 MHz	19.9 dB	47.7 Ω + 9.7 j Ω
960 MHz	14.6 dB	55.1 Ω + 19.2 j Ω

3.2 Antenna Design and Handling

The calibration dipole has a symmetric geometry with a built-in two stub matching network, which leads to the enhanced bandwidth.

The dipole is built of standard semirigid coaxial cable. The internal matching line is open ended. The antenna is therefore open for DC signals.

Do not apply force to dipole arms, as they are liable to bend. The soldered connections near the feedpoint may be damaged. After excessive mechanical stress or overheating, check the impedance characteristics to ensure that the internal matching network is not affected.

After long term use with 40W radiated power, only a slight warming of the dipole near the feedpoint can be measured.

Impedance Measurement Plot

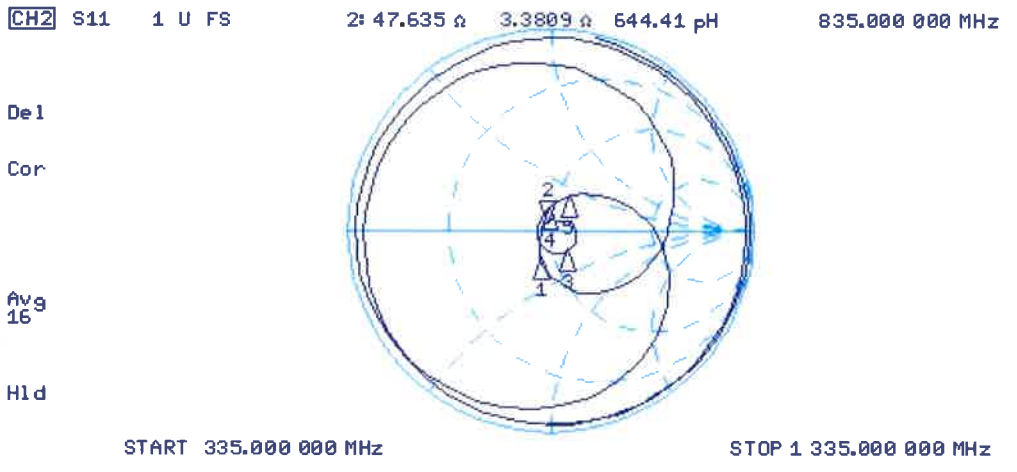
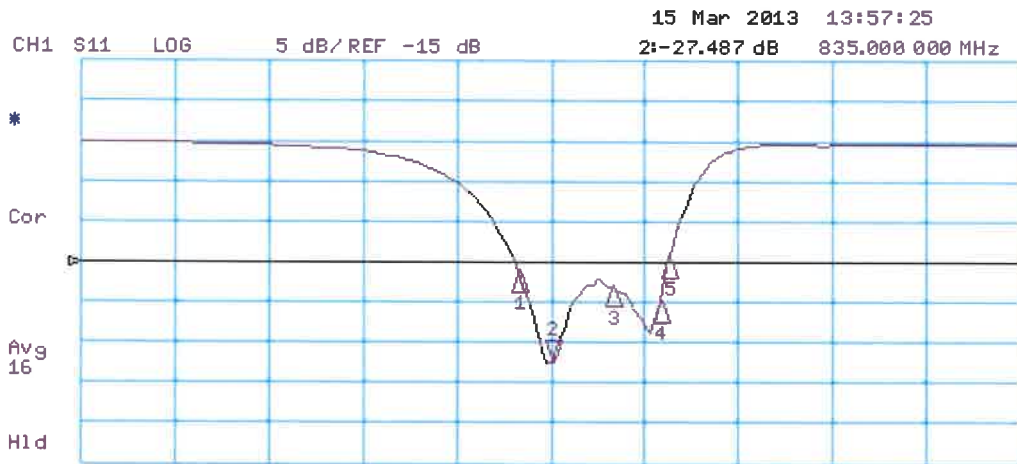

DASY5 H-field Result

Date: 15.03.2013

Test Laboratory: SPEAG Lab2

DUT: HAC-Dipole 835 MHz; Type: CD835V3; Serial: CD835V3 - SN: 1041

Communication System: CW; Frequency: 835 MHz
 Medium parameters used: $\sigma = 0$ S/m, $\epsilon_r = 1$; $\rho = 1$ kg/m³
 Phantom section: RF Section
 Measurement Standard: DASY5 (IEEE/IEC/ANSI C63.19-2007)

DASY52 Configuration:

- Probe: H3DV6 - SN6065; ; Calibrated: 28.12.2012
- Sensor-Surface: (Fix Surface)
- Electronics: DAE4 Sn781; Calibrated: 29.05.2012
- Phantom: HAC Test Arch with AMCC; Type: SD HAC P01 BA; Serial: 1070
- DASY52 52.8.5(1059); SEMCAD X 14.6.8(7028)

Dipole H-Field measurement @ 835MHz/H-Scan - 835MHz d=10mm/Hearing Aid Compatibility Test (41x361x1):

Interpolated grid: dx=0.5000 mm, dy=0.5000 mm

Device Reference Point: 0, 0, -6.3 mm

Reference Value = 0.4990 A/m; Power Drift = -0.05 dB

PMR not calibrated. PMF = 1.000 is applied.

H-field emissions = 0.4657 A/m

Near-field category: M4 (AWF 0 dB)

PMF scaled H-field

Grid 1 M4 0.382 A/m	Grid 2 M4 0.405 A/m	Grid 3 M4 0.383 A/m
Grid 4 M4 0.433 A/m	Grid 5 M4 0.466 A/m	Grid 6 M4 0.447 A/m
Grid 7 M4 0.376 A/m	Grid 8 M4 0.412 A/m	Grid 9 M4 0.399 A/m

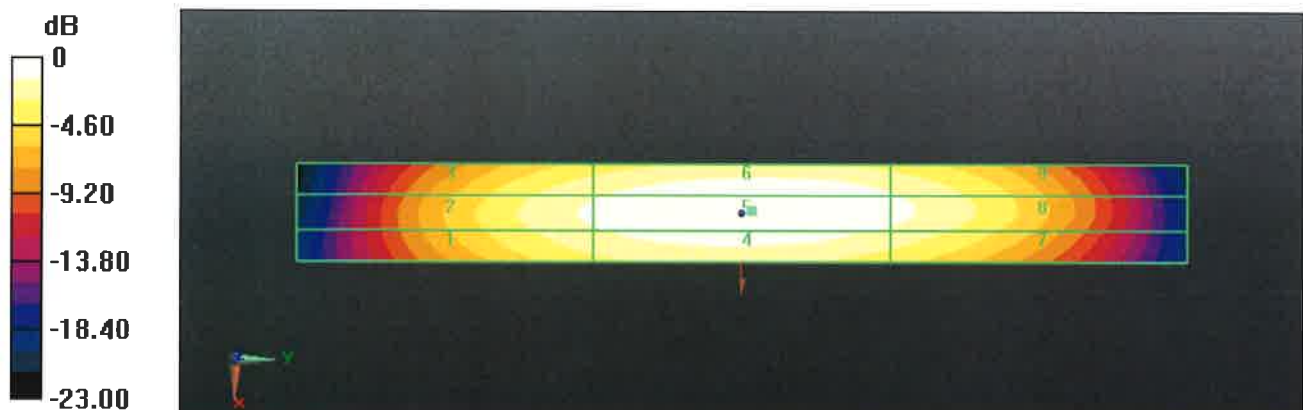

0 dB = 0.4657 A/m = -6.64 dBA/m

DASY5 E-field Result

Date: 15.03.2013

Test Laboratory: SPEAG Lab2

DUT: HAC-Dipole 835 MHz; Type: CD835V3; Serial: CD835V3 - SN: 1041

Communication System: CW; Frequency: 835 MHz

Medium parameters used: $\sigma = 0$ S/m, $\epsilon_r = 1$; $\rho = 1000$ kg/m³

Phantom section: RF Section

Measurement Standard: DASY5 (IEEE/IEC/ANSI C63.19-2007)

DASY52 Configuration:

- Probe: ER3DV6 - SN2336; ConvF(1, 1, 1); Calibrated: 28.12.2012;
- Sensor-Surface: (Fix Surface)
- Electronics: DAE4 Sn781; Calibrated: 29.05.2012
- Phantom: HAC Test Arch with AMCC; Type: SD HAC P01 BA; Serial: 1070
- DASY52 52.8.5(1059); SEMCAD X 14.6.8(7028)

Dipole E-Field measurement @ 835MHz/E-Scan - 835MHz d=10mm/Hearing Aid Compatibility Test (41x361x1):

Interpolated grid: dx=0.5000 mm, dy=0.5000 mm

Device Reference Point: 0, 0, -6.3 mm

Reference Value = 109.4 V/m; Power Drift = -0.01 dB

PMR not calibrated. PMF = 1.000 is applied.

E-field emissions = 167.1 V/m

Near-field category: M4 (AWF 0 dB)

PMF scaled E-field

Grid 1 M4 161.8 V/m	Grid 2 M4 164.6 V/m	Grid 3 M4 157.8 V/m
Grid 4 M4 89.77 V/m	Grid 5 M4 91.72 V/m	Grid 6 M4 88.33 V/m
Grid 7 M4 158.8 V/m	Grid 8 M4 167.1 V/m	Grid 9 M4 164.4 V/m

Dipole E-Field measurement @ 835MHz/E-Scan - 835MHz d=15mm/Hearing Aid Compatibility Test (41x361x1):
 Interpolated grid: dx=0.5000 mm, dy=0.5000 mm
 Device Reference Point: 0, 0, -6.3 mm
 Reference Value = 109.6 V/m; Power Drift = 0.00 dB
 PMR not calibrated. PMF = 1.000 is applied.
 E-field emissions = 108.0 V/m
Near-field category: M4 (AWF 0 dB)

PMF scaled E-field

Grid 1 M4 106.6 V/m	Grid 2 M4 107.9 V/m	Grid 3 M4 105.6 V/m
Grid 4 M4 65.13 V/m	Grid 5 M4 65.52 V/m	Grid 6 M4 64.28 V/m
Grid 7 M4 105.5 V/m	Grid 8 M4 108.0 V/m	Grid 9 M4 106.6 V/m

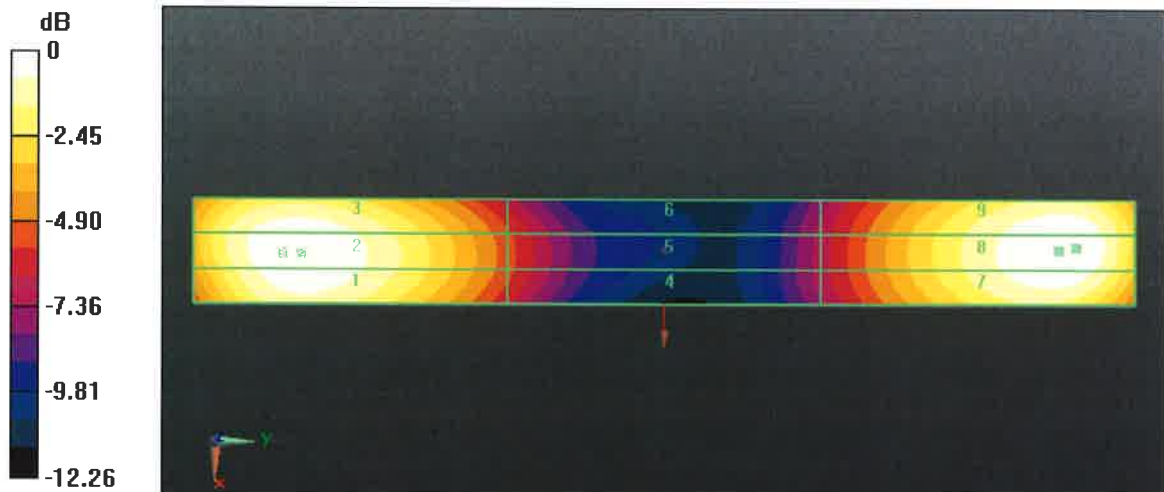

0 dB = 167.1 V/m = 44.46 dBV/m



Accredited by the Swiss Accreditation Service (SAS)

Accreditation No.: **SCS 108**

The Swiss Accreditation Service is one of the signatories to the EA
Multilateral Agreement for the recognition of calibration certificates

Client **B.V. ADT (Auden)**

Certificate No: **CD1880V3-1032_Apr13**

CALIBRATION CERTIFICATE

Object **CD1880V3 - SN: 1032**

Calibration procedure(s) **QA CAL-20.v6
Calibration procedure for dipoles in air**

Calibration date: **April 23, 2013**

This calibration certificate documents the traceability to national standards, which realize the physical units of measurements (SI).
The measurements and the uncertainties with confidence probability are given on the following pages and are part of the certificate.

All calibrations have been conducted in the closed laboratory facility: environment temperature (22 ± 3)°C and humidity < 70%.

Calibration Equipment used (M&TE critical for calibration)

Primary Standards	ID #	Cal Date (Certificate No.)	Scheduled Calibration
Power meter EPM-442A	GB37480704	01-Nov-12 (No. 217-01640)	Oct-13
Power sensor HP 8481A	US37292783	01-Nov-12 (No. 217-01640)	Oct-13
Reference 10 dB Attenuator	SN: 5047.2 (10q)	04-Apr-13 (No. 217-01731)	Apr-14
Probe ER3DV6	SN: 2336	28-Dec-12 (No. ER3-2336_Dec12)	Dec-13
Probe H3DV6	SN: 6065	28-Dec-12 (No. H3-6065_Dec12)	Dec-13
DAE4	SN: 781	29-May-12 (No. DAE4-781_May12)	May-13

Secondary Standards	ID #	Check Date (in house)	Scheduled Check
Power meter Agilent 4419B	SN: GB42420191	09-Oct-09 (in house check Oct-12)	In house check: Oct-13
Power sensor HP E4412A	SN: MY41495277	01-Apr-08 (in house check Oct-12)	In house check: Oct-13
Power sensor HP 8482A	SN: US37295597	09-Oct-09 (in house check Oct-12)	In house check: Oct-13
Network Analyzer HP 8753E	US37390585	18-Oct-01 (in house check Oct-12)	In house check: Oct-13
RF generator R&S SMT-06	SN: 832283/011	27-Aug-12 (in house check Oct-12)	In house check: Oct-14

	Name	Function	Signature
Calibrated by:	Dimce Iliev	Laboratory Technician	
Approved by:	Fin Bomholt	Deputy Technical Manager	

Issued: April 23, 2013

This calibration certificate shall not be reproduced except in full without written approval of the laboratory.



Accredited by the Swiss Accreditation Service (SAS)

The Swiss Accreditation Service is one of the signatories to the EA
Multilateral Agreement for the recognition of calibration certificates

Accreditation No.: **SCS 108**

References

- [1] ANSI-C63.19-2007
American National Standard for Methods of Measurement of Compatibility between Wireless Communications Devices and Hearing Aids.
- [2] ANSI-C63.19-2011
American National Standard, Methods of Measurement of Compatibility between Wireless Communications Devices and Hearing Aids.

Methods Applied and Interpretation of Parameters:

- *Coordinate System:* y-axis is in the direction of the dipole arms. z-axis is from the basis of the antenna (mounted on the table) towards its feed point between the two dipole arms. x-axis is normal to the other axes. In coincidence with the standards [1], the measurement planes (probe sensor center) are selected to be at a distance of 10 mm (15 mm for [2]) above the top metal edge of the dipole arms.
- *Measurement Conditions:* Further details are available from the hardcopies at the end of the certificate. All figures stated in the certificate are valid at the frequency indicated. The forward power to the dipole connector is set with a calibrated power meter connected and monitored with an auxiliary power meter connected to a directional coupler. While the dipole under test is connected, the forward power is adjusted to the same level.
- *Antenna Positioning:* The dipole is mounted on a HAC Test Arch phantom using the matching dipole positioner with the arms horizontal and the feeding cable coming from the floor. The measurements are performed in a shielded room with absorbers around the setup to reduce the reflections. It is verified before the mounting of the dipole under the Test Arch phantom, that its arms are perfectly in a line. It is installed on the HAC dipole positioner with its arms parallel below the dielectric reference wire and able to move elastically in vertical direction without changing its relative position to the top center of the Test Arch phantom. The vertical distance to the probe is adjusted after dipole mounting with a DASY5 Surface Check job. Before the measurement, the distance between phantom surface and probe tip is verified. The proper measurement distance is selected by choosing the matching section of the HAC Test Arch phantom with the proper device reference point (upper surface of the dipole) and the matching grid reference point (tip of the probe) considering the probe sensor offset. The vertical distance to the probe is essential for the accuracy.
- *Feed Point Impedance and Return Loss:* These parameters are measured using a HP 8753E Vector Network Analyzer. The impedance is specified at the SMA connector of the dipole. The influence of reflections was eliminated by applying the averaging function while moving the dipole in the air, at least 70cm away from any obstacles.
- *E-field distribution:* E field is measured in the x-y-plane with an isotropic ER3D-field probe with 100 mW forward power to the antenna feed point. In accordance with [1] and [2], the scan area is 20mm wide, its length exceeds the dipole arm length (180 or 90mm). The sensor center is 10 mm (15 mm for [2]) (in z) above the metal top of the dipole arms. Two 3D maxima are available near the end of the dipole arms. Assuming the dipole arms are perfectly in one line, the average of these two maxima (in subgrid 2 and subgrid 8) is determined to compensate for any non-parallelity to the measurement plane as well as the sensor displacement. The E-field value stated as calibration value represents the maximum of the interpolated 3D-E-field, in the plane above the dipole surface.
- *H-field distribution:* H-field is measured with an isotropic H-field probe with 100mW forward power to the antenna feed point, in the x-y-plane. The scan area and sensor distance is equivalent to the E-field scan. The maximum of the field is available at the center (subgrid 5) above the feed point. The H-field value stated as calibration value represents the maximum of the interpolated H-field, 10mm above the dipole surface at the feed point.

The reported uncertainty of measurement is stated as the standard uncertainty of measurement multiplied by the coverage factor $k=2$, which for a normal distribution corresponds to a coverage probability of approximately 95%.

Measurement Conditions

DASY system configuration, as far as not given on page 1.

DASY Version	DASY5	V52.8.6
Extrapolation	Advanced Extrapolation	
Phantom	HAC Test Arch	
Distance Dipole Top - Probe Center	10mm 15mm	
Scan resolution	dx, dy = 5 mm	
Frequency	1880 MHz \pm 1 MHz	
Input power drift	< 0.05 dB	

Maximum Field values at 1880 MHz

H-field 10 mm above dipole surface	condition	interpolated maximum
Maximum measured	100 mW input power	0.464 A / m \pm 8.2 % (k=2)

E-field 10 mm above dipole surface	condition	Interpolated maximum
Maximum measured above high end	100 mW input power	143.0 V / m
Maximum measured above low end	100 mW input power	140.3 V / m
Averaged maximum above arm	100 mW input power	141.7 V / m \pm 12.8 % (k=2)

E-field 15 mm above dipole surface	condition	Interpolated maximum
Maximum measured above high end	100 mW input power	92.7 V / m
Maximum measured above low end	100 mW input power	90.1 V / m
Averaged maximum above arm	100 mW input power	91.4 V / m \pm 12.8 % (k=2)

Appendix

Antenna Parameters

Frequency	Return Loss	Impedance
1730 MHz	25.0 dB	50.6 Ω + 5.6 j Ω
1880 MHz	19.9 dB	51.1 Ω + 10.2 j Ω
1900 MHz	20.3 dB	54.7 Ω + 9.0 j Ω
1950 MHz	26.5 dB	54.8 Ω + 1.1 j Ω
2000 MHz	22.2 dB	43.1 Ω + 2.0 j Ω

3.2 Antenna Design and Handling

The calibration dipole has a symmetric geometry with a built-in two stub matching network, which leads to the enhanced bandwidth.

The dipole is built of standard semirigid coaxial cable. The internal matching line is open ended. The antenna is therefore open for DC signals.

Do not apply force to dipole arms, as they are liable to bend. The soldered connections near the feedpoint may be damaged. After excessive mechanical stress or overheating, check the impedance characteristics to ensure that the internal matching network is not affected.

After long term use with 40W radiated power, only a slight warming of the dipole near the feedpoint can be measured.

Impedance Measurement Plot

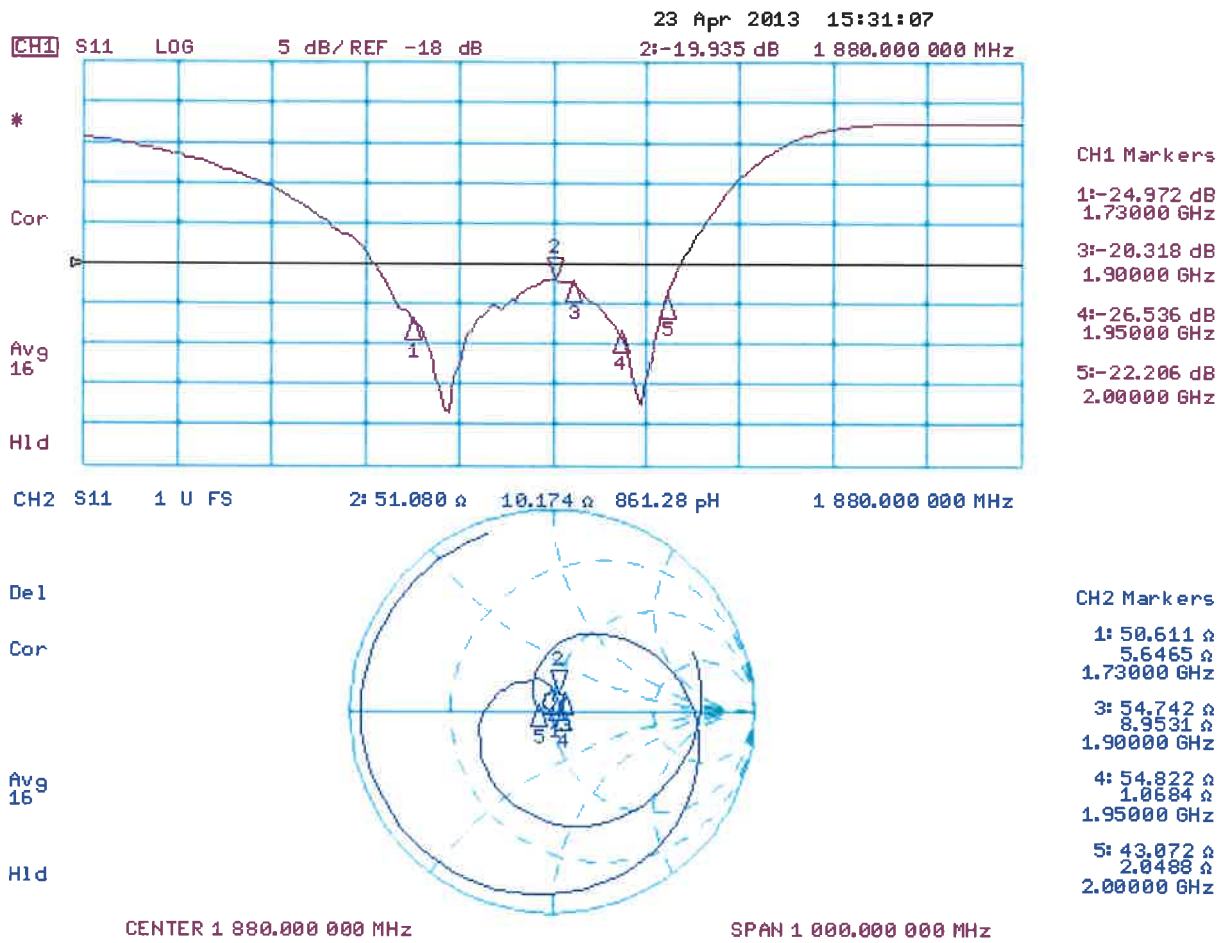

DASY5 H-field Result

Date: 23.04.2013

Test Laboratory: SPEAG Lab2

DUT: HAC Dipole 1880 MHz; Type: CD1880V3; Serial: CD1880V3 - SN: 1032

Communication System: UID 0 - CW; Frequency: 1880 MHz

Medium parameters used: $\sigma = 0$ S/m, $\epsilon_r = 1$; $\rho = 1$ kg/m³

Phantom section: RF Section

Measurement Standard: DASY5 (IEEE/IEC/ANSI C63.19-2007)

DASY52 Configuration:

- Probe: H3DV6 - SN6065; ; Calibrated: 28.12.2012
- Sensor-Surface: (Fix Surface)
- Electronics: DAE4 Sn781; Calibrated: 29.05.2012
- Phantom: HAC Test Arch with AMCC; Type: SD HAC P01 BA; Serial: 1070
- DASY52 52.8.6(1115); SEMCAD X 14.6.9(7117)

Dipole H-Field measurement @ 1880MHz/H-Scan - 1880MHz d=10mm/Hearing Aid Compatibility Test (41x181x1): Interpolated grid: dx=0.5000 mm, dy=0.5000 mm

Device Reference Point: 0, 0, -6.3 mm

Reference Value = 0.4920 A/m; Power Drift = -0.01 dB

PMR not calibrated. PMF = 1.000 is applied.

H-field emissions = 0.4642 A/m

Near-field category: M2 (AWF 0 dB)

PMF scaled H-field

Grid 1 M2 0.399 A/m	Grid 2 M2 0.420 A/m	Grid 3 M2 0.405 A/m
Grid 4 M2 0.437 A/m	Grid 5 M2 0.464 A/m	Grid 6 M2 0.449 A/m
Grid 7 M2 0.402 A/m	Grid 8 M2 0.432 A/m	Grid 9 M2 0.418 A/m

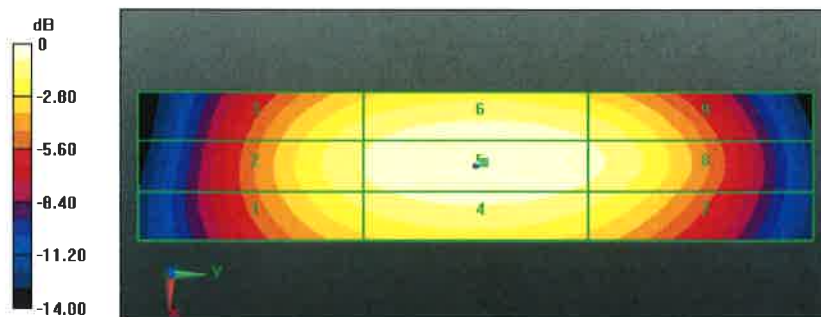

0 dB = 0.4642 A/m = -6.67 dBA/m

DASY5 E-field Result

Date: 23.04.2013

Test Laboratory: SPEAG Lab2

DUT: HAC Dipole 1880 MHz; Type: CD1880V3; Serial: CD1880V3 - SN: 1032

Communication System: UID 0 - CW; Frequency: 1880 MHz

Medium parameters used: $\sigma = 0$ S/m, $\epsilon_r = 1$; $\rho = 1000$ kg/m³

Phantom section: RF Section

Measurement Standard: DASY5 (IEEE/IEC/ANSI C63.19-2007)

DASY52 Configuration:

- Probe: ER3DV6 - SN2336; ConvF(1, 1, 1); Calibrated: 28.12.2012;
- Sensor-Surface: (Fix Surface)
- Electronics: DAE4 Sn781; Calibrated: 29.05.2012
- Phantom: HAC Test Arch with AMCC; Type: SD HAC P01 BA; Serial: 1070
- DASY52 52.8.6(1115); SEMCAD X 14.6.9(7117)

Dipole E-Field measurement @ 1880MHz/E-Scan - 1880MHz d=10mm/Hearing Aid Compatibility Test

(41x181x1): Interpolated grid: dx=0.5000 mm, dy=0.5000 mm

Device Reference Point: 0, 0, -6.3 mm

Reference Value = 161.6 V/m; Power Drift = -0.00 dB

PMR not calibrated. PMF = 1.000 is applied.

E-field emissions = 143.0 V/m

Near-field category: M2 (AWF 0 dB)

PMF scaled E-field

Grid 1 M2 135.7 V/m	Grid 2 M2 140.3 V/m	Grid 3 M2 137.0 V/m
Grid 4 M3 92.35 V/m	Grid 5 M3 94.76 V/m	Grid 6 M3 91.05 V/m
Grid 7 M2 133.2 V/m	Grid 8 M2 143.0 V/m	Grid 9 M2 141.5 V/m

Dipole E-Field measurement @ 1880MHz/E-Scan - 1880MHz d=15mm/Hearing Aid Compatibility Test (41x181x1): Interpolated grid: dx=0.5000 mm, dy=0.5000 mm
 Device Reference Point: 0, 0, -6.3 mm
 Reference Value = 160.9 V/m; Power Drift = 0.01 dB
 PMR not calibrated. PMF = 1.000 is applied.
 E-field emissions = 92.74 V/m
Near-field category: M3 (AWF 0 dB)

PMF scaled E-field

Grid 1 M3 90.77 V/m	Grid 2 M3 92.74 V/m	Grid 3 M3 91.42 V/m
Grid 4 M3 72.21 V/m	Grid 5 M3 73.10 V/m	Grid 6 M3 72.02 V/m
Grid 7 M3 87.31 V/m	Grid 8 M3 90.11 V/m	Grid 9 M3 89.51 V/m

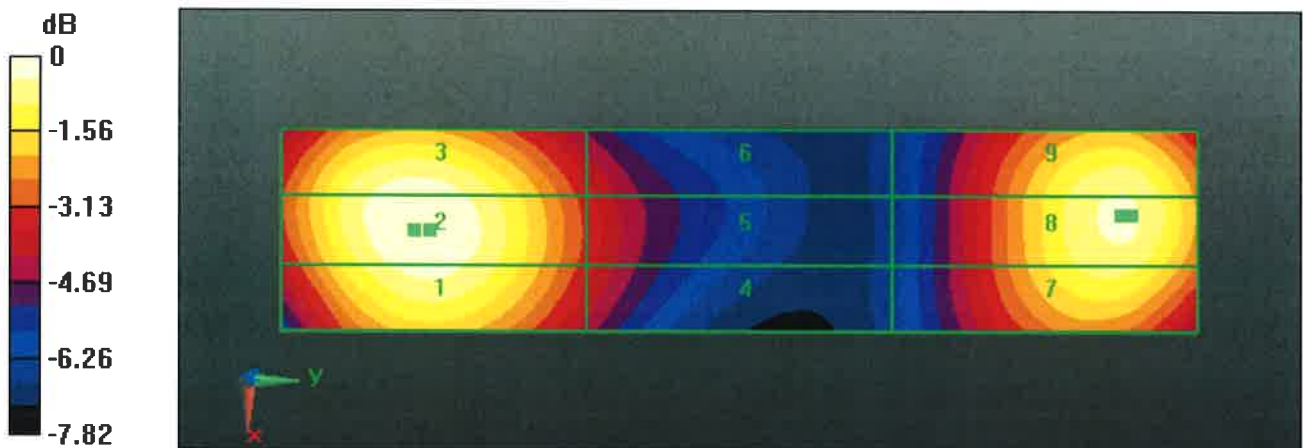

0 dB = 143.0 V/m = 43.11 dBV/m



Accredited by the Swiss Accreditation Service (SAS)
The Swiss Accreditation Service is one of the signatories to the EA
Multilateral Agreement for the recognition of calibration certificates

Accreditation No.: **SCS 108**

Client **B.V.ADT (Auden)**

Certificate No: **ER3-2445_Feb13**

CALIBRATION CERTIFICATE

Object **ER3DV6 - SN:2445**

Calibration procedure(s) **QA CAL-02.v6, QA CAL-25.v4
Calibration procedure for E-field probes optimized for close near field
evaluations in air**

Calibration date: **February 18, 2013**

This calibration certificate documents the traceability to national standards, which realize the physical units of measurements (SI).
The measurements and the uncertainties with confidence probability are given on the following pages and are part of the certificate.

All calibrations have been conducted in the closed laboratory facility: environment temperature (22 ± 3)°C and humidity < 70%.

Calibration Equipment used (M&TE critical for calibration)

Primary Standards	ID	Cal Date (Certificate No.)	Scheduled Calibration
Power meter E4419B	GB41293874	29-Mar-12 (No. 217-01508)	Apr-13
Power sensor E4412A	MY41498087	29-Mar-12 (No. 217-01508)	Apr-13
Reference 3 dB Attenuator	SN: S5054 (3c)	27-Mar-12 (No. 217-01531)	Apr-13
Reference 20 dB Attenuator	SN: S5086 (20b)	27-Mar-12 (No. 217-01529)	Apr-13
Reference 30 dB Attenuator	SN: S5129 (30b)	27-Mar-12 (No. 217-01532)	Apr-13
Reference Probe ER3DV6	SN: 2328	12-Oct-12 (No. ER3-2328_Oct12)	Oct-13
DAE4	SN: 789	18-Sep-12 (No. DAE4-789_Sep12)	Sep-13
Secondary Standards	ID	Check Date (in house)	Scheduled Check
RF generator HP 8648C	US3642U01700	4-Aug-99 (in house check Apr-11)	In house check: Apr-13
Network Analyzer HP 8753E	US37390585	18-Oct-01 (in house check Oct-12)	In house check: Oct-13

	Name	Function	Signature
Calibrated by:	Jeton Kastrati	Laboratory Technician	
Approved by:	Katja Pokovic	Technical Manager	

Issued: February 20, 2013

This calibration certificate shall not be reproduced except in full without written approval of the laboratory.



Accredited by the Swiss Accreditation Service (SAS)

Accreditation No.: **SCS 108**

The Swiss Accreditation Service is one of the signatories to the EA
Multilateral Agreement for the recognition of calibration certificates

Glossary:

NORM _{x,y,z}	sensitivity in free space
DCP	diode compression point
CF	crest factor (1/duty_cycle) of the RF signal
A, B, C, D	modulation dependent linearization parameters
Polarization ϕ	ϕ rotation around probe axis
Polarization ϑ	ϑ rotation around an axis that is in the plane normal to probe axis (at measurement center), i.e., $\vartheta = 0$ is normal to probe axis
Connector Angle	information used in DASY system to align probe sensor X to the robot coordinate system

Calibration is Performed According to the Following Standards:

- a) IEEE Std 1309-2005, " IEEE Standard for calibration of electromagnetic field sensors and probes, excluding antennas, from 9 kHz to 40 GHz", December 2005
- b) CTIA Test Plan for Hearing Aid Compatibility, April 2010.

Methods Applied and Interpretation of Parameters:

- *NORM_{x,y,z}*: Assessed for E-field polarization $\vartheta = 0$ for XY sensors and $\vartheta = 90$ for Z sensor ($f \leq 900$ MHz in TEM-cell; $f > 1800$ MHz: R22 waveguide).
- *NORM(f)_{x,y,z}* = *NORM_{x,y,z}* * *frequency_response* (see Frequency Response Chart).
- *DCP_{x,y,z}*: DCP are numerical linearization parameters assessed based on the data of power sweep with CW signal (no uncertainty required). DCP does not depend on frequency nor media.
- *PAR*: PAR is the Peak to Average Ratio that is not calibrated but determined based on the signal characteristics
- *A_{x,y,z}; B_{x,y,z}; C_{x,y,z}; D_{x,y,z}; VR_{x,y,z}*; *A, B, C, D* are numerical linearization parameters assessed based on the data of power sweep for specific modulation signal. The parameters do not depend on frequency nor media. *VR* is the maximum calibration range expressed in RMS voltage across the diode.
- *Spherical isotropy (3D deviation from isotropy)*: in a locally homogeneous field realized using an open waveguide setup.
- *Sensor Offset*: The sensor offset corresponds to the offset of virtual measurement center from the probe tip (on probe axis). No tolerance required.
- *Connector Angle*: The angle is assessed using the information gained by determining the *NORM_x* (no uncertainty required).

Probe ER3DV6

SN:2445

Manufactured: January 22, 2008
Calibrated: February 18, 2013

Calibrated for DASY/EASY Systems
(Note: non-compatible with DASY2 system!)

DASY/EASY - Parameters of Probe: ER3DV6 - SN:2445

Basic Calibration Parameters

	Sensor X	Sensor Y	Sensor Z	Unc (k=2)
Norm ($\mu\text{V}/(\text{V}/\text{m})^2$)	1.48	1.70	1.83	$\pm 10.1\%$
DCP (mV) ^B	97.7	99.7	101.0	

Modulation Calibration Parameters

UID	Communication System Name		A dB	B dB $\sqrt{\mu\text{V}}$	C	D dB	VR mV	Unc ^E (k=2)
0	CW	X	0.0	0.0	1.0	0.00	203.1	$\pm 3.3\%$
		Y	0.0	0.0	1.0		157.3	
		Z	0.0	0.0	1.0		204.2	
10011	UMTS-FDD (WCDMA)	X	3.15	65.9	18.2	2.91	121.0	$\pm 0.7\%$
		Y	3.28	67.1	19.1		126.3	
		Z	3.17	66.3	18.3		118.8	
10012	IEEE 802.11b WiFi 2.4 GHz (DSSS, 1 Mbps)	X	2.64	66.4	17.8	1.87	124.0	$\pm 0.7\%$
		Y	3.15	70.6	20.3		128.8	
		Z	2.95	68.6	18.8		121.7	
10021	GSM-FDD (TDMA, GMSK)	X	20.01	99.7	29.1	9.39	131.8	$\pm 1.4\%$
		Y	18.28	99.1	28.6		129.3	
		Z	24.77	99.7	28.8		98.6	
10039	CDMA2000 (1xRTT, RC1)	X	4.75	66.2	19.0	4.57	121.0	$\pm 0.9\%$
		Y	4.85	67.0	19.5		125.0	
		Z	4.66	66.2	18.9		119.2	
10081	CDMA2000 (1xRTT, RC3)	X	3.90	65.6	18.6	3.97	118.3	$\pm 0.7\%$
		Y	3.95	66.2	19.0		122.8	
		Z	3.84	65.6	18.5		117.4	
10148	LTE-FDD (SC-FDMA, 50% RB, 20 MHz, QPSK)	X	6.58	67.8	20.4	5.84	133.7	$\pm 1.9\%$
		Y	6.72	68.6	20.9		138.8	
		Z	6.48	67.6	20.1		132.4	
10154	LTE-FDD (SC-FDMA, 50% RB, 10 MHz, QPSK)	X	6.22	67.3	20.2	5.76	130.2	$\pm 1.9\%$
		Y	6.27	67.8	20.5		134.9	
		Z	6.05	66.9	19.7		128.4	
10156	LTE-FDD (SC-FDMA, 50% RB, 5 MHz, QPSK)	X	6.03	67.1	20.2	5.79	127.3	$\pm 1.9\%$
		Y	6.07	67.5	20.4		132.1	
		Z	5.82	66.5	19.6		125.0	
10160	LTE-FDD (SC-FDMA, 50% RB, 15 MHz, QPSK)	X	6.65	67.9	20.4	5.82	135.8	$\pm 2.2\%$
		Y	6.79	68.6	20.9		141.7	
		Z	6.49	67.4	20.0		132.9	
10163	LTE-FDD (SC-FDMA, 50% RB, 3 MHz, QPSK)	X	5.86	67.0	20.0	5.68	126.6	$\pm 1.9\%$
		Y	5.91	67.4	20.3		131.6	
		Z	5.66	66.4	19.5		123.0	
10166	LTE-FDD (SC-FDMA, 50% RB, 1.4 MHz, QPSK)	X	5.19	66.3	19.6	5.46	120.5	$\pm 1.4\%$
		Y	5.22	66.8	20.0		124.4	
		Z	5.05	65.9	19.2		117.6	

10169	LTE-FDD (SC-FDMA, 1 RB, 20 MHz, QPSK)	X	5.12	66.5	19.9	5.73	115.9	±1.4 %
		Y	5.15	67.0	20.3		119.8	
		Z	5.04	66.2	19.5		113.8	
10175	LTE-FDD (SC-FDMA, 1 RB, 10 MHz, QPSK)	X	5.12	66.5	19.8	5.73	115.6	±1.4 %
		Y	5.16	67.1	20.3		119.8	
		Z	5.01	66.0	19.3		117.0	
10177	LTE-FDD (SC-FDMA, 1 RB, 5 MHz, QPSK)	X	5.09	66.3	19.8	5.73	115.9	±1.4 %
		Y	5.18	67.2	20.4		119.9	
		Z	5.02	66.0	19.4		117.6	
10181	LTE-FDD (SC-FDMA, 1 RB, 15 MHz, QPSK)	X	5.14	66.6	19.9	5.73	115.6	±1.7 %
		Y	5.18	67.2	20.4		119.7	
		Z	5.02	66.0	19.4		117.8	
10184	LTE-FDD (SC-FDMA, 1 RB, 3 MHz, QPSK)	X	5.15	66.6	19.9	5.73	115.9	±1.7 %
		Y	5.16	67.0	20.3		119.9	
		Z	5.06	66.2	19.4		118.1	
10187	LTE-FDD (SC-FDMA, 1 RB, 1.4 MHz, QPSK)	X	5.14	66.6	19.9	5.73	116.3	±1.7 %
		Y	5.18	67.1	20.3		120.2	
		Z	5.03	66.1	19.4		118.4	
10276	CDMA2000 (1xRTT, RC1, 1/8 Rate)	X	8.87	75.7	29.1	12.97	53.6	±3.3 %
		Y	9.43	78.3	30.7		55.3	
		Z	8.67	73.7	27.2		55.9	

The reported uncertainty of measurement is stated as the standard uncertainty of measurement multiplied by the coverage factor $k=2$, which for a normal distribution corresponds to a coverage probability of approximately 95%.

^B Numerical linearization parameter: uncertainty not required.

^E Uncertainty is determined using the max. deviation from linear response applying rectangular distribution and is expressed for the square of the field value.

Frequency Response of E-Field (TEM-Cell:ifi110 EXX, Waveguide: R22)

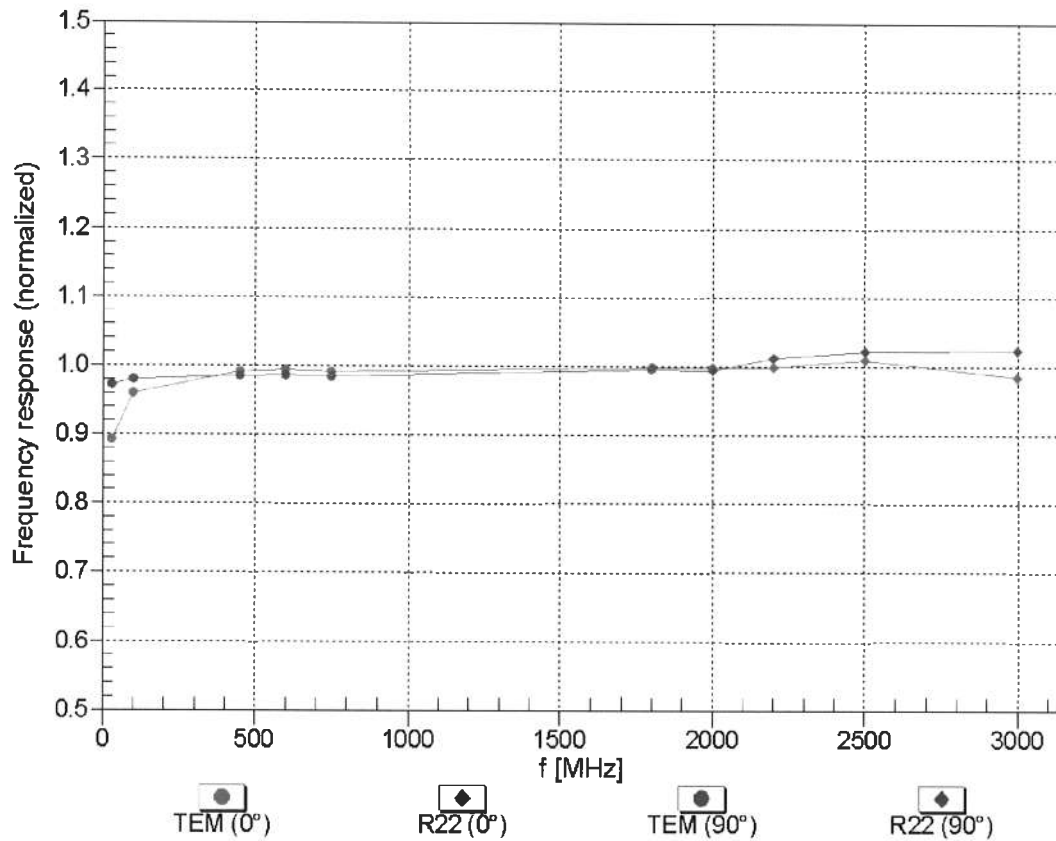

Uncertainty of Frequency Response of E-field: ± 6.3% (k=2)

Receiving Pattern (ϕ), $\vartheta = 0^\circ$

f=600 MHz,TEM,0°

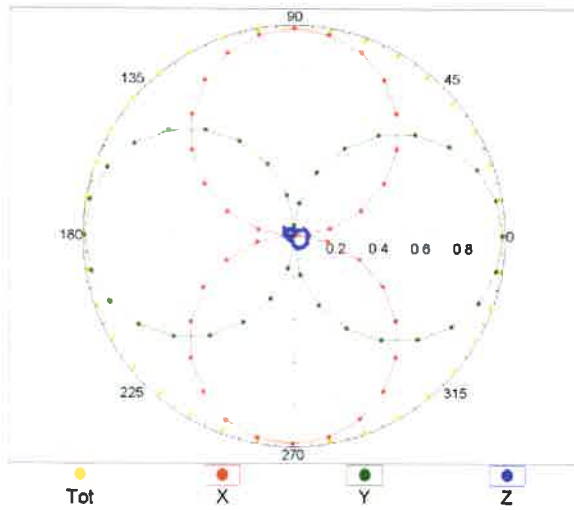

f=2500 MHz,R22,0°

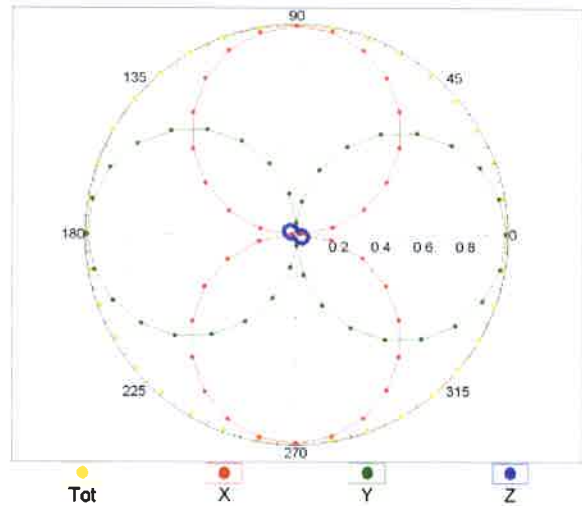

Receiving Pattern (ϕ), $\vartheta = 90^\circ$

f=600 MHz,TEM,90°

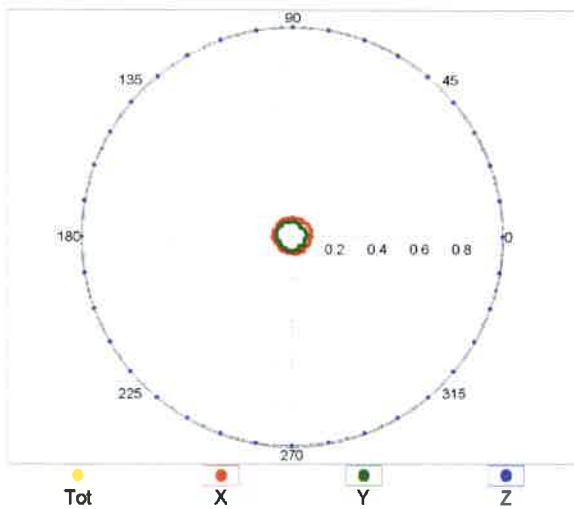

f=2500 MHz,R22,90°

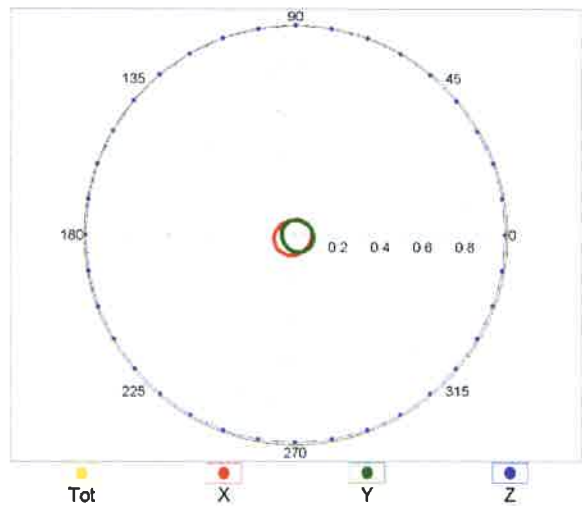

Receiving Pattern (ϕ), $\vartheta = 0^\circ$

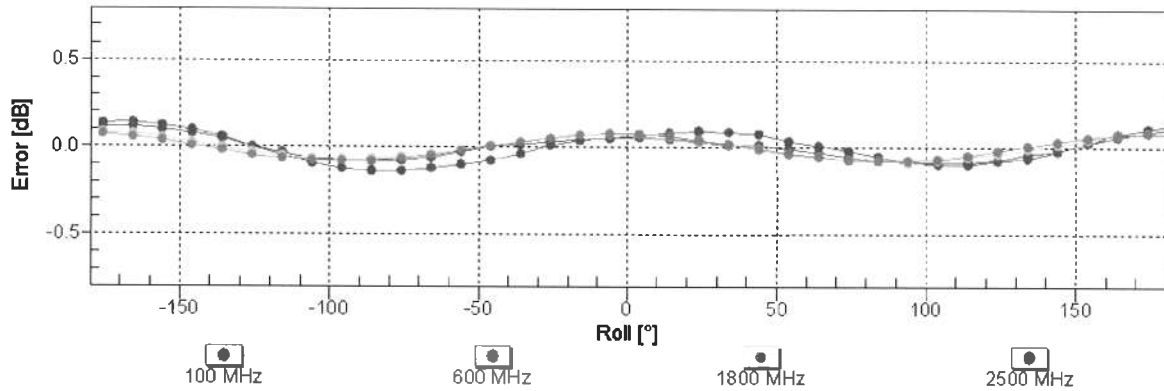

Uncertainty of Axial Isotropy Assessment: $\pm 0.5\%$ ($k=2$)

Receiving Pattern (ϕ), $\vartheta = 90^\circ$

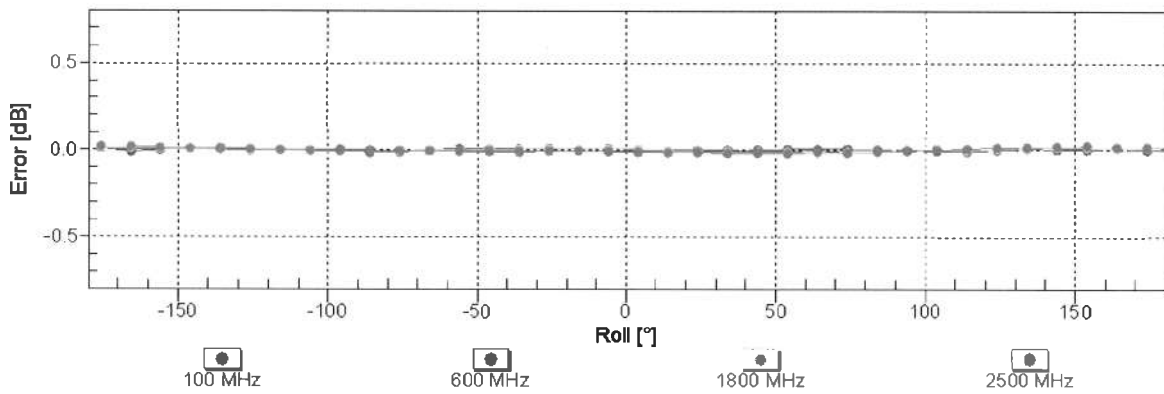

Uncertainty of Axial Isotropy Assessment: $\pm 0.5\%$ ($k=2$)

Dynamic Range f(E-field) (TEM cell , f = 900 MHz)

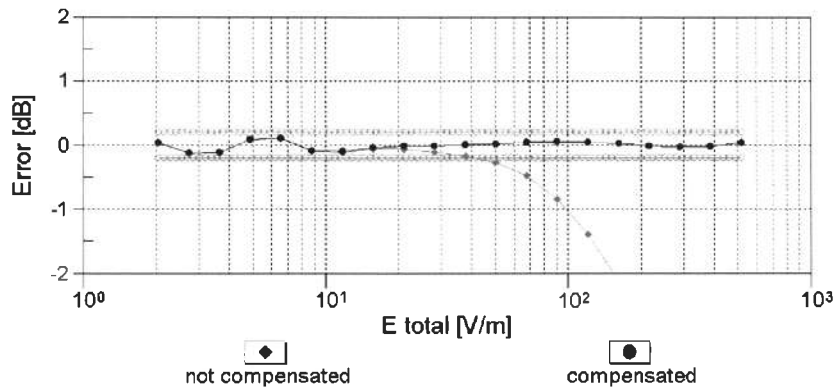
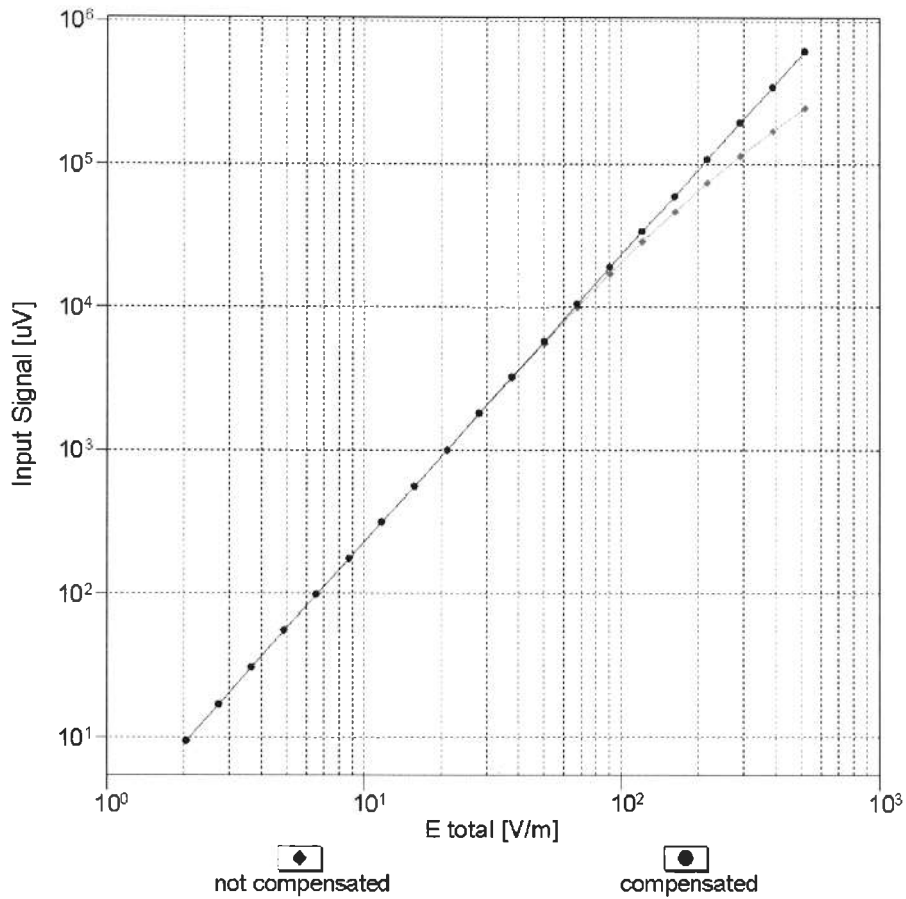

Uncertainty of Linearity Assessment: ± 0.6% (k=2)

Deviation from Isotropy in Air

Error (ϕ, θ), $f = 900$ MHz

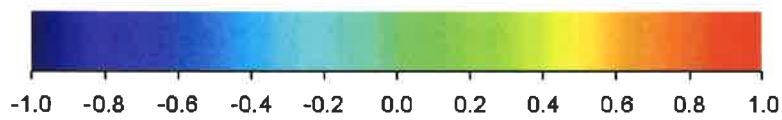
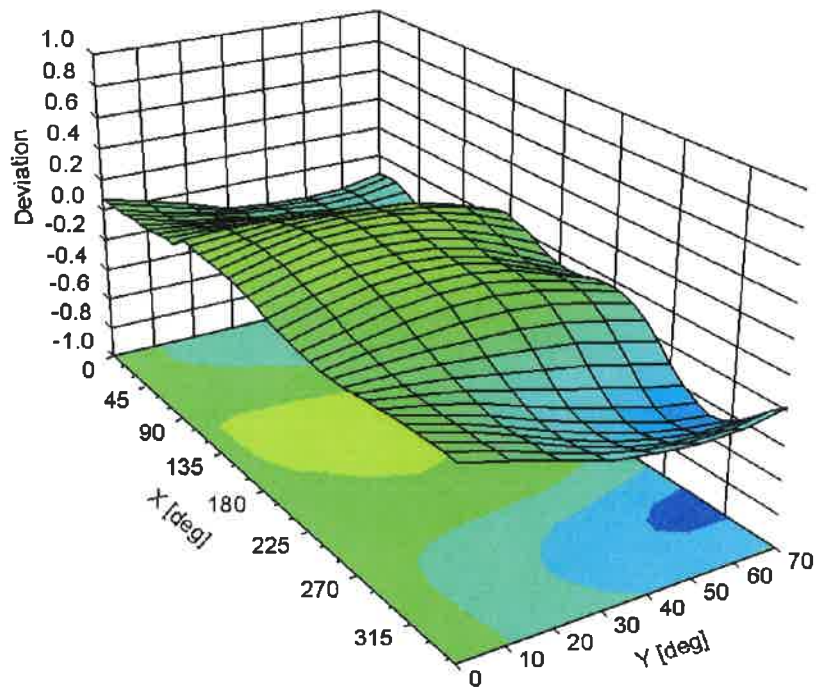

Uncertainty of Spherical Isotropy Assessment: $\pm 2.6\%$ ($k=2$)

DASY/EASY - Parameters of Probe: ER3DV6 - SN:2445

Other Probe Parameters

Sensor Arrangement	Rectangular
Connector Angle (°)	44.1
Mechanical Surface Detection Mode	enabled
Optical Surface Detection Mode	disabled
Probe Overall Length	337 mm
Probe Body Diameter	10 mm
Tip Length	10 mm
Tip Diameter	8 mm
Probe Tip to Sensor X Calibration Point	2.5 mm
Probe Tip to Sensor Y Calibration Point	2.5 mm
Probe Tip to Sensor Z Calibration Point	2.5 mm



Accredited by the Swiss Accreditation Service (SAS)

Accreditation No.: **SCS 108**

The Swiss Accreditation Service is one of the signatories to the EA
Multilateral Agreement for the recognition of calibration certificates

Client **B.V. ADT (Auden)**

Certificate No: **H3-6274_Feb13**

CALIBRATION CERTIFICATE

Object **H3DV6 - SN:6274**

Calibration procedure(s) **QA CAL-03.v6, QA CAL-25.v4
Calibration procedure for H-field probes optimized for close near field
evaluations in air**

Calibration date: **February 15, 2013**

This calibration certificate documents the traceability to national standards, which realize the physical units of measurements (SI).
The measurements and the uncertainties with confidence probability are given on the following pages and are part of the certificate.

All calibrations have been conducted in the closed laboratory facility: environment temperature (22 ± 3)°C and humidity < 70%.

Calibration Equipment used (M&TE critical for calibration)

Primary Standards	ID	Cal Date (Certificate No.)	Scheduled Calibration
Power meter E4419B	GB41293874	29-Mar-12 (No. 217-01508)	Apr-13
Power sensor E4412A	MY41498087	29-Mar-12 (No. 217-01508)	Apr-13
Reference 3 dB Attenuator	SN: S5054 (3c)	27-Mar-12 (No. 217-01531)	Apr-13
Reference 20 dB Attenuator	SN: S5086 (20b)	27-Mar-12 (No. 217-01529)	Apr-13
Reference 30 dB Attenuator	SN: S5129 (30b)	27-Mar-12 (No. 217-01532)	Apr-13
Reference Probe H3DV6	SN: 6182	12-Oct-12 (No. H3-6182_Oct12)	Oct-13
DAE4	SN: 789	18-Sep-12 (No. DAE4-789_Sep12)	Sep-13
Secondary Standards	ID	Check Date (in house)	Scheduled Check
RF generator HP 8648C	US3642U01700	4-Aug-99 (in house check Apr-11)	In house check: Apr-13
Network Analyzer HP 8753E	US37390585	18-Oct-01 (in house check Oct-12)	In house check: Oct-13

Calibrated by:	Name Claudio Leubler	Function Laboratory Technician	Signature
Approved by:	Name Katja Pokovic	Function Technical Manager	
			Issued: February 20, 2013
This calibration certificate shall not be reproduced except in full without written approval of the laboratory.			



Accredited by the Swiss Accreditation Service (SAS)

Accreditation No.: **SCS 108**

The Swiss Accreditation Service is one of the signatories to the EA
Multilateral Agreement for the recognition of calibration certificates

Glossary:

NORM _{x,y,z}	sensitivity in free space
DCP	diode compression point
CF	crest factor (1/duty_cycle) of the RF signal
A, B, C, D	modulation dependent linearization parameters
Polarization ϕ	ϕ rotation around probe axis
Polarization ϑ	ϑ rotation around an axis that is in the plane normal to probe axis (at measurement center), i.e., $\vartheta = 0$ is normal to probe axis
Connector Angle	information used in DASY system to align probe sensor X to the robot coordinate system

Calibration is Performed According to the Following Standards:

- IEEE Std 1309-2005, " IEEE Standard for calibration of electromagnetic field sensors and probes, excluding antennas, from 9 kHz to 40 GHz", December 2005.
- CTIA Test Plan for Hearing Aid Compatibility, April 2010.

Methods Applied and Interpretation of Parameters:

- NORM_{x,y,z}*: Assessed for E-field polarization $\vartheta = 0$ for XY sensors and $\vartheta = 90$ for Z sensor ($f \leq 900$ MHz in TEM-cell; $f > 1800$ MHz: R22 waveguide).
- X, Y, Z(f)_a0a1a2* = *X, Y, Z_a0a1a2* * *frequency_response* (see Frequency Response Chart).
- DCP_{x,y,z}*: DCP are numerical linearization parameters assessed based on the data of power sweep with CW signal (no uncertainty required). DCP does not depend on frequency nor media.
- PAR*: PAR is the Peak to Average Ratio that is not calibrated but determined based on the signal characteristics
- A_{x,y,z}; B_{x,y,z}; C_{x,y,z}; D_{x,y,z}; VR_{x,y,z}; A, B, C, D* are numerical linearization parameters assessed based on the data of power sweep for specific modulation signal. The parameters do not depend on frequency nor media. *VR* is the maximum calibration range expressed in RMS voltage across the diode.
- Spherical isotropy (3D deviation from isotropy)*: in a locally homogeneous field realized using an open waveguide setup.
- Sensor Offset*: The sensor offset corresponds to the offset of virtual measurement center from the probe tip (on probe axis). No tolerance required.
- Connector Angle*: The angle is assessed using the information gained by determining the *X_a0a1a2* (no uncertainty required).

Probe H3DV6

SN:6274

Manufactured: November 30, 2007
Calibrated: February 15, 2013

Calibrated for DASY/EASY Systems
(Note: non-compatible with DASY2 system!)

DASY/EASY - Parameters of Probe: H3DV6 - SN:6274

Basic Calibration Parameters

		Sensor X	Sensor Y	Sensor Z	Unc (k=2)
Norm (A/m / $\sqrt{\text{mV}}$)	a0	2.50E-003	2.58E-003	2.91E-003	$\pm 5.1 \%$
Norm (A/m / $\sqrt{\text{mV}}$)	a1	-1.49E-004	-1.98E-004	-1.16E-004	$\pm 5.1 \%$
Norm (A/m / $\sqrt{\text{mV}}$)	a2	3.26E-005	7.89E-006	1.09E-005	$\pm 5.1 \%$
DCP (mV) ^B		92.3	92.2	92.4	

Modulation Calibration Parameters

UID	Communication System Name		A dB	B dB $\sqrt{\mu\text{V}}$	C	D dB	VR mV	Unc ^E (k=2)
0	CW	X	0.0	0.0	1.0	0.00	144.1	$\pm 3.5 \%$
		Y	0.0	0.0	1.0		142.7	
		Z	0.0	0.0	1.0		139.7	

The reported uncertainty of measurement is stated as the standard uncertainty of measurement multiplied by the coverage factor $k=2$, which for a normal distribution corresponds to a coverage probability of approximately 95%.

^B Numerical linearization parameter: uncertainty not required.

^E Uncertainty is determined using the max. deviation from linear response applying rectangular distribution and is expressed for the square of the field value.

Frequency Response of H-Field

(TEM-Cell:ifi110 EXX, Waveguide: R22)

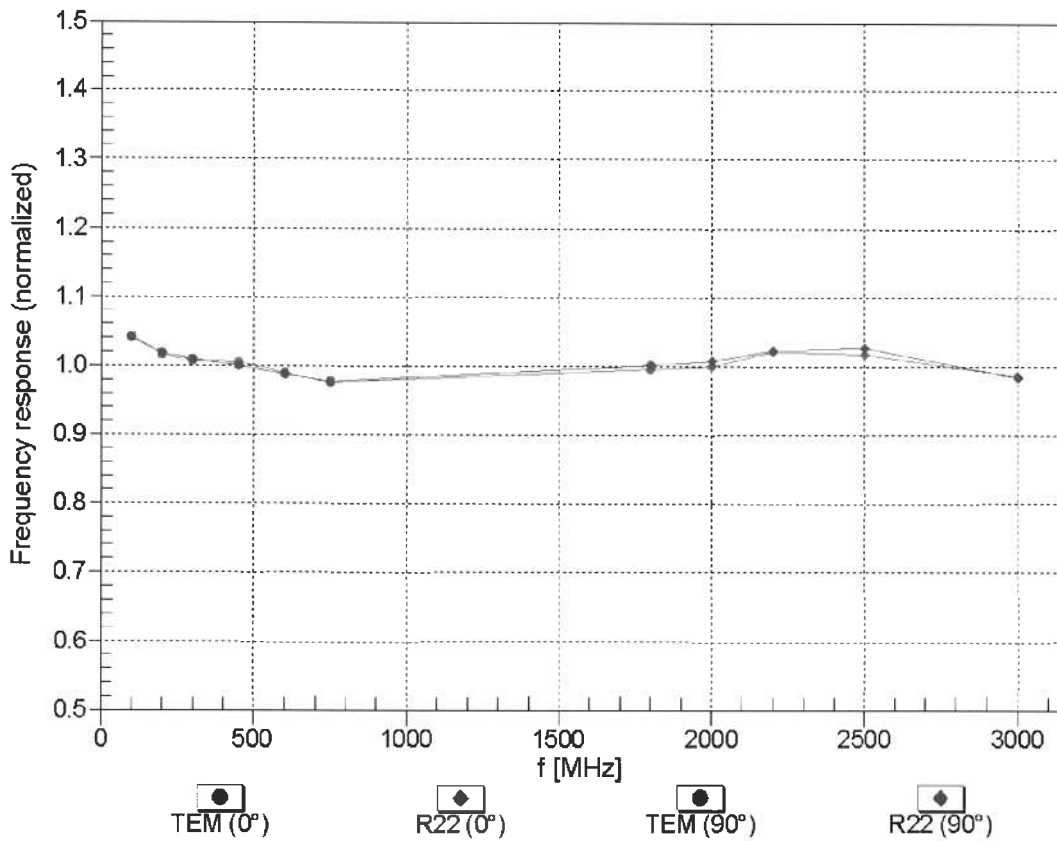

Uncertainty of Frequency Response of H-field: $\pm 6.3\%$ (k=2)

Receiving Pattern (ϕ), $\vartheta = 0^\circ$

f=600 MHz, TEM, 0°

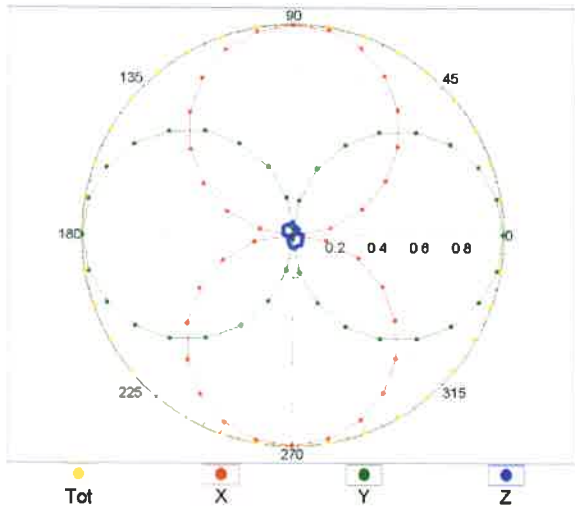

f=2500 MHz, R22, 0°

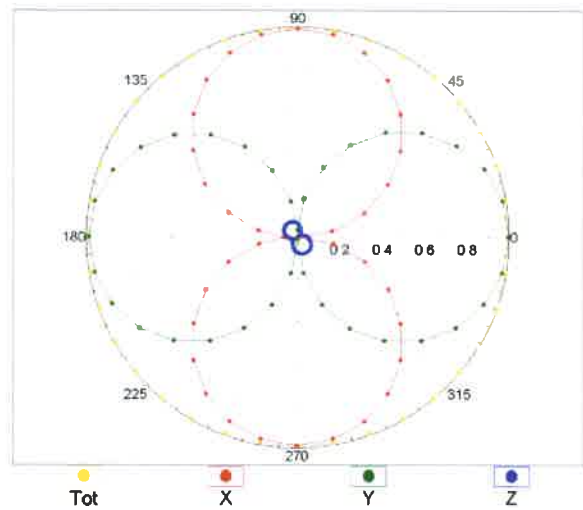

Receiving Pattern (ϕ), $\vartheta = 90^\circ$

f=600 MHz, TEM, 90°

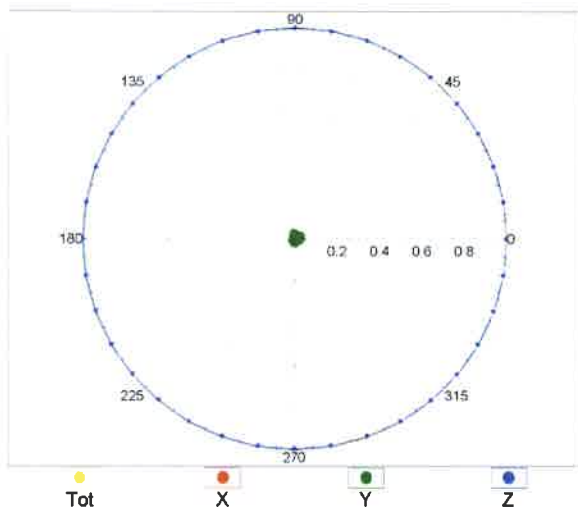

f=2500 MHz, R22, 90°

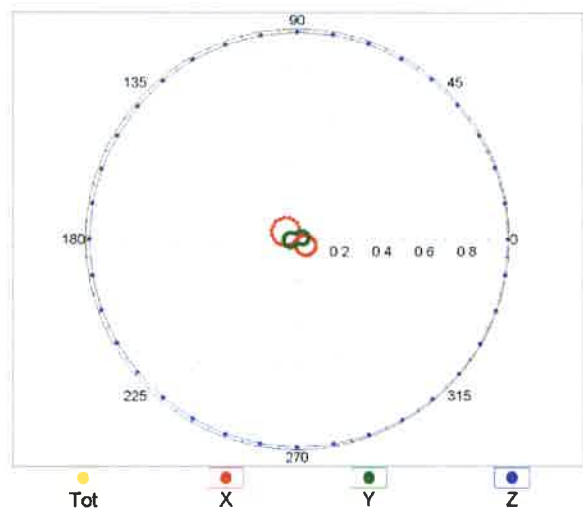

Receiving Pattern (ϕ), $\vartheta = 0^\circ$

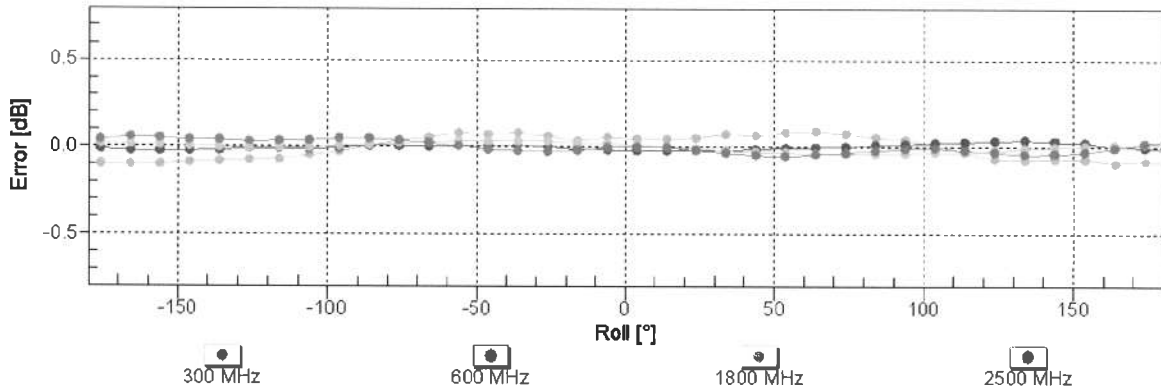

Uncertainty of Axial Isotropy Assessment: $\pm 0.5\%$ (k=2)

Receiving Pattern (ϕ), $\vartheta = 90^\circ$

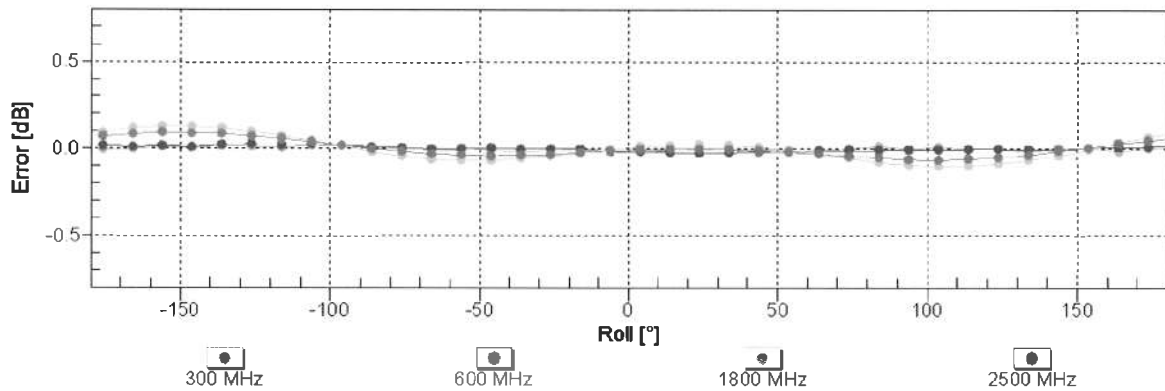

Uncertainty of Axial Isotropy Assessment: $\pm 0.5\%$ (k=2)

Dynamic Range f(H-field) (TEM cell, f = 900 MHz)

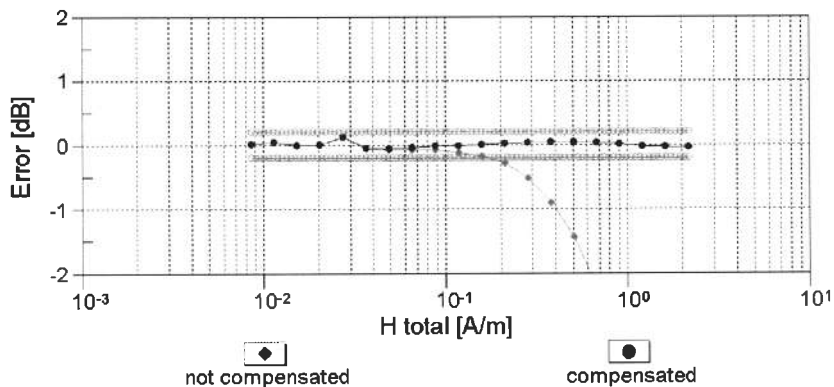
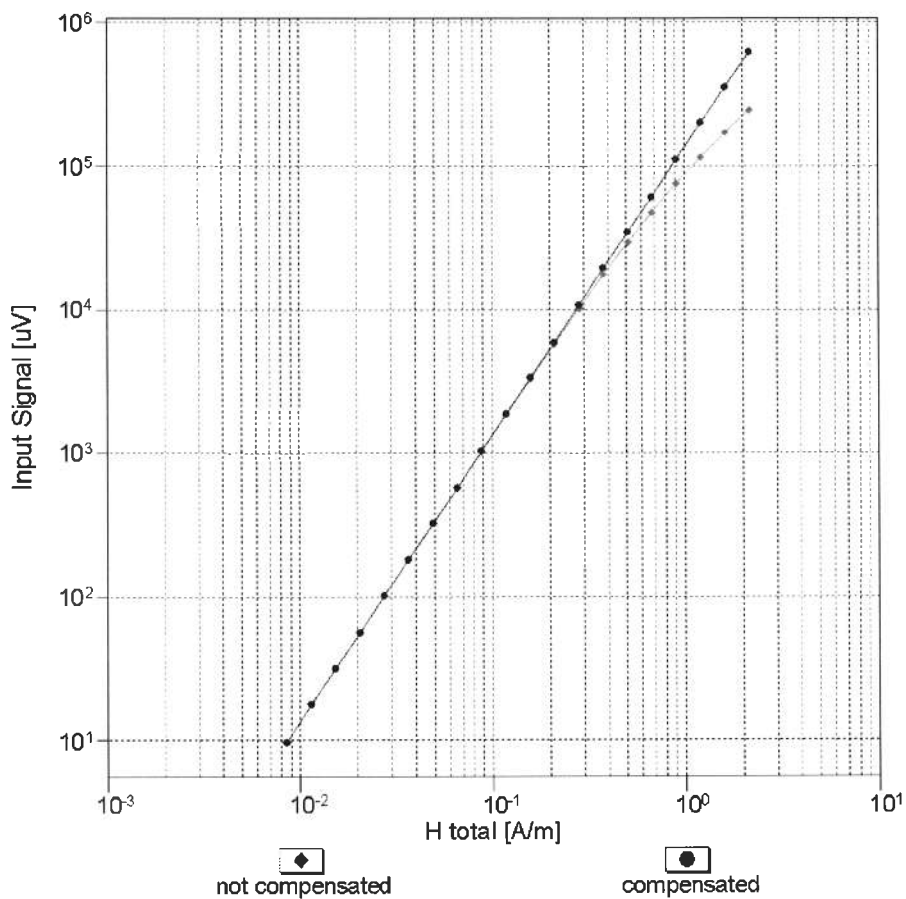

Uncertainty of Linearity Assessment: ± 0.6% (k=2)

Deviation from Isotropy in Air

Error (ϕ, θ), $f = 900$ MHz

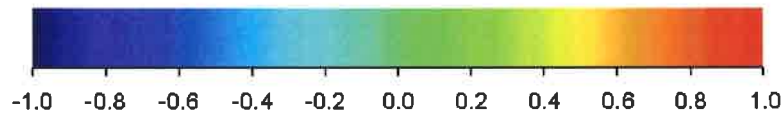
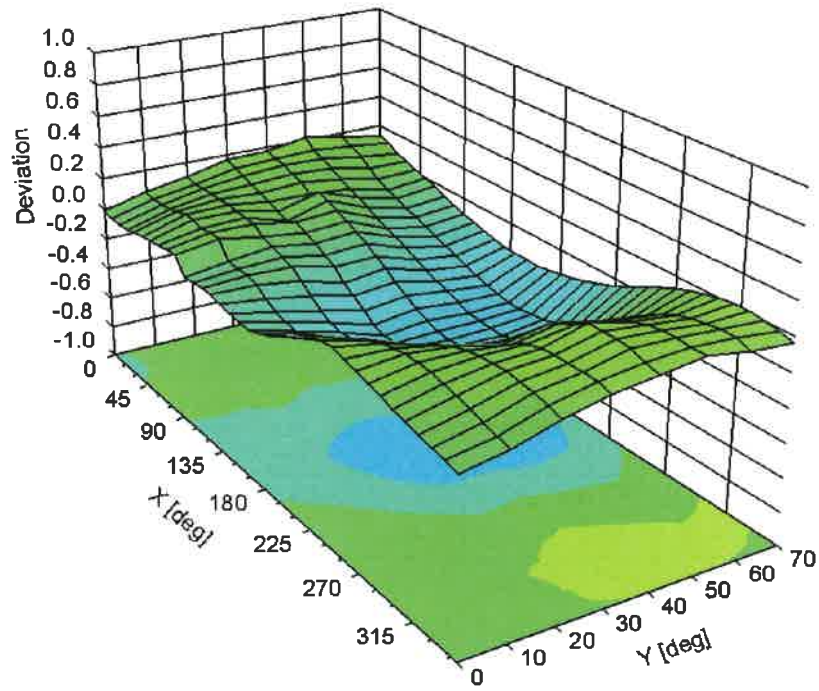

Uncertainty of Spherical Isotropy Assessment: $\pm 2.6\%$ ($k=2$)

DASY/EASY - Parameters of Probe: H3DV6 - SN:6274

Other Probe Parameters

Sensor Arrangement	Rectangular
Connector Angle (°)	-126.1
Mechanical Surface Detection Mode	enabled
Optical Surface Detection Mode	disabled
Probe Overall Length	337 mm
Probe Body Diameter	10 mm
Tip Length	20 mm
Tip Diameter	6 mm
Probe Tip to Sensor X Calibration Point	3 mm
Probe Tip to Sensor Y Calibration Point	3 mm
Probe Tip to Sensor Z Calibration Point	3 mm