

#57_GSM850_DTM Multi-slot class 11_Right Cheek_Ch251

DUT: 370213

Communication System: GSM850; Frequency: 848.8 MHz; Duty Cycle: 1:2.67

Medium: HSL_850_130710 Medium parameters used: $f = 849$ MHz; $\sigma = 0.938$ mho/m; $\epsilon_r = 43.1$; $\rho = 1000$ kg/m³

Ambient Temperature : 23.5 °C ; Liquid Temperature : 22.5 °C

DASY4 Configuration:

- Probe: ET3DV6R - SN1788; ConvF(5.96, 5.96, 5.96); Calibrated: 2012/10/23
- Sensor-Surface: 4mm (Mechanical Surface Detection)
- Electronics: DAE3 Sn577; Calibrated: 2013/5/8
- Phantom: SAM_Left; Type: SAM; Serial: TP-1150
- Measurement SW: DASY4, V4.7 Build 80; Postprocessing SW: SEMCAD, V1.8 Build 186

Ch251/Area Scan (61x101x1): Measurement grid: dx=15mm, dy=15mm

Maximum value of SAR (interpolated) = 0.628 mW/g

Ch251/Zoom Scan (5x5x7)/Cube 0: Measurement grid: dx=8mm, dy=8mm, dz=5mm

Reference Value = 26.3 V/m; Power Drift = -0.002 dB

Peak SAR (extrapolated) = 0.728 W/kg

SAR(1 g) = 0.571 mW/g; SAR(10 g) = 0.433 mW/g

Maximum value of SAR (measured) = 0.593 mW/g

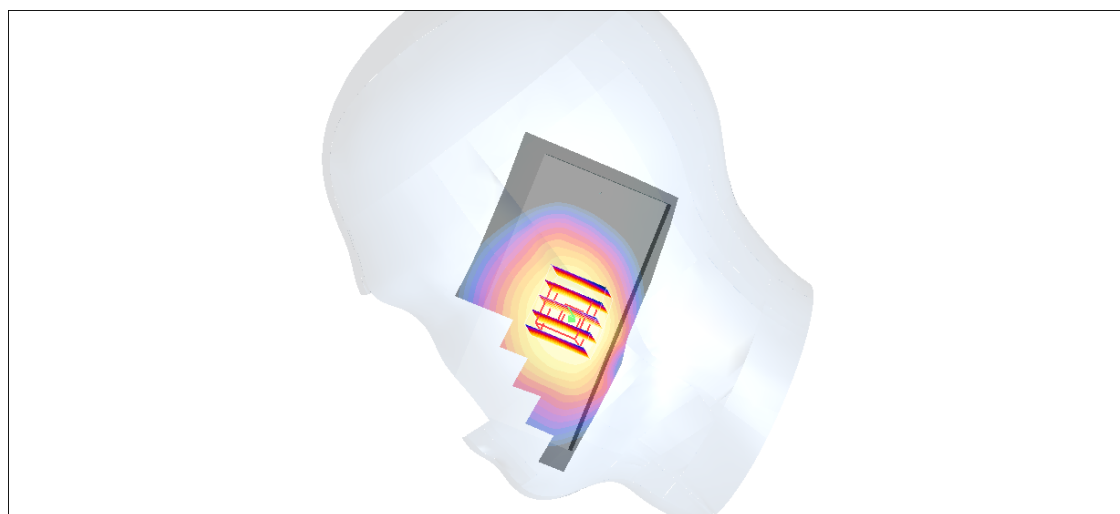
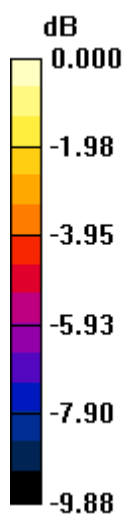

0 dB = 0.593mW/g

#58_GSM850_DTM Multi-slot class 11_Right Tilted_Ch251

DUT: 370213

Communication System: GSM850; Frequency: 848.8 MHz; Duty Cycle: 1:2.67

Medium: HSL_850_130710 Medium parameters used: $f = 849$ MHz; $\sigma = 0.938$ mho/m; $\epsilon_r = 43.1$; $\rho = 1000$ kg/m³

Ambient Temperature : 23.5 °C; Liquid Temperature : 22.5 °C

DASY4 Configuration:

- Probe: ET3DV6R - SN1788; ConvF(5.96, 5.96, 5.96); Calibrated: 2012/10/23
- Sensor-Surface: 4mm (Mechanical Surface Detection)
- Electronics: DAE3 Sn577; Calibrated: 2013/5/8
- Phantom: SAM_Left; Type: SAM; Serial: TP-1150
- Measurement SW: DASY4, V4.7 Build 80; Postprocessing SW: SEMCAD, V1.8 Build 186

Ch251/Area Scan (61x101x1): Measurement grid: dx=15mm, dy=15mm

Maximum value of SAR (interpolated) = 0.363 mW/g

Ch251/Zoom Scan (5x5x7)/Cube 0: Measurement grid: dx=8mm, dy=8mm, dz=5mm

Reference Value = 19.9 V/m; Power Drift = 0.050 dB

Peak SAR (extrapolated) = 0.401 W/kg

SAR(1 g) = 0.342 mW/g; SAR(10 g) = 0.265 mW/g

Maximum value of SAR (measured) = 0.356 mW/g

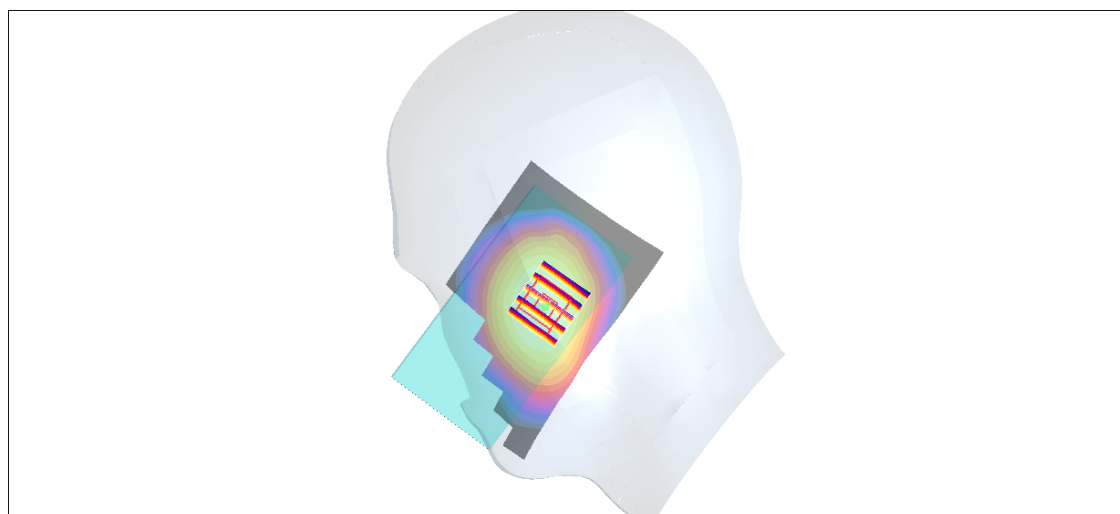
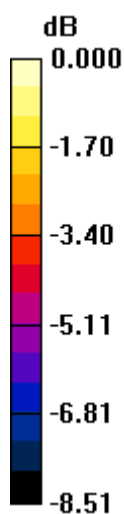

0 dB = 0.356mW/g

#59_GSM850_DTM Multi-slot class 11_Left Cheek_Ch251**DUT: 370213**

Communication System: GSM850; Frequency: 848.8 MHz; Duty Cycle: 1:2.67

Medium: HSL_850_130710 Medium parameters used: $f = 849$ MHz; $\sigma = 0.938$ mho/m; $\epsilon_r = 43.1$; $\rho = 1000$ kg/m³

Ambient Temperature : 23.5 °C ; Liquid Temperature : 22.5 °C

DASY4 Configuration:

- Probe: ET3DV6R - SN1788; ConvF(5.96, 5.96, 5.96); Calibrated: 2012/10/23
- Sensor-Surface: 4mm (Mechanical Surface Detection)
- Electronics: DAE3 Sn577; Calibrated: 2013/5/8
- Phantom: SAM_Left; Type: SAM; Serial: TP-1150
- Measurement SW: DASY4, V4.7 Build 80; Postprocessing SW: SEMCAD, V1.8 Build 186

Ch251/Area Scan (61x101x1): Measurement grid: dx=15mm, dy=15mm

Maximum value of SAR (interpolated) = 0.512 mW/g

Ch251/Zoom Scan (5x5x7)/Cube 0: Measurement grid: dx=8mm, dy=8mm, dz=5mm

Reference Value = 24.1 V/m; Power Drift = 0.058 dB

Peak SAR (extrapolated) = 0.587 W/kg

SAR(1 g) = 0.486 mW/g; SAR(10 g) = 0.365 mW/g

Maximum value of SAR (measured) = 0.516 mW/g

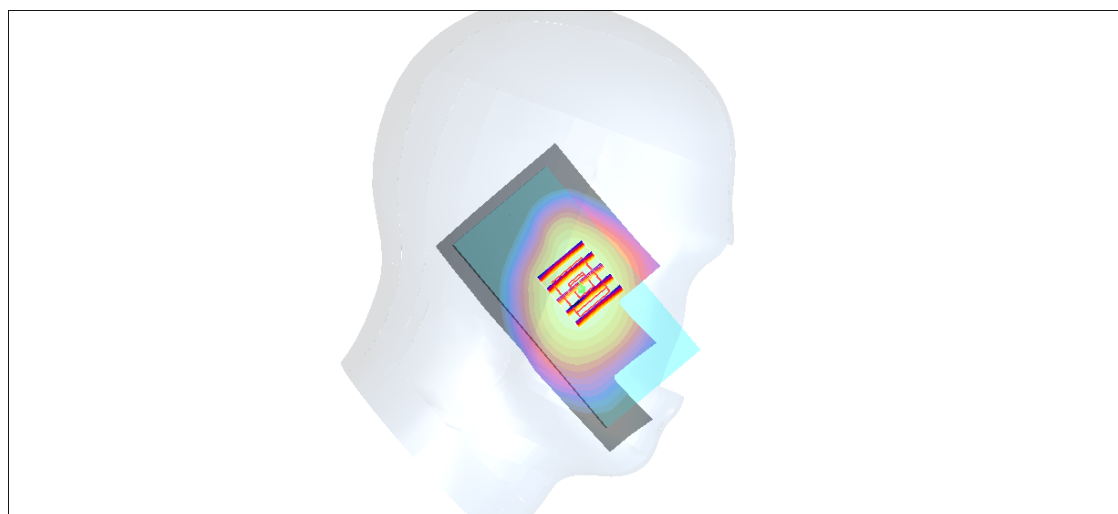
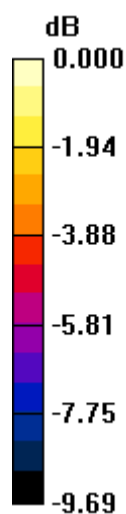

0 dB = 0.516mW/g

#60_GSM850_DTM Multi-slot class 11_Left Tilted_Ch251**DUT: 370213**

Communication System: GSM850; Frequency: 848.8 MHz; Duty Cycle: 1:2.67

Medium: HSL_850_130710 Medium parameters used: $f = 849$ MHz; $\sigma = 0.938$ mho/m; $\epsilon_r = 43.1$; $\rho = 1000$ kg/m³

Ambient Temperature : 23.5 °C; Liquid Temperature : 22.5 °C

DASY4 Configuration:

- Probe: ET3DV6R - SN1788; ConvF(5.96, 5.96, 5.96); Calibrated: 2012/10/23
- Sensor-Surface: 4mm (Mechanical Surface Detection)
- Electronics: DAE3 Sn577; Calibrated: 2013/5/8
- Phantom: SAM_Left; Type: SAM; Serial: TP-1150
- Measurement SW: DASY4, V4.7 Build 80; Postprocessing SW: SEMCAD, V1.8 Build 186

Ch251/Area Scan (61x101x1): Measurement grid: dx=15mm, dy=15mm

Maximum value of SAR (interpolated) = 0.351 mW/g

Ch251/Zoom Scan (5x5x7)/Cube 0: Measurement grid: dx=8mm, dy=8mm, dz=5mm

Reference Value = 20.1 V/m; Power Drift = 0.009 dB

Peak SAR (extrapolated) = 0.398 W/kg

SAR(1 g) = 0.333 mW/g; SAR(10 g) = 0.258 mW/g

Maximum value of SAR (measured) = 0.349 mW/g

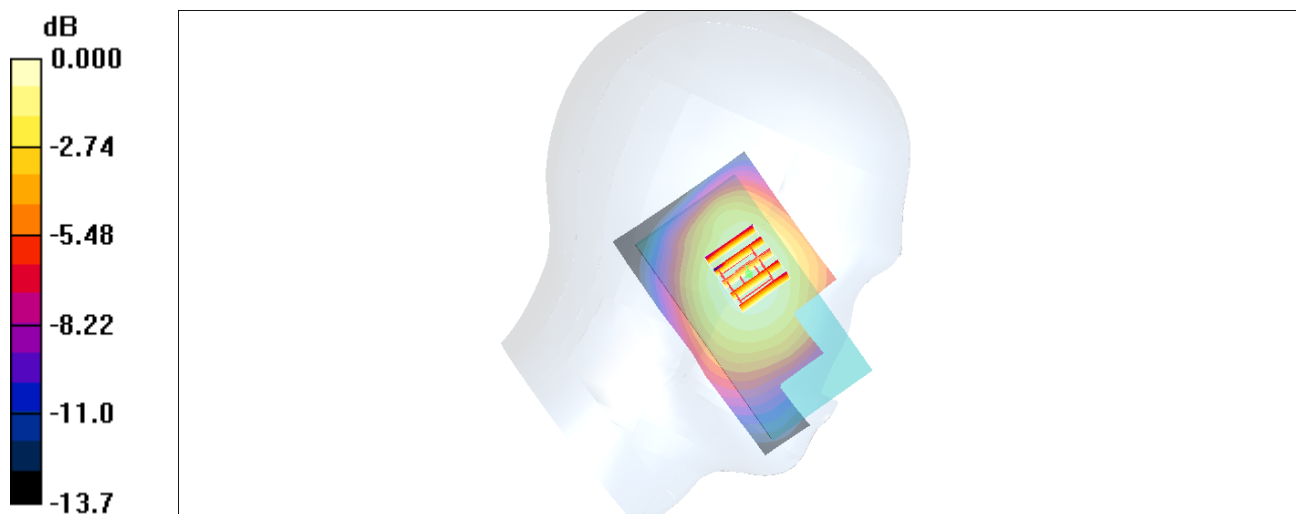

0 dB = 0.349mW/g

#69_GSM1900_DTM Multi-slot class 11_Right Cheek_Ch512

DUT: 370213

Communication System: PCS; Frequency: 1850.2 MHz; Duty Cycle: 1:2.67

Medium: HSL_1900_130710 Medium parameters used: $f = 1850.2$ MHz; $\sigma = 1.4$ mho/m; $\epsilon_r = 38.8$; $\rho = 1000$

kg/m³

Ambient Temperature : 23.5 °C; Liquid Temperature : 22.5 °C

DASY4 Configuration:

- Probe: ET3DV6R - SN1788; ConvF(4.65, 4.65, 4.65); Calibrated: 2012/10/23
- Sensor-Surface: 4mm (Mechanical Surface Detection)
- Electronics: DAE3 Sn577; Calibrated: 2013/5/8
- Phantom: SAM_Right; Type: SAM; Serial: TP-1303
- Measurement SW: DASY4, V4.7 Build 80; Postprocessing SW: SEMCAD, V1.8 Build 186

Ch512/Area Scan (61x101x1): Measurement grid: dx=15mm, dy=15mm

Maximum value of SAR (interpolated) = 0.289 mW/g

Ch512/Zoom Scan (5x5x7)/Cube 0: Measurement grid: dx=8mm, dy=8mm, dz=5mm

Reference Value = 15.2 V/m; Power Drift = -0.116 dB

Peak SAR (extrapolated) = 0.319 W/kg

SAR(1 g) = 0.255 mW/g; SAR(10 g) = 0.177 mW/g

Maximum value of SAR (measured) = 0.277 mW/g

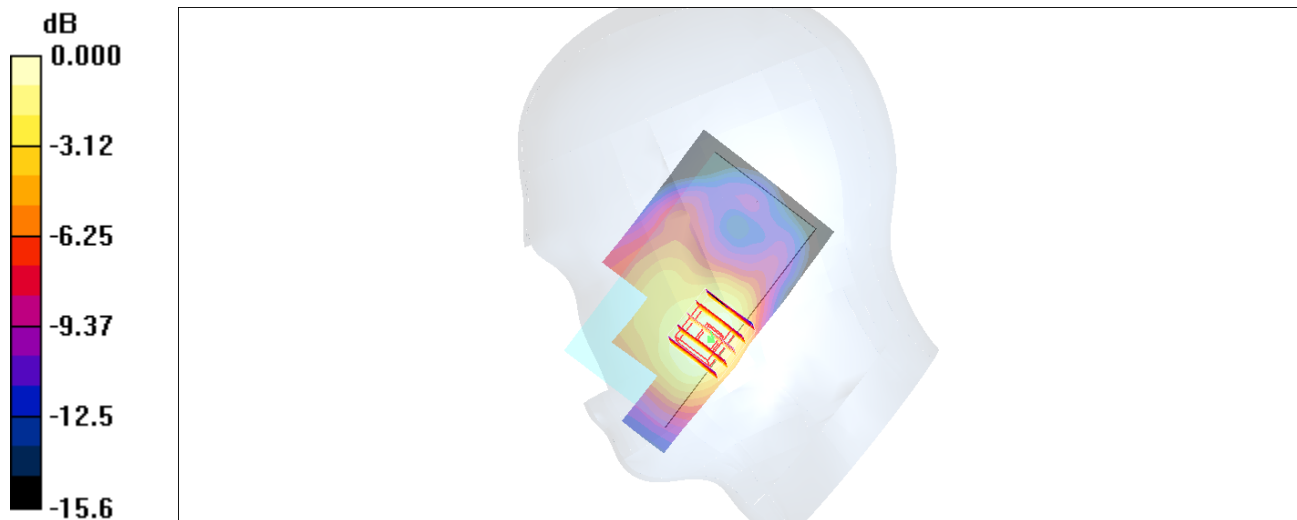

0 dB = 0.277mW/g

#70_GSM1900_DTM Multi-slot class 11_Right Tilted_Ch512

DUT: 370213

Communication System: PCS; Frequency: 1850.2 MHz; Duty Cycle: 1:2.67

Medium: HSL_1900_130710 Medium parameters used: $f = 1850.2$ MHz; $\sigma = 1.4$ mho/m; $\epsilon_r = 38.8$; $\rho = 1000$

kg/m³

Ambient Temperature : 23.5 °C; Liquid Temperature : 22.5 °C

DASY4 Configuration:

- Probe: ET3DV6R - SN1788; ConvF(4.65, 4.65, 4.65); Calibrated: 2012/10/23
- Sensor-Surface: 4mm (Mechanical Surface Detection)
- Electronics: DAE3 Sn577; Calibrated: 2013/5/8
- Phantom: SAM_Right; Type: SAM; Serial: TP-1303
- Measurement SW: DASY4, V4.7 Build 80; Postprocessing SW: SEMCAD, V1.8 Build 186

Ch512/Area Scan (61x101x1): Measurement grid: dx=15mm, dy=15mm

Maximum value of SAR (interpolated) = 0.042 mW/g

Ch512/Zoom Scan (5x5x7)/Cube 0: Measurement grid: dx=8mm, dy=8mm, dz=5mm

Reference Value = 5.67 V/m; Power Drift = -0.015 dB

Peak SAR (extrapolated) = 0.045 W/kg

SAR(1 g) = 0.038 mW/g; SAR(10 g) = 0.028 mW/g

Maximum value of SAR (measured) = 0.040 mW/g

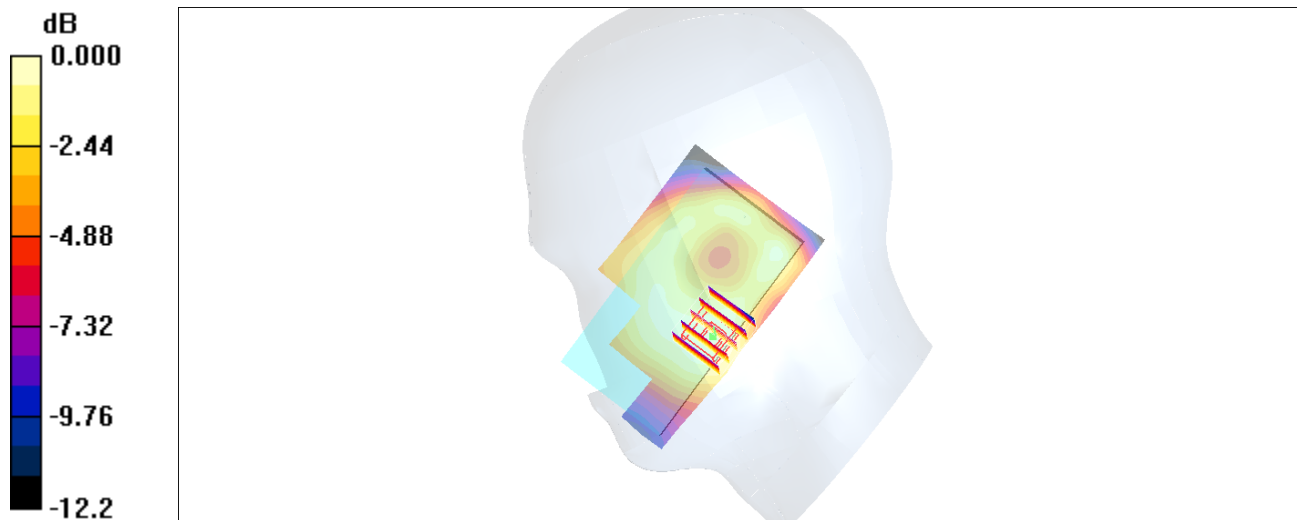

0 dB = 0.040mW/g

#71_GSM1900_DTM Multi-slot class 11_Left Cheek_Ch512**DUT: 370213**

Communication System: PCS; Frequency: 1850.2 MHz; Duty Cycle: 1:2.67

Medium: HSL_1900_130710 Medium parameters used: $f = 1850.2$ MHz; $\sigma = 1.4$ mho/m; $\epsilon_r = 38.8$; $\rho = 1000$ kg/m^3

Ambient Temperature : 23.5 °C; Liquid Temperature : 22.5 °C

DASY4 Configuration:

- Probe: ET3DV6R - SN1788; ConvF(4.65, 4.65, 4.65); Calibrated: 2012/10/23
- Sensor-Surface: 4mm (Mechanical Surface Detection)
- Electronics: DAE3 Sn577; Calibrated: 2013/5/8
- Phantom: SAM_Right; Type: SAM; Serial: TP-1303
- Measurement SW: DASY4, V4.7 Build 80; Postprocessing SW: SEMCAD, V1.8 Build 186

Ch512/Area Scan (61x101x1): Measurement grid: dx=15mm, dy=15mm

Maximum value of SAR (interpolated) = 0.277 mW/g

Ch512/Zoom Scan (5x5x7)/Cube 0: Measurement grid: dx=8mm, dy=8mm, dz=5mm

Reference Value = 15.3 V/m; Power Drift = 0.055 dB

Peak SAR (extrapolated) = 0.369 W/kg

SAR(1 g) = 0.269 mW/g; SAR(10 g) = 0.178 mW/g

Maximum value of SAR (measured) = 0.288 mW/g

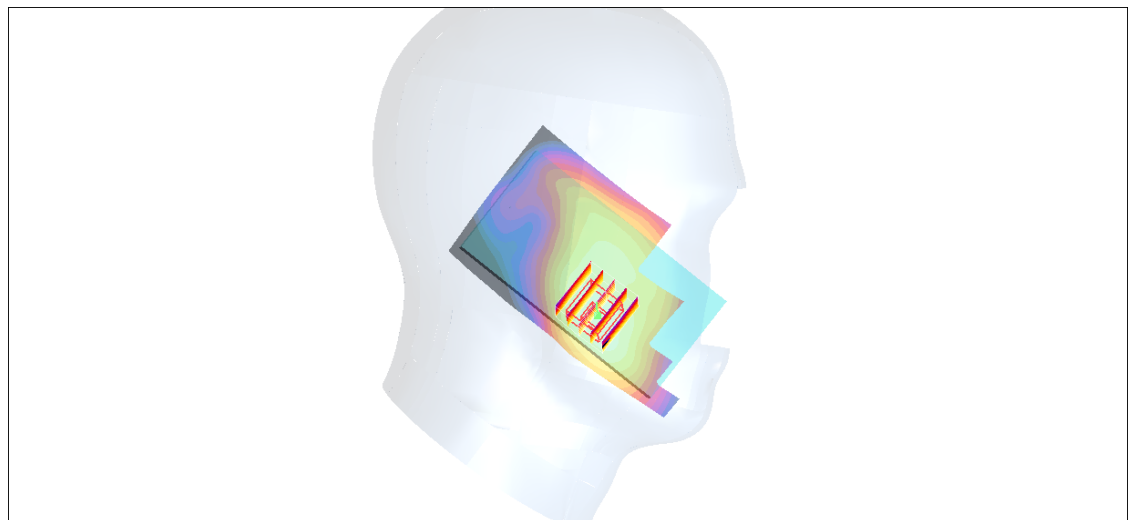
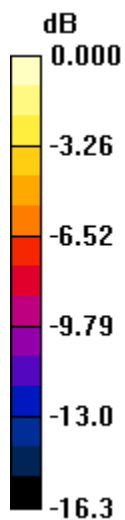

0 dB = 0.288mW/g

#72_GSM1900_DTM Multi-slot class 11_Left Tilted_Ch512**DUT: 370213**

Communication System: PCS; Frequency: 1850.2 MHz; Duty Cycle: 1:2.67

Medium: HSL_1900_130710 Medium parameters used: $f = 1850.2$ MHz; $\sigma = 1.4$ mho/m; $\epsilon_r = 38.8$; $\rho = 1000$ kg/m^3

Ambient Temperature : 23.5 °C; Liquid Temperature : 22.5 °C

DASY4 Configuration:

- Probe: ET3DV6R - SN1788; ConvF(4.65, 4.65, 4.65); Calibrated: 2012/10/23
- Sensor-Surface: 4mm (Mechanical Surface Detection)
- Electronics: DAE3 Sn577; Calibrated: 2013/5/8
- Phantom: SAM_Right; Type: SAM; Serial: TP-1303
- Measurement SW: DASY4, V4.7 Build 80; Postprocessing SW: SEMCAD, V1.8 Build 186

Ch512/Area Scan (61x101x1): Measurement grid: dx=15mm, dy=15mm

Maximum value of SAR (interpolated) = 0.078 mW/g

Ch512/Zoom Scan (5x5x7)/Cube 0: Measurement grid: dx=8mm, dy=8mm, dz=5mm

Reference Value = 7.88 V/m; Power Drift = -0.018 dB

Peak SAR (extrapolated) = 0.097 W/kg

SAR(1 g) = 0.070 mW/g; SAR(10 g) = 0.043 mW/g

Maximum value of SAR (measured) = 0.077 mW/g

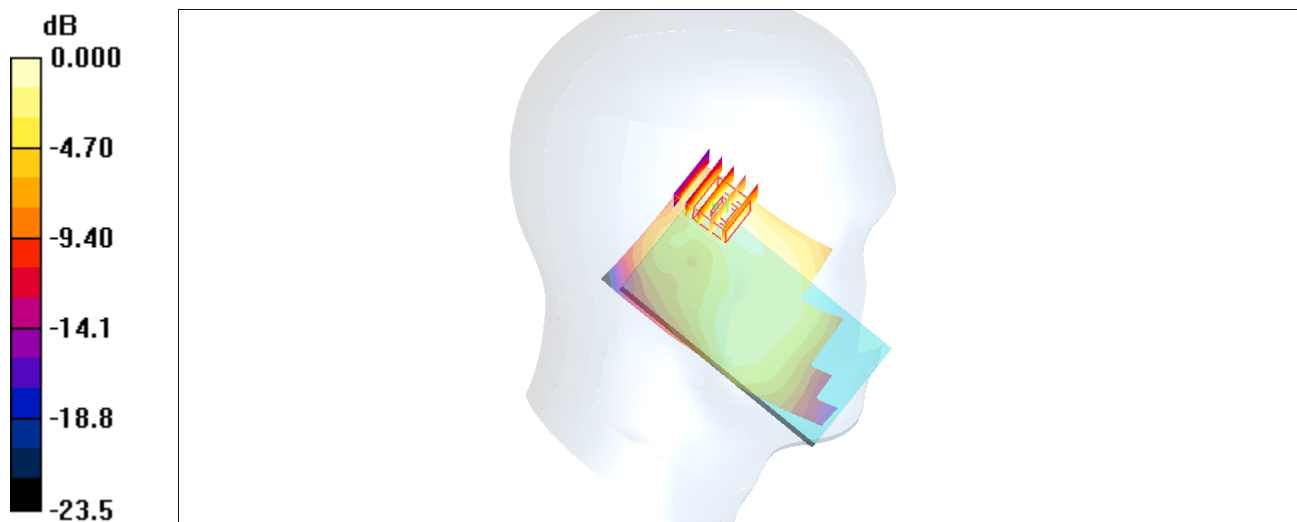

0 dB = 0.077mW/g

#61_WCDMA V_RMC12.2Kbps_Right Cheek_Ch4233

DUT: 370213

Communication System: WCDMA; Frequency: 846.6 MHz; Duty Cycle: 1:1

Medium: HSL_850_130710 Medium parameters used: $f = 847$ MHz; $\sigma = 0.936$ mho/m; $\epsilon_r = 43.2$; $\rho = 1000$ kg/m³

Ambient Temperature : 23.5 °C ; Liquid Temperature : 22.5 °C

DASY4 Configuration:

- Probe: ET3DV6R - SN1788; ConvF(5.96, 5.96, 5.96); Calibrated: 2012/10/23
- Sensor-Surface: 4mm (Mechanical Surface Detection)
- Electronics: DAE3 Sn577; Calibrated: 2013/5/8
- Phantom: SAM_Left; Type: SAM; Serial: TP-1150
- Measurement SW: DASY4, V4.7 Build 80; Postprocessing SW: SEMCAD, V1.8 Build 186

Ch4233/Area Scan (61x101x1): Measurement grid: dx=15mm, dy=15mm

Maximum value of SAR (interpolated) = 0.460 mW/g

Ch4233/Zoom Scan (5x5x7)/Cube 0: Measurement grid: dx=8mm, dy=8mm, dz=5mm

Reference Value = 22.4 V/m; Power Drift = -0.008 dB

Peak SAR (extrapolated) = 0.534 W/kg

SAR(1 g) = 0.416 mW/g; SAR(10 g) = 0.314 mW/g

Maximum value of SAR (measured) = 0.430 mW/g

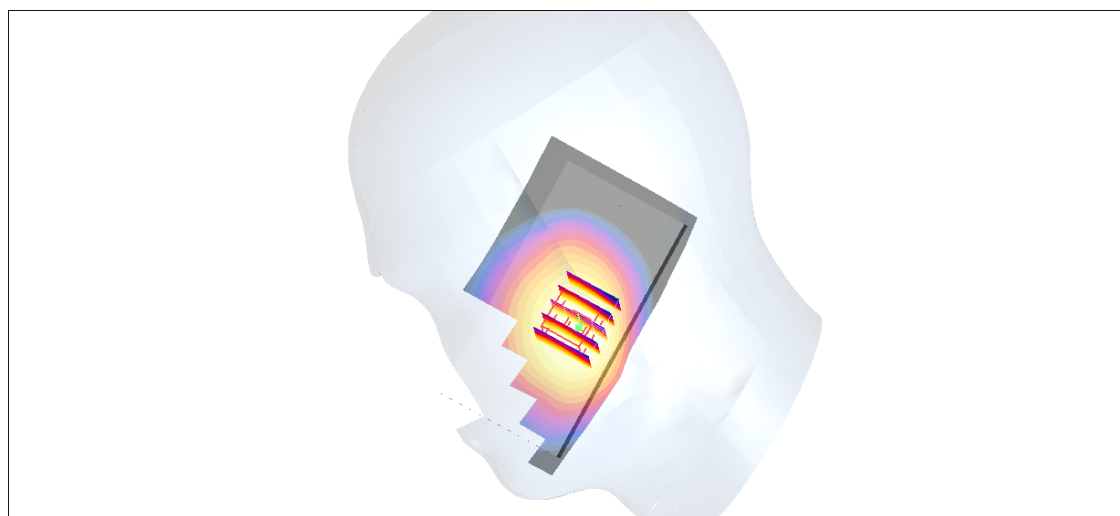
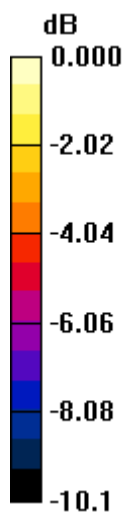

0 dB = 0.430mW/g

#62_WCDMA V_RMC12.2Kbps_Right Tilted_Ch4233

DUT: 370213

Communication System: WCDMA; Frequency: 846.6 MHz; Duty Cycle: 1:1

Medium: HSL_850_130710 Medium parameters used: $f = 847$ MHz; $\sigma = 0.936$ mho/m; $\epsilon_r = 43.2$; $\rho = 1000$ kg/m³

Ambient Temperature : 23.5 °C ; Liquid Temperature : 22.5 °C

DASY4 Configuration:

- Probe: ET3DV6R - SN1788; ConvF(5.96, 5.96, 5.96); Calibrated: 2012/10/23
- Sensor-Surface: 4mm (Mechanical Surface Detection)
- Electronics: DAE3 Sn577; Calibrated: 2013/5/8
- Phantom: SAM_Left; Type: SAM; Serial: TP-1150
- Measurement SW: DASY4, V4.7 Build 80; Postprocessing SW: SEMCAD, V1.8 Build 186

Ch4233/Area Scan (61x101x1): Measurement grid: dx=15mm, dy=15mm

Maximum value of SAR (interpolated) = 0.250 mW/g

Ch4233/Zoom Scan (5x5x7)/Cube 0: Measurement grid: dx=8mm, dy=8mm, dz=5mm

Reference Value = 16.9 V/m; Power Drift = -0.016 dB

Peak SAR (extrapolated) = 0.279 W/kg

SAR(1 g) = 0.237 mW/g; SAR(10 g) = 0.184 mW/g

Maximum value of SAR (measured) = 0.248 mW/g

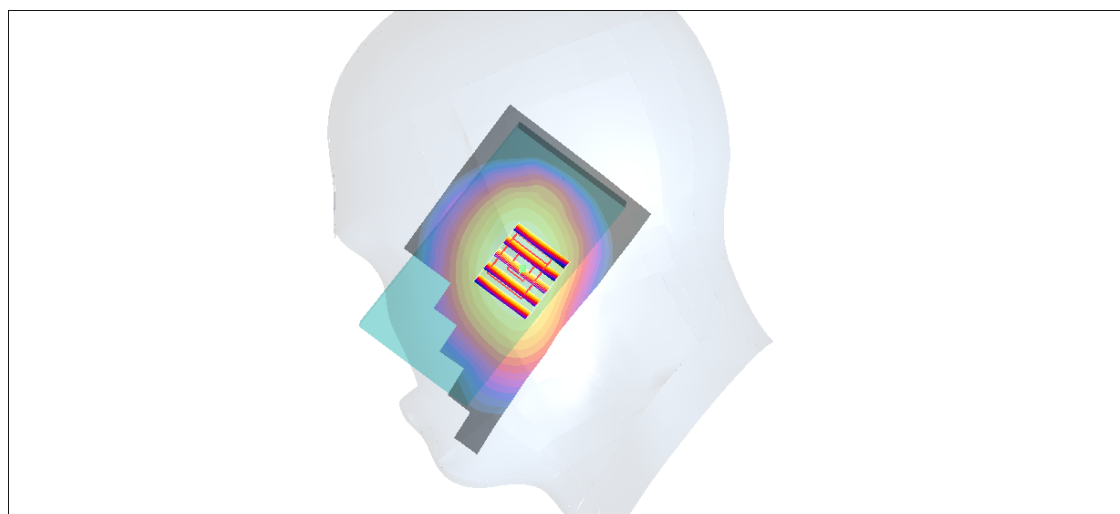
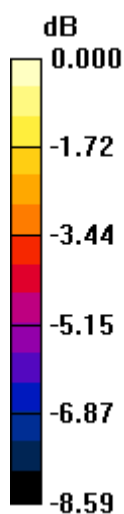

0 dB = 0.248mW/g

#63_WCDMA V_RMC12.2Kbps_Left Cheek_Ch4233

DUT: 370213

Communication System: WCDMA; Frequency: 846.6 MHz; Duty Cycle: 1:1

Medium: HSL_850_130710 Medium parameters used: $f = 847$ MHz; $\sigma = 0.936$ mho/m; $\epsilon_r = 43.2$; $\rho = 1000$ kg/m³

Ambient Temperature : 23.5 °C ; Liquid Temperature : 22.5 °C

DASY4 Configuration:

- Probe: ET3DV6R - SN1788; ConvF(5.96, 5.96, 5.96); Calibrated: 2012/10/23
- Sensor-Surface: 4mm (Mechanical Surface Detection)
- Electronics: DAE3 Sn577; Calibrated: 2013/5/8
- Phantom: SAM_Left; Type: SAM; Serial: TP-1150
- Measurement SW: DASY4, V4.7 Build 80; Postprocessing SW: SEMCAD, V1.8 Build 186

Ch4233/Area Scan (61x101x1): Measurement grid: dx=15mm, dy=15mm

Maximum value of SAR (interpolated) = 0.348 mW/g

Ch4233/Zoom Scan (5x5x7)/Cube 0: Measurement grid: dx=8mm, dy=8mm, dz=5mm

Reference Value = 20.0 V/m; Power Drift = -0.004 dB

Peak SAR (extrapolated) = 0.397 W/kg

SAR(1 g) = 0.331 mW/g; SAR(10 g) = 0.250 mW/g

Maximum value of SAR (measured) = 0.348 mW/g

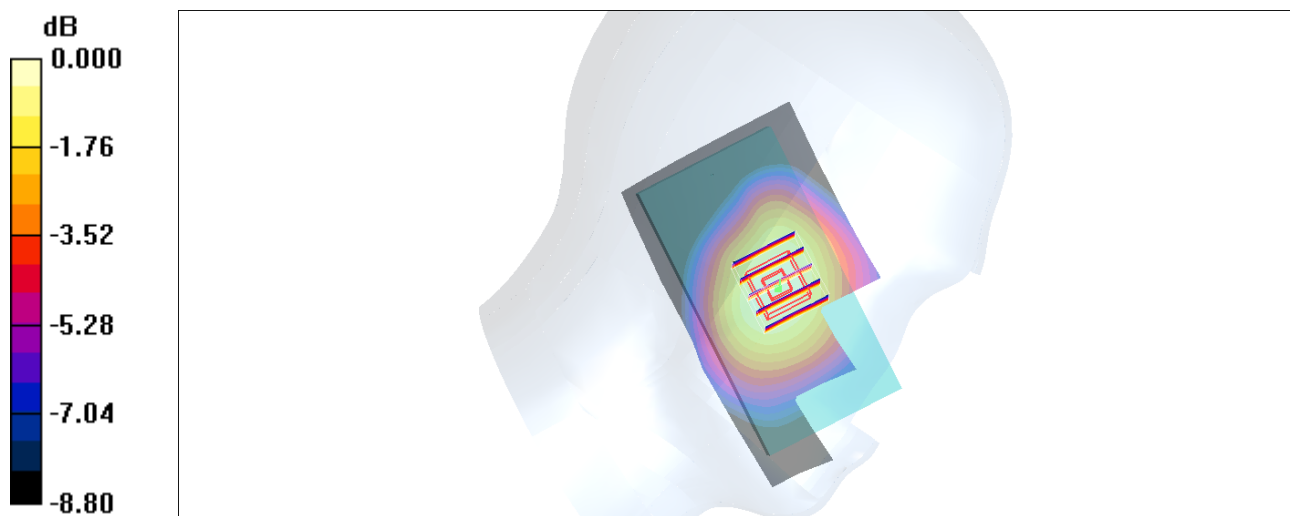

0 dB = 0.348mW/g

#64_WCDMA V_RMC12.2Kbps_Left Tilted_Ch4233

DUT: 370213

Communication System: WCDMA; Frequency: 846.6 MHz; Duty Cycle: 1:1

Medium: HSL_850_130710 Medium parameters used: $f = 847 \text{ MHz}$; $\sigma = 0.936 \text{ mho/m}$; $\epsilon_r = 43.2$; $\rho = 1000 \text{ kg/m}^3$

Ambient Temperature : $23.5 \text{ }^\circ\text{C}$; Liquid Temperature : $22.5 \text{ }^\circ\text{C}$

DASY4 Configuration:

- Probe: ET3DV6R - SN1788; ConvF(5.96, 5.96, 5.96); Calibrated: 2012/10/23
- Sensor-Surface: 4mm (Mechanical Surface Detection)
- Electronics: DAE3 Sn577; Calibrated: 2013/5/8
- Phantom: SAM_Left; Type: SAM; Serial: TP-1150
- Measurement SW: DASY4, V4.7 Build 80; Postprocessing SW: SEMCAD, V1.8 Build 186

Ch4233/Area Scan (61x101x1): Measurement grid: $dx=15\text{mm}$, $dy=15\text{mm}$

Maximum value of SAR (interpolated) = 0.218 mW/g

Ch4233/Zoom Scan (5x5x7)/Cube 0: Measurement grid: $dx=8\text{mm}$, $dy=8\text{mm}$, $dz=5\text{mm}$

Reference Value = 15.8 V/m ; Power Drift = 0.001 dB

Peak SAR (extrapolated) = 0.246 W/kg

SAR(1 g) = 0.208 mW/g ; SAR(10 g) = 0.162 mW/g

Maximum value of SAR (measured) = 0.217 mW/g

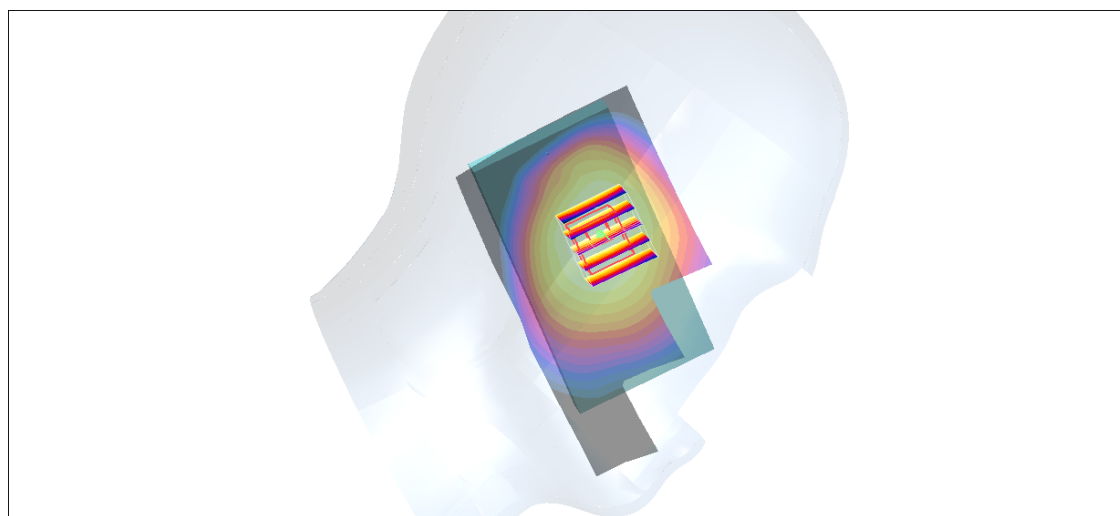
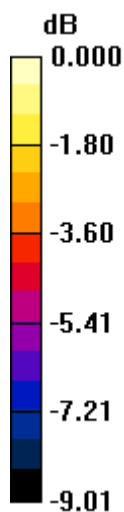

0 dB = 0.217 mW/g

#65_WCDMA II_RMC12.2Kbps_Right Cheek_Ch9400

DUT: 370213

Communication System: WCDMA; Frequency: 1880 MHz; Duty Cycle: 1:1

Medium: HSL_1900_130710 Medium parameters used: $f = 1880$ MHz; $\sigma = 1.43$ mho/m; $\epsilon_r = 38.6$; $\rho = 1000$ kg/m³

Ambient Temperature : 23.5 °C ; Liquid Temperature : 22.5 °C

DASY4 Configuration:

- Probe: ET3DV6R - SN1788; ConvF(4.65, 4.65, 4.65); Calibrated: 2012/10/23
- Sensor-Surface: 4mm (Mechanical Surface Detection)
- Electronics: DAE3 Sn577; Calibrated: 2013/5/8
- Phantom: SAM_Right; Type: SAM; Serial: TP-1303
- Measurement SW: DASY4, V4.7 Build 80; Postprocessing SW: SEMCAD, V1.8 Build 186

Ch9400/Area Scan (61x101x1): Measurement grid: dx=15mm, dy=15mm

Maximum value of SAR (interpolated) = 0.403 mW/g

Ch9400/Zoom Scan (5x5x7)/Cube 0: Measurement grid: dx=8mm, dy=8mm, dz=5mm

Reference Value = 17.4 V/m; Power Drift = 0.040 dB

Peak SAR (extrapolated) = 0.465 W/kg

SAR(1 g) = 0.355 mW/g; SAR(10 g) = 0.236 mW/g

Maximum value of SAR (measured) = 0.380 mW/g

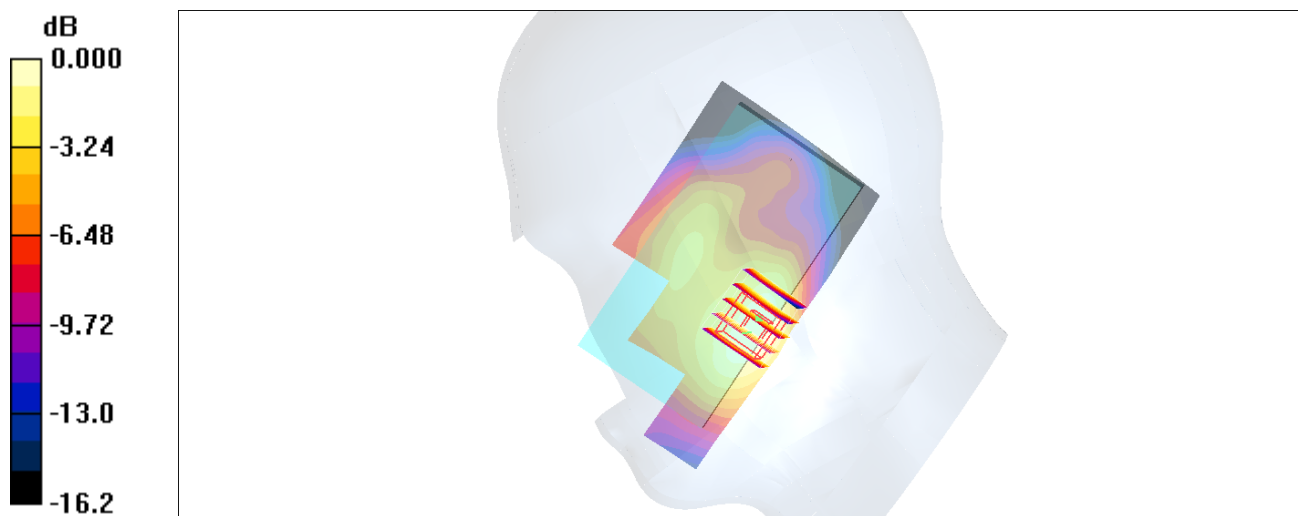

0 dB = 0.380mW/g

#66_WCDMA II_RMC12.2Kbps_Right Tilted_Ch9400**DUT: 370213**

Communication System: WCDMA; Frequency: 1880 MHz; Duty Cycle: 1:1

Medium: HSL_1900_130710 Medium parameters used: $f = 1880$ MHz; $\sigma = 1.43$ mho/m; $\epsilon_r = 38.6$; $\rho = 1000$ kg/m³

Ambient Temperature : 23.5 °C ; Liquid Temperature : 22.5 °C

DASY4 Configuration:

- Probe: ET3DV6R - SN1788; ConvF(4.65, 4.65, 4.65); Calibrated: 2012/10/23
- Sensor-Surface: 4mm (Mechanical Surface Detection)
- Electronics: DAE3 Sn577; Calibrated: 2013/5/8
- Phantom: SAM_Right; Type: SAM; Serial: TP-1303
- Measurement SW: DASY4, V4.7 Build 80; Postprocessing SW: SEMCAD, V1.8 Build 186

Ch9400/Area Scan (61x101x1): Measurement grid: dx=15mm, dy=15mm

Maximum value of SAR (interpolated) = 0.201 mW/g

Ch9400/Zoom Scan (5x5x7)/Cube 0: Measurement grid: dx=8mm, dy=8mm, dz=5mm

Reference Value = 12.5 V/m; Power Drift = -0.005 dB

Peak SAR (extrapolated) = 0.246 W/kg

SAR(1 g) = 0.177 mW/g; SAR(10 g) = 0.109 mW/g

Maximum value of SAR (measured) = 0.193 mW/g

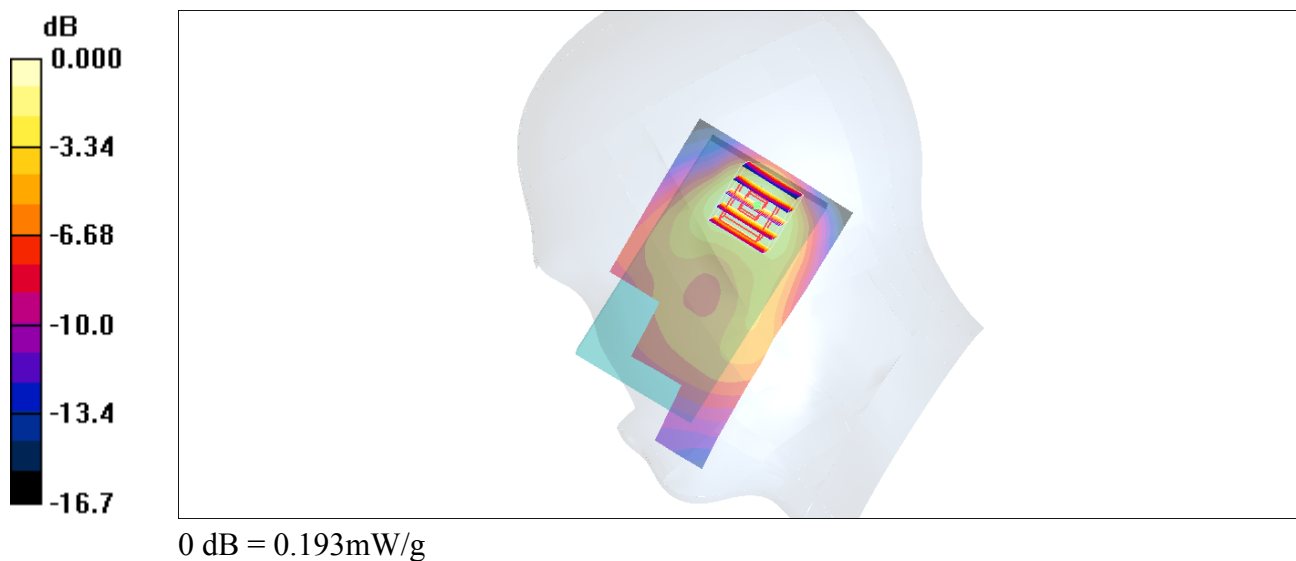

#67_WCDMA II_RMC12.2Kbps_Left Cheek_Ch9400**DUT: 370213**

Communication System: WCDMA; Frequency: 1880 MHz; Duty Cycle: 1:1

Medium: HSL_1900_130710 Medium parameters used: $f = 1880$ MHz; $\sigma = 1.43$ mho/m; $\epsilon_r = 38.6$; $\rho = 1000$ kg/m³

Ambient Temperature : 23.5 °C; Liquid Temperature : 22.5 °C

DASY4 Configuration:

- Probe: ET3DV6R - SN1788; ConvF(4.65, 4.65, 4.65); Calibrated: 2012/10/23
- Sensor-Surface: 4mm (Mechanical Surface Detection)
- Electronics: DAE3 Sn577; Calibrated: 2013/5/8
- Phantom: SAM_Right; Type: SAM; Serial: TP-1303
- Measurement SW: DASY4, V4.7 Build 80; Postprocessing SW: SEMCAD, V1.8 Build 186

Ch9400/Area Scan (61x101x1): Measurement grid: dx=15mm, dy=15mm

Maximum value of SAR (interpolated) = 0.390 mW/g

Ch9400/Zoom Scan (5x5x7)/Cube 0: Measurement grid: dx=8mm, dy=8mm, dz=5mm

Reference Value = 18.4 V/m; Power Drift = 0.043 dB

Peak SAR (extrapolated) = 0.562 W/kg

SAR(1 g) = 0.384 mW/g; SAR(10 g) = 0.238 mW/g

Maximum value of SAR (measured) = 0.418 mW/g

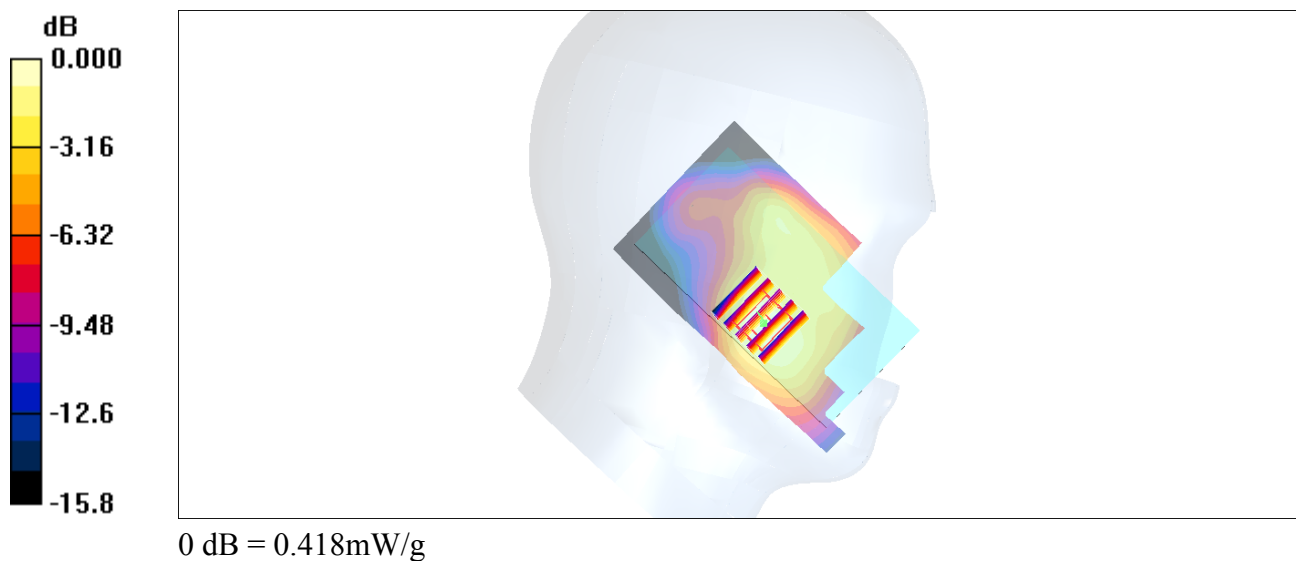

#68_WCDMA II_RMC12.2Kbps_Left Tilted_Ch9400**DUT: 370213**

Communication System: WCDMA; Frequency: 1880 MHz; Duty Cycle: 1:1

Medium: HSL_1900_130710 Medium parameters used: $f = 1880$ MHz; $\sigma = 1.43$ mho/m; $\epsilon_r = 38.6$; $\rho = 1000$ kg/m³

Ambient Temperature : 23.5 °C ; Liquid Temperature : 22.5 °C

DASY4 Configuration:

- Probe: ET3DV6R - SN1788; ConvF(4.65, 4.65, 4.65); Calibrated: 2012/10/23
- Sensor-Surface: 4mm (Mechanical Surface Detection)
- Electronics: DAE3 Sn577; Calibrated: 2013/5/8
- Phantom: SAM_Right; Type: SAM; Serial: TP-1303
- Measurement SW: DASY4, V4.7 Build 80; Postprocessing SW: SEMCAD, V1.8 Build 186

Ch9400/Area Scan (61x101x1): Measurement grid: dx=15mm, dy=15mm

Maximum value of SAR (interpolated) = 0.221 mW/g

Ch9400/Zoom Scan (5x5x7)/Cube 0: Measurement grid: dx=8mm, dy=8mm, dz=5mm

Reference Value = 12.9 V/m; Power Drift = -0.154 dB

Peak SAR (extrapolated) = 0.258 W/kg

SAR(1 g) = 0.183 mW/g; SAR(10 g) = 0.115 mW/g

Maximum value of SAR (measured) = 0.200 mW/g

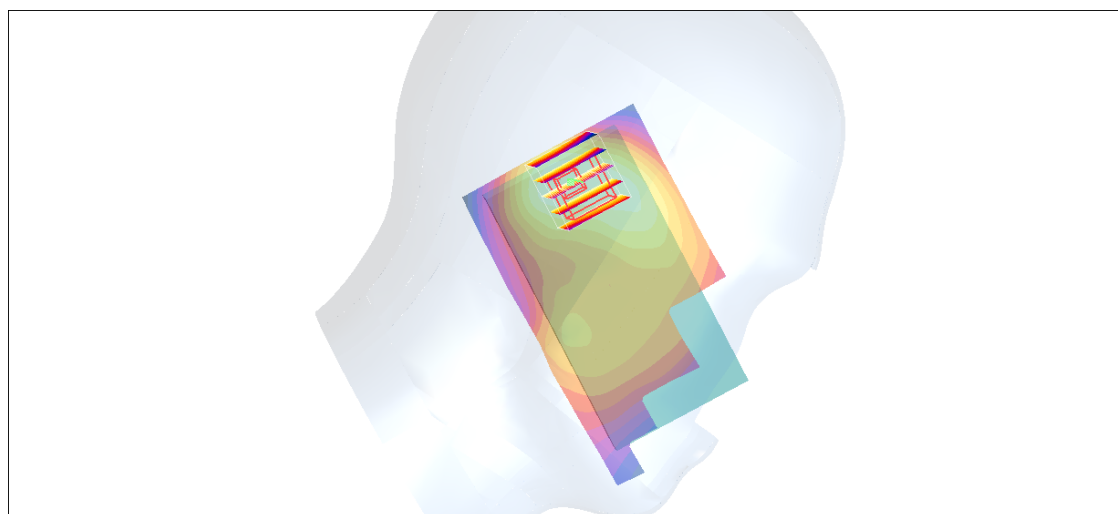
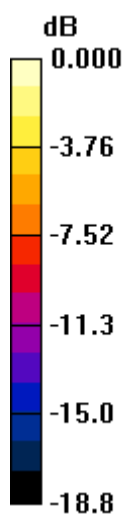

0 dB = 0.200mW/g

#79_WLAN2.4GHz_802.11b 1Mbps_Right Cheek_Ch6

DUT: 370213

Communication System: 802.11b; Frequency: 2437 MHz; Duty Cycle: 1:1

Medium: HSL_2450_130711 Medium parameters used: $f = 2437$ MHz; $\sigma = 1.841$ mho/m; $\epsilon_r = 39.282$; ρ

$= 1000$ kg/m³

Ambient Temperature : 23.5 °C; Liquid Temperature : 22.5 °C

DASY5 Configuration:

- Probe: ES3DV3 - SN3270; ConvF(4.45, 4.45, 4.45); Calibrated: 2012/9/28;
- Sensor-Surface: 3mm (Mechanical Surface Detection)
- Electronics: DAE4 Sn778; Calibrated: 2012/8/27
- Phantom: SAM Left; Type: QD000P40CD; Serial: TP:1542
- Measurement SW: DASY52, Version 52.8 (3); SEMCAD X Version 14.6.5 (6469)

Configuration/Ch6/Area Scan (71x141x1): Measurement grid: dx=12mm, dy=12mm

Maximum value of SAR (interpolated) = 0.542 mW/g

Configuration/Ch6/Zoom Scan (7x7x7)/Cube 0: Measurement grid: dx=5mm, dy=5mm, dz=5mm

Reference Value = 17.862 V/m; Power Drift = 0.151 dB

Peak SAR (extrapolated) = 0.949 mW/g

SAR(1 g) = 0.479 mW/g; SAR(10 g) = 0.238 mW/g

Maximum value of SAR (measured) = 0.618 mW/g

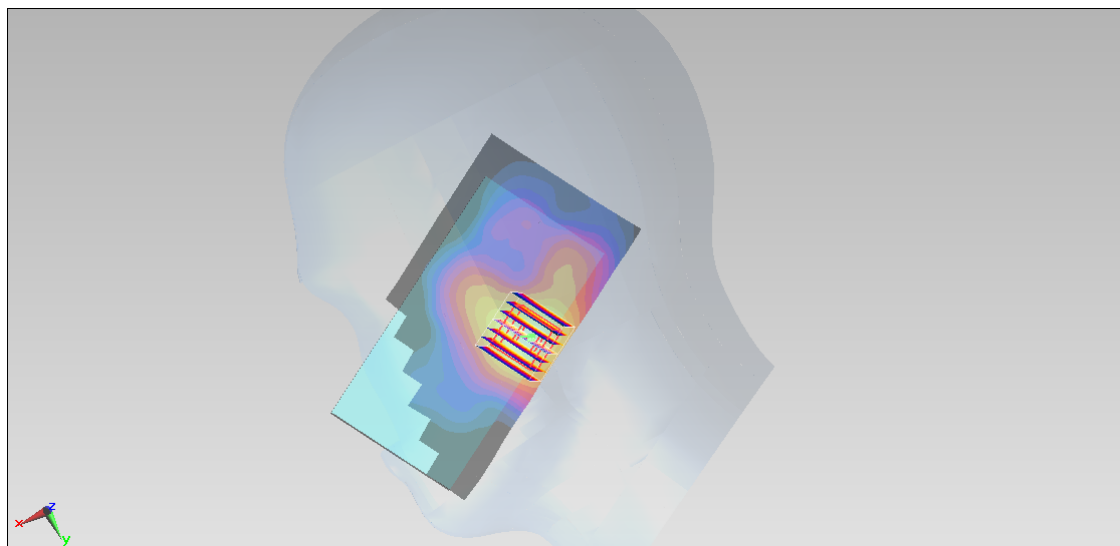
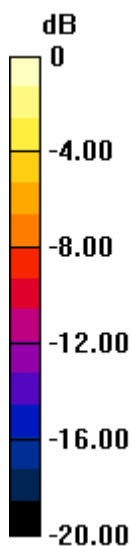

0 dB = 0.618 mW/g = -4.18 dB mW/g

#80_WLAN2.4GHz_802.11b 1Mbps_Right Tilted_Ch6

DUT: 370213

Communication System: 802.11b; Frequency: 2437 MHz; Duty Cycle: 1:1

Medium: HSL_2450_130711 Medium parameters used: $f = 2437$ MHz; $\sigma = 1.841$ mho/m; $\epsilon_r = 39.282$; ρ

$= 1000$ kg/m³

Ambient Temperature : 23.5 °C; Liquid Temperature : 22.5 °C

DASY5 Configuration:

- Probe: ES3DV3 - SN3270; ConvF(4.45, 4.45, 4.45); Calibrated: 2012/9/28;
- Sensor-Surface: 3mm (Mechanical Surface Detection)
- Electronics: DAE4 Sn778; Calibrated: 2012/8/27
- Phantom: SAM Left; Type: QD000P40CD; Serial: TP:1542
- Measurement SW: DASY52, Version 52.8 (3); SEMCAD X Version 14.6.5 (6469)

Configuration/Ch6/Area Scan (71x141x1): Measurement grid: dx=12mm, dy=12mm
Maximum value of SAR (interpolated) = 0.126 mW/g

Configuration/Ch6/Zoom Scan (7x7x7)/Cube 0: Measurement grid: dx=5mm, dy=5mm, dz=5mm

Reference Value = 8.597 V/m; Power Drift = -0.00 dB

Peak SAR (extrapolated) = 0.187 mW/g

SAR(1 g) = 0.101 mW/g; SAR(10 g) = 0.052 mW/g

Maximum value of SAR (measured) = 0.127 mW/g

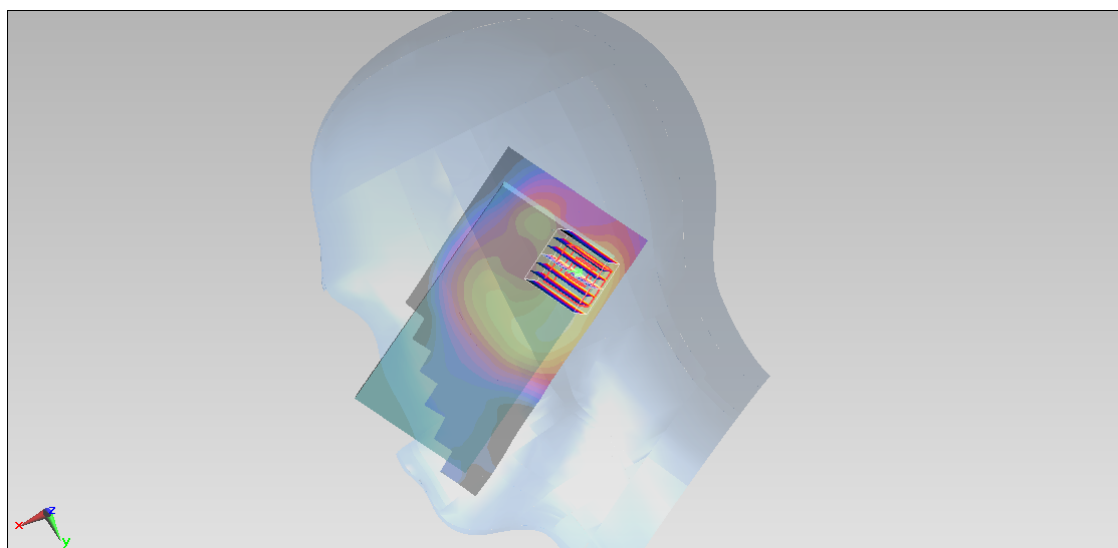
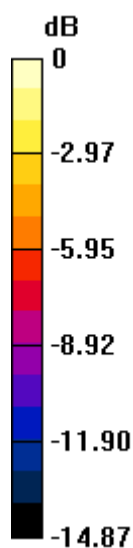

0 dB = 0.127 mW/g = -17.92 dB mW/g

#81_WLAN2.4GHz_802.11b 1Mbps_Left Cheek_Ch6

DUT: 370213

Communication System: 802.11b; Frequency: 2437 MHz; Duty Cycle: 1:1

Medium: HSL_2450_130711 Medium parameters used: $f = 2437$ MHz; $\sigma = 1.841$ mho/m; $\epsilon_r = 39.282$; ρ

$= 1000$ kg/m³

Ambient Temperature : 23.5 °C ; Liquid Temperature : 22.5 °C

DASY5 Configuration:

- Probe: ES3DV3 - SN3270; ConvF(4.45, 4.45, 4.45); Calibrated: 2012/9/28;
- Sensor-Surface: 3mm (Mechanical Surface Detection)
- Electronics: DAE4 Sn778; Calibrated: 2012/8/27
- Phantom: SAM Left; Type: QD000P40CD; Serial: TP:1542
- Measurement SW: DASY52, Version 52.8 (3); SEMCAD X Version 14.6.5 (6469)

Configuration/Ch6/Area Scan (71x141x1): Measurement grid: dx=12mm, dy=12mm

Maximum value of SAR (interpolated) = 0.644 mW/g

Configuration/Ch6/Zoom Scan (7x7x7)/Cube 0: Measurement grid: dx=5mm, dy=5mm, dz=5mm

Reference Value = 20.485 V/m; Power Drift = 0.17 dB

Peak SAR (extrapolated) = 1.296 mW/g

SAR(1 g) = 0.562 mW/g; SAR(10 g) = 0.255 mW/g

Maximum value of SAR (measured) = 0.746 mW/g

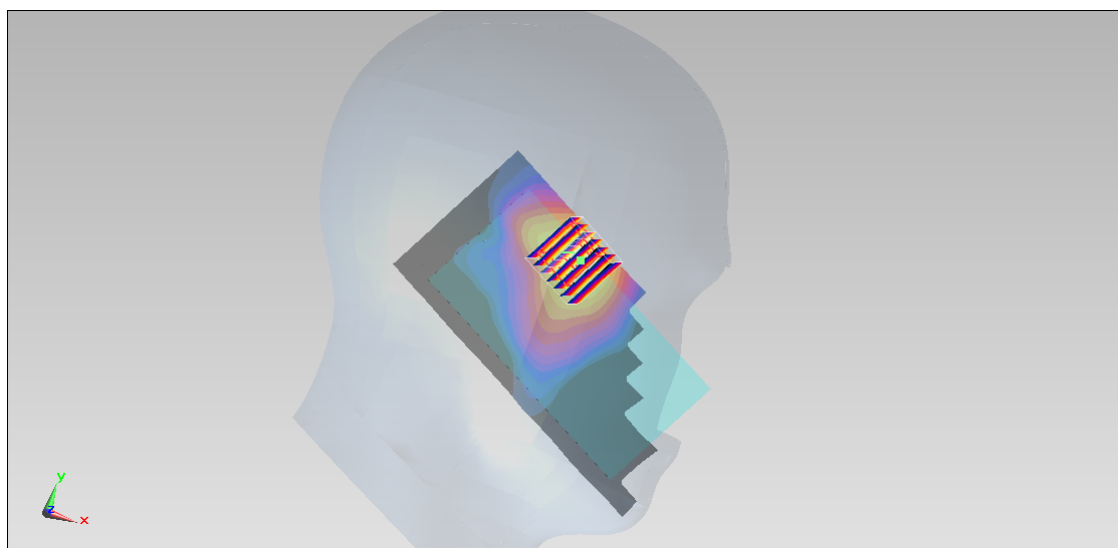
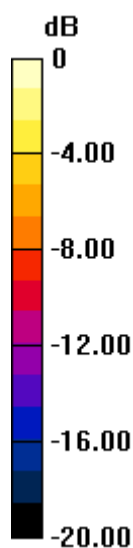

0 dB = 0.746 mW/g = -2.55 dB mW/g

#82_WLAN2.4GHz_802.11b 1Mbps_Left Tilted_Ch6

DUT: 370213

Communication System: 802.11b; Frequency: 2437 MHz; Duty Cycle: 1:1

Medium: HSL_2450_130711 Medium parameters used: $f = 2437$ MHz; $\sigma = 1.841$ mho/m; $\epsilon_r = 39.282$; ρ

$= 1000$ kg/m³

Ambient Temperature : 23.5 °C ; Liquid Temperature : 22.5 °C

DASY5 Configuration:

- Probe: ES3DV3 - SN3270; ConvF(4.45, 4.45, 4.45); Calibrated: 2012/9/28;
- Sensor-Surface: 3mm (Mechanical Surface Detection)
- Electronics: DAE4 Sn778; Calibrated: 2012/8/27
- Phantom: SAM Left; Type: QD000P40CD; Serial: TP:1542
- Measurement SW: DASY52, Version 52.8 (3); SEMCAD X Version 14.6.5 (6469)

Configuration/Ch6/Area Scan (71x141x1): Measurement grid: dx=12mm, dy=12mm
Maximum value of SAR (interpolated) = 0.178 mW/g

Configuration/Ch6/Zoom Scan (7x7x7)/Cube 0: Measurement grid: dx=5mm, dy=5mm, dz=5mm

Reference Value = 9.685 V/m; Power Drift = 0.16 dB

Peak SAR (extrapolated) = 0.341 mW/g

SAR(1 g) = 0.168 mW/g; SAR(10 g) = 0.079 mW/g

Maximum value of SAR (measured) = 0.220 mW/g

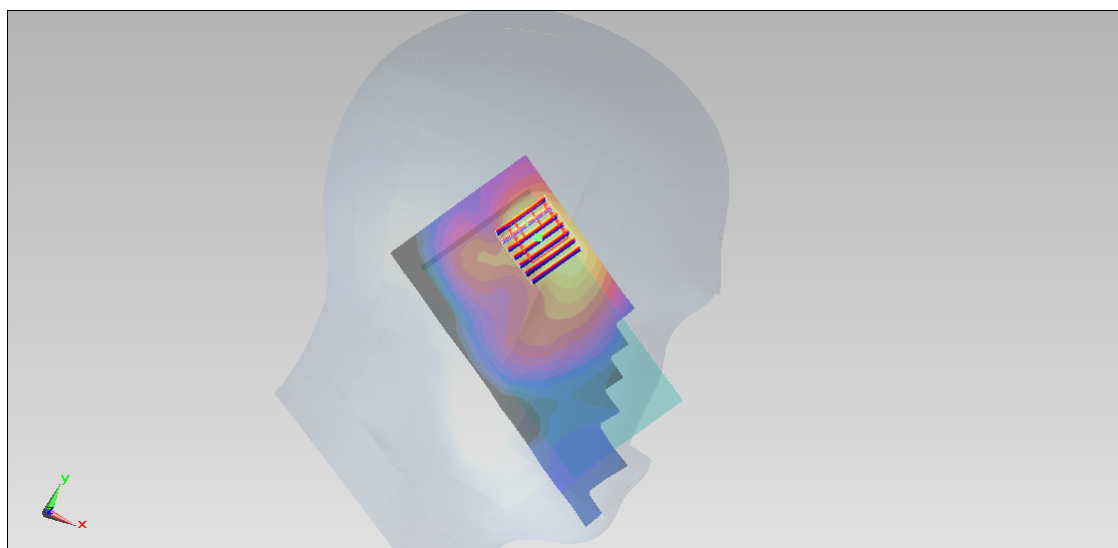
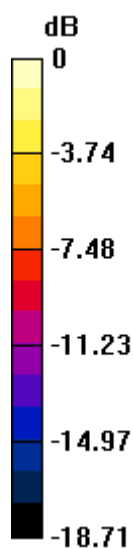

0 dB = 0.220 mW/g = -13.15 dB mW/g

#32_GSM850_GPRS (4 Tx slots)_Front_1cm_Ch251**DUT: 370213**

Communication System: GSM850; Frequency: 848.8 MHz; Duty Cycle: 1:2

Medium: MSL_850_130709 Medium parameters used: $f = 849$ MHz; $\sigma = 0.977$ mho/m; $\epsilon_r = 54.4$; $\rho = 1000$ kg/m³

Ambient Temperature : 23.3 °C ; Liquid Temperature : 22.3 °C

DASY4 Configuration:

- Probe: ET3DV6R - SN1788; ConvF(5.92, 5.92, 5.92); Calibrated: 2012/10/23
- Sensor-Surface: 4mm (Mechanical Surface Detection)
- Electronics: DAE3 Sn577; Calibrated: 2013/5/8
- Phantom: SAM_Right; Type: SAM; Serial: TP-1303
- Measurement SW: DASY4, V4.7 Build 80; Postprocessing SW: SEMCAD, V1.8 Build 186

Ch251/Area Scan (71x111x1): Measurement grid: dx=15mm, dy=15mm

Maximum value of SAR (interpolated) = 0.506 mW/g

Ch251/Zoom Scan (5x5x7)/Cube 0: Measurement grid: dx=8mm, dy=8mm, dz=5mm

Reference Value = 23.4 V/m; Power Drift = 0.034 dB

Peak SAR (extrapolated) = 0.563 W/kg

SAR(1 g) = 0.478 mW/g; SAR(10 g) = 0.367 mW/g

Maximum value of SAR (measured) = 0.506 mW/g

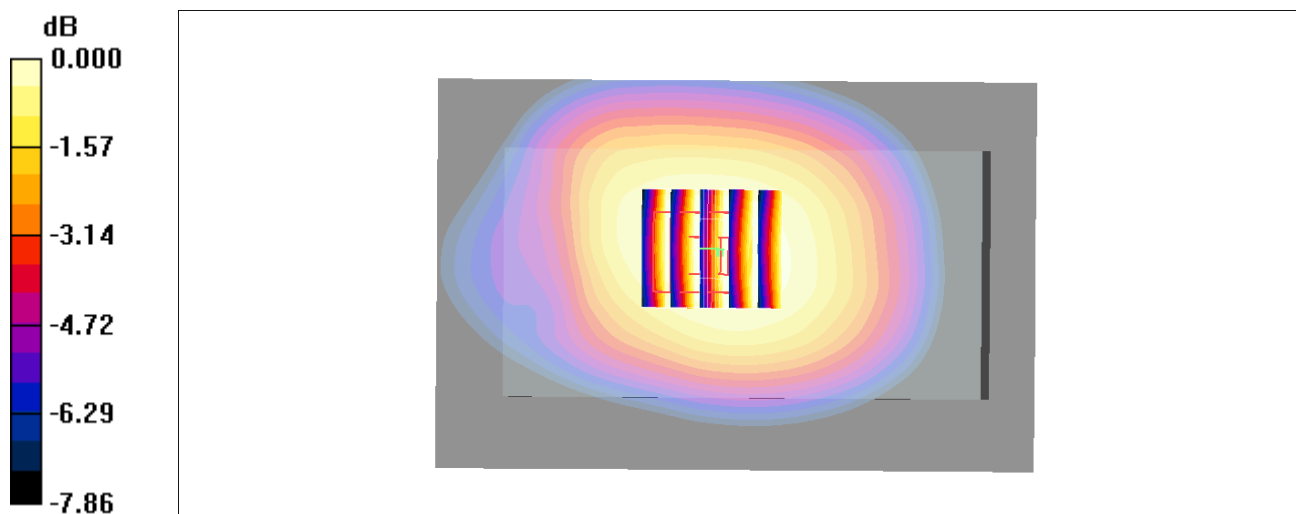

0 dB = 0.506mW/g

#33_GSM850_GPRS (4 Tx slots)_Back_1cm_Ch251

DUT: 370213

Communication System: GSM850; Frequency: 848.8 MHz; Duty Cycle: 1:2

Medium: MSL_850_130802 Medium parameters used: $f = 849$ MHz; $\sigma = 0.995$ mho/m; $\epsilon_r = 55.271$; $\rho =$

1000 kg/m³

Ambient Temperature : 23.5 °C ; Liquid Temperature : 22.5 °C

DASY5 Configuration:

- Probe: EX3DV4 - SN3792; ConvF(9.15, 9.15, 9.15); Calibrated: 2013/6/4;
- Sensor-Surface: 2mm (Mechanical Surface Detection)
- Electronics: DAE4 Sn1338; Calibrated: 2013/5/28
- Phantom: SAM Left; Type: QD000P40CD; Serial: TP:1542
- Measurement SW: DASY52, Version 52.8 (3); SEMCAD X Version 14.6.5 (6469)

Configuration/Ch251/Area Scan (61x101x1): Measurement grid: dx=15mm, dy=15mm
Maximum value of SAR (interpolated) = 1.07 mW/g

Configuration/Ch251/Zoom Scan (5x5x7)/Cube 0: Measurement grid: dx=8mm, dy=8mm, dz=5mm

Reference Value = 34.205 V/m; Power Drift = -0.03 dB

Peak SAR (extrapolated) = 1.362 mW/g

SAR(1 g) = 0.739 mW/g; SAR(10 g) = 0.425 mW/g

Maximum value of SAR (measured) = 1.06 mW/g

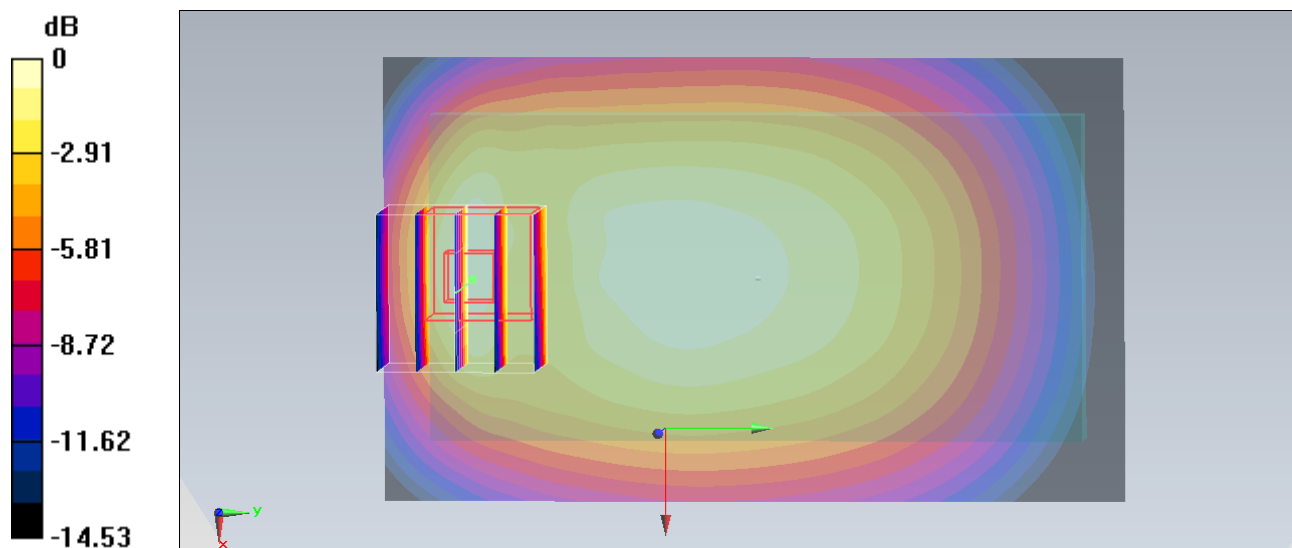

0 dB = 1.06 mW/g = 0.51 dB mW/g

#38_GSM850_GPRS (4 Tx slots)_Back_1cm_Ch128

DUT: 370213

Communication System: GSM850; Frequency: 824.2 MHz; Duty Cycle: 1:2

Medium: MSL_850_130802 Medium parameters used: $f = 824.2$ MHz; $\sigma = 0.971$ mho/m; $\epsilon_r = 55.411$; ρ

$= 1000$ kg/m³

Ambient Temperature : 23.5 °C; Liquid Temperature : 22.5 °C

DASY5 Configuration:

- Probe: EX3DV4 - SN3792; ConvF(9.15, 9.15, 9.15); Calibrated: 2013/6/4;
- Sensor-Surface: 2mm (Mechanical Surface Detection)
- Electronics: DAE4 Sn1338; Calibrated: 2013/5/28
- Phantom: SAM Left; Type: QD000P40CD; Serial: TP:1542
- Measurement SW: DASY52, Version 52.8 (3); SEMCAD X Version 14.6.5 (6469)

Configuration/Ch128/Area Scan (61x101x1): Measurement grid: dx=15mm, dy=15mm
 Maximum value of SAR (interpolated) = 1.20 mW/g

Configuration/Ch128/Zoom Scan (5x5x7)/Cube 0: Measurement grid: dx=8mm, dy=8mm, dz=5mm

Reference Value = 36.354 V/m; Power Drift = -0.02 dB

Peak SAR (extrapolated) = 1.294 mW/g

SAR(1 g) = 0.937 mW/g; SAR(10 g) = 0.767 mW/g

Maximum value of SAR (measured) = 1.17 mW/g

Configuration/Ch128/Zoom Scan (5x5x7)/Cube 1: Measurement grid: dx=8mm, dy=8mm, dz=5mm

Reference Value = 36.354 V/m; Power Drift = -0.02 dB

Peak SAR (extrapolated) = 1.548 mW/g

SAR(1 g) = 0.863 mW/g; SAR(10 g) = 0.507 mW/g

Maximum value of SAR (measured) = 1.21 mW/g

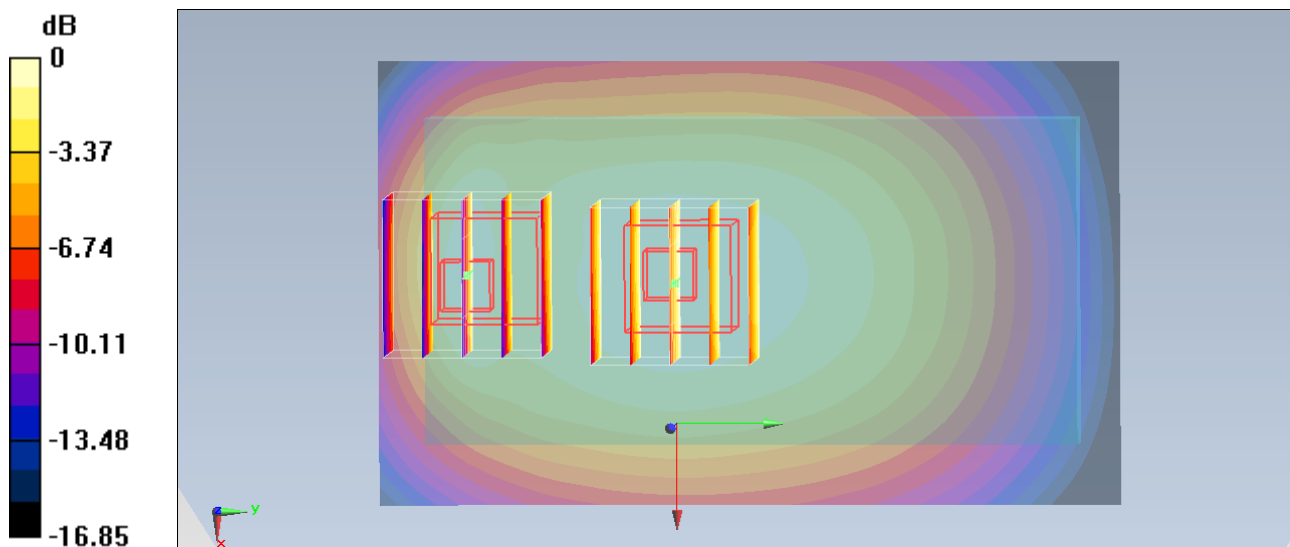

0 dB = 1.21 mW/g = 1.66 dB mW/g

#39_GSM850_GPRS (4 Tx slots)_Back_1cm_Ch189

DUT: 370213

Communication System: GSM850; Frequency: 836.4 MHz; Duty Cycle: 1:2

Medium: MSL_850_130802 Medium parameters used: $f = 836.4$ MHz; $\sigma = 0.983$ S/m; $\epsilon_r = 55.343$; $\rho =$

1000 kg/m³

Ambient Temperature : 23.5 °C ; Liquid Temperature : 22.5 °C

DASY5 Configuration:

- Probe: EX3DV4 - SN3792; ConvF(9.15, 9.15, 9.15); Calibrated: 2013/6/4;
- Sensor-Surface: 2mm (Mechanical Surface Detection)
- Electronics: DAE4 Sn1338; Calibrated: 2013/5/28
- Phantom: SAM Left; Type: QD000P40CD; Serial: TP:1542
- Measurement SW: DASY52, Version 52.8 (3); SEMCAD X Version 14.6.5 (6469)

Configuration/Ch189/Area Scan (61x101x1): Interpolated grid: dx=1.500 mm, dy=1.500 mm
 Maximum value of SAR (interpolated) = 1.18 W/kg

Configuration/Ch189/Zoom Scan (5x5x7)/Cube 0: Measurement grid: dx=8mm, dy=8mm, dz=5mm

Reference Value = 36.030 V/m; Power Drift = -0.04 dB

Peak SAR (extrapolated) = 1.24 W/kg

SAR(1 g) = 0.980 W/kg; SAR(10 g) = 0.735 W/kg

Maximum value of SAR (measured) = 1.12 W/kg

Configuration/Ch189/Zoom Scan (5x5x7)/Cube 1: Measurement grid: dx=8mm, dy=8mm, dz=5mm

Reference Value = 36.030 V/m; Power Drift = -0.04 dB

Peak SAR (extrapolated) = 1.52 W/kg

SAR(1 g) = 0.848 W/kg; SAR(10 g) = 0.490 W/kg

Maximum value of SAR (measured) = 1.20 W/kg

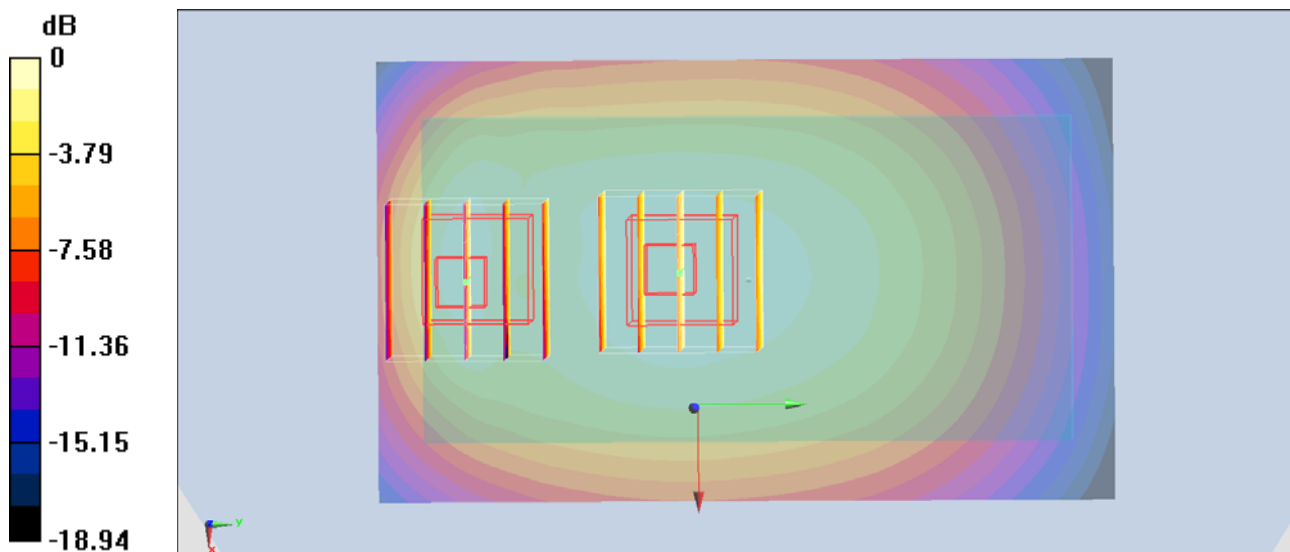

0 dB = 1.20 W/kg = 0.79 dBW/kg

#49_GSM850_GPRS (4 Tx slots)_Back_1cm_Ch189_Repeat

DUT: 370213

Communication System: GSM850; Frequency: 836.4 MHz; Duty Cycle: 1:2

Medium: MSL_850_130802 Medium parameters used: $f = 836.4$ MHz; $\sigma = 0.983$ S/m; $\epsilon_r = 55.343$; $\rho =$

1000 kg/m³

Ambient Temperature : 23.5 °C ; Liquid Temperature : 22.5 °C

DASY5 Configuration:

- Probe: EX3DV4 - SN3792; ConvF(9.15, 9.15, 9.15); Calibrated: 2013/6/4;
- Sensor-Surface: 2mm (Mechanical Surface Detection)
- Electronics: DAE4 Sn1338; Calibrated: 2013/5/28
- Phantom: SAM Left; Type: QD000P40CD; Serial: TP:1542
- Measurement SW: DASY52, Version 52.8 (3); SEMCAD X Version 14.6.5 (6469)

Configuration/Ch189/Area Scan (61x101x1): Interpolated grid: dx=1.500 mm, dy=1.500 mm
Maximum value of SAR (interpolated) = 1.40 W/kg

Configuration/Ch189/Zoom Scan (5x5x7)/Cube 0: Measurement grid: dx=8mm, dy=8mm, dz=5mm

Reference Value = 39.602 V/m; Power Drift = -0.03 dB

Peak SAR (extrapolated) = 1.52 W/kg

SAR(1 g) = 0.962 W/kg; SAR(10 g) = 0.702 W/kg

Maximum value of SAR (measured) = 1.36 W/kg

Configuration/Ch189/Zoom Scan (5x5x7)/Cube 1: Measurement grid: dx=8mm, dy=8mm, dz=5mm

Reference Value = 39.602 V/m; Power Drift = -0.03 dB

Peak SAR (extrapolated) = 1.94 W/kg

SAR(1 g) = 0.872 W/kg; SAR(10 g) = 0.460 W/kg

Maximum value of SAR (measured) = 1.45 W/kg

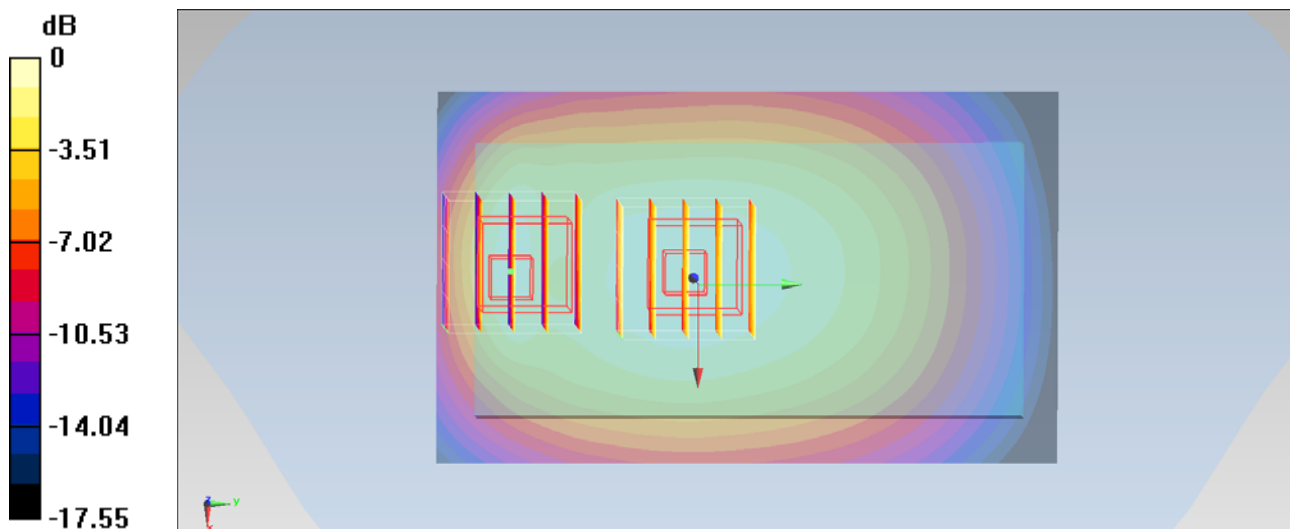

0 dB = 1.45 W/kg = 1.61 dBW/kg

#34_GSM850_GPRS (4 Tx slots)_Left Side_1cm_Ch251

DUT: 370213

Communication System: GSM850; Frequency: 848.8 MHz; Duty Cycle: 1:2

Medium: MSL_850_130709 Medium parameters used: $f = 849$ MHz; $\sigma = 0.977$ mho/m; $\epsilon_r = 54.4$; $\rho = 1000$ kg/m³

Ambient Temperature : 23.3 °C ; Liquid Temperature : 22.3 °C

DASY4 Configuration:

- Probe: ET3DV6R - SN1788; ConvF(5.92, 5.92, 5.92); Calibrated: 2012/10/23
- Sensor-Surface: 4mm (Mechanical Surface Detection)
- Electronics: DAE3 Sn577; Calibrated: 2013/5/8
- Phantom: SAM_Right; Type: SAM; Serial: TP-1303
- Measurement SW: DASY4, V4.7 Build 80; Postprocessing SW: SEMCAD, V1.8 Build 186

Ch251/Area Scan (31x111x1): Measurement grid: dx=15mm, dy=15mm

Maximum value of SAR (interpolated) = 0.369 mW/g

Ch251/Zoom Scan (5x5x7)/Cube 0: Measurement grid: dx=8mm, dy=8mm, dz=5mm

Reference Value = 20.1 V/m; Power Drift = 0.011 dB

Peak SAR (extrapolated) = 0.460 W/kg

SAR(1 g) = 0.344 mW/g; SAR(10 g) = 0.241 mW/g

Maximum value of SAR (measured) = 0.368 mW/g

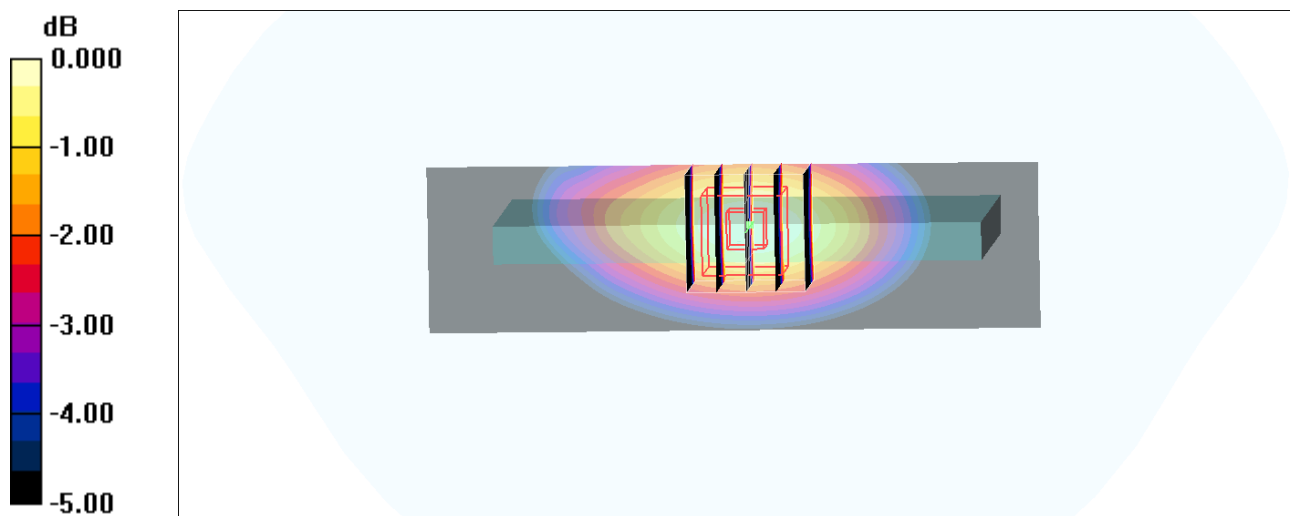

0 dB = 0.368mW/g

#35_GSM850_GPRS (4 Tx slots)_Right Side_1cm_Ch251**DUT: 370213**

Communication System: GSM850; Frequency: 848.8 MHz; Duty Cycle: 1:2

Medium: MSL_850_130709 Medium parameters used: $f = 849$ MHz; $\sigma = 0.977$ mho/m; $\epsilon_r = 54.4$; $\rho = 1000$ kg/m³

Ambient Temperature : 23.3 °C; Liquid Temperature : 22.3 °C

DASY4 Configuration:

- Probe: ET3DV6R - SN1788; ConvF(5.92, 5.92, 5.92); Calibrated: 2012/10/23
- Sensor-Surface: 4mm (Mechanical Surface Detection)
- Electronics: DAE3 Sn577; Calibrated: 2013/5/8
- Phantom: SAM_Right; Type: SAM; Serial: TP-1303
- Measurement SW: DASY4, V4.7 Build 80; Postprocessing SW: SEMCAD, V1.8 Build 186

Ch251/Area Scan (41x111x1): Measurement grid: dx=15mm, dy=15mm

Maximum value of SAR (interpolated) = 0.593 mW/g

Ch251/Zoom Scan (5x5x7)/Cube 0: Measurement grid: dx=8mm, dy=8mm, dz=5mm

Reference Value = 25.6 V/m; Power Drift = -0.126 dB

Peak SAR (extrapolated) = 0.732 W/kg

SAR(1 g) = 0.551 mW/g; SAR(10 g) = 0.390 mW/g

Maximum value of SAR (measured) = 0.585 mW/g

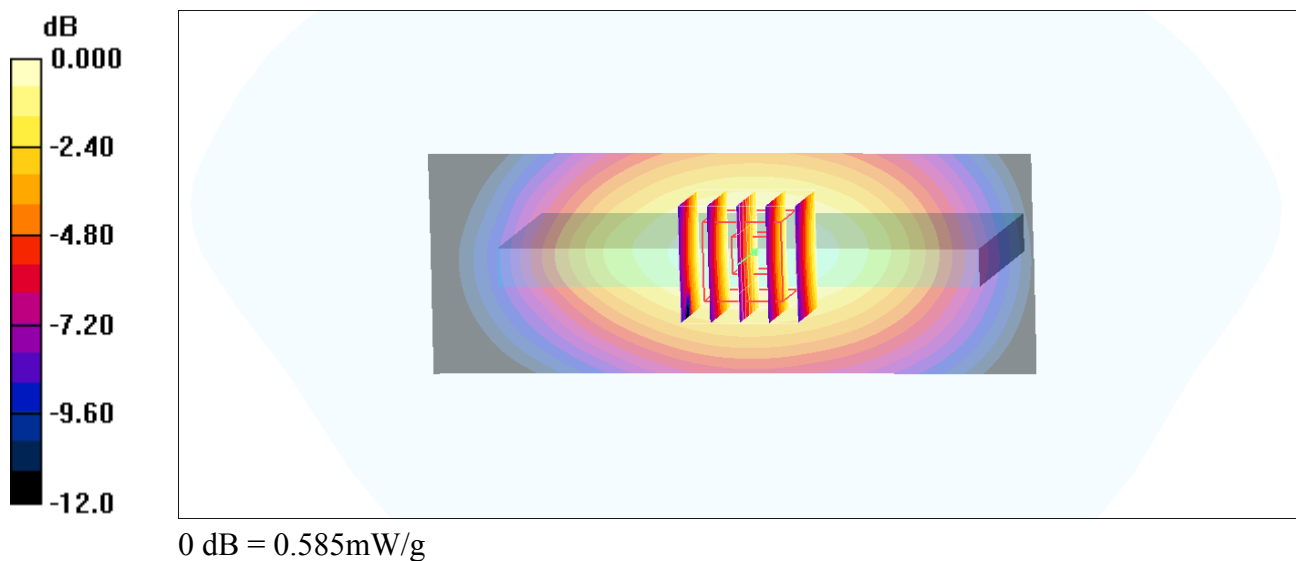

#37_GSM850_GPRS (4 Tx slots)_Bottom Side_1cm_Ch251

DUT: 370213

Communication System: GSM850; Frequency: 848.8 MHz; Duty Cycle: 1:2

Medium: MSL_850_130709 Medium parameters used: $f = 849$ MHz; $\sigma = 0.977$ mho/m; $\epsilon_r = 54.4$; $\rho = 1000$ kg/m³

Ambient Temperature : 23.3 °C ; Liquid Temperature : 22.3 °C

DASY4 Configuration:

- Probe: ET3DV6R - SN1788; ConvF(5.92, 5.92, 5.92); Calibrated: 2012/10/23
- Sensor-Surface: 4mm (Mechanical Surface Detection)
- Electronics: DAE3 Sn577; Calibrated: 2013/5/8
- Phantom: SAM_Right; Type: SAM; Serial: TP-1303
- Measurement SW: DASY4, V4.7 Build 80; Postprocessing SW: SEMCAD, V1.8 Build 186

Ch251/Area Scan (41x71x1): Measurement grid: dx=15mm, dy=15mm

Maximum value of SAR (interpolated) = 0.258 mW/g

Ch251/Zoom Scan (5x5x7)/Cube 0: Measurement grid: dx=8mm, dy=8mm, dz=5mm

Reference Value = 16.7 V/m; Power Drift = -0.002 dB

Peak SAR (extrapolated) = 0.373 W/kg

SAR(1 g) = 0.236 mW/g; SAR(10 g) = 0.140 mW/g

Maximum value of SAR (measured) = 0.262 mW/g

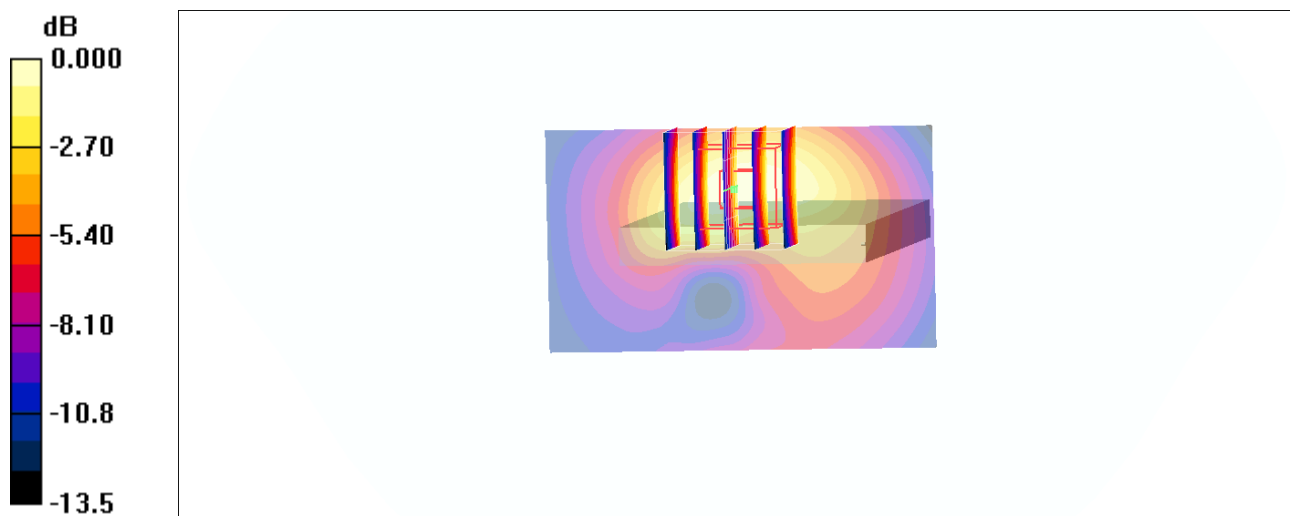

0 dB = 0.262mW/g

#40_GSM850_DTM Multi-slot class 11_Front_1cm_Ch251

DUT: 370213

Communication System: GSM850; Frequency: 848.8 MHz; Duty Cycle: 1:2.67

Medium: MSL_850_130709 Medium parameters used: $f = 849$ MHz; $\sigma = 0.977$ mho/m; $\epsilon_r = 54.4$; $\rho = 1000$ kg/m³

Ambient Temperature : 23.3 °C ; Liquid Temperature : 22.3 °C

DASY4 Configuration:

- Probe: ET3DV6R - SN1788; ConvF(5.92, 5.92, 5.92); Calibrated: 2012/10/23
- Sensor-Surface: 4mm (Mechanical Surface Detection)
- Electronics: DAE3 Sn577; Calibrated: 2013/5/8
- Phantom: SAM_Right; Type: SAM; Serial: TP-1303
- Measurement SW: DASY4, V4.7 Build 80; Postprocessing SW: SEMCAD, V1.8 Build 186

Ch251/Area Scan (71x111x1): Measurement grid: dx=15mm, dy=15mm

Maximum value of SAR (interpolated) = 0.514 mW/g

Ch251/Zoom Scan (5x5x7)/Cube 0: Measurement grid: dx=8mm, dy=8mm, dz=5mm

Reference Value = 23.7 V/m; Power Drift = -0.095 dB

Peak SAR (extrapolated) = 0.582 W/kg

SAR(1 g) = 0.490 mW/g; SAR(10 g) = 0.378 mW/g

Maximum value of SAR (measured) = 0.512 mW/g

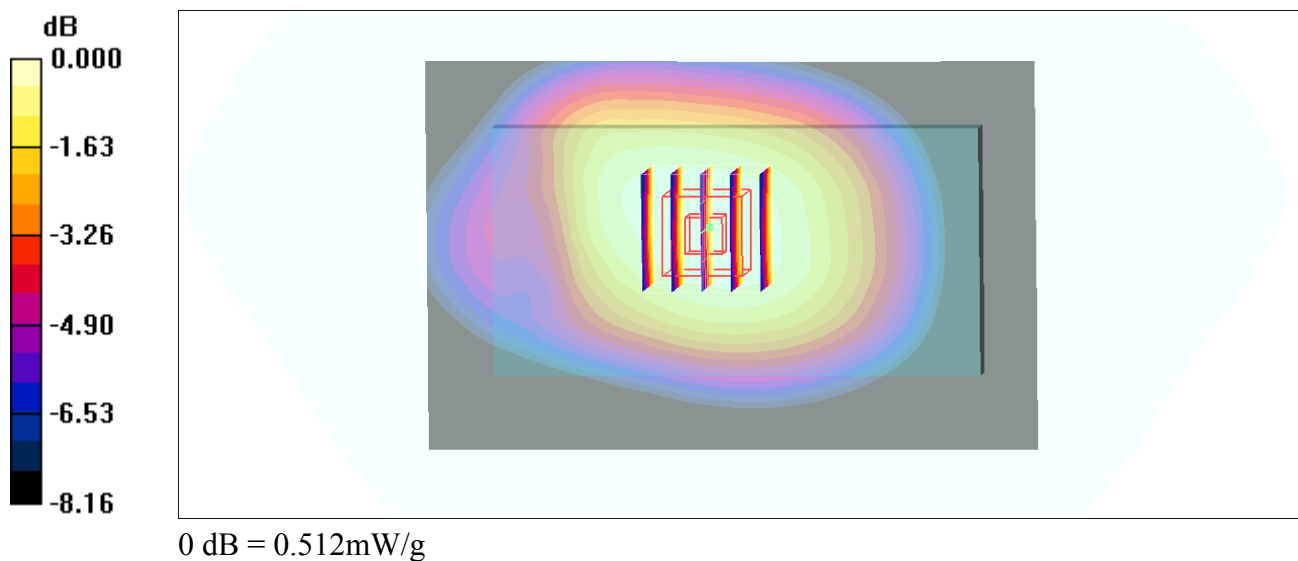

#41_GSM850_DTM Multi-slot class 11_Back_1cm_Ch251

DUT: 370213

Communication System: GSM850; Frequency: 848.8 MHz; Duty Cycle: 1:2.67

Medium: MSL_850_130802 Medium parameters used: $f = 849$ MHz; $\sigma = 0.995$ mho/m; $\epsilon_r = 55.271$; $\rho =$

1000 kg/m³

Ambient Temperature : 23.5 °C ; Liquid Temperature : 22.5 °C

DASY5 Configuration:

- Probe: EX3DV4 - SN3792; ConvF(9.15, 9.15, 9.15); Calibrated: 2013/6/4;
- Sensor-Surface: 2mm (Mechanical Surface Detection)
- Electronics: DAE4 Sn1338; Calibrated: 2013/5/28
- Phantom: SAM Left; Type: QD000P40CD; Serial: TP:1542
- Measurement SW: DASY52, Version 52.8 (3); SEMCAD X Version 14.6.5 (6469)

Configuration/Ch251/Area Scan (61x101x1): Measurement grid: dx=15mm, dy=15mm
 Maximum value of SAR (interpolated) = 0.949 mW/g

Configuration/Ch251/Zoom Scan (5x5x7)/Cube 0: Measurement grid: dx=8mm, dy=8mm, dz=5mm

Reference Value = 32.208 V/m; Power Drift = -0.04 dB

Peak SAR (extrapolated) = 1.250 mW/g

SAR(1 g) = 0.684 mW/g; SAR(10 g) = 0.385 mW/g

Maximum value of SAR (measured) = 0.970 mW/g

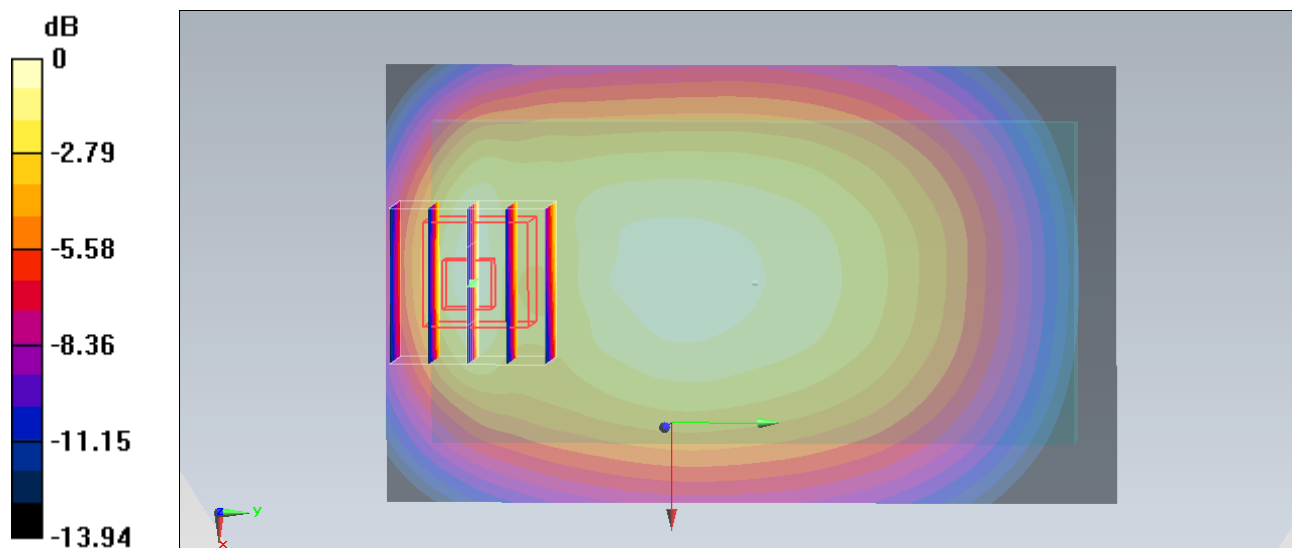

0 dB = 0.970 mW/g = -0.26 dB mW/g

#42_GSM850_DTM Multi-slot class 11_Back_1cm_Ch128

DUT: 370213

Communication System: GSM850; Frequency: 824.2 MHz; Duty Cycle: 1:2.67

Medium: MSL_850_130802 Medium parameters used: $f = 824.2$ MHz; $\sigma = 0.971$ mho/m; $\epsilon_r = 55.411$; ρ

$= 1000$ kg/m³

Ambient Temperature : 23.5 °C ; Liquid Temperature : 22.5 °C

DASY5 Configuration:

- Probe: EX3DV4 - SN3792; ConvF(9.15, 9.15, 9.15); Calibrated: 2013/6/4;
- Sensor-Surface: 2mm (Mechanical Surface Detection)
- Electronics: DAE4 Sn1338; Calibrated: 2013/5/28
- Phantom: SAM Left; Type: QD000P40CD; Serial: TP:1542
- Measurement SW: DASY52, Version 52.8 (3); SEMCAD X Version 14.6.5 (6469)

Configuration/Ch128/Area Scan (61x101x1): Measurement grid: dx=15mm, dy=15mm
Maximum value of SAR (interpolated) = 1.18 mW/g

Configuration/Ch128/Zoom Scan (5x5x7)/Cube 0: Measurement grid: dx=8mm, dy=8mm, dz=5mm

Reference Value = 34.892 V/m; Power Drift = 0.03 dB

Peak SAR (extrapolated) = 1.264 mW/g

SAR(1 g) = 0.916 mW/g; SAR(10 g) = 0.752 mW/g

Maximum value of SAR (measured) = 1.14 mW/g

Configuration/Ch128/Zoom Scan (5x5x7)/Cube 1: Measurement grid: dx=8mm, dy=8mm, dz=5mm

Reference Value = 34.892 V/m; Power Drift = 0.03 dB

Peak SAR (extrapolated) = 1.464 mW/g

SAR(1 g) = 0.817 mW/g; SAR(10 g) = 0.486 mW/g

Maximum value of SAR (measured) = 1.16 mW/g

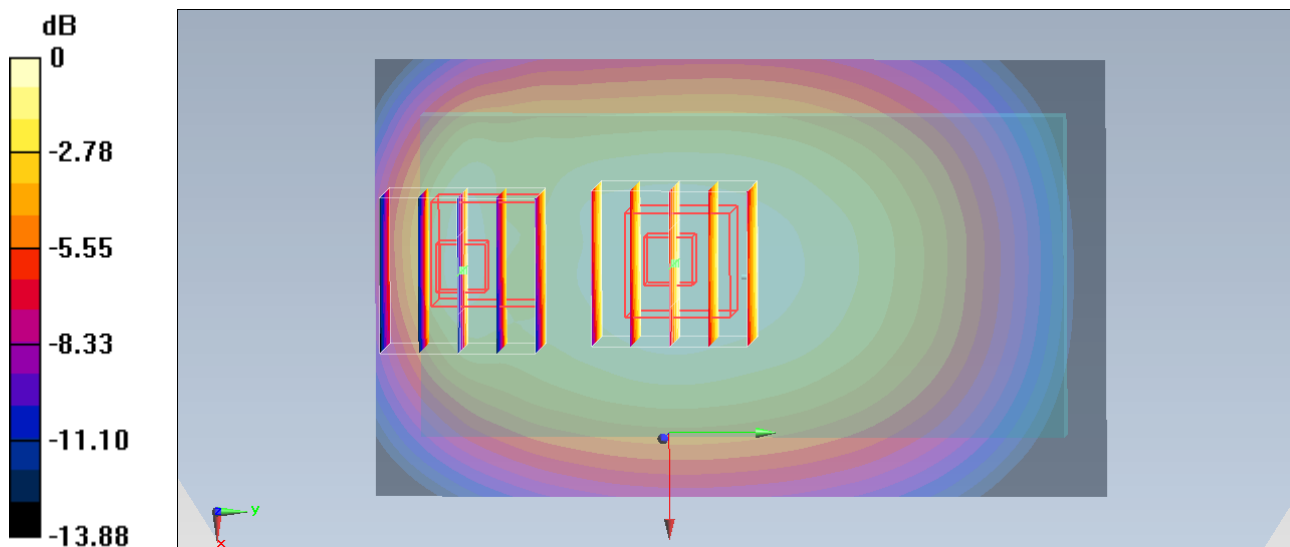

0 dB = 1.16 mW/g = 1.29 dB mW/g

#43_GSM850_DTM Multi-slot class 11_Back_1cm_Ch189

DUT: 370213

Communication System: GSM850; Frequency: 836.4 MHz; Duty Cycle: 1:2.67

Medium: MSL_850_130802 Medium parameters used: $f = 836.4$ MHz; $\sigma = 0.983$ mho/m; $\epsilon_r = 55.343$; ρ

$= 1000$ kg/m³

Ambient Temperature : 23.5 °C ; Liquid Temperature : 22.5 °C

DASY5 Configuration:

- Probe: EX3DV4 - SN3792; ConvF(9.15, 9.15, 9.15); Calibrated: 2013/6/4;
- Sensor-Surface: 2mm (Mechanical Surface Detection)
- Electronics: DAE4 Sn1338; Calibrated: 2013/5/28
- Phantom: SAM Left; Type: QD000P40CD; Serial: TP:1542
- Measurement SW: DASY52, Version 52.8 (3); SEMCAD X Version 14.6.5 (6469)

Configuration/Ch189/Area Scan (61x101x1): Measurement grid: dx=15mm, dy=15mm
 Maximum value of SAR (interpolated) = 1.13 mW/g

Configuration/Ch189/Zoom Scan (5x5x7)/Cube 0: Measurement grid: dx=8mm, dy=8mm, dz=5mm

Reference Value = 34.291 V/m; Power Drift = 0.02 dB

Peak SAR (extrapolated) = 1.230 mW/g

SAR(1 g) = 0.929 mW/g; SAR(10 g) = 0.733 mW/g

Maximum value of SAR (measured) = 1.11 mW/g

Configuration/Ch189/Zoom Scan (5x5x7)/Cube 1: Measurement grid: dx=8mm, dy=8mm, dz=5mm

Reference Value = 34.291 V/m; Power Drift = 0.02 dB

Peak SAR (extrapolated) = 2.739 mW/g

SAR(1 g) = 0.816 mW/g; SAR(10 g) = 0.472 mW/g

Maximum value of SAR (measured) = 1.14 mW/g

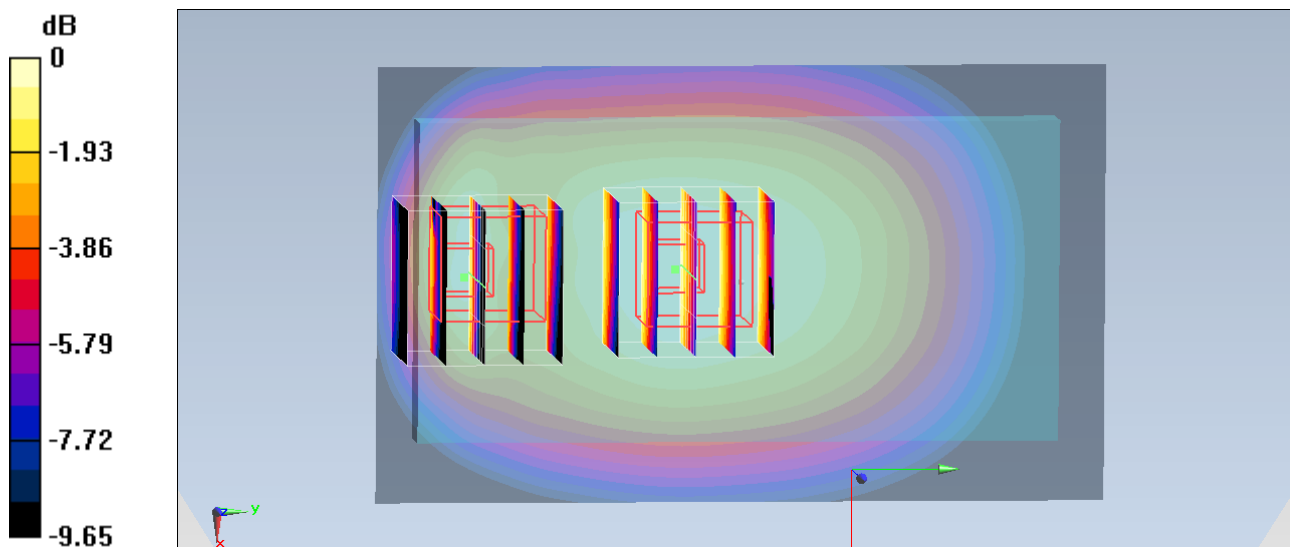

0 dB = 1.14 mW/g = 1.14 dB mW/g

#01_GSM1900_GPRS (4 Tx slots)_Front_1cm_Ch512

DUT: 370213

Communication System: PCS; Frequency: 1850.2 MHz; Duty Cycle: 1:2

Medium: MSL_1900_130709 Medium parameters used: $f = 1850.2$ MHz; $\sigma = 1.49$ mho/m; $\epsilon_r = 52.9$; $\rho = 1000$ kg/m³

Ambient Temperature : 23.5 °C ; Liquid Temperature : 22.5 °C

DASY4 Configuration:

- Probe: ET3DV6R - SN1788; ConvF(4.15, 4.15, 4.15); Calibrated: 2012/10/23
- Sensor-Surface: 4mm (Mechanical Surface Detection)
- Electronics: DAE3 Sn577; Calibrated: 2013/5/8
- Phantom: SAM_Right; Type: SAM; Serial: TP-1303
- Measurement SW: DASY4, V4.7 Build 80; Postprocessing SW: SEMCAD, V1.8 Build 186

Ch512/Area Scan (61x101x1): Measurement grid: dx=15mm, dy=15mm

Maximum value of SAR (interpolated) = 0.506 mW/g

Ch512/Zoom Scan (5x5x7)/Cube 0: Measurement grid: dx=8mm, dy=8mm, dz=5mm

Reference Value = 19.6 V/m; Power Drift = -0.048 dB

Peak SAR (extrapolated) = 0.643 W/kg

SAR(1 g) = 0.464 mW/g; SAR(10 g) = 0.298 mW/g

Maximum value of SAR (measured) = 0.496 mW/g

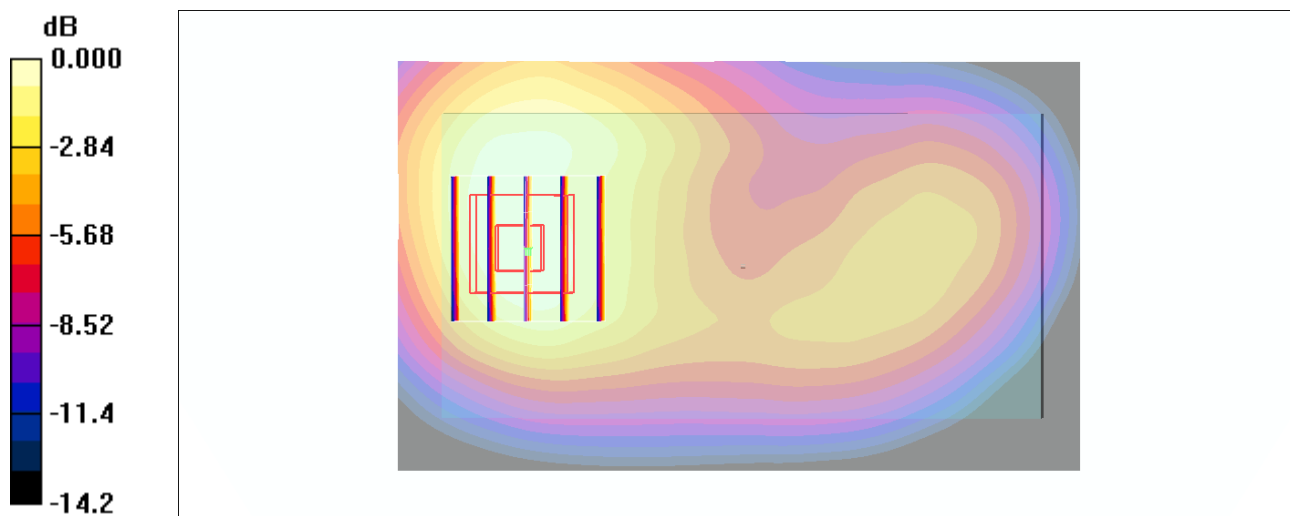

0 dB = 0.496mW/g

#02_GSM1900_GPRS (4 Tx slots)_Back_1cm_Ch512

DUT: 370213

Communication System: PCS; Frequency: 1850.2 MHz; Duty Cycle: 1:2

Medium: MSL_1900_130803 Medium parameters used: $f = 1850.2$ MHz; $\sigma = 1.488$ mho/m; $\epsilon_r = 52.545$;

$\rho = 1000$ kg/m³

Ambient Temperature : 23.4 °C ; Liquid Temperature : 22.4 °C

DASY5 Configuration:

- Probe: EX3DV4 - SN3925; ConvF(7.91, 7.91, 7.91); Calibrated: 2013/6/12;
- Sensor-Surface: 2mm (Mechanical Surface Detection)
- Electronics: DAE3 Sn495; Calibrated: 2013/5/8
- Phantom: SAM Left; Type: QD000P40CD; Serial: TP:1542
- Measurement SW: DASY52, Version 52.8 (3); SEMCAD X Version 14.6.5 (6469)

Configuration/Ch512/Area Scan (61x101x1): Measurement grid: dx=15mm, dy=15mm
 Maximum value of SAR (interpolated) = 1.03 mW/g

Configuration/Ch512/Zoom Scan (5x5x7)/Cube 0: Measurement grid: dx=8mm, dy=8mm, dz=5mm

Reference Value = 25.125 V/m; Power Drift = -0.01 dB

Peak SAR (extrapolated) = 1.225 mW/g

SAR(1 g) = 0.793 mW/g; SAR(10 g) = 0.489 mW/g

Maximum value of SAR (measured) = 1.03 mW/g

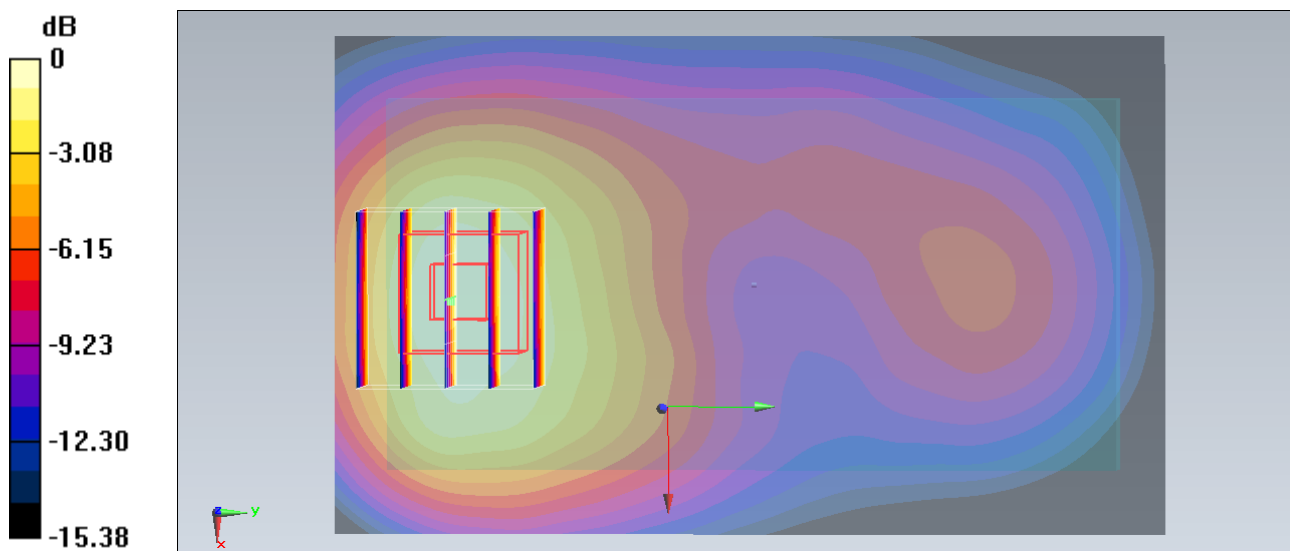

0 dB = 1.03 mW/g = 0.26 dB mW/g

#51_GSM1900_GPRS (4 Tx slots)_Back_1cm_Ch661

DUT: 370213

Communication System: PCS; Frequency: 1880 MHz; Duty Cycle: 1:2

Medium: MSL_1900_130803 Medium parameters used: $f = 1880$ MHz; $\sigma = 1.515$ mho/m; $\epsilon_r = 52.419$; ρ

$= 1000$ kg/m³

Ambient Temperature : 23.4 °C ; Liquid Temperature : 22.4 °C

DASY5 Configuration:

- Probe: EX3DV4 - SN3925; ConvF(7.91, 7.91, 7.91); Calibrated: 2013/6/12;
- Sensor-Surface: 2mm (Mechanical Surface Detection)
- Electronics: DAE3 Sn495; Calibrated: 2013/5/8
- Phantom: SAM Left; Type: QD000P40CD; Serial: TP:1542
- Measurement SW: DASY52, Version 52.8 (3); SEMCAD X Version 14.6.5 (6469)

Configuration/Ch661/Area Scan (61x101x1): Measurement grid: dx=15mm, dy=15mm
 Maximum value of SAR (interpolated) = 1.08 mW/g

Configuration/Ch661/Zoom Scan (5x5x7)/Cube 0: Measurement grid: dx=8mm, dy=8mm, dz=5mm

Reference Value = 23.530 V/m; Power Drift = -0.01 dB

Peak SAR (extrapolated) = 1.309 mW/g

SAR(1 g) = 0.833 mW/g; SAR(10 g) = 0.506 mW/g

Maximum value of SAR (measured) = 1.10 mW/g

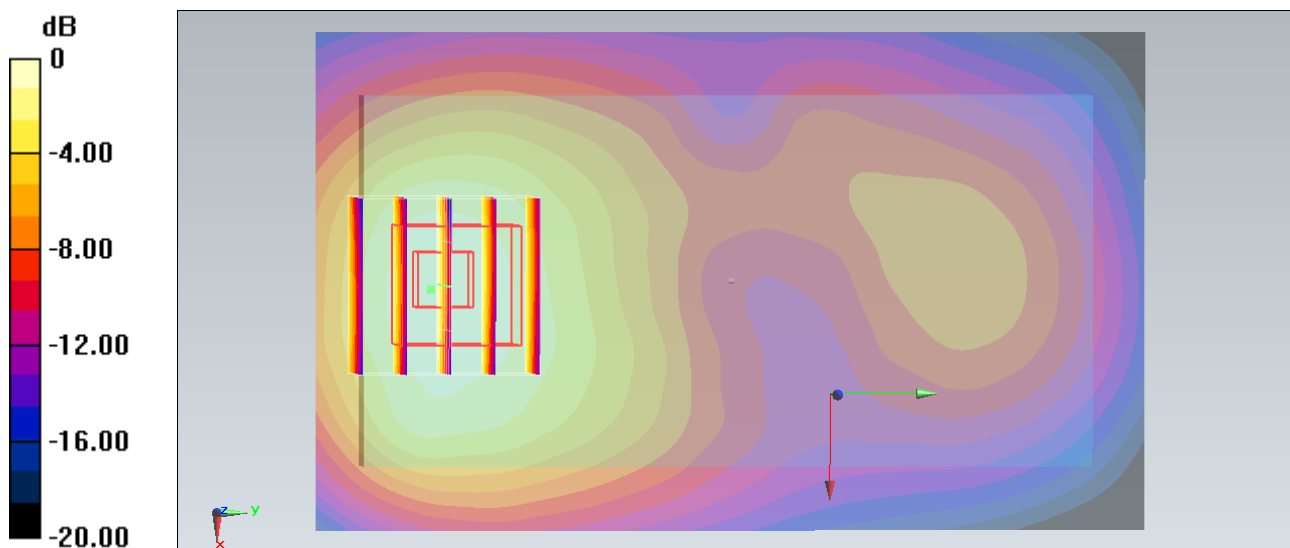

0 dB = 1.10 mW/g = 0.83 dB mW/g

#52_GSM1900_GPRS (4 Tx slots)_Back_1cm_Ch810

DUT: 370213

Communication System: PCS; Frequency: 1909.8 MHz; Duty Cycle: 1:2

Medium: MSL_1900_130803 Medium parameters used: $f = 1910$ MHz; $\sigma = 1.541$ mho/m; $\epsilon_r = 52.29$; $\rho =$

1000 kg/m³

Ambient Temperature : 23.4 °C ; Liquid Temperature : 22.4 °C

DASY5 Configuration:

- Probe: EX3DV4 - SN3925; ConvF(7.91, 7.91, 7.91); Calibrated: 2013/6/12;
- Sensor-Surface: 2mm (Mechanical Surface Detection)
- Electronics: DAE3 Sn495; Calibrated: 2013/5/8
- Phantom: SAM Left; Type: QD000P40CD; Serial: TP:1542
- Measurement SW: DASY52, Version 52.8 (3); SEMCAD X Version 14.6.5 (6469)

Configuration/Ch810/Area Scan (61x101x1): Measurement grid: dx=15mm, dy=15mm
 Maximum value of SAR (interpolated) = 1.23 mW/g

Configuration/Ch810/Zoom Scan (5x5x7)/Cube 0: Measurement grid: dx=8mm, dy=8mm, dz=5mm

Reference Value = 25.037 V/m; Power Drift = 0.01 dB

Peak SAR (extrapolated) = 1.490 mW/g

SAR(1 g) = 0.948 mW/g; SAR(10 g) = 0.572 mW/g

Maximum value of SAR (measured) = 1.24 mW/g

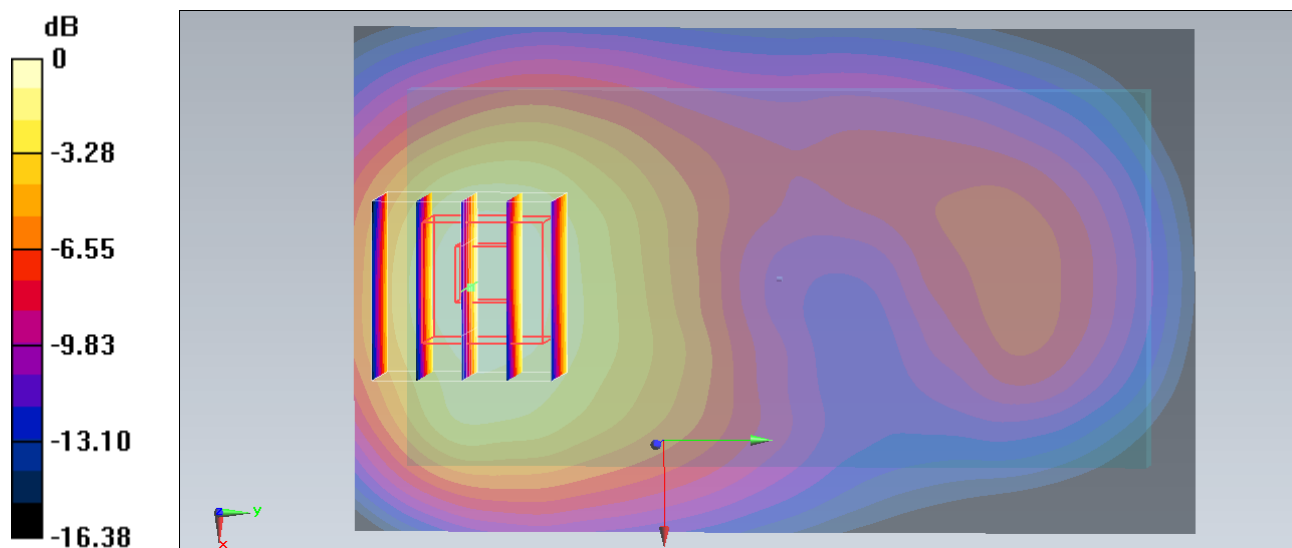

0 dB = 1.24 mW/g = 1.87 dB mW/g

#03_GSM1900_GPRS (4 Tx slots)_Left Side_1cm_Ch512

DUT: 370213

Communication System: PCS; Frequency: 1850.2 MHz; Duty Cycle: 1:2

Medium: MSL_1900_130709 Medium parameters used: $f = 1850.2$ MHz; $\sigma = 1.49$ mho/m; $\epsilon_r = 52.9$; $\rho = 1000$ kg/m³

Ambient Temperature : 23.5 °C ; Liquid Temperature : 22.5 °C

DASY4 Configuration:

- Probe: ET3DV6R - SN1788; ConvF(4.15, 4.15, 4.15); Calibrated: 2012/10/23
- Sensor-Surface: 4mm (Mechanical Surface Detection)
- Electronics: DAE3 Sn577; Calibrated: 2013/5/8
- Phantom: SAM_Right; Type: SAM; Serial: TP-1303
- Measurement SW: DASY4, V4.7 Build 80; Postprocessing SW: SEMCAD, V1.8 Build 186

Ch512/Area Scan (41x101x1): Measurement grid: dx=15mm, dy=15mm

Maximum value of SAR (interpolated) = 0.291 mW/g

Ch512/Zoom Scan (5x5x7)/Cube 0: Measurement grid: dx=8mm, dy=8mm, dz=5mm

Reference Value = 12.4 V/m; Power Drift = 0.029 dB

Peak SAR (extrapolated) = 0.364 W/kg

SAR(1 g) = 0.225 mW/g; SAR(10 g) = 0.128 mW/g

Maximum value of SAR (measured) = 0.249 mW/g

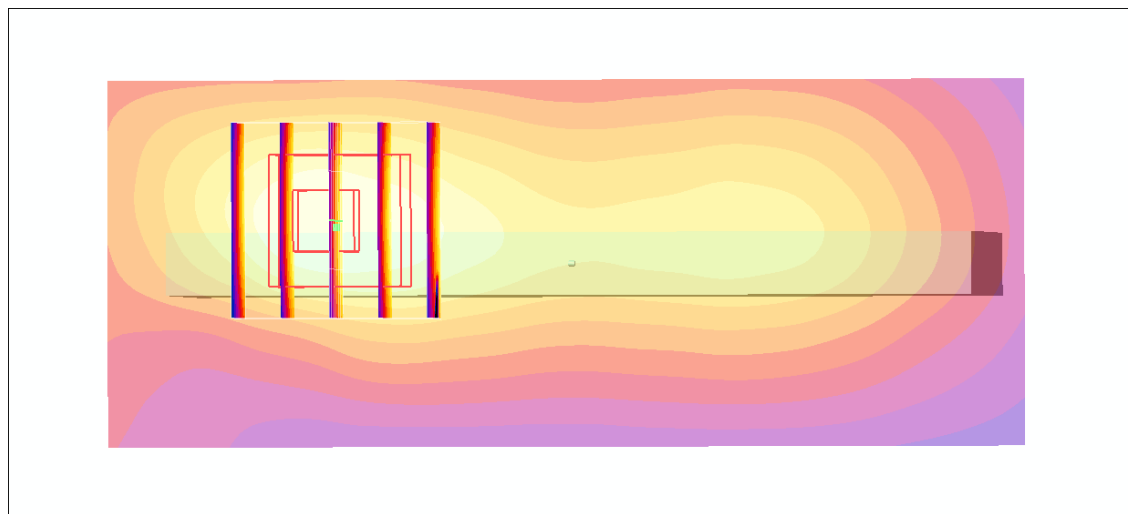
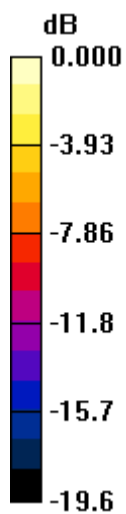

0 dB = 0.249mW/g

#04_GSM1900_GPRS (4 Tx slots)_Right Side_1cm_Ch512

DUT: 370213

Communication System: PCS; Frequency: 1850.2 MHz; Duty Cycle: 1:2

Medium: MSL_1900_130709 Medium parameters used: $f = 1850.2$ MHz; $\sigma = 1.49$ mho/m; $\epsilon_r = 52.9$; $\rho = 1000$ kg/m³

Ambient Temperature : 23.5 °C ; Liquid Temperature : 22.5 °C

DASY4 Configuration:

- Probe: ET3DV6R - SN1788; ConvF(4.15, 4.15, 4.15); Calibrated: 2012/10/23
- Sensor-Surface: 4mm (Mechanical Surface Detection)
- Electronics: DAE3 Sn577; Calibrated: 2013/5/8
- Phantom: SAM_Right; Type: SAM; Serial: TP-1303
- Measurement SW: DASY4, V4.7 Build 80; Postprocessing SW: SEMCAD, V1.8 Build 186

Ch512/Area Scan (41x101x1): Measurement grid: dx=15mm, dy=15mm

Maximum value of SAR (interpolated) = 0.080 mW/g

Ch512/Zoom Scan (5x5x7)/Cube 0: Measurement grid: dx=8mm, dy=8mm, dz=5mm

Reference Value = 7.19 V/m; Power Drift = 0.048 dB

Peak SAR (extrapolated) = 0.105 W/kg

SAR(1 g) = 0.071 mW/g; SAR(10 g) = 0.044 mW/g

Maximum value of SAR (measured) = 0.077 mW/g

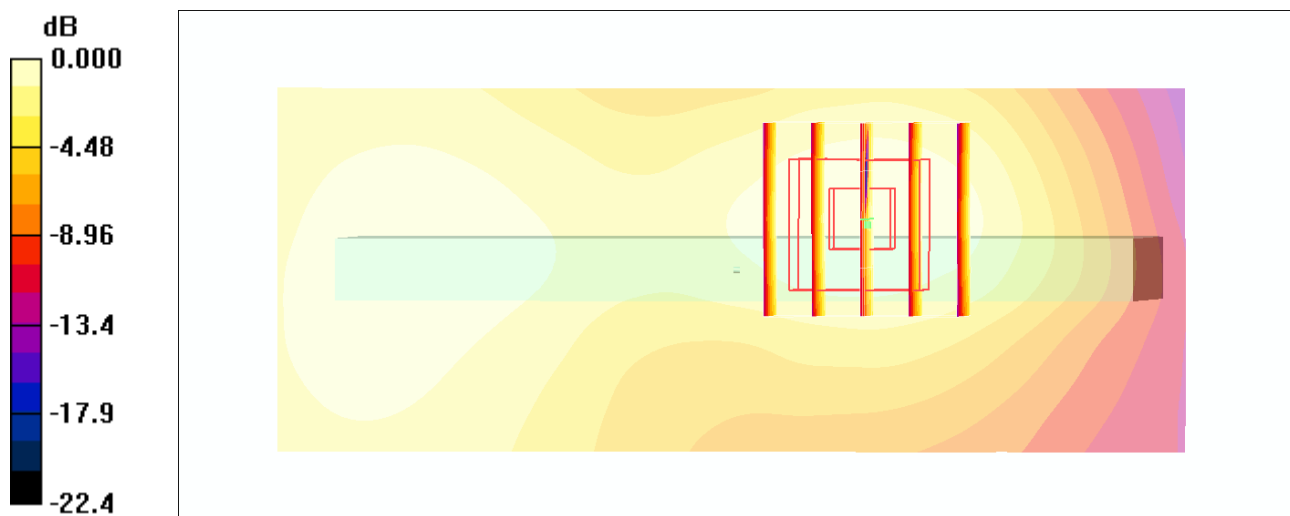

0 dB = 0.077mW/g

#06_GSM1900_GPRS (4 Tx slots)_Bottom Side_1cm_Ch512**DUT: 370213**

Communication System: PCS; Frequency: 1850.2 MHz; Duty Cycle: 1:2

Medium: MSL_1900_130709 Medium parameters used: $f = 1850.2$ MHz; $\sigma = 1.49$ mho/m; $\epsilon_r = 52.9$; $\rho = 1000$ kg/m³

Ambient Temperature : 23.5 °C ; Liquid Temperature : 22.5 °C

DASY4 Configuration:

- Probe: ET3DV6R - SN1788; ConvF(4.15, 4.15, 4.15); Calibrated: 2012/10/23
- Sensor-Surface: 4mm (Mechanical Surface Detection)
- Electronics: DAE3 Sn577; Calibrated: 2013/5/8
- Phantom: SAM_Right; Type: SAM; Serial: TP-1303
- Measurement SW: DASY4, V4.7 Build 80; Postprocessing SW: SEMCAD, V1.8 Build 186

Ch512/Area Scan (41x61x1): Measurement grid: dx=15mm, dy=15mm

Maximum value of SAR (interpolated) = 0.751 mW/g

Ch512/Zoom Scan (5x5x7)/Cube 0: Measurement grid: dx=8mm, dy=8mm, dz=5mm

Reference Value = 21.2 V/m; Power Drift = 0.044 dB

Peak SAR (extrapolated) = 0.953 W/kg

SAR(1 g) = 0.630 mW/g; SAR(10 g) = 0.377 mW/g

Maximum value of SAR (measured) = 0.694 mW/g

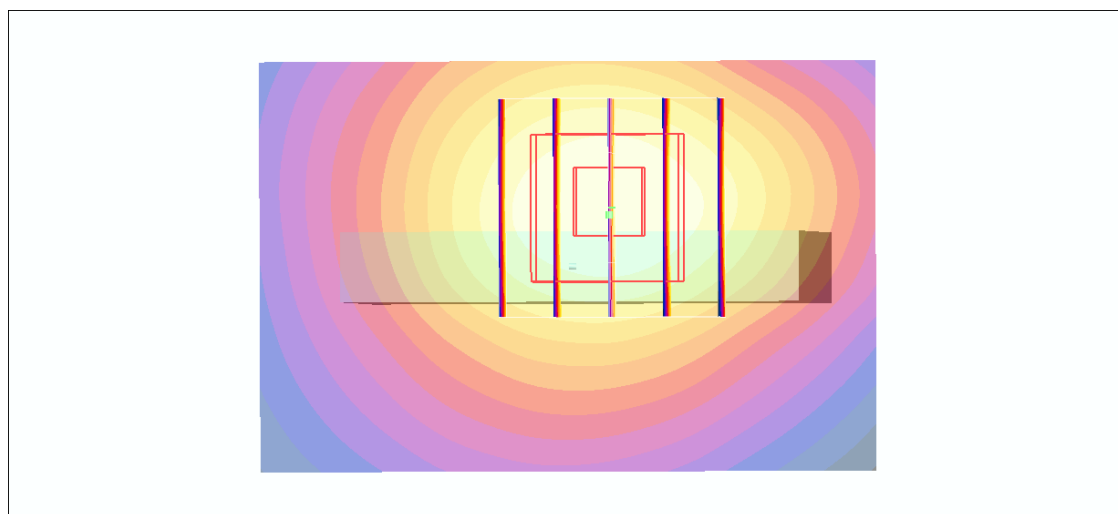
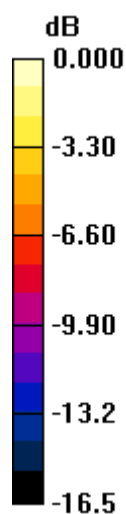

0 dB = 0.694mW/g

#07_GSM1900_DTM Multi-slot class 11_Front_1cm_Ch512

DUT: 370213

Communication System: PCS; Frequency: 1850.2 MHz; Duty Cycle: 1:2.67

Medium: MSL_1900_130709 Medium parameters used: $f = 1850.2$ MHz; $\sigma = 1.49$ mho/m; $\epsilon_r = 52.9$; $\rho = 1000$ kg/m³

Ambient Temperature : 23.5 °C ; Liquid Temperature : 22.5 °C

DASY4 Configuration:

- Probe: ET3DV6R - SN1788; ConvF(4.15, 4.15, 4.15); Calibrated: 2012/10/23
- Sensor-Surface: 4mm (Mechanical Surface Detection)
- Electronics: DAE3 Sn577; Calibrated: 2013/5/8
- Phantom: SAM_Right; Type: SAM; Serial: TP-1303
- Measurement SW: DASY4, V4.7 Build 80; Postprocessing SW: SEMCAD, V1.8 Build 186

Ch512/Area Scan (61x101x1): Measurement grid: dx=15mm, dy=15mm

Maximum value of SAR (interpolated) = 0.467 mW/g

Ch512/Zoom Scan (5x5x7)/Cube 0: Measurement grid: dx=8mm, dy=8mm, dz=5mm

Reference Value = 18.4 V/m; Power Drift = 0.002 dB

Peak SAR (extrapolated) = 0.632 W/kg

SAR(1 g) = 0.445 mW/g; SAR(10 g) = 0.284 mW/g

Maximum value of SAR (measured) = 0.480 mW/g

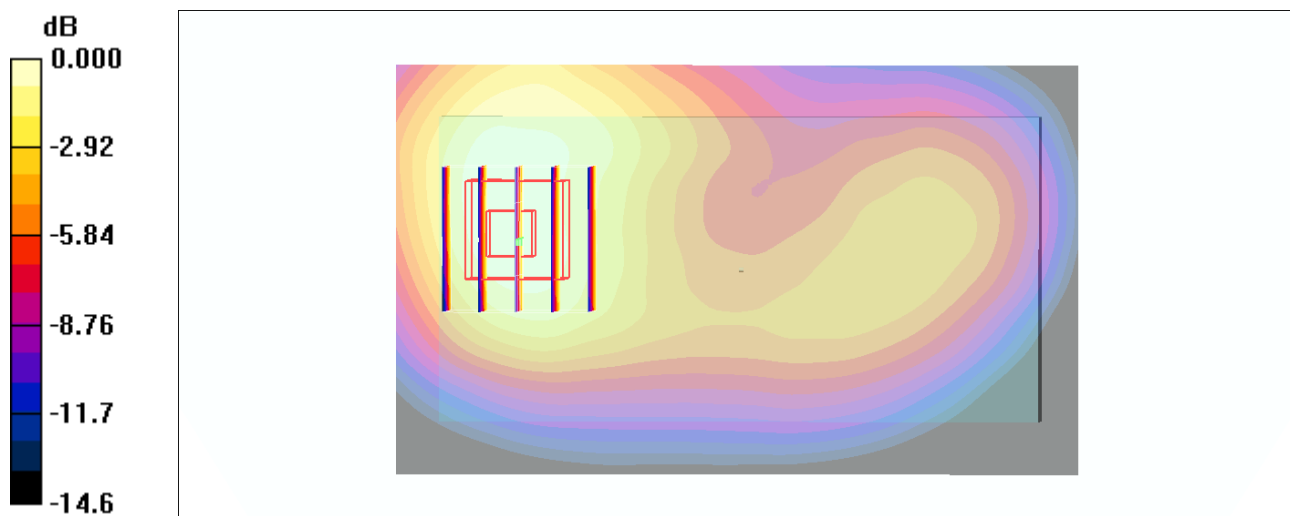

0 dB = 0.480mW/g

#08_GSM1900_DTM Multi-slot class 11_Back_1cm_Ch512

DUT: 370213

Communication System: PCS; Frequency: 1850.2 MHz; Duty Cycle: 1:2.67

Medium: MSL_1900_130803 Medium parameters used: $f = 1850.2$ MHz; $\sigma = 1.488$ mho/m; $\epsilon_r = 52.545$;

$\rho = 1000$ kg/m³

Ambient Temperature : 23.4 °C ; Liquid Temperature : 22.4 °C

DASY5 Configuration:

- Probe: EX3DV4 - SN3925; ConvF(7.91, 7.91, 7.91); Calibrated: 2013/6/12;
- Sensor-Surface: 2mm (Mechanical Surface Detection)
- Electronics: DAE3 Sn495; Calibrated: 2013/5/8
- Phantom: SAM Left; Type: QD000P40CD; Serial: TP:1542
- Measurement SW: DASY52, Version 52.8 (3); SEMCAD X Version 14.6.5 (6469)

Configuration/Ch512/Area Scan (61x101x1): Measurement grid: dx=15mm, dy=15mm
 Maximum value of SAR (interpolated) = 0.985 mW/g

Configuration/Ch512/Zoom Scan (5x5x7)/Cube 0: Measurement grid: dx=8mm, dy=8mm, dz=5mm

Reference Value = 24.579 V/m; Power Drift = -0.03 dB

Peak SAR (extrapolated) = 1.173 mW/g

SAR(1 g) = 0.749 mW/g; SAR(10 g) = 0.456 mW/g

Maximum value of SAR (measured) = 0.981 mW/g

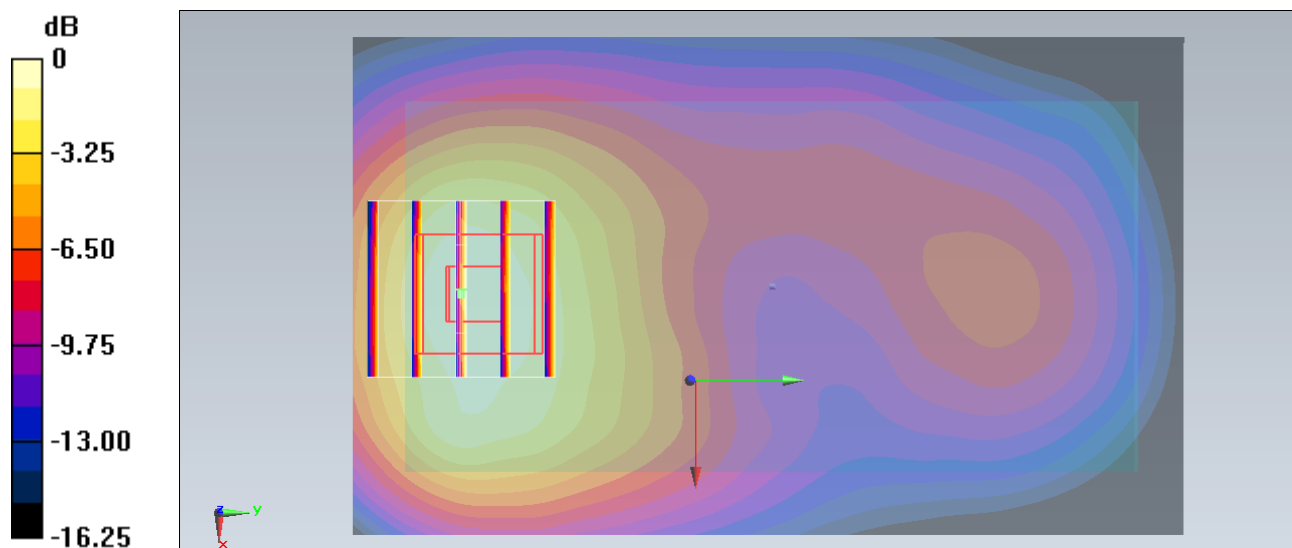

0 dB = 0.981 mW/g = -0.17 dB mW/g

#53_GSM1900_DTM Multi-slot class 11_Back_1cm_Ch661

DUT: 370213

Communication System: PCS; Frequency: 1880 MHz; Duty Cycle: 1:2.67

Medium: MSL_1900_130803 Medium parameters used: $f = 1880$ MHz; $\sigma = 1.515$ mho/m; $\epsilon_r = 52.419$; ρ

$= 1000$ kg/m³

Ambient Temperature : 23.4 °C ; Liquid Temperature : 22.4 °C

DASY5 Configuration:

- Probe: EX3DV4 - SN3925; ConvF(7.91, 7.91, 7.91); Calibrated: 2013/6/12;
- Sensor-Surface: 2mm (Mechanical Surface Detection)
- Electronics: DAE3 Sn495; Calibrated: 2013/5/8
- Phantom: SAM Left; Type: QD000P40CD; Serial: TP:1542
- Measurement SW: DASY52, Version 52.8 (3); SEMCAD X Version 14.6.5 (6469)

Configuration/Ch661/Area Scan (61x101x1): Measurement grid: dx=15mm, dy=15mm
 Maximum value of SAR (interpolated) = 1.03 mW/g

Configuration/Ch661/Zoom Scan (5x5x7)/Cube 0: Measurement grid: dx=8mm, dy=8mm, dz=5mm

Reference Value = 24.971 V/m; Power Drift = -0.03 dB

Peak SAR (extrapolated) = 1.236 mW/g

SAR(1 g) = 0.786 mW/g; SAR(10 g) = 0.477 mW/g

Maximum value of SAR (measured) = 1.03 mW/g

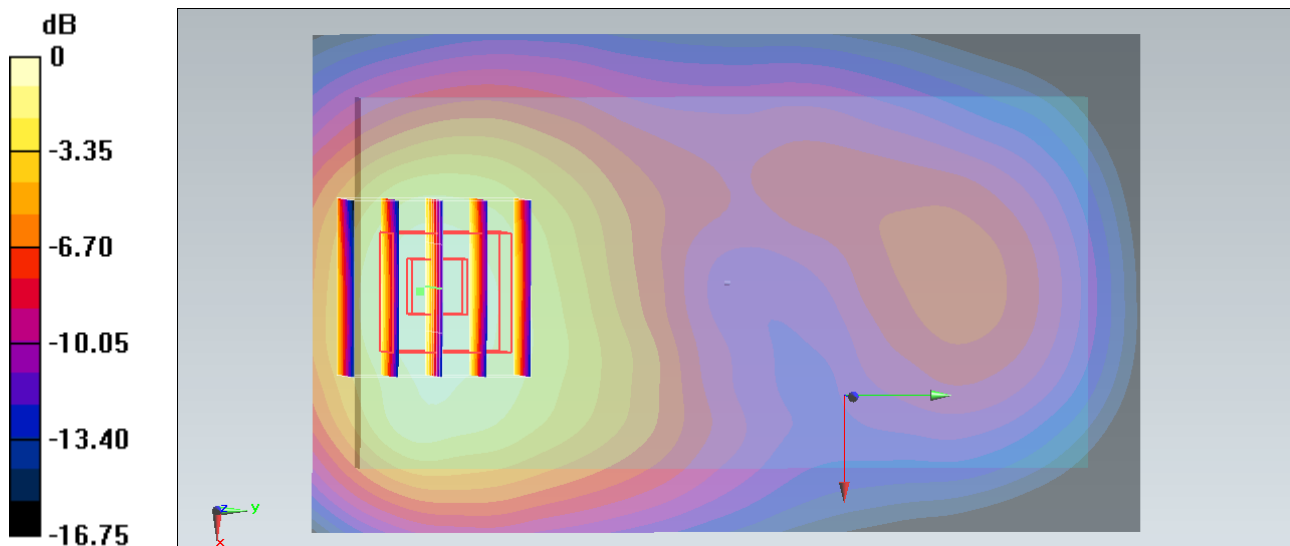

0 dB = 1.03 mW/g = 0.26 dB mW/g

#54_GSM1900_DTM Multi-slot class 11_Back_1cm_Ch810

DUT: 370213

Communication System: PCS; Frequency: 1909.8 MHz; Duty Cycle: 1:2.67

Medium: MSL_1900_130803 Medium parameters used: $f = 1910$ MHz; $\sigma = 1.541$ mho/m; $\epsilon_r = 52.29$; $\rho =$

1000 kg/m³

Ambient Temperature : 23.4 °C ; Liquid Temperature : 22.4 °C

DASY5 Configuration:

- Probe: EX3DV4 - SN3925; ConvF(7.91, 7.91, 7.91); Calibrated: 2013/6/12;
- Sensor-Surface: 2mm (Mechanical Surface Detection)
- Electronics: DAE3 Sn495; Calibrated: 2013/5/8
- Phantom: SAM Left; Type: QD000P40CD; Serial: TP:1542
- Measurement SW: DASY52, Version 52.8 (3); SEMCAD X Version 14.6.5 (6469)

Configuration/Ch810/Area Scan (61x101x1): Measurement grid: dx=15mm, dy=15mm
 Maximum value of SAR (interpolated) = 1.19 mW/g

Configuration/Ch810/Zoom Scan (5x5x7)/Cube 0: Measurement grid: dx=8mm, dy=8mm, dz=5mm

Reference Value = 26.419 V/m; Power Drift = -0.19 dB

Peak SAR (extrapolated) = 1.247 mW/g

SAR(1 g) = 0.784 mW/g; SAR(10 g) = 0.474 mW/g

Maximum value of SAR (measured) = 1.04 mW/g

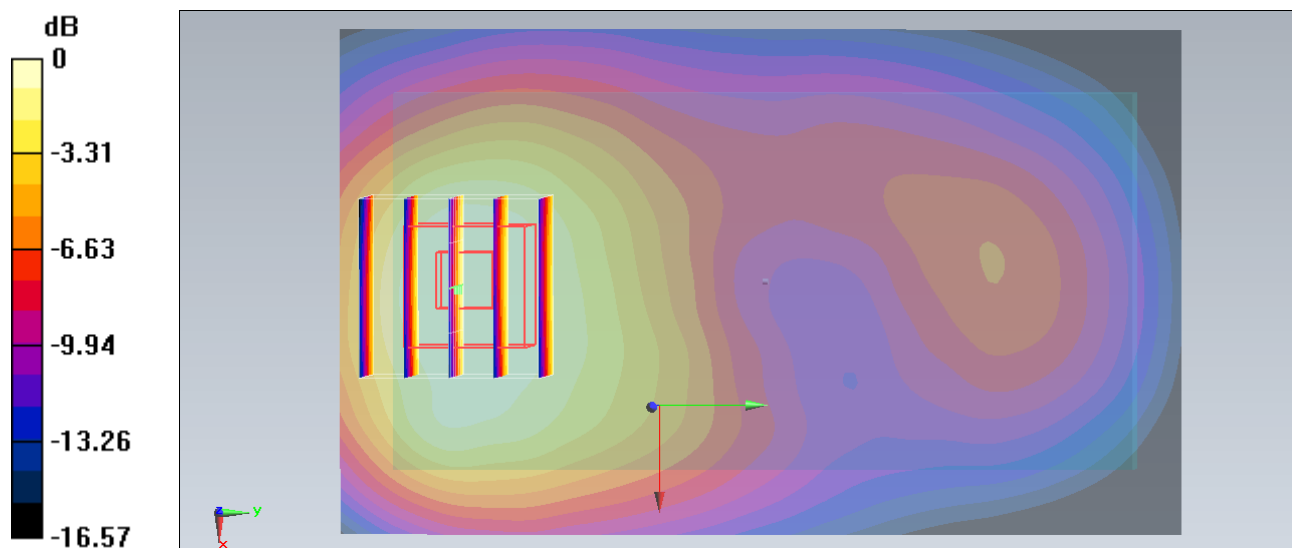

0 dB = 1.04 mW/g = 0.34 dB mW/g

#26_WCDMA V_RMC12.2Kbps_Front_1cm_Ch4233

DUT: 370213

Communication System: WCDMA; Frequency: 846.6 MHz; Duty Cycle: 1:1

Medium: MSL_850_130709 Medium parameters used: $f = 847$ MHz; $\sigma = 0.975$ mho/m; $\epsilon_r = 54.4$; $\rho = 1000$ kg/m³

Ambient Temperature : 22.3 °C; Liquid Temperature : 21.3 °C

DASY4 Configuration:

- Probe: ET3DV6R - SN1788; ConvF(5.92, 5.92, 5.92); Calibrated: 2012/10/23
- Sensor-Surface: 4mm (Mechanical Surface Detection)
- Electronics: DAE3 Sn577; Calibrated: 2013/5/8
- Phantom: SAM_Right; Type: SAM; Serial: TP-1303
- Measurement SW: DASY4, V4.7 Build 80; Postprocessing SW: SEMCAD, V1.8 Build 186

Ch4233/Area Scan (61x101x1): Measurement grid: dx=15mm, dy=15mm

Maximum value of SAR (interpolated) = 0.384 mW/g

Ch4233/Zoom Scan (5x5x7)/Cube 0: Measurement grid: dx=8mm, dy=8mm, dz=5mm

Reference Value = 20.6 V/m; Power Drift = -0.014 dB

Peak SAR (extrapolated) = 0.431 W/kg

SAR(1 g) = 0.365 mW/g; SAR(10 g) = 0.282 mW/g

Maximum value of SAR (measured) = 0.383 mW/g

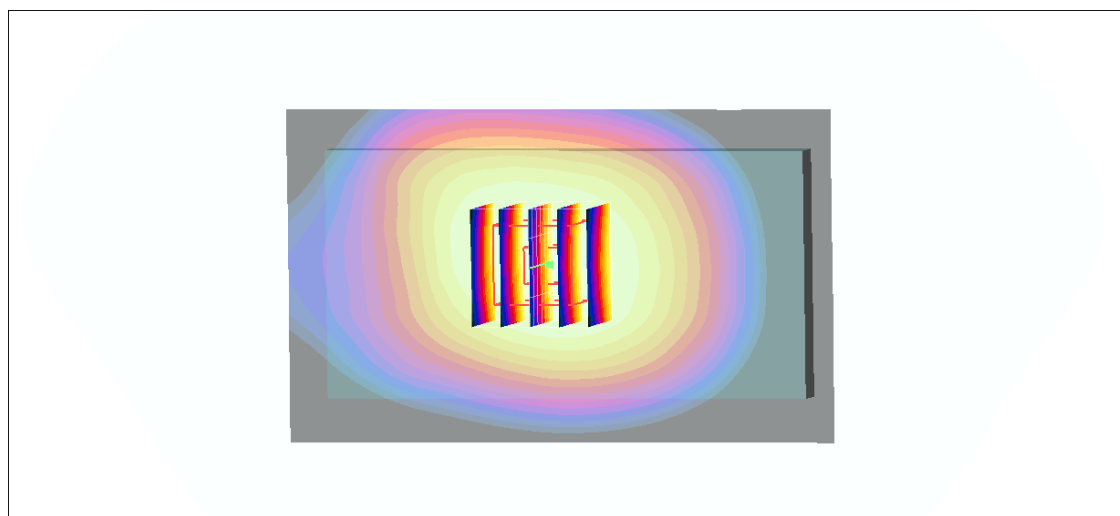
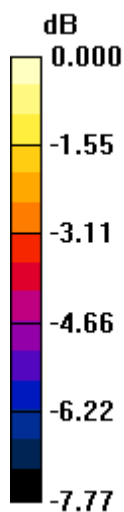

0 dB = 0.383mW/g

#27_WCDMA V_RMC12.2Kbps_Back_1cm_Ch4233

DUT: 370213

Communication System: WCDMA; Frequency: 846.6 MHz; Duty Cycle: 1:1

Medium: MSL_850_130709 Medium parameters used: $f = 847$ MHz; $\sigma = 0.975$ mho/m; $\epsilon_r = 54.4$; $\rho = 1000$ kg/m³

Ambient Temperature : 22.3 °C; Liquid Temperature : 21.3 °C

DASY4 Configuration:

- Probe: ET3DV6R - SN1788; ConvF(5.92, 5.92, 5.92); Calibrated: 2012/10/23
- Sensor-Surface: 4mm (Mechanical Surface Detection)
- Electronics: DAE3 Sn577; Calibrated: 2013/5/8
- Phantom: SAM_Right; Type: SAM; Serial: TP-1303
- Measurement SW: DASY4, V4.7 Build 80; Postprocessing SW: SEMCAD, V1.8 Build 186

Ch4233/Area Scan (61x101x1): Measurement grid: dx=15mm, dy=15mm

Maximum value of SAR (interpolated) = 0.653 mW/g

Ch4233/Zoom Scan (5x5x7)/Cube 0: Measurement grid: dx=8mm, dy=8mm, dz=5mm

Reference Value = 27.1 V/m; Power Drift = -0.006 dB

Peak SAR (extrapolated) = 1.03 W/kg

SAR(1 g) = 0.590 mW/g; SAR(10 g) = 0.329 mW/g

Maximum value of SAR (measured) = 0.676 mW/g

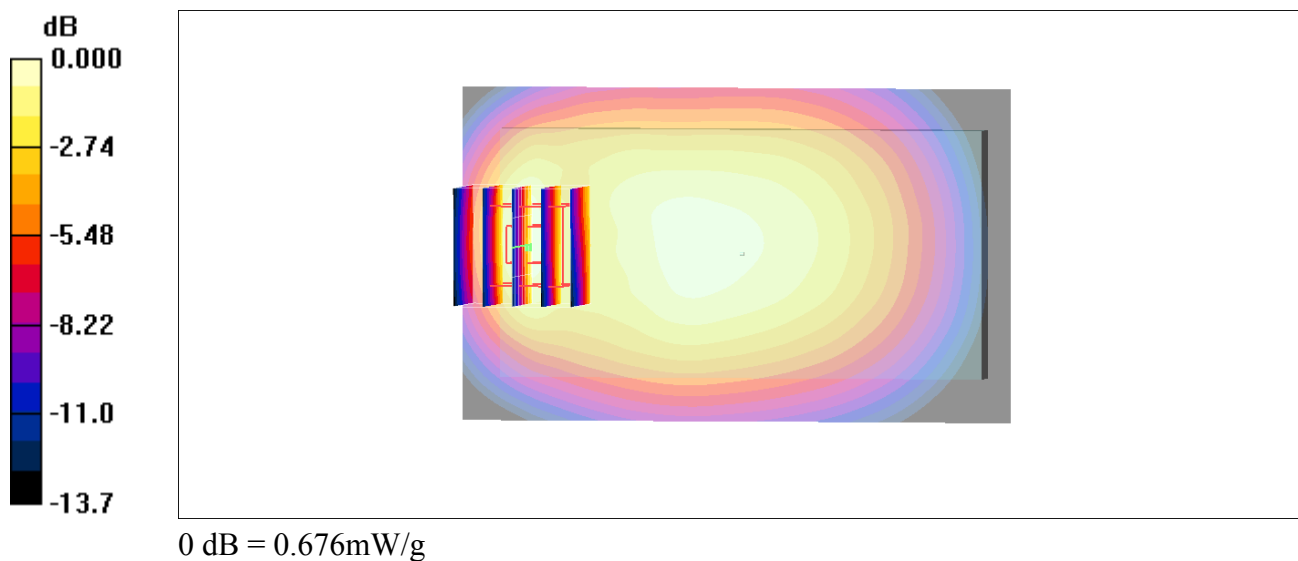

#28_WCDMA V_RMC12.2Kbps_Left Side_1cm_Ch4233

DUT: 370213

Communication System: WCDMA; Frequency: 846.6 MHz; Duty Cycle: 1:1

Medium: MSL_850_130709 Medium parameters used: $f = 847$ MHz; $\sigma = 0.975$ mho/m; $\epsilon_r = 54.4$; $\rho = 1000$ kg/m³

Ambient Temperature : 22.3 °C ; Liquid Temperature : 21.3 °C

DASY4 Configuration:

- Probe: ET3DV6R - SN1788; ConvF(5.92, 5.92, 5.92); Calibrated: 2012/10/23
- Sensor-Surface: 4mm (Mechanical Surface Detection)
- Electronics: DAE3 Sn577; Calibrated: 2013/5/8
- Phantom: SAM_Right; Type: SAM; Serial: TP-1303
- Measurement SW: DASY4, V4.7 Build 80; Postprocessing SW: SEMCAD, V1.8 Build 186

Ch4233/Area Scan (31x101x1): Measurement grid: dx=15mm, dy=15mm

Maximum value of SAR (interpolated) = 0.337 mW/g

Ch4233/Zoom Scan (5x5x7)/Cube 0: Measurement grid: dx=8mm, dy=8mm, dz=5mm

Reference Value = 19.6 V/m; Power Drift = 0.010 dB

Peak SAR (extrapolated) = 0.424 W/kg

SAR(1 g) = 0.319 mW/g; SAR(10 g) = 0.223 mW/g

Maximum value of SAR (measured) = 0.342 mW/g

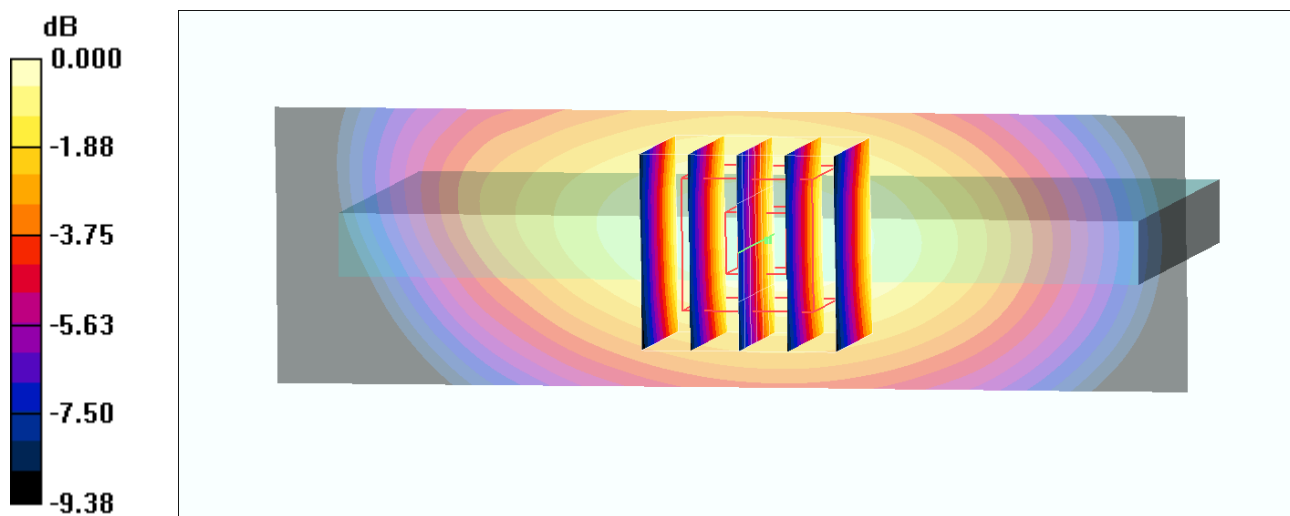

0 dB = 0.342mW/g

#29_WCDMA V_RMC12.2Kbps_Right Side_1cm_Ch4233

DUT: 370213

Communication System: WCDMA; Frequency: 846.6 MHz; Duty Cycle: 1:1

Medium: MSL_850_130709 Medium parameters used: $f = 847$ MHz; $\sigma = 0.975$ mho/m; $\epsilon_r = 54.4$; $\rho = 1000$ kg/m³

Ambient Temperature : 22.3 °C ; Liquid Temperature : 21.3 °C

DASY4 Configuration:

- Probe: ET3DV6R - SN1788; ConvF(5.92, 5.92, 5.92); Calibrated: 2012/10/23
- Sensor-Surface: 4mm (Mechanical Surface Detection)
- Electronics: DAE3 Sn577; Calibrated: 2013/5/8
- Phantom: SAM_Right; Type: SAM; Serial: TP-1303
- Measurement SW: DASY4, V4.7 Build 80; Postprocessing SW: SEMCAD, V1.8 Build 186

Ch4233/Area Scan (31x101x1): Measurement grid: dx=15mm, dy=15mm

Maximum value of SAR (interpolated) = 0.508 mW/g

Ch4233/Zoom Scan (5x5x7)/Cube 0: Measurement grid: dx=8mm, dy=8mm, dz=5mm

Reference Value = 24.0 V/m; Power Drift = -0.068 dB

Peak SAR (extrapolated) = 0.631 W/kg

SAR(1 g) = 0.475 mW/g; SAR(10 g) = 0.335 mW/g

Maximum value of SAR (measured) = 0.510 mW/g

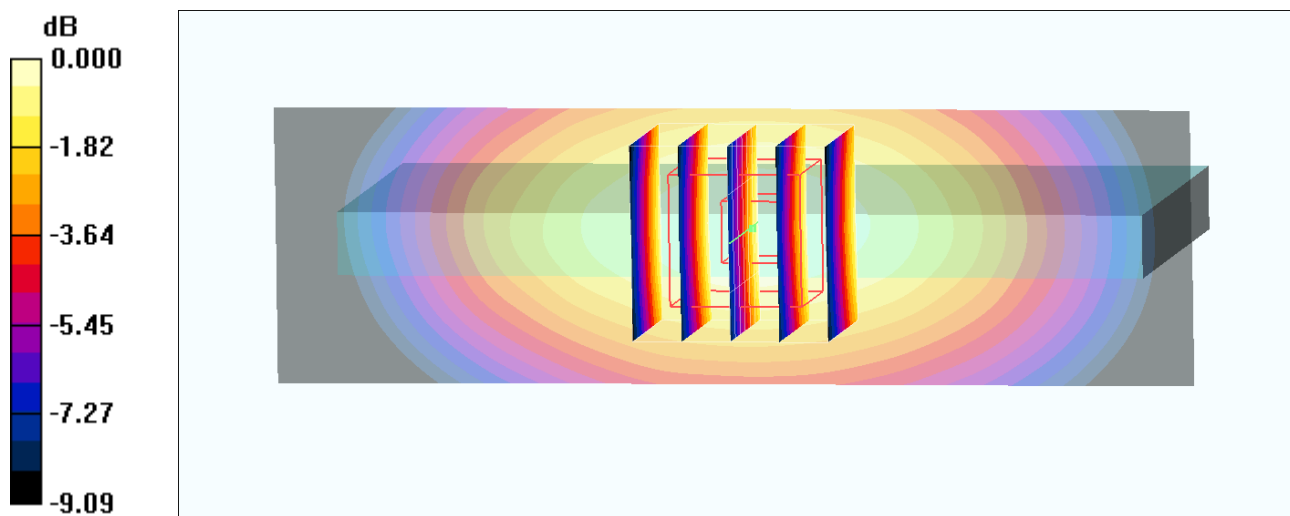

0 dB = 0.510mW/g

#31_WCDMA V_RMC12.2Kbps_Bottom Side_1cm_Ch4233**DUT: 370213**

Communication System: WCDMA; Frequency: 846.6 MHz; Duty Cycle: 1:1

Medium: MSL_850_130709 Medium parameters used: $f = 847$ MHz; $\sigma = 0.975$ mho/m; $\epsilon_r = 54.4$; $\rho = 1000$ kg/m³

Ambient Temperature : 22.3 °C ; Liquid Temperature : 21.3 °C

DASY4 Configuration:

- Probe: ET3DV6R - SN1788; ConvF(5.92, 5.92, 5.92); Calibrated: 2012/10/23
- Sensor-Surface: 4mm (Mechanical Surface Detection)
- Electronics: DAE3 Sn577; Calibrated: 2013/5/8
- Phantom: SAM_Right; Type: SAM; Serial: TP-1303
- Measurement SW: DASY4, V4.7 Build 80; Postprocessing SW: SEMCAD, V1.8 Build 186

Ch4233/Area Scan (31x61x1): Measurement grid: dx=15mm, dy=15mm

Maximum value of SAR (interpolated) = 0.173 mW/g

Ch4233/Zoom Scan (5x5x7)/Cube 0: Measurement grid: dx=8mm, dy=8mm, dz=5mm

Reference Value = 11.8 V/m; Power Drift = 0.005 dB

Peak SAR (extrapolated) = 0.225 W/kg

SAR(1 g) = 0.147 mW/g; SAR(10 g) = 0.088 mW/g

Maximum value of SAR (measured) = 0.160 mW/g

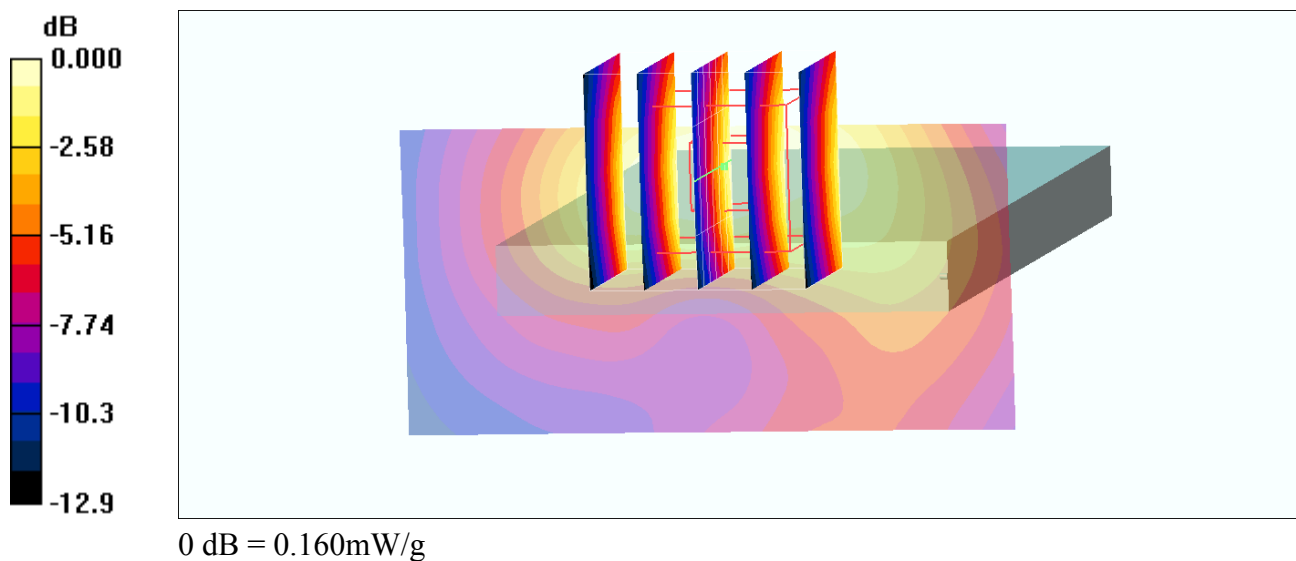

#09_WCDMA II_RMC12.2Kbps_Front_1cm_Ch9400

DUT: 370213

Communication System: WCDMA; Frequency: 1880 MHz; Duty Cycle: 1:1

Medium: MSL_1900_130709 Medium parameters used: $f = 1880$ MHz; $\sigma = 1.51$ mho/m; $\epsilon_r = 52.7$; $\rho = 1000$ kg/m³

Ambient Temperature : 23.5 °C ; Liquid Temperature : 22.5 °C

DASY4 Configuration:

- Probe: ET3DV6R - SN1788; ConvF(4.15, 4.15, 4.15); Calibrated: 2012/10/23
- Sensor-Surface: 4mm (Mechanical Surface Detection)
- Electronics: DAE3 Sn577; Calibrated: 2013/5/8
- Phantom: SAM_Right; Type: SAM; Serial: TP-1303
- Measurement SW: DASY4, V4.7 Build 80; Postprocessing SW: SEMCAD, V1.8 Build 186

Ch9400/Area Scan (61x101x1): Measurement grid: dx=15mm, dy=15mm

Maximum value of SAR (interpolated) = 0.666 mW/g

Ch9400/Zoom Scan (5x5x7)/Cube 0: Measurement grid: dx=8mm, dy=8mm, dz=5mm

Reference Value = 21.9 V/m; Power Drift = 0.021 dB

Peak SAR (extrapolated) = 0.871 W/kg

SAR(1 g) = 0.612 mW/g; SAR(10 g) = 0.387 mW/g

Maximum value of SAR (measured) = 0.655 mW/g

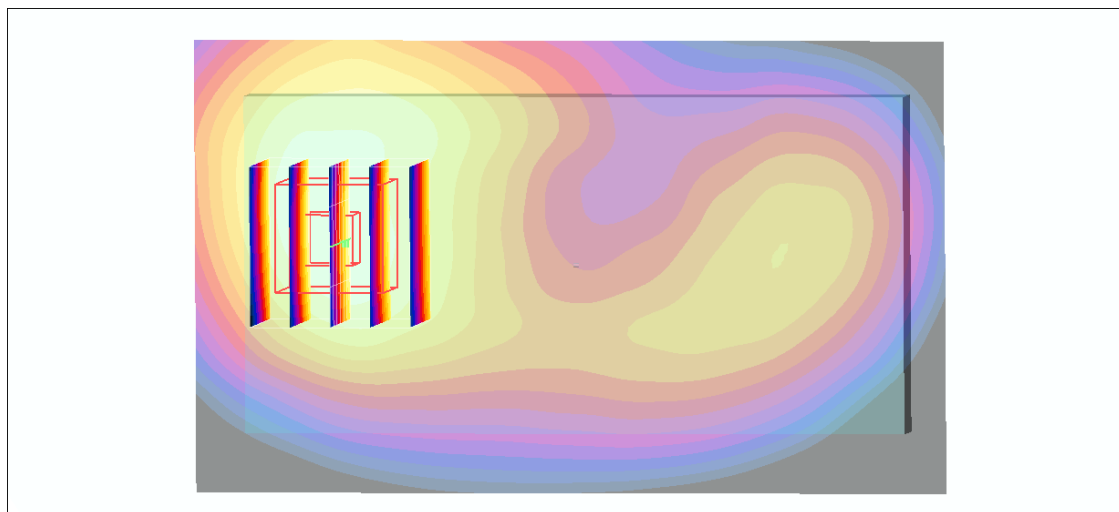
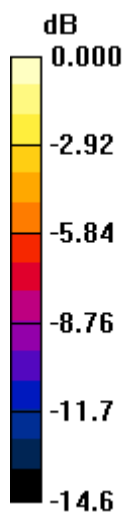

0 dB = 0.655mW/g

#10_WCDMA II_RMC12.2Kbps_Back_1cm_Ch9400

DUT: 370213

Communication System: WCDMA; Frequency: 1880 MHz; Duty Cycle: 1:1

Medium: MSL_1900_130709 Medium parameters used: $f = 1880$ MHz; $\sigma = 1.51$ mho/m; $\epsilon_r = 52.7$; $\rho = 1000$ kg/m³

Ambient Temperature : 23.5 °C ; Liquid Temperature : 22.5 °C

DASY4 Configuration:

- Probe: ET3DV6R - SN1788; ConvF(4.15, 4.15, 4.15); Calibrated: 2012/10/23
- Sensor-Surface: 4mm (Mechanical Surface Detection)
- Electronics: DAE3 Sn577; Calibrated: 2013/5/8
- Phantom: SAM_Right; Type: SAM; Serial: TP-1303
- Measurement SW: DASY4, V4.7 Build 80; Postprocessing SW: SEMCAD, V1.8 Build 186

Ch9400/Area Scan (61x101x1): Measurement grid: dx=15mm, dy=15mm

Maximum value of SAR (interpolated) = 1.04 mW/g

Ch9400/Zoom Scan (5x5x7)/Cube 0: Measurement grid: dx=8mm, dy=8mm, dz=5mm

Reference Value = 27.7 V/m; Power Drift = -0.008 dB

Peak SAR (extrapolated) = 1.46 W/kg

SAR(1 g) = 0.961 mW/g; SAR(10 g) = 0.590 mW/g

Maximum value of SAR (measured) = 1.03 mW/g

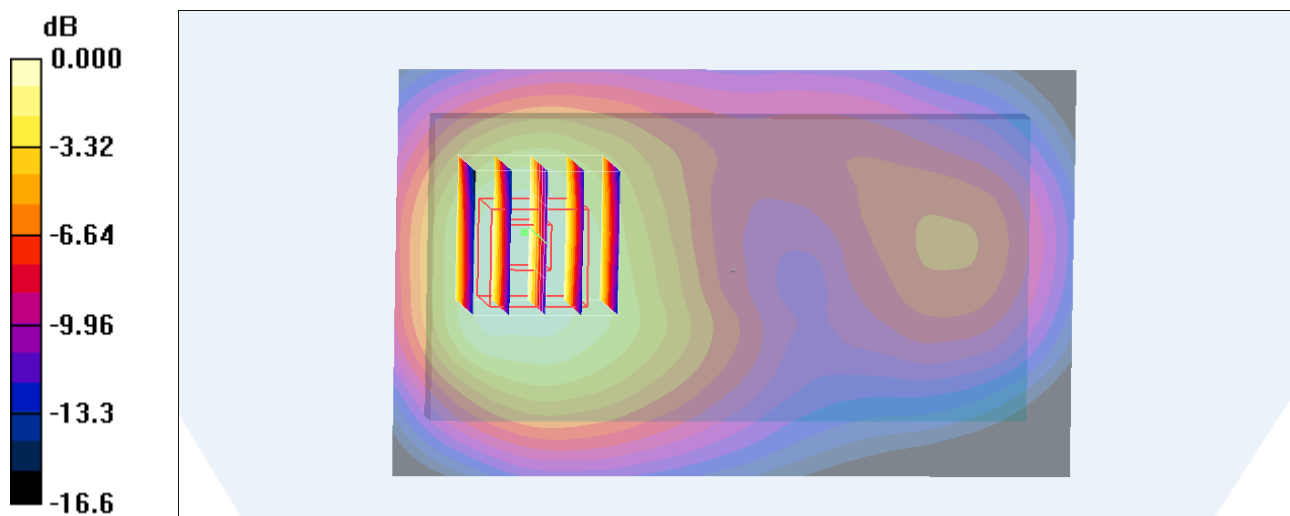

0 dB = 1.03mW/g

#11_WCDMA II_RMC12.2Kbps_Back_1cm_Ch9262**DUT: 370213**

Communication System: WCDMA; Frequency: 1852.4 MHz; Duty Cycle: 1:1

Medium: MSL_1900_130709 Medium parameters used : $f = 1852.4$ MHz; $\sigma = 1.49$ mho/m; $\epsilon_r = 52.9$; $\rho = 1000$ kg/m³

Ambient Temperature : 23.5 °C; Liquid Temperature : 22.5 °C

DASY4 Configuration:

- Probe: ET3DV6R - SN1788; ConvF(4.15, 4.15, 4.15); Calibrated: 2012/10/23
- Sensor-Surface: 4mm (Mechanical Surface Detection)
- Electronics: DAE3 Sn577; Calibrated: 2013/5/8
- Phantom: SAM_Right; Type: SAM; Serial: TP-1303
- Measurement SW: DASY4, V4.7 Build 80; Postprocessing SW: SEMCAD, V1.8 Build 186

Ch9262/Area Scan (61x101x1): Measurement grid: dx=15mm, dy=15mm

Maximum value of SAR (interpolated) = 1.01 mW/g

Ch9262/Zoom Scan (5x5x7)/Cube 0: Measurement grid: dx=8mm, dy=8mm, dz=5mm

Reference Value = 27.6 V/m; Power Drift = -0.024 dB

Peak SAR (extrapolated) = 1.40 W/kg

SAR(1 g) = 0.932 mW/g; SAR(10 g) = 0.577 mW/g

Maximum value of SAR (measured) = 0.993 mW/g

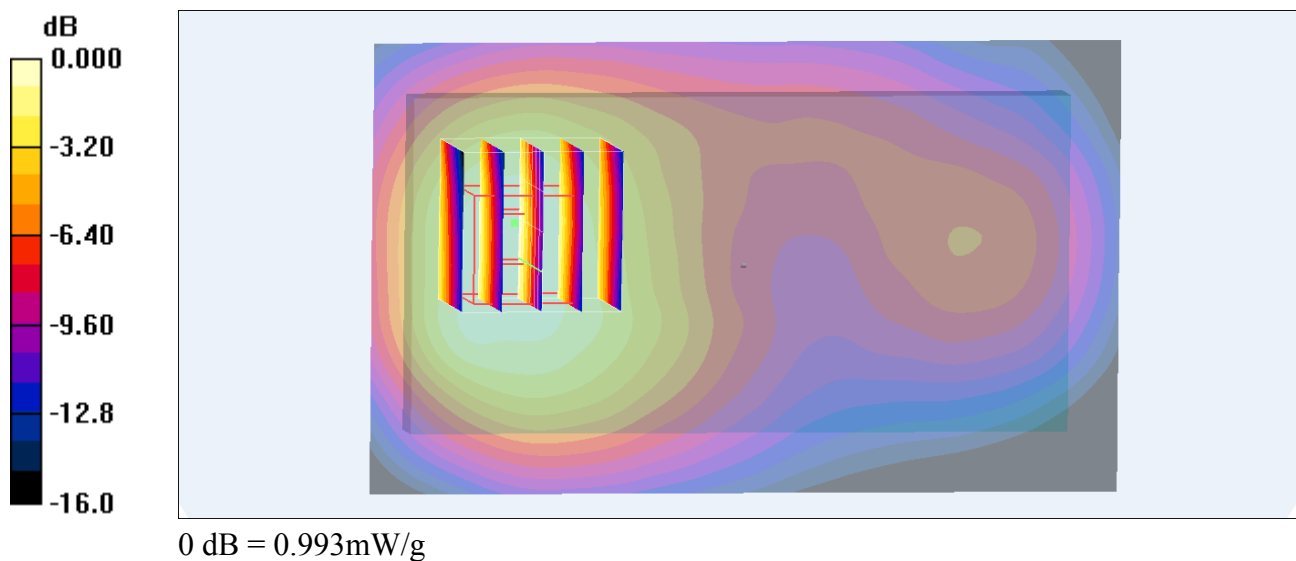

#12_WCDMA II_RMC12.2Kbps_Back_1cm_Ch9538

DUT: 370213

Communication System: WCDMA; Frequency: 1907.6 MHz; Duty Cycle: 1:1

Medium: MSL_1900_130709 Medium parameters used: $f = 1908$ MHz; $\sigma = 1.54$ mho/m; $\epsilon_r = 52.6$; $\rho = 1000$ kg/m³

Ambient Temperature : 23.5 °C ; Liquid Temperature : 22.5 °C

DASY4 Configuration:

- Probe: ET3DV6R - SN1788; ConvF(4.15, 4.15, 4.15); Calibrated: 2012/10/23
- Sensor-Surface: 4mm (Mechanical Surface Detection)
- Electronics: DAE3 Sn577; Calibrated: 2013/5/8
- Phantom: SAM_Right; Type: SAM; Serial: TP-1303
- Measurement SW: DASY4, V4.7 Build 80; Postprocessing SW: SEMCAD, V1.8 Build 186

Ch9538/Area Scan (61x101x1): Measurement grid: dx=15mm, dy=15mm

Maximum value of SAR (interpolated) = 1.15 mW/g

Ch9538/Zoom Scan (5x5x7)/Cube 0: Measurement grid: dx=8mm, dy=8mm, dz=5mm

Reference Value = 28.7 V/m; Power Drift = 0.056 dB

Peak SAR (extrapolated) = 1.68 W/kg

SAR(1 g) = 1.08 mW/g; SAR(10 g) = 0.654 mW/g

Maximum value of SAR (measured) = 1.15 mW/g

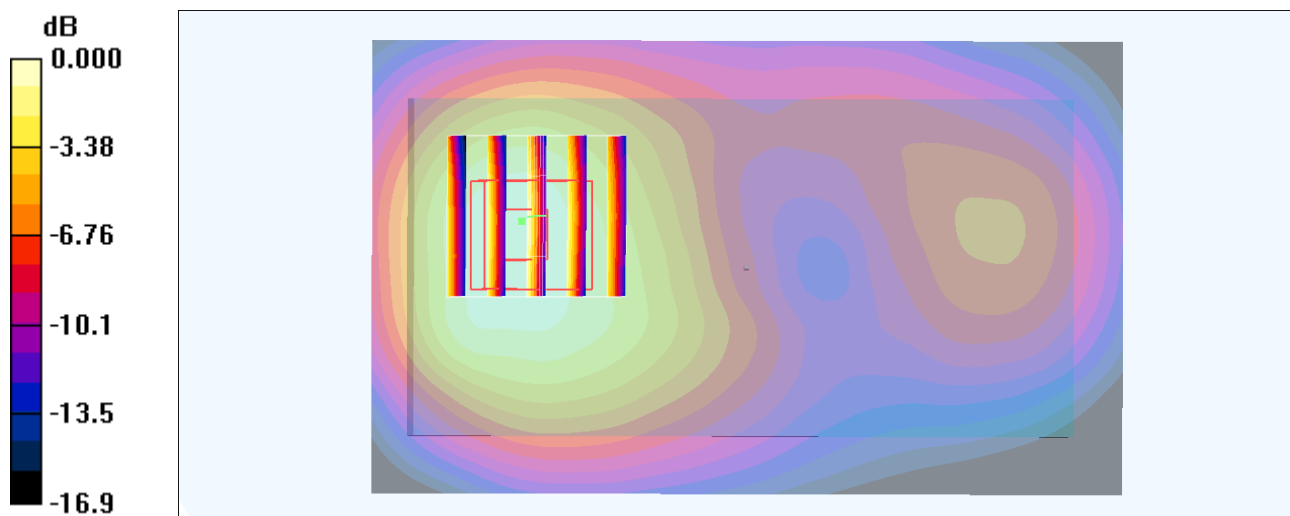

0 dB = 1.15mW/g

#25_WCDMA II_RMC12.2Kbps_Back_1cm_Ch9538;Repeat

DUT: 370213

Communication System: WCDMA; Frequency: 1907.6 MHz; Duty Cycle: 1:1

Medium: MSL_1900_130709 Medium parameters used: $f = 1908$ MHz; $\sigma = 1.54$ mho/m; $\epsilon_r = 52.6$; $\rho = 1000$ kg/m³

Ambient Temperature : 23.5 °C ; Liquid Temperature : 22.5 °C

DASY4 Configuration:

- Probe: ET3DV6R - SN1788; ConvF(4.15, 4.15, 4.15); Calibrated: 2012/10/23
- Sensor-Surface: 4mm (Mechanical Surface Detection)
- Electronics: DAE3 Sn577; Calibrated: 2013/5/8
- Phantom: SAM_Right; Type: SAM; Serial: TP-1303
- Measurement SW: DASY4, V4.7 Build 80; Postprocessing SW: SEMCAD, V1.8 Build 186

Ch9538/Area Scan (61x101x1): Measurement grid: dx=15mm, dy=15mm

Maximum value of SAR (interpolated) = 1.14 mW/g

Ch9538/Zoom Scan (5x5x7)/Cube 0: Measurement grid: dx=8mm, dy=8mm, dz=5mm

Reference Value = 29.1 V/m; Power Drift = -0.018 dB

Peak SAR (extrapolated) = 1.64 W/kg

SAR(1 g) = 1.06 mW/g; SAR(10 g) = 0.647 mW/g

Maximum value of SAR (measured) = 1.14 mW/g

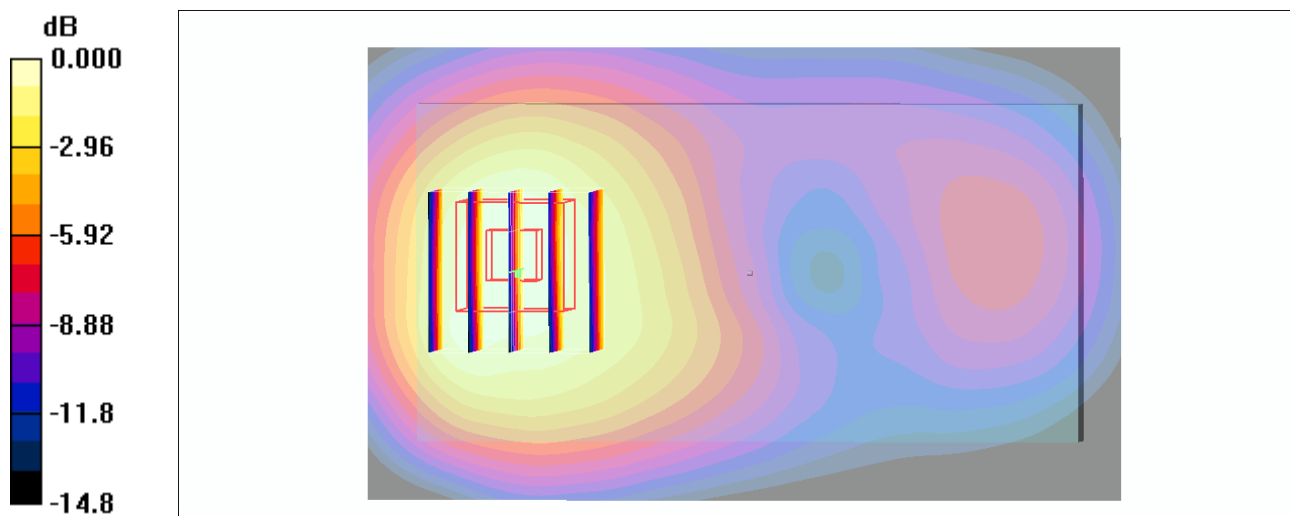

0 dB = 1.14mW/g

#19_WCDMA II_RMC12.2Kbps_Left Side_1cm_Ch9400

DUT: 370213

Communication System: WCDMA; Frequency: 1880 MHz; Duty Cycle: 1:1

Medium: MSL_1900_130709 Medium parameters used: $f = 1880$ MHz; $\sigma = 1.51$ mho/m; $\epsilon_r = 52.7$; $\rho = 1000$ kg/m³

Ambient Temperature : 23.5 °C ; Liquid Temperature : 22.5 °C

DASY4 Configuration:

- Probe: ET3DV6R - SN1788; ConvF(4.15, 4.15, 4.15); Calibrated: 2012/10/23
- Sensor-Surface: 4mm (Mechanical Surface Detection)
- Electronics: DAE3 Sn577; Calibrated: 2013/5/8
- Phantom: SAM_Right; Type: SAM; Serial: TP-1303
- Measurement SW: DASY4, V4.7 Build 80; Postprocessing SW: SEMCAD, V1.8 Build 186

Ch9400/Area Scan (41x101x1): Measurement grid: dx=15mm, dy=15mm

Maximum value of SAR (interpolated) = 0.374 mW/g

Ch9400/Zoom Scan (5x5x7)/Cube 0: Measurement grid: dx=8mm, dy=8mm, dz=5mm

Reference Value = 14.3 V/m; Power Drift = 0.028 dB

Peak SAR (extrapolated) = 0.480 W/kg

SAR(1 g) = 0.296 mW/g; SAR(10 g) = 0.167 mW/g

Maximum value of SAR (measured) = 0.329 mW/g

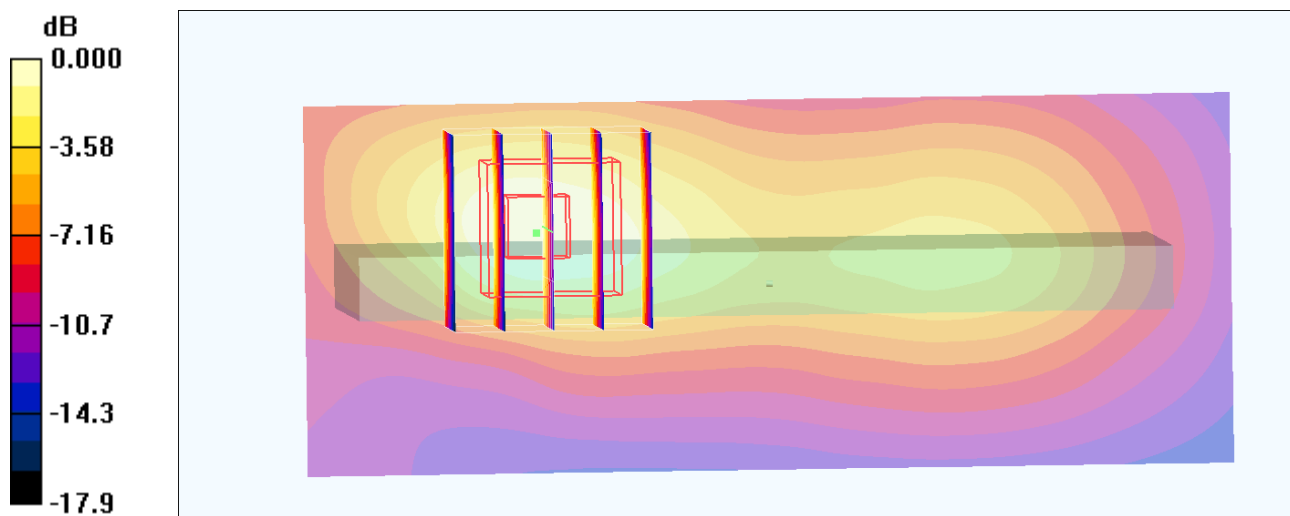

0 dB = 0.329mW/g

#20_WCDMA II_RMC12.2Kbps_Right Side_1cm_Ch9400

DUT: 370213

Communication System: WCDMA; Frequency: 1880 MHz; Duty Cycle: 1:1

Medium: MSL_1900_130709 Medium parameters used: $f = 1880$ MHz; $\sigma = 1.51$ mho/m; $\epsilon_r = 52.7$; $\rho = 1000$ kg/m³

Ambient Temperature : 23.5 °C ; Liquid Temperature : 22.5 °C

DASY4 Configuration:

- Probe: ET3DV6R - SN1788; ConvF(4.15, 4.15, 4.15); Calibrated: 2012/10/23
- Sensor-Surface: 4mm (Mechanical Surface Detection)
- Electronics: DAE3 Sn577; Calibrated: 2013/5/8
- Phantom: SAM_Right; Type: SAM; Serial: TP-1303
- Measurement SW: DASY4, V4.7 Build 80; Postprocessing SW: SEMCAD, V1.8 Build 186

Ch9400/Area Scan (41x101x1): Measurement grid: dx=15mm, dy=15mm

Maximum value of SAR (interpolated) = 0.116 mW/g

Ch9400/Zoom Scan (5x5x7)/Cube 0: Measurement grid: dx=8mm, dy=8mm, dz=5mm

Reference Value = 8.69 V/m; Power Drift = 0.013 dB

Peak SAR (extrapolated) = 0.152 W/kg

SAR(1 g) = 0.102 mW/g; SAR(10 g) = 0.063 mW/g

Maximum value of SAR (measured) = 0.110 mW/g

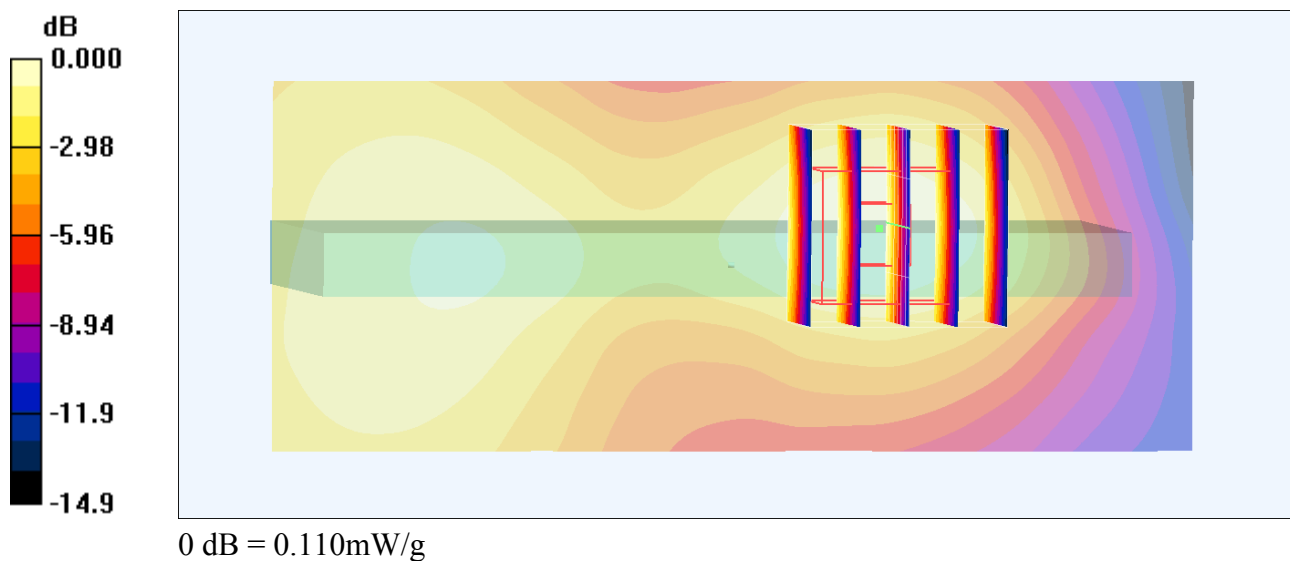

#22_WCDMA II_RMC12.2Kbps_Bottom Side_1cm_Ch9400**DUT: 370213**

Communication System: WCDMA; Frequency: 1880 MHz; Duty Cycle: 1:1

Medium: MSL_1900_130709 Medium parameters used: $f = 1880$ MHz; $\sigma = 1.51$ mho/m; $\epsilon_r = 52.7$; $\rho = 1000$ kg/m³

Ambient Temperature : 23.5 °C ; Liquid Temperature : 22.5 °C

DASY4 Configuration:

- Probe: ET3DV6R - SN1788; ConvF(4.15, 4.15, 4.15); Calibrated: 2012/10/23
- Sensor-Surface: 4mm (Mechanical Surface Detection)
- Electronics: DAE3 Sn577; Calibrated: 2013/5/8
- Phantom: SAM_Right; Type: SAM; Serial: TP-1303
- Measurement SW: DASY4, V4.7 Build 80; Postprocessing SW: SEMCAD, V1.8 Build 186

Ch9400/Area Scan (41x61x1): Measurement grid: dx=15mm, dy=15mm

Maximum value of SAR (interpolated) = 0.942 mW/g

Ch9400/Zoom Scan (5x5x7)/Cube 0: Measurement grid: dx=8mm, dy=8mm, dz=5mm

Reference Value = 23.1 V/m; Power Drift = 0.024 dB

Peak SAR (extrapolated) = 1.25 W/kg

SAR(1 g) = 0.805 mW/g; SAR(10 g) = 0.473 mW/g

Maximum value of SAR (measured) = 0.891 mW/g

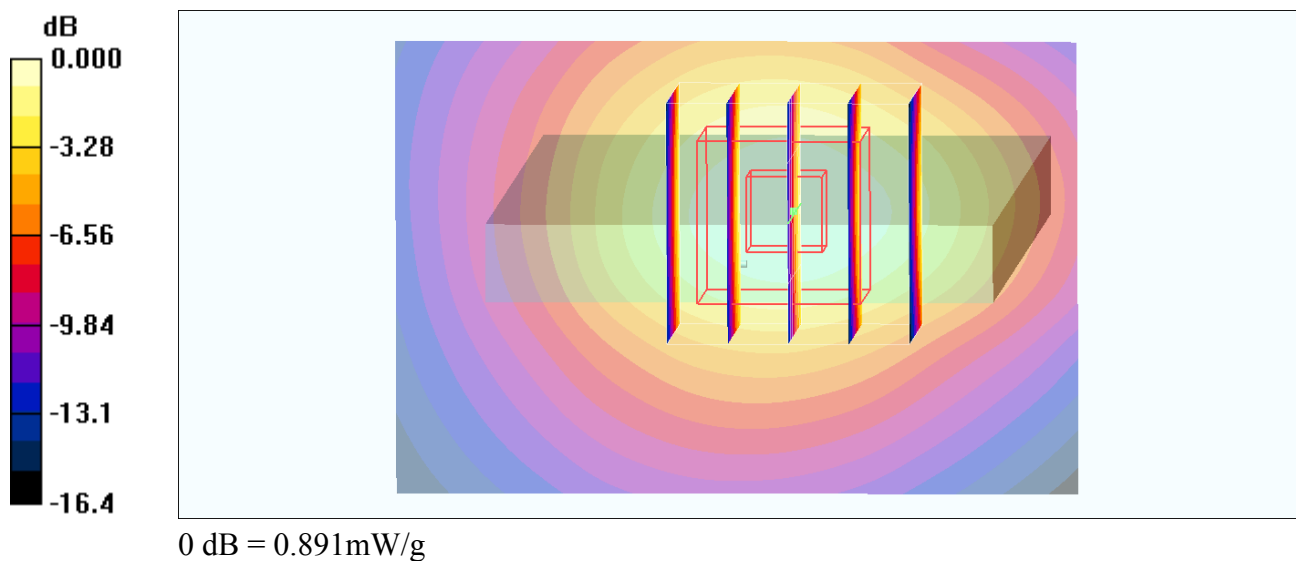

#23_WCDMA II_RMC12.2Kbps_Bottom Side_1cm_Ch9262

DUT: 370213

Communication System: WCDMA; Frequency: 1852.4 MHz; Duty Cycle: 1:1

Medium: MSL_1900_130709 Medium parameters used : $f = 1852.4$ MHz; $\sigma = 1.49$ mho/m; $\epsilon_r = 52.9$; $\rho = 1000$ kg/m³

Ambient Temperature : 23.5 °C; Liquid Temperature : 22.5 °C

DASY4 Configuration:

- Probe: ET3DV6R - SN1788; ConvF(4.15, 4.15, 4.15); Calibrated: 2012/10/23
- Sensor-Surface: 4mm (Mechanical Surface Detection)
- Electronics: DAE3 Sn577; Calibrated: 2013/5/8
- Phantom: SAM_Right; Type: SAM; Serial: TP-1303
- Measurement SW: DASY4, V4.7 Build 80; Postprocessing SW: SEMCAD, V1.8 Build 186

Ch9262/Area Scan (41x61x1): Measurement grid: dx=15mm, dy=15mm

Maximum value of SAR (interpolated) = 0.933 mW/g

Ch9262/Zoom Scan (5x5x7)/Cube 0: Measurement grid: dx=8mm, dy=8mm, dz=5mm

Reference Value = 23.4 V/m; Power Drift = 0.033 dB

Peak SAR (extrapolated) = 1.26 W/kg

SAR(1 g) = 0.818 mW/g; SAR(10 g) = 0.484 mW/g

Maximum value of SAR (measured) = 0.906 mW/g

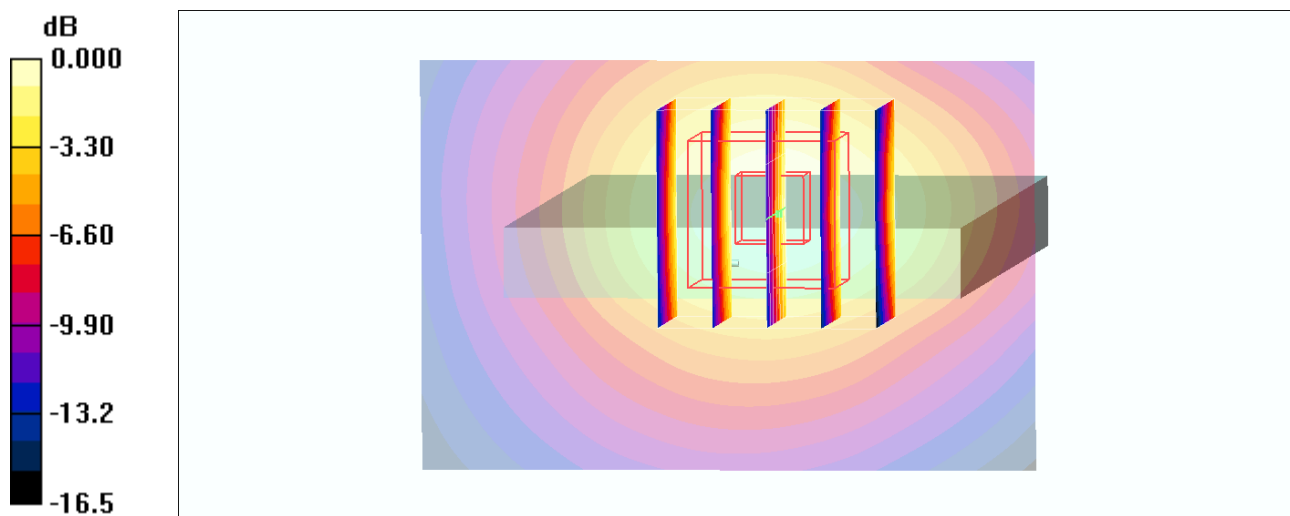

0 dB = 0.906mW/g

#24_WCDMA II_RMC12.2Kbps_Bottom Side_1cm_Ch9538**DUT: 370213**

Communication System: WCDMA; Frequency: 1907.6 MHz; Duty Cycle: 1:1

Medium: MSL_1900_130709 Medium parameters used: $f = 1908$ MHz; $\sigma = 1.54$ mho/m; $\epsilon_r = 52.6$; $\rho = 1000$ kg/m³

Ambient Temperature : 23.5 °C ; Liquid Temperature : 22.5 °C

DASY4 Configuration:

- Probe: ET3DV6R - SN1788; ConvF(4.15, 4.15, 4.15); Calibrated: 2012/10/23
- Sensor-Surface: 4mm (Mechanical Surface Detection)
- Electronics: DAE3 Sn577; Calibrated: 2013/5/8
- Phantom: SAM_Right; Type: SAM; Serial: TP-1303
- Measurement SW: DASY4, V4.7 Build 80; Postprocessing SW: SEMCAD, V1.8 Build 186

Ch9538/Area Scan (41x61x1): Measurement grid: dx=15mm, dy=15mm

Maximum value of SAR (interpolated) = 0.881 mW/g

Ch9538/Zoom Scan (5x5x7)/Cube 0: Measurement grid: dx=8mm, dy=8mm, dz=5mm

Reference Value = 22.6 V/m; Power Drift = -0.010 dB

Peak SAR (extrapolated) = 1.18 W/kg

SAR(1 g) = 0.750 mW/g; SAR(10 g) = 0.439 mW/g

Maximum value of SAR (measured) = 0.827 mW/g

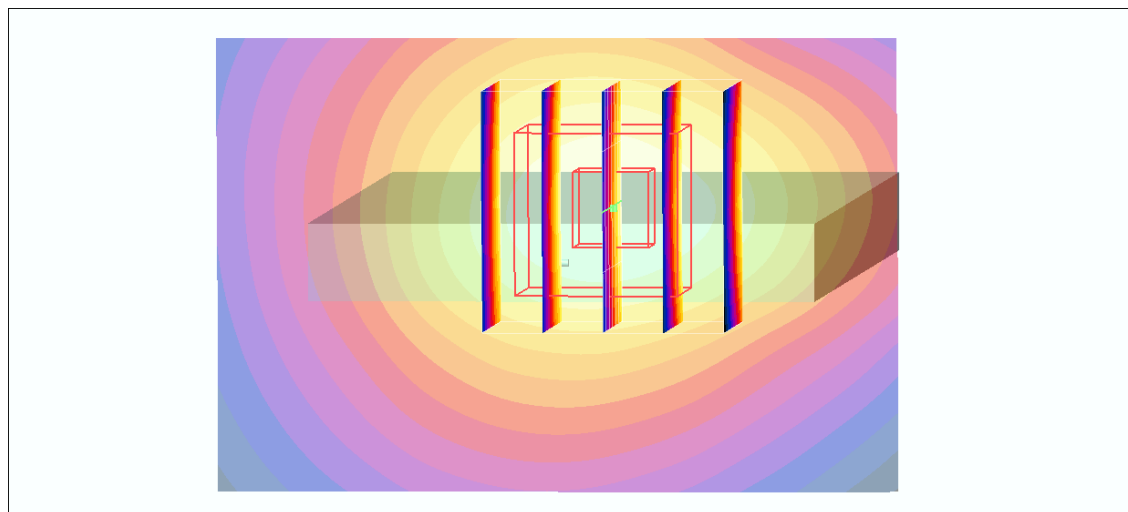
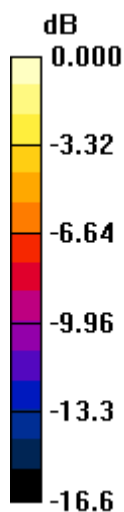

0 dB = 0.827mW/g

#13_WCDMA II_RMC12.2Kbps_Back_1cm_Ch9538;Headset 1

DUT: 370213

Communication System: WCDMA; Frequency: 1907.6 MHz; Duty Cycle: 1:1

Medium: MSL_1900_130709 Medium parameters used: $f = 1908$ MHz; $\sigma = 1.54$ mho/m; $\epsilon_r = 52.6$; $\rho = 1000$ kg/m³

Ambient Temperature : 23.5 °C ; Liquid Temperature : 22.5 °C

DASY4 Configuration:

- Probe: ET3DV6R - SN1788; ConvF(4.15, 4.15, 4.15); Calibrated: 2012/10/23
- Sensor-Surface: 4mm (Mechanical Surface Detection)
- Electronics: DAE3 Sn577; Calibrated: 2013/5/8
- Phantom: SAM_Right; Type: SAM; Serial: TP-1303
- Measurement SW: DASY4, V4.7 Build 80; Postprocessing SW: SEMCAD, V1.8 Build 186

Ch9538/Area Scan (61x101x1): Measurement grid: dx=15mm, dy=15mm

Maximum value of SAR (interpolated) = 1.06 mW/g

Ch9538/Zoom Scan (5x5x7)/Cube 0: Measurement grid: dx=8mm, dy=8mm, dz=5mm

Reference Value = 28.1 V/m; Power Drift = -0.007 dB

Peak SAR (extrapolated) = 1.55 W/kg

SAR(1 g) = 0.993 mW/g; SAR(10 g) = 0.601 mW/g

Maximum value of SAR (measured) = 1.07 mW/g

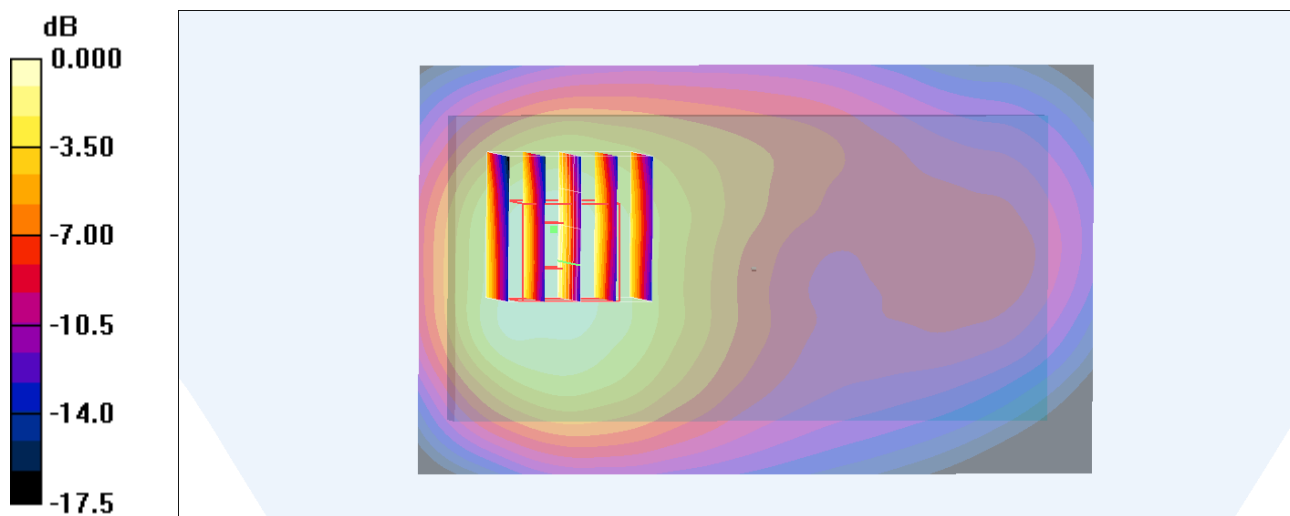

0 dB = 1.07mW/g

#15_WCDMA II_RMC12.2Kbps_Back_1cm_Ch9262;Headset 1

DUT: 370213

Communication System: WCDMA; Frequency: 1852.4 MHz; Duty Cycle: 1:1

Medium: MSL_1900_130709 Medium parameters used : $f = 1852.4$ MHz; $\sigma = 1.49$ mho/m; $\epsilon_r = 52.9$; $\rho = 1000$ kg/m³

Ambient Temperature : 23.5 °C ; Liquid Temperature : 22.5 °C

DASY4 Configuration:

- Probe: ET3DV6R - SN1788; ConvF(4.15, 4.15, 4.15); Calibrated: 2012/10/23
- Sensor-Surface: 4mm (Mechanical Surface Detection)
- Electronics: DAE3 Sn577; Calibrated: 2013/5/8
- Phantom: SAM_Right; Type: SAM; Serial: TP-1303
- Measurement SW: DASY4, V4.7 Build 80; Postprocessing SW: SEMCAD, V1.8 Build 186

Ch9262/Area Scan (61x101x1): Measurement grid: dx=15mm, dy=15mm

Maximum value of SAR (interpolated) = 0.963 mW/g

Ch9262/Zoom Scan (5x5x7)/Cube 0: Measurement grid: dx=8mm, dy=8mm, dz=5mm

Reference Value = 27.5 V/m; Power Drift = -0.122 dB

Peak SAR (extrapolated) = 1.39 W/kg

SAR(1 g) = 0.916 mW/g; SAR(10 g) = 0.566 mW/g

Maximum value of SAR (measured) = 0.990 mW/g

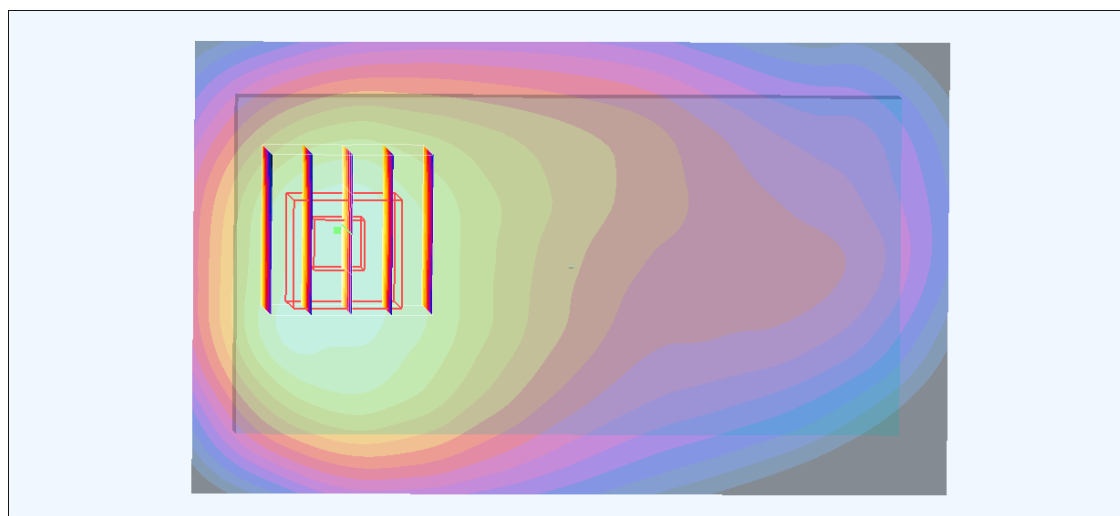
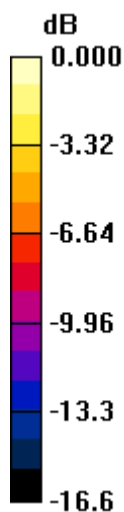

0 dB = 0.990mW/g

#14_WCDMA II_RMC12.2Kbps_Back_1cm_Ch9400;Headset 1**DUT: 370213**

Communication System: WCDMA; Frequency: 1880 MHz; Duty Cycle: 1:1

Medium: MSL_1900_130709 Medium parameters used: $f = 1880$ MHz; $\sigma = 1.51$ mho/m; $\epsilon_r = 52.7$; $\rho = 1000$ kg/m³

Ambient Temperature : 23.5 °C ; Liquid Temperature : 22.5 °C

DASY4 Configuration:

- Probe: ET3DV6R - SN1788; ConvF(4.15, 4.15, 4.15); Calibrated: 2012/10/23
- Sensor-Surface: 4mm (Mechanical Surface Detection)
- Electronics: DAE3 Sn577; Calibrated: 2013/5/8
- Phantom: SAM_Right; Type: SAM; Serial: TP-1303
- Measurement SW: DASY4, V4.7 Build 80; Postprocessing SW: SEMCAD, V1.8 Build 186

Ch9400/Area Scan (61x101x1): Measurement grid: dx=15mm, dy=15mm

Maximum value of SAR (interpolated) = 1.01 mW/g

Ch9400/Zoom Scan (5x5x7)/Cube 0: Measurement grid: dx=8mm, dy=8mm, dz=5mm

Reference Value = 27.7 V/m; Power Drift = 0.009 dB

Peak SAR (extrapolated) = 1.45 W/kg

SAR(1 g) = 0.941 mW/g; SAR(10 g) = 0.574 mW/g

Maximum value of SAR (measured) = 1.00 mW/g

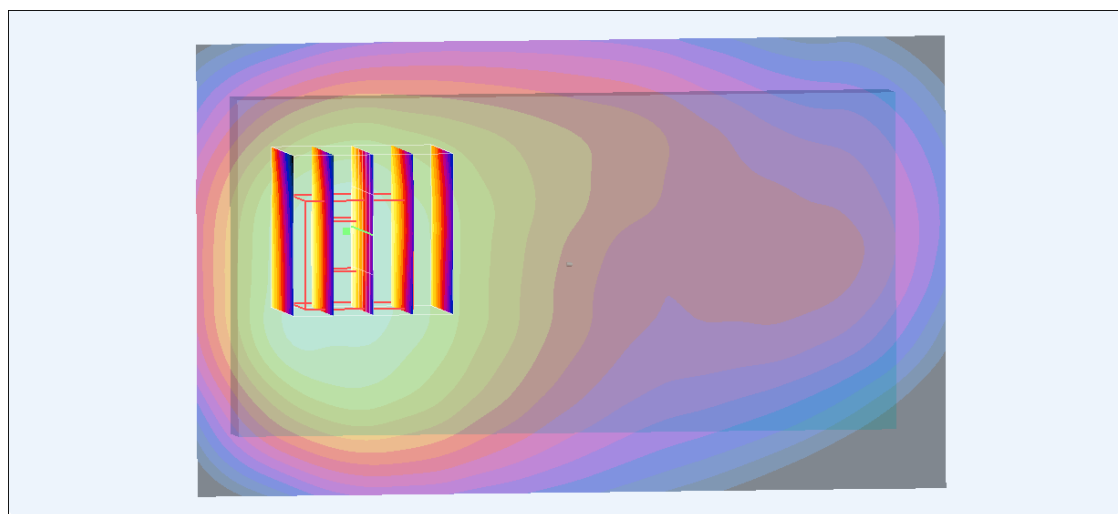
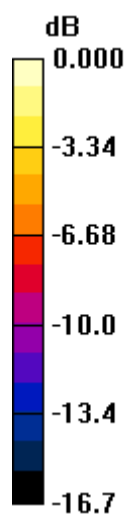

0 dB = 1.00mW/g

#16_WCDMA II_RMC12.2Kbps_Back_1cm_Ch9538;Headset 4

DUT: 370213

Communication System: WCDMA; Frequency: 1907.6 MHz; Duty Cycle: 1:1

Medium: MSL_1900_130709 Medium parameters used: $f = 1908$ MHz; $\sigma = 1.54$ mho/m; $\epsilon_r = 52.6$; $\rho = 1000$ kg/m³

Ambient Temperature : 23.5 °C ; Liquid Temperature : 22.5 °C

DASY4 Configuration:

- Probe: ET3DV6R - SN1788; ConvF(4.15, 4.15, 4.15); Calibrated: 2012/10/23
- Sensor-Surface: 4mm (Mechanical Surface Detection)
- Electronics: DAE3 Sn577; Calibrated: 2013/5/8
- Phantom: SAM_Right; Type: SAM; Serial: TP-1303
- Measurement SW: DASY4, V4.7 Build 80; Postprocessing SW: SEMCAD, V1.8 Build 186

Ch9538/Area Scan (61x101x1): Measurement grid: dx=15mm, dy=15mm

Maximum value of SAR (interpolated) = 1.05 mW/g

Ch9538/Zoom Scan (5x5x7)/Cube 0: Measurement grid: dx=8mm, dy=8mm, dz=5mm

Reference Value = 28.3 V/m; Power Drift = 0.012 dB

Peak SAR (extrapolated) = 1.56 W/kg

SAR(1 g) = 0.995 mW/g; SAR(10 g) = 0.596 mW/g

Maximum value of SAR (measured) = 1.07 mW/g

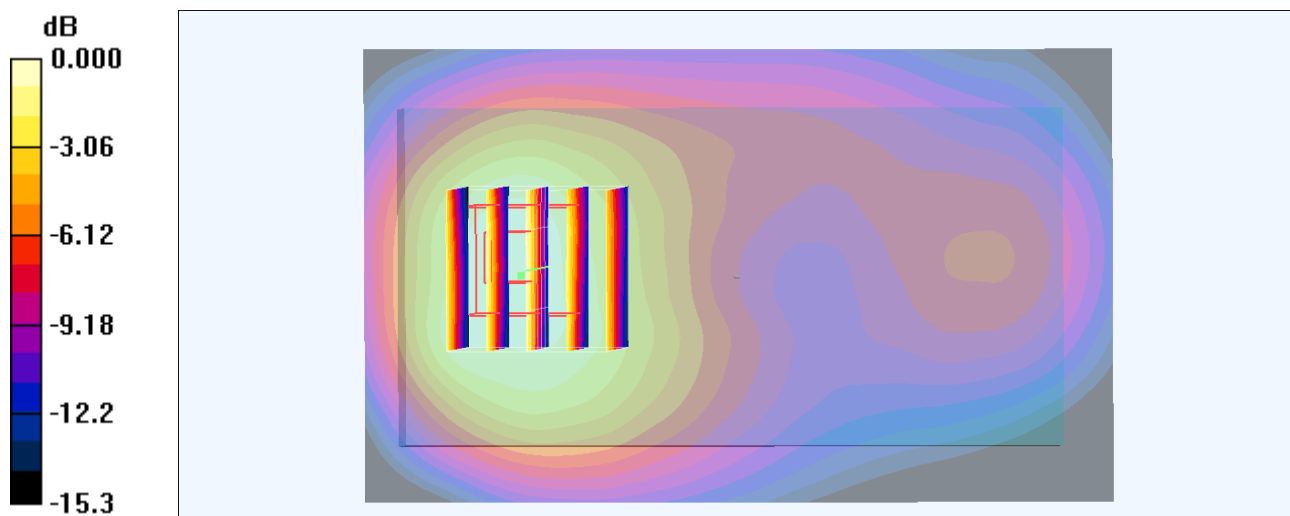

0 dB = 1.07mW/g

#17_WCDMA II_RMC12.2Kbps_Back_1cm_Ch9262;Headset 4

DUT: 370213

Communication System: WCDMA; Frequency: 1852.4 MHz; Duty Cycle: 1:1

Medium: MSL_1900_130709 Medium parameters used : $f = 1852.4$ MHz; $\sigma = 1.49$ mho/m; $\epsilon_r = 52.9$; $\rho = 1000$ kg/m³

Ambient Temperature : 23.5 °C ; Liquid Temperature : 22.5 °C

DASY4 Configuration:

- Probe: ET3DV6R - SN1788; ConvF(4.15, 4.15, 4.15); Calibrated: 2012/10/23
- Sensor-Surface: 4mm (Mechanical Surface Detection)
- Electronics: DAE3 Sn577; Calibrated: 2013/5/8
- Phantom: SAM_Right; Type: SAM; Serial: TP-1303
- Measurement SW: DASY4, V4.7 Build 80; Postprocessing SW: SEMCAD, V1.8 Build 186

Ch9262/Area Scan (61x101x1): Measurement grid: dx=15mm, dy=15mm

Maximum value of SAR (interpolated) = 0.916 mW/g

Ch9262/Zoom Scan (5x5x7)/Cube 0: Measurement grid: dx=8mm, dy=8mm, dz=5mm

Reference Value = 26.8 V/m; Power Drift = 0.048 dB

Peak SAR (extrapolated) = 1.32 W/kg

SAR(1 g) = 0.877 mW/g; SAR(10 g) = 0.544 mW/g

Maximum value of SAR (measured) = 0.958 mW/g

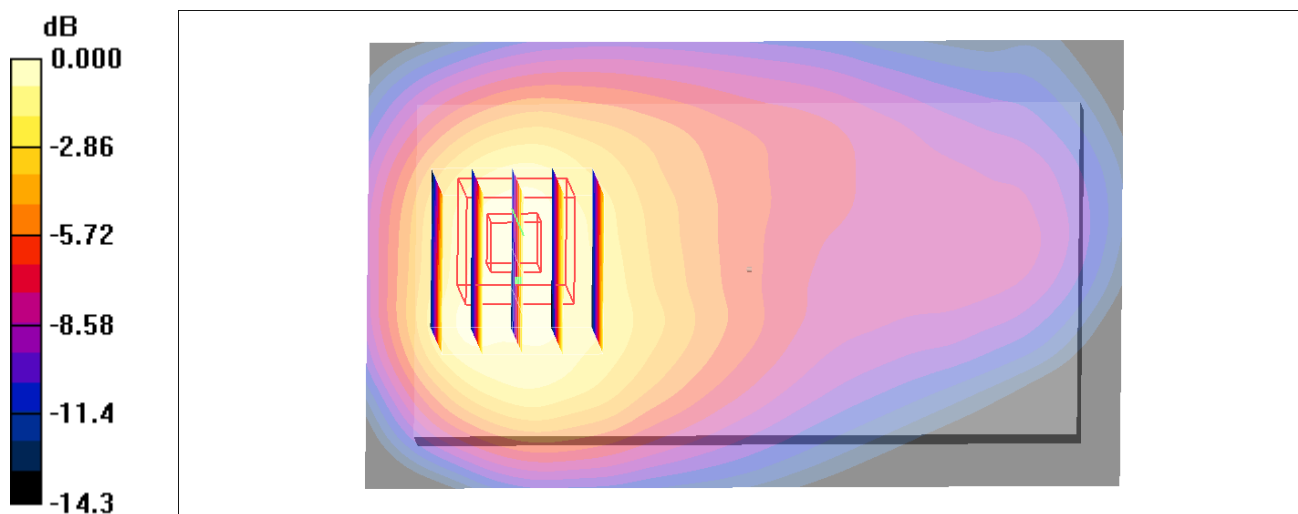

0 dB = 0.958mW/g

#18_WCDMA II_RMC12.2Kbps_Back_1cm_Ch9400;Headset 4

DUT: 370213

Communication System: WCDMA; Frequency: 1880 MHz; Duty Cycle: 1:1

Medium: MSL_1900_130709 Medium parameters used: $f = 1880$ MHz; $\sigma = 1.51$ mho/m; $\epsilon_r = 52.7$; $\rho = 1000$ kg/m³

Ambient Temperature : 23.5 °C ; Liquid Temperature : 22.5 °C

DASY4 Configuration:

- Probe: ET3DV6R - SN1788; ConvF(4.15, 4.15, 4.15); Calibrated: 2012/10/23
- Sensor-Surface: 4mm (Mechanical Surface Detection)
- Electronics: DAE3 Sn577; Calibrated: 2013/5/8
- Phantom: SAM_Right; Type: SAM; Serial: TP-1303
- Measurement SW: DASY4, V4.7 Build 80; Postprocessing SW: SEMCAD, V1.8 Build 186

Ch9400/Area Scan (61x101x1): Measurement grid: dx=15mm, dy=15mm

Maximum value of SAR (interpolated) = 0.986 mW/g

Ch9400/Zoom Scan (5x5x7)/Cube 0: Measurement grid: dx=8mm, dy=8mm, dz=5mm

Reference Value = 27.3 V/m; Power Drift = -0.006 dB

Peak SAR (extrapolated) = 1.39 W/kg

SAR(1 g) = 0.904 mW/g; SAR(10 g) = 0.555 mW/g

Maximum value of SAR (measured) = 0.995 mW/g

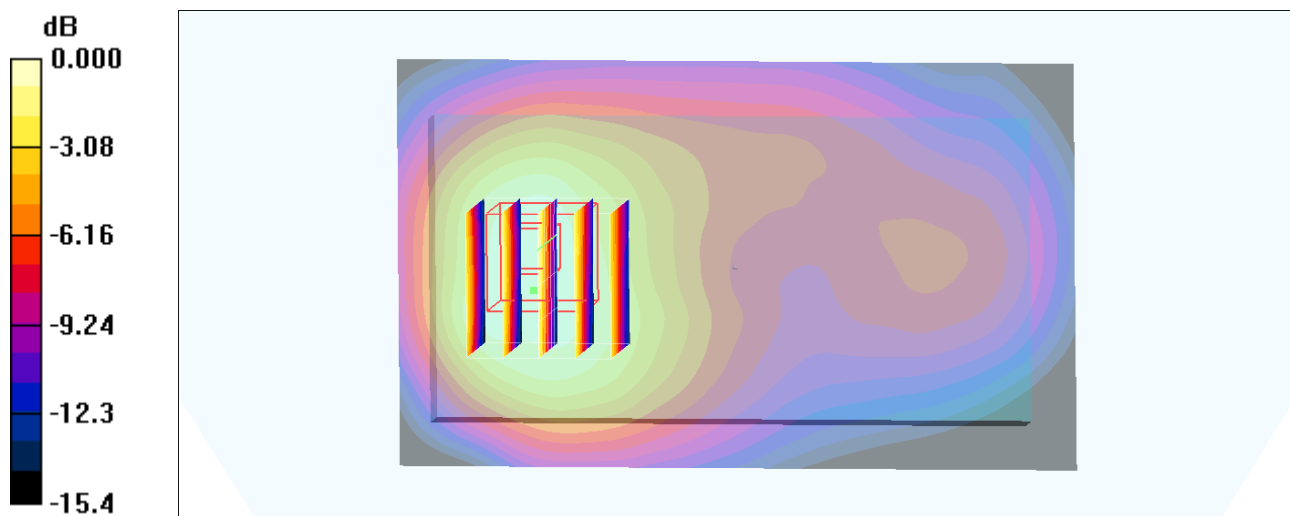

0 dB = 0.995mW/g

#73_WLAN2.4GHz_802.11b 1Mbps_Front_1cm_Ch6

DUT: 370213

Communication System: 802.11b; Frequency: 2437 MHz; Duty Cycle: 1:1

Medium: MSL_2450_130711 Medium parameters used: $f = 2437$ MHz; $\sigma = 2.001$ mho/m; $\epsilon_r = 53.912$; ρ

$= 1000$ kg/m³

Ambient Temperature : 23.4 °C; Liquid Temperature : 22.4 °C

DASY5 Configuration:

- Probe: EX3DV4 - SN3925; ConvF(7.44, 7.44, 7.44); Calibrated: 2013/6/12;
- Sensor-Surface: 2mm (Mechanical Surface Detection)
- Electronics: DAE3 Sn495; Calibrated: 2013/5/8
- Phantom: SAM Right; Type: QD000P40CC; Serial: TP:1383
- Measurement SW: DASY52, Version 52.8 (3); SEMCAD X Version 14.6.5 (6469)

Configuration/Ch6/Area Scan (81x131x1): Measurement grid: dx=12mm, dy=12mm
Maximum value of SAR (interpolated) = 0.150 mW/g

Configuration/Ch6/Zoom Scan (7x7x7)/Cube 0: Measurement grid: dx=5mm, dy=5mm, dz=5mm

Reference Value = 8.670 V/m; Power Drift = 0.10 dB

Peak SAR (extrapolated) = 0.222 mW/g

SAR(1 g) = 0.110 mW/g; SAR(10 g) = 0.056 mW/g

Maximum value of SAR (measured) = 0.164 mW/g

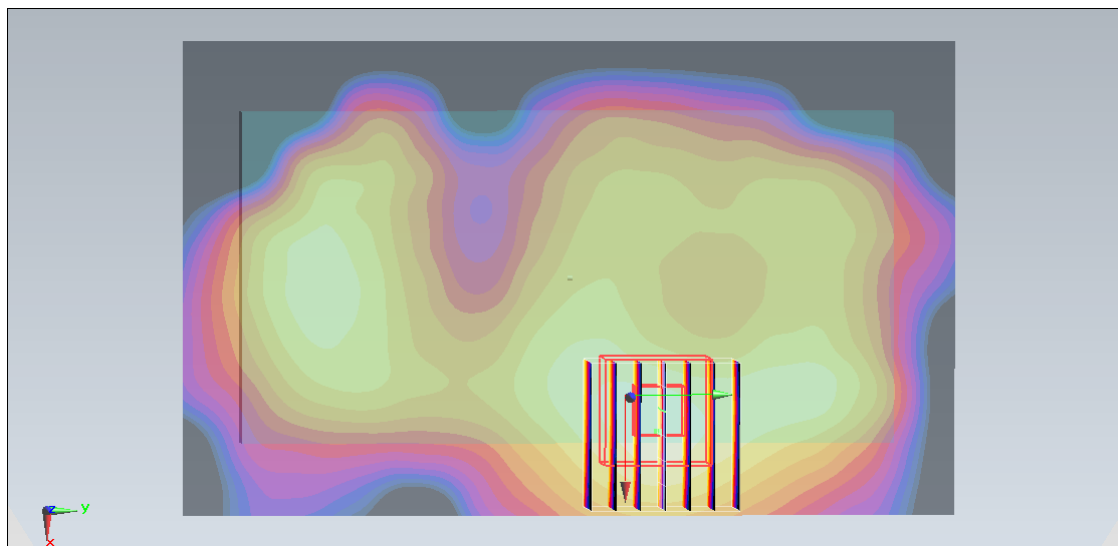
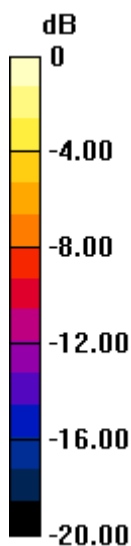

0 dB = 0.164 mW/g = -15.70 dB mW/g

#74_WLAN2.4GHz_802.11b 1Mbps_Back_1cm_Ch6

DUT: 370213

Communication System: 802.11b; Frequency: 2437 MHz; Duty Cycle: 1:1

Medium: MSL_2450_130711 Medium parameters used: $f = 2437$ MHz; $\sigma = 2.001$ mho/m; $\epsilon_r = 53.912$; ρ

$= 1000$ kg/m³

Ambient Temperature : 23.4 °C; Liquid Temperature : 22.4 °C

DASY5 Configuration:

- Probe: EX3DV4 - SN3925; ConvF(7.44, 7.44, 7.44); Calibrated: 2013/6/12;
- Sensor-Surface: 2mm (Mechanical Surface Detection)
- Electronics: DAE3 Sn495; Calibrated: 2013/5/8
- Phantom: SAM Right; Type: QD000P40CC; Serial: TP:1383
- Measurement SW: DASY52, Version 52.8 (3); SEMCAD X Version 14.6.5 (6469)

Configuration/Ch6/Area Scan (81x131x1): Measurement grid: dx=12mm, dy=12mm
Maximum value of SAR (interpolated) = 0.417 mW/g

Configuration/Ch6/Zoom Scan (7x7x7)/Cube 0: Measurement grid: dx=5mm, dy=5mm, dz=5mm

Reference Value = 14.641 V/m; Power Drift = 0.06 dB

Peak SAR (extrapolated) = 0.557 mW/g

SAR(1 g) = 0.302 mW/g; SAR(10 g) = 0.157 mW/g

Maximum value of SAR (measured) = 0.422 mW/g

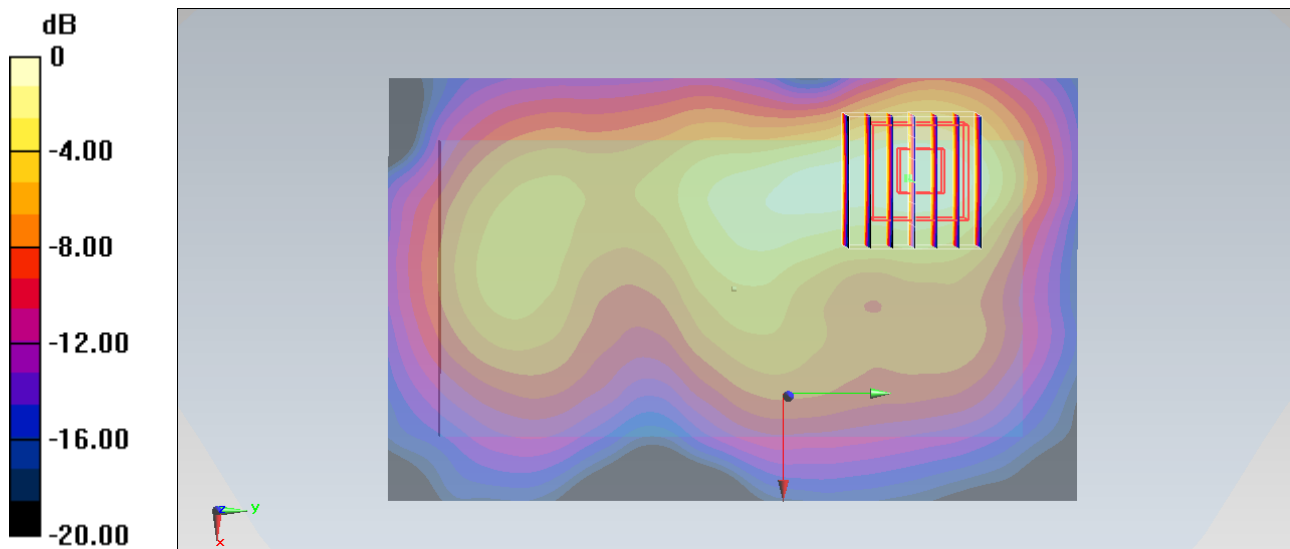

0 dB = 0.422 mW/g = -7.49 dB mW/g

#75_WLAN2.4GHz_802.11b 1Mbps_Left Side_1cm_Ch6

DUT: 370213

Communication System: 802.11b; Frequency: 2437 MHz; Duty Cycle: 1:1

Medium: MSL_2450_130711 Medium parameters used: $f = 2437$ MHz; $\sigma = 2.001$ mho/m; $\epsilon_r = 53.912$; ρ

$= 1000$ kg/m³

Ambient Temperature : 23.4 °C; Liquid Temperature : 22.4 °C

DASY5 Configuration:

- Probe: EX3DV4 - SN3925; ConvF(7.44, 7.44, 7.44); Calibrated: 2013/6/12;
- Sensor-Surface: 2mm (Mechanical Surface Detection)
- Electronics: DAE3 Sn495; Calibrated: 2013/5/8
- Phantom: SAM Right; Type: QD000P40CC; Serial: TP:1383
- Measurement SW: DASY52, Version 52.8 (3); SEMCAD X Version 14.6.5 (6469)

Configuration/Ch6/Area Scan (41x131x1): Measurement grid: dx=12mm, dy=12mm

Maximum value of SAR (interpolated) = 0.0377 mW/g

Configuration/Ch6/Zoom Scan (7x7x7)/Cube 0: Measurement grid: dx=5mm, dy=5mm, dz=5mm

Reference Value = 3.811 V/m; Power Drift = -0.04 dB

Peak SAR (extrapolated) = 0.101 mW/g

SAR(1 g) = 0.018 mW/g; SAR(10 g) = 0.00741 mW/g

Maximum value of SAR (measured) = 0.0277 mW/g

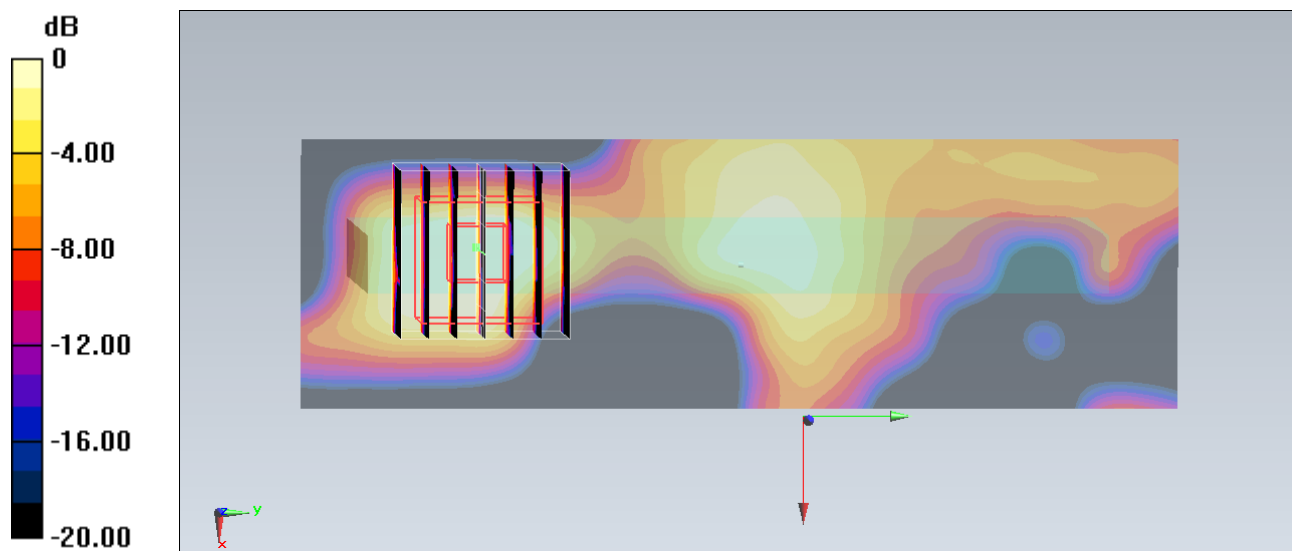

0 dB = 0.0277 mW/g = -31.15 dB mW/g

#76_WLAN2.4GHz_802.11b 1Mbps_Right Side_1cm_Ch6

DUT: 370213

Communication System: 802.11b; Frequency: 2437 MHz; Duty Cycle: 1:1

Medium: MSL_2450_130711 Medium parameters used: $f = 2437 \text{ MHz}$; $\sigma = 2.001 \text{ mho/m}$; $\epsilon_r = 53.912$; ρ

$= 1000 \text{ kg/m}^3$

Ambient Temperature : $23.4 \text{ }^\circ\text{C}$; Liquid Temperature : $22.4 \text{ }^\circ\text{C}$

DASY5 Configuration:

- Probe: EX3DV4 - SN3925; ConvF(7.44, 7.44, 7.44); Calibrated: 2013/6/12;
- Sensor-Surface: 2mm (Mechanical Surface Detection)
- Electronics: DAE3 Sn495; Calibrated: 2013/5/8
- Phantom: SAM Right; Type: QD000P40CC; Serial: TP:1383
- Measurement SW: DASY52, Version 52.8 (3); SEMCAD X Version 14.6.5 (6469)

Configuration/Ch6/Area Scan (41x131x1): Measurement grid: $dx=12\text{mm}$, $dy=12\text{mm}$
 Maximum value of SAR (interpolated) = 0.282 mW/g

Configuration/Ch6/Zoom Scan (7x7x7)/Cube 0: Measurement grid: $dx=5\text{mm}$, $dy=5\text{mm}$,
 $dz=5\text{mm}$

Reference Value = 11.673 V/m ; Power Drift = 0.05 dB

Peak SAR (extrapolated) = 0.352 mW/g

SAR(1 g) = 0.184 mW/g ; SAR(10 g) = 0.094 mW/g

Maximum value of SAR (measured) = 0.266 mW/g

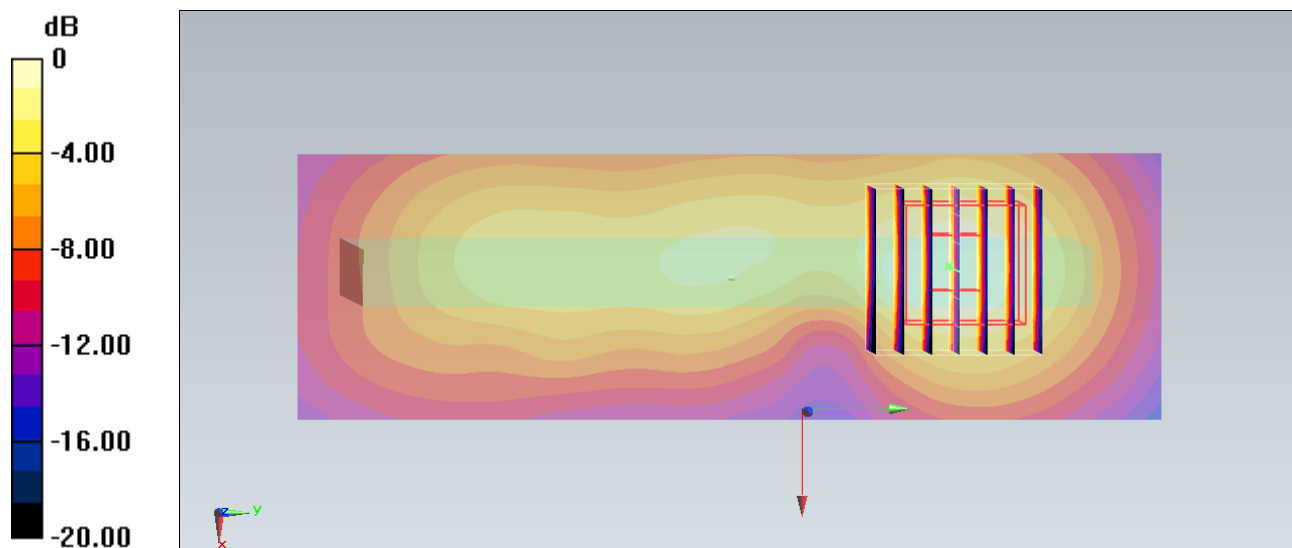

0 dB = 0.266 mW/g = -11.50 dB mW/g

#83_WLAN2.4GHz_802.11b 1Mbps_Back_1cm_Ch6;Headset 1

DUT: 370213

Communication System: 802.11b; Frequency: 2437 MHz; Duty Cycle: 1:1

Medium: MSL_2450_130711 Medium parameters used: $f = 2437$ MHz; $\sigma = 2.001$ mho/m; $\epsilon_r = 53.912$; ρ

$= 1000$ kg/m³

Ambient Temperature : 23.4 °C; Liquid Temperature : 22.4 °C

DASY5 Configuration:

- Probe: EX3DV4 - SN3925; ConvF(7.44, 7.44, 7.44); Calibrated: 2013/6/12;
- Sensor-Surface: 2mm (Mechanical Surface Detection)
- Electronics: DAE3 Sn495; Calibrated: 2013/5/8
- Phantom: SAM Right; Type: QD000P40CC; Serial: TP:1383
- Measurement SW: DASY52, Version 52.8 (3); SEMCAD X Version 14.6.5 (6469)

Configuration/Ch6/Area Scan (81x131x1): Measurement grid: dx=12mm, dy=12mm
Maximum value of SAR (interpolated) = 0.314 mW/g

Configuration/Ch6/Zoom Scan (7x7x7)/Cube 0: Measurement grid: dx=5mm, dy=5mm, dz=5mm

Reference Value = 11.768 V/m; Power Drift = 0.10 dB

Peak SAR (extrapolated) = 0.392 mW/g

SAR(1 g) = 0.183 mW/g; SAR(10 g) = 0.090 mW/g

Maximum value of SAR (measured) = 0.275 mW/g

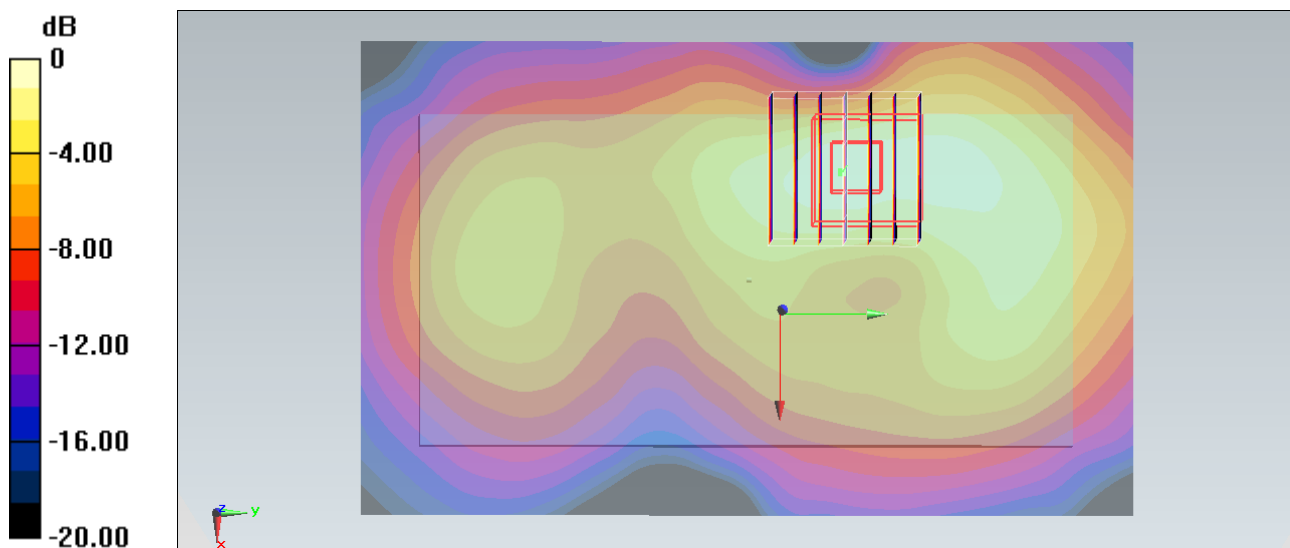

0 dB = 0.275 mW/g = -11.21 dB mW/g

#84_WLAN2.4GHz_802.11b 1Mbps_Back_1cm_Ch6;Headset 4

DUT: 370213

Communication System: 802.11b; Frequency: 2437 MHz; Duty Cycle: 1:1

Medium: MSL_2450_130711 Medium parameters used: $f = 2437$ MHz; $\sigma = 2.001$ mho/m; $\epsilon_r = 53.912$; ρ

$= 1000$ kg/m³

Ambient Temperature : 23.4 °C; Liquid Temperature : 22.4 °C

DASY5 Configuration:

- Probe: EX3DV4 - SN3925; ConvF(7.44, 7.44, 7.44); Calibrated: 2013/6/12;
- Sensor-Surface: 2mm (Mechanical Surface Detection)
- Electronics: DAE3 Sn495; Calibrated: 2013/5/8
- Phantom: SAM Right; Type: QD000P40CC; Serial: TP:1383
- Measurement SW: DASY52, Version 52.8 (3); SEMCAD X Version 14.6.5 (6469)

Configuration/Ch6/Area Scan (81x131x1): Measurement grid: dx=12mm, dy=12mm
Maximum value of SAR (interpolated) = 0.334 mW/g

Configuration/Ch6/Zoom Scan (7x7x7)/Cube 0: Measurement grid: dx=5mm, dy=5mm, dz=5mm

Reference Value = 12.346 V/m; Power Drift = 0.00 dB

Peak SAR (extrapolated) = 0.414 mW/g

SAR(1 g) = 0.196 mW/g; SAR(10 g) = 0.099 mW/g

Maximum value of SAR (measured) = 0.295 mW/g

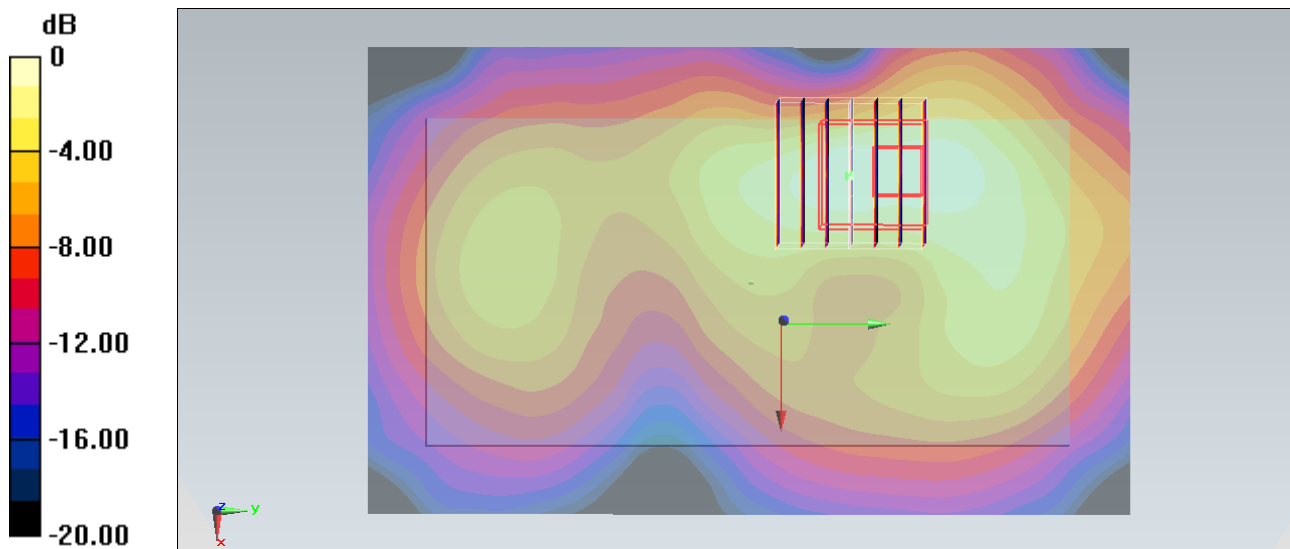

0 dB = 0.295 mW/g = -10.60 dB mW/g