

# **RF Measurement Report**

**Prepared by:**

## **National Certification Laboratory**

**8370 Court Avenue, Suite B-1  
Ellicott City, Maryland 21043  
(410) 461-5548**

**In Support of:**

**FCC APPLICATION FOR CERTIFICATION**

**For:**

**Young Design, Inc.  
308 Hillwood Avenue  
Falls Church, Virginia 22046**

**Model: Lucent WaveLAN Silver Card with AMP2440 Amplifier**

**Demonstration of Compliance with FCC Rules Part 15.247**

**November 24, 2000**



## TABLE OF CONTENTS

- 1.0 Introduction
- 1.1 Summary
- 2.0 Description of Equipment Under Test (EUT)
- 2.1 EMI Countermeasure
- 3.0 Test Program
- 4.0 Test Configuration for Antenna Terminal Conducted
- 5.0 Test Configuraton for A.C. Conducted and Radiated
- 6.0 A.C. Conducted Emissions Scheme
- 7.0 Radiated Emissions Scheme

### **TABLES**

- Table 1. EUT Optional Antennas
- Table 2. Support Equipment
- Table 3. Measurement Equipment

RF Exposure Statement

### **EXHIBITS**

- Exhibit 1. EUT Photographs
- Exhibit 2. Schematic Diagram
- Exhibit 3. User Manual

***NCL PROJ.# Young-559***



## **1.0 Introduction:**

This report has been prepared on behalf of **Young Design, Inc.**, to support the attached Application for a Certification of a Part 15 Spread Spectrum Transmitter. The Equipment Under Test (EUT) was the **Lucent/OriNOCO WaveLAN Silver Card with Model AMP2440-xxF Amplifier.**

Radio-Noise Emissions tests were performed according to *FCC Public Notice 54797, titled "Guidance on Measurement for Direct Sequence SST"*. The measuring equipment conforms to ANSI C63.2 Specifications for Electromagnetic Noise and Field Strength Instrumentation.

Testing was performed at National Certification Laboratory in Ellicott City, MD. Site description and site attenuation data have been placed on file with the FCC's sampling and Measurements Branch. FCC acceptance was granted on May 26, 1993.

## **1.1 Summary:**

The Young Design, Inc., **Lucent WaveLAN Silver Card with Model: AMP2440-RxF Amplifier**, and a suite of specific antennas complies with the FCC limits (15.247) for a Direct Sequence SST. Tests were performed on IEEE 802.11 radio channels 1, 6, and 11. These are referred to in the report as the low, mid and high channels respectively.

## **2.0 Description of Equipment Under Test (EUT):**

The **Lucent WaveLAN Silver Card** is currently certified with FCCID: **IMRWLPCE24H**. Young Design, Inc. has not modified this product in any manner except for the addition of high gain antennas, and an external amplifier.

### **Professional Installation Requirement:**

The amplifier unit incorporates a standard N connector to the antenna, therefore requiring professional installation. The User Manual specifies that only trained certified technicians should install the **AMP2440-xxF Amplifier**. There are many technical steps needed to install an operating system as outlined in the manual. These include antenna support structure, site survey, antenna alignment, test, and troubleshoot. All systems sold to businesses are installed under the supervision of Young Design, Inc. Marketing is limited to sales by authorized dealers.

The EUT features:

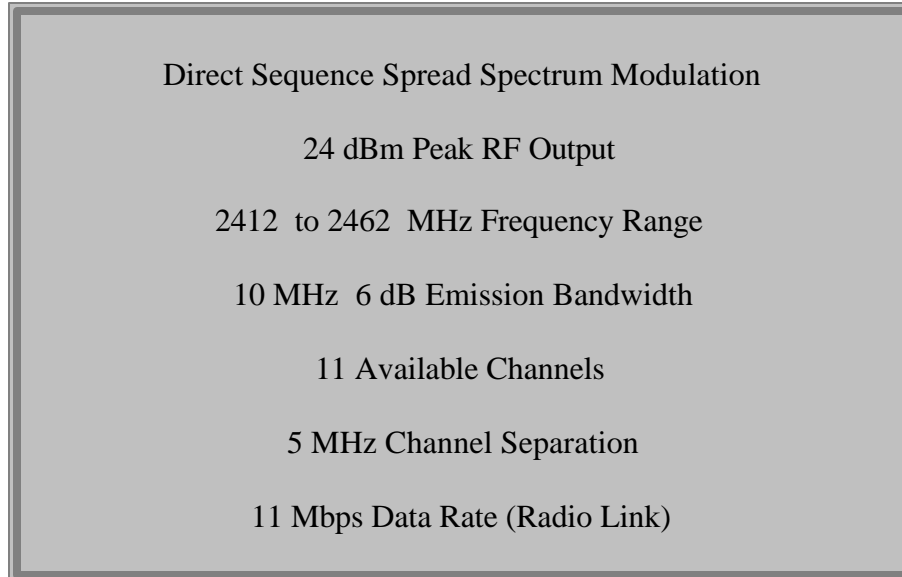

### **2.1 EMI Countermeasure:**

The following modifications were made to the EUT, by the project engineer to assure compliance to specifications:

None.

### **3.0 Test Program:**

This report contains measurement charts and data as evidence for the following tests performed:

1. (15.247b) Peak RF output power.
2. (15.247c) Field Strength of harmonics and spurious out-of-band emissions.
3. (15.247c) RF Antenna Conducted output of harmonics and spurious out-of-band emissions.
4. (15.247a) 6 dB Emission Bandwidth.
5. (15.207 A.C. Power Line Conducted emissions.



6. (15.247c) Band Edge emissions.
7. (15.247d) Power Spectral Density

#### **4.0 Test Configuration for Antenna Terminal Conducted:**

The PCM wireless LAN card was installed in a notebook computer for testing. A DOS program is used to control the transmitter. The external amplifier is connected in-line between the wireless LAN card and antenna via 50 feet of 3/8 inch low-loss cable. This has insertion loss of 3.3 dB at 2450 MHz. The Installation Manual will specify that the coax cable between the D.C. Injector and amplifier must have at least 3.3dB loss if other than 3/8 inch low-loss cable is used. The 50 foot cable is the **minimum** length of 3/8 inch cable to be supplied with the system.

RF power output measurements were taken with a Peak RF power meter at the amplifier antenna connector. RF antenna conducted output tests such as Bandwidth, Spurious/Harmonics, and Power Spectral Density were taken with the amplifier antenna connector feeding directly into the spectrum analyzer via external 30 dB attenuator. The analyzer's internal attenuator was adjusted to prevent overloading of the front end.

Field strength measurements were taken both with the amplifier in-line, and subsequently with just the wireless LAN card feeding a grid dish, panel, or omni antenna aimed at the receiving antenna. Testing was performed using the highest gain antenna from each design family (grid, panel, omni) in order to cover the worst case range of combinations.

A list of all antennas and suggested cables that will be sold with the EUT is provided in Table 1.



## **PEAK POWER TEST RESULTS**

Limit: 1 watt (30 dBm)

Condition: Transmitter is set to a single 11 Mbps modulated channel at full power.  
Measurements taken at amplifier antenna connector.

Readings from Peak Power Meter:

WLAN Card w/ AMP @ 2412 MHz: **23.9 dBm**

WLAN Card w/ AMP @ 2437 MHz: **24.0 dBm**

WLAN Card w/ AMP @ 2462 MHz: **23.8 dBm**



## **6 dB EMISSION BANDWIDTH**

Minimum 6 dB BW:           0.500 MHz  
RBW Setting on S.A.:       100 kHz

Condition:                    Transmitter is set to a single 11 Mbps modulated channel at full power.  
                                  Measurements taken at amplifier antenna connector.

Readings from Spectrum Analyzer:

WLAN Card w/ AMP @ 2412 MHz:   **10.8 MHz**

WLAN Card w/ AMP @ 2437 MHz:   **10.8 MHz**

WLAN Card w/ AMP @ 2462 MHz:   **9.6 MHz**

**SEE FOLLOWING THREE (3) PLOTS OF MODULATED CARRIER**



## 6 dB EMISSION BANDWIDTH – MODULATED CARRIER

Low Channel

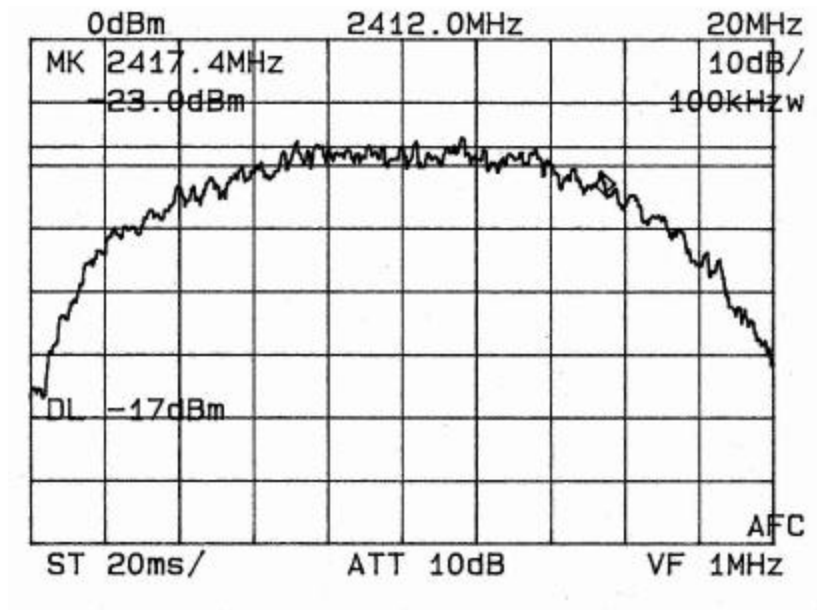

Mid Channel

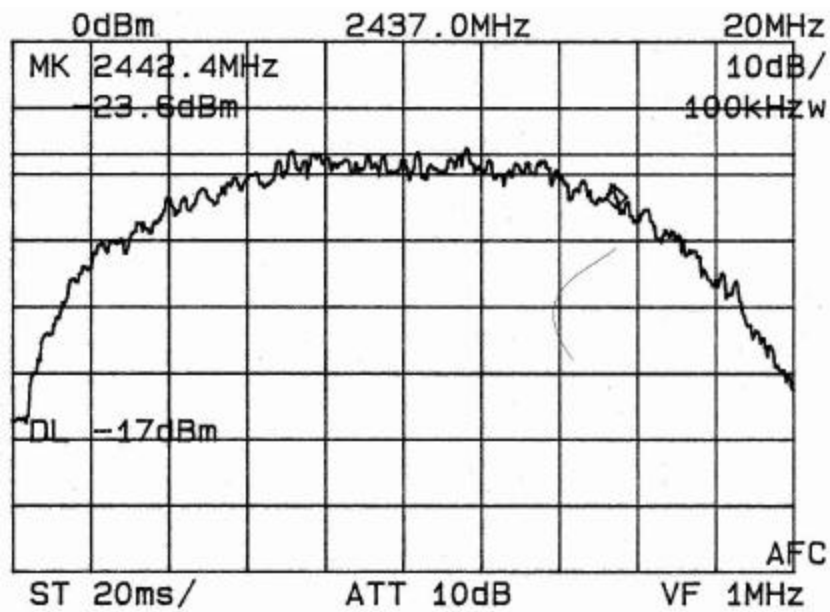





High Channel

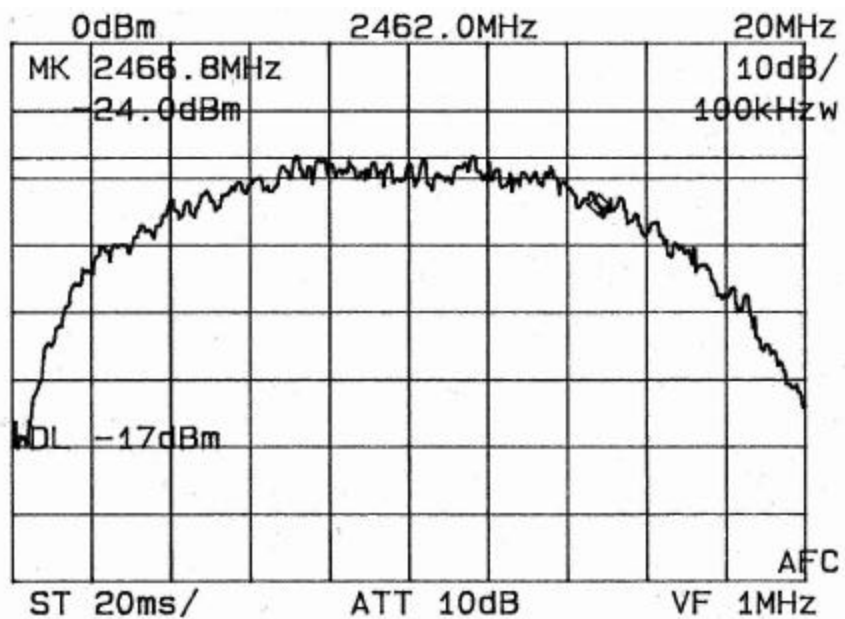



## POWER SPECTRAL DENSITY

Limit: 8 dBm  
Resolution Bandwidth: 3 kHz  
Average Time Interval: 1 second/3 kHz

Actual Time Interval used  
for testing: 1.5 seconds/3 kHz

Condition: Transmitter is set to a single 11 Mbps modulated channel at full power.  
Measurements taken at amplifier antenna connector.

Note: 30 dB front-end attenuator on analyzer

Readings from spectrum analyzer:

WLAN Card w/ AMP @ 2412 MHz:	<b>1.8 dBm</b>
WLAN Card w/ AMP @ 2437 MHz:	<b>1.2 dBm</b>
WLAN Card w/ AMP @ 2462 MHz:	<b>0.6 dBm</b>



Low Channel

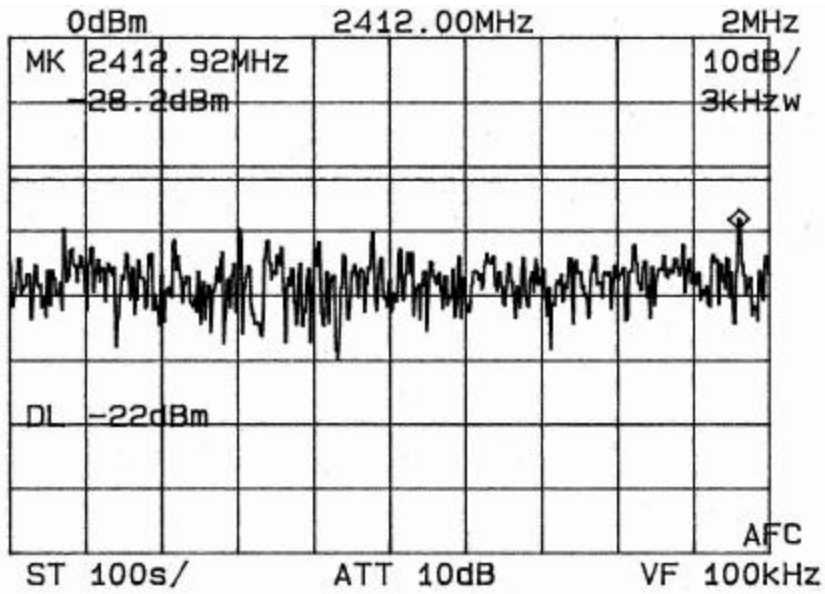

Mid Channel

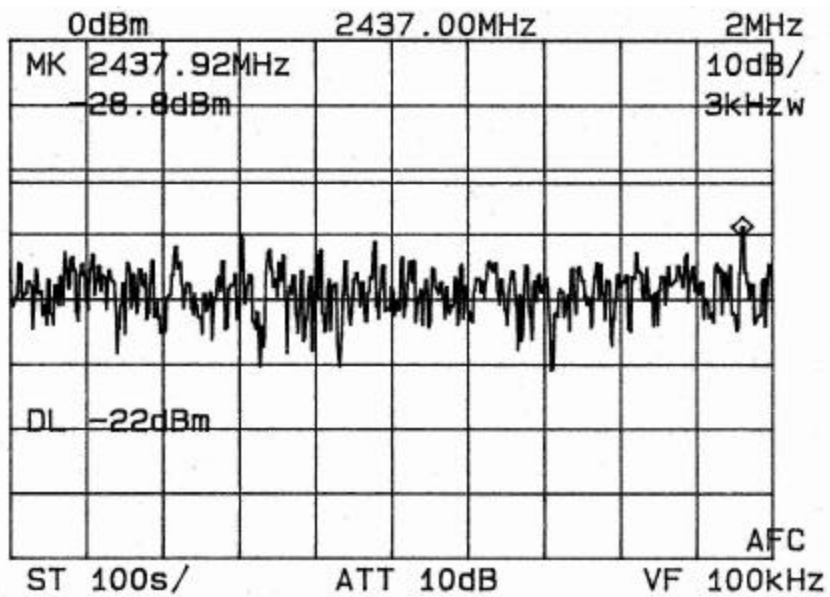



High Channel

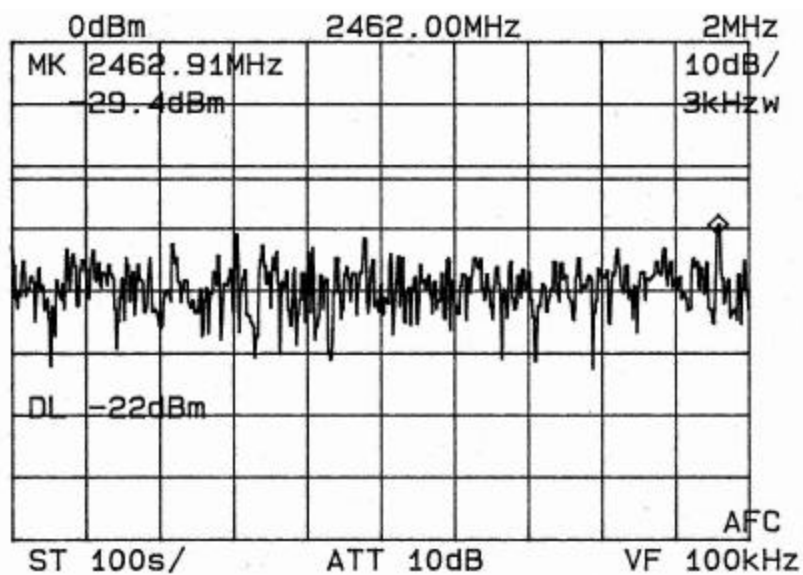



## **RF ANTENNA CONDUCTED SPURIOUS/HARMONICS EMISSIONS**

Limit: 20 dB below Carrier Level Measured with 100 kHz RBW  
RBW Setting on S.A.: 100 kHz

Condition: Transmitter is set to a single 11 Mbps modulated channel at full power.  
Measurements taken at amplifier antenna connector

Three separate measurements are performed to show harmonic and spurious emissions generated with the transmitter tuned to low, middle, and high parts of the spectral range.

SEE FOLLOWING THREE (3) DATA TABLES



## FCC Part 15.247(c) – Conducted Spurious Emissions

Frequency of Carrier = 2412 MHz

Limit = 20 dBc

Condition: Transmitter is set to a single modulated channel.

### TEST RESULTS

LIMIT: -20 dB FROM PEAK CARRIER

<u>Component</u>	<u>Frequency (MHz)</u>	<u>Result (dBc)</u>
Harmonic	4824.00	-66.0
Harmonic	7236.00	-68.0
Harmonic	9648.00	-73.0
Harmonic	12060.00	-73.0
Harmonic	14472.00	-74.0
Harmonic	16884.00	-75.0
Harmonic	19296.00	-75.0
Harmonic	21708.00	-75.0
Harmonic	24120.00	-75.0



## FCC Part 15.247(c) – Conducted Spurious Emissions

Frequency of Carrier = 2437 MHz

Limit = 20 dBc

Condition: Transmitter is set to a single modulated channel.

### TEST RESULTS

LIMIT: -20 dB FROM PEAK CARRIER

<u>Component</u>	<u>Frequency (MHz)</u>	<u>Result (dBc)</u>
Harmonic	4874.00	-64.0
Harmonic	7311.00	-69.0
Harmonic	9748.00	-73.0
Harmonic	12185.00	-73.0
Harmonic	14622.00	-74.0
Harmonic	17059.00	-74.0
Harmonic	19496.00	-75.0
Harmonic	21933.00	-75.0
Harmonic	24370.00	-75.0



## FCC Part 15.247(c) – Conducted Spurious Emissions

Frequency of Carrier = 2462 MHz

Limit = 20 dBc

Condition: Transmitter is set to a single modulated channel.

### TEST RESULTS

LIMIT: -20 dB FROM PEAK CARRIER

Component	Frequency (MHz)	Result (dBc)
Harmonic	4924.00	-65.0
Harmonic	7386.00	-67.0
Harmonic	9848.00	-73.0
Harmonic	12310.00	-73.0
Harmonic	14772.00	-74.0
Harmonic	17234.00	-74.0
Harmonic	19696.00	-74.0
Harmonic	22158.00	-75.0
Harmonic	24620.00	-75.0





# CONDUCTED BAND EDGE EMISSIONS – MODULATED CARRIER (100 kHz RES. BW)

## LOW CHANNEL

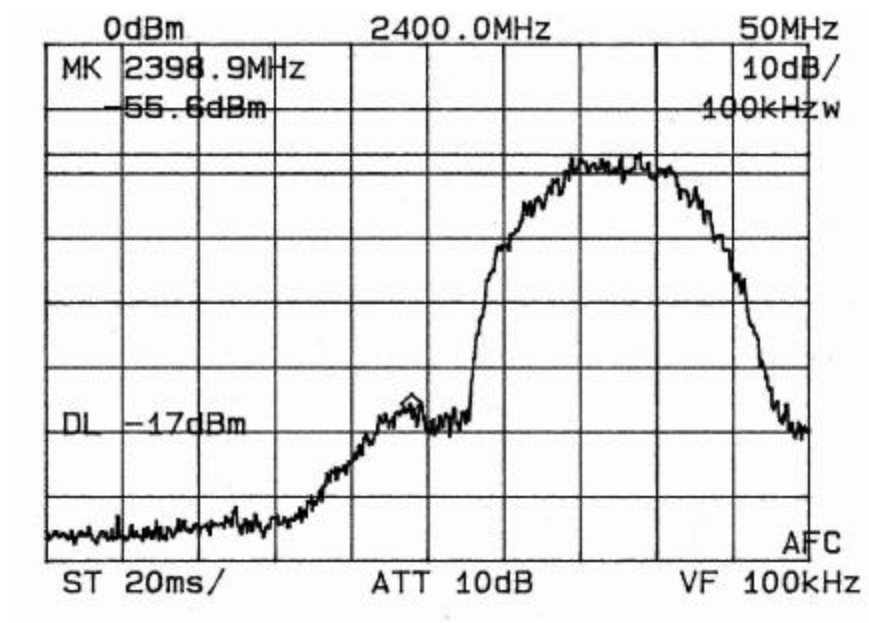

## HIGH CHANNEL

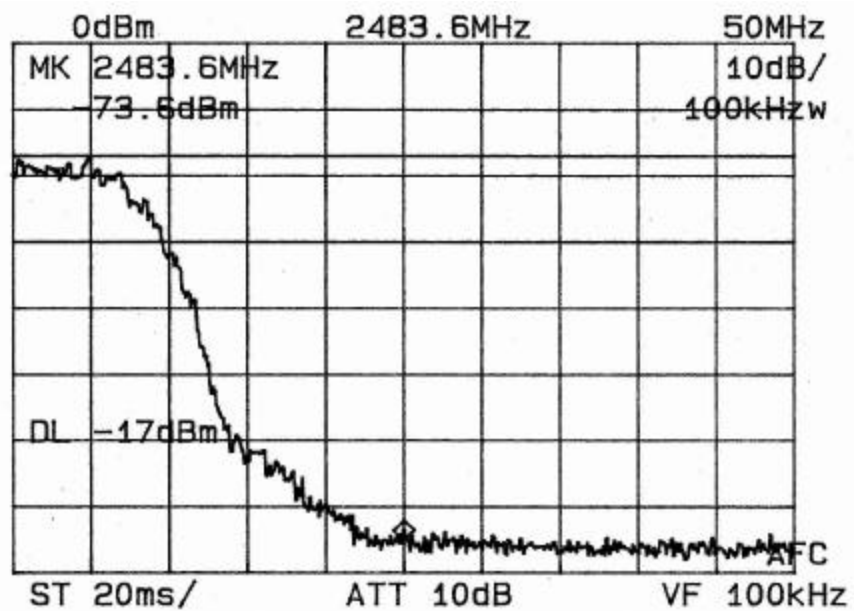

## 5.0 Test Configuration for Conducted and Radiated Emissions:

The EUT was set up on the center of the test table, in a manner which follows the general guidelines of ANSI C63.4, Section 6 “**General Operating Conditions and Configurations**”. Two sets of measurements were taken: First set with amplifier, second set without amplifier.

This is described below:

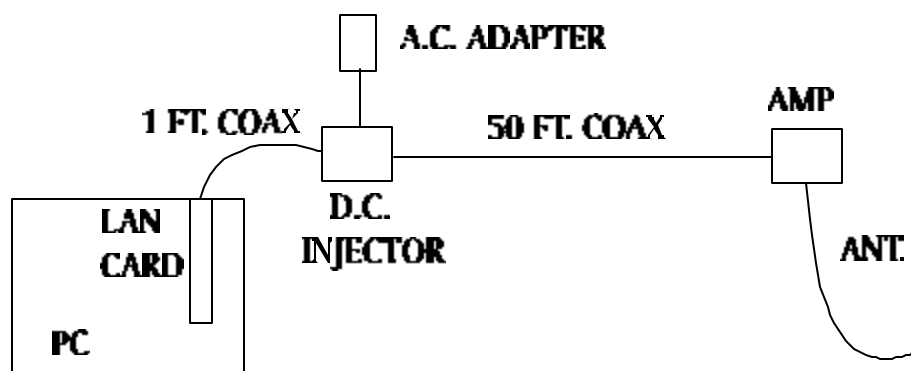

## 6.0 A.C. Conducted Emissions Scheme:

The EUT is placed on an 80 cm high 1 X 1.5 m non-conductive table. Power to the RF amplifier is provided through a Solar Corporation 50  $\Omega$  / 50 uH Line Impedance Stabilization Network bonded to a 2.2 X 2 meter horizontal ground plane, and a 2.2 X 2 meter vertical ground plane. The LISN has its AC input supplied from a filtered AC power source. A separate LISN provides AC power to the peripheral equipment. I/O cables are moved about to obtain maximum emissions.

The 50  $\Omega$  output of the LISN is connected to the input of the spectrum analyzer and emissions in the frequency range of 450 kHz to 30 MHz are searched. The detector function is set to Quasi-Peak and the resolution bandwidth is set at 9 kHz, with all post detector filtering no less than 10 times the resolution bandwidth for final measurements. All emissions within 20 dB of the limit are recorded in the data tables.



## **7.0 Radiated Emissions Scheme:**

The EUT is placed on an 80 cm high 1 X 1.5 meter non-conductive motorized turntable for radiated testing on the 3 meter open area test site. The emissions from the EUT are measured continuously at every azimuth by rotating the turntable. Guided horn and log periodic broadband antennas are mounted on an antenna mast to determine the height of the maximum emissions. The heights of the antennas are varied between 1 and 4 meters. Both the horizontal and vertical field components are measured.

The RF spectrum is searched from 30 MHz to 25 GHz.

The output from the antenna is connected to the input of the preamplifier. The pre-amp out is connected to the spectrum analyzer. The detector function is set to PEAK. The resolution bandwidth of the spectrum analyzer is set at 100 kHz for the frequency range of 30-1000 MHz, and 1 MHz for the frequency range of 1-25 GHz. A 10Hz video BW setting is used to average readings above 1 GHz when applicable. All emissions within 20 dB of the limit are recorded in the data tables.

To convert the spectrum analyzer reading into a quantified E-field level to allow comparison with the FCC limits, it is necessary to account for various calibration factors. These factors include cable loss (CL) and antenna factors (AF). The AF/CL in dB/m is algebraically added to the Spectrum Analyzer Voltage in dB $\mu$ V/m. This level is then compared to the FCC limit.

### **EXAMPLE:**

**Spectrum Analyzer Voltage:**                      **VdBmV**

**Composite Factor:**                                      **AF/CL dB/m**

**Electric Field:**                                      **E dBmV/m = V dBmV + AF/CL dB/m**

**Linear Conversion:**                                      **E mV/m = Antilog (E dBmV/m /20)**



## FCC CLASS "B" CONDUCTED EMISSIONS DATA

CLIENT: YOUNG DESIGN  
EUT: LUCENT SILVER  
W/ AMP 2440-RxF

MODE: TRANSMIT

LINE 1-Neutral: Quasi-Peak Level Date:

FREQUENCY MHz	SPEC. Ana dBuV	Calc. Volt. uV	FCC LIMIT uV	MARGIN dB	CONDITION
1.15	36.00	63.10	250.00	11.96	PASS
7.17	35.00	56.23	250.00	12.96	PASS
15.1	38.20	81.28	250.00	9.76	PASS
18.9	30.80	34.67	250.00	17.16	PASS

LINE 2-Phase: Quasi-Peak Level

FREQUENCY MHz	SPEC. Ana dBuV	Calc. Volt. uV	FCC LIMIT uV	MARGIN dB	CONDITION
1.12	35.60	60.26	250.00	12.36	PASS
7.23	34.60	53.70	250.00	13.36	PASS
15.1	34.80	54.95	250.00	13.16	PASS
18.8	33.40	46.77	250.00	14.56	PASS
22.3	32.00	39.81	250.00	15.96	PASS

TEST ENGINEER:

Brian Haghtalab



### FCC RADIATED EMISSIONS DATA

CLIENT: YOUNG DESIGN  
 EUT: LUCENT SILVER W/ AMP 2440  
 ANTENNA: 12 dBi Omni  
 FREQ.: 2412 MHZ  
 POWER: 250 mW

3 METER TEST

Detector - PEAK

DATE: .....

FREQUENCY MHz	POLARITY		SPEC A dBuV	AF/CL dB/m	AMP Gain dB	Average Factor dB	Peak E-Field dbuV/m	Avrg. Limit dBuV/m	MARGIN dB	CONDITION
	H	V								
4,824.00		V	31.00	35.00	25.00	0.00	41.00	54.00	13.00	PASS
12,060.00		V	28.00	40.00	25.00	0.00	43.00	54.00	11.00	PASS
14,472.00	H		20.00	43.00	25.00	0.00	38.00	54.00	16.00	PASS
19,296.00		V	22.00	36.00	25.00	0.00	33.00	54.00	21.00	PASS

TEST ENGINEER:

Brian Haachtalab

### FCC RADIATED EMISSIONS DATA

CLIENT: YOUNG DESIGN  
 EUT: LUCENT SILVER W/ AMP 2440  
 ANTENNA: 17 dBi Long Panel  
 FREQ.: 2412 MHZ  
 POWER: 250 mW

3 METER TEST

Detector - PEAK

DATE: 11/02/2000

FREQUENCY MHz	POLARITY		SPEC A dBuV	AF/CL dB/m	AMP Gain dB	Average Factor dB	Peak E-Field dbuV/m	Avrg. Limit dBuV/m	MARGIN dB	CONDITION
	H	V								
4,824.00		V	32.00	35.00	25.00	0.00	42.00	54.00	12.00	PASS
12,060.00		V	28.00	40.00	25.00	0.00	43.00	54.00	11.00	PASS
14,472.00	H		22.00	43.00	25.00	0.00	40.00	54.00	14.00	PASS
19,296.00		V	21.00	36.00	25.00	0.00	32.00	54.00	22.00	PASS

TEST ENGINEER:

Brian Haghtalab



### FCC RADIATED EMISSIONS DATA

CLIENT: YOUNG DESIGN  
 EUT: LUCENT SILVER W/ AMP 2440  
 ANTENNA: 24 dBi Grid Dish  
 FREQ.: 2412 MHZ  
 POWER: 250 mW

3 METER TEST      Detector - PEAK      DATE: 11/02/2000

FREQUENCY MHz	POLARITY		SPEC A dBuV	AF/CL dB/m	AMP Gain dB	Average Factor dB	Peak E-Field dbuV/m	Avrg. Limit dBuV/m	MARGIN dB	CONDITION
	H	V								
4,824.00	H	V	33.00	35.00	25.00	0.00	43.00	54.00	11.00	PASS
12,060.00			27.00	40.00	25.00	0.00	42.00	54.00	12.00	PASS
14,472.00	H		20.00	43.00	25.00	0.00	38.00	54.00	16.00	PASS
19,296.00	H		21.00	36.00	25.00	0.00	32.00	54.00	22.00	PASS

TEST ENGINEER:

Brian Haghtalab

### FCC RADIATED EMISSIONS DATA

CLIENT: YOUNG DESIGN  
 EUT: LUCENT SILVER W/ AMP 2440  
 ANTENNA: 18 dBi Flat Panel  
 FREQ.: 2412 MHZ  
 POWER: 250 mW

3 METER TEST      Detector - PEAK      DATE: 11/02/2000

FREQUENCY MHz	POLARITY		SPEC A dBuV	AF/CL dB/m	AMP Gain dB	Average Factor dB	Peak E-Field dbuV/m	Avrg. Limit dBuV/m	MARGIN dB	CONDITION
	H	V								
4,824.00	H	V	31.00	35.00	25.00	0.00	41.00	54.00	13.00	PASS
12,060.00			25.00	40.00	25.00	0.00	40.00	54.00	14.00	PASS
14,472.00	H		19.00	43.00	25.00	0.00	37.00	54.00	17.00	PASS
19,296.00	H		20.00	36.00	25.00	0.00	31.00	54.00	23.00	PASS

TEST ENGINEER:

Brian Haghtalab



### FCC RADIATED EMISSIONS DATA

CLIENT: YOUNG DESIGN  
 EUT: LUCENT SILVER W/ AMP 2440  
 ANTENNA: 12 dBi Wide Angle  
 FREQ.: 2412 MHZ  
 POWER: 250 mW

3 METER TEST

Detector - PEAK

DATE: 11/02/2000

FREQUENCY MHz	POLARITY		SPEC A dBuV	AF/CL dB/m	AMP Gain dB	Average Factor dB	Peak E-Field dbuV/m	Avrg. Limit dBuV/m	MARGIN dB	CONDITION
	H	V								
4,824.00	H		31.00	35.00	25.00	0.00	41.00	54.00	13.00	PASS
12,060.00		V	26.00	40.00	25.00	0.00	41.00	54.00	13.00	PASS
14,472.00	H		20.00	43.00	25.00	0.00	38.00	54.00	16.00	PASS
19,296.00	H		21.00	36.00	25.00	0.00	32.00	54.00	22.00	PASS

TEST ENGINEER:

Brian Haghtalab

### FCC RADIATED EMISSIONS DATA

CLIENT: YOUNG DESIGN  
 EUT: LUCENT SILVER W/ AMP 2440  
 ANTENNA: 12 dBi A2.4SP12A Flat Panel  
 FREQ.: 2412 MHZ  
 POWER: 250 mW

3 METER TEST

Detector - PEAK

DATE: 11/02/2000

FREQUENCY MHz	POLARITY		SPEC A dBuV	AF/CL dB/m	AMP Gain dB	Average Factor dB	Peak E-Field dbuV/m	Avrg. Limit dBuV/m	MARGIN dB	CONDITION
	H	V								
4,824.00	H		33.00	35.00	25.00	0.00	43.00	54.00	11.00	PASS
12,060.00		V	25.00	40.00	25.00	0.00	40.00	54.00	14.00	PASS
14,472.00	H		20.00	43.00	25.00	0.00	38.00	54.00	16.00	PASS
19,296.00	H		19.00	36.00	25.00	0.00	30.00	54.00	24.00	PASS

TEST ENGINEER:

Brian Haghtalab



### FCC RADIATED EMISSIONS DATA

CLIENT: YOUNG DESIGN  
 EUT: LUCENT SILVER W/ AMP 2440  
 ANTENNA: 12 dBi Omni  
 FREQ.: 2437 MHZ  
 POWER: 250 mW

3 METER TEST      Detector - PEAK      DATE: 11/02/2000

FREQUENCY MHz	POLARITY		SPEC A dBuV	AF/CL dB/m	AMP Gain dB	Average Factor dB	Peak E-Field dbuV/m	Avrg. Limit dBuV/m	MARGIN dB	CONDITION
	H	V								
4,874.00	H		30.00	35.00	25.00	0.00	40.00	54.00	14.00	PASS
7,311.00	H		29.00	37.00	25.00	0.00	41.00	54.00	13.00	PASS
12,185.00		V	26.00	40.00	25.00	0.00	41.00	54.00	13.00	PASS
19,496.00		V	20.00	36.00	25.00	0.00	31.00	54.00	23.00	PASS

TEST ENGINEER:

Brian Haghtalab

### FCC RADIATED EMISSIONS DATA

CLIENT: YOUNG DESIGN  
 EUT: LUCENT SILVER W/ AMP 2440  
 ANTENNA: 17 dBi Long Panel  
 FREQ.: 2437 MHZ  
 POWER: 250 mW

3 METER TEST      Detector - PEAK      DATE: 11/02/2000

FREQUENCY MHz	POLARITY		SPEC A dBuV	AF/CL dB/m	AMP Gain dB	Average Factor dB	Peak E-Field dbuV/m	Avrg. Limit dBuV/m	MARGIN dB	CONDITION
	H	V								
4,874.00	H		32.00	35.00	25.00	0.00	42.00	54.00	12.00	PASS
7,311.00		V	30.00	37.00	25.00	0.00	42.00	54.00	12.00	PASS
12,185.00		V	25.00	40.00	25.00	0.00	40.00	54.00	14.00	PASS
19,496.00	H		21.00	36.00	25.00	0.00	32.00	54.00	22.00	PASS

TEST ENGINEER:

Brian Haghtalab





### FCC RADIATED EMISSIONS DATA

CLIENT: YOUNG DESIGN  
 EUT: LUCENT SILVER W/ AMP 2440  
 ANTENNA: 24 dBi Grid Dish  
 FREQ.: 2437 MHZ  
 POWER: 250 mW

3 METER TEST      Detector - PEAK

DATE: 11/02/2000

FREQUENCY MHz	POLARITY		SPEC A dBuV	AF/CL dB/m	AMP Gain dB	Average Factor dB	Peak E-Field dbuV/m	Avrg. Limit dBuV/m	MARGIN dB	CONDITION
	H	V								
4,874.00	H		31.00	35.00	25.00	0.00	41.00	54.00	13.00	PASS
7,311.00	H		31.00	37.00	25.00	0.00	43.00	54.00	11.00	PASS
12,185.00		V	27.00	40.00	25.00	0.00	42.00	54.00	12.00	PASS
19,496.00	H		20.00	36.00	25.00	0.00	31.00	54.00	23.00	PASS

TEST ENGINEER:

Brian Haghtalab

### FCC RADIATED EMISSIONS DATA

CLIENT: YOUNG DESIGN  
 EUT: LUCENT SILVER W/ AMP 2440  
 ANTENNA: 18 dB Flat Panel  
 FREQ.: 2437 MHZ  
 POWER: 250 mW

3 METER TEST      Detector - PEAK

DATE: 11/02/2000

FREQUENCY MHz	POLARITY		SPEC A dBuV	AF/CL dB/m	AMP Gain dB	Average Factor dB	Peak E-Field dbuV/m	Avrg. Limit dBuV/m	MARGIN dB	CONDITION
	H	V								
4,874.00	H		30.00	35.00	25.00	0.00	40.00	54.00	14.00	PASS
7,311.00	H		30.00	37.00	25.00	0.00	42.00	54.00	12.00	PASS
12,185.00		V	29.00	40.00	25.00	0.00	44.00	54.00	10.00	PASS
19,496.00	H		19.00	36.00	25.00	0.00	30.00	54.00	24.00	PASS

TEST ENGINEER:

Brian Haghtalab



### FCC RADIATED EMISSIONS DATA

CLIENT: YOUNG DESIGN  
 EUT: LUCENT SILVER W/ AMP 2440  
 ANTENNA: 12 dB Wide Angle  
 FREQ.: 2437 MHZ  
 POWER: 250 mW

3 METER TEST      Detector - PEAK      DATE: 11/02/2000

FREQUENCY MHz	POLARITY		SPEC A dBuV	AF/CL dB/m	AMP Gain dB	Average Factor dB	Peak E-Field dbuV/m	Avrg. Limit dBuV/m	MARGIN dB	CONDITION
	H	V								
4,874.00	H		32.00	35.00	25.00	0.00	42.00	54.00	12.00	PASS
7,311.00	H		31.00	37.00	25.00	0.00	43.00	54.00	11.00	PASS
12,185.00		V	27.00	40.00	25.00	0.00	42.00	54.00	12.00	PASS
19,496.00	H		21.00	36.00	25.00	0.00	32.00	54.00	22.00	PASS

TEST ENGINEER:

Brian Haghtalab

### FCC RADIATED EMISSIONS DATA

CLIENT: YOUNG DESIGN  
 EUT: LUCENT SILVER W/ AMP 2440  
 ANTENNA: 12 dBi A2.4SP12A Flat Panel  
 FREQ.: 2437 MHZ  
 POWER: 250 mW

3 METER TEST      Detector - PEAK      DATE: 11/02/2000

FREQUENCY MHz	POLARITY		SPEC A dBuV	AF/CL dB/m	AMP Gain dB	Average Factor dB	Peak E-Field dbuV/m	Avrg. Limit dBuV/m	MARGIN dB	CONDITION
	H	V								
4,874.00	H		31.00	35.00	25.00	0.00	41.00	54.00	13.00	PASS
7,311.00		V	29.00	37.00	25.00	0.00	41.00	54.00	13.00	PASS
12,185.00		V	26.00	40.00	25.00	0.00	41.00	54.00	13.00	PASS
19,496.00	H		19.00	36.00	25.00	0.00	30.00	54.00	24.00	PASS

TEST ENGINEER:

Brian Haghtalab



### FCC RADIATED EMISSIONS DATA

CLIENT: YOUNG DESIGN  
 EUT: LUCENT SILVER W/ AMP 2440  
 ANTENNA: 12 dBi Omni  
 FREQ.: 2462 MHZ  
 POWER: 250 mW

3 METER TEST      Detector - PEAK

DATE: 11/02/2000

FREQUENCY MHz	POLARITY		SPEC A dBuV	AF/CL dB/m	AMP Gain dB	Average Factor dB	Peak E-Field dbuV/m	Avrg. Limit dBuV/m	MARGIN dB	CONDITION
	H	V								
4,924.00		V	29.00	35.00	25.00	0.00	39.00	54.00	15.00	PASS
7,386.00		V	30.00	37.00	25.00	0.00	42.00	54.00	12.00	PASS
12,310.00	H		27.00	40.00	25.00	0.00	42.00	54.00	12.00	PASS
19,696.00	H		19.00	36.00	25.00	0.00	30.00	54.00	24.00	PASS
22,158.00		V	18.00	37.00	25.00	0.00	30.00	54.00	24.00	PASS

TEST ENGINEER:

Brian Haghtalab

### FCC RADIATED EMISSIONS DATA

CLIENT: YOUNG DESIGN  
 EUT: LUCENT SILVER W/ AMP 2440  
 ANTENNA: 17 dBi Long Panel  
 FREQ.: 2462 MHZ  
 POWER: 250 mW

3 METER TEST      Detector - PEAK

DATE: 11/02/2000

FREQUENCY MHz	POLARITY		SPEC A dBuV	AF/CL dB/m	AMP Gain dB	Average Factor dB	Peak E-Field dbuV/m	Avrg. Limit dBuV/m	MARGIN dB	CONDITION
	H	V								
4,924.00		V	31.00	35.00	25.00	0.00	41.00	54.00	13.00	PASS
7,386.00	H		30.00	37.00	25.00	0.00	42.00	54.00	12.00	PASS
12,310.00	H		28.00	40.00	25.00	0.00	43.00	54.00	11.00	PASS
19,696.00		V	20.00	36.00	25.00	0.00	31.00	54.00	23.00	PASS
22,158.00		V	19.00	37.00	25.00	0.00	31.00	54.00	23.00	PASS

TEST ENGINEER:

Brian Haghtalab



### FCC RADIATED EMISSIONS DATA

CLIENT: YOUNG DESIGN  
 EUT: LUCENT SILVER W/ AMP 2440  
 ANTENNA: 24 dBi Grid Dish  
 FREQ.: 2462 MHZ  
 POWER: 250 mW

3 METER TEST      Detector - PEAK

DATE: 11/02/2000

FREQUENCY MHz	POLARITY		SPEC A dBuV	AF/CL dB/m	AMP Gain dB	Average Factor dB	Peak E-Field dbuV/m	Avg. Limit dBuV/m	MARGIN dB	CONDITION
	H	V								
4,924.00		V	30.00	35.00	25.00	0.00	40.00	54.00	14.00	PASS
7,386.00	H		31.00	37.00	25.00	0.00	43.00	54.00	11.00	PASS
12,310.00	H		26.00	40.00	25.00	0.00	41.00	54.00	13.00	PASS
19,696.00		V	19.00	36.00	25.00	0.00	30.00	54.00	24.00	PASS
22,158.00		V	19.00	37.00	25.00	0.00	31.00	54.00	23.00	PASS

TEST ENGINEER:

Brian Haghtalab

### FCC RADIATED EMISSIONS DATA

CLIENT: YOUNG DESIGN  
 EUT: LUCENT SILVER W/ AMP 2440  
 ANTENNA: 18 dBi Flat Panel  
 FREQ.: 2462 MHZ  
 POWER: 250 mW

3 METER TEST      Detector - PEAK

DATE: 11/02/2000

FREQUENCY MHz	POLARITY		SPEC A dBuV	AF/CL dB/m	AMP Gain dB	Average Factor dB	Peak E-Field dbuV/m	Avg. Limit dBuV/m	MARGIN dB	CONDITION
	H	V								
4,924.00		V	32.00	35.00	25.00	0.00	42.00	54.00	12.00	PASS
7,386.00		V	29.00	37.00	25.00	0.00	41.00	54.00	13.00	PASS
12,310.00		V	28.00	40.00	25.00	0.00	43.00	54.00	11.00	PASS
19,696.00	H		21.00	36.00	25.00	0.00	32.00	54.00	22.00	PASS
22,158.00	H		22.00	37.00	25.00	0.00	34.00	54.00	20.00	PASS

TEST ENGINEER:

Brian Haghtalab



### FCC RADIATED EMISSIONS DATA

**CLIENT:** YOUNG DESIGN  
**EUT:** LUCENT SILVER W/ AMP 2440  
**ANTENNA:** 12 dBi Wide Angle  
**FREQ.:** 2462 MHZ  
**POWER:** 250 mW

**3 METER TEST**      **Detector - PEAK**      **DATE: 11/02/2000**

FREQUENCY MHz	POLARITY		SPEC A dBuV	AF/CL dB/m	AMP Gain dB	Average Factor dB	Peak E-Field dbuV/m	Avg. Limit dBuV/m	MARGIN dB	CONDITION
	H	V								
4,924.00		V	31.00	35.00	25.00	0.00	41.00	54.00	13.00	PASS
7,386.00	H		30.00	37.00	25.00	0.00	42.00	54.00	12.00	PASS
12,310.00		V	29.00	40.00	25.00	0.00	44.00	54.00	10.00	PASS
19,696.00	H		19.00	36.00	25.00	0.00	30.00	54.00	24.00	PASS
22,158.00		V	19.00	37.00	25.00	0.00	31.00	54.00	23.00	PASS

TEST ENGINEER:

Brian Haghtalab

### FCC RADIATED EMISSIONS DATA

**CLIENT:** YOUNG DESIGN  
**EUT:** LUCENT SILVER W/ AMP 2440  
**ANTENNA:** 12 dBi A2.4SP12A Flat Panel  
**FREQ.:** 2462 MHZ  
**POWER:** 250 mW

**3 METER TEST**      **Detector - PEAK**      **DATE: 11/02/2000**

FREQUENCY MHz	POLARITY		SPEC A dBuV	AF/CL dB/m	AMP Gain dB	Average Factor dB	Peak E-Field dbuV/m	Avg. Limit dBuV/m	MARGIN dB	CONDITION
	H	V								
4,924.00	H		32.00	35.00	25.00	0.00	42.00	54.00	12.00	PASS
7,386.00	H		27.00	37.00	25.00	0.00	39.00	54.00	15.00	PASS
12,310.00		V	26.00	40.00	25.00	0.00	41.00	54.00	13.00	PASS
19,696.00	H		20.00	36.00	25.00	0.00	31.00	54.00	23.00	PASS
22,158.00	H		18.00	37.00	25.00	0.00	30.00	54.00	24.00	PASS

TEST ENGINEER:

Brian Haghtalab



### FCC RADIATED EMISSIONS DATA

CLIENT: YOUNG DESIGN  
 EUT: LUCENT SILVER WLAN  
 ANTENNA: 12 dBi Omni  
 FREQ.: 2412 MHZ  
 POWER: 22 mW

3 METER TEST      Detector - PEAK      DATE: 11/02/2000

FREQUENCY MHz	POLARITY		SPEC A dBuV	AF/CL dB/m	AMP Gain dB	Average Factor dB	Peak E-Field dbuV/m	Avg. Limit dBuV/m	MARGIN dB	CONDITION
	H	V								
4,824.00		V	29.00	35.00	25.00	0.00	39.00	54.00	15.00	PASS
12,060.00		V	27.00	40.00	25.00	0.00	42.00	54.00	12.00	PASS
14,472.00	H		18.00	43.00	25.00	0.00	36.00	54.00	18.00	PASS
19,296.00		V	18.00	36.00	25.00	0.00	29.00	54.00	25.00	PASS

TEST ENGINEER:

Brian Haghtalab

### FCC RADIATED EMISSIONS DATA

CLIENT: YOUNG DESIGN  
 EUT: LUCENT SILVER WLAN  
 ANTENNA: 17 dBi Long Panel  
 FREQ.: 2412 MHZ  
 POWER: 22 mW

3 METER TEST      Detector - PEAK      DATE: 11/02/2000

FREQUENCY MHz	POLARITY		SPEC A dBuV	AF/CL dB/m	AMP Gain dB	Average Factor dB	Peak E-Field dbuV/m	Avg. Limit dBuV/m	MARGIN dB	CONDITION
	H	V								
4,824.00		V	28.00	35.00	25.00	0.00	38.00	54.00	16.00	PASS
12,060.00		V	26.00	40.00	25.00	0.00	41.00	54.00	13.00	PASS
14,472.00	H		20.00	43.00	25.00	0.00	38.00	54.00	16.00	PASS
19,296.00		V	18.00	36.00	25.00	0.00	29.00	54.00	25.00	PASS

TEST ENGINEER:

Brian Haghtalab



### FCC RADIATED EMISSIONS DATA

CLIENT: YOUNG DESIGN  
 EUT: LUCENT SILVER WLAN  
 ANTENNA: 24 dBi Grid Dish  
 FREQ.: 2412 MHZ  
 POWER: 22 mW

3 METER TEST      Detector - PEAK

DATE: 11/02/2000

FREQUENCY MHz	POLARITY		SPEC A dBuV	AF/CL dB/m	AMP Gain dB	Average Factor dB	Peak E-Field dbuV/m	Avrg. Limit dBuV/m	MARGIN dB	CONDITION
	H	V								
4,824.00	H		31.00	35.00	25.00	0.00	41.00	54.00	13.00	PASS
12,060.00		V	29.00	40.00	25.00	0.00	44.00	54.00	10.00	PASS
14,472.00	H		22.00	43.00	25.00	0.00	40.00	54.00	14.00	PASS
19,296.00	H		21.00	36.00	25.00	0.00	32.00	54.00	22.00	PASS

TEST ENGINEER:

Brian Haghtalab

### FCC RADIATED EMISSIONS DATA

CLIENT: YOUNG DESIGN  
 EUT: LUCENT SILVER WLAN  
 ANTENNA: 18 dBi Flat Panel  
 FREQ.: 2412 MHZ  
 POWER: 22 mW

3 METER TEST      Detector - PEAK

DATE: 11/02/2000

FREQUENCY MHz	POLARITY		SPEC A dBuV	AF/CL dB/m	AMP Gain dB	Average Factor dB	Peak E-Field dbuV/m	Avrg. Limit dBuV/m	MARGIN dB	CONDITION
	H	V								
4,824.00	H		32.00	35.00	25.00	0.00	42.00	54.00	12.00	PASS
12,060.00		V	23.00	40.00	25.00	0.00	38.00	54.00	16.00	PASS
14,472.00	H		20.00	43.00	25.00	0.00	38.00	54.00	16.00	PASS
19,296.00	H		22.00	36.00	25.00	0.00	33.00	54.00	21.00	PASS

TEST ENGINEER:

Brian Haghtalab



### FCC RADIATED EMISSIONS DATA

CLIENT: YOUNG DESIGN  
 EUT: LUCENT SILVER WLAN  
 ANTENNA: 12 dBi Wide Angle  
 FREQ.: 2412 MHZ  
 POWER: 22 mW

3 METER TEST      Detector - PEAK

DATE: 11/02/2000

FREQUENCY MHz	POLARITY		SPEC A dBuV	AF/CL dB/m	AMP Gain dB	Average Factor dB	Peak E-Field dbuV/m	Avg. Limit dBuV/m	MARGIN dB	CONDITION
	H	V								
4,824.00	H		30.00	35.00	25.00	0.00	40.00	54.00	14.00	PASS
12,060.00		V	27.00	40.00	25.00	0.00	42.00	54.00	12.00	PASS
14,472.00	H		22.00	43.00	25.00	0.00	40.00	54.00	14.00	PASS
19,296.00	H		19.00	36.00	25.00	0.00	30.00	54.00	24.00	PASS

TEST ENGINEER:

Brian Haghtalab

### FCC RADIATED EMISSIONS DATA

CLIENT: YOUNG DESIGN  
 EUT: LUCENT SILVER WLAN  
 ANTENNA: 12 dBi A2.4SP12A Flat Panel  
 FREQ.: 2412 MHZ  
 POWER: 22 mW

3 METER TEST      Detector - PEAK

DATE: 11/02/2000

FREQUENCY MHz	POLARITY		SPEC A dBuV	AF/CL dB/m	AMP Gain dB	Average Factor dB	Peak E-Field dbuV/m	Avg. Limit dBuV/m	MARGIN dB	CONDITION
	H	V								
4,824.00	H		32.00	35.00	25.00	0.00	42.00	54.00	12.00	PASS
12,060.00		V	27.00	40.00	25.00	0.00	42.00	54.00	12.00	PASS
14,472.00	H		22.00	43.00	25.00	0.00	40.00	54.00	14.00	PASS
19,296.00	H		19.00	36.00	25.00	0.00	30.00	54.00	24.00	PASS

TEST ENGINEER:

Brian Haghtalab





### FCC RADIATED EMISSIONS DATA

CLIENT: YOUNG DESIGN  
 EUT: LUCENT SILVER WLAN  
 ANTENNA: 12 dBi Omni  
 FREQ.: 2437 MHZ  
 POWER: 22 mW

3 METER TEST      Detector - PEAK      DATE: 11/02/2000

FREQUENCY MHz	POLARITY		SPEC A dBuV	AF/CL dB/m	AMP Gain dB	Average Factor dB	Peak E-Field dbuV/m	Avrg. Limit dBuV/m	MARGIN dB	CONDITION
	H	V								
4,874.00	H		30.00	35.00	25.00	0.00	40.00	54.00	14.00	PASS
7,311.00	H		29.00	37.00	25.00	0.00	41.00	54.00	13.00	PASS
12,185.00		V	28.00	40.00	25.00	0.00	43.00	54.00	11.00	PASS
19,496.00		V	22.00	36.00	25.00	0.00	33.00	54.00	21.00	PASS

TEST ENGINEER:

Brian Haghtalab

### FCC RADIATED EMISSIONS DATA

CLIENT: YOUNG DESIGN  
 EUT: LUCENT SILVER WLAN  
 ANTENNA: 17 dBi Long Panel  
 FREQ.: 2437 MHZ  
 POWER: 22 mW

3 METER TEST      Detector - PEAK      DATE: 11/02/2000

FREQUENCY MHz	POLARITY		SPEC A dBuV	AF/CL dB/m	AMP Gain dB	Average Factor dB	Peak E-Field dbuV/m	Avrg. Limit dBuV/m	MARGIN dB	CONDITION
	H	V								
4,874.00	H		30.00	35.00	25.00	0.00	40.00	54.00	14.00	PASS
7,311.00		V	32.00	37.00	25.00	0.00	44.00	54.00	10.00	PASS
12,185.00		V	23.00	40.00	25.00	0.00	38.00	54.00	16.00	PASS
19,496.00	H		19.00	36.00	25.00	0.00	30.00	54.00	24.00	PASS

TEST ENGINEER:

Brian Haghtalab



### FCC RADIATED EMISSIONS DATA

CLIENT: YOUNG DESIGN  
 EUT: LUCENT SILVER WLAN  
 ANTENNA: 24 dBi Grid Dish  
 FREQ.: 2437 MHZ  
 POWER: 22 mW

3 METER TEST      Detector - PEAK

DATE: 11/02/2000

FREQUENCY MHz	POLARITY		SPEC A dBuV	AF/CL dB/m	AMP Gain dB	Average Factor dB	Peak E-Field dbuV/m	Avg. Limit dBuV/m	MARGIN dB	CONDITION
	H	V								
4,874.00	H		32.00	35.00	25.00	0.00	42.00	54.00	12.00	PASS
7,311.00	H		29.00	37.00	25.00	0.00	41.00	54.00	13.00	PASS
12,185.00		V	26.00	40.00	25.00	0.00	41.00	54.00	13.00	PASS
19,496.00	H		21.00	36.00	25.00	0.00	32.00	54.00	22.00	PASS

TEST ENGINEER:

Brian Haghtalab

### FCC RADIATED EMISSIONS DATA

CLIENT: YOUNG DESIGN  
 EUT: LUCENT SILVER WLAN  
 ANTENNA: 18 dB Flat Panel  
 FREQ.: 2437 MHZ  
 POWER: 22 mW

3 METER TEST      Detector - PEAK

DATE: 11/02/2000

FREQUENCY MHz	POLARITY		SPEC A dBuV	AF/CL dB/m	AMP Gain dB	Average Factor dB	Peak E-Field dbuV/m	Avg. Limit dBuV/m	MARGIN dB	CONDITION
	H	V								
4,874.00	H		32.00	35.00	25.00	0.00	42.00	54.00	12.00	PASS
7,311.00	H		29.00	37.00	25.00	0.00	41.00	54.00	13.00	PASS
12,185.00		V	25.00	40.00	25.00	0.00	40.00	54.00	14.00	PASS
19,496.00	H		21.00	36.00	25.00	0.00	32.00	54.00	22.00	PASS

TEST ENGINEER:

Brian Haghtalab



### FCC RADIATED EMISSIONS DATA

**CLIENT:** YOUNG DESIGN  
**EUT:** LUCENT SILVER WLAN  
**ANTENNA:** 12 dB Wide Angle  
**FREQ.:** 2437 MHZ  
**POWER:** 22 mW

**3 METER TEST**      **Detector - PEAK**      **DATE: 11/02/2000**

FREQUENCY MHz	POLARITY		SPEC A dBuV	AF/CL dB/m	AMP Gain dB	Average Factor dB	Peak E-Field dbuV/m	Avg. Limit dBuV/m	MARGIN dB	CONDITION
	H	V								
4,874.00	H		33.00	35.00	25.00	0.00	43.00	54.00	11.00	PASS
7,311.00	H		30.00	37.00	25.00	0.00	42.00	54.00	12.00	PASS
12,185.00		V	26.00	40.00	25.00	0.00	41.00	54.00	13.00	PASS
19,496.00	H		22.00	36.00	25.00	0.00	33.00	54.00	21.00	PASS

TEST ENGINEER:

Brian Haghtalab

### FCC RADIATED EMISSIONS DATA

**CLIENT:** YOUNG DESIGN  
**EUT:** LUCENT SILVER WLAN  
**ANTENNA:** 12 dBi A2.4SP12A Flat Panel  
**FREQ.:** 2437 MHZ  
**POWER:** 22 mW

**3 METER TEST**      **Detector - PEAK**      **DATE: 11/02/2000**

FREQUENCY MHz	POLARITY		SPEC A dBuV	AF/CL dB/m	AMP Gain dB	Average Factor dB	Peak E-Field dbuV/m	Avg. Limit dBuV/m	MARGIN dB	CONDITION
	H	V								
4,874.00	H		30.00	35.00	25.00	0.00	40.00	54.00	14.00	PASS
7,311.00		V	29.00	37.00	25.00	0.00	41.00	54.00	13.00	PASS
12,185.00		V	28.00	40.00	25.00	0.00	43.00	54.00	11.00	PASS
19,496.00	H		22.00	36.00	25.00	0.00	33.00	54.00	21.00	PASS

TEST ENGINEER:

Brian Haghtalab



### FCC RADIATED EMISSIONS DATA

**CLIENT:** YOUNG DESIGN  
**EUT:** LUCOENT SILVER WLAN  
**ANTENNA:** 12 dBi Omni  
**FREQ.:** 2462 MHZ  
**POWER:** 22 mW

3 METER TEST      Detector - PEAK

DATE: 11/02/2000

FREQUENCY MHz	POLARITY		SPEC A dBuV	AF/CL dB/m	AMP Gain dB	Average Factor dB	Peak E-Field dbuV/m	Avg. Limit dBuV/m	MARGIN dB	CONDITION
	H	V								
4,924.00		V	31.00	35.00	25.00	0.00	41.00	54.00	13.00	PASS
7,386.00		V	27.00	37.00	25.00	0.00	39.00	54.00	15.00	PASS
12,310.00	H		23.00	40.00	25.00	0.00	38.00	54.00	16.00	PASS
19,696.00	H		19.00	36.00	25.00	0.00	30.00	54.00	24.00	PASS
22,158.00		V	20.00	37.00	25.00	0.00	32.00	54.00	22.00	PASS

TEST ENGINEER:

Brian Haghtalab

### FCC RADIATED EMISSIONS DATA

**CLIENT:** YOUNG DESIGN  
**EUT:** LUCENT SILVER WLAN  
**ANTENNA:** 17 dBi Long Panel  
**FREQ.:** 2462 MHZ  
**POWER:** 22 mW

3 METER TEST      Detector - PEAK

DATE: 11/02/2000

FREQUENCY MHz	POLARITY		SPEC A dBuV	AF/CL dB/m	AMP Gain dB	Average Factor dB	Peak E-Field dbuV/m	Avg. Limit dBuV/m	MARGIN dB	CONDITION
	H	V								
4,924.00		V	29.00	35.00	25.00	0.00	39.00	54.00	15.00	PASS
7,386.00	H		29.00	37.00	25.00	0.00	41.00	54.00	13.00	PASS
12,310.00	H		27.00	40.00	25.00	0.00	42.00	54.00	12.00	PASS
19,696.00		V	21.00	36.00	25.00	0.00	32.00	54.00	22.00	PASS
22,158.00		V	19.00	37.00	25.00	0.00	31.00	54.00	23.00	PASS

TEST ENGINEER:

Brian Haghtalab



### FCC RADIATED EMISSIONS DATA

**CLIENT:** YOUNG DESIGN  
**EUT:** LUCENT SILVER WLAN  
**ANTENNA:** 24 dBi Grid Dish  
**FREQ.:** 2462 MHZ  
**POWER:** 22 mW

3 METER TEST      Detector - PEAK

DATE: 11/02/2000

FREQUENCY MHz	POLARITY		SPEC A dBuV	AF/CL dB/m	AMP Gain dB	Average Factor dB	Peak E-Field dbuV/m	Avrg. Limit dBuV/m	MARGIN dB	CONDITION
	H	V								
4,924.00		V	30.00	35.00	25.00	0.00	40.00	54.00	14.00	PASS
7,386.00	H		33.00	37.00	25.00	0.00	45.00	54.00	9.00	PASS
12,310.00	H		27.00	40.00	25.00	0.00	42.00	54.00	12.00	PASS
19,696.00		V	21.00	36.00	25.00	0.00	32.00	54.00	22.00	PASS
22,158.00		V	20.00	37.00	25.00	0.00	32.00	54.00	22.00	PASS

TEST ENGINEER:

Brian Haghtalab

### FCC RADIATED EMISSIONS DATA

**CLIENT:** YOUNG DESIGN  
**EUT:** LUCENT SILVER WLAN  
**ANTENNA:** 18 dBi Flat Panel  
**FREQ.:** 2462 MHZ  
**POWER:** 22 mW

3 METER TEST      Detector - PEAK

DATE: 11/02/2000

FREQUENCY MHz	POLARITY		SPEC A dBuV	AF/CL dB/m	AMP Gain dB	Average Factor dB	Peak E-Field dbuV/m	Avrg. Limit dBuV/m	MARGIN dB	CONDITION
	H	V								
4,924.00		V	30.00	35.00	25.00	0.00	40.00	54.00	14.00	PASS
7,386.00		V	33.00	37.00	25.00	0.00	45.00	54.00	9.00	PASS
12,310.00		V	25.00	40.00	25.00	0.00	40.00	54.00	14.00	PASS
19,696.00	H		21.00	36.00	25.00	0.00	32.00	54.00	22.00	PASS
22,158.00	H		20.00	37.00	25.00	0.00	32.00	54.00	22.00	PASS

TEST ENGINEER:

Brian Haghtalab



### FCC RADIATED EMISSIONS DATA

CLIENT: YOUNG DESIGN  
 EUT: LUCENT SILVER WLAN  
 ANTENNA: 12 dBi Wide Angle  
 FREQ.: 2462 MHZ  
 POWER: 22 mW

3 METER TEST      Detector - PEAK

DATE: 11/02/2000

FREQUENCY MHz	POLARITY		SPEC A dBuV	AF/CL dB/m	AMP Gain dB	Average Factor dB	Peak E-Field dbuV/m	Avrg. Limit dBuV/m	MARGIN dB	CONDITION
	H	V								
4,924.00		V	32.00	35.00	25.00	0.00	42.00	54.00	12.00	PASS
7,386.00	H		28.00	37.00	25.00	0.00	40.00	54.00	14.00	PASS
12,310.00		V	25.00	40.00	25.00	0.00	40.00	54.00	14.00	PASS
19,696.00	H		21.00	36.00	25.00	0.00	32.00	54.00	22.00	PASS
22,158.00		V	20.00	37.00	25.00	0.00	32.00	54.00	22.00	PASS

TEST ENGINEER:

Brian Haghtalab

### FCC RADIATED EMISSIONS DATA

CLIENT: YOUNG DESIGN  
 EUT: LUCENT SILVER WLAN  
 ANTENNA: 12 dBi A2.4SP12A Flat Panel  
 FREQ.: 2462 MHZ  
 POWER: 22 mW

3 METER TEST      Detector - PEAK

DATE: 11/02/2000

FREQUENCY MHz	POLARITY		SPEC A dBuV	AF/CL dB/m	AMP Gain dB	Average Factor dB	Peak E-Field dbuV/m	Avrg. Limit dBuV/m	MARGIN dB	CONDITION
	H	V								
4,924.00	H		33.00	35.00	25.00	0.00	43.00	54.00	11.00	PASS
7,386.00	H		28.00	37.00	25.00	0.00	40.00	54.00	14.00	PASS
12,310.00		V	24.00	40.00	25.00	0.00	39.00	54.00	15.00	PASS
19,696.00	H		21.00	36.00	25.00	0.00	32.00	54.00	22.00	PASS
22,158.00	H		18.00	37.00	25.00	0.00	30.00	54.00	24.00	PASS

TEST ENGINEER:

Brian Haghtalab



**Table 1**

**EUT OPTIONAL ANTENNAS/ ACCESSORIES**

**FCC ID#: NMS-LUC2400E**

FCC certified systems consist of:

- A2440-xxF amplifier, DC Injector and 12 VDC Power supply
- Orinoco/Lucent WLAN card with the FCC ID#: IMRWLPCE24H
- Outdoor Antenna (Table A)
- Coax Cable (Table B)

**Table A**  
**Authorized Antennas**

<b>Antenna Type</b>	<b>Gain</b>	<b>Make</b>	<b>Model</b>
Grid Dish Antenna	24 dBi	Lucent	AOU24-DI-24
Grid Dish Antenna	24 dBi	YDI	PT2424
Grid Dish Antenna	21 dBi	YDI	PT2421
Flat Panel Antenna	18 dBi	YDI	A2.45FP18
Flat Panel Antenna	15 dBi	YDI	A2.45FP15
Flat Panel Antenna	12 dBi	YDI	A2.45FP12
Long Panel Antenna	17 dBi	YDI	A2.45LP17
Long Panel Antenna	14 dBi	YDI	A2.45LP14
Omni Antenna	12 dBi	YDI	A2412
Omni Antenna	10 dBi	Lucent	AOU24-OD-10
Omni Antenna	10 dBi	YDI	A2410
Omni Antenna	9 dBi	YDI	A2408
Omni Antenna	6 dBi	Lucent	LXE 155845
Wide Angle Antenna	12 dBi	Lucent	AOU-WA-12-B
Wide Angle Antenna	12 dBi	Lucent	AOU-WA-12-A
Amplified Flat Panel Antenna	12 dBi	YDI	A2.4SP12A



**Table 1**

**EUT OPTIONAL ANTENNAS/ ACCESSORIES**

**Table B**

**Authorized Cables with Minimum Lengths**

<b>Cable Type</b>	<b>Minimum Length/Loss</b>	<b>Max Recommended Lengths</b>
RG58/U LMR195	19 Feet/ 3.4 dB	40 Feet
LMR200	20 Feet/ 3.4 dB	50 Feet
LMR240	25 Feet/ 3.3 dB	65 Feet
LMR400	50 Feet/ 3.4 dB	110 Feet
LMR 500	60 Feet/ 3.5 dB	150 Feet
LMR 600	80 Feet/ 3.5 dB	180 Feet
LMR 900	120 Feet/ 3.5 dB	260 Feet
LMR1200	150 Feet/ 3.4 dB	350 Feet
LMR1700	200 Feet/ 3.4 dB	480 Feet

**NOTE:** This table is for reference only. In order to comply with FCC Part 15 Certification, the installer must insure that actual coax cable used between the DC injector and the amplifier has at least 3.3 dB of insertion loss.

---





**Table 2**

**SUPPORT EQUIPMENT**

Host Computer - Panasonic Model CF35 Pentium Laptop Computer



**Table 3**

**Measurement Equipment Used**

The following equipment is used to perform measurements:

HP 435A RF Peak Power Meter	- Serial No. 1362016
EMCO Model 3110 Biconical Antenna	- Serial No. 1619
Antenna Research MWH-1825B Horn Antenna	- Serial No. 1005
EMCO Model 3115 Ridged Horn Antenna	- Serial No. 3007
HP 8348A Preamplifier	- Serial No. 197-2564A
Solar 8012-50-R-24-BNC LISN	- Serial No. 924867
Bird 8306-300-N 30dB Attenuator	- Serial No. 29198391515
HP 14IT w/8555A Spectrum Analyzer	- Serial No. 6-95-1124
Advanest Model R4131D Spectrum Analyzer	- Serial No. 54378A
4 Meter Antenna Mast	
Motorized Turntable	
Heliac FSJ1-50A 1/4" Superflex Coax Cable (12 Ft.)	



## RF EXPOSURE STATEMENT

### Notice in Installation Manual:

### FCC Radiation Exposure Statement

This equipment complies with FCC radiation exposure limits set forth for an uncontrolled environment, when installed as directed. This equipment should be installed and operated with fix-mounted antennas that are installed with a minimum of 2 meters of separation distance between the antenna and all persons' body during normal operation.

### RF Exposure Calculations:

The following information provides the **minimum** separation distance for the highest gain antenna provided with the the **Lucent WaveLAN Silver Card with Model AMP2440-RxF Amplifier**, as calculated from **FCC OET 65 Appendix B, Table 1B** Guidelines for General Population/Uncontrolled Exposure. This calculation is based on the highest EIRP possible from the system, considering maximum power and antenna gain, and considering a 1.0 mW/cm<sup>2</sup> uncontrolled exposure limit. The Friss formula used was:

$$S = (P_o * G) / (4 * \pi * r^2) \quad \text{or} \quad r = \sqrt{(P_o * G) / (4 * \pi * S)}$$

Where **S** = 1.0 mW/cm<sup>2</sup> for 2400 MHz

Where **P<sub>o</sub>** = 250 mW (Peak RF)

Where **G** = Isotropic antenna gain (numeric)

Where **r** = Minimum Safe Distance from antenna (cm)

For: 24 dBi Grid Dish Antenna - Lucent or YDI models ..... r = 71 cm