





DFS TEST REPORT

Part 15 Subpart E 15.407

Equipment under test NETWORK VIDEO RECORDER
Model name TRM-810S
FCC ID NLMTRM810S
Applicant Hanwha Techwin Co., Ltd.
Manufacturer Hanwha Techwin (Tianjin) Co.,Ltd.
 Hanwha Techwin Security Vietnam Co.,Ltd.
 D-TECH Co.,Ltd.
Date of test(s) 2019.01.07 ~ 2019.01.30
Date of issue 2019.02.14

Issued to
Hanwha Techwin Co., Ltd.
 6, Pangyo-ro 319 Beon-gil, Bundang-gu Seongnam-si,
 Gyeonggi-do, 13488, Korea
 Tel: +82-70-7147-8361/ Fax: +82-31-8108-3717

Issued by
KES Co., Ltd.
 3701, 40, Simin-daero 365beon-gil, Dongan-gu, Anyang-si,
 Gyeonggi-do, Korea
 473-21, Gayeo-ro, Yeosu-si, Gyeonggi-do, Korea
 Tel: +82-31-425-6200 / Fax: +82-31-424-0450

Test and report completed by :	Report approval by :
	
Young-Jin Lee Test engineer	Hyeon-Su, Jang Technical manager



KES Co., Ltd.

C-3701, 40, Simin-daero 365beon-gil,
Dongan-gu, Anyang-si, Gyeonggi-do, Korea
Tel: +82-31-425-6200 / Fax: +82-31-424-0450
www.kes.co.kr

Test report No.:
KES-RF-19T0016
Page (2) of (19)

Revision history

Revision	Date of issue	Test report No.	Description
-	2019.02.14	KES-RF-19T0016	Initial

This report shall not be reproduced except in full, without the written approval of KES Co., Ltd.
The results shown in this test report refer only to the sample(s) tested unless otherwise stated.
The authenticity of the test report, contact shchoi@kes.co.kr



TABLE OF CONTENTS

1.	General information	4
1.1.	EUT description	4
1.2.	Test configuration.....	5
1.3.	Accessory information	5
1.4.	Software and Firmware description	5
1.5.	Device modifications.....	5
1.6.	Frequency/channel operations	6
2.	Summary of tests	7
3.	DFS (Dynamic Frequency Selection) test description	8
3.1.	Applicability.....	8
3.2.	Requirements.....	9
3.3.	DFS Detection Thresholds	10
3.4.	Parameters of DFS Test Signals	11
4.	Test results	12
4.1.	DFS (Dynamic Frequency Selection)	12
4.1.1	Radar waveform.....	13
4.1.2	LAN Traffic	14
4.1.3	Channel move time & aggregate channel closing transmission time.....	15
4.1.4	Non-occupancy period	17
Appendix A.	18

1. General information

Applicant: Hanwha Techwin Co., Ltd.
 Applicant address: 1204, Changwon-daero, Seongsan-gu, Changwon-si,
 Gyeongsangnam-do, South Korea
 Test site: KES Co., Ltd.
 Test site address: 3701, 40, Simin-daero 365beon-gil, Dongan-gu, Anyang-si, Gyeonggi-do, Korea
 473-21, Gayeo-ro, Yeosu-si, Gyeonggi-do, Korea
 Test Facility: FCC Accreditation Designation No.: KR0100, Registration No.: 444148
 Rule part(s): 15.407
 FCC ID: NLMTRM810S
 Test device serial No.: Production Pre-production Engineering

1.1. EUT description

Equipment under test: NETWORK VIDEO RECORDER
 Frequency range: UNII-1 5 180 MHz ~ 5 240 MHz (11ac_VHT20)
 5 190 MHz ~ 5 230 MHz (11ac_VHT40)
 5 210 MHz (11ac_VHT80)
 UNII-2A 5 260 MHz ~ 5 320 MHz (11ac_VHT20)
 5 270 MHz ~ 5 310 MHz (11ac_VHT40)
 5 290 MHz (11ac_VHT80)
 UNII-2C 5 500 MHz ~ 5 720 MHz (11ac_VHT20)
 5 510 MHz ~ 5 710 MHz (11ac_VHT40)
 5 530 MHz ~ 5 690 MHz (11ac_VHT80)
 UNII-3 5 745 MHz ~ 5 825 MHz (11ac_VHT20)
 5 755 MHz ~ 5 795 MHz (11ac_VHT40)
 5 775 MHz (11ac_VHT80)
 GPS 1 575.42 MHz (GPS)
 Model: TRM-810S
 Modulation technique: OFDM
 Antenna specification: 5 GHz_UNII 1, 2A // Dipole Antenna & 2.72 dBi
 5 GHz_UNII 2C // Dipole Antenna & 3.45 dBi
 5 GHz_UNII 3 // Dipole Antenna & 5.63 dBi
 Power source: DC 9V~36V

Number of channels 5 180 MHz ~ 5 240 MHz (11ac_VHT20) : 4ch
 5 190 MHz ~ 5 230 MHz (11ac_VHT40) : 2ch
 5 210 MHz (11ac_VHT80) : 1ch
 5 260 MHz ~ 5 320 MHz (11ac_VHT20) : 4ch
 5 270 MHz ~ 5 310 MHz (11ac_VHT40) : 2ch
 5 290 MHz (11ac_VHT80) : 1ch
 5 500 MHz ~ 5 720 MHz (11ac_VHT20) : 12ch
 5 510 MHz ~ 5 710 MHz (11ac_VHT40) : 6ch
 5 530 MHz ~ 5 690 MHz (11ac_VHT80) : 3ch
 5 745 MHz ~ 5 825 MHz (11ac_VHT20) : 5ch
 5 755 MHz ~ 5 795 MHz (11ac_VHT40) : 2ch
 5 775 MHz (11ac_VHT80) : 1ch
 1 575.42 MHz (GPS) : 1ch

1.2. Test configuration

The **Hanwha Techwin Co., Ltd. NETWORK VIDEO RECORDER FCC ID: NLMTRM810S** was tested per the guidance of KDB 905462 D02 v02, D03 v01r02.

1.3. Accessory information

Equipment	Manufacturer	Model	Serial No.	Power source
Control Box	Hanwha Techwin(Tianjin) Co., Ltd.	-	-	-

1.4. Software and Firmware description

The software and firmware installed in the EUT is version V1.00_190129183607

1.5. Device modifications

N/A

1.6. Frequency/channel operations
UNII-1

Ch.	Frequency (MHz)
36	5 180
44	5 220
48	5 240

UNII-2A

Ch.	Frequency (MHz)
52	5 260
56	5 280
64	5 320

UNII-2C

Ch.	Frequency (MHz)
100	5 500
120	5 600
144	5 720

UNII-3

Ch.	Frequency (MHz)
149	5 745
157	5 785
165	5 825

Table 1.7-1. 802.11ac_VHT20 mode

UNII-1

Ch.	Frequency (MHz)
38	5 190
46	5 230

UNII-2A

Ch.	Frequency (MHz)
54	5 270
62	5 310

UNII-2C

Ch.	Frequency (MHz)
102	5 510
118	5 590
142	5 710

UNII-3

Ch.	Frequency (MHz)
151	5 755
159	5 795

Table 1.7-2. 802.11ac_VHT40 mode

UNII-1

Ch.	Frequency (MHz)
42	5 210

UNII-2A

Ch.	Frequency (MHz)
58	5 290

UNII-2C

Ch.	Frequency (MHz)
106	5 530
122	5 610
138	5 690

UNII-3

Ch.	Frequency (MHz)
155	5 775

Table 1.7-3. 802.11ac_VHT80 mode



2. Summary of tests

Reference	Parameter	Test results
15.407(h)(iii)(iv)	Channel Move Time	Pass
	Channel Closing Transmission Time	Pass
	Non-Occupancy Period	Pass

3. DFS (Dynamic Frequency Selection) test description

3.1. Applicability

The following table from KDB 905462 D02 v02 lists the applicable requirements for the DFS testing. The device evaluated in this report is considered a client device without radar detection capability.

Requirement	Operational Mode		
	Master	Client Without Radar Detection	Client With Radar Detection
Non-Occupancy Period	Yes	Not required	Yes
DFS Detection Threshold	Yes	Not required	Yes
Channel Availability Check Time	Yes	Not required	Not required
U-NII Detection Bandwidth	Yes	Not required	Yes

Table 2.1. DFS Applicability

Requirement	Operational Mode	
	Master Device or Client with Radar Detection	Client Without Radar Detection
DFS Detection Threshold	Yes	Not required
Channel Closing Transmission Time	Yes	Yes
Channel Move Time	Yes	Yes
U-NII Detection Bandwidth	Yes	Not required
Non-Occupancy Period	NA/Yes	Yes

Additional requirements for devices with multiple	Master Device or Client with Radar Detection	Client Without Radar Detection
U-NII Detection Bandwidth and statistical Performance Check	All BW modes must be tested	Not required
Channel Move Time and Channel Closing Transmission Time	Test using widest BW mode available	Test using the widest BW mode available for the link
All other tests	Any single BW mode	Not required
Note: Frequencies selected for statistical performance check (Section 7.8.4) should include several frequencies within the radar detection bandwidth and frequencies near the edge of the radar detection bandwidth. For 802.11 devices it is suggested to select frequencies in each of the bonded 20 MHz channels and the channel center frequency.		

Table 2.2. DFS Applicability During normal operation

3.2. Requirements

KDB 905462 D02 v02 the following are the requirements for Client Devices:

- a) A Client Device will not transmit before having received appropriate control signals from a Master Device.
- b) A Client Device will stop all its transmissions whenever instructed by a Master Device to which it is associated and will meet the Channel Move Time and Channel Closing Transmission Time requirements. The Client Device will not resume any transmissions until it has again received control signals from a Master Device.
- c) If a Client Device is performing In-Service Monitoring and detects a Radar Waveform above the DFS Detection Threshold, it will inform the Master Device. This is equivalent to the Master Device detecting the Radar Waveform and d) through f) of section 5.1.1 apply.
- d) Irrespective of Client Device or Master Device detection the Channel Move Time and Channel Closing Transmission Time requirements remain the same.
- e) The client test frequency must be monitored to ensure no transmission of any type has occurred for 30 minutes. Note: If the client moves with the master, the device is considered compliant if nothing appears in the client non-occupancy period test. For devices that shutdown (rather than moving channels), no beacons should appear

Parameter	Value
Non-occupancy period	Minimum 30 minutes
Channel Availability Check Time	60 seconds
Channel Move Time	10 seconds See Note 1.
Channel Closing Transmission Time	200 milliseconds + an Aggregate of 60 milliseconds over remaining 10 second period. See Notes 1 and 2.
U-NII Detection Bandwidth	Minimum 100% of the U-NII 99% transmission power bandwidth. See Note3.
<p>Note 1: Channel Move Time and the Channel Closing Transmission Time should be performed with Radar Type 0. The measurement timing begins at the end of the Radar Type 0 burst.</p> <p>Note 2: The Channel Closing Transmission Time is comprised of 200 milliseconds starting at the beginning of the Channel Move Time plus any additional intermittent control signals required to facilitate a Channel move (and aggregate of 60 milliseconds) during the remainder of the 10 second period. The aggregate duration of control signals will not count quiet periods in between transmissions.</p> <p>Note 3: During the U-NII Detection Bandwidth detection test, radar type 0 should the used. For each frequency step the minimum percentage of detection is 90 percent. Measurements are performed with no data traffic.</p>	

Table 2.3. DFS Response Requirement Values

3.3. DFS Detection Thresholds

The DFS detection thresholds are defined for Master devices and Client Devices with In-service monitoring. These detection Thresholds are listed in the following table.

Maximum Transmit Power	Value (See Notes 1, 2, and 3)
EIRP \geq 200 milliwatt	-64 dBm
EIRP < 200 milliwatt and Power spectral density < 10 dBm/MHz	-62 dBm
EIRP < 200 milliwatt that do not meet the power spectral density requirement	-64 dBm
<p>Note 1: This is the level at the input of the receiver assuming a 0 dBi receive antenna.</p> <p>Note 2: Throughout these test procedures an additional 1 dB has been added to the amplitude of the test transmission waveforms to account for variations in measurement equipment. This will ensure that the test signal is at or above the detection threshold level to trigger a DFS respons.</p> <p>Note 3: EIRP is based on the highest antenna gain. For MIMO devices refer to KDB Publication 662911 D01</p>	

Table 2.4. DFS Detection Thresholds for Master Devices and Client Devices With Radar Detection

3.4. Parameters of DFS Test Signals

As the EUT is a Client Device with no Radar Detection only Zero type radar pulse is required for the testing. Radar Pulse type 0 was used in the evaluation of the Client device for the purpose of measuring the channel Move Time and the Channel Closing Transmission Time.

Radar Type	Pulse Width (μsec)	PRI (μsec)	Number of Pulses	Minimum Percentage of Successful Detection	Mnimum Number of Trials
0	1	1428	18	See Note 1	See Note 1
1	1	Test A: 15 unique PRI values randomly selected from the list of 23 PRI values in Table 5a	Roundup: {(1/360)*(19*10 ⁶ PRI μsec)}	60%	30
		Test B: 15 unique PRI values randomly selected within the range of 518-3066 μsec, with a minimum increment of 1 μsec, excluding PRI values selected in Test A			
2	1-5	150-230	23-29	60%	30
3	6-10	200-500	16-18	60%	30
4	11-20	200-500	12-16	60%	30
Aggregate (Radar Types 1-4)				80%	120
Note 1: Short Pulse Radar Type 0 should be used for the detection bandwidth test, channel move time, and channel closing time tests.					

Table 2.5. Short Pulse Radar Test Waveforms

Radar Type	Pulse Width (μsec)	Chirp Width (MHz)	PRI (μsec)	Pulses per Burst	Number of Bursts	Minimum Percentage of Successful Detection	Minimum Trials
5	50-100	5-20	1000-2000	1-3	8-20	80%	30

Table 2.6. Short Pulse Radar Test Waveforms

Radar Type	Pulse Width (μsec)	PRI (μsec)	Pulses Per Hop	Hopping Rate (kHz)	Hopping Sequence Length (msec)	Minimum Percentage of Successful Detection	Minimum Trials
6	1	333	9	0.333	300	70%	30

Table 2.7. Frequency Hopping Radar Test Waveform

4. Test results

4.1. DFS (Dynamic Frequency Selection)

Test setup

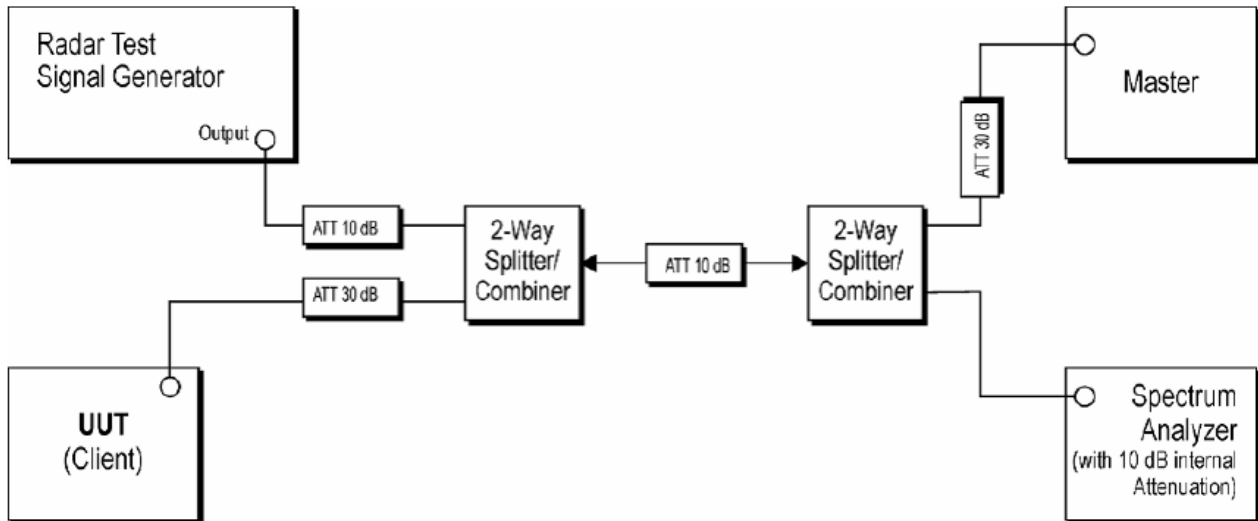

Figure 1: Conducted Test Setup for DFS

Test procedure

KDB 905462 D02 v02 describes a radiated test setup and a conducted test setup. The conducted test setup was used for this testing. Figure 1 shows the typical test setup.

1. One frequency will be chosen from the Operating Channels of the UUT within the 5250 ~5350 MHz or 5470 ~5725 MHz bands.
2. The Client Device (EUT) is setup per the diagram in Figure 1 and communications between the Master device and the Client is established.
3. An MPEG or data file that is typical for the device is streamed from the Master to the Client to properly load the network.

4.1.1 Radar waveform

Mode: 802.11ac_VHT80 (Band2A)
 Operating frequency: 5 290 MHz

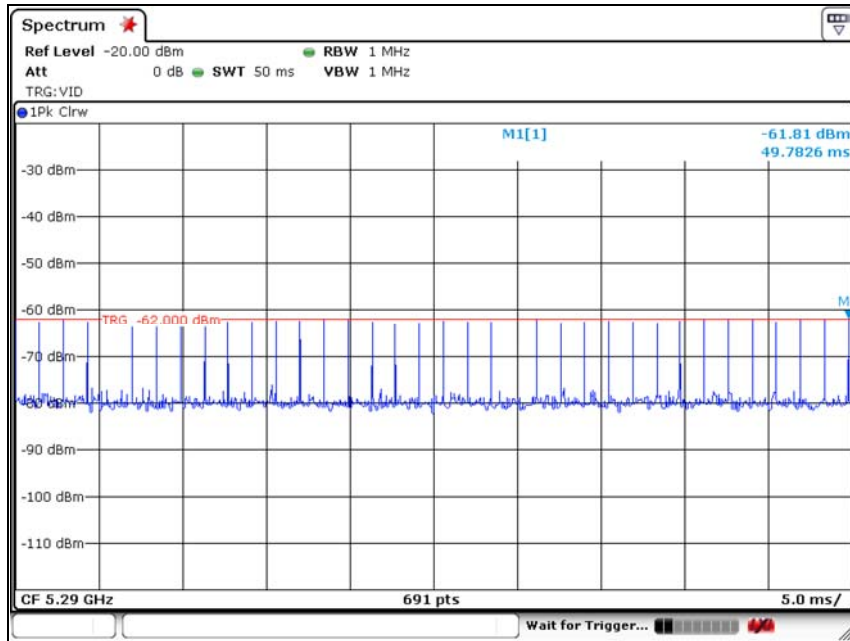

Mode: 802.11ac_VHT80 (Band2C)
 Operating frequency: 5 530 MHz

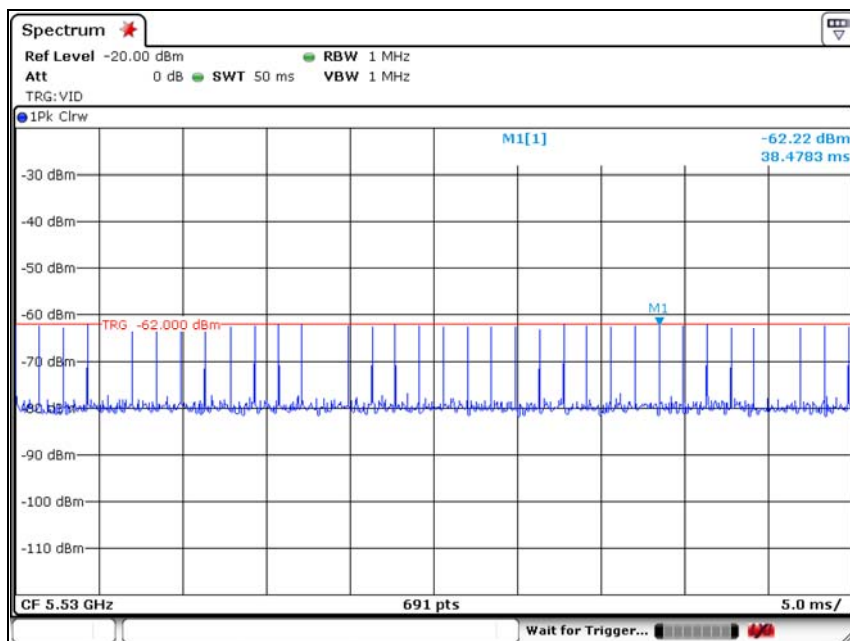

This report shall not be reproduced except in full, without the written approval of KES Co., Ltd.
 The results shown in this test report refer only to the sample(s) tested unless otherwise stated.
 The authenticity of the test report, contact shchoi@kes.co.kr

4.1.2 LAN Traffic

Mode: 802.11ac_VHT80 (Band2A)
 Operating frequency: 5 290 MHz

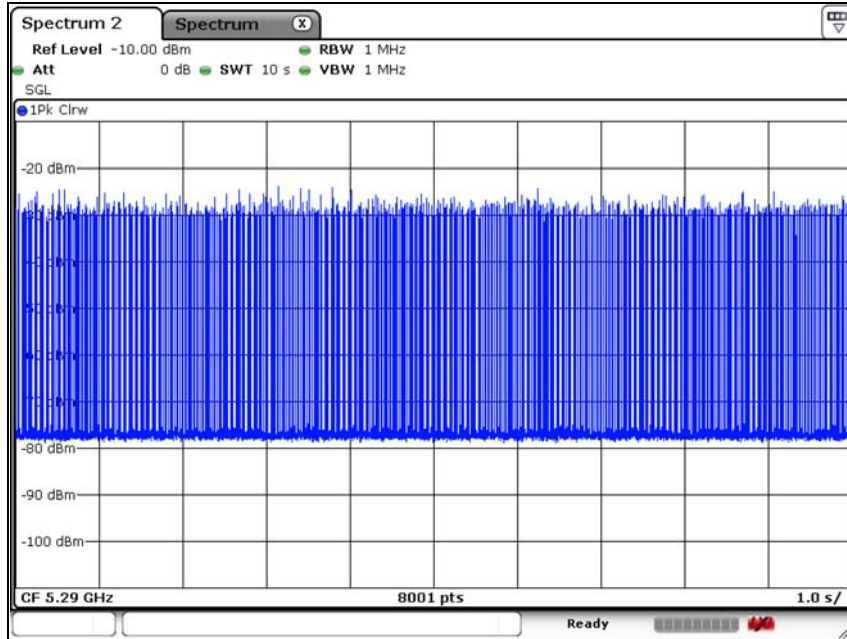

Mode: 802.11ac_VHT80 (Band2C)
 Operating frequency: 5 530 MHz

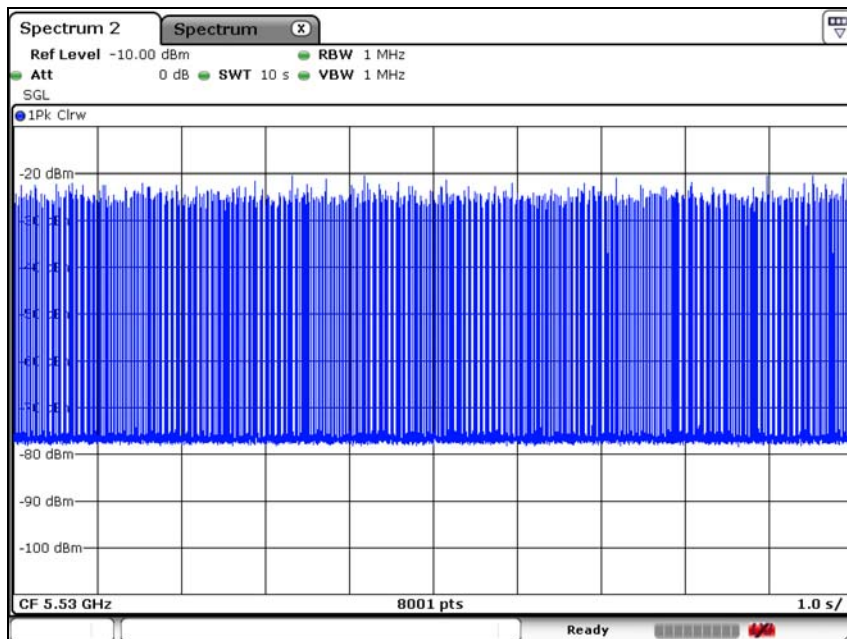

This report shall not be reproduced except in full, without the written approval of KES Co., Ltd.
 The results shown in this test report refer only to the sample(s) tested unless otherwise stated.
 The authenticity of the test report, contact shchoi@kes.co.kr

4.1.3 Channel move time & aggregate channel closing transmission time

Mode: 802.11ac_VHT80 (Band2A)
 Operating frequency: 5 290 MHz

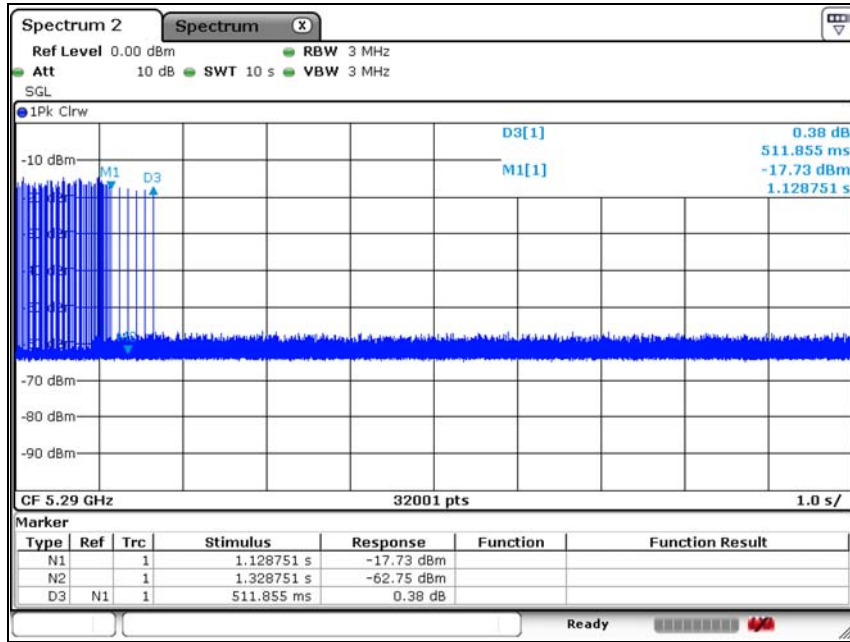

Channel closing transmission time calculated	Test results
Sweep time[S] sec	10
Sampling bins[B]	32001
Number of sampling bins in 10 sec[N]	1
Closing transmission time [C] ms	0.312

Channel move time (s)	Limit
0.512	≤ 10 s

Note:

Dwell = S/B;

Where **dwell** is the dwell time per spectrum analyzer sampling bin, **S** is the sweep time and **B** is the number of spectrum analyzer sampling bins.

An upper bound of the aggregate duration of the channel closing transmission time is calculated by:

C = N × Dwell;

Where **C** is the closing time, **N** is the number of spectrum analyzer sampling bins showing a U-NII transmission and **dwell** is the dwell time per bin.

Dwell = [S] / [B] = 10 / 32001 = 0.000312

Closing Transmission Time[C] = [N] × [Dwell] = 1 × 0.000312 = 0.000312 s = 0.312 ms

Mode: 802.11ac_VHT80 (Band2C)
 Operating frequency: 5 530 MHz

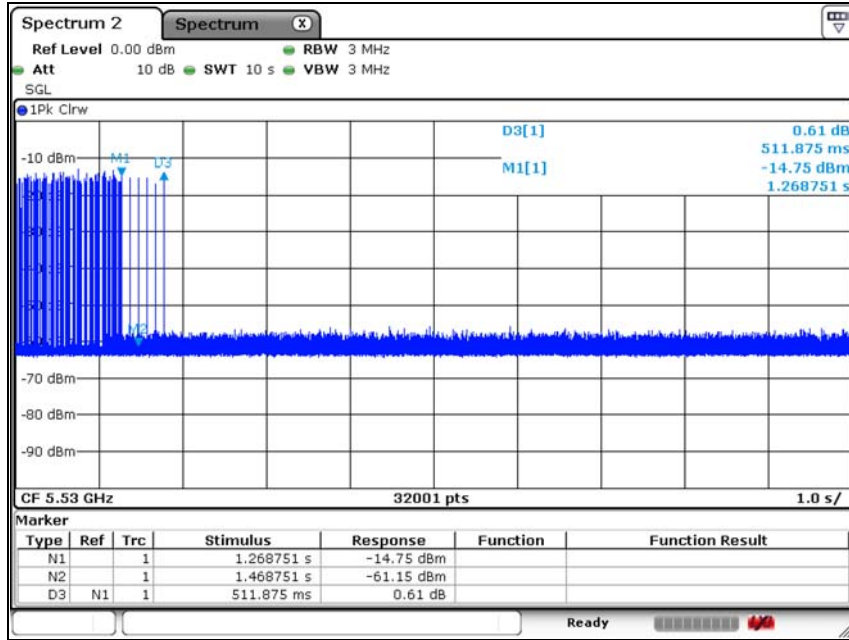

Channel closing transmission time calculated	Test results
Sweep time[S] sec	10
Sampling bins[B]	32001
Number of sampling bins in 10 sec[N]	1
Closing transmission time [C] ms	0.312

Channel move time (s)	Limit
0.512	≤ 10 s

Note:

Dwell = S/B;

Where **dwell** is the dwell time per spectrum analyzer sampling bin, **S** is the sweep time and **B** is the number of spectrum analyzer sampling bins.

An upper bound of the aggregate duration of the channel closing transmission time is calculated by:

C = N × Dwell;

Where **C** is the closing time, **N** is the number of spectrum analyzer sampling bins showing a U-NII transmission and **dwell** is the dwell time per bin.

Dwell = [S] / [B] = 10 / 32001 = 0.000312

Closing Transmission Time[C] = [N] × [Dwell] = 1 × 0.000312 = 0.000312 s = 0.312 ms

4.1.4 Non-occupancy period

Mode: 802.11ac_VHT80 (Band2A)
 Operating frequency: 5 290 MHz

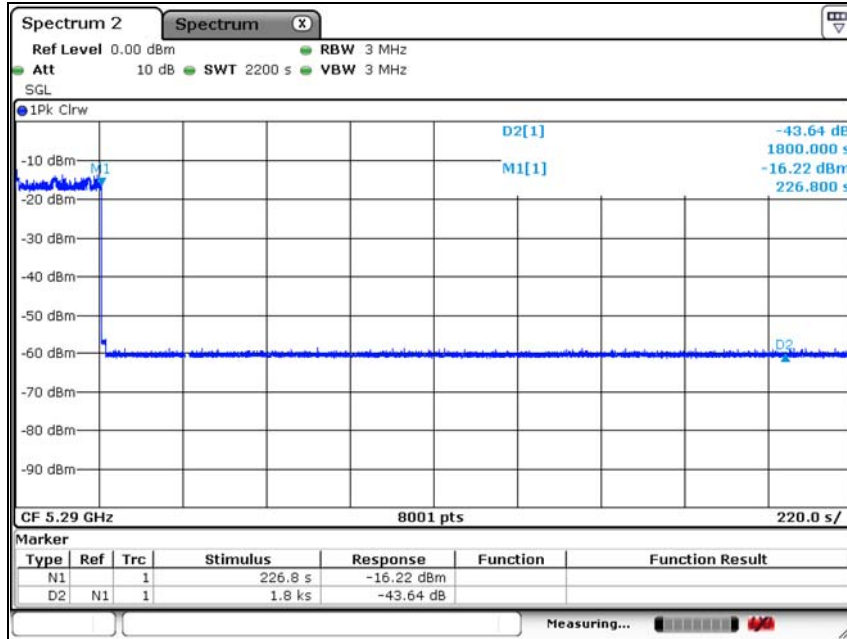

Mode: 802.11ac_VHT80 (Band2C)
 Operating frequency: 5 530 MHz

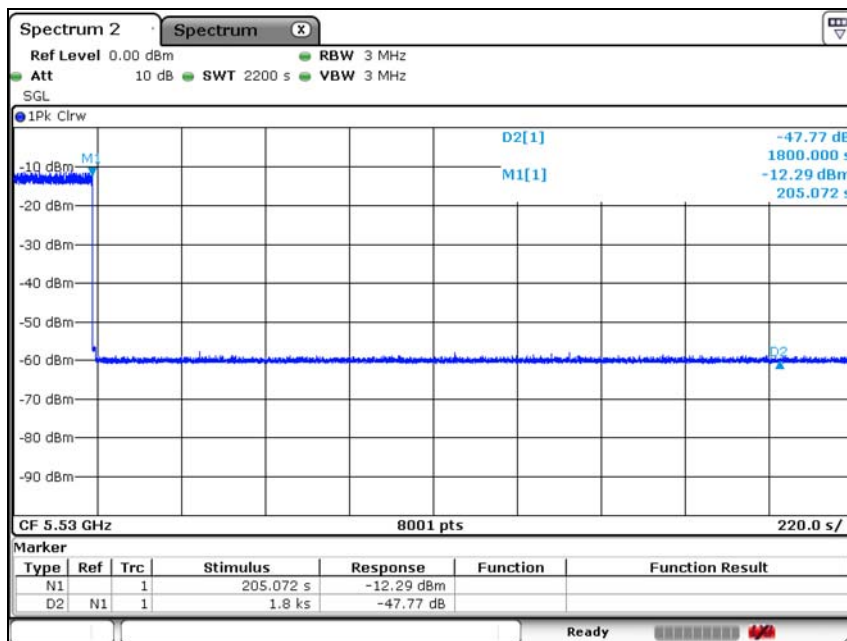

This report shall not be reproduced except in full, without the written approval of KES Co., Ltd.
 The results shown in this test report refer only to the sample(s) tested unless otherwise stated.
 The authenticity of the test report, contact shchoi@kes.co.kr



KES Co., Ltd.

C-3701, 40, Simin-daero 365beon-gil,
Dongan-gu, Anyang-si, Gyeonggi-do, Korea
Tel: +82-31-425-6200 / Fax: +82-31-424-0450
www.kes.co.kr

Test report No.:
KES-RF-19T0016
Page (18) of (19)

Appendix A.

Measurement equipment

This report shall not be reproduced except in full, without the written approval of KES Co., Ltd.
The results shown in this test report refer only to the sample(s) tested unless otherwise stated.
The authenticity of the test report, contact shchoi@kes.co.kr



KES Co., Ltd.

C-3701, 40, Simin-daero 365beon-gil,
 Dongan-gu, Anyang-si, Gyeonggi-do, Korea
 Tel: +82-31-425-6200 / Fax: +82-31-424-0450
 www.kes.co.kr

Test report No.:
 KES-RF-19T0016
 Page (19) of (19)

Equipment	Manufacturer	Model	Serial No.	Calibration interval	Calibration date.	Calibration due.
Spectrum Analyzer	R&S	FSV30	100736	1 year	2018.06.28	2019.06.28
					2019.01.09	2020.01.09
Vector Signal Generator	R&S	SMBV100A	256397	1 year	2018.06.28	2019.06.28
Attenuator	HP	8495B	110504721	1 year	2018.01.18	2019.01.18
					2019.01.15	2020.01.15
Attenuator	WEINSCHL	200099	8969	1 year	2018.01.18	2019.01.18
					2019.01.15	2020.01.15
Attenuator	WEINSCHL	200099	9011	1 year	2018.01.18	2019.01.18
					2019.01.15	2020.01.15
Attenuator	KEYSIGHT	8493C	82506	1 year	2018.01.22	2019.01.22
					2019.01.15	2020.01.15
Attenuator	HP	8495B	2630A12857	1 year	2018.01.18	2019.01.18
					2019.01.15	2020.01.15
Attenuator	Agilent	8493C	51401	1 year	2018.06.29	2019.06.29
Splitter	MINI-CIRCUITS	ZFSC-2-10G+	F679501347-1	1 year	2018.06.28	2019.06.28
Splitter	MINI-CIRCUITS	ZFSC-2-10G+	F679501347-2	1 year	2018.06.28	2019.06.28
DC Power supply	EXTENDED	EX-1500H2	405410100030	1 year	2018.04.13	2019.04.13

Peripheral devices

Device	Manufacturer	Model No.	Serial No.	Note.
Access Point (Master)	Cisco system Inc.	AIR-RM3000AC-A-K9	-	FCC ID: LDK102086
Notebook Computer	LG	LG15U47	701QCPY564416	-

This report shall not be reproduced except in full, without the written approval of KES Co., Ltd.
 The results shown in this test report refer only to the sample(s) tested unless otherwise stated.
 The authenticity of the test report, contact shchoi@kes.co.kr