

WISENET

NETWORK VIDEO RECORDER

User Manual

TRM-1610S
TRM-1610M

Network Video Recorder

User Manual

Copyright

©2017 Hanwha Techwin Co., Ltd. All rights reserved.

Trademark

Each of trademarks herein is registered. The name of this product and other trademarks mentioned in this manual are the registered trademark of their respective company.

Restriction

Copyright of this document is reserved. Under no circumstances, this document shall be reproduced, distributed or changed, partially or wholly, without formal authorization.

Disclaimer

Hanwha Techwin makes the best to verify the integrity and correctness of the contents in this document, but no formal guarantee shall be provided. Use of this document and the subsequent results shall be entirely on the user's own responsibility. Hanwha Techwin reserves the right to change the contents of this document without prior notice.

❖ Design and specifications are subject to change without prior notice.

❖ The initial administrator ID is "admin" and the password should be set when logging in for the first time.

Please change your password every three months to safely protect personal information and to prevent the damage of the information theft.

Please, take note that it's a user's responsibility for the security and any other problems caused by mismanaging a password.



IMPORTANT SAFETY INSTRUCTIONS

Read these operating instructions carefully before using the unit.
Follow all the safety instructions listed below.
Keep these operating instructions handy for future reference.

- 1) Read these instructions.
- 2) Keep these instructions.
- 3) Heed all warnings.
- 4) Follow all instructions.
- 5) Do not use this apparatus near water.
- 6) Clean the contaminated area on the product surface with a soft, dry cloth or a damp cloth. (Do not use a detergent or cosmetic products that contain alcohol, solvents or surfactants or oil constituents as they may deform or cause damage to the product.)
- 7) Do not block any ventilation openings, Install in accordance with the manufacturer's instructions.
- 8) Do not install near any heat sources such as radiators, heat registers, stoves, or other apparatus (including amplifiers) that produce heat.
- 9) Do not defeat the safety purpose of the polarized or grounding- type plug. A polarized plug has two blades with one wider than the other. A grounding type plug has two blades and a third grounding prong. The wide blade or the third prong are provided for your safety. If the provided plug does not fit into your outlet, consult an electrician for replacement of the obsolete outlet.
- 10) Protect the power cord from being walked on or pinched particularly at plugs, convenience receptacles, and the point where they exit from the apparatus.
- 11) Only use attachments/accessories specified by the manufacturer.
- 12) Use only with the cart, stand, tripod, bracket, or table specified by the manufacturer, or sold with the apparatus. When a cart is used, use caution when moving the cart/ apparatus combination to avoid injury from tip-over.
- 13) Unplug this apparatus during lightning storms or when unused for long periods of time.
- 14) Refer all servicing to qualified service personnel. Servicing is required when the apparatus has been damaged in any way, such as power-supply cord or plug is damaged, liquid has been spilled or objects have fallen into the apparatus, the apparatus has been exposed to rain or moisture, does not operate normally, or has been dropped.



Standards Approvals

- 
 - Any changes or modifications in construction of this device which are not expressly approved by the party responsible for compliance could void the user's authority to operate the equipment.
- 
 - This device complies with part 15 of the FCC Rules. Operation is subject to the following two conditions: (1) This device may not cause harmful interference, and (2) this device must accept any interference received, including interference that may cause undesired operation.
 - This equipment has been tested and found to comply with the limits for a Class A digital device, pursuant to part 15 of the FCC Rules. These limits are designed to provide reasonable protection against harmful interference when the equipment is operated in a commercial environment. This equipment generates, uses, and can radiate radio frequency energy and, if not installed and used in accordance with the instruction manual, may cause harmful interference to radio communications. Operation of this equipment in a residential area is likely to cause harmful interference in which case the user will be required to correct the interference at his own expense.

BEFORE START

This manual provides operational information necessary for using the product and contains a description about each component part and its function as well as menu or network settings.
You have to keep in mind the following notices :

- Hanwha Techwin retains the copyright on this manual.
- This manual cannot be copied without Hanwha Techwin's prior written approval.
- We are not liable for any or all losses to the product incurred by your use of non-standard product or violation of instructions mentioned in this manual.
- Prior to opening the case, please consult a qualified technician first. Whenever this is needed power must be removed from the unit.
- Before adding a hard disk drive or external storage (USB memory, USB HDD, etc), check if it is compliant with this product. For the compatibility list, contact the retailer.

Warning

Battery

The following are the specifications of the battery you are using now.

- Normal capacity : 3mAh
- Continuous standard load : 0.015mA
- Operating temperature : -40°C ~ 85°C
(-40°F ~ +176°F)

CALIFORNIA USA ONLY

This Perchlorate warning applies only to primary CR (Manganese Dioxide) Lithium coin cells in the product sold or distributed ONLY in California USA. "Perchlorate Material - special handling may apply, See www.dtsc.ca.gov/hazardouswaste/perchlorate."

Caution

- Connect the power cord into a grounded outlet.
- The Mains plug is used as a disconnect device and shall stay readily operable at any time.
- Batteries shall not be exposed to excessive heat such as sunshine, fire or the like.
- Risk of Explosion if Battery is replaced by an Incorrect Type. Dispose of Used Batteries According to the Instructions.

System Shutdown

Turning off the power while the product is in operation, or undertaking improper actions may cause damage or malfunction to the hard drive or the product.

To safely power off, select Exit from the menu and click <OK> on the pop-up screen, then unplug the power cable.

You may want to install a UPS system for safe operation in order to prevent damage caused by an unexpected power stoppage. (Any questions concerning UPS, consult your UPS retailer.)



- If powered off abnormally, restarting may take more time for restoring data from hard disk drive for proper operation.

Operating Temperature

If left unused for an extended period of time at low temperatures of -40°C to 70°C(-40°F ~ 158°F) (when an industrial SSD is used), the heater operation time will increase.

As the operating temperature of the hard disk is 5°C to 55°C(41°F ~ 131°F), be careful to avoid using the product in low temperature conditions as it may cause HDD damage.

Ethernet Port

This equipment is in door use and all the communication wirings are limited to inside of the building.

Security Precautions

The initial administrator ID is “**admin**” and the password should be set when logging in for the first time.

Please change your password every three months to safely protect personal information and to prevent the damage of the information theft.

Please, take note that it's a user's responsibility for the security and any other problems caused by mismanaging a password.

CONTENTS

OVERVIEW	3	Important Safety Instructions
	3	Before Start
	5	Contents
	6	Features
	7	Part Names and Functions (Front)
	7	Part Names and Functions (Rear)
	8	How to check M12 terminal pins
	8	DC power connector wiring diagram
	8	Alarm input/output wiring diagram
	9	Control box name and function

INSTALLATION	10	Checking the installation environment
	10	How to install the bracket
	10	How to install the control box
	10	How to connect the control box
	10	HDD Addition

CONNECTING WITH OTHER DEVICE	12	Connecting to an external device
	12	Connecting the USB
	12	Connecting the Alarm Input/Output
	12	Connecting the Network

LIVE	14	Getting Started
	15	Live Screen Configuration
	18	Live Screen Mode
	21	Zoom
	21	Layout
	22	Audio ON/OFF
	22	Freeze
	22	Event Monitoring
	22	Capture
	23	Maintain the Screen Ratio
	24	Backup

MENU SETUP	25	System Setup
	30	Setting the Device
	39	Setting the Recording
	41	Setting the Event
	43	Network Configuration

SEARCH & PLAY	51	Search
	52	Playback

STARTING WEB VIEWER	54	What is Web Viewer?
	54	Connecting Web Viewer

LIVE VIEWER	56	Live Viewer
	57	Live Screen Configuration
	60	Controlling a Connected Network Camera

SEARCH VIEWER	62	Search Viewer
----------------------	-----------	---------------

SETUP VIEWER	65	Setup Viewer
---------------------	-----------	--------------

BACKUP VIEWER	74	SEC Backup Viewer
----------------------	-----------	-------------------

APPENDIX	75	Product Specification
	78	Product Overview
	80	Default Setting
	82	Troubleshooting
	84	Open Source License Report on the Product









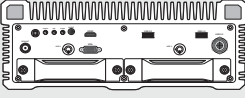
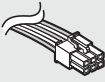
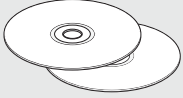

FEATURES

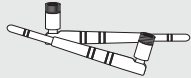
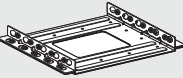
The product records video and audio from network cameras to a hard disk, and enables playback from the hard disk. It also provides remote monitoring environment for video and audio over the network using a remote computer.

- User-friendly UI
- Supports a range of 4K camera resolutions (3840X2160, 4096X2160, 4000X3000)
- Outputs a 4K high definition image using HDMI
- Record and play video
- Record and play audio
- Supports ONVIF Profile S standard and RTP / RTSP protocols
- Display the HDD operation status by HDD SMART
- HDD overwrite enabled
- Backup using USB 2.0, 3.0 protocols and external HDD
- Simultaneous play of 16 channels
- Various Search Modes (Time, Event, Smart Search)
- Various Recording Modes (Normal, Event, Scheduled Recording, Emergency recording)
- Alarm Input / Output
- Remote Monitoring function by Windows Network Viewer
- Live monitoring of the network camera
- Installation Wizard Function (Easy Setup, Quick Setup)

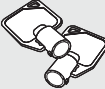
Package Contents

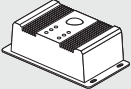
Please unwrap the product, and place the product on a flat place or in the place to be installed. Please check the following contents are included in addition to the main unit.

		
NVR	Power cable	Network Viewer Software / User Manual CD
		
User Manual or Quick Manual	Wi-Fi antenna	Mounting bracket
		
Screw for bracket assembly	Mounting screws	HDD fixing screws
		
HDD lock key	M12 to USB cable	GPS antenna
		
Control box	Control box connection cable	Alarm cable

PART NAMES AND FUNCTIONS (FRONT)

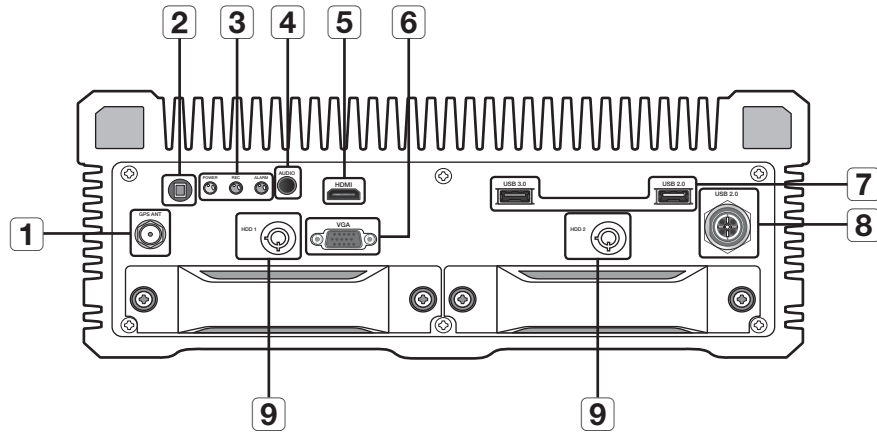

Part Names	Functions
1 GPS ANT	Connects the GPS antenna.
2 Power Switch	As the switch is a push type, it is turned off when it is pushed. While it is on, if it is pressed and held for 5 seconds, the system will stabilize and then turn off automatically. (Maximum 60 seconds) <ul style="list-style-type: none"> If the ACC yellow line on the power cable is not connected to the power or to the car's ACC terminal, the power will not turn on.
3 LED lamp	POWER : Shows the power On/Off status. REC : Turned on when recording is in progress. ALARM : Turned on when an event occurs.
4 AUDIO	Voice signal output terminal (earphone jack).
5 HDMI	HDMI video output terminal.
6 VGA	VGA video output terminal.
7 USB	Used to connect a USB type device. (USB 2.0, USB 3.0)
8 USB 2.0	This is an M12 type, and is connected with a USB device.
9 HDD door lock key	This is a lock device to restrict access to the hard disk. Use the key that was provided with the product.

PART NAMES AND FUNCTIONS (REAR)

TRM-1610S

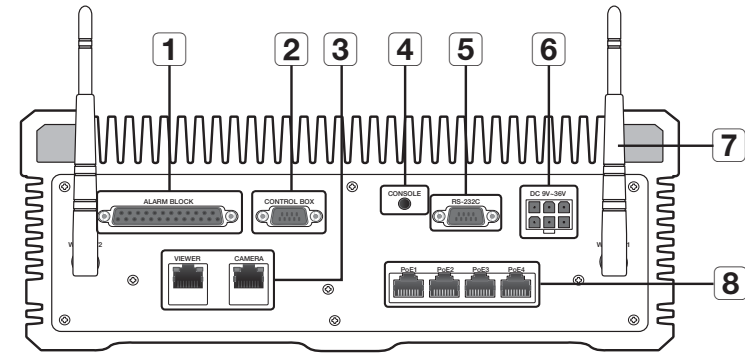

TRM-1610M

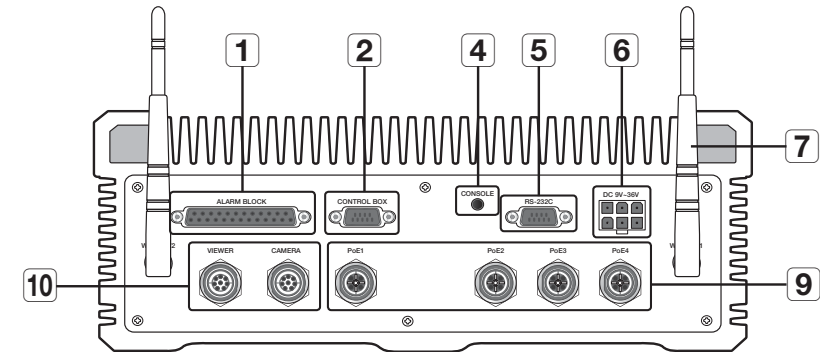

Part Names	Functions
1 ALARM BLOCK	Alarm input/output terminal. <ul style="list-style-type: none"> The Alarm Block consists of six inputs and six outputs, and is connected externally via the supplied alarm cable. Each output consists of an open collector circuit.
2 CONTROL BOX	Terminal to connect control box.
3 NETWORK	VIEWER : Port recommended for connection with a network, web viewer. CAMERA : Port recommended for camera connection, which receives an image from the camera.
4 CONSOLE	Console is designed for the service repair purpose only.
5 RS-232C	Cable terminal for serial communication.
6 DC 9V~36V	Terminal to connect power. Use the power cable that was provided with the product.
7 Wi-Fi Antenna	Antenna for Wi-Fi use. Connect and use the antenna that was provided with the product.

Part Names	Functions
8 PoE	Power supply port to connect camera. <ul style="list-style-type: none"> The maximum power supply of PoE1 - PoE4 is 32W. Please connect/install the camera in a manner that ensures that 32W is not exceeded. When 32W is exceeded, the power of the last connected PoE is turned off. If the power consumption of cameras connected to the set (eg., PoE1 - PoE4) is less than 24W, PoE cameras can be connected to the powered-off port.
9 M12 PoE	This is an M12 type port, and is a power supply port for connection to a camera.
10 M12 Network	This is an M12 type port, and is a terminal to connect to the network.
	CAMERA : Port recommended for camera connection, which receives an image from the camera. VIEWER : Port recommended for connection with a network, web viewer.

HOW TO CHECK M12 TERMINAL PINS

Gigabit Ethernet (M12 8pin A-Code Pinout)

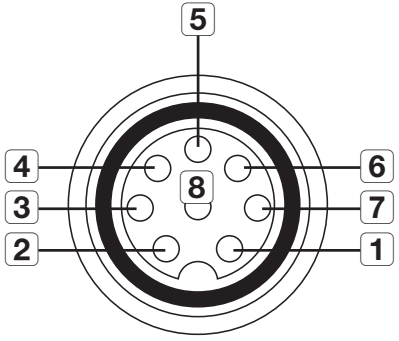
	1	pin - 1	Orange - White	TX_D1+	RJ-45 pin 1
	2	pin - 2	Orange	TX_D1-	RJ-45 pin 2
	3	pin - 3	Green - White	RX_D2+	RJ-45 pin 3
	4	pin - 4	Green	RX_D2-	RJ-45 pin 6
	5	pin - 5	Brown - White	BI_D4+	RJ-45 pin 7
	6	pin - 6	Brown	BI_D4-	RJ-45 pin 8
	7	pin - 7	Blue - White	BI_D3-	RJ-45 pin 5
	8	pin - 8	Blue	BI_D3+	RJ-45 pin 4

PoE (M12 4pin D-Code Pinout)

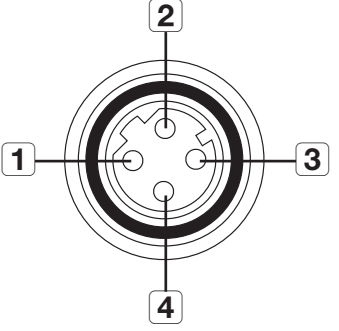
	1	pin - 1	Orange - White	TX_D+	RJ-45 pin 1
	2	pin - 2	Green - White	RX_D+	RJ-45 pin 3
	3	pin - 3	Orange	TX_D-	RJ-45 pin 2
	4	pin - 4	Green	RX_D-	RJ-45 pin 6

DC POWER CONNECTOR WIRING DIAGRAM

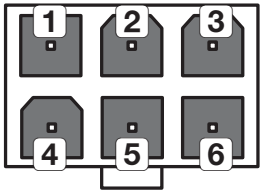
	1	GND	Ground signal of the set.
	2		
	3		
	4	PWR (DC_IN)	It receives DC 9 - 36V input as the power signal of the set.
	5		
	6	ACC	This is a terminal to connect to the car's ACC power. When the ACC power is on, the set operates.

! If the ACC yellow line on the power cable is not connected to the power or the car's ACC terminal, the power will not turn on.

ALARM INPUT/OUTPUT WIRING DIAGRAM

ALARM BLOCK

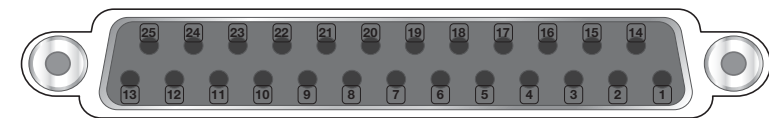

1	Alarm In 1	8	Alarm In 8	15	Alarm In 14	22	Alarm Out 4
2	Alarm In 2	9	Alarm In 9	16	Alarm In 15	23	Alarm Out 5
3	Alarm In 3	10	Alarm In 10	17	Alarm In 16	24	Alarm Out 6
4	Alarm In 4	11	Alarm In 11	18	GND	25	GND
5	Alarm In 5	12	Alarm In 12	19	Alarm Out 1		
6	Alarm In 6	13	Alarm In 13	20	Alarm Out 2		
7	Alarm In 7	14	GND	21	Alarm Out 3		

CONTROL BOX NAME AND FUNCTION

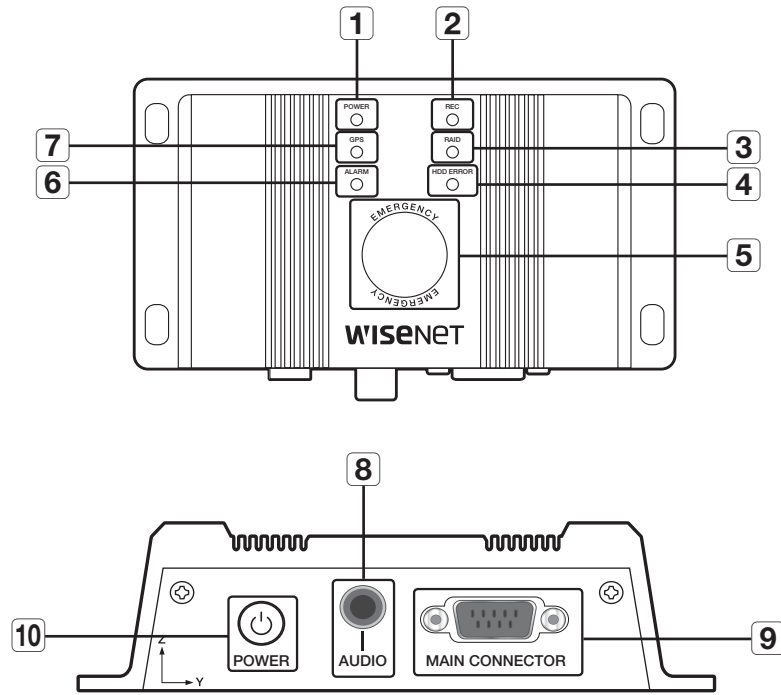

Part Names	Functions
6 ALARM	Shows the alarm status.
7 GPS	Shows GPS reception status. <ul style="list-style-type: none"> The LED is off before GPS reception is active. If the GPS reception is good, the LED illuminates. If the GPS reception is poor, the LED blinks.
8 AUDIO	Outputs audio to the RCA jack.
9 MAIN CONNECTOR	Connected to the main unit via the control box connecting cable.
10 POWER	As the switch is a push type, it is turned off when it is pushed. While it is on, if it is pressed and held for 5 seconds, the system will stabilize and then turn off automatically.

Part Names	Functions
1 POWER	Shows the power status. <ul style="list-style-type: none"> In a delayed boot state, the LED blinks until the system starts up.
2 REC	Shows the REC status. <ul style="list-style-type: none"> LED blinks during emergency recording.
3 RAID	Shows the RAID status. <ul style="list-style-type: none"> When the RAID is OK, the LED is on. The LED blinks when RAID is in a Degraded or Rebuilding state. The LED is off when RAID is unused or in RAID Fail.
4 HDD ERROR	Shows HDD error. <ul style="list-style-type: none"> When HDD is checked, replaced, or there is RAID Fail, the LED illuminates.
5 EMERGENCY	Performs emergency recording. <ul style="list-style-type: none"> The REC LED blinks when recording is in progress. You can set an alarm occurrence to indicate that emergency recording is on/off. For emergency recording buzzer setting, refer to "Settings". (page 28)

installation

Please take note of the followings before using this product.

- Do not use the product outdoor.
- Do not spill water or liquid in the connection part of the product.
- Do not impose the system to excessive shock or force.
- Do not pull out the power plug forcefully.
- Do not disassemble the product on your own.
- Do not exceed the rated input/output range.
- Use a certified power cord only.
- For the product with an input ground, use a grounded power plug.
- Do not move the product using the HDD bracket handle on the front of the product as it may cause damage to the HDD.

CHECKING THE INSTALLATION ENVIRONMENT

This product is a top-notch security device that is equipped with a high-capacity HDD and other key circuit boards.

Note that an excessive internal temperature of the product may cause a system failure or a shortened product life (see the right figure). Keep in mind the following instructions before installing the product.

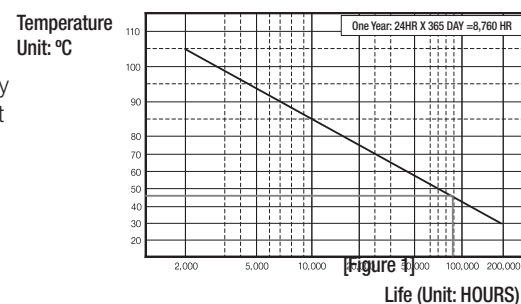

HOW TO INSTALL THE BRACKET

1. After removing the product from the box, disconnect the bottom bracket by removing the bracket assembly screws (10 pieces), as shown in the figure.
2. Place the floor bracket on a flat surface and fasten it with the mounting screws (12 pieces) included in the product, as shown in the figure.
3. Reassemble the main unit and floor bracket.
 - This is a shock absorber to protect the HDD from vehicle vibration.

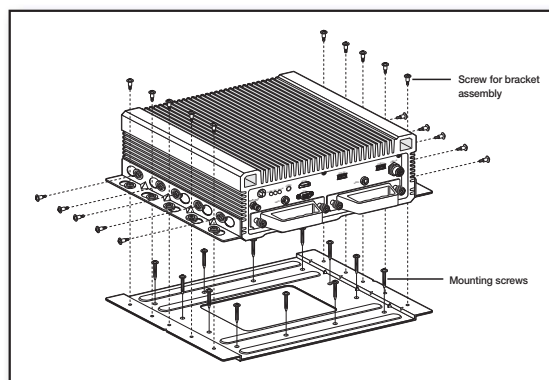

HOW TO INSTALL THE CONTROL BOX

Assemble mounting screws and install the camera on a wall/floor/ceiling as shown in the figure.

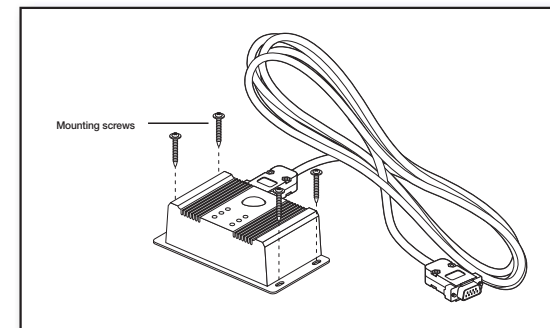

HOW TO CONNECT THE CONTROL BOX

Connect to the main unit via the control box connection cable.

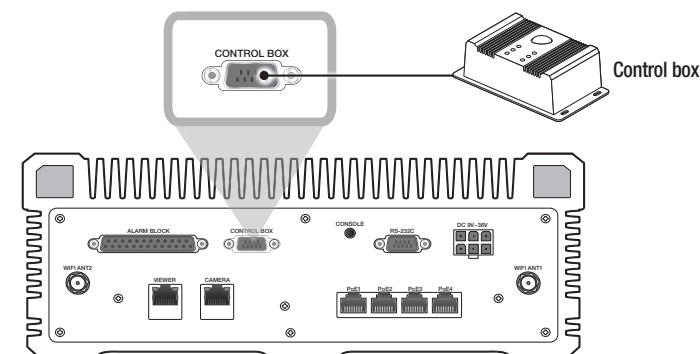

HDD ADDITION

Make sure to unplug the power cord from the wall outlet to prevent possible electric shock, injury or product damage. Please consult your provider for further information on HDD installation since improper installation or settings may damage the product.

- Number of HDDs supported : Up to 2 HDDs supported
- Make sure to unplug the power cord from the wall outlet before proceeding with the installation.



▪ Cautions for data loss (HDD care)

Please pay attention so that the data inside the HDD is not damaged. Before adding a HDD, please check the compatibility with this product. HDD is vulnerable to malfunction due to its sensitive nature especially against shock when operating. Please ensure that the HDD is free from such shock. We are not liable for any damage to the HDD incurred by user's carelessness or miss use.

▪ Cases might cause damage to HDD or recorded data

To minimize the risk of data loss from a damaged HDD, please backup data as often as possible. If exposed to shock when disassembling or installing, data stored in the hard disk may be damaged. A sudden power failure or turning off the product while in HDD operation may damage the hard disk drive. HDD or files stored inside may be damaged if the main body is moved or impacted during the HDD operation.

Cautions when installing a HDD

1. Do not apply excessive force to the HDD.
2. Pay attention so as not to lose the disassembly screws or accessories.
 - If the screws or accessories are not put together correctly, the product may breakdown or not operate properly.
3. Please check the HDD compatibility before adding a HDD.
 - Please contact your nearest dealer to obtain the list of compatible devices.

Installing the HDD

- !** If you are adding a new or previously used HDD to this product in addition to the HDD(s) originally installed, format the new HDD manually in the set before use.
For information on how to format an HDD, refer to "Device/Format". (page 36)

1. Unscrew the HDD bracket fixing screws on the front of the set and pull it to the front to separate the HDD.
 - If the lock on the front is locked, open the lock using the key that was provided when you purchased the product.

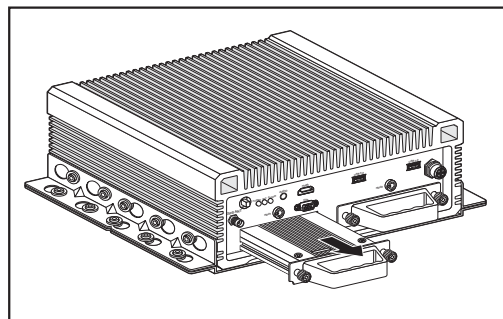
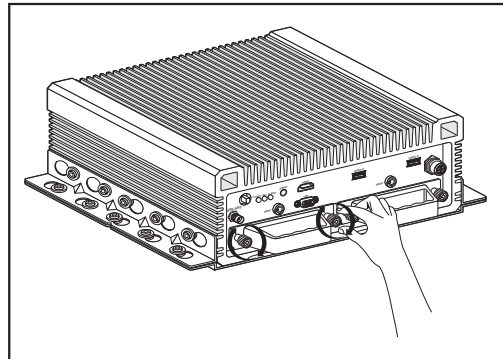
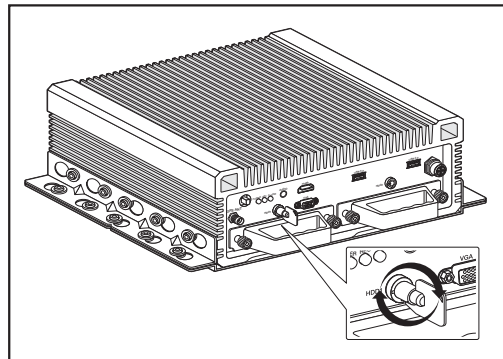

2. Loosen the screws on the front/rear of the bracket and separate the bracket.
3. After replacing/installing the HDD, fix the HDD and bracket with screws.

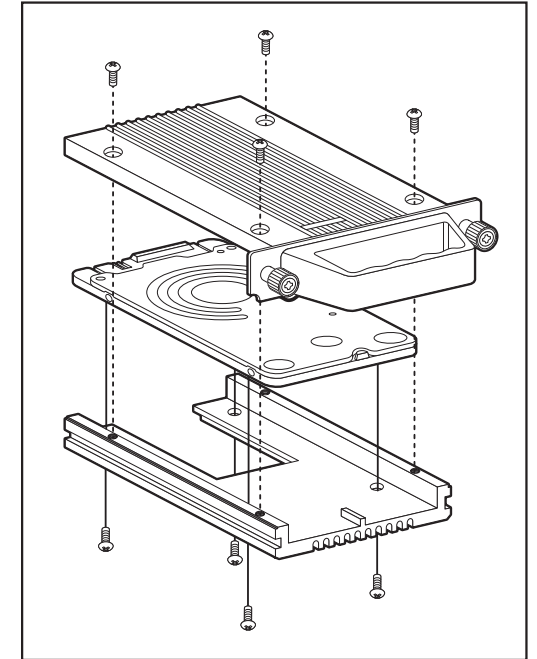

4. Slide the bracket with the HDD into the main body, and tighten the screws to fix it.

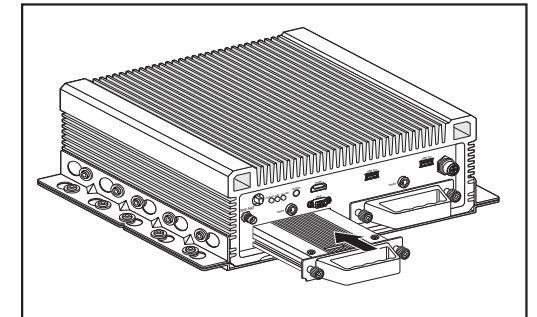

connecting with other device

CONNECTING TO AN EXTERNAL DEVICE

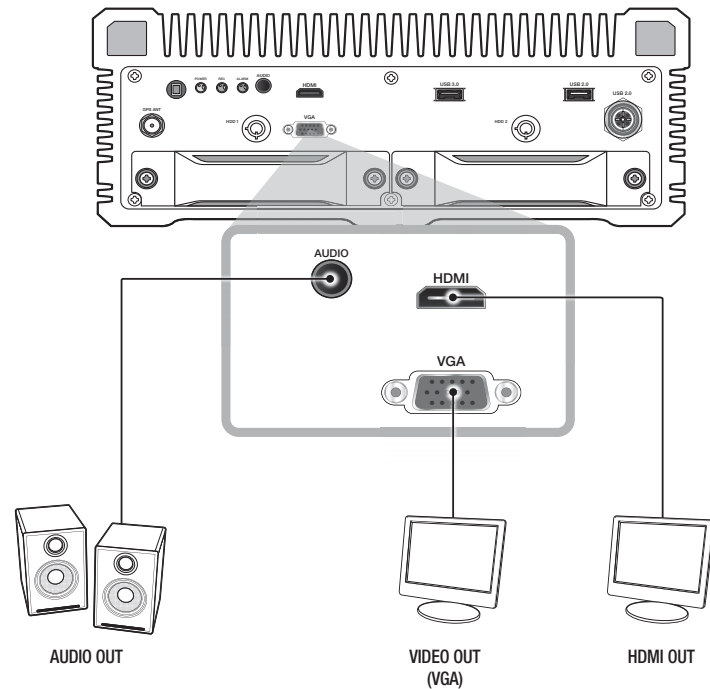

- ! Unrated or improper power source may cause damage to the system. Ensure that you use only the rated power source before pressing the POWER button.

CONNECTING THE USB

1. On the front of the product, there is a USB port.
2. You can connect a USB HDD, USB memory or mouse to the USB port.
3. If a USB HDD is connected to the system, recognition and settings are available in "Menu > Device > Storage Device". (Page 36)
4. The product supports hot plugging function that enables connecting/disconnecting USB devices while in operating the system.

- ! If you use the USB device for Backup purposes, format it with FAT32 on PC if it is not formatted on the NVR.
- Some USB devices may fail to function properly due to compatibility issue, please check the device before using.
- Only USB storage devices that comply with the standards (having a metal cover) are guaranteed for data transfer.
- In case if the USB device's electric contacts have been worn out, data transfer between the devices may not properly function.

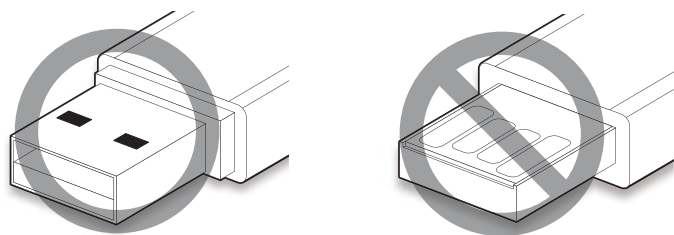

CONNECTING THE ALARM INPUT/OUTPUT

The Alarm In/Out port at the back is composed of the following.

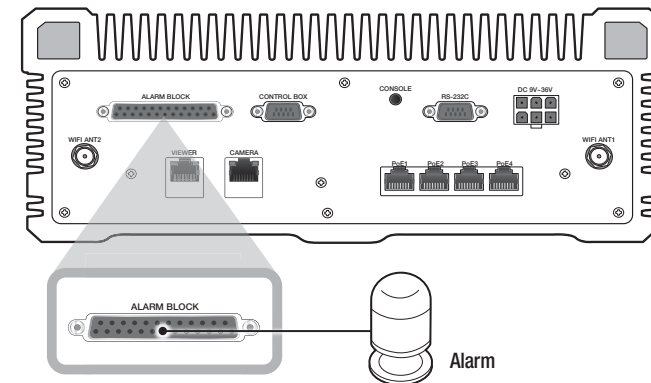

- ALARM IN 1 ~ 16 : Alarm Input Port
- ALARM OUT 1 ~ 6 : Alarm Output Port

CONNECTING THE NETWORK

- ✍ For more information about network connection, refer to "Network Configuration". (Page 43)

Network connection via Ethernet (10/100/1000BaseT)

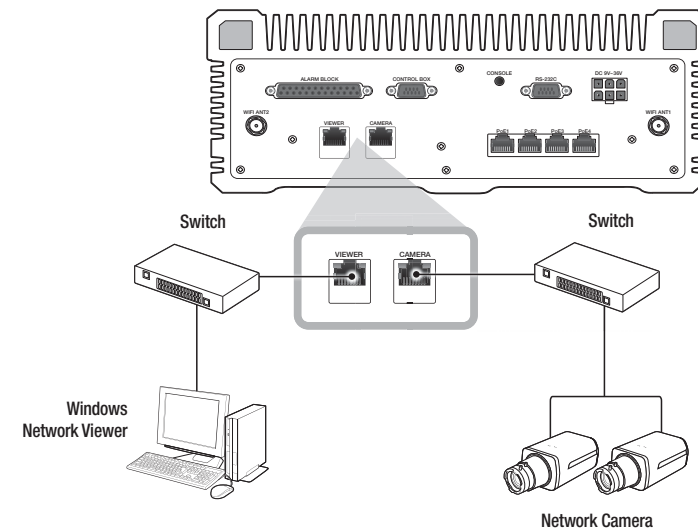

Network connection via router

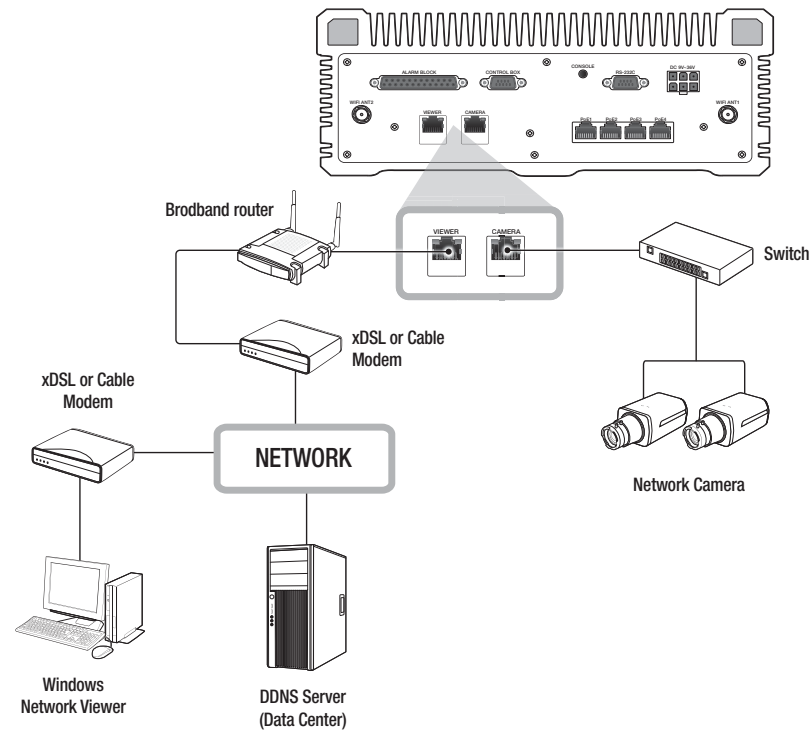

How to back up via Wi-Fi

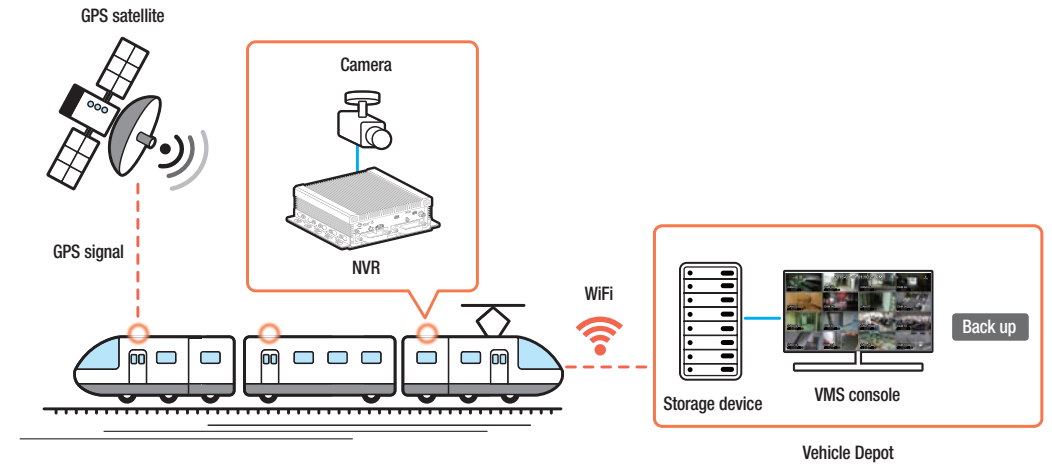

Connecting to Internet through PPPoE

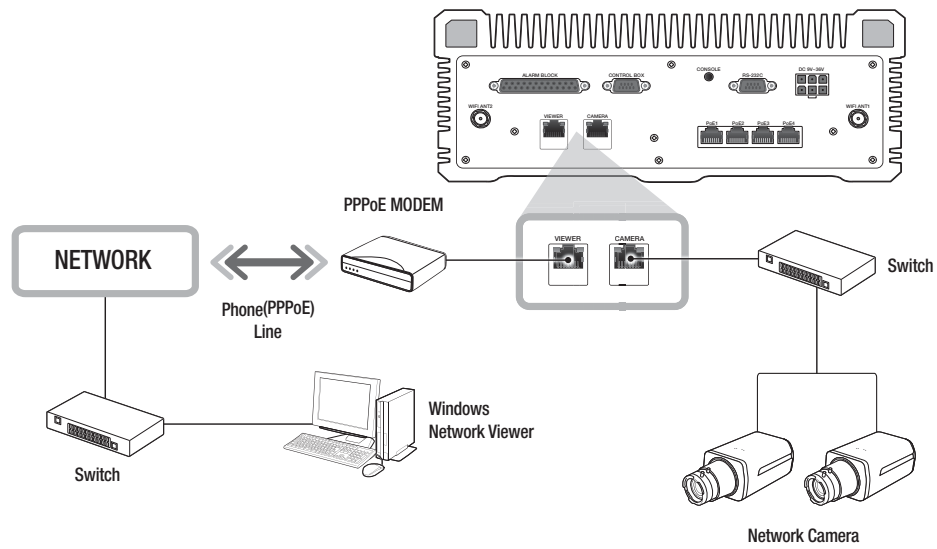

GETTING STARTED

Starting the system

1. Connect the power cable of the NVR to the wall outlet.
2. You will see the initialization screen.
The initialization process will last about 2 minute.
If a new HDD is installed, the initialization process may take longer.
3. The live screen appears with a beep.



Install Wizard

As shown below, proceed through each step of the <Install Wizard>.

1. In the <Language> screen, select the language and press the <Next> button.
2. In the <ID/PW> screen, set the password and press <Next>.

• Setting Camera Password

You can change the password of the camera en bloc if the camera password is in a factory reset state.
If the camera password is not in a factory reset state, please enter the password of the current camera to register the camera.

- New Password : Input a new password according to the password setting rules.
- Confirm Password : Input the new password again.

A camera password registered with ONVIF and RTSP cannot be changed.

• Password setting guide

When you click < >, a basic guide for setting a password is displayed.
Check the password setting rules.

3. In the <Network> screen, set the network access method and the access environment. To use a simple intranet, click <Next>.
 - DHCP server : If the DHCP server is set to enable, an IP is automatically assigned to the camera.
For more information, please refer to "**DHCP Server**" in the menu settings. (Page 49)
 - Network 1 (Camera) : Connects to the camera and receives the video feed from the camera
 - Network 2 (Viewer) : This is a port for transmitting an image to the webviewer.
 - Network 3 (Wi-Fi) : Port for connecting to external Wi-Fi.
The Wi-Fi port is used for backup.
 - Network 1 (Camera) / Network 2 (Viewer) Setup
 - IP Type : Choose the network connection method.
 - IP Address, Subnet Mask, Gateway, DNS
 - Network 3 (Wi-Fi) can be set after the installation wizard is closed.

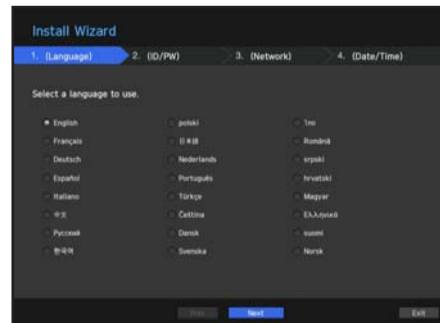

- If the LAN cable is not connected to the port, the setting button will not be activated for use. Check the LAN cable connection.
- The built-in DHCP Server in NVR will turn on automatically at stage 3. At this stage, using the existing DHCP server in the same network may cause a problem, as two DHCP servers would be simultaneously operating.
- For more details on network settings, refer to the user manual.

4. After setting the date/time settings in the <Date/Time> screen, click on the <Finish> button to launch the setting completion window.
5. In the setting completion window, click on the <OK> button to finish camera setting and launch the camera registration screen.

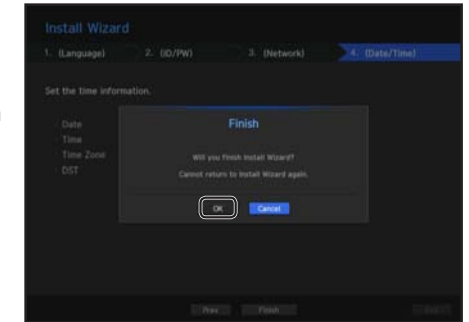

6. Cameras connected to the PoE port are automatically registered and displayed in the camera registration list. Select the cameras to be registered from the list of cameras, and click the <Register> button.

- The camera may not be shown in the list if there is no response from the camera. You can re-import the list by pressing the < > button.

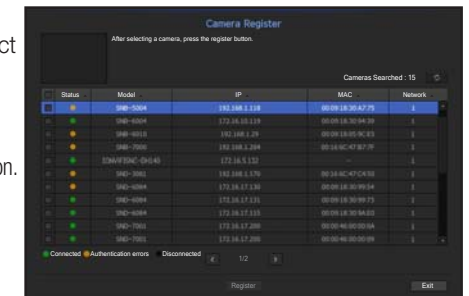

7. When camera registration is finished, the frame rate of the set recording profile is displayed. After you click the <Manual Setting> button, you can modify the frame rate value.

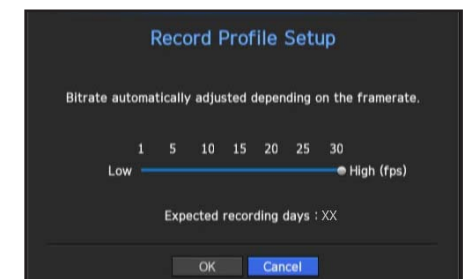

Shutting Down the System

1. In the live screen menu, select <Shutdown>.
2. The "Shutdown" confirmation pop-up window will appear.
3. Click on <OK>.
The system will shut down.



- Only the user with the "shutdown" permission can shut down the system.
- For the permission management, refer to "User > Setting Permissions". (Page 27)

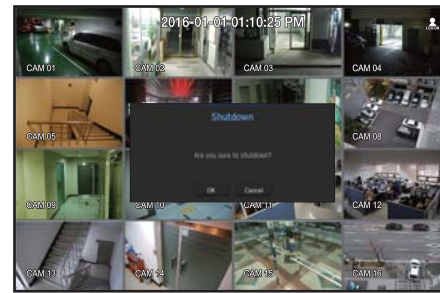

Login

To use the NVR menu, you are required to login as a user that is authorized to access the applicable menu.

1. Right click with your mouse button on the live mode screen.
You will see the context menu on the screen as shown.
2. Select <Login>.
The login dialog appears.



- The initial administrator ID is set to "admin" and you will need to configure the password in the installation wizard.
- Please change your password every three months to safely protect personal information and to prevent the damage of the information theft.
Please, take note that it's a user's responsibility for the security and any other problems caused by mismanaging a password.

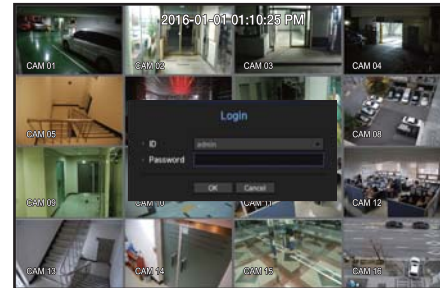

- For the restricted permission, refer to "User > Setting Permissions". (Page 27)

LIVE SCREEN CONFIGURATION

Icons on the Live Screen

You can check the status or operation of the NVR with the icons on the live screen.

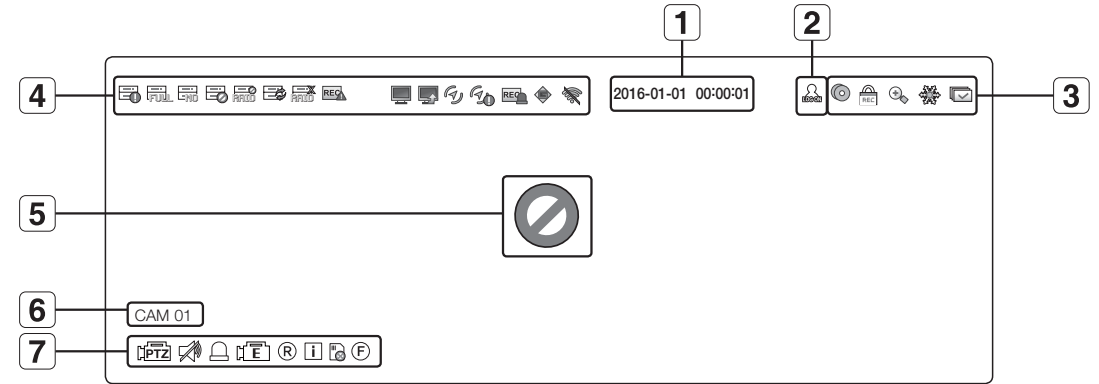

Name		Description
1	Current Date, Time	Displays the current time and date.
2	Login Information	When you are logged in, the "LOG ON" icon will be displayed.
3	Screen Mode	It is displayed when there is ongoing backup in the live condition.
		If access to the recording canceling menu is restricted, then it is only displayed when there is ongoing manual recording. <ul style="list-style-type: none"> Only a user with the right to cancel recording can do so.
		It is displayed when the magnifying function is in operation.
		This icon is displayed when you press the Freeze button.
		It is displayed when all the channels are switched at the set time interval.
4	System Operation	It is displayed when the recording data cannot be received properly due to a device problem.
		Displayed if the HDD is full and the NVR has an insufficient space to record.
		Displayed if no HDD is installed or the existing HDD should be replaced.
		Displayed if the HDD needs a technical examination.
		It is displayed when there is a malfunctioning HDD in the RAID. <ul style="list-style-type: none"> There are one or two HDD malfunctions but you can still read or write to it.
		It is displayed when recovering a RAID Error.

Name		Description	
4	System Operation		It is displayed when you cannot write RAID due to a malfunction of HDD.
			It is displayed when the max permitted amount of data for each channel is exceeded.
			It is displayed when the network is overloaded. <ul style="list-style-type: none"> It occurs when the max receiving allowance is exceeded, causing an overload to the CPU. It will disappear if you modify the camera settings or delete a camera to reduce the performance burden.
			It is displayed when there is firmware to update the server.
			Shows GPS reception/no reception.
			Appears when emergency recording is in progress.
			Shows the vehicle shake state.
			Displays the Wi-Fi connection status when <Wi-Fi Enable> is set.
5	Video Input Status		Displayed if no input is entered in the condition that the camera is set to <ON>.
			Displayed when the live image with the camera turned <ON> exceeds the supported resolution.
		WISENET	Displayed if no permission to live view is granted.
			If a camera is <OFF>, or if no camera is registered, or it is in <Covert2> mode, nothing will be displayed on the screen. If the camera is set to <Covert1>, the video will be displayed but the OSD menus will not be displayed.
6	Camera Title / Channel	Display the camera title and channel number.	
7	Camera Operation		This icon is displayed for a channel that a PTZ-featuring camera is connected to.
			Displays AUDIO ON/MUTE. Not displayed in video mode if deactivated.
			If the sensor is set to <ON>, the input signal will be displayed on the screen of the connected channel.
			This icon is displayed when Motion Detection is set to <ON> and a camera motion or camera event occurs.
			It displays the status of general/event/scheduled recording.
			It is displayed when it fails to decode all the frames due to limited decoding performance and in this case only the I-Frame is decoded.
			RED - Displayed when there is any abnormality in the RED-SD card. YELLOW - Displayed when there is no storage space in the SD card.
			Flickers when a defocus event occurs. When you click the icon, a simple focus command is sent to the camera.

Error Information

- If the built-in HDD is not connected, the "NO HDD" icon () will be displayed in the top left corner. In this case, the recording, playback and backup functions do not work. If a new HDD is installed, format the HDD using the "Device > Storage Device" menu.
- If you see the icon for NO HDD () or HDD FAIL () after HDD formatting, be sure to contact your service center.

Live Screen Menu

If you right click with your mouse button in live screen mode, it will launch the live screen menu where you can access each menu.

The context menu differs depending on the state of Log in/out, split mode, and NVR operation status.

- Depending on the user permissions, you may have limited access to menu items of Live View, Backup, Stop Recording, Search, PTZ, Remote Alarm Output, and Exit.

Single Mode Menu

The single mode menu is available only in Single Mode.

If the menu is displayed as <Screen Mode> in the single screen, it is displayed as a <Full Screen> in the menu where only one channel is selected in the split screen.

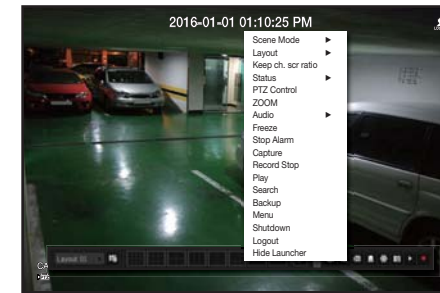

< Single Mode Menu >

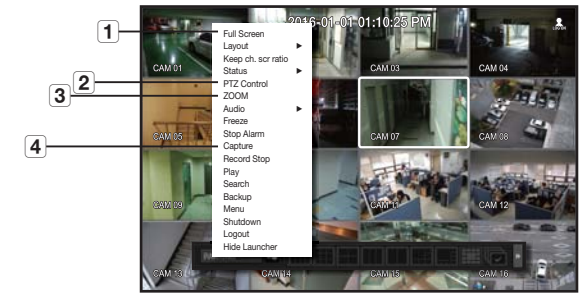

< One channel selection menu in the split screen >

Menu	Description
1 Full Screen	Select and click a desired channel in Split mode to switch to the full screen of the selected channel.
2 PTZ Control	Accesses the PTZ Control menu. The PTZ menu will be active on the Live screen after you select a single channel. (Page 23)
3 ZOOM	You can enlarge the selected screen. (Page 21)
4 Capture	Captures the screen of the selected channel. (Page 22)

Split Mode Menu

In Live split mode, right-click to display this context menu as shown.
The context sensitive menu in split mode differs, depending on the login/logout status.

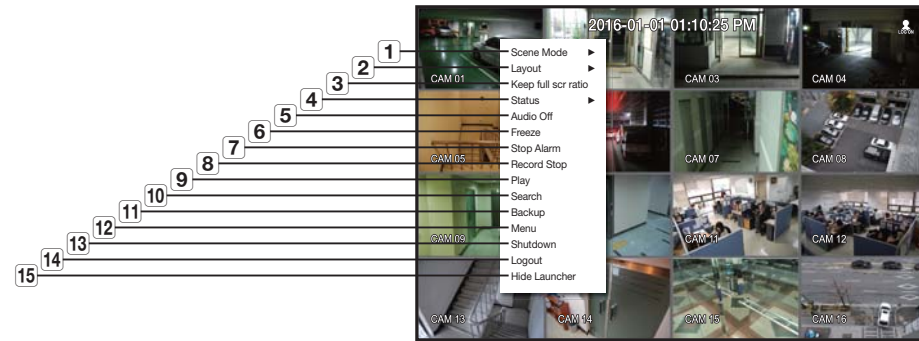

Menu	Description
1 Screen Mode	Select a screen mode for the Live screen. Refer to " Live screen mode ". (Page 18)
2 Layout	Set the layout of each channel. Refer to " Layout ". (Page 21)
3 Keep full scr ratio/ Keep ch. scr ratio	Channel screen ratio is changed. Refer to " Maintain the Screen Ratio ". (Page 23)
4 Status	Shows the connection information of camera connected to each channel as well as live and recording status. Refer to " Status ". (Page 19)
5 Audio On/Off	Turns ON/MUTE the sound of the selected channel. Refer to " Audio ON/OFF ". (Page 22)
6 Freeze	Stop playing the video temporarily. Refer to " Freeze ". (Page 22)
7 Stop Alarm	Stop the alarm output, deactivate the event icon and release the auto sequencing. Refer to " Event Monitoring ". (Page 22)
8 Record/Stop	Starts/stops the standard recording.
9 Play	Refer to " Search & Play > Play ". (Page 52)
10 Search	Refer to " Search & Play > Search ". (Page 51)

Menu	Description
11 Backup	Searches for a backup device and runs backup for each channel or schedule backup later at a more preferable time. (Page 24)
12 Menu	Enter the main menu. Refer to the menu settings. (Page 25)
13 Shutdown	The system shutdown dialog will appear.
14 Login/Logout	You can log in or out.
15 Show/Hide Launcher	Shows or hides the launcher. Refer to " View the Launcher Menu ". (Page 18)

View the Launcher Menu

The Launcher menu appears on the bottom of the live screen.

1. Select <Show Launcher> in the context menu of the Live screen.
2. Move the cursor to the bottom and click a desired item in the Launcher menu.

- If no input is entered for 10 seconds, the menu will disappear.
- The Launcher menu can be accessed only by using the mouse.



Menu	Description
1 Layout	Select the layout to be displayed on the screen.
2 Layout Setup	You can set, change or delete the new layout of each channel.
3 Screen Mode	Displays a list of split modes available in a bar type. The current screen mode will be displayed grey.
4 Menu Expansion Button	Click to display the hidden menu to the right.
5 Backup	Searches for a backup device and runs backup of each channel or schedule it for later at a more desirable time.
6 Zoom	Enlarges the selected area. This is available only in Single Live mode.
7 PTZ	If the network camera connected to the selected channel supports the PTZ operations, this will run the PTZ control launcher. This is active only in Live single mode.
8 Alarm	Stops the alarm if it's activated.
9 Freeze	Freezes the Live screen temporarily.
10 Capture	Captures the screen of the selected channel.
11 Play	Enters Play mode if a file to play exist, and if not, enters Search mode.
12 Record	Start/End recording the Live screen.

LIVE SCREEN MODE

You can play up to 16 live video channels in single, 8-split, or auto sequence mode.

- When you register a camera, the Live4NVR profile is created to set H.264 800*600 30fps as default. If necessary, you can change it in **Menu > Device > Camera > Camera Settings**. If the performance is exceeded, it may play I frame only. If you cannot create an additional profile for the camera specifications, then sometimes you cannot create Live4NVR. In this case, you need to modify the camera profile. Refer to "Camera Setting". (Page 33)

Method for displaying screen mode

If you want to change the split mode, select a screen mode suggested in the launcher menu or right click with the mouse button and select a split mode in the screen mode menu.

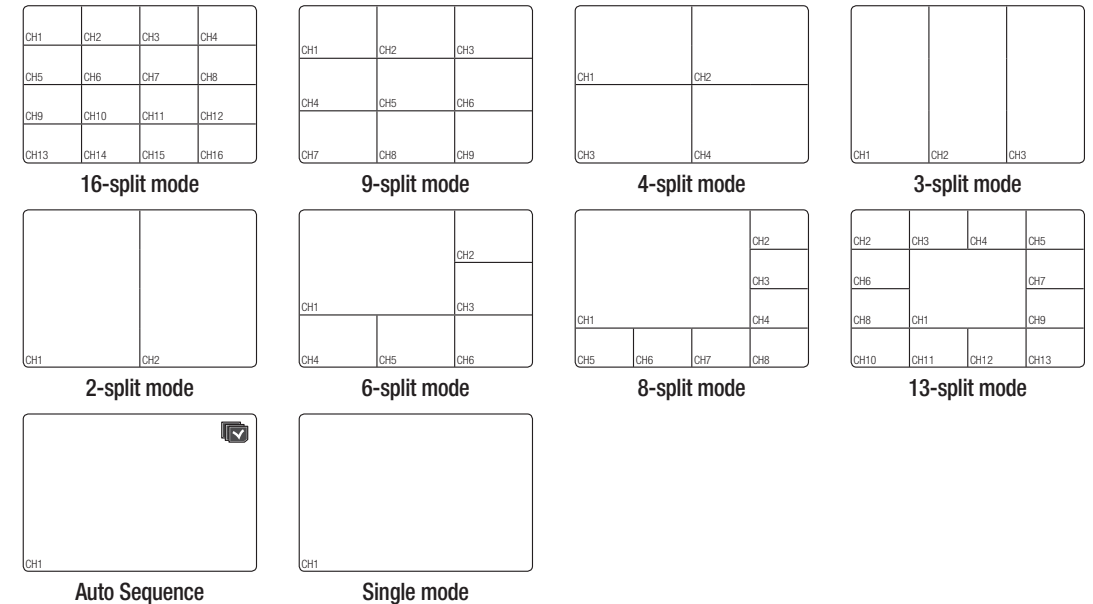

Switching the split mode

You can also play 16 Live channels in the sequence of: Single, 4-split, 9-split and 16-split mode.

Press the button in the launcher or use the right menu to automatically switch the screen.

Mouse right button menu → Screen mode → Auto switching mode

If you reach the end of the steps as outlined in the previous page, you will be moved to the first page and no automatic switching will be performed.

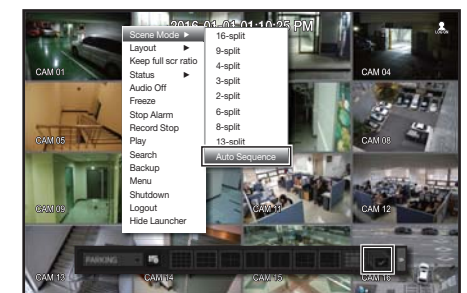

Auto Sequence

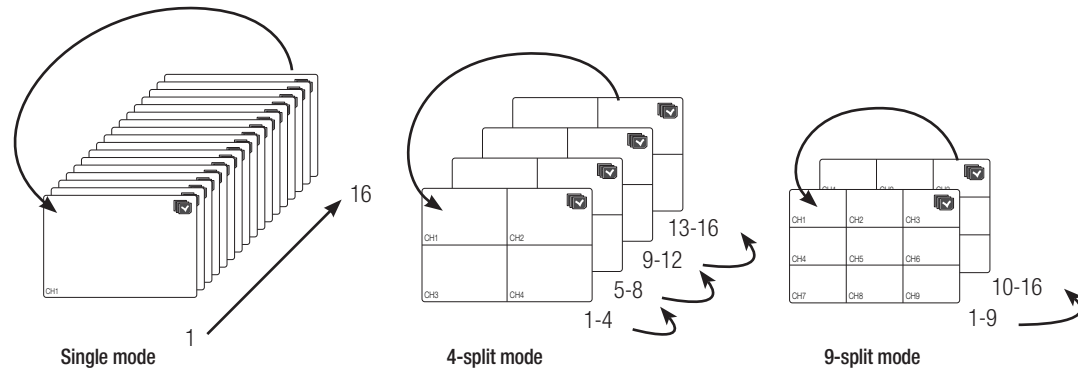

- In a split mode, If you have set <Sequence switching time> in "Setting the Device > Monitor", Auto Sequence will be conducted at the set interval. (Page 39)
- When you switch the channel, the video may be delayed depending on the network condition.

Manual Switching

Click the arrow <◀/▶> key to move to the next split mode.

- If pressing the right [▶] button in 9-split mode :
Channel (CH 1~9) → Channel (CH 10~16) → Auto Sequence

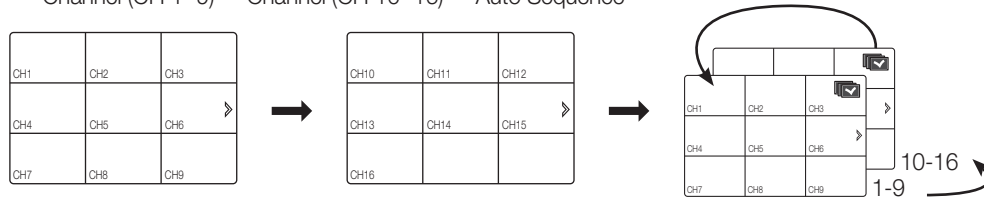

- If pressing the right [▶] button in 4-split mode :
Channel (CH 1~4) → Channel (CH 5~8) → Channel (CH 9~12) → Channel (CH 13~16) → Auto Sequence

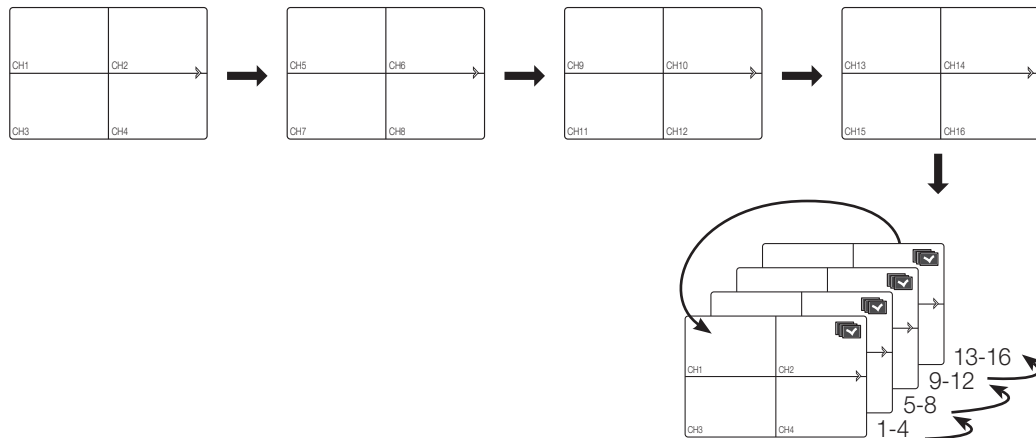

Status

You can check the connection information of the camera to be connected to each channel on the live screen.

Connection

If you select <Connection> in the <Status> menu on the live screen, you can check the connection state of the camera connected to each channel.

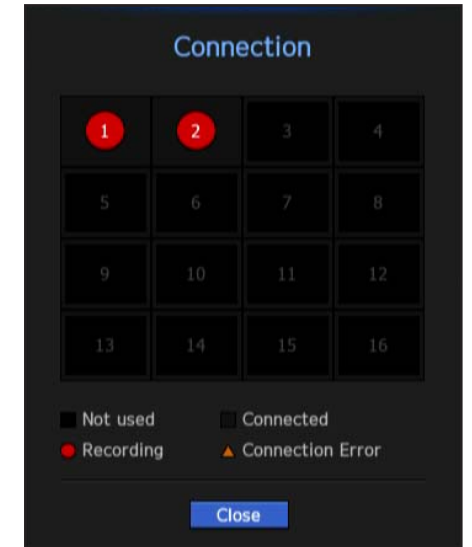

Live Status

If you select <Live> in the <Status> menu on the live screen, you can check the transmission information and state of the camera connected to each channel.

- Model :** Displays the camera model name connected to each channel.
- Status :** Displays the status of camera connection set to each channel.
- IP Address :** Displays the IP address of a camera set to each channel.
- Codec :** Displays the live profile codec information for a camera set to each channel.
- Resolution :** Displays the live profile resolution of a camera set to each channel.
- Frame Rate :** Displays the number of live profile frames of the camera set for each channel.

CH	Model	Status	IP Address	Codec	Resolution	Frame Rate
1	M8-8000	Connected	192.168.0.30	H.264	800x600	25fps
2	M8-5321	Connected	192.168.0.40	H.264	800x600	30fps
3	-	-	-	-	-	-
4	-	-	-	-	-	-
5	-	-	-	-	-	-
6	-	-	-	-	-	-
7	-	-	-	-	-	-
8	-	-	-	-	-	-

Record Status

If you select <Record> under the <Status> menu on the live screen, you can check a channel's video type, recording type, number of input/recording frames, allowed/input/recording data volume.

- Total Bitrate (Record/Max) : Record bitrate shows the amount of actual data recording while Total bitrate shows the maximum data transfer allowed by the NVR.
- Profile : Shows the video profile configured to each channel.
- Frame (fps) : Show the input/record frames per second for each channel.
- Bitrate (bps)
 - Limit / Input / Record : Shows the amount of limit/input/recording data for each channel.
 - Input / Limit : Shows the data ratio of actual data transferred from the camera and allowed maximum defined by user.
- View all : You can view the recording status of all channels. Click the button to choose a group, and you can view the recording status of the selected group.
- Current : Shows the recording status information of currently transferred data.
- MAX : Shows recording information of the most biggest recording data out of configured standard and event recordings.
-  : Reloads the recording information.
- Record Setup : The menu screen will switch to the record setting screen.



- The warning message on the list's bottom means the NVR replaced the selected recording profile with other available profile, since the selected one does not produce video data which prohibits screen saving. If the screen displays video, it automatically resets to the selected profile and its name turns to yellow in the list.
 - If Key Frame recording exceeds the allowed data amount specified by limit bitrate, a popup alert and icon appear on the screen. The limited recording alert popup does not repeat after displaying once unless camera or recording settings are changed; it may appear again if settings were changed to notify such status. If you want to set the alert popup not to appear, change your setting of <Setup Warnings> not to display a message popup. For further information on bitrate limit of recording data, refer to "Record Setting". (Page 40)

PoE Status

When <PoE> is selected in the <Status> menu of the live screen, the PoE status in each port can be determined.

1. Select the <PoE Status>. PoE status view window is displayed.
- Consumption(W) : Displays the power consumption in PoE.
 - 0 : No device is connected to the port or a device is using its own power supply.
 - - : Trouble in the port (More detailed trouble information can be displayed in additional information.)

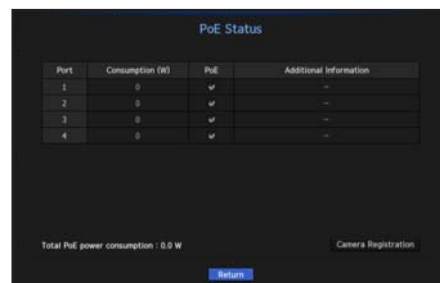

- The full PoE power rating is 32W. If the power for all ports exceeds the PoE specification, power to the ports is blocked in order.

- PoE : Turns on/off the power supply to the camera. If checked, it means the power supply is On; if not checked, it means it is Off.
- Additional information : If there is a problem in the power supply, it is explained here. Power supply problems include excessive power (class 1 to 4) and voltage errors.
- Total PoE power consumption : Display the sum of power consumption for all the ports.

2. Press <Return> to move to the previous screen.

Channel Setting

You can display the channel in a desired area of a split screen.

1. Place the cursor over the camera name of each channel to display the <▼> key to the right on the screen.
2. Click a camera name to display a channel list where you can select a different channel.
3. Select a desired channel and click it. The current channel will be switched to the selected one. Use the cursor to select a channel to move, and drag and drop it to a desired channel; this can also change the channel position.

- Ex : if switching CH 1 to CH 7

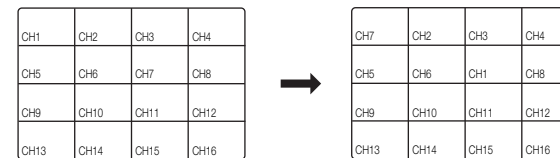

Switching to Single Mode

When in split mode, select and double-click a desired channel to switch to its Single mode.

- Ex : If double-clicking CH 3.

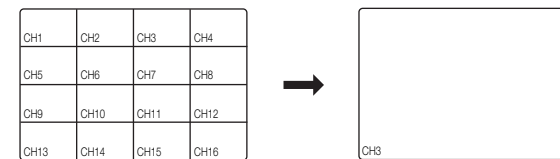

ZOOM

This is activated only in Live Single mode.

After selecting a single screen, if you use the Magnify function, the selected area will be magnified by 3.

1. In the live screen menu, select **<ZOOM>**.
You can also click on **<🔍>** in the launcher menu.
The Magnify icon in the middle of the screen will be displayed.
2. Drag and drop with your mouse to select the area to magnify.
3. Double click on it to magnify the selected area by 3.
 - In the magnified screen, you can drag and drop the selected area for magnification.
4. In the live screen menu, select **<Zoom Out>**.
Click on **<🔍>** in the launcher menu to release the magnification function.

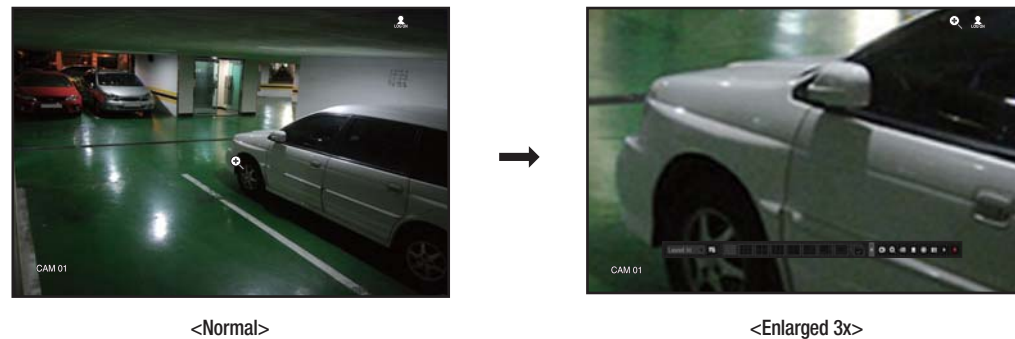

LAYOUT

In the live screen, you can set the layout for each channel.

Setting Up the Live Layout

This section outlines how to select a series of channels based on their purpose/accessibility and monitor them in a single layout.

Example) Layout "Lobby" - Lobby camera 1, Lobby camera 2, Front entrance camera 2

Layout "VIP" - Directors' meeting room 1, Directors' meeting room 2, Directors' lounge 1, Corridor camera on the 7th floor

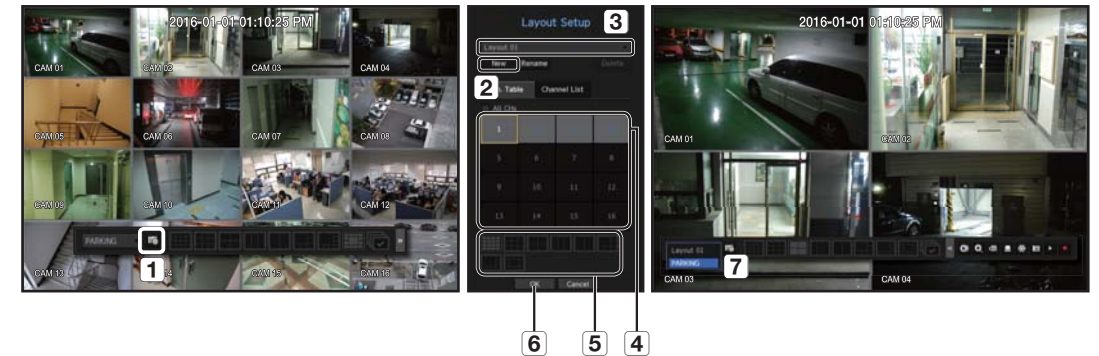

To create a new layout, follow these steps:

1. Open the channel layout setup menu.
2. Click **<New>**.
3. Enter a name for the selected channels (e.g., PARKING).
4. Select the channels that you want to add to the layout (e.g., 1, 2, 3, 4).
5. Choose a split mode to apply (e.g., 4-way split).
6. Click **<OK>**.
7. Choose a layout to view it on the screen (e.g., change to PARKING).

1. Select the **<🔍>**.

The layout setting screen will appear.

- New : You can set the new layout.
 - Rename : You can make changes to the selected layout.
When the layout is changed, the channel order is initialized.
 - Delete : You can delete the selected layout.
 - Channel Table : You can select channels in the table to be registered in, or removed from the layout.
 - Channel List : You can select channels in the list to be registered in, or removed from the layout.
2. Press the **<New>** button and enter the name of layout to add.
 3. In the **<Ch. Table>** or **<Channel List>**, click and select the channel to be displayed on the layout screen.
 4. Click on **<OK>** to save the selected layout.

- The layout for each user is saved separately.

AUDIO ON/OFF

You can turn the sound on/off corresponding to the channel in Live mode.

AUDIO ON/OFF in Single mode

Click on the audio icon (🔊) on the screen to turn it ON/OFF.

- ✎ If there is no sound even though the output settings have been properly configured, confirm that the connected network camera supports the audio function, and check to ensure that the audio settings are properly configured. The sound icon can be displayed if the sound signal fails to output from noise.
- Only the channel where <AUDIO> is set to <ON> in "Setting the Device > Camera" displays the audio icon (🔊) in Live mode that you can use to turn the sound on/off.

FREEZE

This is available only in Live mode, this pauses playing the Live image temporarily.

1. Click on <❄️> of the launcher mode. Video playing is paused.
2. Click on <❄️>. Pause is canceled. Playing is resumed.

EVENT MONITORING

This will display the channel in sync with a specific event (Sensor/Motion/Video Loss) if it occurs. In "Monitor > Event Display", set the event monitoring to ON/OFF and specify the event display time. (Page 39)

- If multiple events occur simultaneously, the screen will switch to a split mode.
 - 2~4 events : 4-split mode
 - 5~9 events : 9-split mode
 - 10~16 events : 16-split mode
- If the second event occurs within the set time of <Event Display>, the first event will last until the second one is terminated.
 - Ex : If you set <Event Display> to 5 seconds, and only one event occurs in CH 1.

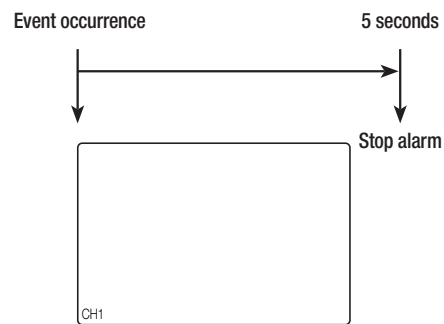

- Ex : If you set <Event Display> to 5 seconds, and the second event occurs in CH 2 within the set time after the first event occurred in CH 1.

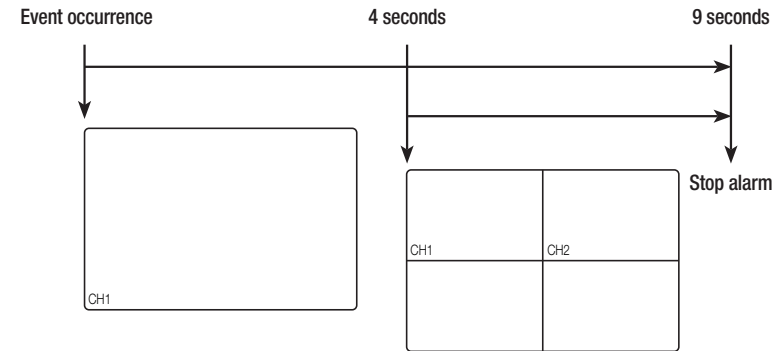

- ✎ Select <Stop Alarm> to initialize the status of alarm output and release the event function.
- If an alarm is output with the pre-event and post-event times specified together with the event recording settings, the event recording will perform according to the specified recording type (pre event or post event).
- ! In case of continuous events such as motion detection, switching to another split mode display may not immediate if concatenating events follow, even when you stopped alarm of the event.
 - The video may be delayed depending on the network condition.
 - The event output can be delayed as the transfer of the alarm event from the network camera takes time.

CAPTURE

You can capture a screen selected on the live screen. Function to perform in single channel mode on the live screen or when selecting a channel.



1. Select <Capture> from the live screen menu. You can click on <📷> in the launcher menu.
2. Select the output information to be displayed on the captured screen.
 - When you select the <Description> check box, a window to enter a description is opened and you can enter up to 50 Korean letters.
3. Select a device to save a captured file, file path and file name.
4. Complete the settings and click <OK>, then the image captured from the screen is saved to the selected device.
 - If there is no video in the channel, the capture function will fail. If you do not retry, the capture function will automatically terminate after 5 seconds.

MAINTAIN THE SCREEN RATIO

The screen ratio for a live video can be changed.

Maintain a screen ratio for all channels

Video screen ratio for all channels can be changed in live split screen mode.

1. Select **<Keep full scr ratio>** from the live screen menu.
The screen ratio for all channels will be changed.
2. If you want to go back to the previous screen ratio, check the menu option for **<Keep full scr ratio>**.

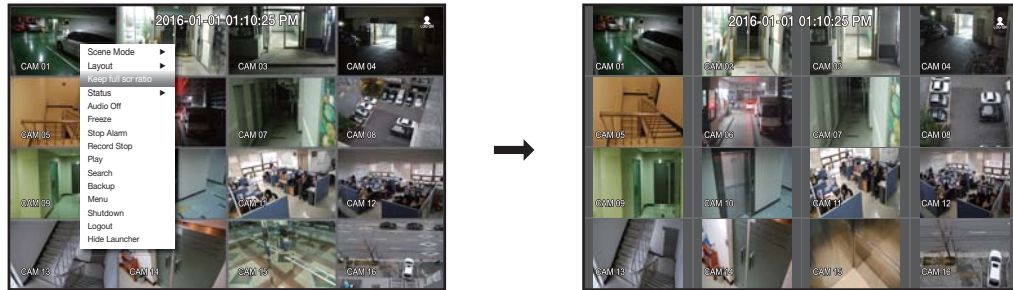

Maintain a channel screen ratio

If you select a channel from a live single screen or split screen, you can change its video screen ratio.

1. Select **<Keep ch. scr ratio>** from the live screen menu.
The screen ratio of a specified channel will be changed.
2. If you want to go back to a previous screen ratio, select **<Keep ch. scr ratio>** again.



Using the PTZ camera

You can use a single PTZ camera to perform the Pan, Tilt and Zoom operations to monitor multiple places, and configure the custom settings of the presets in a desired mode.



1. Open the **<PTZ Control>** menu.
The **<PTZ>** icon in the left bottom of the screen will turn yellow, indicating that the system accesses "PTZ Control" mode. You will see the "PTZ Control" launcher menu.
 - The PTZ working (active) mark can be active even if the PTZ operation is not available in normal mode. So ensure that you have completed the PTZ settings before proceeding.
 2. Use the PTZ Wheel in the launch menu to adjust the location of recording by a camera.
 - Sensitivity : Adjust sensitivity for Pan, Tilt controls.
 - PTZ Wheel : Click a near area from the center to move the camera lens slowly; clicking a far area will move it fast.
 - If clicking and holding the mouse in the left will turn the camera counterclockwise; if clicking and holding the mouse in the right will move the camera lens clockwise.
 - Zoom : Activate the Zoom operation of the PTZ camera.
 - Iris : Adjust the amount of light incoming to the camera.
 - Focus : You can adjust the focus manually.
 - Swing : Swing is a monitoring function that moves between two preset points and enables you to trace the motion.
 - Group : The group function enables you to group various presets before calling them in sequence.
 - Trace : Tracking remembers the trace of movements that you instructed and reproduces it for your reference.
 - Tour : Monitor all the groups created by a user in turn.
 - Some cameras may differ in the menu title and operation with regard to Swing, Group, Tour and Trace.
- ! ■ Even if the network camera supports the PTZ operations by default, the PTZ control can be enabled only if the applicable menu is active in the launcher menu.

Using Digital PTZ (D-PTZ) function

1. Register a camera that supports the D-PTZ profile.
 - In cameras that support the D-PTZ profile, you can use the D-PTZ function.
2. Both cameras that support general PTZ and cameras that support D-PTZ can control the live image using some of the **<PTZ control>** function menus.
 - For more information about the supported functions, please refer to the camera manual.

Preset

Preset is a specific position remembered by the PTZ camera. You can use the Preset function to define up to 300 presets for a single PTZ camera.



To add a preset

1. Check the preset checkbox.
2. Select **<K>**.
The virtual keyboard will appear on the screen. Use it to provide the preset name.
 - Refer to "Using Virtual Keyboard". (Page 26)
 - : You can change the preset settings to your preference.
 - : Delete a selected preset.
 - : Delete all the existing preset settings.
 - You can add up to 300 presets, which is the max count supported by the NVR.
 - If you replace a camera that saves your preset settings with a different one, you must configure the preset settings again.
3. Select **<OK>**.
The preset setting will be saved in the provided name.

To change or delete a registered preset

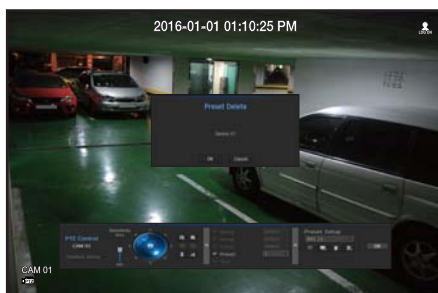

1. Check the preset checkbox and select a preset to change or delete.
2. Press **<K>** or **<D>** as needed.
 - : Delete all the existing preset settings.
 - If you delete the entire presets, the default presets specified in the network camera can be deleted accordingly.
3. Provide a new name and press **<OK>**.

BACKUP

You can check the backup device and set the backup schedule by channel or by time.

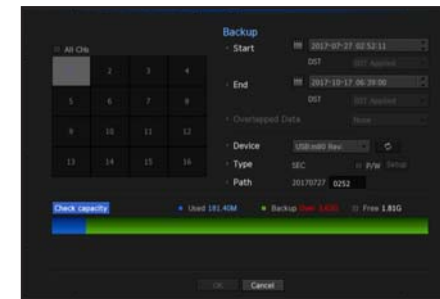

1. Select **<Backup>** from the live screen menu.
You can click on **<Backup>** in the launcher menu.
2. The backup settings screen will be opened.
 - Channel : Sets the channel to backup.
 - You can select multiple channels.
 - If you select **<All CHs>**, all channels will be selected.
 - Backup Range : Sets the **<Start>** and **<End>** time for the backup.
 - Overlapped Data : Shows a list of overlapping data on a same time according to the number of data. It appears when one channel has multiple data on a certain time point due to changing of time or time zone settings, etc.
 - Refer to time and time zone of "Setting the Date/Time/Language". (Page 25)
 - Device : Select a backup device from the recognized devices.
 - Type : Saves data in the proprietary format with built-in viewer, which supports immediate playback on a PC.
 - If you select the SEC format, you can select whether or not to "Set Password".
 - Path : displays the location of the folder in which the backup file is to be saved.
 - Check capacity : Shows the size of the selected backup data, used and available capacity of the selected backup device.
3. When the backup setup is done, press **<OK>**.
 - If no available device is recognized for backup, **<OK>** button is not activated.
 - The application may slow down during the backup.
 - You can switch to the menu screen during the backup in operation, but playback of data is not available.
 - The data can be played back on a Webviewer while the backup is in progress but audio does not function.
 - If backup has failed, select "Device > Storage Device" and check the free space of the HDD and check also if the HDD is properly connected.
 - Pressing the **<Exit>** during the backup will return to the previous menu, while the backup progresses.

menu setup

You can setup the system, devices, and options for recording, event and network.

SYSTEM SETUP

You can setup Date/Time/Language, User, System Properties and Log.

Date/Time/Language

Setting the Date/Time/Language

You can check and setup the current Date/Time and time related properties, as well as the language used for the interface on the screen.

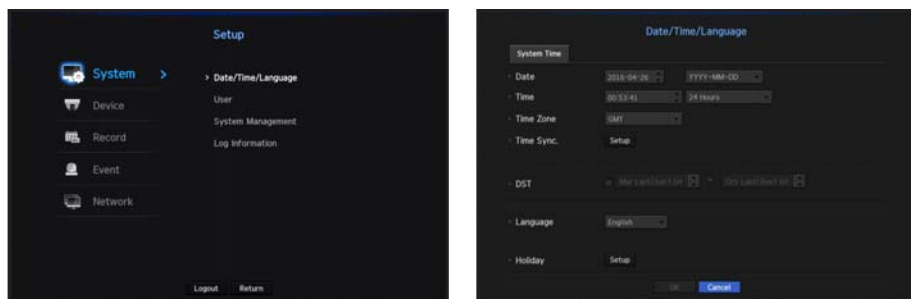

- Date : Sets the date and its format that will appear on the screen.
- Time : Sets the time and its format that will appear on the screen.
- Time Zone : Sets the time zone of your area based on the Greenwich Mean Time (GMT).
 - GMT (Greenwich Mean Time) is standard World Time and the basis of world time zone.
- Time Sync. : Specify the use of synchronization with the time server.
Click the <Setup> button to display time synchronization setup screen.
If you select to use the <Time Server>, the current time will be synchronized on a regular basis by the server defined as <Time Server>.
If this is the case, you cannot change the time setting manually.
 - Synchronization : Select whether to use time synchronization and the time synchronization source (GPS or NTP).
 - Time Server : Enter an IP or URL address of the time server.
 - Last Sync Time : Displays the most recent synchronization time from the selected time server.
 - Activate as Server : Set to <Use> to allow the NVR to act as a Time Server for other NVRs.
- DST : Set up Daylight Saving Time with its period to make the time earlier than the GMT of its time zone by 1 hour during the set period.
- Language : Select your language. Sets the language for the interface.
English, French, German, Spanish, Italian, Chinese, Russian, Korean, Polish, Japanese, Dutch, Portuguese, Turkish, Czech, Danish, Swedish, Thai, Romanian, Serbian, Croatian, Hungarian, Greek, Finnish, and Norwegian are supported.

- Holiday : A user can select specific dates as holidays according to their own preferences. Holidays are applied in the <Recording Schedule> or <Alarm Schedule> setting too.

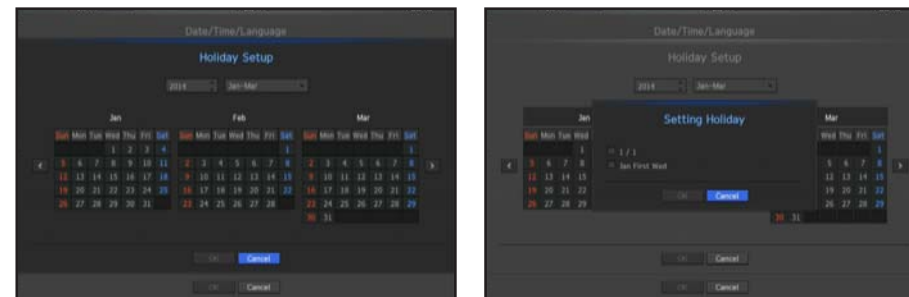

- e.g. every first day of a year is set to be a holiday if you select January 1 and check <1/1>, and every first day of a year and every first Wednesday of January are set to be holidays if you check <1/1> and <Jan First Wed>.

To use the calendar



1. Select year and month.
Select the <◀ ▶> key on both ends of year and month to move back/forward to the previous/next year or previous/next three month.
2. Select a date and click on the <OK> button.
 - A date is marked in gray if there exist data for search for system log, event log, time search and event search.

User

You can set permissions of each user over the NVR's specific function and settings.

Setting the Administrator

You can set and change Administrator's ID and password.
The administrator can use and set all menu items and functions.



- ID : Change the admin ID.
- Password : Checks the current password.
- New P/W : Enter new password.
- Confirm P/W : Confirms the new password.
 - If <View password> is selected, the password will no longer be hidden on the screen when you type it.

- The initial administrator ID is set to "admin" and you will need to configure the password in the installation wizard.
- Please change your password every three months to safely protect personal information and to prevent the damage of the information theft. Please, take note that it's a user's responsibility for the security and any other problems caused by mismanaging a password.
- If you click <View password>, a basic guide for password setup is displayed.

Using Virtual Keyboard



1. For alphanumeric inputs, the virtual keyboard window appears.
2. Using a mouse, click on the desired character tab.
3. In the upper text input box of the virtual keyboard, there displays a list of candidate words containing the selected character.
4. Select a word from the list, or use the keyboard to enter the whole word.
 - If there are many of candidate words, use <Left> <Right> buttons to move between them forward and backward.
5. Select <OK>. Entered word is applied.
 - For upper case letters, use <Caps Lock> button.
 - For special characters, use <Shift> button.
 - Using the virtual keyboard is the same to a normal keyboard use in your region.
 - ID allows alphanumeric characters only.
 - The password should at a minimum be an 8-digit combination of alphabetical letters and numbers.



User setting

You can create a group or set permissions for each group.
You can add a user and edit the registered user information.

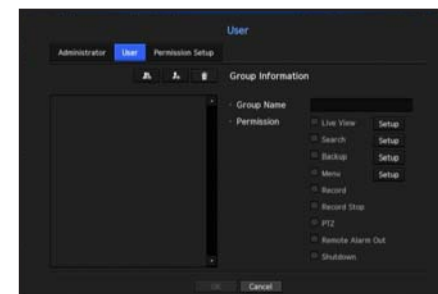

If you want to add a group

1. Click on the [Add] button to launch the Group Addition popup window. If you want to add a group, click on <OK>.
2. Press the group name item to launch the virtual keyboard used to enter group names. Enter the group name to register.
 - You can add a maximum of 10 groups.

If you want to set group permission

Set permission to access each group.
Each group's users can only access items with a check mark beside them.

1. Select the menu to set group permissions. The menu with access permissions will appear when a user of the group logs in.
 - Live View : You can set permissions to access the live screen for each channel.
 - Search : You can set permissions to access the search menu for each channel.
 - Backup : You can set permissions to access the backup menu for each channel.
 - Menu : You can select and set the setting menu that can be accessed. A group user can only access the menu selected. If you select the menu, the menu permission setting screen will be displayed.
 - Record Stop, PTZ, Remote Alarm Out, Shutdown : You can select these functions to add to a group's permissions.
2. Click <OK>. Check a group user to give them the permission to access the selected item.

If you want to register a user

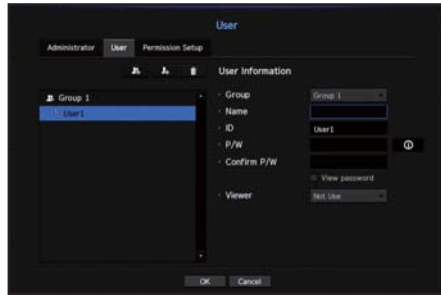

1. Click on the [] button to launch the user addition popup window. To add a user, click on <OK>.
2. Select a group.
When registering a user, the selected group will be automatically registered.
 - A group can be changed after inputting all required information.
3. Enter name, ID, password and select whether to use the viewer.
If you activate use of <Viewer>, you will have the right to use the web viewer and the network viewer.
4. Click <OK>.
Registered user information will be saved.

When you want to delete the group and user information

1. To delete, click on the [] button.
2. The deletion confirmation window will appear and you can select an item to delete and click on <Delete>.

Setting Permissions

You can set restricted access for all general users. Items with restrictions will require logging in for use.

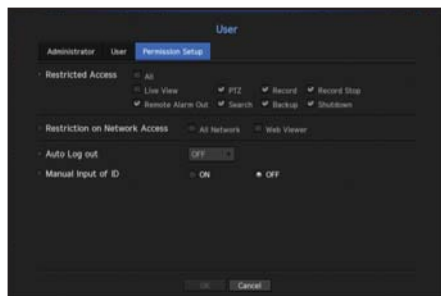

- Restricted Access : All menu items allowed for a user can be set with restricted access.
 - Checked () : Restricted
 - Not checked () : Accessible
 - If it is not checked () in <Restricted Access>, any user can access the item no matter what the <Permission> setting.
 - If it is checked () in <Restricted Access>, a user can access the item only if the user has permission in <Permission> setting.

- Restriction on Network Access : Restricts remote access from a <Restricted Access> network.
 - All Network : Restricts all access instances via Network Viewer and Web Viewer.
 - Web Viewer : Restricts access via the Web Viewer.
- Auto Log out : A user will be automatically logged out if there is no operation on NVR for over set period of time.
- Manual Input of ID : In the login window, select whether to enter ID.

If the user has restricted access

If a new group is restricted to access the entire menus, the users belonging to the group can access only the basic menus and can change only their respective password.

If all permissions are restricted, you will see only some menu items accessible in the Live screen menu.



To change the user password

If you log in with the user account of a group with restricted access, you just can change your own password.

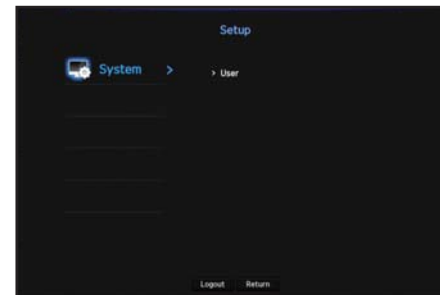

1. Provide the login information.
2. Select <User Menu>.
The Permission Management screen appears.
3. Select <User>.
The Password dialog shall appear.
4. Provide a new password.
5. Select <OK>.
The old password will be changed to a new one.

System Management

You can check the system version, update to a newer version, as well as data backup and initialization.

Checking the System Information

You can check the current software version and MAC address before proceeding with the upgrade.

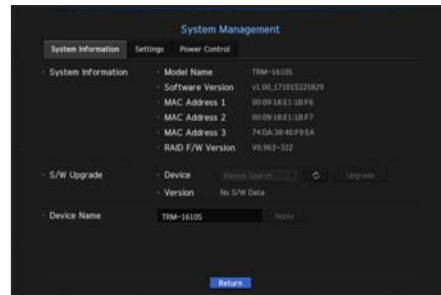

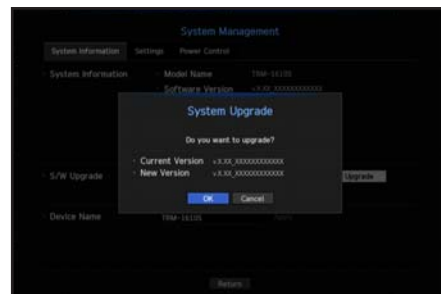

- System Information : Shows the current system's information. The values can not be changed by a user.
- S/W Upgrade : Updates the NVR's software up to date.
 - Press the <  > button to search for and display the equipment to upgrade.
- Device Name : Displayed if the network viewer is connected to NVR.

To upgrade the current software version





1. Connect a device storing the software to be updated.
 - It may take about 10 seconds to recognize the device.
 - Upgradeable devices include USB memory, and network device.
 - To update the network, the current NVR should have been connected to the network. Upgrade via the proxy server may not be enabled due to the restricted access.
2. Select <System Management> from <System> window.
3. Select <System Information>.

4. When the recognized device appears, select <Upgrade>.
 - If you connect a device in the upgrade menu window, you can press the <  > button to search for available software.
 - If there is an upgrade image on the network, the popup window will appear.
 - The <Upgrade> button will be activated only if the current <Software Version> of the <System Information> is same to or older than that of <S/W Upgrade>.
 5. Press <OK> in the "S/W Upgrade" window.
 - While updating, it shows the progress.
 6. When the updating is done, it automatically restarts. Do not turn the power off until it finishes restarting.
-  ▪ If "Upgrade Failed" appears, retry from the step 4. When you experience continued failure, consult the service center for assistance.

Settings

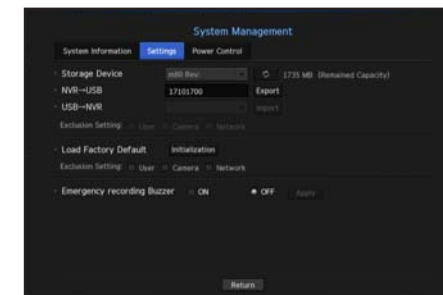
You can copy and import the NVR settings by using a storage media.



- Storage Device : Shows the connected storage device.
 - Press the <  > button to view the list of storage devices.
 - NVR → USB : Exports NVR settings to the connected storage device.
 - USB → NVR : Imports NVR settings from the storage device and applies to the NVR.
 - Uncheck the checkbox of an item(s) that you want to import. Only the other items than the selected one will be applied to the NVR.
 - <Export> and <Import> settings should be used in the same software version.
 - Load Factory Default : Restore the factory default settings of NVR. Uncheck the checkbox of an item(s) that you want to reset. Then, only the other items than the selected one will return to the factory default. If <Initialization> is selected, a confirmation dialog for "Load Factory Default" prompts. Press <OK> to initialize the system to the factory default.
 - Emergency recording Buzzer: You can set whether or not to generate a buzzer when the emergency recording button in the control box is pressed.
-  ▪ If you want to initialize the <Authority Setting>, you need to reset the password. In case you reboot, reset it the Installation Wizard and if not, use the guide screen to reset it.

How to control power

NVR power-related settings are applied.

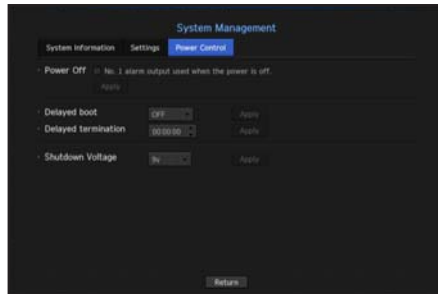

- Power off : If the power is off, the first alarm is generated. After checking the checkbox, if the <Apply> button is pressed, all event alarms that are set to the first alarm output are released, and then the first alarm cannot be selected by other alarm output.
 - If that function is set, the first alarm-out checkbox and all alarms in the alarm setup screen are deactivated, to Off.
- Delayed boot : Sets boot to occur after a certain period of time rather than immediately booting the NVR after power is applied.
- Delayed termination : You can set the time so that NVR is not terminated during backup after the vehicle has stopped.
- Shutdown Voltage : NVR is terminated when the battery voltage of the vehicle drops below the set voltage. The voltage value can be set between 9v and 33v.

! This function will work once 3 minutes has passed after booting. If you set it incorrectly, change the setting value within 3 minutes.

Log Information

You can browse logs on the system and events.

Checking the system log

System Log shows log and timestamp on every system start up, system shutdown, and changes on system settings.

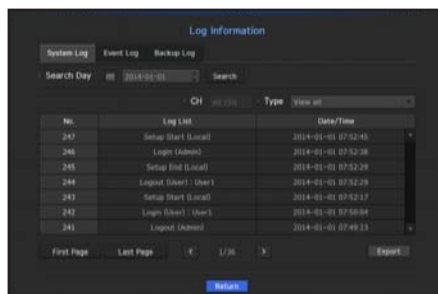

- Search Day : Click the Calendar icon to display the calendar window, or use the direction buttons to specify the search period of the system log.
 - For using the calendar, refer to "To use the calendar". (Page 25)
- Search : Specify the date and press this button to display the search result in the log list.
- Type : When there are too many logs, you can display logs of the desired format by selecting the type.
- Export : Save all the logged information recorded in the NVR into the storage media.

Checking the event log

You can search recorded events including alarms, camera events and video loss. It also shows the log and its timestamp.

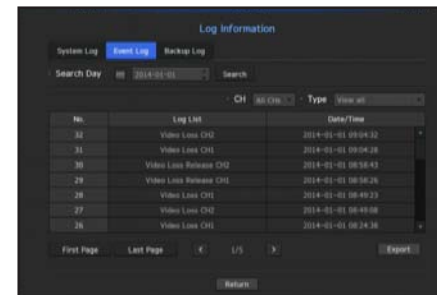

- Search Day : Click the Calendar icon to display the calendar window, or use the direction buttons to specify the search period of the system log.
 - For using the calendar, refer to "To use the calendar". (Page 25)
- Search : Specify the date and press this button to display the search result in the log list.
- Type : When there are too many logs, you can display logs of the desired format by selecting the type.
- Export : Save all the logged information recorded in the NVR into the storage media.

Checking the backup log

You can find out who backed up and the details (backup time, channel, device to use, file format, etc.).

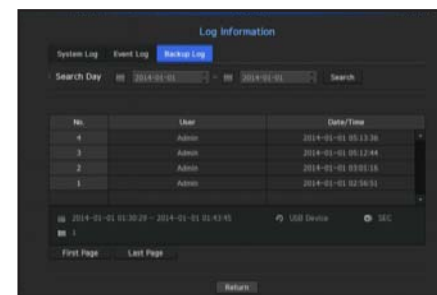

- Search Day : Click the Calendar icon to display the calendar window, or use the direction buttons to specify the search period of the system log.
 - For using the calendar, refer to "To use the calendar". (Page 25)
- Search : Specify the date and press this button to display the search result in the log list.

SETTING THE DEVICE

You can configure settings related to camera, storage media, monitor.

Camera

To register a camera

You can register a network camera for each channel and make connection between.

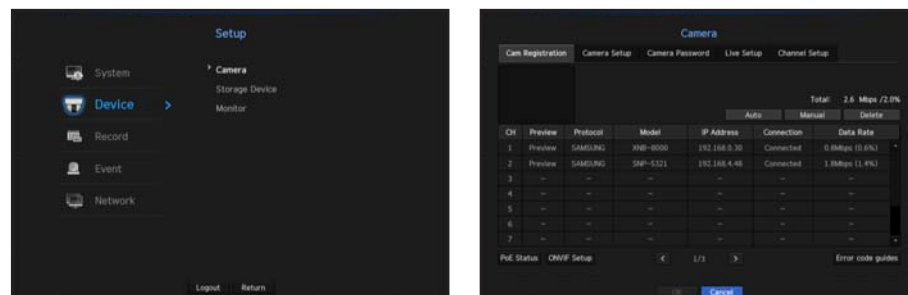

- Preview : View the video of the channel as a current image.
 - Camera searched with ONVIF does not provide previews.
- Protocol : Show the protocol information of a registered network camera.
- Model : Show the camera model name.
- IP Address : Display the IP address of a network camera.
- Connection : Display the connection status.
- Data Rate : Displays the total amount of data received by the channel.
- PoE Status : Displays connected PoE status information.
- ONVIF Setup : You can additionally set up ONVIF protocol camera.
- Error code guides : You can check the details of generated error codes.

If the NVR has been initialized, it may not connect to cameras. Configure the network settings first and add cameras. For more information on network settings, refer to "Network Configuration". (Page 43)

If you want to register a camera in PoE mode

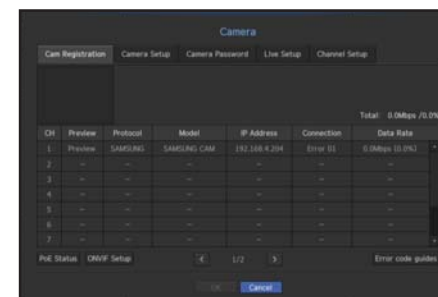

- ! The camera connected to the PoE port of the NVR must be set to DHCP mode.
- Samsung cameras are registered for Samsung protocols and other cameras are registered by using the Onvif protocol.
- A device in which the DHCP server is running should not be connected to the PoE port or camera configuration port. (e.g., Wi-Fi hub)

To auto-search for and register a network camera



1. In the <Cam Registration> field, click on the <Auto> button.
 2. Search for a network camera connected.
 - An already registered camera will be marked in blue in the list.
 - If you search for the camera again or if the IP is an old IP that was not assigned by the DHCP server (such as -192.168.1.100), then press the <Refresh> button to check if a new IP has been assigned. If the IP is still the same, then select Assign IP to assign the IP manually.
 3. Select a camera from the camera list to see a preview of its current video feed.
 - Camera searched with ONVIF does not provide previews.
 4. Check the checkbox next to a network camera that you want to connect to.
 - You can select all of the network cameras in the list and provide <ID> and <Password> all at once.
 - Click a header at the top of the list to sort the list according to that header.
- ! Registering camera with user account other than admin may restrict camera function.
 - When you change the camera ID/password in the camera web viewer, if the camera is already registered in NVR, you also have to change the camera ID/passwd information registered in NVR.

5. Click on the <ID/PW> button to enter the selected network camera's <ID> and <Password>.
6. Press the <Connection Test> button to make a connection to a camera.
7. Press <Register> to register the selected camera.

To manually search for and register a network camera



1. In the <Cam Registration> menu, click on the <Manual> button.
 2. The manual search window will appear.
 3. Select a channel and protocol used to connect to a camera.
The input items may differ depending on the selected protocol.
 - SAMSUNG : Comply with the internal network protocols adopted by Hanwha Techwin.
 - ONVIF : Means the camera supports ONVIF protocols. When connecting a camera that its name cannot be found from the list, select <ONVIF>.
-  ■ Time difference between the ONVIF camera and NVR exceeds more than 2 minutes, the camera cannot be connected. In this case, synchronize the ONVIF camera's time to the NVR or set times of both camera and NVR to a same NTP server (if in the same time zone), or make the NVR an NTP server.
4. If you select the <SAMSUNG> protocol, check options as necessary.
 - Model : Select a camera model.
 - Samsung Network Camera/Encoder : Means the camera/encoder supports Hanwha Techwin's SUNAPI, SVNP protocol. When connecting a camera that does not appear in the camera list, select Samsung Network Camera/Encoder.

- Address type : Select an address type of the camera.
 - Address type can be different depending on connected product model.
 - Static(IPv4) : Used to provide the IP address of the camera manually.
 - iPOLiS DDNS : This is available only if the camera is registered with the iPOLiS DDNS(www.samsungipolis.com) server. Provide the registered domain for DDNS ID.
 - Ex) http://www.samsungipolis.com/snb5000 → provide "snb5000" for iPOLiS DDNS
 - URL : Used for URL address input.



- Refer to the user manual of the connected camera and check the DDNS specification that is supported by the camera.

- IP Address : Provide the IP address of the camera.
 - Device Port : Provide the device port of the camera.
 - HTTP Port : Provide the HTTP port of the camera.
 - ID : Provide the ID of the camera that you want to register.
 - Password : Enter the password of the camera to be registered.
5. Select <ONVIF> or <RTSP> for the protocol and enter your input for each field appears.
 - ONVIF Address / RTSP URL : Enter the camera's RTSP access address that supports ONVIF or RTSP. For more information about the RTSP address, refer to the manual of each applicable network camera.
 - ID : Enter the ID for accessing via ONVIF/RTSP protocol.
 - Password : Enter the password for accessing via ONVIF/RTSP protocol.
 - Mode : If <More Detail> button clicked, setup window will appear. Select a mode that is supported by the network camera in RTSP connection mode.
 - TCP : The connection type with the network camera will switch to "RTP over TCP".
 - UDP : The connection type with the network camera will switch to "RTP over UDP".
 - HTTP : The connection type with the network camera will switch to "RTP over TCP (HTTP)".
 - HTTPS : The connection type with the network camera will switch to "RTP over TCP (HTTPS)".

If you want to check the error details of camera registration

If you failed to register a camera, the reason for the failure will be displayed.

- **Connection failed due to unknown error.** : This message appears if the camera has failed to be registered due to unknown connection status.
- **Due to the camera account locking, access has failed.** : When you enter a wrong ID/password 5 times to login to the camera account, this message is displayed.
Try to log in again after 30 seconds. If the same message appears, you may need to check whether someone has tried to access your camera account from the outside.
- **Connected successfully.** : This message appears if the camera is connected successfully.
- **Incorrect model information. Provide the correct model information.** : This message appears if the model information provided for registering the camera is incorrect.
- **Authentication has failed** : This message appears if the ID or password provided for registering the camera is incorrect.
- **Connection has failed due to excessive concurrent users.** : This message appears if the concurrent user count exceeds the upper limit.
- **Connection has failed due to incorrect HTTP port information.** : This message appears if the HTTP port number of the camera is invalid.
- **Connection has failed. Unknown connection status.** : This message appears if the camera has failed to be connected due to a unknown error.
- **User Model Modification** : When registering a new camera, it is named according to the device's default if user set the model to <Samsung Network Camera/Encoder>. In case if automatic registration fails, user can change the model name of camera to be registered.

To edit camera profile

When a camera is added for the first time, it is added as the default profile of H.264, H.265 and MJPEG in order temporarily.

To change its profile, refer to "**Setting the network camera's recording profile**" (Page 40) or "**Live Setting**" (Page 35).



- In case of NVR, if you set 3 different profiles for live, recording and network profile, one camera will produce video streams accordingly, having different stream formats. Especially, note that the live profile may vary depending on the used screen split mode.
- For cameras, if applied with one profile only, the produced frame rate is fixed as the profile specifies; if applied with multiple profiles, produced video stream's frame rate is not guaranteed. For example, if applied with 2 profiles of 30fps, the camera may transmit streams at 20fps.

ONVIF Setup

In the bottom of the camera addition screen, click on the <ONVIF Setup> button to set additional settings for cameras with the ONVIF protocol.

- You can change the information only if the user account (camera account used for camera registration) is used to read the user information and a connection is made with the admin privilege.



Profile

- CH : It shows the list of registered camera with the ONVIF setting.
- Add Profile : You can add camera profile.
After adding a profile, click on the <OK> button to add it to the list.
- Delete : After selecting the profile to delete, click on the <Delete> button to delete the selected profile.
- Profile information : You can set the details of the selected profile.

After finishing setting each item, click on the <OK> button to save changes.

User

- Add User : You can add a camera user.
After adding a user, click on the <OK> button to add them to the list.
- Delete : After selecting the user to delete, click on the <Delete> button to delete the selected user.
- User Information : You can set the details of the selected user.

Network

You can set the details of the network.

- IP Type : The network is IPv4 type.
- DHCP : Select whether to use the DHCP.
- DNS / NTP Server : Only if the DHCP setting is <ON>, the DHCP checkbox will be activated.
 - If the DHCP is checked, you can manually enter the IP address.

Relay

You can set details of the relay.

- Digital Output : You can select a digital output channel.
- Relay Mode : Select either bi or mono stable modes.
- Relay Idle State : Select either open or closed relay standby modes.
- Delay Time : Select the relay operation waiting time.

Event

You can set details of the event.

- Available events (camera) : It shows the list of all the events supported by a camera by using the ONVIF protocol.
- NVR supported events : You can map the list of events supported by a camera to events that the NVR can detect. There is no default value. It only shows the value sent by a camera.

Camera Setting

You can change the video settings of a registered network camera for each channel.

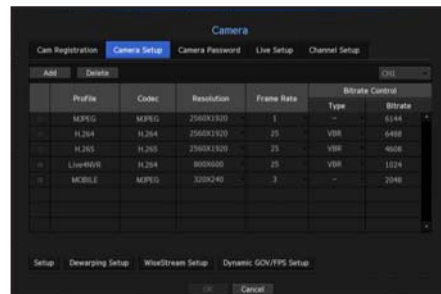

- Add : You can add camera profile. Click on the Add button to launch the addition window. Enter the information and click on the <OK> button to add it to the list.
- Delete : You can delete the selected profile from the list.
- Select Camera : Select the camera channel to change the video transmission settings.
- Profile : Show a video profile for the connected camera.
- Codec : Show the codec information for the selected profile.
- Resolution : You can change the resolution of the selected profile.
- Frame Rate : You can change the baud rate of the selected profile.
- Bitrate Control : You can change the bit rate for video transmission of the selected profile.

- If you change the settings of a specific profile for each model, the effective range of the baud rate may be changed accordingly. Ex) if you set the baud rate of the first profile to 30fps, the send rate of the second profile will be changed to 15fps.
- Menu options other than codec, resolution and transmission rate can be configured in the settings menu of the network camera.
- If you change the current profile settings, you may encounter an interrupted playback on the recording or live screen for a certain time.
- Changes made in Camera Setup page are applied immediately, while changes made through the camera's web page may require up to 3 minutes.

Setup

In the bottom of the camera setting screen, press the <Setup> button to set your camera while watching the live video of the selected camera.

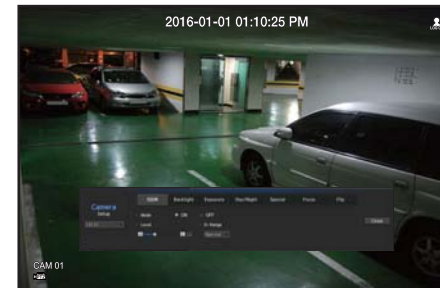

- SUNAPI : Camera that supports the communication protocols provided by Hanwha Techwin
 1. Camera supporting SUNAPI.
 2. A camera connected with admin privileges.
 3. A camera connected to Samsung protocols.
 In the above cases, you can use the function.
- For more details on camera settings, refer to the camera user manual. Settings and operational spec vary depending on each camera.
- This function is not supported in some models.

SSDR

If there is a significant difference between the dark and the bright areas, increase the brightness of the dark areas to maintain the level of brightness of the entire area. Mode, level, D-Range can be set.

Backlight

You can view both bright and dark areas. Mode, WDR level, WDR black/white levels can be set.

Exposure

You can adjust the exposure of your camera. Brightness control, shutter, SSNR, Sens-up, shutter/lens, and gains can be set.

Day/Night

You can change the mode to adjust the color and contrast. Mode, switching time, brightness change, alarm time, alarm input/output, negative color, daytime/nighttime switching and simple focus, and activation time can be set.

Special

DIS (shaking compensation), use of Defog levels can be set.

Focus

You can adjust the focus of you camera's video.
Items of Simple Focus and Focus-Initialize Setting can be set.

Flip

Mirror and flip modes can be set.
After finishing with setting camera, click on the <Close> button to move back to the previous screen.

Dewarping Setup

Press <Dewarping Setup> at the bottom of the camera settings screen and a distortion correction settings window for each channel is prompted.

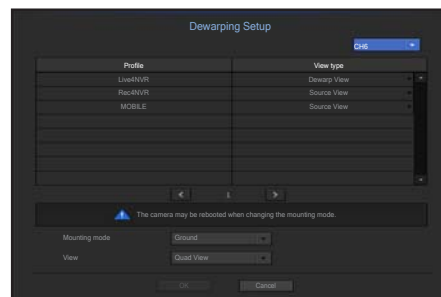

- Profile/View type : You can select the view type of profiles, except for fixed profiles (SourceMJPEG, SourceH264, DewarpMJPEG, DewarpH264) whose settings can't be changed, in the profile list on the distortion correction settings pop-up window.
- Mounting mode : You can change the fisheye installation type. You can select a view mode from among CEILING/GROUND/WALL depending on the installation location.
- View : You can change the fisheye view mode of the current screen according to each split section.

✎ If there is no camera registered in the NVR that supports fisheye view, <Dewarping Setup> will not be available.

How to set WiseStream

Function to analyze the complexity of the video and effectively reduce the data size while maintaining the quality. For details, refer to the camera's help or the product's user guide.

Press the <WiseStream Setup> button at the bottom of the camera setup screen to display the WiseStream setting popup window for that channel.

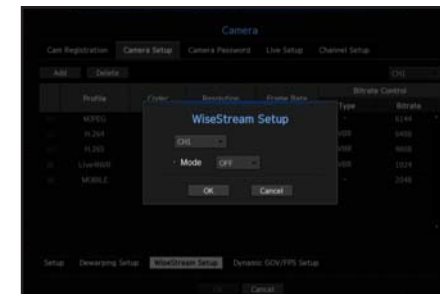

- Channel : You can select the channel to set WiseStream.
- Mode : You can choose the degree of video compression. You can choose either OFF, Low, Medium, or High.

✎ <WiseStream Setup> cannot be executed if there is no camera registered in NVR that supports WiseStream.

How to set the variable GOV/FPS

Variable GOV is a function that automatically changes GOV length according to the video situation. For details, refer to the camera's help or the product user's guide.

Press the <Dynamic GOV/FPS Setup> button at the bottom of the camera setup screen to display the Variable GOV/FPS setting popup window for that channel.



- Profile : Shows the video profile of the connected camera setting.
- Dynamic FPS : Set the FPS value to automatically change to the setting value of the maximum dynamic FPS.
- Dynamic GOV
 - Mode : Set the GOV length to change automatically.
 - Length : Enter the maximum GOV length value to be applied when there is no motion in the video. Minimum GOV value can be set on the camera web page.
 - Range : The range of the input value of <Length> is displayed.

✎ Profiles that do not support variable GOV/FPS setting are displayed as <->.

Setting Camera Password

You can change the passwords of all registered cameras at once.

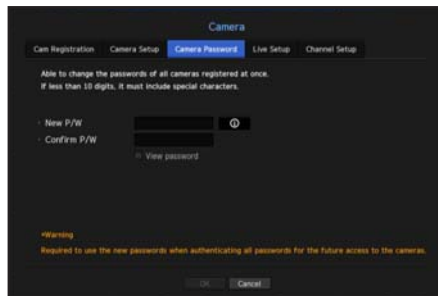

- New P/W : Input a new password according to the password setting rules.
- Confirm P/W : Input the new password again.

- If you click < >, a basic guide for password setup is displayed.
- If <View password> is selected, the password is no longer hidden on the screen when you type it.
- A camera password registered with ONVIF and RTSP cannot be changed.

Password setting guide

The length and limitations of a password are as follows.

- Uppercase letters/lowercase letters/numbers/special characters, containing at least 3 out of the 4 character types mentioned: 8 or 9 digit combination
- Uppercase letters/lowercase letters/numbers/special characters, containing at least 2 out of the 4 character types mentioned: 10 to 15 digit combination
- The password shall not be identical to the user ID.
- To enhance security, it is not recommended to use repeated digits or letters, or keyboard patterns as a password.
- Special characters accepted for a password : ~!@#\$%^&*()_+={}|.~./

Live Setting

You can change the live transfer settings of the network camera.

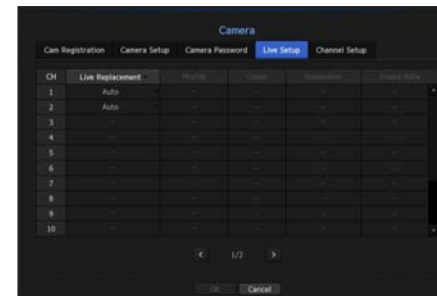

- Live Replacement : You can select the live profile setup mode. If you select <Manual>, the profile setup items are enabled, and you can change settings manually.
 - Auto : In case of split mode, the profile for live monitoring shows the Live4NVR profile(basic: H.264 800*600 30fps) created at the time of registration and it automatically selects the second profile in case of single mode.
 - Manual : Live monitoring is performed with the profile selected by the user from the registered camera profiles.
 - Record : Live monitoring is performed with the profile set for recording.
- Profile : You can select the video profile of the connected camera setting.
- Codec : Show the codec of the selected recording profile.
- Resolution : Show the resolution of the selected profile.
- Frame Rate : Show the frame rate of the selected profile.

Channel Setting

You can configure the video settings for each channel.

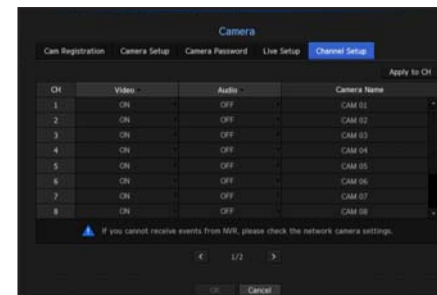

- Apply to CH : If you select <Apply to CH>, the "Apply to CH" confirmation window will appear. After selecting channels that the settings will be applied to, click on <OK> to apply them to the selected channels.
- Video
 - <ON/OFF> : You can turn ON/OFF the selected channel's camera.
 - <Covert1> : Shows information other than the video of the selected channel. For privacy protection, it does not display the video while the recording continues.
 - <Covert2> : Shows nothing but an empty screen while the recording continues.

- If the channel is set to <Covert1> or <Covert2> mode, the channel's sound is not hearable. However, the channel's sound is recorded if its Audio setting is set to <ON>, even the sound is not heard in Live mode.

- Audio
 - If set to <ON>, you can turn the audio of the channel ON/OFF on the Live screen.
 - If set to <OFF>, the channel's audio is off on the Live screen and not recorded.
- Camera Name : Provide a camera Name.
 - You can enter up to 15 characters including space.

Storage Device

You can check information on storage devices.

Device/Format

You can check storage devices and their capacity, usage as well as status. HDD, USB (memory or HDD) can be connected as a storage device.

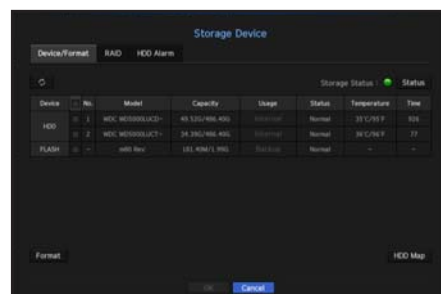

- Storage Status : Displays the working status of a storage device.
 - Red : Displays the situation of video loss.
 - Green : Displays the normal situation without video recording losses.
 - Status
 - Full BPS : Displays the current rate of recording.
 - Current Loss Rate : Displays the current recording loss rate.
 - Max Loss Amount : Displays the maximum amount of losses up until now.
 - If loss is continuously generated, check the following.
For more information, refer to the "**Troubleshooting**". (page 82)
 - When data is received due to a system malfunction (reset the video transmission volume of the camera)
 - When there is a problem in HDD recording performance due to an HDD malfunction (check the HDD error or replace the HDD)
- No. : You can check the designated number for the built-in HDD.
 - If you want the find out about the location corresponding to the HDD number, refer to the <HDD Map>.
- Capacity : Displays the amount of storage device use and the full capacity.
- Usage : Designate the purpose of use for a storage device.
 - If the state of use is in "**Not Defined**", format the HDD before use.

- Status : Displays the current working condition of a storage device. For inspection or replacement of HDD alarms, please refer to "**HDD Alarm Setting.**" (Page 38)
 - Normal : It is displayed during normal operation.
 - Inspection : Operating with partial problems.
 - Replacement : It is displayed when you can no longer use it.
- Temperature : You can check the temperature of the HDD mounted in the NVR.
- Time : Displays the use time of an HDD.
- Format : Select a device and click on format after which a format confirmation window appears. Click on the <OK> button to format the selected storage device.

- ! ▪ Formatting will delete all the recording data that has been saved. Be careful.
 - While formatting is ongoing, you cannot record video.
 - Do not remove a formatting device until it is finished.
 - After installing an HDD, if the state of use of the HDD is "**Not Defined**", format the HDD before use. (If the warning message persists after formatting, replace the HDD with a new one)
- HDD Map : You can check the location according to the assigned number for the HDDs installed inside.
 - Refer to this when servicing or installing an additional HDD.
- ! ▪ Do not add or remove an HDD while NVR is running.

RAID mode setting

If you enable the RAID (Redundant Array of Independent Disks) mode, when a system HDD is damaged you can restore data safely. This NVR supports RAID Level1. The RAID Level1 supported by this NVR maintains the same data on the two HDDs that constitute the RAID Array. This means that even when one HDD fails, the stored data can be used and recovered.

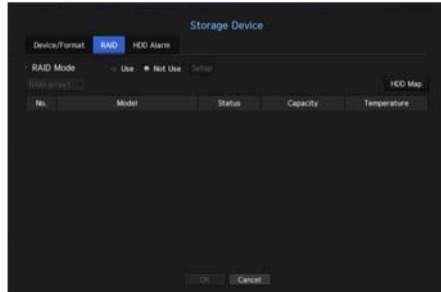

- Status : Displays the operational status of the RAID.
 - Active : Signals the fact that the RAID is operating normally.
 - Degraded: This is displayed when one of two HDDs constituting the RAID array has a fault. Replace the HDD and proceed with recovery before the remaining HDD fails.
 - For more on how to replace the HDD and to restore the RAID, refer to "**Recovering RAID Array**". (Page 38)
 - Rebuilding : It means that a RAID is being restored.
 - Fail : This means that the RAID cannot be used or restored.
- Status : Displays the current operating condition of the HDDs installed in a RAID.
 - Active : Displays that the HDD is operating normally.
 - Faulty : It displays that the HDD is malfunctioning. You need to immediately replace the HDD for smooth recovery of the RAID.
 - Check : A problem occurs on the HDD, requiring replacement or inspection.
- Capacity : It shows the total capacity of the HDDs that composes a RAID.
- Temperature : You can check the temperature of HDD(s) that compose a RAID.

RAID mode setting



1. Click on the <Use> or <Setup> button.
2. In the use RAID window, select settings of RAID and click on the <OK> button.
 - Use/Not Used : You can select whether or not to use the RAID mode.
 - Level1 : It shows the type of RAID supported by the NVR.
3. Click the <OK> button on the RAID screen.
4. The data deletion and system rebooting message window will appear. You can click on the <OK> button to reboot the system for RAID mode setting.
5. When RAID building is complete, select <Setup> - <Device> - <Storage Device> - <RAID> to check the build.



- When you select the Disable button in RAID mode or change the RAID Array to unused in the setting window, RAID Array is released.
- If the status of HDD is displayed as inspected/replaced in the device/format page, you cannot use it to build a RAID.
- A RAID configuration can consist only of HDDs of the same type and same capacity.



- If you enable or disable the RAID mode, existing data will be deleted. You make sure to backup your data.

Recovering RAID Array

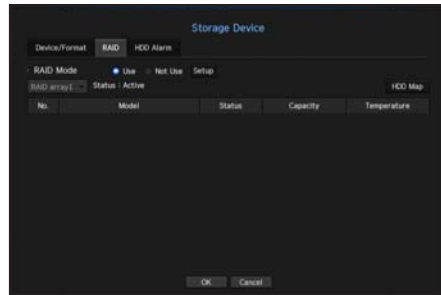

1. If the number of HDDs for which the Faulty/Check indicator is displayed on the <Status> is identified, check the position of the HDD to be replaced on the HDD map.
2. Remove the failed HDD and replace it with a new HDD.
3. The <Device> - <Storage Device> - <RAID> menu will show the progress of recovery.

- !
 - Replace it with the same model of HDD or an HDD of the same capacity from the same manufacturer.
 - A HDD used to build the RAID should be one of the recommended models. If it's not possible to use the same model of HDD, then use the HDD with the same capacity from the same manufacturer should be used.
 - If you remove the power cord while using the RAID, it can damage it, so be careful. For reliable power, it is recommended you use the UPS.
 - A new HDD to be replaced should be one that is not RAID configured.

HDD Alarm Setting

For HDD malfunctions, you can set the inspection alarm output terminal, the replacement alarm output terminal and the alarm time. You can set the alarm behavior for abnormal HDD temperature.



- Alarm
 - If <All> was selected, both beep sound and alarm signal through rear side ports will output.
 - If <BEEP> was selected, a beep will sound.
 - Alarm signal will output through the alarm out port on the rear side when selected <1>, <2>, <3>, <4>, <5> and <6>.
- Check Alarm Output Port : If HDD generates check alarm, the alarm signal will output to the specified alarm output port.
- HDD Temperature Alarm : When the HDD temperature increases higher than the set temperature, a signal is output to the check alarm output terminal.
- Replace Alarm Output Port : If HDD generates replace alarm, the alarm signal will output to the specified alarm output port.
- Duration : Sets the alarm duration for the alarm signal and beep sound.
- ☒
 - <Check> status means that the HDD is operating but it has problems that require technical examination. (☒) appears on the Live screen.
 - <Replace> status means that the HDD has defect and requires immediate replacement.

Monitor

You can set the information displayed on the monitor as well as the output system.

Monitor settings

You can configure the monitor output-related settings including the displayed information, dwell time and output system.

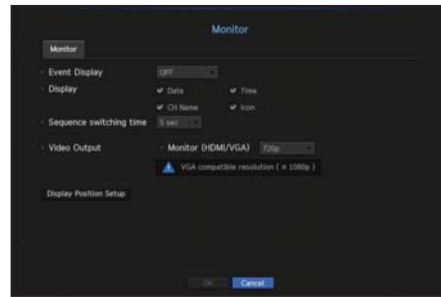

- Event Display : Sets the dwell time of the event channel display on the monitor when an event occurs. If you set <Continuous>, it will keep displaying until you cancel it.
- Display : Displays only checked items on the monitor screen.
- Sequence switching time : Set the automatic switching time for the segmented screen in live mode.
- Video Output : Sets resolution for video output.

To adjust the display position

Some monitors may not display information (camera name, icon, time information, etc.) about the NVR, depending on the condition. Then, you can change the display position of the data.



1. From the monitor setup menu, select <Display Position Setup>.
2. Using the number button to adjust the screen that is cut off.
3. Press <OK>.
 - For the icon information, refer to "Live Screen Configuration > Icons on the Live Screen". (page 15)

SETTING THE RECORDING

You can setup scheduled recording, event recording and other recording related settings.

Recording Schedule

Make your reservation on a date and time to schedule the recording on specified time.

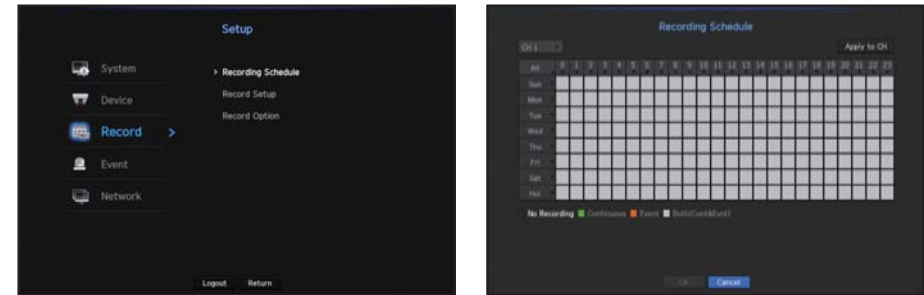

- All : The entire time range (Monday through Sunday including holidays, AM 0~ PM 23) will be reserved with the same recording schedule
- Apply to CH : If you select <Apply to CH>, the "Apply to CH" confirmation pop-up window will appear. After selecting channels that the settings will be applied to, click on <OK> to apply them to the selected channels.

- Event recording and scheduled recording starts about 3 seconds prior to the event/schedule for guaranteed recording.

Record setting by the color

Color	Function	Description
No Color	No Recording	No schedule / event recording
Green	Continuous	Scheduled recording only
Orange	Event	Event recording only
White	Both(Cont&Evt)	Both scheduled / event recordings

Each press of a selected cell will cycle through <No Recording>-<Continuous>-<Event>-<Both(Cont&Evt)>.

Record Setting

You can set resolution, FPS, and quality of recordings by channel, and by recording type of standard / event. You can check frame rates and data transfer amount of Full Frame and Key Frame recordings for each channel, and set the transfer limit for recordings.

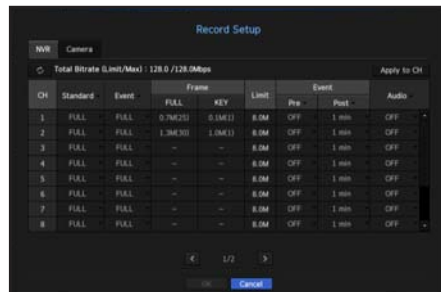

- Apply to CH : If you select <Apply to CH>, the "Apply to CH" confirmation window will appear. After selecting channels that the settings will be applied to, click on <OK> to apply them to the selected channels.
- Standard, Event : Configures Standard recording and Event recording.
 - FULL : Records all frames fed by the camera.
 - KEY : Records only key frames fed by the camera. Actual recording rate may differ from camera settings. In general, 1 to 2 frames per second are recorded.
 - OFF : No recording is made.
- Frame
 - FULL : Shows the amount of data for all the scene recordings.
 - KEY : Shows the amount of data for the main scene recordings.
- Limit : Set the amount of data allowed for input for each channel.
- Event : When an event occurs, you can set which point you will start or stop recording.
 - Pre : When an event occurs, recording will be started regardless of the time set. If you set it to 5 seconds, recording will start at 5 seconds before an event occurs.
 - Post : When an event occurs, recording will continue after the time set. If you set it to five seconds, recording will continue for a further five seconds after an event is finished.
- Audio : Specify whether to record the sound received from the camera or not.

- If a channel's data transfer exceeds defined allowed limit, then it may affect to other channels, and may force switching to <KEY> recording even when the channel is configured to <FULL> recording mode. For Key Frame recording channels, the icon for limited recording appears on the live screen's top side. But if the sum of the limits is below the max limit, you can still receive the entire frames despite exceeding the permitted bitrates for each channel.
- A channel displayed in yellow indicates that the recorded data is not being transferred from the camera and that the recording is being performed temporarily using another profile on the camera. Check the channel information to see the applied profile to the channel listed in yellow. A channel displayed in orange indicates that the amount of inputted data is greater than the permitted data amount. In this case, it is impossible to record all of the incoming frames. Instead, only part of the frames (1 or 2 frames per second) can be recorded. To resolve this issue, you must set the permitted data amount to be greater than the amount of inputted data. Refer to notes on "Record status". (Page 20)

Setting the network camera's recording profile

You can configure the video profile settings for instructing the network camera (connected to each channel) to make recording.

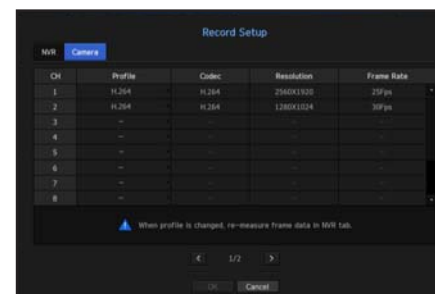

- You can configure the settings only for the profiles that are supported by the camera.
 - If the profiles used for recording and network are different, camera's video feed may not comply with the frame rate as specified in the camera.
- Profile : Select a record profile for the connected camera.
 - Codec : Show the codec information for the selected record profile.
 - Resolution : Display the resolution for the selected record profile.
 - Frame Rate : Display the baud rate for the selected record profile.

Record Option

When the HDD capacity is full, you can set whether to stop recording or start overwriting.

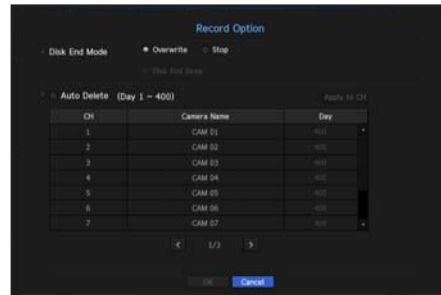

- Disk End Mode : Selects the HDD repeat recording method.
 - Overwrite : If the HDD is full, this will overwrite the existing data and keep recording.
 - Stop : If the HDD is full, this will stop recording automatically.
- Disk End Beep : If you select <Stop> for the disk end mode, this button will be active. Specify the use of beep when the HDD recording ends. If you check it, the beep will sound on the disk full and the recording stops.
- Auto Delete : If you check this option, the period list box is active. Specify the deletion period to delete any earlier data than the specified date. However, you can search for data from the current time to the selected date.
 - You can select a channel and set a different recording duration for each channel.
- Apply to CH : If you select <Apply to CH>, a confirmation dialog window is opened. Select a channel to apply the applicable settings then press <OK>. The settings will be applied to the selected channel.
 - If you press <OK> when you have completed your settings, all the existing data earlier than the specified period will be deleted automatically. So it is recommend to backup the previous data if necessary for later use.

SETTING THE EVENT

You can make the setup for record in case of sensor detection, camera event or video loss detection.

Sensor Detection

You can set the sensor's operating condition and connected camera, as well as alarm output and its duration.

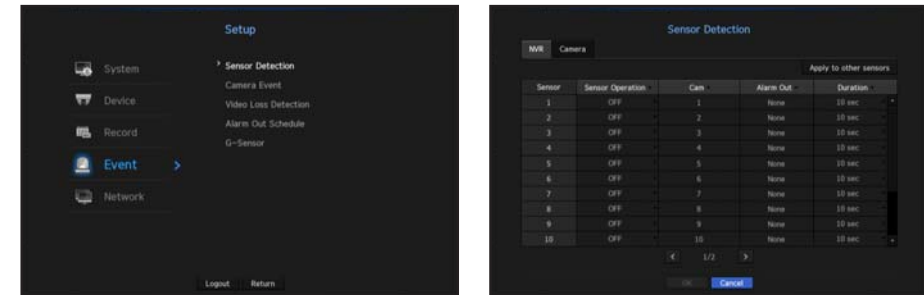

- Apply to other sensors : If you select <Apply to other sensors>, the "Apply to other sensors" confirmation window will appear. After selecting channels that the settings will be applied to, click on <OK> to apply them to the selected channels.
- Sensor Operation : Sets the operation mode of sensors.
 - In the <Camera> tab, you can set whether or not to use a sensor.
 - <N.O (Normal Open)> : Sensor is opened. If the sensor is closed, it generates alarm.
 - <N.C (Normal Close)> : Sensor is closed. If the sensor is open, it generates alarm.
- Cam : Select a channel to be connected to the sensor. If selected camera, "Cam Preset setup" window appears. Select a channel and setup the preset.
 - Preset setup can be done in PTZ mode.
- Alarm out : Sets the alarm output method.
 - For further information on alarm output, refer to "HDD Alarm > Alarm". (Page 38)
- Duration : Sets the duration of alarm signal and alarm sound.
 - If you select <Camera> tab, you can configure the sensor operation settings of the network camera connected to each channel.
 - If the connected network camera that has configured the alarm in/out settings triggers an alarm, NVR will perform the alarm out.

Camera Event

You can set the activation of events (motion detection, video analysis, audio event) sent from the camera, alarm output method and alarm time.

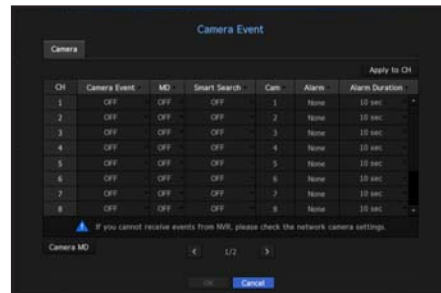

- Apply to CH : If you select <Apply to CH>, the "Apply to CH" confirmation window will appear. After selecting channels that the settings will be applied to, click on <OK> to apply them to the selected channels.
- Camera Event : Select whether to use an event detection.
- MD : Select whether or not to use motion detection from camera.
- Smart Search : Enables or disables the Smart Search option.
 - To use the smart search function, the smart search option must be set to <ON>. Refer to "Smart Search" (page 52).
- Cam : Select an event detection channel. If you select a camera item, the "Camera preset" screen will appear. Select a channel to connect and set the preset.
 - You can set the preset in PTZ mode.
- Alarm : Select the method for alarm output.
 - For more details, refer to "HDD alarm > Alarm". (Page 38)
- Alarm Duration : Set the duration of alarm.
- Camera MD : You can set the detailed setting of motion detection for a network camera connected.

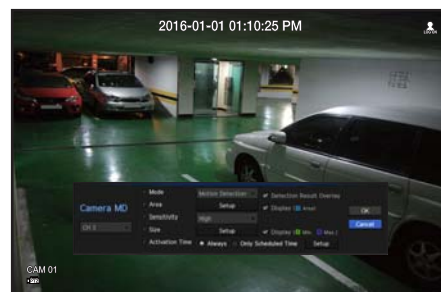

- Mode : Set the motion detection mode.
- Area : Click on <Setup> and when the detailed setup menu appears, set the motion detection area.
- Sensitivity : Set the sensitivity for motion detection. (very low/low//medium/high/very high).
- Size : Click on <Setup>. When the detailed setup menu appears, set the max/min size of the object to be detected.
- Activation Time : Select the operation time of motion detection.

After finishing with setup, click on the <OK> button to move back to the previous screen after saving the setup.

Video Loss Detection

You can set the camera so that the camera can trigger the alarm if it is disconnected or the video is lost due to unstable network connection.

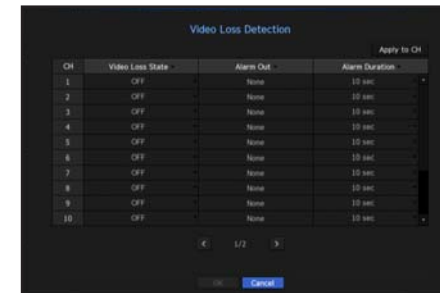

- Apply to CH : If you select <Apply to CH>, the "Apply to CH" confirmation window will appear. After selecting channels that the settings will be applied to, click on <OK> to apply them to the selected channels.
- Video Loss State : Specify the use of video loss detection.
- Alarm Out : Select an alarm output method.
 - For further information on alarm output, refer to "HDD Alarm > Alarm". (Page 38)
- Alarm Duration : Specify the duration of the alarm output with the beep.

Alarm Out Schedule

You can set the conditions and operating hours for scheduled alarms.

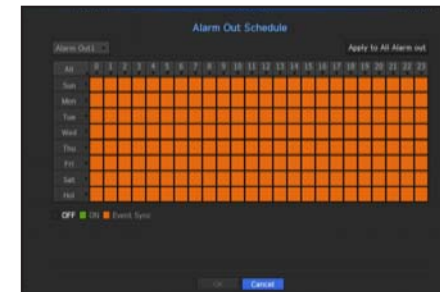

- Alarm Out : Sets the alarm output method.
 - For further information on alarm output, refer to "HDD Alarm > Alarm". (Page 38)
 - <ON> : Marked in green, and always generates alarm on scheduled time.
 - <OFF> : Marked in black, no alarm is generated even if an event occurs.
 - <Event Sync> : Marked in orange, generates alarm only when an event occurs.
- Apply to All Alarm out : Applies the configured schedule to all alarms.
 - When the alarm is generated on the scheduled time, you can stop the alarm by canceling the schedule.

G sensor

This function sets events and alarms to be generated according to vehicle movement.

- The time of occurrence can be checked in the event log. (Page 29)
- After the email setting, G sensor event occurrences can be sent. (Page 47)

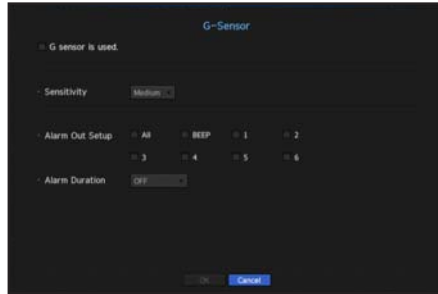

- G Sensor is used. : Checks whether G sensor is used or not.
- Sensitivity : Sets the sensitivity level (Low/Medium/High) for G sensor output. The higher the sensitivity level, the more frequent the G sensor events.
- Alarm out Setup
 - If <All> was selected, both beep sound and alarm signal through rear side ports will output.
 - If <BEEP> was selected, a beep will sound.
 - Alarm signal will output through the alarm out port on the rear side when selected <1>, <2>, <3>, <4>, <5> and <6>.
- Alarm Duration : Sets the alarm duration for the alarm signal and beep sound.



- The G sensor event does not occur if the control box is not connected to the vehicle.

NETWORK CONFIGURATION

It provides networked monitoring of Live screen from a remote place, and supports mail forwarding function with events. You can configure the network environment which enables such functions.

Interface

You can set the network connection route and protocol.

Setting a network connection

Sets the protocol and environment of the network.



- Network 1 (Camera) : Port recommended for camera connection, which receives a image from the camera.
- Network 2 (Viewer) : Port recommended for connection with a network, web viewer.
- Network 3 (Wi-Fi) : Port for connecting to external Wi-Fi. The Wi-Fi port is used for backup. (Up to 120Mbps is available.)
- Network 1 (Camera) / Network 2 (Viewer) / Network 3 (Wi-Fi) setup
 - IP Type : Select a network connection type.
 - IP Address, Subnet Mask, Gateway, DNS
 - <Static> : You can manually enter IP address, subnet mask, gateway and DNS.
 - <DHCP> : IP address, subnet mask and gateway values will be automatically set.
 - <PPPoE> : IP address, subnet mask and gateway values will be automatically set.
 - For Network 3 (Wi-Fi), the SSID is displayed above the IP address.
 - User ID, Password : If you set the connection mode to PPPoE, you need to enter "User ID" and "Password" to register in PPPoE.
- Transfer bandwidth : Enter the maximum amount of upload data bandwidth. Check the assigned setting in Connection Mode before entering your value.
 - Up to 256Mbps is available for wired networks.
- Default Gateway : Set the basic gateway by using Network1 / Network2 / Network3 setup.



- You can manually input DNS of <DHCP> and <PPPoE> when it selected to <Manual>.

Connecting and Setting the Network

Networking may differ from the connection method, check your environment before setting the connection mode.

When no router is used

• Static mode

- Internet connection : Static IP, leased line, and LAN environments allows connection between the NVR and remote user.
- NVR Network Settings : Set the <Network> in <Interface> menu of the connected NVR to <Static>.
 - Consult your network manager for IP, Gateway and Subnet Mask.

• DHCP mode

- Internet connection : Connect the NVR directly to a cable modem, DHCP ADSL modem or FTTH network.
- NVR Network Settings : Set the <Network> in <Interface> menu of the connected NVR to <DHCP>.

• PPPoE

- Internet connection : An PPPoE modem is directly connected to the NVR, where the PPPoE connection requires user ID and password.
- NVR Network Settings : Set the <Network> in <Interface> menu of the connected NVR to <PPPoE>.
 - PPPoE <User ID> and <Password> should be the same to the PPPoE user information. If you don't know the ID and password, consult your PPPoE service provider.

When a router is used

- ! ▪ To avoid IP address conflict with the NVR's static IP, check followings :

• Setting the NVR with a static IP

- Internet connection : You can connect the NVR to a router which is connected to an PPPoE/Cable modem or a router in a Local Area Network (LAN) environment.

• Setting the NVR Network

1. Set the <Network> in <Interface> menu of the connected NVR to <Static>.
2. Check whether the set IP address is in the static IP range provided by the Broadband Router. IP Address, Gateway, and Subnet Mask : Consult your network manager.
 - Check whether the set IP address is in the static IP range provided by the Broadband Router.

- ! ▪ If a DHCP server is configured with starting address (192.168.0.100) and end address (192.168.0.200), you should set the IP address out of the configured DHCP range (192.168.0.2 ~ 192.168.0.99 and 192.168.0.201 ~ 192.168.0.254).

3. Check the Gateway address and subnet mask are equal to those set in the Broadband Router.

• Setting the DHCP IP Address of the Broadband Router

1. To access the Broadband Router's configurations, open a web browser on the local PC that is connected to the Broadband Router and enter the router's address (ex : http://192.168.1.1).
2. At this stage, make the local PC's windows network configurations to the below example :
 - Ex) IP : 192.168.1.2
 - Subnet Mask : 255.255.255.0
 - Gateway : 192.168.1.1
 - Once connected to the Broadband Router, it prompts with password. While entering nothing to the User Name field, enter "admin" into the password field and press <OK> to access the router configurations.
 - Access the router's DHCP configuration menu and set its DHCP server activation, and provide the start and end address. Set the start address (192.168.0.100) and end address (192.168.0.200).



- Above steps may differ from the router devices depending on the manufacturer.

Wi-Fi Setup



1. Click the <Setup> button.
 - If the Settings button is disabled, tick the <Wi-Fi Enable> checkbox on the right.
2. Select the IP type and click the <Wi-Fi Setup> button. A list of discovered Wi-Fi networks is displayed.
3. If you select a Wi-Fi network to connect to from the list, the password input window appears.
4. Enter the password and click <OK>. Wi-Fi is connected.



- The transmission range of the wireless signal may weaken if heavy obstructions, such as concrete, brick, or metal walls are between the NVR and Router.
- If there are multiple Wi-Fi routers and devices in your environment, it may reduce the wireless bandwidth available. Weak network bandwidth may reduce the videoquality or video loss.

Port Setting

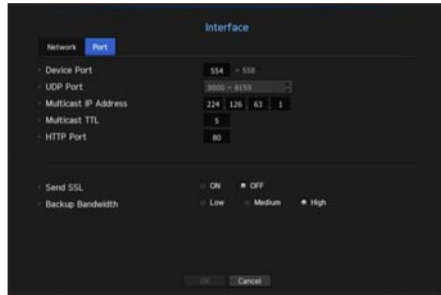

- Device Port : Enter the connectable port number. Initially, <554> is set.
 - TCP : It has better stability and lower speed when compared to UDP, and recommended for internet environments.
- UDP Port : Initially, <8000~8159> is set. It increases / decreases by 160.
 - UDP : It has less stability and faster speed when compared to TCP, and recommended for local area network (LAN) environments.
- Multicast IP Address : User can directly input.
- Multicast TTL : Select from 0 ~ 255. Initial value for the TTL is set to <5>.
- HTTP Port : Enter the port number for the Web Viewer. Initially, it is set to <80>.
- Send SSL : Select this option to send SSL.
- Backup Bandwidth : Select the degree of backup bandwidth.

DDNS

If a remote user accesses the network, you can set whether or not to use DDNS and the site to be connected.

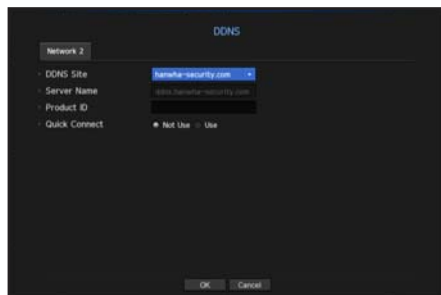

- DDNS Site : Specify the use of DDNS and select a site that you registered.
- Server Name : Provide the host name that you registered with the DDNS site.
- Product ID : Provide the user ID that you registered with the DDNS Site.
- Password : Provide the password that you registered with the DDNS site.
- Host Name: Enter the host name registered on the DDNS site.
- User Name: Enter the user name registered on the DDNS site.

- ✍ Refer to "Using Virtual Keyboard". (Page 26)
 - If you select <OFF>, the input box will be inactive.
 - If you select <hanwha-security.com>, the host name input box will be inactive.

- Quick Connect : Select whether or not to use. To use the function, set to <Use> after connecting the NVR to a UPnP router.

- ✍
 - If canceled during Quick Connect configuration, it automatically switches to <Not Use> and saved.
 - If you are setting a port that is already in use, the connection may not be established. Check the port setting of the router.
 - The server name, manufacturing ID, and quick connect appear when <DDNS site> is selected as <hanwha-security.com>.

To check Quick Connect status

A progress bar and its message appears for a Quick Connect.

- **Quick Connect Success** : Message for a successful connection.
- **Invalid Network Configuration** : Message appears if the network configuration is not valid. Check the configuration.
- **Please enable UPnP function of the router** : Message appears if the router requires UPnP function enabled.
- **Failed to find the router** : Message appears if the router is not found. Check the router's configurations.
- **Please restart the router** : Message appears if the router should be restarted.

DDNS Setting

DDNS is a short form of Dynamic Domain Naming System.

DNS (Domain Name System) is a service that routes a domain name consisting of user friendly characters (ex : www.google.com) to an IP address consisting of numbers (64.233.189.104).

DDNS (Dynamic DNS) is a service that registers a domain name and the floating IP address with the DDNS server so that the domain name can be routed to the IP address even if the IP is changed in a dynamic IP system.

• Setting DDNS in the NVR

Set <Protocol Type> in the <Protocol> menu of the connected NVR to the following :

Ex) Protocol Type : TCP

Port (TCP) : 554, 555, 556, 557, 558

DDNS Site : hanwha-security.com

• DDNS Settings of the Router

Select the corresponding menu for the network transfer protocol of the router.

• Setting up UPnP of Router

Refer to the router's documentation to enable the UPnP function of the router.

IP Filtering

You can prepare the list of IP addresses to allow or block access to a specific IP address.

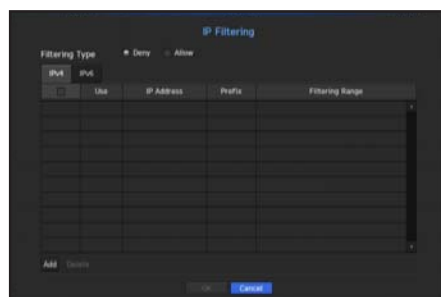

- Filtering Type :
 - Deny : If you select reject, access to the registered IP address will be limited.
 - Allow : If you choose permit, then they can only access the registered IP addresses.
- Use : Select the checkbox for the IP address that will use IP filtering.
- IP Address : Enter the IP address for filtering.
- Filtering Range : If you enter an IP address or prefix, then the range of IP addresses blocked or permitted will be displayed.

! If a camera's IP address is not included in the Permit list or is in the Reject list access to it will be rejected.

SSL

You can select a security connection system or install public certificates.

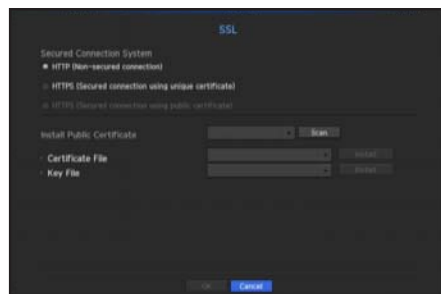

- Secured Connection System : You can select a type of security connection system.
 - HTTP (Non-secured connection)
 - HTTPS (Secured connection using unique certificate)
 - HTTPS (Secured connection using public certificate)

! If the NVR device is connected to the external internet or installed in an environment with high priority for security, making a secure connection is recommended.

- Install Public Certificate : You can scan and register public certificates to be installed. If you want to use a certificate, you need to install a certificate file along with and an encryption file.
 - The <HTTPS (Secured connection using public certificate)> menu can be selected only if there is a registered public certificate.

802.1x

When connecting to a network, you can select whether to use the 802.1x protocol and install a corresponding certificate.

802.1x is a certificate system for the server and the client. It can guarantee robust performance against hacking into the Tx/Rx network data, virus or information leaks.

By using this system, you can block access from a client who is not certified and only allow communication to certified users and thus increase the level of security.

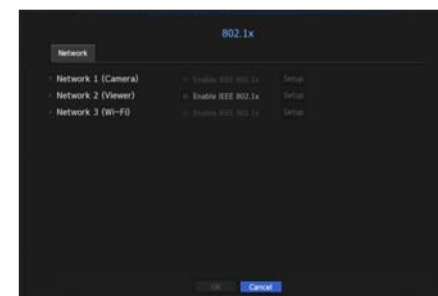

- EAPOL Version : Select the EAPOL version to be used as protocol.
 - Some switch hubs will not operate if you set them to version <2>. Select version <1>.
 - ID : Enter the ID provided by the RADIUS server administrator.
 - If the entered ID does not match the ID of the client's certificate, it won't be processed properly.
 - Password : Enter the password provided by the RADIUS server administrator.
 - If the password you entered does not match that of the client's private key, it won't be processed properly.
 - Certificates : Search for a device. Click on <Rescan> to search for a device again.
 - CA Certificate : Select this only if your public certificate includes the public key.
 - Client Certificate : Select if the public certificate includes a client's authentication key.
 - Client Private Key : Select it if the public certificate contains the client private key.
- ✍
- For successful implementation of the 802.1x operating environment, the administrator must use the RADIUS server. In addition, the switch hub connected to the server must be a device that supports 802.1x.
 - If the time setting of the RADIUS server, the switch hub and an NVR device do not match, communication between them can fail.
 - If a password is assigned to the client's private key, the server administrator should confirm the ID and password. The ID and password allow up to 30 characters each. (But it only supports letters, numbers and special characters ("-", "_", ".") 3 types) only. Accessing non password-protected files is allowed without entering a password.
 - The 802.1x protocol adopted by the NVR is EAP-TLS.
 - You need to install all three certificates to use 802.1x.
 - <Enable IEEE 802.1x> When this option is deselected, the disconnection may not work depending on the settings of the switch hub connected. Configure settings to let switch hub update the authentication at regular intervals.

Live Streaming Setting

You can set the video profile to be transmitted to the network.



- Profile : Select a network profile for the connected camera.
- Codec : Show the codec information for the selected network profile.
- Resolution : Display the resolution for the selected network profile.
- Frame Rate : Display the baud rate for the selected network profile.

- If the profiles used for network and recording are different, camera's video feed may not comply with the frame rate as specified in the camera.

E-mail

You can send an e-mail to a NVR-registered user at a specific time interval, or if an event occurs.

SMTP Setting

Sets the SMTP mail server.

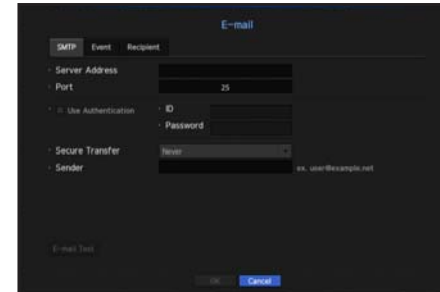

- Server Address : Enter the SMTP server address to connect to.
- Port : Sets the communication port.
- Use Authentication : Check this if the SMTP server uses user authentication. The account input box will be activated.
- ID : Enter a ID to use authentication when connecting to the SMTP server.
- Password : Enter the password of the SMTP server user.
- Secure Transfer : Select one from <Never> and <TLS (if available)>.
- Sender : Use the virtual keyboard to enter the sender's e-mail address.
 - Refer to "Using Virtual Keyboard". (Page 26)
- E-mail Test : Conducts the test on the server settings.

Event Setting

You can set the interval and type of the event that will be sent to the user.

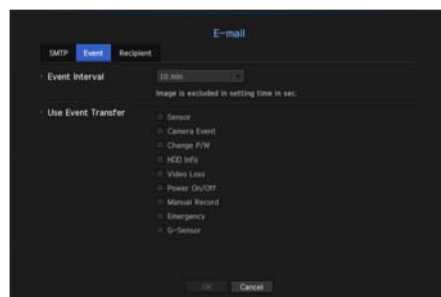



- Event Interval : Set the event interval.
 - If a series of events occurs, the e-mail will be sent at the specified interval, not on each event.
- Use Event Transfer : Select an event type to send if an event occurs.
If the selected event occurs, the e-mail will be sent to the group that has the recipient authority.

Recipient Setting

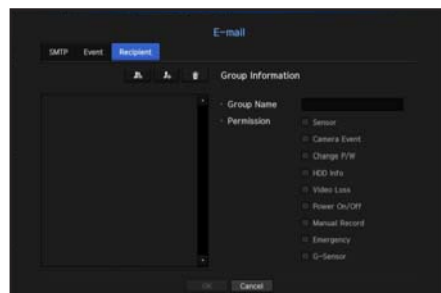
You can create a group and add users to it or; you can delete users and change a group.



- Click on <  > to add a group.
Select a group name and the privilege.
- Select a recipient group to receive emails.
If a group is added, it will appear in the group list.
- Click on <  > to add a recipient.
Select a group and enter names and email addresses.
If a group is created, you can add a recipient.
 - For inputting the recipient name and email address, refer to "Using Virtual Keyboard". (Page 26)

SNMP

Using the SNMP protocol, the system or network administrator can monitor the network devices remotely as well as the operating environment.



- Enable SNMP v1 : SNMP version 1 is used.
 - Enable SNMP v2 : SNMP version 2 is used.
 - Read Community : Enter the name of read-only community to access the SNMP information. By default it is set to <private>.
 - Write Community : Enter the name of write-only community to access the SNMP information. By default, it is set to <public>.
 - Enable SNMP v3 : SNMP version 3 is used.
 - Password : Set the initial user password for SNMP version 3.
 - Enable SNMP Traps : SNMP trap is used to send important events and conditions to the Admin System.
 - Trap Manager : Enter the IP address to which messages will be sent.
- ! ■ SNMP v3 can be set only if the security connection method is set to HTTPS mode. Refer to "SSL" for more details. (Page 46)

DHCP Server

You can set the internal DHCP server and assign an IP address to the network camera.

Network Setting

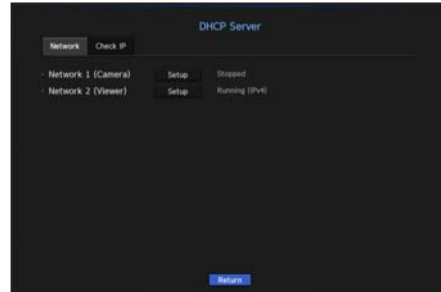

- Network 1/2 : Select <Setup>, and you can set the IP range operated by the server and time.

To set the DHCP server

1. On the DHCP Server Setup window, click <Setup>.
2. Select <Run> in the <Status> field.
3. Enter the starting IP and end IP in the <IP Range> field.
4. Fill in the <IP Lease Time> field.
5. Click <OK>.
 - The IP range entered is set as the DHCP server address of the network.

Check IP

You can check the IP Address and Mac currently used through the DHCP server, and the connected network port.



- Network : Select the network port to check the information on IP and others.

MTS

Vehicle information, real-time location, events and video are transmitted to SSM-MTS (Mobile Tracking System).

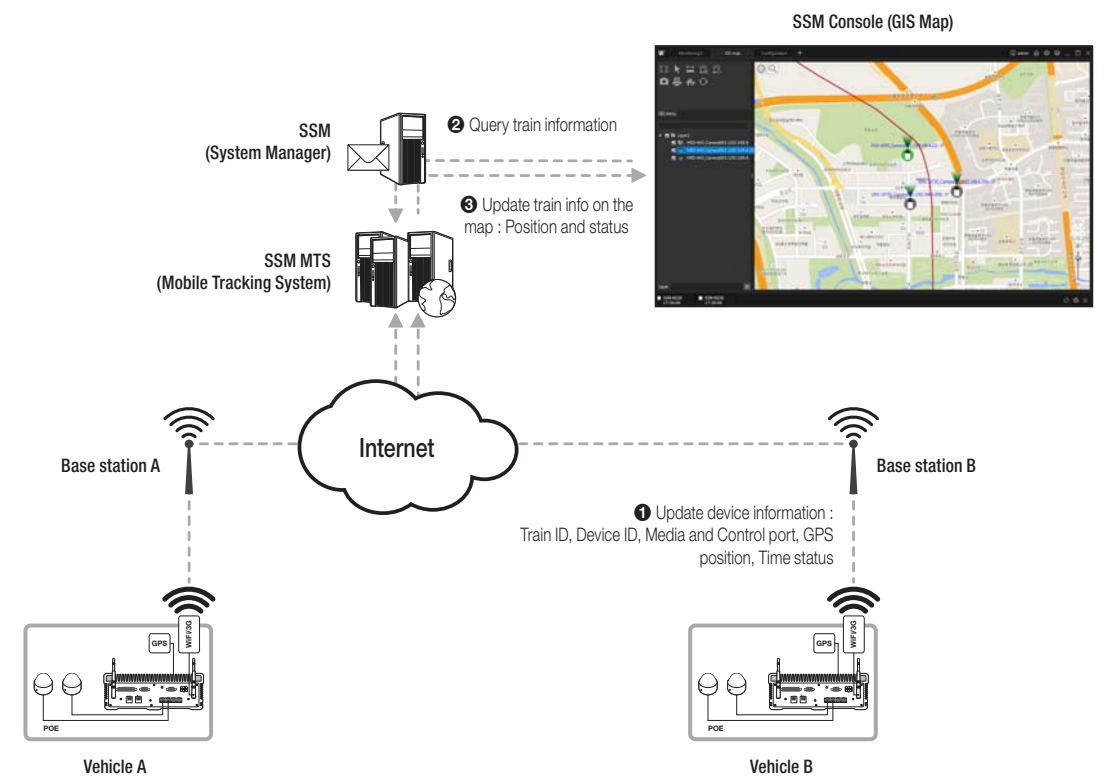

MTS

Sets the MTS server address and whether tracking, event notification, and JPEG push are enabled.

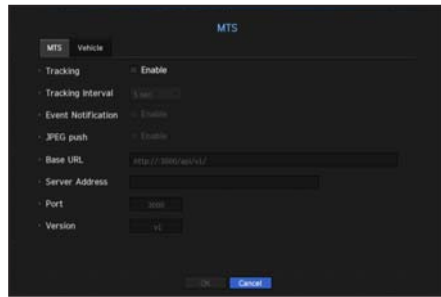

- Tracking : Chooses whether or not to send location.
- Tracking Interval : Selects the location transmission interval.
- Event Notification : Selects whether to send events.
- JPEG Push : When live monitoring is requested from a remote site, the video is transmitted in JPEG format. The fps and resolution of the transmitted video follow the settings of the first profile (MJPEG) of a selected channel on transmission request.
- Base URL : The MTS server address configured when <server address>, <port>, and <version> are entered.
- Server Address : The URL of the MTS server.
- Port : The port number of MTS.
- Version : Enter the communication protocol version of MTS.

- Operates only when NVR is registered in MTS. If the information is not being delivered even though the NVR was registered, check the default URL.
 - If no location information is received at system startup, the latitude and longitude are delivered as 0 degrees, 0 minutes, and 0 seconds.
 - If the location information reception is lost, the last received location information is transmitted.
 - Only cameras that support SUNAPI provide the JPEG push function.

Vehicle

Sets the vehicle information to be transferred to MTS.

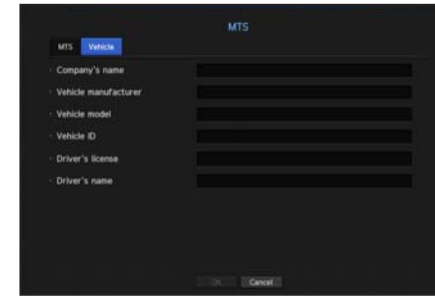

- Company's name : Enter the company name where the vehicle is registered.
- Vehicle manufacturer : Enter the manufacturer name of the vehicle.
- Vehicle model : Enter the vehicle model.
- Vehicle ID : Enter the license plate number.
- Driver's license : Enter the driver's license number.
- Driver's name : Enter the driver name.

SEARCH

You can perform the search for recorded data by the time or by the search criteria such as an event. You can access the **<Search>** menu directly in Live mode.

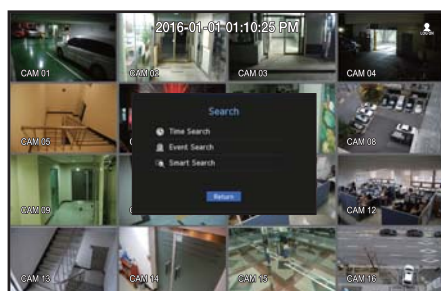

1. In live mode, right click with your mouse button. The Live menu appears.
2. Select **<Search>**.
3. The Search menu should appear.
4. The search can be restricted by the Auto Delete function. Refer to "**Setting the Recording > Record Option**". (Page 41)

- Overlapped data : It only appears if there exists overlapped data on a certain time, produced due to the change of NVR's time setup. The latest data comes first, from **<List0>**.
 - The search time is based on the time specified by NVR.

Time Search

You can search for recorded data of a desired time. The displayed time is based on the local time zone and the daylight saving time (DST). Therefore, data recorded at the same time from different areas may differ based on the time zone and the DST.

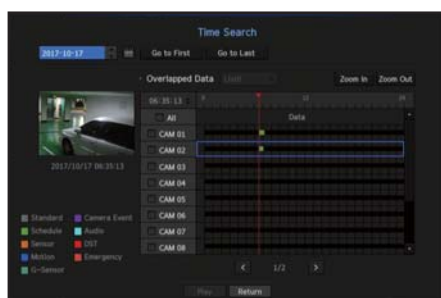

1. Select **<Time Search>** in the **<Search>** menu.
2. In the date selection window, click on the **< >** button to select a search date.
 - For using the calendar, refer to "**To use the calendar**". (Page 25)

3. The record data on the specific date will be listed. The display bar is different according to the data type. So check the data type for the color in the left pane.

- If DST (Daylight Saving Time) is configured, overlapping multiple recordings may be produced for a certain moment of time. Such a time section is distinguished with red color to mark DST section.

- Go to First : Move to the earliest recording date.
 - Go to Last : Move to the latest recording date.
 - Time : Enter a time to perform the search or use the up/down button **< >** to select one.
 - Zoom In : The map enlarges in detail. It will switch in the sequence of 24hours - 12 hours - 6 hours - 2hours - 1 hour.
 - Zoom Out : The map will switch in the reverse order of the detailed mode above. It will switch in the sequence of 1hour - 2 hours - 6 hours - 12 hours - 24 hours.
 - Preview : Click **<Channel>** and select (click, drag) a time in **<Duration>** to display a still image for the portion.
 - If the selected channel does not contain any recorded data, it will be marked black.
4. Select a data item and click **<Play>**. The screen switches to the data playback mode.

Color indications depending on current recording status

The recorded data types are represented through the use of different colors. Each color corresponds to a certain recording type.

Event Search

You can search for events by the channel and play them.

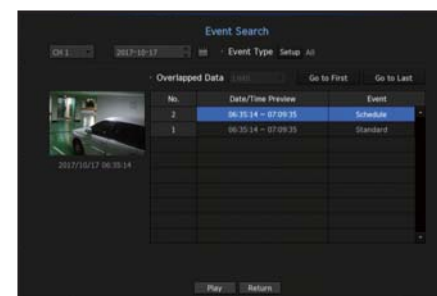

1. Select **<Event Search>** in the **<Search>** menu.
 2. Configure the channel, search date and event type settings.
 - Only recordings corresponding to the selected event type are searched.
 - Date/Time Preview : If you select a data item in the list, the still image of the selected data will be displayed in the left preview pane.
 - Event : Displays the type of the event that occurred.
3. Select a data item and click **<Play>**. The screen switches to the event data playback mode.

Smart Search

You can select a specific area of the image as an area of interest or exclusion using a virtual line to perform a search of events that have occurred in a specific time period.

- To perform smart search, the **<Smart Search>** option in **<Camera Event>** should be turned **<ON>** and the camera motion event option must be set to the entire area (page 42).

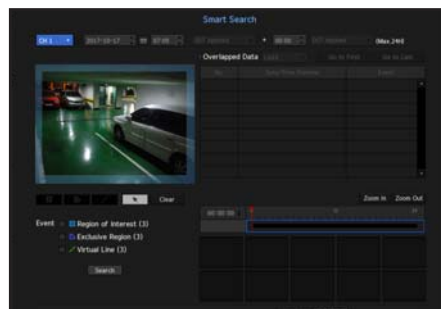

1. In the **<Search>** menu, select **<Smart Search>**.
2. Configure the channel, search date and time settings.
 - Go to First : Moves to the oldest smart search result.
 - Go to Last : Moves to the most recent smart search result.
 - Event : Displays the type of event generated.
 - Region of Interest : The entire screen is set as a non-detection area and a specific area designated as a detection area. Click and drag on the image or select 4 vertexes to designate a desired detection area.
 - Exclusive Region : The entire screen is set as a detection area and a specific area designated as a non-detection area. Click and drag on the image or select 4 vertexes to designate a desired non-detection area.
 - Virtual Line : Detects a motion towards a marked direction based on the virtual line. At a desired position on the screen, click or drag the start point and end point of the line.
 - Up to 3 areas of interest, areas of exclusion and virtual lines can be set, respectively.
3. Click the **<Search>** button.
 - Search results displayed include a list, timeline and thumbnail.
 - When you double-click a list or thumbnail displayed as search results, the applicable data can be played back.
4. Select data to play and click **<Play>**.
Moves to the playback screen for the data searched.

PLAYBACK

Play

You can play data stored in the HDD and backup a desired portion of the data.

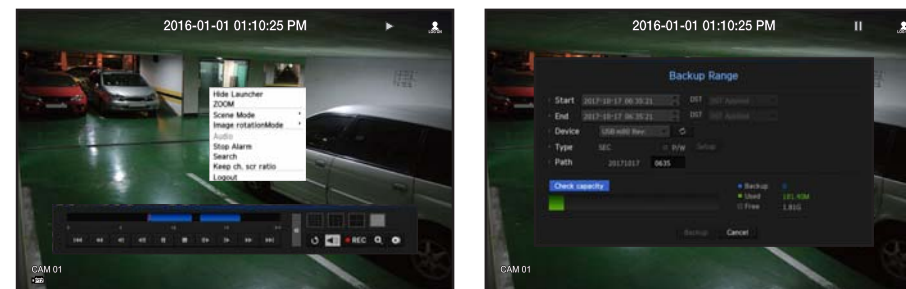

1. In the live screen menu, select the **<Play>** menu or click on **<▶>** in the launcher menu.
2. Select a menu for searches.
 - If this is the first time you try to play, you will start with the data search window. For data search, refer to **"Search"**. (Page 51)
3. Select a data item and click **<Play>** in the Search menu.
The selected data is played and the play launcher appears on the screen.
 - If there is an existing data, **<Play>** will start immediately without performing the search.
- Playback Information : Displays the date and time of the current data in the top corner.
- Backup : Click **<⏮>** to set the current time to the start time of backup; you can specify a backup area using the mouse (yellow triangle).
Click **<⏭>** again to set the current time to the end time of the backup and the **"Backup Range"** window appears.
 - Type : Supports formats of NVR and SEC.
 - Device : Select a backup device.
 - Check Capacity : Enables you to check the capacity of the selected storage device.
4. If you want to go back to the live screen during plays, then click on **<■>** of the launcher menu.

Checking menu while playing a video

1. Right-click on the play screen.
Screen menu appears on the play screen.
2. Select a menu to run.
For more information about each menu, please refer to the **"Split Mode Menu"**. (Page 17)

- Rotate mode only appears in single screen mode. You can rotate the play screen by 90 degrees.

Using the Playback Button

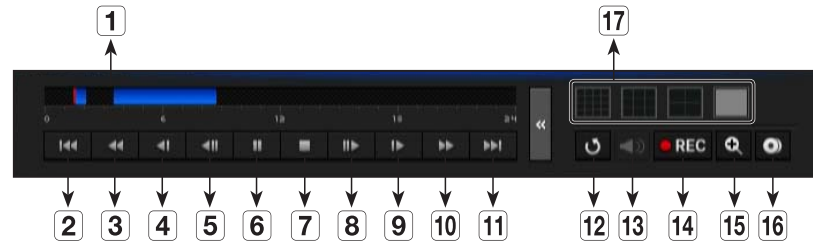

Name	Description
1 Play Timeline	Indicates the current playback point, and can be used to move.
2 Skip Backward	Moves backward by unit time.
3 Backward Fast Play	Used for quick backward search while in Play.
4 Backward Slow Play	Used for backward frame-by-frame search while in PAUSE.
5 Step Backward	Moves backward by one frame at a time.
6 Pause	Stops playing the current video temporarily.
7 Stop	Stops playback and moves to the live screen.
8 Step Forward	Moves forward by one frame at a time.
9 Forward Slow Play	In a split mode, the real time playback may not be supported, depending on the record quality, resolution and number of channels. And some frame rates may be supported.
10 Forward Fast Play	Used for quick forward playback.
11 Skip Forward	Moves forward by unit time.
12 Return	Return to the search setup screen.
13 Audio	Sets Audio ON/OFF.
14 REC	Records all channels in Live mode.
15 ZOOM	This is available in Single mode, which will enlarge the video from a selected channel. To cancel the zooming, simply double-click the enlarged image or select <Close Zoom> in the Live screen menu.
16 Partial Backup	Begins backup of the selected section of the video being played, with the specified starting/ending point.
17 Mode Switch	Click on a desirable play mode to change the screen segmentation mode.

starting web viewer

WHAT IS WEB VIEWER?

WebViewer is a software program with which the operator can access a remote NVR (Network Video Recorder) for real-time monitoring, PTZ control (if configured) or search.

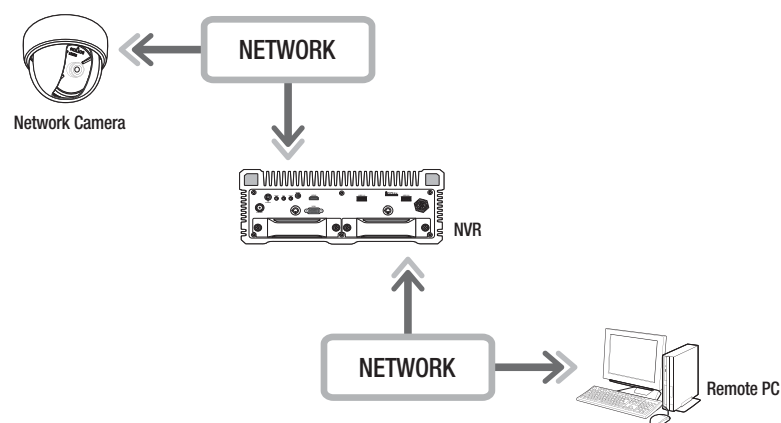

Product Features

- Remote connection using the browser
- PTZ camera control enabled
- 4:3 mode : supports 1, 4, 9, 16, 1+5, 1+7, 1+12, 1+9, 1+11, and 2+8 channels (up to 16 cameras)
- 16:9 mode : supports 2, 3, 6, 12, and 20 channels (up to 16 cameras)
- Saving function in JPEG/BMP/PNG image format for printing and storage.
- Record video in AVI format-compatible with popular media players. (The integrated codec is needed)
- To play the video in Windows Media Player, you must download and install the relevant codec from www.windows7codecs.com. (version 4.0.3 or higher)

System Requirements

The following lists the minimum suggested hardware and operating system requirements needed to run the Web Viewer.

Item	Minimum	Recommended
CPU	Intel Core 2 Quad 2.5GHz or higher	Intel i7 (3.5GHz) or more
RAM	3GB or more	4GB or more
HDD	200GB or more	500GB or more
VGA Memory	512MB or more	1GB or more
Display Resolution	1280 x 1024 or higher	
OS	- Supported OS : Windows 7, 8.1, 10, Mac OS X 10.9, 10.10, 10.11 - Plug-in free web viewer Supported web browsers : Google Chrome 47, MS Edge 38 - Plug-in Webviewer Supported web browsers : MS Explorer 11, Apple Safari 9 ※ Mac OS X only	
Network	10/100/1000 Ethernet NIC	

- It is recommended to install the latest version of graphic driver.

CONNECTING WEB VIEWER

1. Open your web browser and type the IP address or URL of NVR into the URL address box.

- Accesses the web viewer by connecting to Network 2 (recommended).
- "192.168.2.200" is set to IP by default.
- You must have specified the IP address in "Network > Interface".
- The URL connection will be enabled only when the DDNS connection settings have been completed. For more information, refer to "Network Configuration > DDNS". (Page 45)

2. A user with the admin permissions should provide the admin ID and password. A registered user should provide the user ID and password.

- All settings are applied according to the NVR settings.
- To log in with a different ID, quit your Internet browser and log back in.
- The initial ID and password for webviewer is "admin" and "4321". When an initial password is entered, while partially resetting to access a web viewer, a pop up window will appear that will guide the user to change the password and when doing a whole reset to access a web viewer, a pop up window will appear that will guide the user to complete the settings for the Install Wizard. Set a new password when a pop up window appears.
- Please change your password every three months to safely protect personal information and to prevent the damage of the information theft. Please, take note that it's a user's responsibility for the security and any other problems caused by mismanaging a password.



- It allow s up to 10 simultaneous access including the Admin and general users.
- Password of the Admin and general users can be changed in <User> menu of the NVR.
- Normal users should have set <Webviewer> under <Restriction on Network Access> to Use before connecting to the Web Viewer. (Page 27)
- All settings are applied by the NVR's settings.

3. The plugin installation confirmation pop-up window will appear.



4. When a program installation wizard window appears, press the [Install] button to install the program.
 - The version of the program installed may vary depending on the update version.
5. When program installation is complete, click on the [Finish] button.
6. After completing installation and successfully logging in, the main live viewer screen appears.

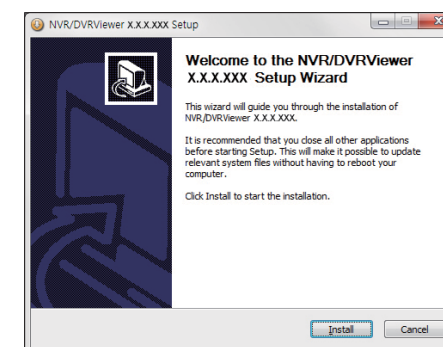

If you want to access the web viewer with multiple browsers

Set auto execution of plugin (npNVRViewer) in the browser menu that you first access and refresh the screen after activating the plugin or selecting plugin reliability.

- Each time the browser is upgraded in the future, the plugin activation method can be changed. Plug in setting menu can be referred to in the browser manual.
- On a browser in the latest version that does not support plug-ins, please refer to the descriptions about the plug-in free web viewer stated below.

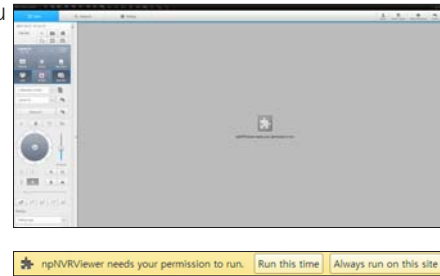

Accessing the Plug-in Free Webviewer from a web browser

Internet browsers that do not use plug-ins will automatically connect to the plug-in free web viewer. (e.g.: Chrome, Edge Browser)

- As the plug-in free webviewer has lower performance than the plug-in webviewer, it has a limit on the monitoring of high quality profiles. To monitor high quality profiles, use either a plug-in webviewer or network Viewer.

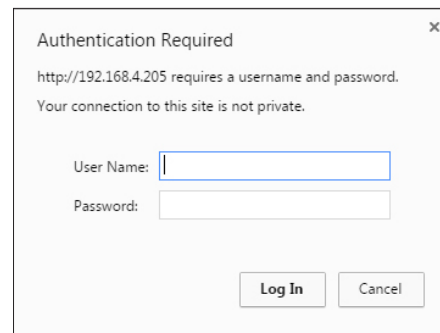

< Chrome, Edge Browser >

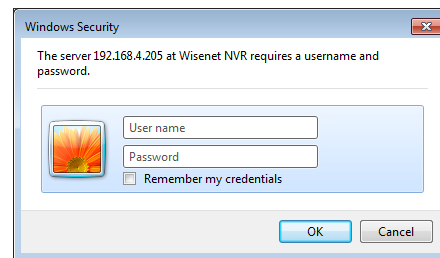

< Internet Explorer >

Live viewer screen layout

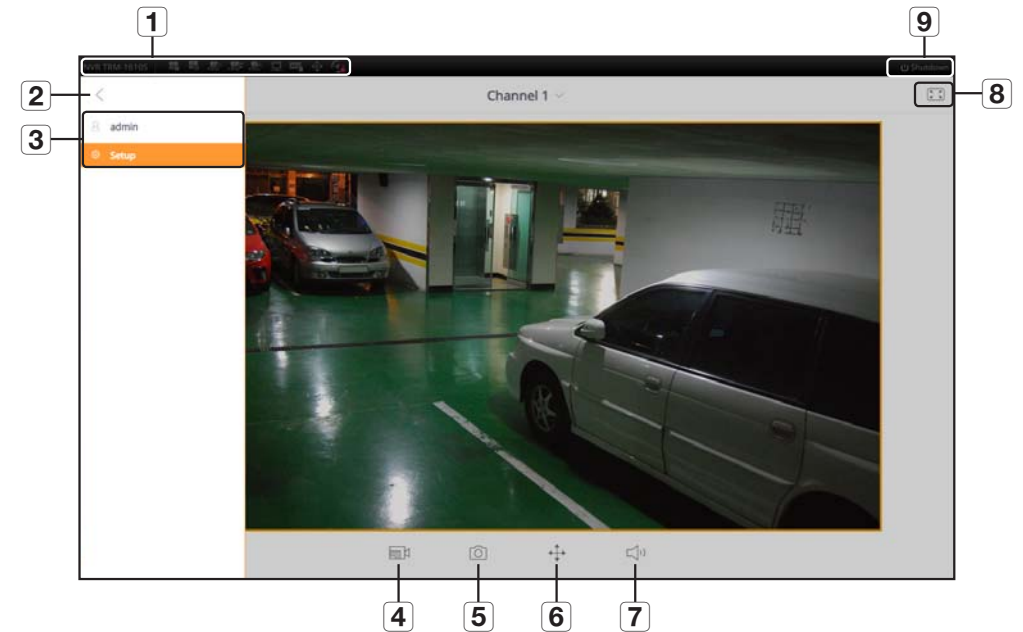

Menu	Description
1 System Status Display	Displays icons that indicate the screen state of system status. <ul style="list-style-type: none"> For more information about each icon, please refer to "System Status". (Page 57)
2 View Menu	Enables or disables View Menu.
3 Select Menu	Displays the user login ID and moves to the setup page. <ul style="list-style-type: none"> The way that you configure settings is identical to the existing web viewer settings. Please refer to <Setup Viewer>. (Page 65)
4	Changes the camera profile.
5	Captures the current video and saves it in a designated path.
6	Supports the PTZ Digital Zoom function.
7	Turns the sound ON/OFF.
8	Changes the aspect ratio.
9 Shutdown	Turns off the power of the NVR system.

- Plug-in Free Webviewer only supports a single split live screen. However, output of only up to 720p resolution is available. Resolution exceeding 720p will not be displayed. (Exception - H.265 codec is not output if the resolution and frame rate exceed 720P 26fps.)
- You can change the live screen by selecting <Channel 1>.

LIVE VIEWER

You can check the video from camera registered in the NVR connected from a remote PC. Also, you can adjust the camera and check the network transfer status.

Live Viewer Screen

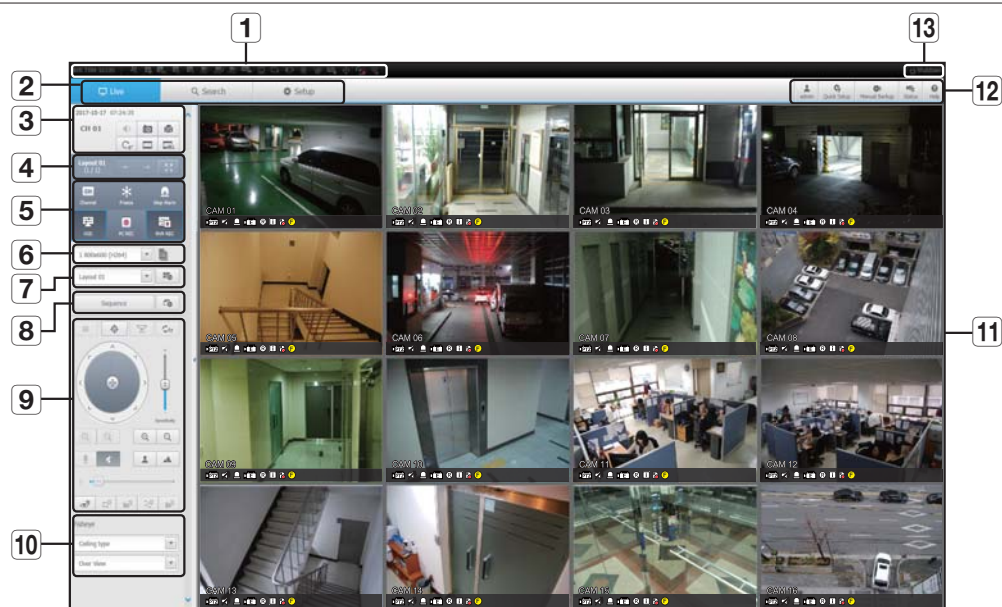

Menu	Description	
1 System Status Indicator	Displays icons to display the screen or system status.	
2 Menu Selection	Switches into corresponding menu screen by clicking each menu.	
3	Date/channel	Shows the access date/time and the selected channel.
	Sound	Sets the sound connected to each channel to either ON/OFF.
	Capture	Saves current video for the selected channel in the path designated by the user.
	Print	Prints current video image for the selected channel through designated printer.
	Rotate Video	Rotates the screen of a selected channel by 90 degrees.
	Keep ch. scr ratio	Changes screen ratio of the selected channel.
	Keep full scr ratio	Changes screen ratio for all channels.
4	Channel change	Switches to the previous/next channel group.
	Full screen	Switch from the full screen to the split screen. Press the [ESC] key on the keyboard to exit full screen mode. <ul style="list-style-type: none"> Safari for Mac does not support full screen mode.

Menu	Description	
Channel information	Shows the channel information selected. <ul style="list-style-type: none"> If the user's PC monitor does not support 60Hz at a specific high resolution, or the HDMI cable does not support HDMI 2.0, 60fps or higher will not be output from the channel information. 	
Pause	Temporarily stops the videos in all the channels or deactivates the Pause function in suspending status.	
5 Stop Alarm	Deactivates an alarm when it occurs.	
OSD	Check the OSD item to display the OSD screen information in the web viewer window.	
PC recording	Saves the real-time video, in AVI format, from the selected channel in a designated folder on the PC.	
NVR recording	Start and stop NVR recording.	
6 Profile selection	Sets a desired profile for each channel.	
7 Layout setting	Set the layout.	
8 Switching	Set the sequence.	
9 PTZ	Controls connect PTZ camera(s).	
10 Fisheye	Runs the fisheye settings for the selected channel. (Configures the mounting mode and the view mode to correct the screen distortion.)	
11 Display Pane	ID	Display the ID of user connected.
	Quick setup	Simple camera registration and recording settings.
	Manual backup	Manually backup the video of the camera connected.
	Status	Shows the camera live and recording status.
	Help	Move to the help window.
13 Shutdown	Turn off the NVR system.	

LIVE SCREEN CONFIGURATION

System Status

You can check the status or operation of the NVR with the icons on the live screen.

- On a plug-in free web viewer, the status information icon is not displayed.



Item	Description
	It is displayed when there is a problem with the fan.
	It is displayed when there is an issue with the recording conditions.
	Displayed if the HDD is full and the NVR has an insufficient space to record.
	Displayed if no HDD is installed or the existing HDD should be replaced.
	Displayed if the HDD needs a technical examination.
	It is displayed when there is a malfunctioning HDD in the RAID. <ul style="list-style-type: none"> There are one or two HDD malfunctions but you can still read or write to it.
	It is displayed when recovering a RAID Error.
	It is displayed when you cannot write RAID due to a malfunction of HDD.
	It is displayed when the max permitted amount of data for each channel is exceeded.
	It is displayed when the network is overloaded. It is displayed when the network is overloaded. <ul style="list-style-type: none"> It occurs when the max receiving performance is exceeded, causing an overload to the CPU. It will disappear if you modify the camera setting or delete a camera to reduce the level of performance overload.
	It is displayed when there is firmware to update the server. It is displayed when there is firmware to update the server.
	Displayed when the battery that enables time information to be saved in the NVR equipment is empty.
	If you press the screen stop button, it is displayed.

Item	Description
	It is displayed when all the channels are switched at the set time interval.
	Appears when emergency recording is in progress.
	Shows the vehicle shake state.
	Shows GPS reception/no reception.
	Displays the Wi-Fi connection status when <Wi-Fi Enable> is set.

To capture a screen

- Click < > button.
When a pop-up window appears, select the saving path for captured image.
- Select the path and name the file. And then click the <OK> button.
- Save current camera's video image as .bmp, .jpg or .png file.

- If the viewer is running without the administrator's permission in Windows 7, you may not save the captured image as .bmp, .jpg or .png file.

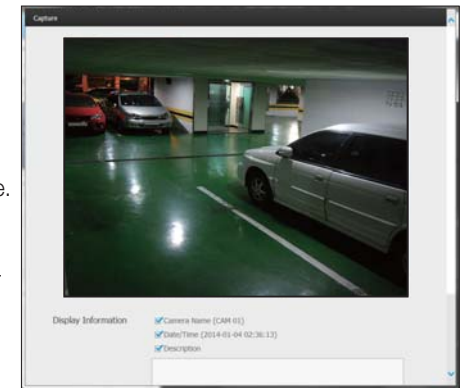

To print a screen

- Click < > button.
- Print current camera's video image with the printer connected to the PC operating the Web Viewer.

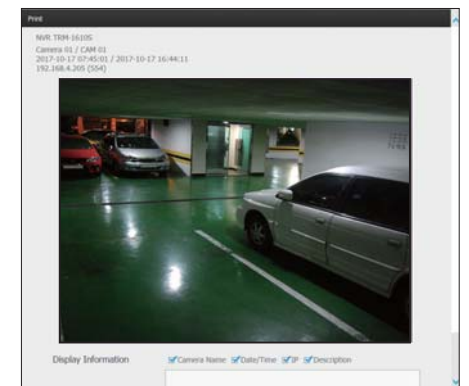

How to choose a profile

You can select a desired profile for each channel.

1. Multi-split screen is connected to profile 1 by default.
2. One-split screen is connected to profile 2 by default.
3. The user can change the profile through selection.
 - PC performance or network bandwidth may cause problems such as lack of connection or poor video output.

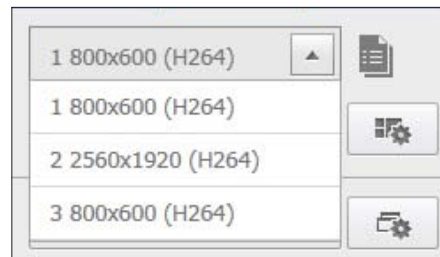

Setting the layout

If you don't add or save it in the layout after registering a camera, the live screen will not be displayed.

Click on the < > button to launch the layout setting screen.

If you want to add a layout

Click on < >.

Set the layout name to add and click on the <OK> button to add it.

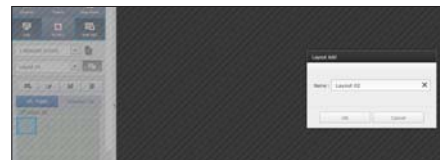

If you want to change the layout name

Select the layout name to change and click on < >.

After changing the name, click on the outside of the layout window to change the name.

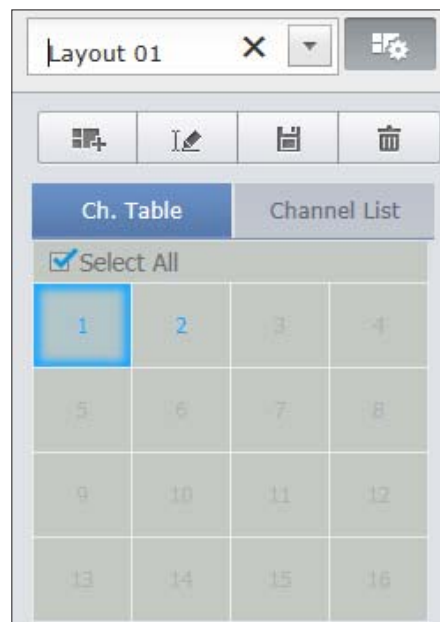

If you want to save the layout

Click on < >.

The changed layout will be saved.

- The layout for each user is saved separately.

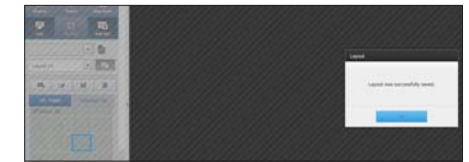

If you want to delete the layout

After selecting the layout to delete, click on < >.

The selected layout will be deleted.

- Unless you press the Save or Delete button, changes will not be saved.

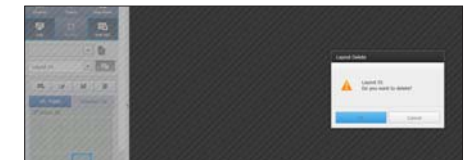

Changing Split Mode

When clicking the Split Mode selection button, the screen is changed into the selected split mode.



Setting screen switching

If you don't register the layout, the screen switching function will not operate.

You can view the layouts one by one.

Click on the <  > button to launch the switching setting window.

1. Select the layouts to be shown in turn by pressing <  >.
2. Enter the screen switching time.

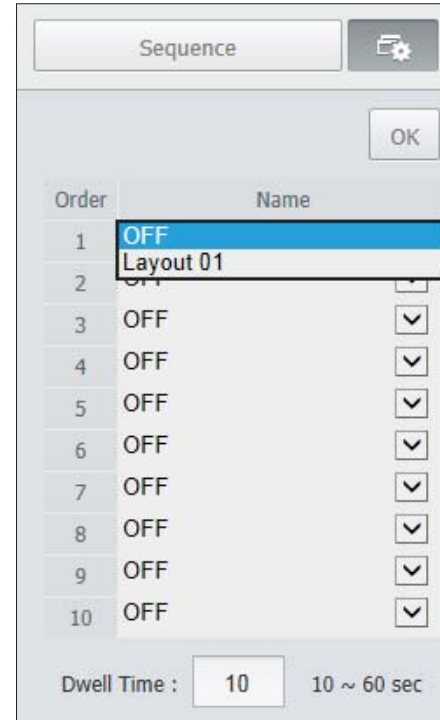

3. Click on the <OK> button to save the designated sequence.

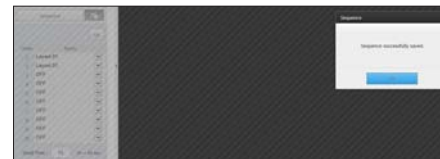

To perform switching

Click on the <Sequence> button to activate the switching mode and run a sequence.

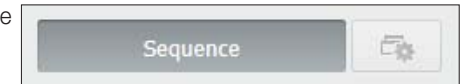

Auto Sequence

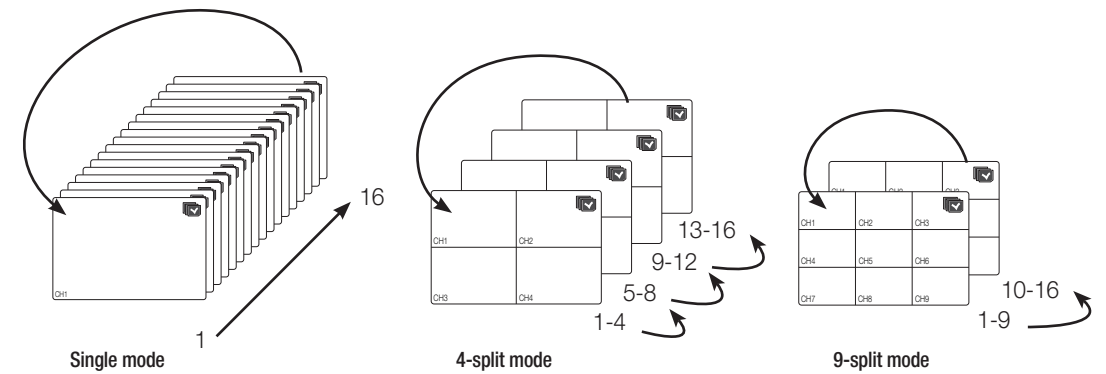

- In a split mode, if you have set <Sequence switching time> in "Device > Monitor", Auto Sequence will be conducted at the set interval. (Page 39)
- When switching to another channel, the video may be slightly delayed depending on network status.
- If you perform automatic switching of a single screen, the layout setting menu will be deactivated during operation.

CONTROLLING A CONNECTED NETWORK CAMERA

Controlling PTZ

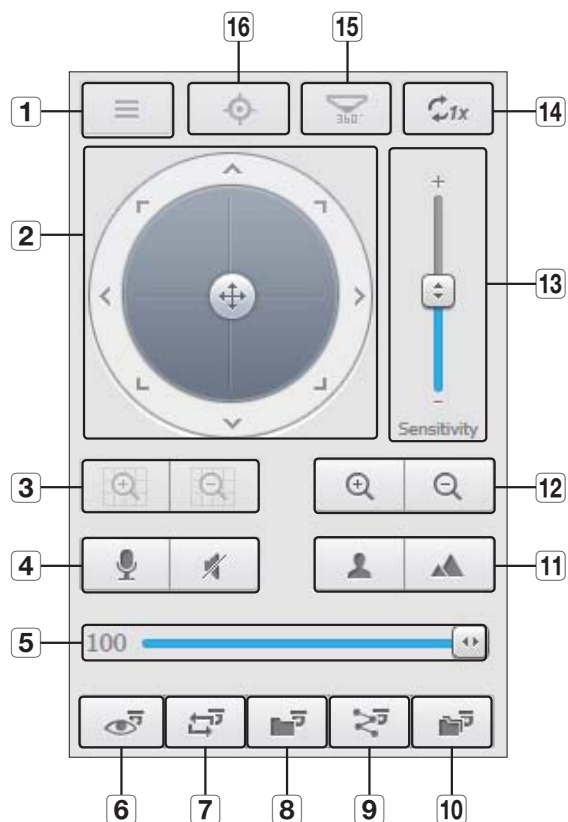

If PTZ camera is connected, the <  > icon appears on screen. When selecting corresponding camera channel, the PTZ tab is provided to allow you to control the PTZ.



Item	Description
1 Camera menu	Displays the camera settings menu.
2 Direction Adjustment	Use this to adjust the direction of the camera or click the crosshair in the center to use it as an OK button.
3 Digital zoom	Adjust digital zooming to make an image larger or smaller.
4 Sound	You can set the camera audio torque and mute.
5 Volume control	Change the PC volume between 0 and 100.
6 Preset	Sets the preset position for camera framing and moves to designated preset position when selecting a desired preset.

Item	Description
7 Swing	Moves between the preset start point and end point.
8 Group	Moves in the path specified by combining the preset.
9 Trace	Moves camera's framing in the predefined path.
10 Tour	Moves in the path specified by combining multiple groups.
11 Focus	Adjusts the focus of the camera.
12 Zoom	Zooms in/out the image by controlling camera's zoom.
13 Sensitivity	Adjust the sensitivity of your camera operation.
14 Digital Zoom Off	Returns to the original size from the zoomed state.
15 Fisheye D-PTZ	Provides the digital PTZ function for the distortion corrected screen.
16 Simple focus	Automatically adjusts the camera focus.

To activate digital zoom

1. Press the <  > button and the screen will be zoomed in by 50% per click.
2. Press the <  > button and the screen will be zoomed out by 50% per click.
 - You can zoom in or out by 10% with the mouse wheel.
3. Click the <  > button and the screen returns to 100% size.

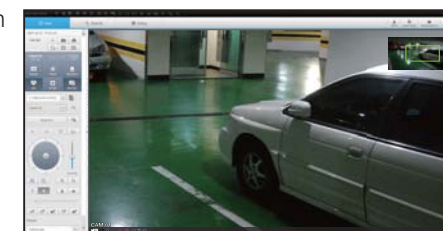



-  Digital zoom function is only available in the single model.

To use the digital PTZ function on a distortion corrected screen

1. Click the icon on the distortion corrected screen.
2. Mouse over the screen and drag to control.

To set a preset

1. Click <  > button to display "Preset" window.
2. Click on <  > to select the preset order.
3. Enter the name of preset.
4. Use direction keys to adjust the direction which camera aims at.
5. Click the <  > button.

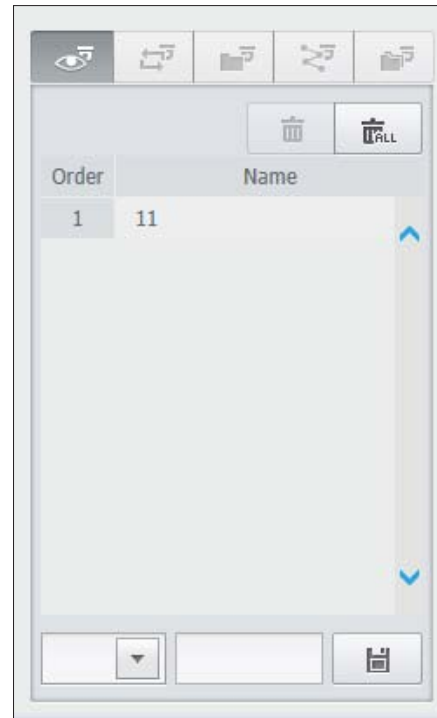

To activate the preset

1. Click <  > button to display "Preset" window.
2. Select a desired preset to activate from the list.
The camera's framing moves to the preset position.

To activate Swing(Auto-pan), Group(Scan), Trace(Pattern) and Tour

You can activate listed functions in the same manner as using a preset. For more information, refer to corresponding user manual of applicable camera.

-  Only selective functions of the camera can be supported, depending on camera.

SEARCH VIEWER

You can search and play the video record saved in NVR by accessing NVR remotely.

Search Viewer Screen



Item	Description
1	Menu Selection Switches to the corresponding menu screen by clicking each menu.
2	Calendar Displays the video-recorded date in blue and today in red. Click the date in blue color to display the recorded video information in timeline.
3	Channel selection Displays the search channels.
4	Search Search for the user designated channel for the selected date.
5	Channel displays Display the selected channel number.

Item	Description
	Sound Sets the sound connected to each channel to either ON/OFF.
	Capture Saves current video for selected channel in the designated path.
	Print Prints current video image for selected channel through the assigned printer.
	Section backup Backup the video for the selected section.
	Rotate Video Rotates the screen of a selected channel by 90 degrees.
6	Keep ch. scr ratio Changes screen ratio of the selected channel.
	Keep full scr ratio Changes screen ratio for all channels.
	Magnify/Shrink Magnify or shrink the current video for the selected channel.
	OSD Displays the channel information.
	Full screen Show the four way split screen in the full screen.
7	Sound control Adjust the audio for the video searched.
8	Fisheye Runs the fisheye settings for the selected channel. (Configures the mounting mode and the view mode to correct the screen distortion.)
9	Recording Color Displays the corresponding color depending on recorded data type if you place your mouse cursor on that area.
10	Display Pane Plays corresponding data on the screen if you select a search result.

Time Search

You can search recorded data by setting date and time.

To search by date

You can select the search date by using calendar.

- Click on < < > > to select the year/month for your search.
If a date has data associated with it, it is displayed in blue. The current date is displayed as a blue box.
- Click the date to search in calendar.
The first image of searched video data on the date is displayed on screen and the data is displayed in the timeline.
- To search video data on today, click <Today>.
Today's date is selected.

Color indications depending on current recording status

Displays the corresponding color according to the recorded data type.



- If 2 or more kinds of recording type are mixed for the same timeline, only the recording type with higher priority is displayed. (Priority: Emergency > G-Sensor > DST > Audio Detection > Camera Event > Sensor > Schedule > Motion > Standard)

To adjust timeline

If searched data are overlapping, you can select a desired data, move its playback time point, and zoom in/out the timeline.



1. Select the number of data to search if data is overlapping. It appears only when data are overlapped and assigns <0> to the most recent data.
2. Click your desired time point to play on the timeline. The playback start point is moved.
3. Click <+> / <-> to zoom in/out the zoom factor to display time.
4. When magnified, if you want to view the pre/post timeline, click on the timeline and drag it in the direction you want to move it.

If you want to check the recording list

The results for each recording section will be displayed.

No.	CH	Start Time	End Time	Event Type	DST Type
1	1	01:41:04	01:41:04	Schedule	
2	1	01:49:42	03:23:26	Schedule	
3	3	01:49:52	03:23:51	Schedule	

To back up the search results

You can back up the search results in the list.

1. Click the [] button.
2. From the search results, select the check box of the item you wish to back up.
 - Format : Select the format of the file to back up.
 - AVI : Codec information provided from the NVR is saved together and can be played in a separate viewer (Windows Media Player, etc.) on the PC.
 - SEC : Proprietary file format, which can be played on the PC immediately as it is saved with a dedicated viewer.
 - If you select the SEC format, you can select whether or not to "Set Password".
 - Path : displays the location of the folder in which the section backup file is to be saved.
3. After completing the backup settings, click the <Backup> button.
 - If you press the <Stop> button during the backup process, the backup will be suspended.

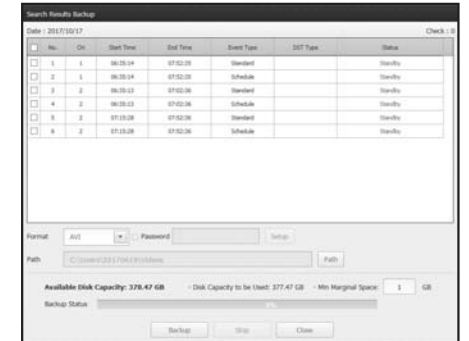

To run the section backup function

You can select and back up a desired section in the timeline or list of video(s) being played.

1. Click the [] button.
2. On the timeline of a video being played, select the start point and the end point of the section to back up. Section backup settings screen will open.
 - Channel : Displays the channel for the section backup.
 - Backup section : Displays the <Start time> and the <End time> of a section to back up.
 - Format : Selects the format of a section to back up.
 - AVI : Codec information provided from the NVR is saved together and can be played on a separate viewer (Windows Media Player, etc.) on the PC.
 - SEC : Proprietary file format, which can be played on the PC immediately as it is saved with a dedicated viewer.
 - If you select the SEC format, you can select whether or not to "Set Password".
 - File name : Sets the name of a section backup file.
 - Path : displays the location of the folder in which the section backup file is to be saved.
3. After completing the section backup settings, click the <Backup> button.
 - If you press the <Stop> button during the section backup process, the backup will be suspended.

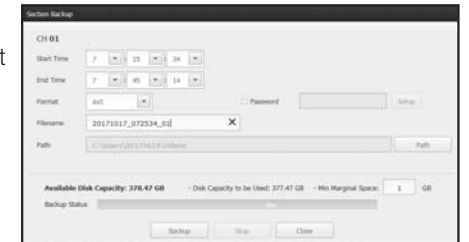

Names and Functions of Play Buttons

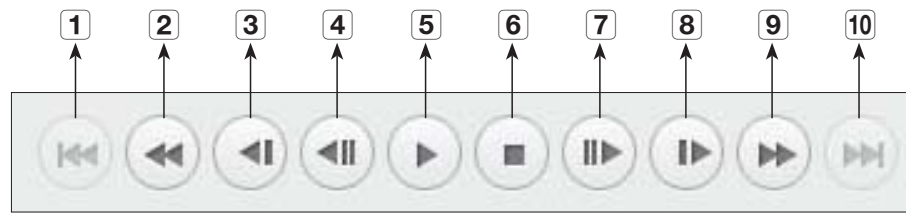

Item	Description	
1	Back	Returns to the previous event.
2	Rewind	Used to rewind a video. (Supports x1, x2, x4, x8, x16, x32, x64, x1, x2 and x4 speed)
3	Slow Rewind	Used to rewind the video at a slow speed. (supports x1/2, x1/4, x1/8, x1/2 and x1/4 speed)
4	Previous frame	Move to the frame in reverse direction.
5	Play/Pause	Video is played and paused.
6	Stop	Terminates the video play.
7	Next frame	Move to the frame in the forward direction.
8	Slow Play	Used to play the video forward at a slow speed. (supports x1/2, x1/4, x1/8, x1/2 and x1/4 speed)
9	Slow Forward	Used to play a video forwards. (Supports x1, x2, x4, x8, x16, x32, x64, x1, x2 speed)
10	Move forward	Proceeds to the next event.

SETUP VIEWER

You can configure the NVR settings remotely on the network.

To configure the NVR settings, click <Setup>.

Settings Screen

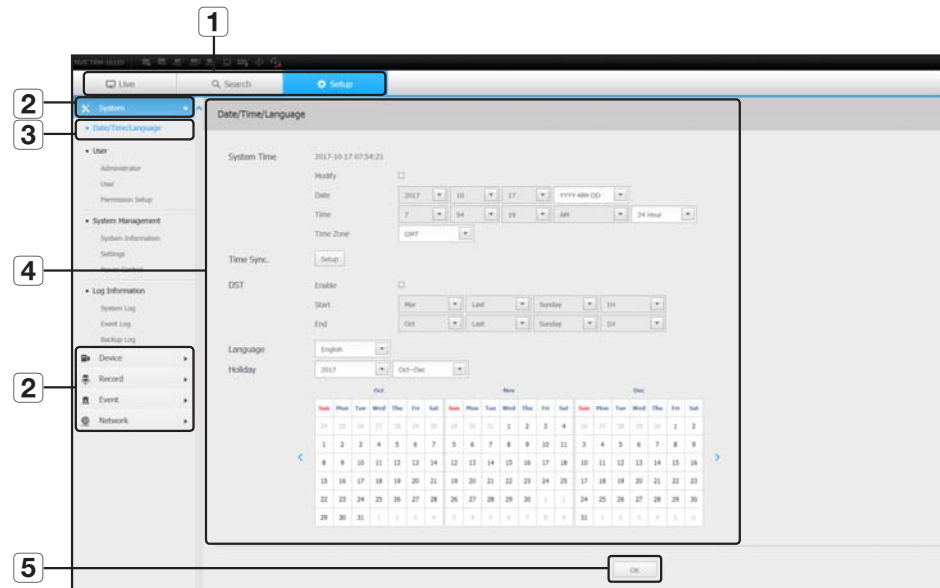

Item	Description
1	Menu Selection Click each menu to switch into corresponding menu screen.
2	Parent Menu Configure the settings or select a parent item to change the existing settings.
3	Sub-Menu Among the sub-menus of selected parent menu, select a desired item to set.
4	Detailed Menu Click desired item's input field to change and enter a desired value.
5	OK Apply the modified settings.

System

You can configure the various settings of the NVR system.

Date/Time/Language

For more information, refer to "Date/Time/Language" in the "System" menu. (Page 25)

Date/Time

Set the date and time.

Time Synchronization Setup

Set the time synchronization.

DST (Daylight Saving Time)

During the summer, Daylight Saving Time (DST) advances clocks one hour forwards from the standard local time zone.

Language

Select a preferred language for the NVR.

Holiday

A user can select specific dates as holidays according to their own preferences.

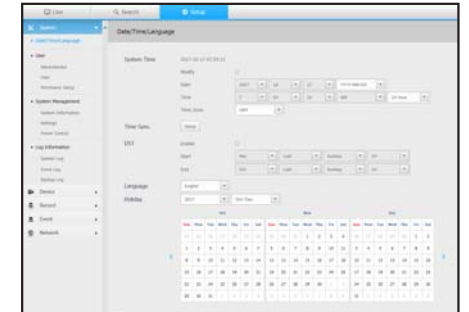

User

For more information, refer to "User" in the "System Setup" menu. (Page 26)

Administrator

You can change the admin ID or the password.

- ID allows alphanumeric characters only.
- If the admin ID is not used for access, you cannot change the ID.
- If the ID being used is changed, you will be automatically logged out.

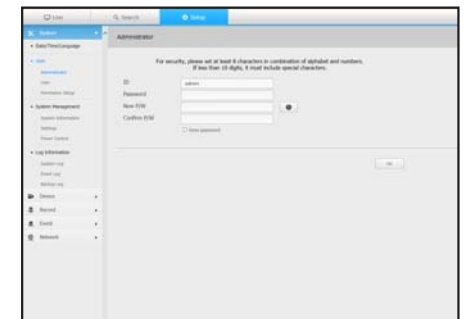

User

You can add, change or remove a user or users.

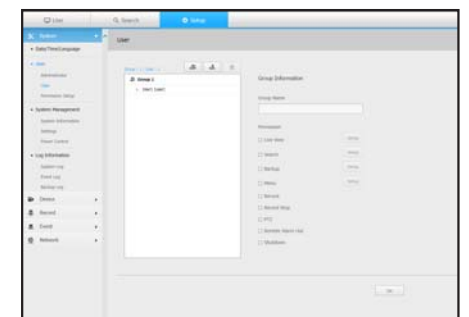

setup viewer

Permission Setup

You can set the user permission.

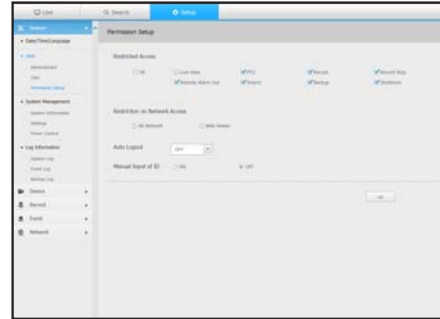

Power Control

You can set the use of power shutdown, delayed boot, shutdown time, and shutdown voltage.

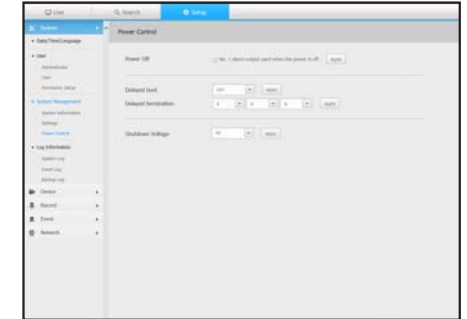

System Management

For more information, refer to "**System Management**" in the "**System**" menu. (Page 28)

System Information

You can see information of the current system.
Check the software version and MAC address.
You can search for a file from the storage device connected to the PC to perform an upgrade.

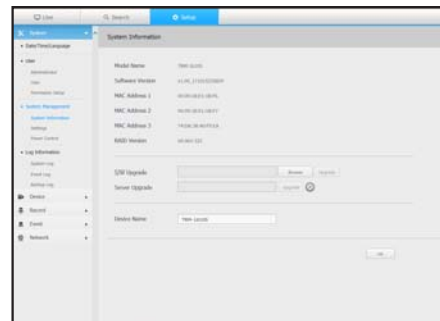

Log information

System log

Data recorded in the system log displays various system-related logs/date/time such as system starts, system ending and menu setting changes.

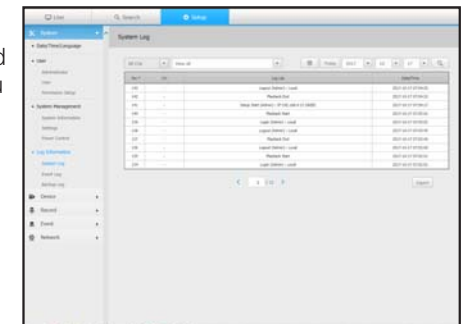

Settings

Using a storage device, you can apply the current configuration of NVR to another NVR.

Press the Initialize button to return the network settings to their factory default state. Items in the **<Not Included>** category are excluded from the initialization.

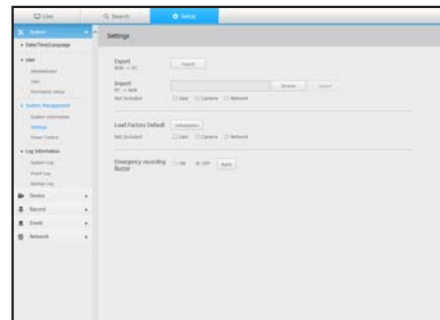

Event log

The event log lists recorded events, such as sensor events, camera events, or image losses.

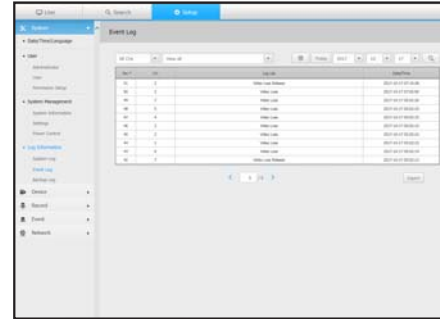

Backup log

You can inquire about a user who performed a backup, execution time, details (backup time, channel, backup device, backup file type).

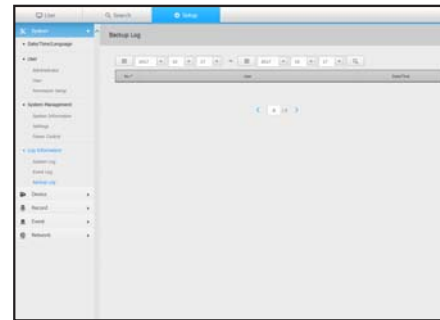

Device

You can check a list of devices that are connected to the NVR and configure the necessary settings. Click <Device> in the menu screen. For more information, refer to "**Setting the Device**". (Page 30)

Camera

Cam Registration

You can add a network camera(s).

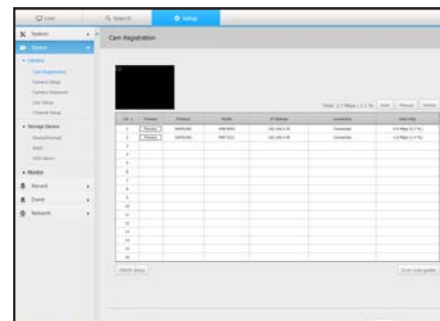

Camera Setup

You can change the settings of a connected network camera.

- When you click the **[Camera website]** button, a new camera web browser window is opened.
 - Not supported if the camera is connected using the RTSP protocol.
 - Not supported if the camera is connected using DDNS, URL, MAC Address.
 - It supports the version specified below or later for each Q/P/X series camera. (QND-7010R series: 1.04, QND-7080R series: 1.02, QND-6010R series: 1.02, QND-6070R series: 1.01, P series: 1.01)
 - It supports only when the camera is connected to IPv4 and is not set to HTTPS.
 - When connecting to the camera web page on a closed network, a camera that does not support the universal web cannot output an image.
 - When trying to connect, if the plugin does not get installed, try again after setting the compatibility view from the web page of the NVR web viewer.
 - It only supports Google Chrome browser.

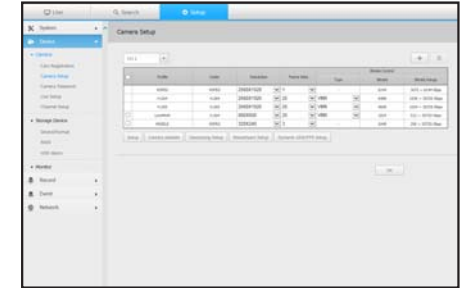

Camera Password

You can change the passwords of all registered cameras at once.

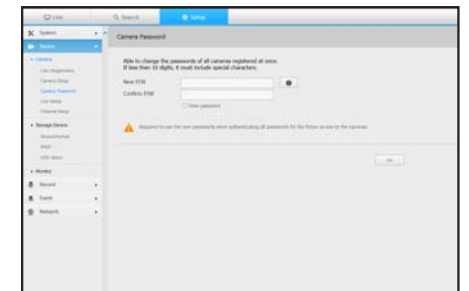

Live Setup

You can change the live transfer settings of the network camera.

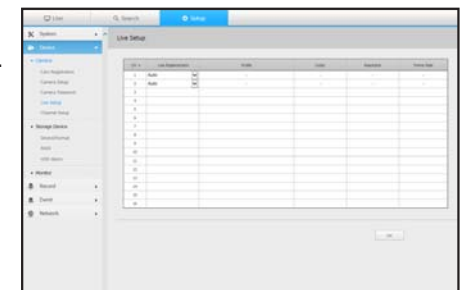

Channel Setup

You can configure the video settings for each channel.

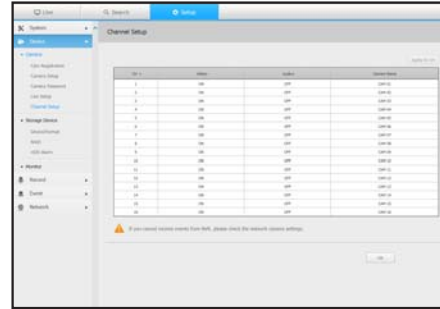

Storage Device

You can check and change the settings related to the data storage device.

Device/format

You can check a storage device, amount of use, type of use and status of storage device.

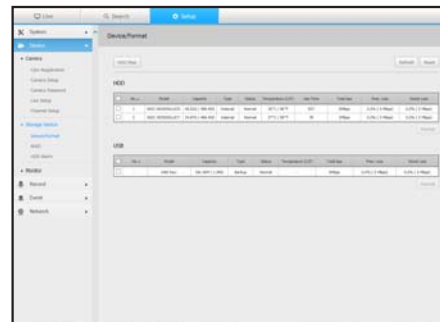

RAID

If RAID mode is set, you can safely recover data even when the system HDD is damaged.

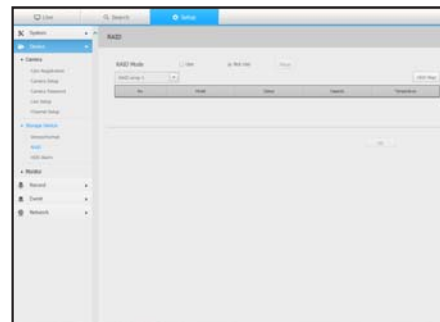

HDD Alarm

You can set the inspection alarm output terminal, replacement alarm output terminal, alarm time, etc. on a bad HDD. You can set the alarm behavior for abnormal HDD temperature.

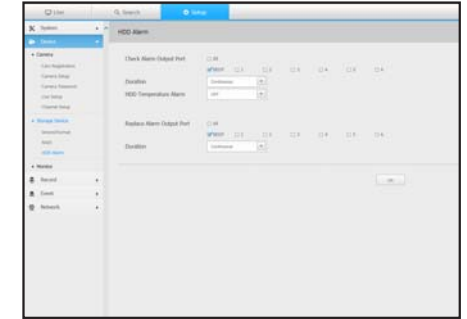

Monitor

Monitor

You can configure the monitoring screen settings and set the output system.



- If the video is not played properly, refer to the troubleshooting section later in this manual. (Page 82)
- The Monitor Setup settings control the monitor connected to the NVR.

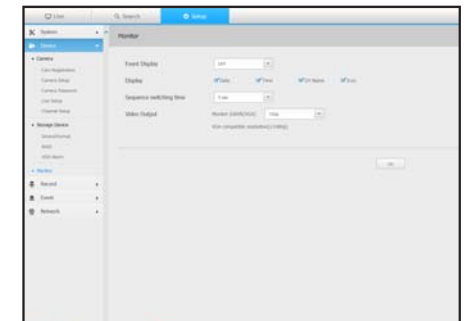

Record

For more information, refer to "**Setting the Recording**". (Page 39)

Recording Schedule

If you set a recording schedule for a specific date and time, the recording will start at that specific time.

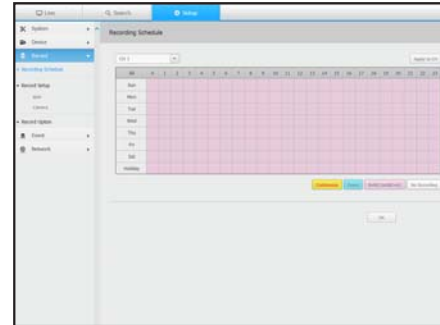

Record Setup

NVR

Select a type of the normal/event recording frame rate for each channel.

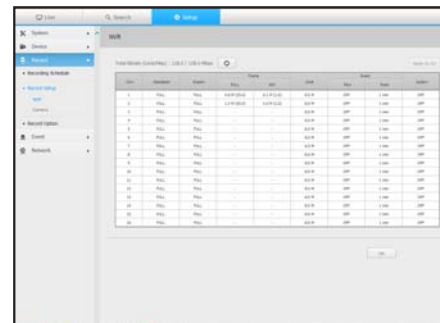

Camera

You can set the recording profile for a network camera.

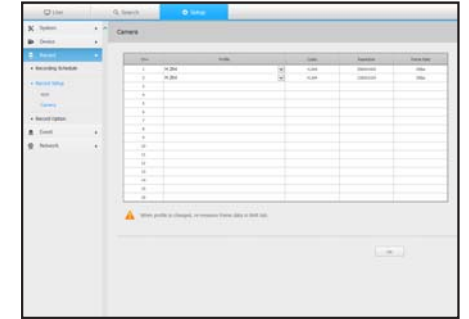

Record Option

You can set the Disk End Mode.

- You can set the recording duration separately for each channel.

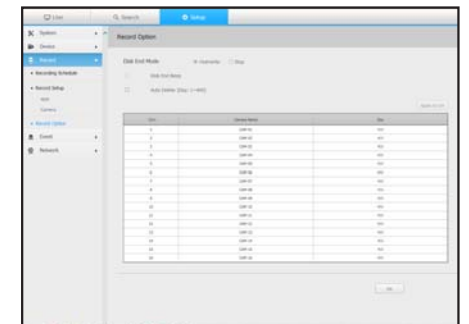

Event

For more information, refer to "Setting the Event". (Page 41)

Sensor Detection

NVR / Camera

You can set the sensor operation mode and the synchronized camera as well as the alarm output type and the duration.

- If the connected network camera that has configured the alarm in/out settings triggers an alarm, NVR will perform the alarm out.

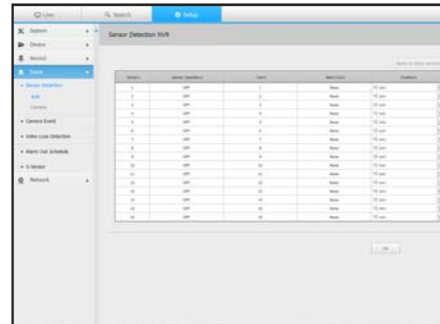

Camera Event

You can set NVR and camera event mode, alarm output type and alarm time.

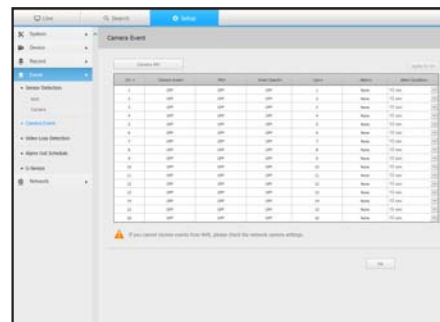

Video Loss Detection

You can set to trigger the alarm if a video loss occurs.

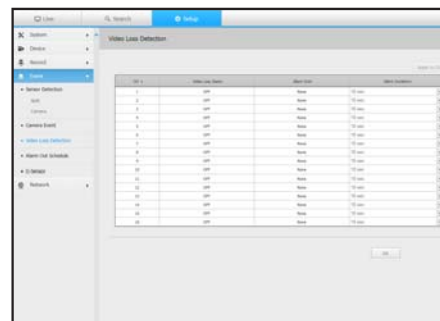

Alarm Out Schedule

You can schedule the alarm output according to the day of the week and the time. The default setting is Event Sync, which activates the alarm only if an event occurs.

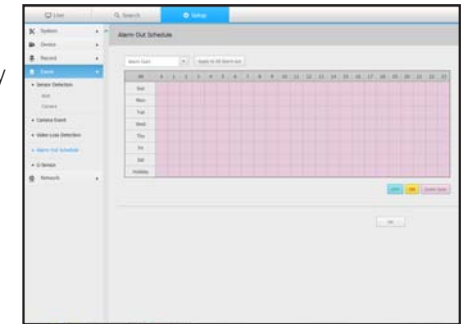

G-Sensor

You can set G sensor events and alarms to operate depending on vehicle movement.

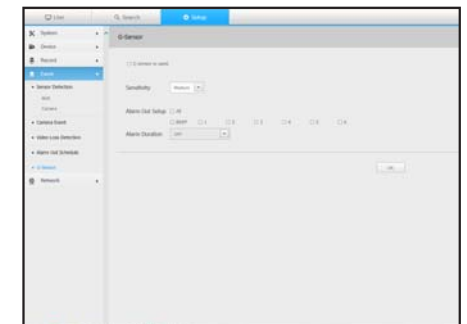

Network

For more information, refer to "Network Configuration". (Page 43)

Interface

A remote user can access the NVR via the network to check the current mode and the IP address.

Network

Specify the network connection path.

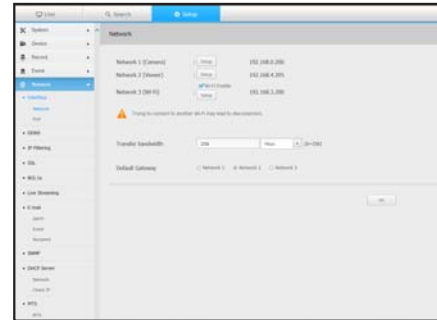

Port

You can configure the protocol related settings.

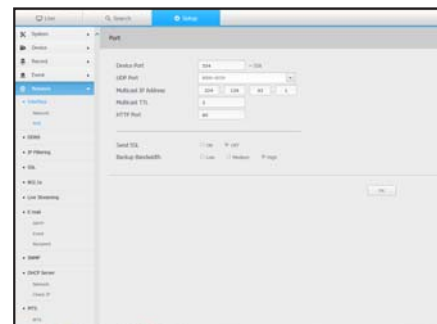

DDNS

Network 2

You can check the DDNS settings.

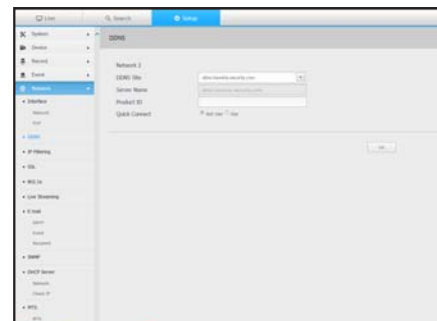

IP Filtering

You can prepare the list of IP address to allow or block accesses to a specific IP address.

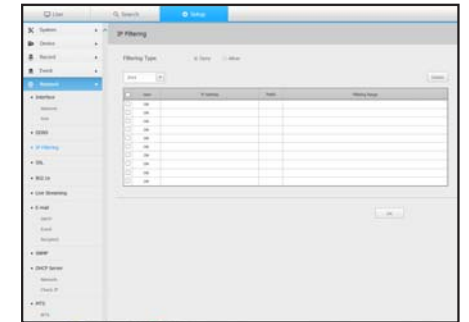

SSL

You can select a security connection system or install public certificates.

- While using HTTPS, if you want to switch to HTTP, then abnormal operation can take place as the browser contains the setting values. You need to change the URL to HTTP and reconnect or initialize the cookie setting of the browser.

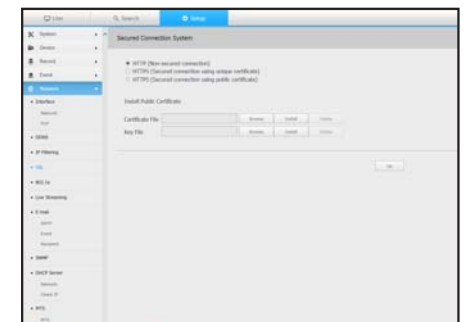

802.1x

When connecting to a network, you can select whether to use the 802.1x protocol and install corresponding certificate.

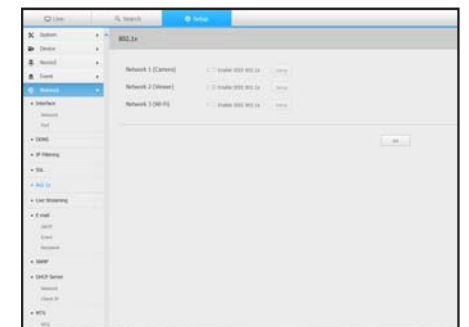

setup viewer

Live Streaming

You can set the video profile transmitted to the network and the expansion monitor.

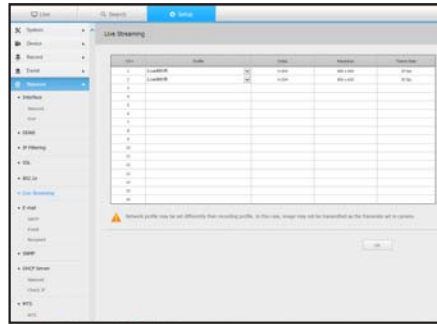

E-mail

You can specify the SMTP server that sends a mail if an event occurs and set the recipient group and users.

SMTP

You can set the server that sends mails and specify if you use the authentication process.

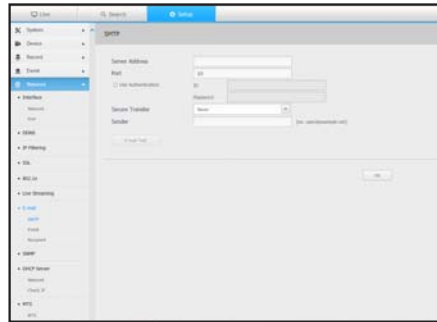

Event

You can set the event interval and specify which events the server sends mails for.

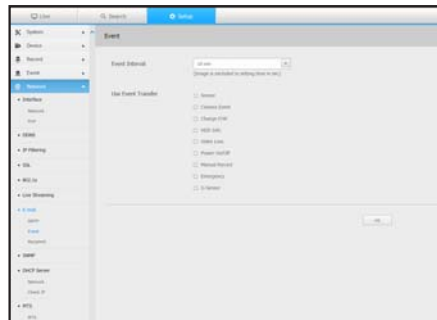

Recipient

You can set groups and recipients to receive emails.

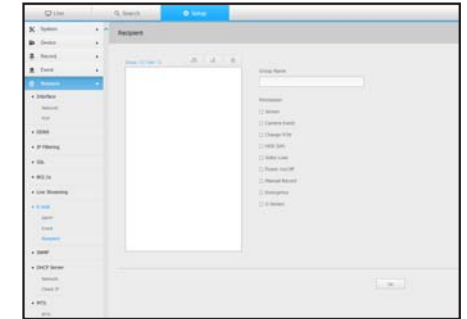

SNMP

Using the SNMP protocol, the system or network administrator can remotely monitoring the network devices and sets the environment.

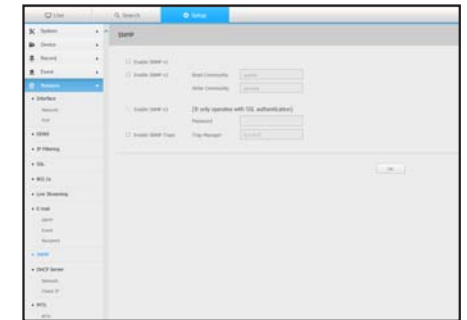

DHCP Server

Network

You can set the internal DHCP server and assign an IP address to the network camera.

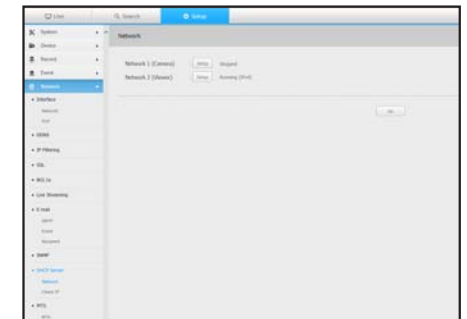

Check IP

You can check the IP and MAC currently used through the DHCP server, and the connected network port.

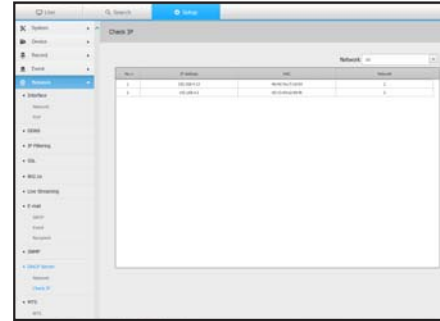

MTS

Vehicle information, real-time location, events and video are transmitted to SSM-MTS (Mobile Tracking System).

MTS

Sets the MTS server address and whether tracking, event notification, and JPEG push are enabled.

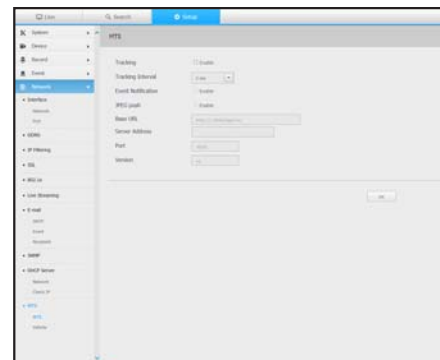

Vehicle

Sends vehicle information to MTS.

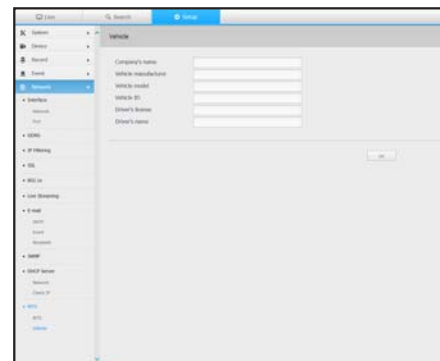

Using the setting icons



- : Display the ID of user connected.
- : You can register a network camera for each channel and easily set the resolution and the number of shots in case of event occurrence or manual recording.
 - For more on how to register a camera, refer to "**To register a camera**". (Page 30)



- : You can manually enter the desired backup channel and time/date to backup the recorded video.
 - If you select the SEC format, you can select whether or not to "**Set Password**".

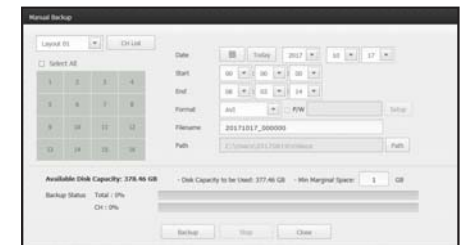

- : You can check the recording status and the status of camera connected.
 - Live : Select **<Live>** to check the status of camera connected to each channel and the transmission information.
 - Recording : Select **<Record>** to check the following for each channel : profile, recording type, inputs / recording transmission rate, settings / inputs / amount of recorded data.
 - PoE : Select **<PoE>** to check the consumption by PoE connected to each channel.

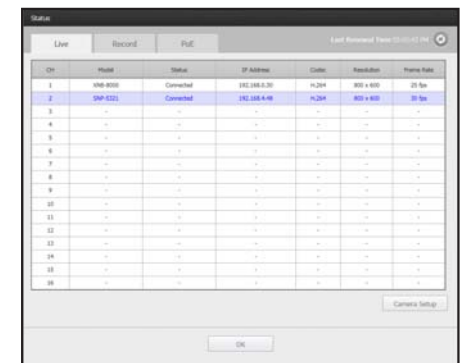

- : You will be immediately directed to the homepage of Hanwha Techwin.

SEC BACKUP VIEWER

You can play a file that is backed up in the format of SEC.

Backup in SEC format produces backup data file, library file and self-executable viewer file.

If you run the backup file viewer, the backup data file will be played.

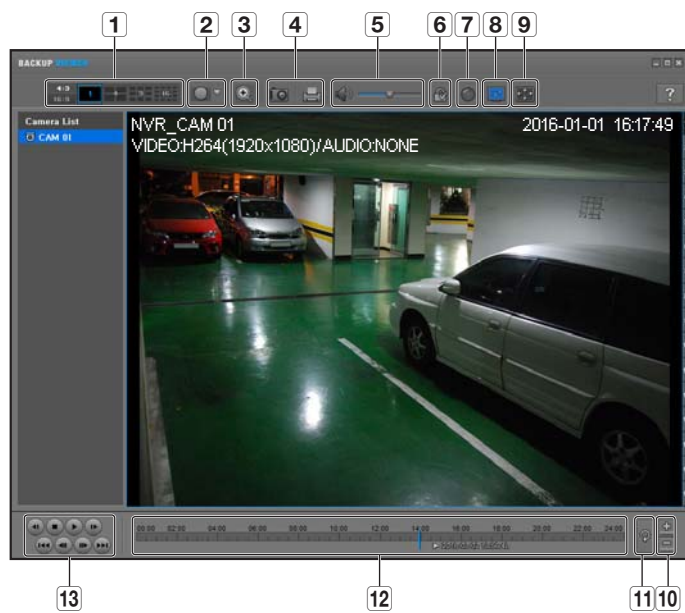

Recommended System Requirements

PCs with a lower specification than the recommended below may not fully support forward/backward and high-speed playback.

- OS : Windows 7
- CPU : Intel Core 2 Quad 2.5GHz or higher
- RAM : 3GB or more
- VGA : Geforce 6200 or higher

Item		Description	
1	Split screen		Selects screen ratio to display.
			The screen is changed to a split screen.
2	Fish eye view mode		If is pushed, it is possible to change to a fish eye installation type. It is possible to select WALL/GROUND/CEILING mode according to the installation place.
			The fish eye view mode on the current screen can be changed independently on each split.

Item		Description	
3	Digital Zoom		Enlarge the image by up to 100 times as big as the current one. Press the Zoom In () button the enlarge the image; press the Zoom Out () button to shrink the image. You can also use the slide bar () in the pop-up window to zoom in/out. Press () on a size-changed video to restore the default zoom factor (100%). If you enlarge the image by more than 200%, the enlarged area will be marked on the digital zooming screen. Click on the marked area and move it to a desired position. The digital zooming is applied to all backup viewer. When the digital zooming is canceled, the video size will restore the default rate of 100%.
4	Screen Printout		Saves the current video's image as in an image file. Supports JPEG file format.
			Prints out the current screen. You should have installed the appropriate printer driver before you can print out the screen.
5	Audio		A toggle button. Each time you press this button, the audio output will toggle between activated and deactivated.
			You can adjust the volume level from 0 to 100.
6	Watermark		Press the button to enable file tampering detection, to detect data file forging.
7	Deinterlace		You can enable the De-interlace function.
8	Show OSD		Check the OSD checkbox to display the OSD information on the backup playback screen. Information such as backup date, day of the week, time, model name, and channel number will be displayed on the screen.
9	Maintain aspect ratio/Full screen		Maintains the aspect ratio of the playback screen.
			Plays the video on a full screen.
10	Enlarge / Reduce Timeline		Collapses the time range that is displayed on the range bar of the storage time. You can collapse the range bar until the overall range is shortened to 24 hours.
			Enlarges the time range that is displayed on the range bar of the storage time. You can enlarge the range bar until the overall range is extended to 1 minute.
11	Restore Timeline		Restores the timeline to the default.
12	Display of storage time range		Displays the time range of a stored video file. You can move the gridline of the range bar to select a time point to play.
13	Playback Control		You can adjust the video playback of the timeline.

PRODUCT SPECIFICATION

Item	Details	
	TRM-1610S	TRM-1610M
Display		
Network Camera	Inputs	Max. 16CH (4 PoE,RJ-45) / Max. 16CH (4 PoE, M12)
	Resolution	CIF ~ 12MP
	Protocols	SUNAPI, ONVIF
Live	Local Display	HDMI / VGA
	Multi-Channel Display	Local Monitor : 1 / 2V / 3V / 4 / 6 / 8 / 9 / 13 / 16 / Auto sequence Web : 1 / 4 / 9 / 16 / Auto sequence
	Performance	[Local Monitor] - 12M (30fps) - 8.3M(120fps) - 1080p(480fps)
Performance		
Operating System	Embedded	Linux
Record	Compression	H.265, H.264, MJPEG, WiseStream(H.265, H.264)
	Recording Bandwidth	Max. 128Mbps
	Resolution	CIF ~ 12MP
	Type	Normal, Schedule(Continuous/Event), Event (Pre/Post), Emergency
	Retention	Retention per channel (1~400 days)
	Event Trigger	Alarm Input (16), Video Loss, Camera Event(Sensor, MD, Video Analytics, Defocus Camera)
	Event Action	e-Mail, Alarm Out, Buzzer, Monitor Out, VMS transmission

Item	Details	
	TRM-1610S	TRM-1610M
Search & Play	Playback Bandwidth	32Mbps(16ch simultaneously)
	User	Max. 4 Users (Local 1, Remote 3)
	Mode	Date & Time(Calendar)/Event Log list, Smart Search(Virtual Line w/ direction, Enter/Exit)
	Simultaneous playback	Max. 16 channels(Local Monitor, CMS)
Search & Play	Resolution	CIF ~ 12MP
	Fisheye Dewarping	Web / CMS
	Playback Control	Fast/Slow Forward/Backward, Move one step up/down
Storage	Built-In	0TB ~ 4TB (2TB 2EA)
	Internal HDD	2 SATA(Front-Swap) - Max. 4TB(HDD, Non-RAID Mode) - Max. 1TB(SSD, Non-RAID Mode)
	RAID	RAID-1
Backup	File backup	Exe(GUI), JPG/AVI(excluding GPS information)(Network)
	Function	Multi channel(Upto 16CH) Play, Date-Time/Title/GPS display
	Type	Auto(Wifi), Manual(HDD)
	Wifi Backup Performance	MAX. 150Mbps (IEEE802.11ac)
Sensor	I/O	16/6
Audio	Input	16 channels (network)
	Compression	G.711, G.726, AAC(16/48KHz)
	Audio Communication	2-Way

Item	Details	
	TRM-1610S	TRM-1610M
Network		
Interface	RJ-45 (Gigabit Ethernet x2)	M12 (Gigabit Ethernet x2)
Protocol	TCP/IP, UDP/IP, RTP (UDP), RTP (TCP), RTSP, NTP, HTTP, DHCP (Server, Client), PPPoE, SMTP, ICMP, IGMP, ARP, DNS, DDNS, uPnP, HTTPS, SNMP, ONVIF (Profile-S), SUNAPI(Server, Client)	
DDNS	Hanwha DDNS	
Transmission Bandwidth	Wired (LAN)	MAX. 256Mbps
Max Remote Users	Search(3) / Live unicast(10) / Multicast(20)	
IP Version	IPv4	
Security	User access Log, IP Filtering, 802.1x, Encryption	
Wireless	Wi-Fi	Internal (802.11 n(2.4G)/ac(5G), Dual antenna(MIMO))
Language	English, French, German, Italian, Spanish, Russian, Turkish, Polish, Dutch, Swedish, Czech, Portuguese, Danish, Rumanian, Serbian, Croatian, Hungarian, Greek, Norwegian, Finnish, Korean, Chinese, Japanese, Thai	
OS	Window 7, 8, 10, Mac OS X(10.8 or above)	
Web Browser	MS IE, Google Chrome, Mac Safari	
Viewer Software	Type	SSM TR, Webviewer, Wisenet mobile viewer
	CMS Support	Support SDK/CGI(SUNAPI) for integration to 3'rd party VMS(eg. Genetec)
Functions		
Camera Setup	Register	Auto, Manual
	Setup Items	IP address, Add profile edit, Bitrate, Compression, Camera MD setup Camera video setup (Simple focus, Brightness/Contrast, Flip/Mirror, IRIS, WDR, D&N, SSSNR, Shutter, SSSDR, DIS), Fisheye Dewarping Mode, Hallway View Setup, Camera Webpage Wisestream On/Off

Item	Details	
	TRM-1610S	TRM-1610M
Camera Control	PoE Power Control	Monitor PoE/PoE+ power consumption, On/Off control for each PoE/PoE+ camera, Remote reset for each PoE/PoE+ camera
	Time Sync.	NVR time protocol for PoE/PoE+ camera (Time sync based on NVR time), GPS time sync GPS time sync
PTZ	Control	Via GUI, Webviewer
	Preset	300 Presets
Smart phone	Support Model	Android, iOS
	Protocol Support	RTP, RTSP, HTTP, CGI(SUNAPI)
	Control	Live(16ch) : Multi-Profile Support Playback(1ch)
	Max. Remote Users	Search(3) / Live unicast(10) / Live Multicast(20)
System Control	Mouse, Web	
Remote Management (SSM-TR, ISV)	Metadata TX	GPS, Speed(GPS) Internal Metadata: Transport company, vehicle type / car number / license number / driver name
		Health Check (Status, Rec, Event,..)
		Support Vehicle ID, Driver Name
Indicator/Interface		
Front	Indicator	3 LED status indicators : Power 1, Alarm 1, Record 1
	Switch	Support (PW Clear)
	HDMI / VGA	2 (Live screen is supported up to 16-div. mode, clone) HDMI : Maximum 4K (3840 x 2160), VGA : maximum 1080p
	USB	3 (1 x M12, 2 x USB-A), except for M12 with built-in LTE module
	GPS/GNSS	1 EA SMA
	HDD Key Lock	2 EA

Item		Details	
		TRM-1610S	TRM-1610M
Connectors	Audio	Out(1EA, RCA, Line)	
	Ethernet	LAN / WAN : 2ea (1Gbps, RJ-45) PoE Camera Input : 4ea(100Mbps, RJ-45)	LAN / WAN : 2ea (1Gbps, M12) PoE Camera Input : 4ea(100Mbps, M12)
	Control I/O	DB15 1ea (External Control Box) (1) Status LED (2) Impact Sensor (3) Emergency Recording button (4) Power Switch	
	Alarm	DB25 1ea (1) In(16EA) (2) Out(6EA)	
	Reset	Switch(1EA)	
	Power Cord	One 6-pin connector	
System			
Power Management	Shutdown Delay	0min ~ 72Hrs (User selectable)	
		Support CGI shutdown	
	Startup Delay	0(default) min ~ 10 min (User selectable)	
Log	Log List	Max. 20,000 (System Log, Event Log each)	
Environmental			
Operating Temperature / Humidity		TX compliant (-25 to +55 °C, -13 to +131 °F, HDD in use) TX compliant (-40 to +70 °C, -40 to +158 °F, Industrial SSD in use)	
Humidity		20% ~ 85% RH	

Item		Details	
		TRM-1610S	TRM-1610M
Electrical			
Power	9 ~ 36V DC		
	Battery Power Detection & Low Power Limit Setup		
Power Consumption		Low temperature at start: 144W, Low temperature in use: 93W, Room temperature: 67W (maximum)	
PoE Budget		Max. 32W	
Mechanical			
Color / Material		Black / Aluminium	
Dimension (WxHxD)		Main unit : Approx. 250 x 99 x 303 (9.84" x 3.89" x 11.92") Control box : Approx. 118 x 29.2 x 70mm (4.64" x 1.15" x 2.75")	
Weight		Main unit : 7.35Kg Control box : 0.2Kg	
Standard Approvals	Basic	CE, FCC, cJUL, KC	
	EMC	EN-55022	
	Safety	UL-60950-1	
	Shock/Vibration	MIL STD-810F(SSD Terms of Use)	
	Rail(Temp,Humid,shock, vib)	EN-50155	
	Rail(EMC)	EN-50121-3-2	
	Rail(EMI)	EN-50121-4	
	Rail(Shock, vib)	EN-61373	
Vehicle(EU)	e-Mark		

Item		Details	
		TRM-1610S	TRM-1610M
Accessory	Supplied	Control Box 1pc	
		Control Box Cable 1pc (DB9)	
		Alarm I/O Cable 1pc (DB25)	
		Key 2pcs	
		Power Input Cable 1pc	
		Wifi Antenna 2pc	
		GPS Antenna 1pc	
		M12-USB cable	
		CD(Manual)	
		Screws(HDD Tray, Mounting)	
		Mounting Bracket (Damper)	
	Optional	Ext. PoE Switch(RJ-45, 8PoE, 64W)	Ext. PoE Switch(M12, 8PoE, 64W)
		SSD bracket (no damper) for MIL	
		HDD Tray	
		100V DC Adapter	

PRODUCT OVERVIEW

- TRM-1610S

unit : mm (inches)

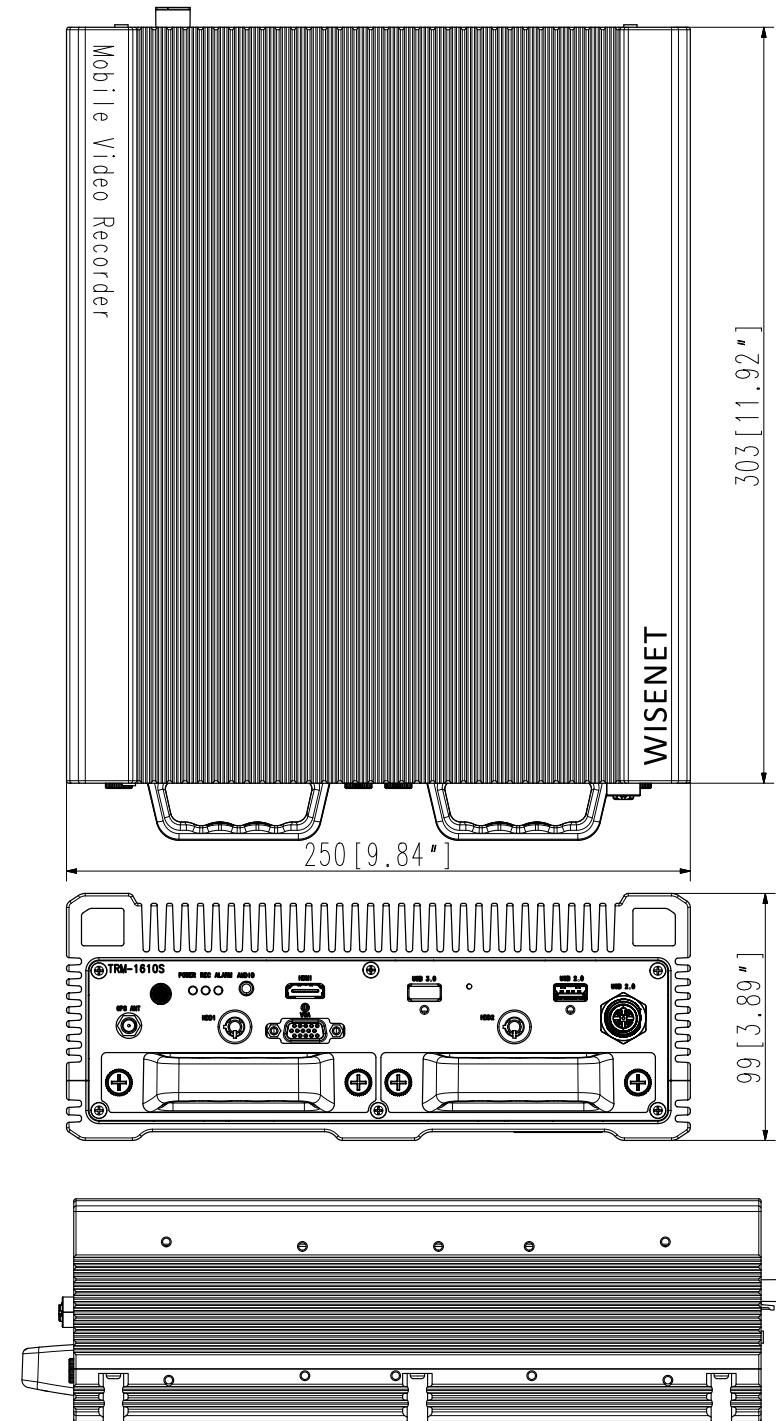

• TRM-1610M

unit : mm (inches)

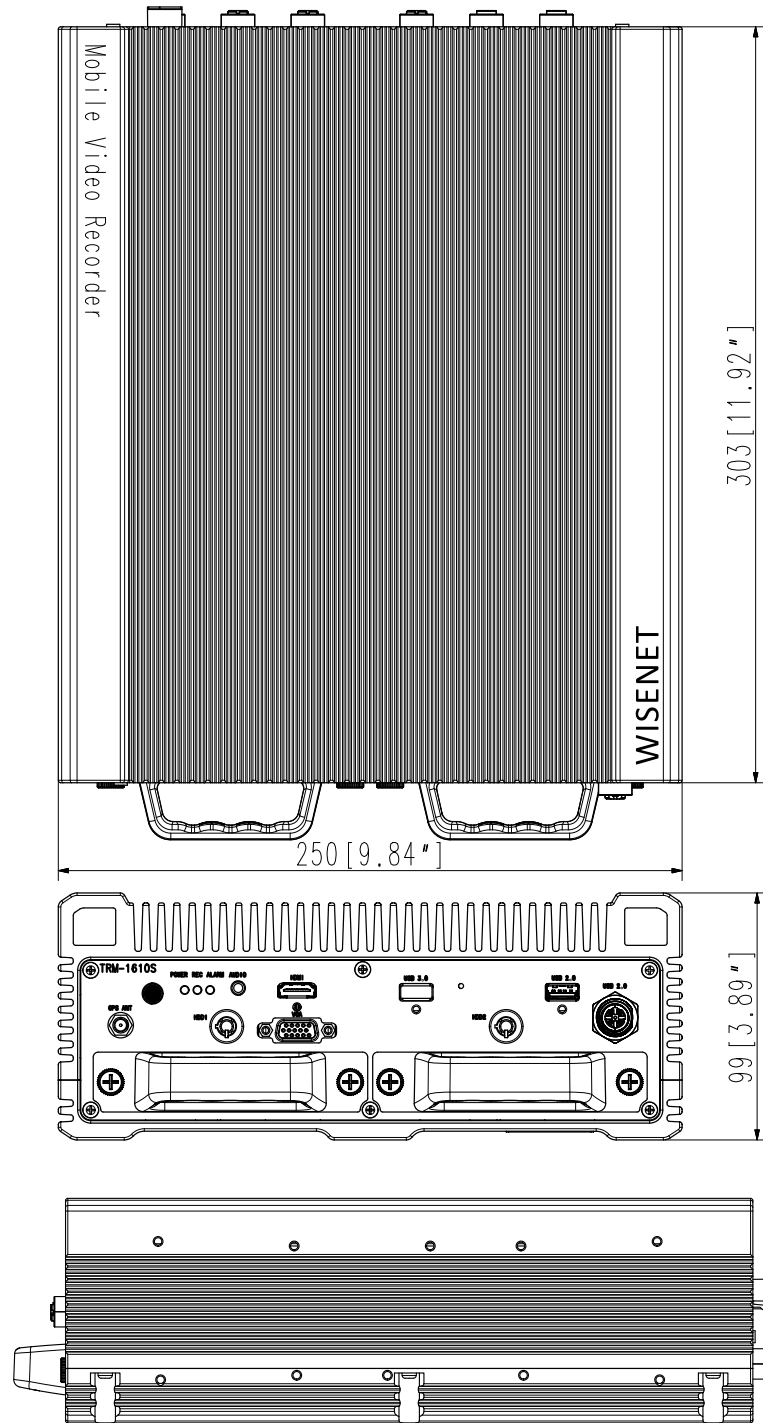

• Control box

unit : mm (inches)

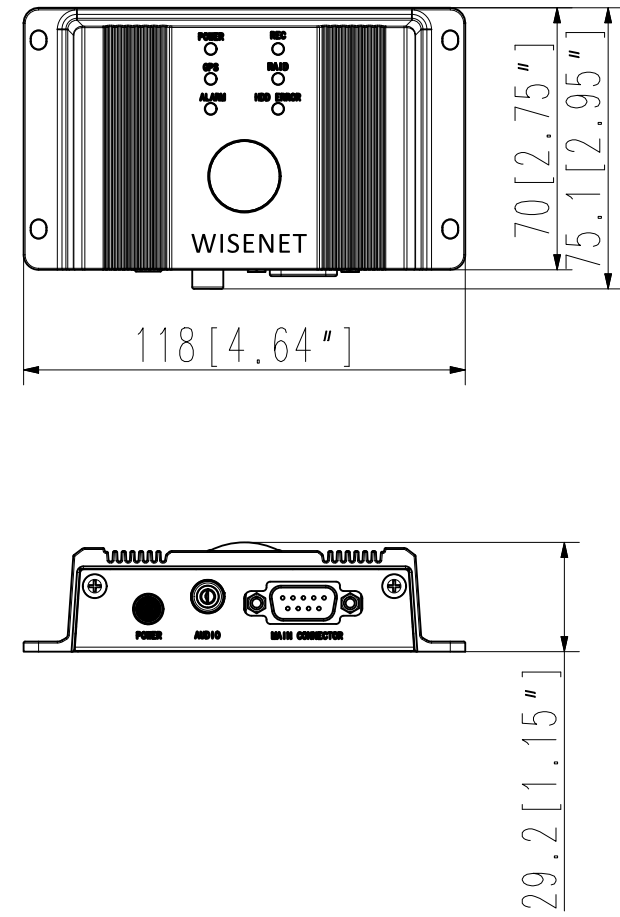

DEFAULT SETTING

To reset the system, move to "**System Management > Settings > Load Factory Default**" and press the **<Initialization>** button.

This returns the factory default settings.

-  When you initialize with the **<Authority Management Settings>** included, you are required to reboot the camera and reset the password.
- The default settings are based on TRM-1610S.
- The initial administrator ID is "**admin**" and the password should be set when logging in for the first time.
- Please change your password every three months to safely protect personal information and to prevent the damage of the information theft. Please, take note that it's a user's responsibility for the security and any other problems caused by mismanaging a password.

Category	Details		Factory Default	
System	Date/Time/Language	Date	YYYY-MM-DD	
		Time	24 hours	
		Time Zone	GMT	
		Time Sync.	OFF	
		DST	OFF	
		Language	English	
	User	Admin	ID	admin
		Permission Setup	Restricted Access	Backup/Record/Record Stop/Search/PTZ/Remote Alarm Out/Shutdown
			Restriction on Network Access	None
			Auto Log out	3 Min
			Manual Input of ID	OFF
	System Management	System Information	Device Name	TRM-1610S
	Log Information	System Log	Type	View all
		Event Log	Type	View all
		Backup Log		OFF
Device	Camera	Camera Register	OFF	
		Set Camera	OFF	
		Camera Password	OFF	
		Live Setup	OFF	
		Channel Setup	Video	ON
	Audio		OFF	
	Camera Name		CAM 01 ~ CAM 16	
	Storage Device	Device/Format	Device	HDD
Usage			Internal	
Status			Normal	
Temperature			-	
Use Time			-	

Category	Details		Factory Default		
Device	Storage Device	RAID	No use		
		HDD Alarm	Check Alarm Output Port	BEEP	
			Duration	Continuous	
			HDD Temperature Alarm	OFF	
			Replace Alarm Output Port	BEEP	
	Distributed Recording	Duration	Continuous		
	Monitor	Monitor	Event Display	OFF	
			Display	All	
			Sequence switching time	5 sec	
			Video Output	1280x1024	
Display Position Setup			30		
Record	Recording Schedule	CH1~CH16	Both(Cont&Evt)		
	Record Setup	Standard	Full		
		Event	Full		
		Pre Event	OFF		
		POST Event	1 min		
		Audio	OFF		
	Record Option	Disk End Mode	Overwrite		
		Auto Delete	OFF		
	Event	Sensor Detection	NVR	Sensor Operation	OFF
				Cam	Camera No.
Alarm Out				None	
Camera			Duration	10 sec	
			Sensor Operation	OFF	
Camera Event		Camera	Cam	Camera No.	
			Alarm Out	None	
			Duration	10 sec	
			Camera Event	OFF	
			MD	OFF	
Video loss detection		Smart Search	OFF		
		Cam	Camera No.		
		Alarm	None		
		Alarm Duration	10 sec		
		Video loss status	OFF		
		Alarm Out	None		
		Alarm Duration	10 sec		

Category	Details		Factory Default
Event	Alarm Out Schedule		Event Sync
	G-Sensor		G sensor is used.
			Sensitivity
			Alarm Out Setup
			Duration
Network	Interface	Network	IP Type
			Network 1(Camera)
			Network 2(Viewer)
			Network 3(Wi-Fi)
			Subnet Mask
			Gateway
			DNS
			Static IP
		192.168.1.200	
		192.168.2.200	
	Port	Device Type	
		UDP Port	
		Multicast IP Address	
		Multicast TTL	
		HTTP Port	
		Send SSL	
		Backup Bandwidth	
	554		
	8000~8159		
	224.126.63.1		
	5		
	80		
	OFF		
	High		
	DDNS	Network2	DDNS Site
	IP Filtering		Filtering Type
	SSL		Secured Connection System
802.1x	Network1/2/3	Enable IEEE 802.1x	
Live Streaming			
E-Mail	SMTP	Port	
		Use Authentication	
		Secure Transfer	
	Event	Event Interval	
		Use Event Transfer	
	Recipient	Group Name	
		Permission	
		HTTP (Non-secured connection)	
OFF			
OFF			
10 min			
OFF			
OFF			
OFF			



Category	Details		Factory Default
Network	SNMP		Enable SNMP v1
			Enable SNMP v2
			Enable SNMP v3
			Enable SNMP Traps
	DHCP Server	Network 1(camera)	IP Address
			Subnet Mask
			IP Range
			IP Lease time
		Network 2(Viewer)	IP Address
			Subnet Mask
			IP Range
			IP Lease time
	MTS	MTS	
Vehicle			
OFF			
OFF			
192.168.1.200			
255.255.255.0			
192.168.1.1 ~ 192.168.1.254			
86400			
192.168.2.200			
255.255.255.0			
192.168.2.1 ~ 192.168.2.254			
86400			

TROUBLESHOOTING

Problem	Action
Live video will be slow or cut off.	<ul style="list-style-type: none"> The frame number set for multiple data transmission set in camera or network environment could differ from the actual rate of transmission. Right click with the mouse button and select <Channel Information> to check the number of incoming frames for each channel and the actual number of framed played. Basically, when you register a camera, the Live4NVR profile is created and the rate is set to H.264.800*600fps. If necessary, go to <Menu> → <Device> → <Camera> → <Camera Setting> and change the number of frames. If you keep seeing video slow down or cut off, then check the network environment or camera condition.
The system does not turn on and the indicator on the front panel does not work at all.	<ul style="list-style-type: none"> Check if the power supply system is properly connected. Check the system for the input voltage from the power source. If the problem persists even after you have taken the above actions, check the power supplier and replace it with a new one if necessary. Check inside if the cables are properly connected. (SMPS, FRONT)
Some channels display just a black screen even if they receive video sources.	<ul style="list-style-type: none"> Check if the camera is properly supplied with power. Check the video output connecting the camera's webviewer. Check if the network port is properly connected and the network setting is set correctly. Change the hub supporting Gigabit, it may solves.
The screen displays the logo image repeatedly.	<ul style="list-style-type: none"> This may occur from a problem with the main board, or the related software is corrupt. Contact the nearest service center for more information.
The Channel button does not work on the Live screen.	<ul style="list-style-type: none"> The Channel button does not work if the current screen is in the event monitoring mode.
The cursor will not move to the Start button when I start the calendar search.	<ul style="list-style-type: none"> Check if the channel and the date that you want to play are marked with the V symbol. Both channel and date should be checked before you can start playing with the Start button.
No video is played on the connected monitor.	<ul style="list-style-type: none"> Check if the necessary cables are connected to the monitor properly. Some monitors do not support the NVR output (HDMI or VGA). (NVR output resolution : VGA : 1280*720, 1280*1024, 1920*1080, HDMI : 720P, 1080P, 1440P, 2160P) Check the monitor resolution In case of a 4K video, check whether the cable in use supports HDMI 2.0.

Problem	Action
No response controlling PTZ in the live viewer.	<ul style="list-style-type: none"> Check the registered Camera if it support PTZ function.
The camera is not connected or the PC fails to connect to the product.	<ul style="list-style-type: none"> Check if the network cable is connected properly. Ensure that you have set Network – Connection Mode. Check the IP setting of the PC or camera. Try the Ping Test. Check if there is a different device near the product uses the same IP.
I registered a camera, but the web viewer does not show live video.	<ul style="list-style-type: none"> After registering a camera, a user need to edit/save the desired layout, before the screen split mode and live screen fit for the setting appears.
In the web viewer, the screen does not switch automatically.	<ul style="list-style-type: none"> You need to select the desired layout for sequence operation, in the automatic switching menu.
The Live screen is too bright or too dark.	<ul style="list-style-type: none"> Check the video settings of the registered camera.
A message of "Need to reset date/time." Is displayed on the screen.	<ul style="list-style-type: none"> This message is displayed if there occurs a problem with the time setting of the internal clock or an error in the clock itself. Contact the retailer or the service center for more information.
The time bar is not displayed in Search mode.	<ul style="list-style-type: none"> The timeline can switch between normal and extension mode. In extension mode, the time bar may not be displayed in the current timeline. Switch to normal mode or use the left or right button to navigate through the time bar.
The "NO HDD" icon and an error message are displayed.	<ul style="list-style-type: none"> Check the HDD for connection. If the problem persists in a normal condition, contact the nearest service center to have the HDD checked by the service personnel.
I have installed an additional HDD on the NVR but it does not recognize the HDD.	<ul style="list-style-type: none"> See the compatibility list to check if the additional HDD is supported by the NVR. For the compatibility list, contact the retailer where you purchased the NVR.
I have connected an external storage device (USB Memory, USB HDD) to the NVR but the NVR seems not to recognize it.	<ul style="list-style-type: none"> See the compatibility list of external storage devices to check if the connected device is supported by the NVR. For the compatibility list, contact the retailer where you purchased the NVR.
If I press the ESC key in full screen mode of the WebViewer, the system does not switch to a normal split mode.	<ul style="list-style-type: none"> Press the ALT+TAB keys to select 'ACTIVE MOVIE' and press the ESC key again. The system will switch to a normal split mode.
I found it difficult to configure the network settings if using the default search, backup and router settings.	<ul style="list-style-type: none"> For more information, refer to the user manual. If you want to check the basics of the product for a quick start, refer to the quick start guide (backup, search). If you use the router for network connection, refer to the "Connecting and Setting the Network" section in this manual.

Problem	Action
I forgot the password.	<ul style="list-style-type: none"> Contact the NVR administrator for help.
Recording does not work.	<ul style="list-style-type: none"> If your player does not display a Live image at all, that indicates recording does not work so first check if you see an image on the screen. Recording does not work if the recording settings are not properly configured Scheduled Record: Specify a desired time in Menu – Record – Recording Schedule. Recording will start at the specified time. <ul style="list-style-type: none"> <Continuous> Record: Recording will proceed in any conditions at the specified time. <Event> Record: When an event occurs, recording will perform only if the event is of alarm, motion detection and video loss. If there is no event found, recording will not perform. <Continuous / Event> Record: If there is no event found, Continuous recording will perform. Whereas, if an event occurs, Event recording will perform.
The image quality of the recording data is not good.	<ul style="list-style-type: none"> Increase the resolution and quality level in Menu – Record – Quality / Resolution. <ol style="list-style-type: none"> Resolution: Select a bigger size when specifying the recording size. The recording image in the CIF format shows a deteriorated quality as it is enlarged from a small-sized image. Record Quality: Specify a bigger level for the recording quality. If you increase the resolution and the recording quality, the data size increases accordingly. So the HDD will be filled faster. Overwriting will overwrite the existing data so recording will proceed at a shorter interval.
Frame rate of the actual recording does not match that of configured to the camera.	<ul style="list-style-type: none"> If multiple profiles were applied to one camera for video transmission, the actual video stream can be serviced by the camera at a lower frame rate than specified. Configure your camera to use one profile for data streaming as possible. For example, if you set the same profile for recording and network profiles, the actual recording is made at the specified frame rate. Still, live video display using split screen mode may apply yet another profile to camera in accordance with the used screen mode. Note that allowed limit bitrate for recording / recording settings should be set to be bigger values than that of camera's feed.

Problem	Action
In the recording setting screen, the permitted level for a specific channel is displayed in orange.	<ul style="list-style-type: none"> If the input data is greater than the permitted level for each channel, it is displayed in orange. Set the permitted data limit to higher than the amount of input data. If the sum of input data for each channel exceeds the limit, the alarm icon will be displayed. In this case, the channel exceeding the input limit does not record the entire frame, but it records the main frame only(one or two per sec).
In the live screen, the [] icon is displayed and the message window saying " recording data load exceeds the limit. Check it in the record setting." pops up.	<ul style="list-style-type: none"> If the sum of input data for each channel exceeds the limit, the alarm icon and the pop up window will be displayed. In this case, the channel exceeding the input limit does not record the entire frame, but it records the main frame only(one or two per sec). Set the permitted data limit to higher than the amount of input data entered in the record setting menu (page 40).
Recording is not performed in accordance with the settings.	<ul style="list-style-type: none"> If the recording status displays 'Exceeds the maximum hard disc performance', set the recording size according to the recording performance specifications for each HDD condition. (Refer to "Record Settings" in the menu settings. (Page 39))
The recording screen will slow down.	<ul style="list-style-type: none"> Check whether the recording performance specifications for each HDD condition match the actual recording settings. (Refer to "Record Settings" in the menu settings. (Page 39)) If the data volume of a video exceeds the playing performance, only the main frame is played. (Refer to "Product Specifications" in the appendix. (Page 75))
If recording loss persists continuously	<ul style="list-style-type: none"> Reset the camera recording profile to let the entire recording bps size fit the recording performance for each HDD condition. (Refer to "Record Settings" in the menu settings. (Page 39)) <ul style="list-style-type: none"> Check the HDD status and determine whether inspection or replacement is necessary. (Refer to "Storage Device" in the menu settings. (Page 36))
Bootling log screen does not proceed further in the [] state.	<ul style="list-style-type: none"> HDD may be problematic. Please visit your nearest customer center to check the HDD.

When a "work that uses the Library" uses material from a header file that is part of the Library, the object code for the work may be a derivative work of the Library even though the source code is not. Whether this is true is especially significant if the work can be linked without the Library, or if the work is itself a library. The threshold for this to be true is not precisely defined by law.

If such an object file uses only numerical parameters, data structure layouts and accessors, and small macros and small inline functions (ten lines or less in length), then the use of the object file is unrestricted, regardless of whether it is legally a derivative work. (Executables containing this object code plus portions of the Library will still fall under Section 6.)

Otherwise, if the work is a derivative of the Library, you may distribute the object code for the work under the terms of Section 6. Any executables containing that work also fall under Section 6, whether or not they are linked directly with the Library itself.

6. As an exception to the Sections above, you may also combine or link a "work that uses the Library" with the Library to produce a work containing portions of the Library, and distribute that work under terms of your choice, provided that the terms permit modification of the work for the customer's own use and reverse engineering for debugging such modifications.

You must give prominent notice with each copy of the work that the Library is used in it and that the Library and its use are covered by this License. You must supply a copy of this License. If the work during execution displays copyright notices, you must include the copyright notice for the Library among them, as well as a reference directing the user to the copy of this License. Also, you must do one of these things:

- Accompany the work with the complete corresponding machine-readable source code for the Library including whatever changes were used in the work (which must be distributed under Sections 1 and 2 above); and, if the work is an executable linked with the Library, with the complete machine-readable "work that uses the Library", as object code and/or source code, so that the user can modify the Library and then relink to produce a modified executable containing the modified Library. (It is understood that the user who changes the contents of definitions files in the Library will not necessarily be able to recompile the application to use the modified definitions.)
- Use a suitable shared library mechanism for linking with the Library. A suitable mechanism is one that (1) uses at run time a copy of the library already present on the user's computer system, rather than copying library functions into the executable, and (2) will operate properly with a modified version of the library, if the user installs one, as long as the modified version is interface-compatible with the version that the work was made with.
- Accompany the work with a written offer, valid for at least three years, to give the same user the materials specified in Subsection 6a, above, for a charge no more than the cost of performing this distribution.
- If distribution of the work is made by offering access to copy from a designated place, offer equivalent access to copy the above specified materials from the same place.
- Verify that the user has already received a copy of these materials or that you have already sent this user a copy.

For an executable, the required form of the "work that uses the Library" must include any data and utility programs needed for reproducing the executable from it. However, as a special exception, the materials to be distributed need not include anything that is normally distributed (in either source or binary form) with the major components (compiler, kernel, and so on) of the operating system on which the executable runs, unless that component itself accompanies the executable.

It may happen that this requirement contradicts the license restrictions of other proprietary libraries that do not normally accompany the operating system. Such a contradiction means you cannot use both them and the Library together in an executable that you distribute.

7. You may place library facilities that are a work based on the Library side-by-side in a single library together with other library facilities not covered by this License, and distribute such a combined library, provided that the separate distribution of the work based on the Library and of the other library facilities is otherwise permitted, and provided that you do these two things:

- Accompany the combined library with a copy of the same work based on the Library, uncombined with any other library facilities. This must be distributed under the terms of the Sections above.
- Give prominent notice with the combined library of the fact that part of it is a work based on the Library, and explaining where to find the accompanying uncombined form of the same work.

8. You may not copy, modify, sublicense, link with, or distribute the Library except as expressly provided under this License. Any attempt otherwise to copy, modify, sublicense, link with, or distribute the Library is void, and will automatically terminate your rights under this License. However, parties who have received copies, or rights, from you under this License will not have their licenses terminated so long as such parties remain in full compliance.

9. You are not required to accept this License, since you have not signed it. However, nothing else grants you permission to modify or distribute the Library or its derivative works. These actions are prohibited by law if you do not accept this License. Therefore, by modifying or distributing the Library (or any work based on the Library), you indicate your acceptance of this License to do so, and all its terms and conditions for copying, distributing or modifying the Library or works based on it.

10. Each time you redistribute the Library (or any work based on the Library), the recipient automatically receives a license from the original licensor to copy, distribute, link with or modify the Library subject to these terms and conditions. You may not impose any further restrictions on the recipients' exercise of the rights granted herein. You are not responsible for enforcing compliance by third parties with this License.

11. If, as a consequence of a court judgment or allegation of patent infringement or for any other reason (not limited to patent issues), conditions are imposed on you (whether by court order, agreement or otherwise) that contradict the conditions of this License, they do not excuse you from the conditions of this License. If you cannot distribute so as to satisfy simultaneously your obligations under this License and any other pertinent obligations, then as a consequence you may not distribute the Library at all. For example, if a patent license would not permit royalty-free redistribution of the Library by all those who receive copies directly or indirectly through you, then the only way you could satisfy both it and this License would be to refrain entirely from distribution of the Library.

If any portion of this section is held invalid or unenforceable under any particular circumstance, the balance of the section is intended to apply, and the section as a whole is intended to apply in other circumstances.

It is not the purpose of this section to induce you to infringe any patents or other property right claims or to contest validity of any such claims; this section has the sole purpose of protecting the integrity of the free software distribution system which is implemented by public license practices. Many people have made generous contributions to the wide range of software distributed through that system in reliance on consistent application of that system; it is up to the author/donor to decide if he or she is willing to distribute software through any other system and a licensee cannot impose that choice.

This section is intended to make thoroughly clear what is believed to be a consequence of the rest of this License.

12. If the distribution and/or use of the Library is restricted in certain countries either by patents or by copyrighted interfaces, the original copyright holder who places the Library under this License may add an explicit geographical distribution limitation excluding those countries, so that distribution is permitted only in or among countries not thus excluded. In such case, this License incorporates the limitation as if written in the body of this License.

13. The Free Software Foundation may publish revised and/or new versions of the Lesser General Public License from time to time. Such new versions will be similar in spirit to the present version, but may differ in detail to address new problems or concerns.

Each version is given a distinguishing version number. If the Library specifies a version number of this License which applies to it and "any later version", you have the option of following the terms and conditions either of that version or of any later version published by the Free Software Foundation. If the Library does not specify a license version number, you may choose any version ever published by the Free Software Foundation.

14. If you wish to incorporate parts of the Library into other free programs whose distribution conditions are incompatible with these, write to the author to ask for permission. For software which is copyrighted by the Free Software Foundation, write to the Free Software Foundation; we sometimes make exceptions for this. Our decision will be guided by the two goals of preserving the free status of all derivatives of our free software and of promoting the sharing and reuse of software generally.

NO WARRANTY

15. BECAUSE THE LIBRARY IS LICENSED FREE OF CHARGE, THERE IS NO WARRANTY FOR THE LIBRARY, TO THE EXTENT PERMITTED

BY APPLICABLE LAW. EXCEPT WHEN OTHERWISE STATED IN WRITING THE COPYRIGHT HOLDERS AND/OR OTHER PARTIES PROVIDE THE LIBRARY "AS IS" WITHOUT WARRANTY OF ANY KIND, EITHER EXPRESSED OR IMPLIED, INCLUDING, BUT NOT LIMITED TO, THE IMPLIED WARRANTIES OF MERCHANTABILITY AND FITNESS FOR A PARTICULAR PURPOSE. THE ENTIRE RISK AS TO THE QUALITY AND PERFORMANCE OF THE LIBRARY IS WITH YOU. SHOULD THE LIBRARY PROVE DEFECTIVE, YOU ASSUME THE COST OF ALL NECESSARY SERVICING, REPAIR OR CORRECTION.

16. IN NO EVENT UNLESS REQUIRED BY APPLICABLE LAW OR AGREED TO IN WRITING WILL ANY COPYRIGHT HOLDER, OR ANY OTHER PARTY WHO MAY MODIFY AND/OR REDISTRIBUTE THE LIBRARY AS PERMITTED ABOVE, BE LIABLE TO YOU FOR DAMAGES, INCLUDING ANY GENERAL, SPECIAL, INCIDENTAL OR CONSEQUENTIAL DAMAGES ARISING OUT OF THE USE OR INABILITY TO USE THE LIBRARY (INCLUDING BUT NOT LIMITED TO LOSS OF DATA OR DATA BEING RENDERED INACCURATE OR LOSSES SUSTAINED BY YOU OR THIRD PARTIES OR A FAILURE OF THE LIBRARY TO OPERATE WITH ANY OTHER SOFTWARE), EVEN IF SUCH HOLDER OR OTHER PARTY HAS BEEN ADVISED OF THE POSSIBILITY OF SUCH DAMAGES.

END OF TERMS AND CONDITIONS

How to Apply These Terms to Your New Libraries

If you develop a new library, and you want it to be of the greatest possible use to the public, we recommend making it free software that everyone can redistribute and change. You can do so by permitting redistribution under these terms (or, alternatively, under the terms of the ordinary General Public License).

To apply these terms, attach the following notices to the library. It is safest to attach them to the start of each source file to most effectively convey the exclusion of warranty; and each file should have at least the "copyright" line and a pointer to where the full notice is found.

```
one line to give the library's name and an idea of what it does.
Copyright (C) year name of author
This library is free software; you can redistribute it and/or
modify it under the terms of the GNU Lesser General Public
License as published by the Free Software Foundation; either
version 2.1 of the License, or (at your option) any later version.
This library is distributed in the hope that it will be useful,
but WITHOUT ANY WARRANTY; without even the implied warranty of
MERCHANTABILITY or FITNESS FOR A PARTICULAR PURPOSE.
See the GNU
Lesser General Public License for more details.
You should have received a copy of the GNU Lesser General Public
License along with this library; if not, write to the Free Software
Foundation, Inc., 59 Temple Place, Suite 330, Boston, MA 02111-
1307 USA
```

Also add information on how to contact you by electronic and paper mail.

You should also get your employer (if you work as a programmer) or your school, if any, to sign a "copyright disclaimer" for the library, if necessary. Here is a sample; alter the names:

```
Yoyodyne, Inc., hereby disclaims all copyright interest in
the library 'Frob' (a library for tweaking knobs) written
by James Random Hacker.

signature of Ty Coon, 1 April 1990
Ty Coon, President of Vice
```

That's all there is to it!

MOZILLA PUBLIC LICENSE

Copyright (c) 2004, Apple Computer, Inc. and The Mozilla Foundation.
Copyright (c) 2004-2005 HighPoint Technologies, Inc.
Copyright (c) 2004-2005 HighPoint Technologies, Inc.

Version 1.1

1. Definitions.

1.0.1. "Commercial Use" means distribution or otherwise making the Covered Code available to a third party.

1.1. "Contributor" means each entity that creates or contributes to the creation of Modifications.

1.2. "Contributor Version" means the combination of the Original Code, prior Modifications used by a Contributor, and the Modifications made by that particular Contributor.

1.3. "Covered Code" means the Original Code or Modifications or the combination of the Original Code and Modifications, in each case including portions thereof.

1.4. "Electronic Distribution Mechanism" means a mechanism generally accepted in the software development community for the electronic transfer of data.

1.5. "Executable" means Covered Code in any form other than Source Code.

1.6. "Initial Developer" means the individual or entity identified as the Initial Developer in the Source Code notice required by **Exhibit A**.

1.7. "Larger Work" means a work which combines Covered Code or portions thereof with code not governed by the terms of this License.

1.8. "License" means this document.

1.8.1. "Licensable" means having the right to grant, to the maximum extent possible, whether at the time of the initial grant or subsequently acquired, any and all of the rights conveyed herein.

1.9. "Modifications" means any addition to or deletion from the substance or structure of either the Original Code or any previous Modifications. When Covered Code is released as a series of files, a Modification is:

- Any addition to or deletion from the contents of a file containing Original Code or previous Modifications.
- Any new file that contains any part of the Original Code or previous Modifications.

1.10. "Original Code" means Source Code of computer software code which is described in the Source Code notice required by **Exhibit A** as Original Code, and which, at the time of its release under this License is not already Covered Code governed by this License.

1.10.1. "Patent Claims" means any patent claim(s), now owned or hereafter acquired, including without limitation, method, process, and apparatus claims, in any patent Licensable by grantor.

1.11. "Source Code" means the preferred form of the Covered Code for making modifications to it, including all modules it contains, plus any associated interface definition files, scripts used to control compilation and installation of an Executable, or source code differential comparisons against either the Original Code or another well known, available Covered Code of the Contributor's choice. The Source Code can be in a compressed or archival form, provided the appropriate decompression or de-archiving software is widely available for no charge.

1.12. "You" (or "Your") means an individual or a legal entity exercising rights under, and complying with all of the terms of, this License or a future version of this License issued under Section 6.1. For legal entities, "You" includes any entity which controls, is controlled by, or is under common control with You. For purposes of this definition, "control" means (a) the power, direct or indirect, to cause the direction or management of such entity, whether by contract or otherwise, or (b) ownership of more than fifty percent (50%) of the outstanding shares or beneficial ownership of such entity.

2. Source Code License.

2.1. The Initial Developer Grant. The Initial Developer hereby grants You a world-wide, royalty-free, non-exclusive license, subject to third party intellectual property claims:

- under intellectual property rights (other than patent or trademark) Licensable by Initial Developer to use, reproduce, modify, display, perform, sublicense and distribute the Original Code (or portions thereof) with or without Modifications, and/or as part of a Larger Work; and
- under Patents Claims infringed by the making, using or selling of Original Code, to make, have made, use, practice, sell, and offer for sale, and/or otherwise dispose of the Original Code (or portions thereof).

(c) the licenses granted in this Section 2.1(a) and (b) are effective on the date Initial Developer first distributes Original Code under the terms of this License.

(d) Notwithstanding Section 2.1(b) above, no patent license is granted: 1) for code that You delete from the Original Code; 2) separate from the Original Code; or 3) for infringements caused by: i) the modification of the Original Code or ii) the combination of the Original Code with other software or devices.

2.2. Contributor Grant. Subject to third party intellectual property claims, each Contributor hereby grants You a world-wide, royalty-free, non-exclusive license

(a) under intellectual property rights (other than patent or trademark) Licensable by Contributor, to use, reproduce, modify, display, perform, sublicense and distribute the Modifications created by such Contributor (or portions thereof) either on an unmodified basis, with other Modifications, as Covered Code and/or as part of a Larger Work; and

(b) under Patent Claims infringed by the making, using, or selling of Modifications made by that Contributor either alone and/or in combination with its Contributor Version (or portions of such combination), to make, use, sell, offer for sale, have made, and/or otherwise dispose of: 1) Modifications made by that Contributor (or portions thereof); and 2) the combination of Modifications made by that Contributor with its Contributor Version (or portions of such combination).

(c) the licenses granted in Sections 2.2(a) and 2.2(b) are effective on the date Contributor first makes Commercial Use of the Covered Code.

(d) Notwithstanding Section 2.2(b) above, no patent license is granted: 1) for any code that Contributor has deleted from the Contributor Version; 2) separate from the Contributor Version; 3) for infringements caused by: i) third party modifications of Contributor Version or ii) the combination of Modifications made by that Contributor with other software (except as part of the Contributor Version) or other devices; or 4) under Patent Claims infringed by Covered Code in the absence of Modifications made by that Contributor.

3. Distribution Obligations.

3.1. Application of License. The Modifications which You create or to which You contribute are governed by the terms of this License, including without limitation Section 2.2. The Source Code version of Covered Code may be distributed only under the terms of this License or a future version of this License released under Section 6.1, and You must include a copy of this License with every copy of the Source Code You distribute. You may not offer or impose any terms on any Source Code version that alters or restricts the applicable version of this License or the recipients' rights hereunder. However, You may include an additional document offering the additional rights described in Section 3.5.

3.2. Availability of Source Code. Any Modification which You create or to which You contribute must be made available in Source Code form under the terms of this License either on the same media as an Executable version or via an accepted Electronic Distribution Mechanism to anyone to whom you made an Executable version available; and if made available via Electronic Distribution Mechanism, must remain available for at least twelve (12) months after the date it initially became available, or at least six (6) months after a subsequent version of that particular Modification has been made available to such recipients. You are responsible for ensuring that the Source Code version remains available even if the Electronic Distribution Mechanism is maintained by a third party.

3.3. Description of Modifications. You must cause all Covered Code to which You contribute to contain a file documenting the changes You made to create that Covered Code and the date of any change. You must include a prominent statement that the Modification is derived, directly or indirectly, from Original Code provided by the Initial Developer and including the name of the Initial Developer in (a) the Source Code, and (b) in any notice in an Executable version or related documentation in which You describe the origin or ownership of the Covered Code.

3.4. Intellectual Property Matters

(a) **Third Party Claims.** If Contributor has knowledge that a license under a third party's intellectual property rights is required to exercise the rights granted by such Contributor under Sections 2.1 or 2.2, Contributor must include a text file with the Source Code distribution titled "LEGAL" which describes the claim and the party

making the claim in sufficient detail that a recipient will know whom to contact. If Contributor obtains such knowledge after the Modification is made available as described in Section 3.2, Contributor shall promptly modify the LEGAL file in all copies Contributor makes available thereafter and shall take other steps (such as notifying appropriate mailing lists or newsgroups) reasonably calculated to inform those who received the Covered Code that new knowledge has been obtained.

(b) **Contributor APIs.** If Contributor's Modifications include an application programming interface and Contributor has knowledge of patent licenses which are reasonably necessary to implement that API, Contributor must also include this information in the LEGAL file.

(c) Representations.

Contributor represents that, except as disclosed pursuant to Section 3.4(a) above, Contributor believes that Contributor's Modifications are Contributor's original creation(s) and/or Contributor has sufficient rights to grant the rights conveyed by this License.

3.5. Required Notices. You must duplicate the notice in **Exhibit A** in each file of the Source Code. If it is not possible to put such notice in a particular Source Code file due to its structure, then You must include such notice in a location (such as a relevant directory) where a user would be likely to look for such a notice. If You created one or more Modification(s) You may add your name as a Contributor to the notice described in **Exhibit A**. You must also duplicate this License in any documentation for the Source Code where You describe recipients' rights or ownership rights relating to Covered Code. You may choose to offer, and to charge a fee for, warranty, support, indemnity or liability obligations to one or more recipients of Covered Code. However, You may do so only on Your own behalf, and not on behalf of the Initial Developer or any Contributor. You must make it absolutely clear that any such warranty, support, indemnity or liability obligation is offered by You alone, and You hereby agree to indemnify the Initial Developer and every Contributor for any liability incurred by the Initial Developer or such Contributor as a result of warranty, support, indemnity or liability terms You offer.

3.6. Distribution of Executable Versions. You may distribute Covered Code in Executable form only if the requirements of Section 3.1-3.5 have been met for that Covered Code, and if You include a notice stating that the Source Code version of the Covered Code is available under the terms of this License, including a description of how and where You have fulfilled the obligations of Section 3.2. The notice must be conspicuously included in any notice in an Executable version, related documentation or collateral in which You describe recipients' rights relating to the Covered Code. You may distribute the Executable version of Covered Code or ownership rights under a license of Your choice, which may contain terms different from this License, provided that You are in compliance with the terms of this License and that the license for the Executable version does not attempt to limit or alter the recipient's rights in the Source Code version from the rights set forth in this License. If You distribute the Executable version under a different license You must make it absolutely clear that any terms which differ from this License are offered by You alone, not by the Initial Developer or any Contributor. You hereby agree to indemnify the Initial Developer and every Contributor for any liability incurred by the Initial Developer or such Contributor as a result of any such terms You offer.

3.7. Larger Works. You may create a Larger Work by combining Covered Code with other code not governed by the terms of this License and distribute the Larger Work as a single product. In such a case, You must make sure the requirements of this License are fulfilled for the Covered Code.

4. Inability to Comply Due to Statute or Regulation.

If it is impossible for You to comply with any of the terms of this License with respect to some or all of the Covered Code due to statute, judicial order, or regulation then You must: (a) comply with the terms of this License to the maximum extent possible; and (b) describe the limitations and the code they affect. Such description must be included in the LEGAL file described in Section 3.4 and must be included with all distributions of the Source Code. Except to the extent prohibited by statute or regulation, such description must be sufficiently detailed for a recipient of ordinary skill to be able to understand it.

5. Application of this License.

This License applies to code to which the Initial Developer has attached the notice in **Exhibit A** and to related Covered Code.

6. Versions of the License.

6.1. New Versions. Netscape Communications Corporation ("Netscape") may publish revised and/or new versions of the License from time to time. Each version will be given a distinguishing version number.

6.2. Effect of New Versions. Once Covered Code has been published under a particular version of the License, You may always continue to use it under the terms of that version. You may also choose to use such Covered Code under the terms of any subsequent version of the License published by Netscape. No one other than Netscape has the right to modify the terms applicable to Covered Code created under this License.

6.3. Derivative Works. If You create or use a modified version of this License (which you may only do in order to apply it to code which is not already Covered Code governed by this License), You must (a) rename Your license so that the phrases "Mozilla", "MOZILLAPL", "MOZPL", "Netscape", "MPL", "NPL" or any confusingly similar phrase do not appear in your license (except to note that your license differs from this License) and (b) otherwise make it clear that Your version of the license contains terms which differ from the Mozilla Public License and Netscape Public License. (Filing in the name of the Initial Developer, Original Code or Contributor in the notice described in **Exhibit A** shall not of themselves be deemed to be modifications of this License.)

7. DISCLAIMER OF WARRANTY. COVERED CODE IS PROVIDED UNDER THIS LICENSE ON AN "AS IS" BASIS, WITHOUT WARRANTY OF ANY KIND, EITHER EXPRESSED OR IMPLIED, INCLUDING, WITHOUT LIMITATION, WARRANTIES THAT THE COVERED CODE IS FREE OF DEFECTS, MERCHANTABLE, FIT FOR A PARTICULAR PURPOSE OR NON-INFRINGEMENT. THE ENTIRE RISK AS TO THE QUALITY AND PERFORMANCE OF THE COVERED CODE IS WITH YOU. SHOULD ANY COVERED CODE PROVE DEFECTIVE IN ANY RESPECT, YOU (NOT THE INITIAL DEVELOPER OR ANY OTHER CONTRIBUTOR) ASSUME THE COST OF ANY NECESSARY SERVICING, REPAIR OR CORRECTION. THIS DISCLAIMER OF WARRANTY CONSTITUTES AN ESSENTIAL PART OF THIS LICENSE. NO USE OF ANY COVERED CODE IS AUTHORIZED HEREUNDER EXCEPT UNDER THIS DISCLAIMER.

8. TERMINATION.

8.1. This License and the rights granted hereunder will terminate automatically if You fail to comply with terms herein and fail to cure such breach within 30 days of becoming aware of the breach. All sublicenses to the Covered Code which are properly granted shall survive any termination of this License. Provisions which, by their nature, must remain in effect beyond the termination of this License shall survive.

8.2. If You initiate litigation by asserting a patent infringement claim (excluding declaratory judgment actions) against Initial Developer or a Contributor (the Initial Developer or Contributor against whom You file such action is referred to as "Participant") alleging that:

(a) such Participant's Contributor Version directly or indirectly infringes any patent, then any and all rights granted by such Participant to You under Sections 2.1 and/or 2.2 of this License shall, upon 60 days notice from Participant terminate prospectively, unless if within 60 days after receipt of notice You either: (i) agree in writing to pay Participant a mutually agreeable reasonable royalty for Your past and future use of Modifications made by such Participant, or (ii) withdraw Your litigation claim with respect to the Contributor Version against such Participant. If within 60 days of notice, a reasonable royalty and payment arrangement are not mutually agreed upon in writing by the parties or the litigation claim is not withdrawn, the rights granted by Participant to You under Sections 2.1 and/or 2.2 automatically terminate at the expiration of the 60 day notice period specified above.

(b) any software, hardware, or device, other than such Participant's Contributor Version, directly or indirectly infringes any patent, then any rights granted to You by such Participant under Sections 2.1(b) and 2.2(b) are revoked effective as of the date You first made, used, sold, distributed, or had made, Modifications made by that Participant.

8.3. If You assert a patent infringement claim against Participant alleging that such Participant's Contributor Version directly or indirectly infringes any patent where such claim is resolved (such as by license or settlement) prior to the initiation of patent infringement litigation, then the reasonable value of the licenses granted by such Participant under Sections 2.1 or 2.2 shall be taken into account in determining the amount or value of any payment or license.

8.4. In the event of termination under Sections 8.1 or 8.2 above, all end user license agreements (excluding distributors and resellers) which have been validly granted by You or any distributor hereunder prior to termination shall survive termination.

9. LIMITATION OF LIABILITY. UNDER NO CIRCUMSTANCES AND UNDER NO LEGAL THEORY, WHETHER TORT (INCLUDING NEGLIGENCE), CONTRACT, OR OTHERWISE, SHALL YOU, THE INITIAL DEVELOPER, ANY OTHER CONTRIBUTOR, OR ANY DISTRIBUTOR OF COVERED CODE, OR ANY SUPPLIER OF ANY OF SUCH PARTIES, BE LIABLE TO ANY PERSON FOR ANY INDIRECT, SPECIAL, INCIDENTAL, OR CONSEQUENTIAL DAMAGES OF ANY CHARACTER INCLUDING, WITHOUT LIMITATION, DAMAGES FOR LOSS OF GOODWILL, WORK STOPPAGE, COMPUTER FAILURE OR MALFUNCTION, OR ANY AND ALL OTHER COMMERCIAL DAMAGES OR LOSSES, EVEN IF SUCH PARTY SHALL HAVE BEEN INFORMED OF THE POSSIBILITY OF SUCH DAMAGES. THIS LIMITATION OF LIABILITY SHALL NOT APPLY TO LIABILITY FOR DEATH OR PERSONAL INJURY RESULTING FROM SUCH PARTY'S NEGLIGENCE TO THE EXTENT APPLICABLE LAW PROHIBITS SUCH LIMITATION. SOME JURISDICTIONS DO NOT ALLOW THE EXCLUSION OR LIMITATION OF INCIDENTAL OR CONSEQUENTIAL DAMAGES, SO THIS EXCLUSION AND LIMITATION MAY NOT APPLY TO YOU.

10. U.S. GOVERNMENT END USERS.

The Covered Code is a "commercial item," as that term is defined in 48 C.F.R. 2.101 (Oct. 1995), consisting of "commercial computer software" and "commercial computer software documentation," as such terms are used in 48 C.F.R. 12.212 (Sept. 1995). Consistent with 48 C.F.R. 12.212 and 48 C.F.R. 227.7202-1 through 227.7202-4 (June 1995), all U.S. Government End Users acquire Covered Code with only those rights set forth herein.

11. MISCELLANEOUS.

This License represents the complete agreement concerning subject matter hereof. If any provision of this License is held to be unenforceable, such provision shall be reformed only to the extent necessary to make it enforceable. This License shall be governed by California law provisions (except to the extent applicable law, if any, provides otherwise), excluding its conflict-of-law provisions. With respect to disputes in which at least one party is a citizen of, or an entity chartered or registered to do business in the United States of America, any litigation relating to this License shall be subject to the jurisdiction of the Federal Courts of the Northern District of California, with venue lying in Santa Clara County, California, with the losing party responsible for costs, including without limitation, court costs and reasonable attorneys' fees and expenses. The application of the United Nations Convention on Contracts for the International Sale of Goods is expressly excluded. Any law or regulation which provides that the language of a contract shall be construed against the drafter shall not apply to this License.

12. RESPONSIBILITY FOR CLAIMS.

As between Initial Developer and the Contributors, each party is responsible for claims and damages arising, directly or indirectly, out of its utilization of rights under this License and You agree to work with Initial Developer and Contributors to distribute such responsibility on an equitable basis. Nothing herein is intended or shall be deemed to constitute any admission of liability.

13. MULTIPLE-LICENSED CODE.

Initial Developer may designate portions of the Covered Code as Multiple-Licensed. Multiple-Licensed means that the Initial Developer permits you to utilize portions of the Covered Code under Your choice of the MPL or the alternative licenses, if any, specified by the Initial Developer in the file described in Exhibit A.

EXHIBIT A -Mozilla Public License.

The contents of this file are subject to the Mozilla Public License Version 1.1 (the "License"); you may not use this file except in compliance with the License. You may obtain a copy of the License at <http://www.mozilla.org/MPL/>

Software distributed under the License is distributed on an "AS IS" basis, WITHOUT WARRANTY OF ANY KIND, either express or implied. See the License for the specific language governing rights and limitations under the License.

9. Accepting Warranty or Additional Liability. While redistributing the Work or Derivative Works thereof, You may choose to offer, and charge a fee for, acceptance of support, warranty, indemnity, or other liability obligations and/or rights consistent with this License. However, in accepting such obligations, You may act only on Your own behalf and on Your sole responsibility, not on behalf of any other Contributor, and only if You agree to indemnify, defend, and hold each Contributor harmless for any liability incurred by, or claims asserted against, such Contributor by reason of your accepting any such warranty or additional liability.

END OF TERMS AND CONDITIONS

APPENDIX: How to apply the Apache License to your work

To apply the Apache License to your work, attach the following boilerplate notice, with the fields enclosed by brackets "[]" replaced with your own identifying information. (Don't include the brackets!) The text should be enclosed in the appropriate comment syntax for the file format. We also recommend that a file or class name and description of purpose be included on the same "printed page" as the copyright notice for easier identification within third-party archives.

Copyright [yyyy] [name of copyright owner] Licensed under the Apache License, Version 2.0 (the "License"); you may not use this file except in compliance with the License. You may obtain a copy of the License at <http://www.apache.org/licenses/LICENSE-2.0> Unless required by applicable law or agreed to in writing, software distributed under the License is distributed on an "AS IS" BASIS, WITHOUT WARRANTIES OR CONDITIONS OF ANY KIND, either express or implied. See the License for the specific language governing permissions and limitations under the License.

The zlib/libpng License

Copyright (c) 2011 Lee Thomason

Copyright (c) 1995-2012 Jean-loup Gailly and Mark Adler

Copyright (c) 1998-2012 Glenn Randers-Pehrson

Copyright (c) 2003-2005 Hector Mauricio Rodriguez Segura

Copyright (c) 1995-2009 Nullsoft and Contributors

Copyright (c) 2002-2008 Davide Pizzolato

This software is provided 'as-is', without any express or implied warranty. In no event will the authors be held liable for any damages arising from the use of this software.;

Permission is granted to anyone to use this software for any purpose, including commercial applications, and to alter it and redistribute it freely, subject to the following restrictions:

- The origin of this software must not be misrepresented; you must not claim that you wrote the original software. If you use this software in a product, an acknowledgment in the product documentation would be appreciated but is not required.
- Altered source versions must be plainly marked as such, and must not be misrepresented as being the original software.
- This notice may not be removed or altered from any source distribution.

Boost Software License - Version 1.0

August 17th, 2003

Permission is hereby granted, free of charge, to any person or organization obtaining a copy of the software and accompanying documentation covered by this license (the "Software") to use, reproduce, display, distribute, execute, and transmit the Software, and to prepare derivative works of the Software, and to permit third-parties to whom the Software is furnished to do so, all subject to the following:

The copyright notices in the Software and this entire statement, including the above license grant, this restriction and the following disclaimer, must be included in all copies of the Software, in whole or in part, and all derivative works of the Software, unless such copies or derivative works are solely in the form of machine-executable object code generated by a source language processor.

THE SOFTWARE IS PROVIDED "AS IS", WITHOUT WARRANTY OF ANY KIND, EXPRESS OR IMPLIED, INCLUDING BUT NOT LIMITED TO THE WARRANTIES OF MERCHANTABILITY, FITNESS FOR A PARTICULAR PURPOSE, TITLE AND NON-INFRINGEMENT. IN NO

EVENT SHALL THE COPYRIGHT HOLDERS OR ANYONE DISTRIBUTING THE SOFTWARE BE LIABLE FOR ANY DAMAGES OR OTHER LIABILITY, WHETHER IN CONTRACT, TORT OR OTHERWISE, ARISING FROM, OUT OF OR IN CONNECTION WITH THE SOFTWARE OR THE USE OR OTHER DEALINGS IN THE SOFTWARE.

Curl License

Copyright (c) 1996 - 2003, Daniel Stenberg, <daniel@haxx.se>.

All rights reserved.

Permission to use, copy, modify, and distribute this software for any purposewith or without fee is hereby granted, provided that the above copyright notice and this permission notice appear in all copies.

THE SOFTWARE IS PROVIDED "AS IS", WITHOUT WARRANTY OF ANY KIND, EXPRESS OR IMPLIED, INCLUDING BUT NOT LIMITED TO THE WARRANTIES OF MERCHANTABILITY, FITNESS FOR A PARTICULAR PURPOSE AND NONINFRINGEMENT OF THIRD PARTY RIGHTS. IN NO EVENT SHALL THE AUTHORS OR COPYRIGHT HOLDERS BE LIABLE FOR ANY CLAIM, DAMAGES OR OTHER LIABILITY, WHETHER IN AN ACTION OF CONTRACT, TORT OR OTHERWISE, ARISING FROM, OUT OF OR IN CONNECTION WITH THE SOFTWARE OR THE USEOR OTHER DEALINGS IN THE SOFTWARE.

Except as contained in this notice, the name of a copyright holder shall not be used in advertising or otherwise to promote the sale, use or other dealings in this Software without prior written authorization of the copyright holder.

Microsoft Public License (Ms-PL)

Copyright (c) 2009 Wong Shao Voon

Copyright (c) 1998-2012 Glenn Randers-Pehrson

This license governs use of the accompanying software. If you use the software, you accept this license. If you do not accept the license, do not use the software.

1. Definitions

The terms "reproduce," "reproduction," "derivative works," and "distribution" have the same meaning here as under U.S. copyright law.

A "contribution" is the original software, or any additions or changes to the software.

A "contributor" is any person that distributes its contribution under this license.

"Licensed patents" are a contributor's patent claims that read directly on its contribution.

2. Grant of Rights

A. Copyright Grant- Subject to the terms of this license, including the license conditions and limitations in section 3, each contributor grants you a non-exclusive, worldwide, royalty-free copyright license to reproduce its contribution, prepare derivative works of its contribution, and distribute its contribution or any derivative works that you create.

B. Patent Grant- Subject to the terms of this license, including the license conditions and limitations in section 3, each contributor grants you a non-exclusive, worldwide, royalty-free license under its licensed patents to make, have made, use, sell, offer for sale, import, and/or otherwise dispose of its contribution in the software or derivative works of the contribution in the software.

3. Conditions and Limitations

- No Trademark License- This license does not grant you rights to use any contributors' name, logo, or trademarks.
- If you bring a patent claim against any contributor over patents that you claim are infringed by the software, your patent license from such contributor to the software ends automatically.
- If you distribute any portion of the software, you must retain all copyright, patent, trademark, and attribution notices that are present in the software.
- If you distribute any portion of the software in source code form, you may do so only under this license by including a complete copy of this license with your distribution. If you distribute any portion of the software in compiled or object code form, you may only do so under a license that complies with this license.

E. The software is licensed "as-is." You bear the risk of using it. The contributors give no express warranties, guarantees or conditions. You may have additional consumer rights under your local laws which this license cannot change. To the extent permitted under your local laws, the contributors exclude the implied warranties of merchantability, fitness for a particular purpose and non-infringement.

The Code Project Open License (CPOL) 1.02

Copyright (c) 2004..2007 Rob Groves

Preamble

This License governs Your use of the Work. This License is intended to allow developers to use the Source Code and Executable Files provided as part of the Work in any application in any form.

The main points subject to the terms of the License are:

- Source Code and Executable Files can be used in commercial applications;
- Source Code and Executable Files can be redistributed; and
- Source Code can be modified to create derivative works.
- No claim of suitability, guarantee, or any warranty whatsoever is provided. The software is provided "as-is".
- The Article accompanying the Work may not be distributed or republished without the Author's consent

This License is entered between You, the individual or other entity reading or otherwise making use of the Work licensed pursuant to this License and the individual or other entity which offers the Work under the terms of this License ("Author").

License

THE WORK (AS DEFINED BELOW) IS PROVIDED UNDER THE TERMS OF THIS CODE PROJECT OPEN LICENSE ("LICENSE"). THE WORK IS PROTECTED BY COPYRIGHT AND/OR OTHER APPLICABLE LAW. ANY USE OF THE WORK OTHER THAN AS AUTHORIZED UNDER THIS LICENSE OR COPYRIGHT LAW IS PROHIBITED.

BY EXERCISING ANY RIGHTS TO THE WORK PROVIDED HEREIN, YOU ACCEPT AND AGREE TO BE BOUND BY THE TERMS OF THIS LICENSE. THE AUTHOR GRANTS YOU THE RIGHTS CONTAINED HEREIN IN CONSIDERATION OF YOUR ACCEPTANCE OF SUCH TERMS AND CONDITIONS. IF YOU DO NOT AGREE TO ACCEPT AND BE BOUND BY THE TERMS OF THIS LICENSE, YOU CANNOT MAKE ANY USE OF THE WORK.

1. Definitions.

- "Articles"** means, collectively, all articles written by Author which describes how the Source Code and Executable Files for the Work may be used by a user.
- "Author"** means the individual or entity that offers the Work under the terms of this License.
- "Derivative Work"** means a work based upon the Work or upon the Work and other pre-existing works.
- "Executable Files"** refer to the executables, binary files, configuration and any required data files included in the Work.
- "Publisher"** means the provider of the website, magazine, CD-ROM, DVD or other medium from or by which the Work is obtained by You.
- "Source Code"** refers to the collection of source code and configuration files used to create the Executable Files.
- "Standard Version"** refers to such a Work if it has not been modified, or has been modified in accordance with the consent of the Author, such consent being in the full discretion of the Author.
- "Work"** refers to the collection of files distributed by the Publisher, including the Source Code, Executable Files, binaries, data files, documentation, whitepapers and the Articles.
- "You"** is you, an individual or entity wishing to use the Work and exercise your rights under this License.

2. **Fair Use/Fair Use Rights.** Nothing in this License is intended to reduce, limit, or restrict any rights arising from fair use, fair dealing, first sale or other limitations on the exclusive rights of the copyright owner under copyright law or other applicable laws.

3. **License Grant.** Subject to the terms and conditions of this License, the Author hereby grants You a worldwide, royalty-free, non-exclusive, perpetual (for the duration of the applicable copyright) license to exercise the rights in the Work as stated below:

- You may use the standard version of the Source Code or Executable Files in Your own applications.
- You may apply bug fixes, portability fixes and other modifications obtained from the Public Domain or from the Author. A Work modified in such a way shall still be considered the standard version and will be subject to this License.
- You may otherwise modify Your copy of this Work (excluding the Articles) in any way to create a Derivative Work, provided that You insert a prominent notice in each changed file stating how, when and where You changed that file.
- You may distribute the standard version of the Executable Files and Source Code or Derivative Work in aggregate with other (possibly commercial) programs as part of a larger (possibly commercial) software distribution.
- The Articles discussing the Work published in any form by the author may not be distributed or republished without the Author's consent. The author retains copyright to any such Articles. You may use the Executable Files and Source Code pursuant to this License but you may not repost or republish or otherwise distribute or make available the Articles, without the prior written consent of the Author.

Any subroutines or modules supplied by You and linked into the Source Code or Executable Files this Work shall not be considered part of this Work and will not be subject to the terms of this License.

4. **Patent License.** Subject to the terms and conditions of this License, each Author hereby grants to You a perpetual, worldwide, non-exclusive, no-charge, royalty-free, irrevocable (except as stated in this section) patent license to make, have made, use, import, and otherwise transfer the Work.

5. Restrictions. The license granted in Section 3 above is expressly made subject to and limited by the following restrictions:

- You agree not to remove any of the original copyright, patent, trademark, and attribution notices and associated disclaimers that may appear in the Source Code or Executable Files.
- You agree not to advertise or in any way imply that this Work is a product of Your own.
- The name of the Author may not be used to endorse or promote products derived from the Work without the prior written consent of the Author.
- You agree not to sell, lease, or rent any part of the Work. This does not restrict you from including the Work or any part of the Work inside a larger software distribution that itself is being sold. The Work by itself, though, cannot be sold, leased or rented.
- You may distribute the Executable Files and Source Code only under the terms of this License, and You must include a copy of, or the Uniform Resource Identifier for, this License with every copy of the Executable Files or Source Code You distribute and ensure that anyone receiving such Executable Files and Source Code agrees that the terms of this License apply to such Executable Files and/or Source Code. You may not offer or impose any terms on the Work that alter or restrict the terms of this License or the recipients' exercise of the rights granted hereunder. You may not sublicense the Work. You must keep intact all notices that refer to this License and to the disclaimer of warranties. You may not distribute the Executable Files or Source Code with any technological measures that control access or use of the Work in a manner inconsistent with the terms of this License.
- You agree not to use the Work for illegal, immoral or improper purposes, or on pages containing illegal, immoral or improper material. The Work is subject to applicable export laws. You agree to comply with all such laws and regulations that may apply to the Work after Your receipt of the Work.

6. **Representations, Warranties and Disclaimer.** THIS WORK IS PROVIDED "AS IS", "WHERE IS" AND "AS AVAILABLE", WITHOUT ANY EXPRESS OR IMPLIED WARRANTIES OR CONDITIONS OR GUARANTEES. YOU, THE USER, ASSUME ALL RISK IN ITS USE, INCLUDING COPYRIGHT INFRINGEMENT, PATENT INFRINGEMENT, SUITABILITY, ETC. AUTHOR EXPRESSLY DISCLAIMS ALL EXPRESS, IMPLIED OR STATUTORY WARRANTIES OR CONDITIONS, INCLUDING WITHOUT LIMITATION, WARRANTIES OR CONDITIONS OF MERCHANTABILITY, MERCHANTABLE QUALITY OR FITNESS FOR A PARTICULAR PURPOSE, OR ANY WARRANTY OF TITLE OR

NON-INFRINGEMENT, OR THAT THE WORK (OR ANY PORTION THEREOF) IS CORRECT, USEFUL, BUG-FREE OR FREE OF VIRUSES. YOU MUST PASS THIS DISCLAIMER ON WHENEVER YOU DISTRIBUTE THE WORK OR DERIVATIVE WORKS.

7. **Indemnity.** You agree to defend, indemnify and hold harmless the Author and the Publisher from and against any claims, suits, losses, damages, liabilities, costs, and expenses (including reasonable legal or attorneys' fees) resulting from or relating to any use of the Work by You.

8. **Limitation on Liability.** EXCEPT TO THE EXTENT REQUIRED BY APPLICABLE LAW, IN NO EVENT WILL THE AUTHOR OR THE PUBLISHER BE LIABLE TO YOU ON ANY LEGAL THEORY FOR ANY SPECIAL, INCIDENTAL, CONSEQUENTIAL, PUNITIVE OR EXEMPLARY DAMAGES ARISING OUT OF THIS LICENSE OR THE USE OF THE WORK OR OTHERWISE, EVEN IF THE AUTHOR OR THE PUBLISHER HAS BEEN ADVISED OF THE POSSIBILITY OF SUCH DAMAGES.

9. Termination.

a. This License and the rights granted hereunder will terminate automatically upon any breach by You of any term of this License. Individuals or entities who have received Derivative Works from You under this License, however, will not have their licenses terminated provided such individuals or entities remain in full compliance with those licenses. Sections 1, 2, 6, 7, 8, 9, 10 and 11 will survive any termination of this License.

b. If You bring a copyright, trademark, patent or any other infringement claim against any contributor over infringements You claim are made by the Work, your License from such contributor to the Work ends automatically.

c. Subject to the above terms and conditions, this License is perpetual (for the duration of the applicable copyright in the Work). Notwithstanding the above, the Author reserves the right to release the Work under different license terms or to stop distributing the Work at any time; provided, however that any such election will not serve to withdraw this License (or any other license that has been, or is required to be, granted under the terms of this License), and this License will continue in full force and effect unless terminated as stated above.

10. **Publisher.** The parties hereby confirm that the Publisher shall not, under any circumstances, be responsible for and shall not have any liability in respect of the subject matter of this License. The Publisher makes no warranty whatsoever in connection with the Work and shall not be liable to You or any party on any legal theory for any damages whatsoever, including without limitation any general, special, incidental or consequential damages arising in connection to this license. The Publisher reserves the right to cease making the Work available to You at any time without notice

11. Miscellaneous

a. This License shall be governed by the laws of the location of the head office of the Author or if the Author is an individual, the laws of location of the principal place of residence of the Author.

b. If any provision of this License is invalid or unenforceable under applicable law, it shall not affect the validity or enforceability of the remainder of the terms of this License, and without further action by the parties to this License, such provision shall be reformed to the minimum extent necessary to make such provision valid and enforceable.

c. No term or provision of this License shall be deemed waived and no breach consented to unless such waiver or consent shall be in writing and signed by the party to be charged with such waiver or consent.

d. This License constitutes the entire agreement between the parties with respect to the Work licensed herein. There are no understandings, agreements or representations with respect to the Work not specified herein. The Author shall not be bound by any additional provisions that may appear in any communication from You. This License may not be modified without the mutual written agreement of the Author and You.

The Independent JPEG Group's JPEG software

Copyright (C) 1991-1997, Thomas G. Lane.

README for release 6b of 27-Mar-1998

=====

This distribution contains the sixth public release of the Independent JPEG Group's free JPEG software. You are welcome to redistribute this software and to use it for any purpose, subject to the conditions under LEGAL ISSUES, below.

Serious users of this software (particularly those incorporating it into larger programs) should contact IJG at jpeg-info@uunet.uu.net to be added to our electronic mailing list. Mailing list members are notified of updates and have a chance to participate in technical discussions, etc.

This software is the work of Tom Lane, Philip Gladstone, Jim Boucher, Lee Crocker, Julian Minguillon, Luis Ortiz, George Phillips, Davide Rossi, Guido Vollbeding, Ge' Weijers, and other members of the Independent JPEG Group.

IJG is not affiliated with the official ISO JPEG standards committee.

LEGAL ISSUES

=====

In plain English:

1. We don't promise that this software works. (But if you find any bugs, please let us know!)
2. You can use this software for whatever you want. You don't have to pay us.
3. You may not pretend that you wrote this software. If you use it in a program, you must acknowledge somewhere in your documentation that you've used the IJG code.

In legalese:

The authors make NO WARRANTY or representation, either express or implied, with respect to this software, its quality, accuracy, merchantability, or fitness for a particular purpose. This software is provided "AS IS", and you, its user, assume the entire risk as to its quality and accuracy.

This software is copyright (C) 1991-1998, Thomas G. Lane. All Rights Reserved except as specified below.

Permission is hereby granted to use, copy, modify, and distribute this software (or portions thereof) for any purpose, without fee, subject to these conditions:

(1) If any part of the source code for this software is distributed, then this README file must be included, with this copyright and no-warranty notice unaltered; and any additions, deletions, or changes to the original files must be clearly indicated in accompanying documentation.

(2) If only executable code is distributed, then the accompanying documentation must state that "this software is based in part on the work of the Independent JPEG Group".

(3) Permission for use of this software is granted only if the user accepts full responsibility for any undesirable consequences; the authors accept NO LIABILITY for damages of any kind.

These conditions apply to any software derived from or based on the IJG code, not just to the unmodified library. If you use our work, you ought to acknowledge us.

Permission is NOT granted for the use of any IJG author's name or company name in advertising or publicity relating to this software or products derived from it. This software may be referred to only as "the Independent JPEG Group's software".

We specifically permit and encourage the use of this software as the basis of commercial products, provided that all warranty or liability claims are assumed by the product vendor.

ansi2knr.c is included in this distribution by permission of L. Peter Deutsch, sole proprietor of its copyright holder, Aladdin Enterprises of Menlo Park, CA. ansi2knr.c is NOT covered by the above copyright and conditions, but instead by the usual distribution terms of the Free Software Foundation; principally, that you must include source code if you redistribute it. (See the file ansi2knr.c for full details.) However, since ansi2knr.c is not needed as part of any program generated from the IJG code, this does not limit you more than the foregoing paragraphs do.

The Unix configuration script "configure" was produced with GNU Autoconf. It is copyright by the Free Software Foundation but is freely distributable. The same holds for its supporting scripts (config.guess, config.sub, ltconfig, ltmain.sh). Another support script, install-sh, is copyright by M.I.T. but is also freely distributable.

It appears that the arithmetic coding option of the JPEG spec is covered by patents owned by IBM, AT&T, and Mitsubishi. Hence arithmetic coding cannot legally be used without obtaining one or more licenses. For this reason, support for arithmetic coding has been removed from

the free JPEG software. (Since arithmetic coding provides only a marginal gain over the unpatented Huffman mode, it is unlikely that very many implementations will support it.) So far as we are aware, there are no patent restrictions on the remaining code.

The IJG distribution formerly included code to read and write GIF files. To avoid entanglement with the Unisys LZW patent, GIF reading support has been removed altogether, and the GIF writer has been simplified to produce "uncompressed GIFs". This technique does not use the LZW algorithm; the resulting GIF files are larger than usual, but are readable by all standard GIF decoders.

We are required to state that

"The Graphics Interchange Format(c) is the Copyright property of CompuServe Incorporated. GIF(sm) is a Service Mark property of CompuServe Incorporated."

RSA MD4 or MD5 Message-Digest Algorithm License

License to copy and use this software is granted provided that it is identified as the "RSA Data Security, Inc. MD4 or MD5 Message-Digest Algorithm" in all material mentioning or referencing this software or this function.

License is also granted to make and use derivative works provided that such works are identified as "derived from the RSA Data Security, Inc. MD4 or MD5 Message-Digest Algorithm" in all material mentioning or referencing the derived work.

RSA Data Security, Inc. makes no representations concerning either the merchantability of this software or the suitability of this software for any particular purpose. It is provided "as is" without express or implied warranty of any kind.

These notices must be retained in any copies of any part of this documentation and/or software.

The PHP License, version 3.01

Copyright (c) 1999 - 2006 The PHP Group. All rights reserved.

Redistribution and use in source and binary forms, with or without modification, is permitted provided that the following conditions are met:

1. Redistributions of source code must retain the above copyright notice, this list of conditions and the following disclaimer.
2. Redistributions in binary form must reproduce the above copyright notice, this list of conditions and the following disclaimer in the documentation and/or other materials provided with the distribution.
3. The name "PHP" must not be used to endorse or promote products derived from this software without prior written permission. For written permission, please contact group@php.net.
4. Products derived from this software may not be called "PHP", nor may "PHP" appear in their name, without prior written permission from group@php.net. You may indicate that your software works in conjunction with PHP by saying "Foo for PHP" instead of calling it "PHP Foo" or "phpfoo"
5. The PHP Group may publish revised and/or new versions of the license from time to time. Each version will be given a distinguishing version number. Once covered code has been published under a particular version of the license, you may always continue to use it under the terms of that version. You may also choose to use such covered code under the terms of any subsequent version of the license published by the PHP Group. No one other than the PHP Group has the right to modify the terms applicable to covered code created under this License.
6. Redistributions of any form whatsoever must retain the following acknowledgment:

"This product includes PHP software, freely available from {http://www.php.net/software/}".

THIS SOFTWARE IS PROVIDED BY THE PHP DEVELOPMENT TEAM "AS IS" AND ANY EXPRESSED OR IMPLIED WARRANTIES, INCLUDING, BUT NOT LIMITED TO, THE IMPLIED WARRANTIES OF MERCHANTABILITY AND FITNESS FOR A PARTICULAR PURPOSE ARE DISCLAIMED. IN NO EVENT SHALL THE PHP DEVELOPMENT TEAM OR ITS CONTRIBUTORS BE LIABLE FOR ANY DIRECT, INDIRECT, INCIDENTAL, SPECIAL, EXEMPLARY, OR CONSEQUENTIAL DAMAGES (INCLUDING, BUT NOT LIMITED TO, PROCUREMENT OF SUBSTITUTE GOODS OR SERVICES; LOSS OF USE, DATA, OR PROFITS; OR BUSINESS INTERRUPTION) HOWEVER CAUSED AND

ON ANY THEORY OF LIABILITY, WHETHER IN CONTRACT, STRICT LIABILITY, OR TORT (INCLUDING NEGLIGENCE OR OTHERWISE) ARISING IN ANY WAY OUT OF THE USE OF THIS SOFTWARE, EVEN IF ADVISED OF THE POSSIBILITY OF SUCH DAMAGE.

This software consists of voluntary contributions made by many individuals on behalf of the PHP Group.

The PHP Group can be contacted via Email at group@php.net. For more information on the PHP Group and the PHP project, please see {http://www.php.net}.

PHP includes the Zend Engine, freely available at {http://www.zend.com}.

LICENSE ISSUES

=====

The OpenSSL toolkit stays under a dual license, i.e. both the conditions of the OpenSSL License and the original SSLeay license apply to the toolkit. See below for the actual license texts. Actually both licenses are BSD-style Open Source licenses. In case of any license issues related to OpenSSL please contact openssl-core@openssl.org.

OpenSSL License

Copyright (c) 1998-2008 The OpenSSL Project. All rights reserved.

Redistribution and use in source and binary forms, with or without modification, are permitted provided that the following conditions are met:

1. Redistributions of source code must retain the above copyright notice, this list of conditions and the following disclaimer.
2. Redistributions in binary form must reproduce the above copyright notice, this list of conditions and the following disclaimer in the documentation and/or other materials provided with the distribution.
3. All advertising materials mentioning features or use of this software must display the following acknowledgment:

"This product includes software developed by the OpenSSL Project for use in the OpenSSL Toolkit. (http://www.openssl.org/)"
4. The names "OpenSSL Toolkit" and "OpenSSL Project" must not be used to endorse or promote products derived from this software without prior written permission. For written permission, please contact openssl-core@openssl.org.
5. Products derived from this software may not be called "OpenSSL" nor may "OpenSSL" appear in their names without prior written permission of the OpenSSL Project.
6. Redistributions of any form whatsoever must retain the following acknowledgment:

"This product includes software developed by the OpenSSL Project for use in the OpenSSL Toolkit (http://www.openssl.org/)"

THIS SOFTWARE IS PROVIDED BY THE OpenSSL PROJECT "AS IS" AND ANY EXPRESSED OR IMPLIED WARRANTIES, INCLUDING, BUT NOT LIMITED TO, THE IMPLIED WARRANTIES OF MERCHANTABILITY AND FITNESS FOR A PARTICULAR PURPOSE ARE DISCLAIMED. IN NO EVENT SHALL THE OpenSSL PROJECT OR ITS CONTRIBUTORS BE LIABLE FOR ANY DIRECT, INDIRECT, INCIDENTAL, SPECIAL, EXEMPLARY, OR CONSEQUENTIAL DAMAGES (INCLUDING, BUT NOT LIMITED TO, PROCUREMENT OF SUBSTITUTE GOODS OR SERVICES; LOSS OF USE, DATA, OR PROFITS; OR BUSINESS INTERRUPTION) HOWEVER CAUSED AND ON ANY THEORY OF LIABILITY, WHETHER IN CONTRACT, STRICT LIABILITY, OR TORT (INCLUDING NEGLIGENCE OR OTHERWISE) ARISING IN ANY WAY OUT OF THE USE OF THIS SOFTWARE, EVEN IF ADVISED OF THE POSSIBILITY OF SUCH DAMAGE.

=====

This product includes cryptographic software written by Eric Young (eay@cryptsoft.com). This product includes software written by Tim Hudson (tjh@cryptsoft.com).

PCRE 5 LICENCE

PCRE is a library of functions to support regular expressions whose syntax and semantics are as close as possible to those of the Perl 5 language.

Release 5 of PCRE is distributed under the terms of the "BSD" licence, as specified below. The documentation for PCRE, supplied in the "doc" directory, is distributed under the same terms as the software itself.

ISC License

Copyright (c) 2004-2013 by Internet Systems Consortium, Inc. ("ISC")

Copyright (c) 1995-2003 by Internet Software Consortium

Permission to use, copy, modify, and distribute this software for any purpose with or without fee is hereby granted, provided that the above copyright notice and this permission notice appear in all copies.

THE SOFTWARE IS PROVIDED "AS IS" AND ISC DISCLAIMS ALL WARRANTIES WITH REGARD TO THIS SOFTWARE INCLUDING ALL IMPLIED WARRANTIES OF MERCHANTABILITY AND FITNESS. IN NO EVENT SHALL ISC BE LIABLE FOR ANY SPECIAL, DIRECT, INDIRECT, OR CONSEQUENTIAL DAMAGES OR ANY DAMAGES WHATSOEVER RESULTING FROM LOSS OF USE, DATA OR PROFITS, WHETHER IN AN ACTION OF CONTRACT, NEGLIGENCE OR OTHER TORTIOUS ACTION, ARISING OUT OF OR IN CONNECTION WITH THE USE OR PERFORMANCE OF THIS SOFTWARE.

Internet Systems Consortium, Inc.

950 Charter Street

Redwood City, CA 94063

<info@isc.org>

https://www.isc.org/

Brian Gladman Alternate License

Copyright (c) 2003, 2010 Brian Gladman, Worcester, UK. All rights reserved.

LICENSE TERMS

The free distribution and use of this software in both source and binary form is allowed (with or without changes) provided that:

- distributions of this source code include the above copyright notice, this list of conditions and the following disclaimer;
- distributions in binary form include the above copyright notice, this list of conditions and the following disclaimer in the documentation and/or other associated materials;
- the copyright holder's name is not used to endorse products built using this software without specific written permission.

ALTERNATIVELY, provided that this notice is retained in full, this product may be distributed under the terms of the GNU General Public License (GPL), in which case the provisions of the GPL apply INSTEAD OF those given above.

DISCLAIMER

This software is provided 'as is' with no explicit or implied warranties in respect of its properties, including, but not limited to, correctness and/or fitness for purpose.

Academic Free License

v. 2.1

This Academic Free License (the "License") applies to any original work of authorship (the "Original Work") whose owner (the "Licensor") has placed the following notice immediately following the copyright notice for the Original Work:

Licensed under the Academic Free License version 2.1

(1) Grant of Copyright License. Licensor hereby grants You a world-wide, royalty-free, non-exclusive, perpetual, sublicenseable license to do the following:

- to reproduce the Original Work in copies;
- to prepare derivative works ("Derivative Works") based upon the Original Work;
- to distribute copies of the Original Work and Derivative Works to the public;
- to perform the Original Work publicly; and
- to display the Original Work publicly.

(2) Grant of Patent License. Licensor hereby grants You a world-wide, royalty-free, non-exclusive, perpetual, sublicenseable license, under patent claims owned or controlled by the Licensor that are embodied in the Original Work as furnished by the Licensor, to make, use, sell and offer for sale the Original Work and Derivative Works.

(3) Grant of Source Code License. The term "Source Code" means the preferred form of the Original Work for making modifications to it and all available documentation describing how to modify the Original Work. Licensor hereby agrees to provide a machine-readable copy of the Source Code of the Original Work along with each copy of the Original Work that Licensor distributes. Licensor reserves the right to satisfy this obligation by placing a machine-readable copy of the Source Code in an information repository reasonably calculated to permit inexpensive and convenient access by You for as long as Licensor continues to distribute the Original Work, and by publishing the address of that information repository in a notice immediately following the copyright notice that applies to the Original Work.

(4) Exclusions From License Grant. Neither the names of Licensor, nor the names of any contributors to the Original Work, nor any of their trademarks or service marks, may be used to endorse or promote products derived from this Original Work without express prior written permission of the Licensor. Nothing in this License shall be deemed to grant any rights to trademarks, copyrights, patents, trade secrets or any other intellectual property of Licensor except as expressly stated herein. No patent license is granted to make, use, sell or offer to sell embodiments of any patent claims other than the licensed claims defined in Section 2. No right is granted to the trademarks of Licensor even if such marks are included in the Original Work. Nothing in this License shall be interpreted to prohibit Licensor from licensing under different terms from this License any Original Work that Licensor otherwise would have a right to license.

(5) This section intentionally omitted.

(6) Attribution Rights. You must retain, in the Source Code of any Derivative Works that You create, all copyright, patent or trademark notices from the Source Code of the Original Work, as well as any notices of licensing and any descriptive text identified therein as an "Attribution Notice." You must cause the Source Code for any Derivative Works that You create to carry a prominent Attribution Notice reasonably calculated to inform recipients that You have modified the Original Work.

(7) Warranty of Provenance and Disclaimer of Warranty. Licensor warrants that the copyright in and to the Original Work and the patent rights granted herein by Licensor are owned by the Licensor or are sublicensed to You under the terms of this License with the permission of the contributor(s) of those copyrights and patent rights. Except as expressly stated in the immediately preceding sentence, the Original Work is provided under this License on an "AS IS" BASIS and WITHOUT WARRANTY, either express or implied, including, without limitation, the warranties of NON-INFRINGEMENT, MERCHANTABILITY or FITNESS FOR A PARTICULAR PURPOSE. THE ENTIRE RISK AS TO THE QUALITY OF THE ORIGINAL WORK IS WITH YOU. This DISCLAIMER OF WARRANTY constitutes an essential part of this License. No license to Original Work is granted hereunder except under this disclaimer.

(8) Limitation of Liability. Under no circumstances and under no legal theory, whether in tort (including negligence), contract, or otherwise, shall the Licensor be liable to any person for any direct, indirect, special, incidental, or consequential damages of any character arising as a result of this License or the use of the Original Work including, without limitation, damages for loss of goodwill, work stoppage, computer failure or malfunction, or any and all other commercial damages or losses. This limitation of liability shall not apply to liability for death or personal injury resulting from Licensor's negligence to the extent applicable law prohibits such limitation. Some jurisdictions do not allow the exclusion or limitation of incidental or consequential damages, so this exclusion and limitation may not apply to You.

(9) Acceptance and Termination. If You distribute copies of the Original Work or a Derivative Work, You must make a reasonable effort under the circumstances to obtain the express assent of recipients to the terms of this License. Nothing else but this License (or another written agreement between Licensor and You) grants You permission to create Derivative Works based upon the Original Work or to exercise any of the rights granted in Section 1 herein, and any attempt to do so except under the terms of this License (or another written agreement between Licensor and You) is expressly prohibited by U.S. copyright law, the equivalent laws of other countries, and by international treaty. Therefore, by exercising any of the rights granted to You in Section 1 herein, You indicate Your acceptance of this License and all of its terms and conditions.

(10) Termination for Patent Action. This License shall terminate automatically and You may no longer exercise any of the rights granted to You by this License as of the date You commence an action, including a cross-claim or counterclaim, against Licensor or any licensee alleging that the Original Work infringes a patent. This termination provision shall not apply for an action alleging patent infringement by combinations of the Original Work with other software or hardware.

(11) Jurisdiction, Venue and Governing Law. Any action or suit relating to this License may be brought only in the courts of a jurisdiction wherein the Licensor resides or in which Licensor conducts its primary business, and under the laws of that jurisdiction excluding its conflict-of-law provisions. The application of the United Nations Convention on Contracts for the International Sale of Goods is expressly excluded. Any use of the Original Work outside the scope of this License or after its termination shall be subject to the requirements and penalties of the U.S. Copyright Act, 17 U.S.C. § 101 et seq., the equivalent laws of other countries, and international treaty. This section shall survive the termination of this License.

(12) Attorneys Fees. In any action to enforce the terms of this License or seeking damages relating thereto, the prevailing party shall be entitled to recover its costs and expenses, including, without limitation, reasonable attorneys' fees and costs incurred in connection with such action, including any appeal of such action. This section shall survive the termination of this License.

(13) Miscellaneous. This License represents the complete agreement concerning the subject matter hereof. If any provision of this License is held to be unenforceable, such provision shall be reformed only to the extent necessary to make it enforceable.

(14) Definition of "You" in This License. "You" throughout this License, whether in upper or lower case, means an individual or a legal entity exercising rights under, and complying with all of the terms of, this License. For legal entities, "You" includes any entity that controls, is controlled by, or is under common control with you. For purposes of this definition, "control" means (i) the power, direct or indirect, to cause the direction or management of such entity, whether by contract or otherwise, or (ii) ownership of fifty percent (50%) or more of the outstanding shares, or (iii) beneficial ownership of such entity.

(15) Right to Use. You may use the Original Work in all ways not otherwise restricted or conditioned by this License or by law, and Licensor promises not to interfere with or be responsible for such uses by You.

The Artistic License

Preamble

The intent of this document is to state the conditions under which a Package may be copied, such that the Copyright Holder maintains some semblance of artistic control over the development of the package, while giving the users of the package the right to use and distribute the Package in a more-or-less customary fashion, plus the right to make reasonable modifications.

Definitions:

- "Package" refers to the collection of files distributed by the Copyright Holder, and derivatives of that collection of files created through textual modification.
- "Standard Version" refers to such a Package if it has not been modified, or has been modified in accordance with the wishes of the Copyright Holder.
- "Copyright Holder" is whoever is named in the copyright or copyrights for the package.
- "You" is you, if you're thinking about copying or distributing this Package.
- "Reasonable copying fee" is whatever you can justify on the basis of media cost, duplication charges, time of people involved, and so on. (You will not be required to justify it to the Copyright Holder, but only to the computing community at large as a market that must bear the fee.)
- "Freely Available" means that no fee is charged for the item itself, though there may be fees involved in handling the item. It also means that recipients of the item may redistribute it under the same conditions they received it.

1. You may make and give away verbatim copies of the source form of the Standard Version of this Package without restriction, provided that you duplicate all of the original copyright notices and associated disclaimers.

2. You may apply bug fixes, portability fixes and other modifications derived from the Public Domain or from the Copyright Holder. A Package modified in such a way shall still be considered the Standard Version.

3. You may otherwise modify your copy of this Package in any way, provided that you insert a prominent notice in each changed file stating how and when you changed that file, and provided that you do at least ONE of the following:

a) place your modifications in the Public Domain or otherwise make them Freely Available, such as by posting said modifications to Usenet or an equivalent medium, or placing the modifications on a major archive site such as ftp.uu.net, or by allowing the Copyright Holder to include your modifications in the Standard Version of the Package.

b) use the modified Package only within your corporation or organization.

c) rename any non-standard executables so the names do not conflict with standard executables, which must also be provided, and provide a separate manual page for each non-standard executable that clearly documents how it differs from the Standard Version.

d) make other distribution arrangements with the Copyright Holder.

4. You may distribute the programs of this Package in object code or executable form, provided that you do at least ONE of the following:

a) distribute a Standard Version of the executables and library files, together with instructions (in the manual page or equivalent) on where to get the Standard Version.

b) accompany the distribution with the machine-readable source of the Package with your modifications.

c) accompany any non-standard executables with their corresponding Standard Version executables, giving the non-standard executables non-standard names, and clearly documenting the differences in manual pages (or equivalent), together with instructions on where to get the Standard Version.

d) make other distribution arrangements with the Copyright Holder.

5. You may charge a reasonable copying fee for any distribution of this Package. You may charge any fee you choose for support of this Package. You may not charge a fee for this Package itself. However, you may distribute this Package in aggregate with other (possibly commercial) programs as part of a larger (possibly commercial) software distribution provided that you do not advertise this Package as a product of your own.

6. The scripts and library files supplied as input to or produced as output from the programs of this Package do not automatically fall under the copyright of this Package, but belong to whomever generated them, and may be sold commercially, and may be aggregated with this Package.

7. C or perl subroutines supplied by you and linked into this Package shall not be considered part of this Package.

8. The name of the Copyright Holder may not be used to endorse or promote products derived from this software without specific prior written permission.

9. THIS PACKAGE IS PROVIDED "AS IS" AND WITHOUT ANY EXPRESS OR IMPLIED WARRANTIES, INCLUDING, WITHOUT LIMITATION, THE IMPLIED WARRANTIES OF MERCHANTABILITY AND FITNESS FOR A PARTICULAR PURPOSE.

The End

Expat License

Copyright (c) 1998, 1999, 2000 Thai Open Source Software Center Ltd and Clark Cooper

Copyright (c) 2001, 2002, 2003, 2004, 2005, 2006 Expat maintainers. Permission is hereby granted, free of charge, to any person obtaining a copy of this software and associated documentation files (the "Software"), to deal in the Software without restriction, including without limitation the rights to use, copy, modify, merge, publish, distribute, sublicense, and/or sell copies of the Software, and to permit persons to whom the Software is furnished to do so, subject to the following conditions:

The above copyright notice and this permission notice shall be included in all copies or substantial portions of the Software.

THE SOFTWARE IS PROVIDED "AS IS", WITHOUT WARRANTY OF ANY KIND, EXPRESS OR IMPLIED, INCLUDING BUT NOT LIMITED TO THE WARRANTIES OF MERCHANTABILITY, FITNESS FOR A PARTICULAR PURPOSE AND NONINFRINGEMENT. IN NO EVENT SHALL THE AUTHORS OR COPYRIGHT HOLDERS BE LIABLE FOR ANY CLAIM, DAMAGES OR OTHER LIABILITY, WHETHER IN AN ACTION OF CONTRACT, TORT OR OTHERWISE, ARISING FROM, OUT OF OR IN CONNECTION WITH THE SOFTWARE OR THE USE OR OTHER DEALINGS IN THE SOFTWARE.

Fine Free File Command License

Copyright (c) Ian F. Darwin 1986, 1987, 1989, 1990, 1991, 1992, 1994, 1995.

Software written by Ian F. Darwin and others;

maintained 1994- Christos Zoulas.

This software is not subject to any export provision of the United States Department of Commerce, and may be exported to any country or planet.

Redistribution and use in source and binary forms, with or without modification, are permitted provided that the following conditions are met:

1. Redistributions of source code must retain the above copyright notice immediately at the beginning of the file, without modification, this list of conditions, and the following disclaimer.

2. Redistributions in binary form must reproduce the above copyright notice, this list of conditions and the following disclaimer in the documentation and/or other materials provided with the distribution.

THIS SOFTWARE IS PROVIDED BY THE AUTHOR AND CONTRIBUTORS "AS IS" AND ANY EXPRESS OR IMPLIED WARRANTIES, INCLUDING, BUT NOT LIMITED TO, THE IMPLIED WARRANTIES OF MERCHANTABILITY AND FITNESS FOR A PARTICULAR PURPOSE ARE DISCLAIMED. IN NO EVENT SHALL THE AUTHOR OR CONTRIBUTORS BE LIABLE FOR ANY DIRECT, INDIRECT, INCIDENTAL, SPECIAL, EXEMPLARY, OR CONSEQUENTIAL DAMAGES (INCLUDING, BUT NOT LIMITED TO, PROCUREMENT OF SUBSTITUTE GOODS OR SERVICES; LOSS OF USE, DATA, OR PROFITS; OR BUSINESS INTERRUPTION) HOWEVER CAUSED AND ON ANY THEORY OF LIABILITY, WHETHER IN CONTRACT, STRICT LIABILITY, OR TORT (INCLUDING NEGLIGENCE OR OTHERWISE) ARISING IN ANY WAY OUT OF THE USE OF THIS SOFTWARE, EVEN IF ADVISED OF THE POSSIBILITY OF SUCH DAMAGE.

libxml2 License

Except where otherwise noted in the source code (e.g. the files hash.c, list.c and the trio files, which are covered by a similar licence but with different Copyright notices) all the files are:

Copyright (C) 1998-2003 Daniel Veillard. All Rights Reserved.

Permission is hereby granted, free of charge, to any person obtaining a copy of this software and associated documentation files (the "Software"), to deal in the Software without restriction, including without limitation the rights to use, copy, modify, merge, publish, distribute, sublicense, and/or sell copies of the Software, and to permit persons to whom the Software is furnished to do so, subject to the following conditions:

The above copyright notice and this permission notice shall be included in all copies or substantial portions of the Software.

THE SOFTWARE IS PROVIDED "AS IS", WITHOUT WARRANTY OF ANY KIND, EXPRESS OR IMPLIED, INCLUDING BUT NOT LIMITED TO THE WARRANTIES OF MERCHANTABILITY, FITNESS FOR A PARTICULAR PURPOSE AND NONINFRINGEMENT. IN NO EVENT SHALL THE DANIEL VEILLARD BE LIABLE FOR ANY CLAIM, DAMAGES OR OTHER LIABILITY, WHETHER IN AN ACTION OF CONTRACT, TORT OR OTHERWISE, ARISING FROM, OUT OF OR IN CONNECTION WITH THE SOFTWARE OR THE USE OR OTHER DEALINGS IN THE SOFTWARE.

Except as contained in this notice, the name of Daniel Veillard shall not be used in advertising or otherwise to promote the sale, use or other dealings in this Software without prior written authorization from him.

Open Market License

This FastCGI application library source and object code (the "Software") and its documentation (the "Documentation") are copyrighted by Open Market, Inc ("Open Market"). The following terms apply to all files associated with the Software and Documentation unless explicitly disclaimed in individual files.

Open Market permits you to use, copy, modify, distribute, and license this Software and the Documentation solely for the purpose of implementing the FastCGI specification defined by Open Market or derivative specifications publicly endorsed by Open Market and promulgated by an open standards organization and for no other purpose, provided that existing copyright notices are retained in all copies and that this notice is included verbatim in any distributions.

No written agreement, license, or royalty fee is required for any of the authorized uses. Modifications to this Software and Documentation may be copyrighted by their authors and need not follow the licensing terms described here, but the modified Software and Documentation must be used for the sole purpose of implementing the FastCGI specification defined by Open Market or derivative specifications publicly endorsed by Open Market and promulgated by an open standards organization and for no other purpose. If modifications to this Software and Documentation have new licensing terms, the new terms must protect Open Market's proprietary rights in the Software and Documentation to the same extent as these licensing terms and must be clearly indicated on the first page of each file where they apply.

Open Market shall retain all right, title and interest in and to the Software and Documentation, including without limitation all patent, copyright, trade secret and other proprietary rights.

OPEN MARKET MAKES NO EXPRESS OR IMPLIED WARRANTY WITH RESPECT TO THE SOFTWARE OR THE DOCUMENTATION, INCLUDING WITHOUT LIMITATION ANY WARRANTY OF MERCHANTABILITY OR FITNESS FOR A PARTICULAR PURPOSE. IN NO EVENT SHALL OPEN MARKET BE LIABLE TO YOU OR ANY THIRD PARTY FOR ANY DAMAGES ARISING FROM OR RELATING TO THIS SOFTWARE OR THE DOCUMENTATION, INCLUDING, WITHOUT LIMITATION, ANY INDIRECT, SPECIAL OR CONSEQUENTIAL DAMAGES OR SIMILAR DAMAGES, INCLUDING LOST PROFITS OR LOST DATA, EVEN IF OPEN MARKET HAS BEEN ADVISED OF THE POSSIBILITY OF SUCH DAMAGES. THE SOFTWARE AND DOCUMENTATION ARE PROVIDED "AS IS". OPEN MARKET HAS NO LIABILITY IN CONTRACT, TORT, NEGLIGENCE OR OTHERWISE ARISING OUT OF THIS SOFTWARE OR THE DOCUMENTATION.

Purdue License

Copyright 1996 Purdue Research Foundation, West Lafayette, Indiana 47907. All rights reserved.

Written by Victor A. Abell.

This software is not subject to any license of the American Telephone and Telegraph Company or the Regents of the University of California.

Permission is granted to anyone to use this software for any purpose on any computer system, and to alter it and redistribute it freely, subject to the following restrictions:

1. Neither the authors nor Purdue University are responsible for any consequences of the use of this software.
2. The origin of this software must not be misrepresented, either by explicit claim or by omission. Credit to the authors and Purdue University must appear in documentation and sources.
3. Altered versions must be plainly marked as such, and must not be misrepresented as being the original software.
4. This notice may not be removed or altered.

vsftpd GPL 2.0 with Exception License

vsftpd is licensed under version 2 of the GNU GPL.

As copyright holder, I give permission for vsftpd to be linked to the OpenSSL libraries. This includes permission for vsftpd binaries to be distributed linked against the OpenSSL libraries. All other obligations under the GPL v2 remain intact.

GNU LESSER GENERAL PUBLIC LICENSE

Version 3, 29 June 2007

Copyright (C) 2007 Free Software Foundation, Inc.< http://fsf.org/>

Everyone is permitted to copy and distribute verbatim copies of this license document, but changing it is not allowed.

This version of the GNU Lesser General Public License incorporates the terms and conditions of version 3 of the GNU General Public License, supplemented by the additional permissions listed below.

0. Additional Definitions.

As used herein, "this License" refers to version 3 of the GNU Lesser General Public License, and the "GNU GPL" refers to version 3 of the GNU General Public License.

"The Library" refers to a covered work governed by this License, other than an Application or a Combined Work as defined below.

An "Application" is any work that makes use of an interface provided by the Library, but which is not otherwise based on the Library. Defining a subclass of a class defined by the Library is deemed a mode of using an interface provided by the Library.

A "Combined Work" is a work produced by combining or linking an Application with the Library. The particular version of the Library with which the Combined Work was made is also called the "Linked Version".

The "Minimal Corresponding Source" for a Combined Work means the Corresponding Source for the Combined Work, excluding any source code for portions of the Combined Work that, considered in isolation, are based on the Application, and not on the Linked Version.

The "Corresponding Application Code" for a Combined Work means the object code and/or source code for the Application, including any data and utility programs needed for reproducing the Combined Work from the Application, but excluding the System Libraries of the Combined Work.

1. Exception to Section 3 of the GNU GPL.

You may convey a covered work under sections 3 and 4 of this License without being bound by section 3 of the GNU GPL.

2. Conveying Modified Versions.

If you modify a copy of the Library, and, in your modifications, a facility refers to a function or data to be supplied by an Application that uses the facility (other than as an argument passed when the facility is invoked), then you may convey a copy of the modified version:

- a) under this License, provided that you make a good faith effort to ensure that, in the event an Application does not supply the function or data, the facility still operates, and performs whatever part of its purpose remains meaningful, or
- b) under the GNU GPL, with none of the additional permissions of this License applicable to that copy.

3. Object Code Incorporating Material from Library Header Files.

The object code form of an Application may incorporate material from a header file that is part of the Library. You may convey such object code under terms of your choice, provided that, if the incorporated material is not limited to numerical parameters, data structure layouts and accessors, or small macros, inline functions and templates (ten or fewer lines in length), you do both of the following:

- a) Give prominent notice with each copy of the object code that the Library is used in it and that the Library and its use are covered by this License.
- b) Accompany the object code with a copy of the GNU GPL and this license document.

4. Combined Works.

You may convey a Combined Work under terms of your choice that, taken together, effectively do not restrict modification of the portions of the Library contained in the Combined Work and reverse engineering for debugging such modifications, if you also do each of the following:

- a) Give prominent notice with each copy of the Combined Work that the Library is used in it and that the Library and its use are covered by this License.
- b) Accompany the Combined Work with a copy of the GNU GPL and this license document.

c) For a Combined Work that displays copyright notices during execution, include the copyright notice for the Library among these notices, as well as a reference directing the user to the copies of the GNU GPL and this license document.

d) Do one of the following:

- 0) Convey the Minimal Corresponding Source under the terms of this License, and the Corresponding Application Code in a form suitable for, and under terms that permit, the user to recombine or relink the Application with a modified version of the Linked Version to produce a modified Combined Work, in the manner specified by section 6 of the GNU GPL for conveying Corresponding Source.
- 1) Use a suitable shared library mechanism for linking with the Library. A suitable mechanism is one that (a) uses at run time a copy of the Library already present on the user's computer system, and (b) will operate properly with a modified version of the Library that is interface-compatible with the Linked Version.

e) Provide Installation Information, but only if you would otherwise be required to provide such information under section 6 of the GNU GPL, and only to the extent that such information is necessary to install and execute a modified version of the Combined Work produced by recombining or relinking the Application with a modified version of the Linked Version. (If you use option 4d0, the Installation Information must accompany the Minimal Corresponding Source and Corresponding Application Code. If you use option 4d1, you must provide the Installation Information in the manner specified by section 6 of the GNU GPL for conveying Corresponding Source.)

5. Combined Libraries.

You may place library facilities that are a work based on the Library side by side in a single library together with other library facilities that are not Applications and are not covered by this License, and convey such a combined library under terms of your choice, if you do both of the following:

- a) Accompany the combined library with a copy of the same work based on the Library, uncombined with any other library facilities, conveyed under the terms of this License.
- b) Give prominent notice with the combined library that part of it is a work based on the Library, and explaining where to find the accompanying uncombined form of the same work.

6. Revised Versions of the GNU Lesser General Public License.

The Free Software Foundation may publish revised and/or new versions of the GNU Lesser General Public License from time to time. Such new versions will be similar in spirit to the present version, but may differ in detail to address new problems or concerns.

Each version is given a distinguishing version number. If the Library as you received it specifies that a certain numbered version of the GNU Lesser General Public License "or any later version" applies to it, you have the option of following the terms and conditions either of that published version or of any later version published by the Free Software Foundation. If the Library as you received it does not specify a version number of the GNU Lesser General Public License, you may choose any version of the GNU Lesser General Public License ever published by the Free Software Foundation.

If the Library as you received it specifies that a proxy can decide whether future versions of the GNU Lesser General Public License shall apply, that proxy's public statement of acceptance of any version is permanent authorization for you to choose that version for the Library.



Hanwha Techwin cares for the environment at all product manufacturing stages, and is taking measures to provide customers with more environmentally friendly products.

The Eco mark represents Hanwha Techwin's devotion to creating environmentally friendly products, and indicates that the product satisfies the EU RoHS Directive.



Correct Disposal of This Product (Waste Electrical & Electronic Equipment)

(Applicable in the European Union and other European countries with separate collection systems)

This marking on the product, accessories or literature indicates that the product and its electronic accessories (e.g. charger, headset, USB cable) should not be disposed of with other household waste at the end of their working life. To prevent possible harm to the environment or human health from uncontrolled waste disposal, please separate these items from other types of waste and recycle them responsibly to promote the sustainable reuse of material resources.

Household users should contact either the retailer where they purchased this product, or their local government office, for details of where and how they can take these items for environmentally safe recycling.

Business users should contact their supplier and check the terms and conditions of the purchase contract. This product and its electronic accessories should not be mixed with other commercial wastes for disposal.



Correct disposal of batteries in this product

(Applicable in the European Union and other European countries with separate battery return systems.)

This marking on the battery, manual or packaging indicates that the batteries in this product should not be disposed of with other household waste at the end of their working life. Where marked, the chemical symbols Hg, Cd or Pb indicate that the battery contains mercury, cadmium or lead above the reference levels in EC Directive 2006/66. If batteries are not properly disposed of, these substances can cause harm to human health or the environment.

To protect natural resources and to promote material reuse, please separate batteries from other types of waste and recycle them through your local, free battery return system.

Head Office

6, Pangyo-ro 319 beon-gil, Bundang-gu, Seongnam-si,
Gyeonggi-do, 463-400 Rep. of KOREA

Tel : +82.70.7147.8753 Fax : +82.31.8018.3740

www.hanwha-security.com

Hanwha Techwin America

500 Frank W. Burr Blvd. Suite 43 Teaneck, NJ 07666

Toll Free +1.877.213.1222 Direct +1.201.325.6920

Fax +1.201.373.0124

www.hanwha-security.com

Hanwha Techwin Europe

Heriot House, Heriot Road, Chertsey, Surrey, KT16 9DT, United Kingdom

Tel +44.1932.57.8100 Fax +44.1932.57.8101

www.hanwha-security.eu

FCC Compliance Statement

This device complies with part 15 of the FCC rules. Operation is subject to the following two conditions: (1) This device may not cause harmful interference, and (2) this device must accept any interference received, including interference that may cause undesired operation.

FCC Caution

Any changes or modifications not expressly approved by the party responsible for compliance could void the user's authority to operate this equipment. This transmitter must not be co-located or operating in conjunction with any other antenna or transmitter.

FCC Radiation Exposure Statement

This equipment complies with FCC radiation exposure limits set forth for an uncontrolled environment. This equipment should be installed and operated with minimum distance 20 cm between the radiator and your body. This transmitter must not be co-located or operating in conjunction with any other antenna or transmitter.

IEEE 802.11n operation of this product in the USA is firmware-limited to channels 1 through 11.

If the device is going to be operated in the 5.15 - 5.25 frequency range, then it is restricted to indoor environment only. This device meets all other requirements specified in Part 15E, Section 15.407 of the FCC Rules.