





标签式样

REV. No.

ODM开发Team

BOM MODEL名	SNK-B73041BW/CUS	作成者	peter.kim	基准	本社及式样标准
------------	------------------	-----	-----------	----	---------

1> LABEL RATING打印式样PT03-002464C用量：1EA

<p>NETWORK VIDEO RECORDER MODEL:SNR-73201W DC 12V 2A FCC ID : NLMSNR73201W IC : 21482-SNR73201W HANWHA TECHWIN CO.,LTD. MADE IN CHINA</p>	<p>M/C:SNR-73201W1T/CUS ③  Mar 2017 S/N:ZF0S69OJ300001A ETHERNET ADD.:XX-XX-XX-XX-XX-XX CAN ICES-3(B)/NMB-3(B)</p> <p>     </p> <p>PT03-002464C</p>
---	--

ZF0S

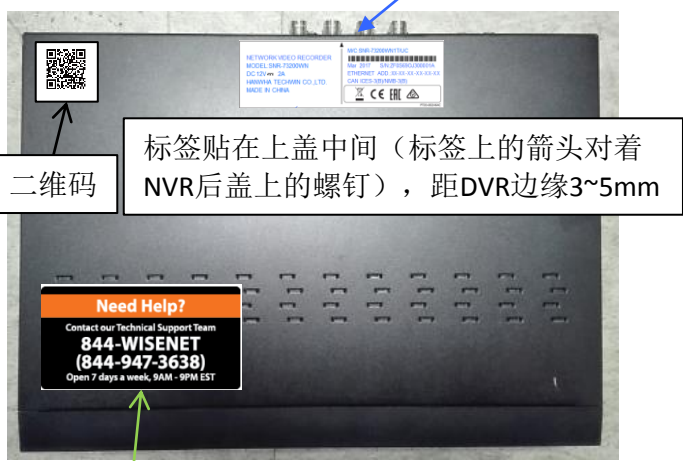

二维码

标签贴在上盖中间（标签上的箭头对着NVR后盖上的螺钉），距DVR边缘3~5mm

Call Center Sticker



②

C1205010001
ZBP267Z800001X
ZBP267Z800002X
ZBP267Z800003X
ZBP267Z800004X





① SERIAL NO.:

ZETD69OH300001A

临时签，扫描完后废弃

按顺序①→②→③→①的顺序扫描上面3种标签上的条形码，得到大箱子上的标签（下图中的标签）。
注意：临时标签扫描完后废弃。

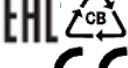
2> LABEL-PACKING 打印式样PT03-000044B用量：1EA

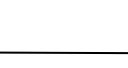
<p>SNK-B73041BW  849688008140 SNK-B73041BW/CUS  S/N:ZETD69OJ300001A</p>	<p>     </p>
FW Ver. XXX	CMS Ver.
MADE IN CHINA	

 8 49688 00814 0
 ZETD

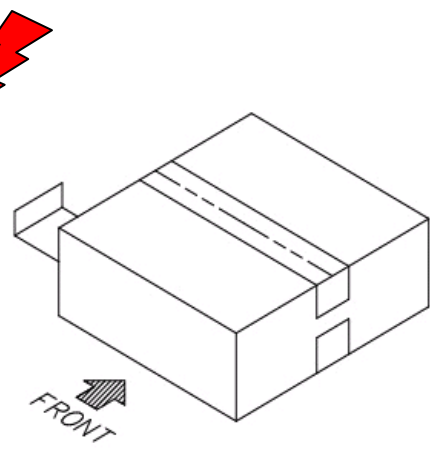

具体版本号需要raysharp通知 HANWHA peter.kim