

EMC TEST REPORT For FCC



Test Report No. : CTK02-F169-1
Date of Issue : April 19, 2004
FCC ID : NLMDIGIMAXV4
Model/Type No. : Digimax V4, Digimax 4500 super, Digimax 4500V and Digimax V4000
Kind of Product : Digital Camera
Applicant : Samsung Techwin Co., Ltd.
Applicant Address : 145-3 Sangdaewon 1-Dong, Jungwon-Gu, Sunghnam-City,
Kyungki-Do, Korea
Manufacturer : 1) Samsung Techwin Co., Ltd.
2) Tianjin Samsung Opto-Electronics Co., Ltd.
Manufacturer Address : 1) 145-3 Sangdaewon 1-Dong, Jungwon-Gu, Sunghnam-City,
Kyungki-Do, Korea
2) 7 Pingchang Road, Nankai Dist., Tianjin, China
Contact Person : Kun-Sop, Kim (Manager)
Telephone : +82-31-740-8253
Received Date : April 2, 2004
Test period : Start: April 2, 2004 End: April 6, 2004
Test Results : **In Compliance** **Not in Compliance**

The test results presented in this report relate only to the object tested.

CERTiTEK Standards Laboratory Co., Ltd. is accredited by Korea Laboratory Accreditation Scheme (KOLAS) which signed the International Laboratory Accreditation Cooperation (ILAC) Mutual Recognition Arrangement (MRA) for the above test item(s) and test method(s).

Tested by



Young-Joon, Park
EMC Test Engineer
Date: April 19, 2004

Reviewed by

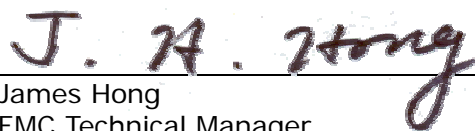

James Hong
EMC Technical Manager
Date: April 19, 2004



REPORT REVISION HISTORY

Date	Revision	Page No
January 6, 2003	Issued (CTK02-F169)	All
April 19, 2004	(CTK02-F169-1) Additional Model of Digimax V4000	All
	Front Cover will be changed into Aluminum Cover from Plastic Cover.	

This report shall not be reproduced except in full, without the written approval of CERTiTEK Standards Laboratory Co., Ltd. This document may be altered or revised by CERTiTEK Standards Laboratory Co., Ltd. Personnel only, and shall be noted in the revision section of the document. Any alteration of this document not carried out by CERTiTEK Standards Laboratory Co., Ltd. will constitute fraud and shall nullify the document.



TABLE OF CONTENTS

1.0 General Product Description	4
1.1 Model Differences	4
1.2 Device Modifications.....	4
1.3 EUT Configuration(s)	5
1.4 Test Software	5
1.5 EUT Operating Mode(s).....	5
1.6 Calibration Details of Equipment Used for Measurement	5
1.7 Test Facility	5
1.8 Measurement Procedure	6
1.9 Laboratory Accreditations and Listings	7
2.0 Emissions Test Regulations.....	8
2.1 Conducted Voltage Emissions	9
2.2 Radiated Electric Field Emissions.....	10
Configurations	11
APPENDIX A - TEST DATA.....	12
Conducted Voltage Emissions (Quasi-Peak reading)	12
Radiated Electric Field Emissions (Quasi-Peak reading).....	14

1.0 General Product Description

1.0.1 Tested Equipment

- Unless otherwise indicated, all tests were conducted on Model Digimax V4.
- Tests performed on Model _____ were considered to be representative of Model(s) _____.

1.0.2 Equipment Size, Mobility and Identification

Dimensions: 105.5(W) by 54.6(H) by 38(D) mm in

Mobility: Hand-Held Table-top Floor-standing

-

Serial No.: Prototype

1.0.3 Electrical Ratings

EUT :

Input : 5.0Vdc

Output : -

Adaptor :

Input : 100-250Vac, 50/60Hz

Output : 5.0Vdc, 2.0A

1.0.4 Test Voltage & Frequency (Using the adaptor)

Unless indicated otherwise on the individual data sheet or test results, the test voltage and frequency was as indicated below.

Voltage: 120Vac

Frequency: 60Hz

1.0.5 Clock & Other Frequencies Utilized

DSP : 13.5MHz

HOST CPU : 5.00MHz

TG&CDS&AGC : 36.00MHz

1.1 Model Differences

Digimax V4, Digimax 4500 super, Digimax 4500V and Digimax V4000 are identical to each other only except for model designation for the marketing purposes.

1.2 Device Modifications

Description of the Changes according to FCC part 2.1043:

Front Cover will be changed into Aluminum Cover from Plastic Cover.

1.3 EUT Configuration(s)

See Appendix A for individual test set-up configuration(s). The following peripheral devices and/or interface cables were connected during the measurement:

Peripheral Devices

Device	Manufacturer	Model No.	Serial No.	FCC ID or DoC
Adaptor	Ault Inc.	PW137	12501032	-
Desk Top PC	Hewlett-Packard Company	PD1059P	-	DoC
LCD Monitor	TPV ELECTRONICS(FUJIAN)CO.,LTD	HSTND-2A01	-	DoC
Keyboard	SAMSUNG	SEM-DT35	3T011297	DoC
Mouse (PS/2 type)	SAMSUNG	OMS3CB	0303009873	DoC
Mouse (USB type)	SAMSUNG	OMS3CB	0303009875	DoC

Cable Description

#	Description	Ferrite Core	Length (m)	Other Details
1	AC power cable, Unshielded	No	1.5	Connect to AC power
2	AC power cable, Unshielded	No	1.8	Connect to AC power
3	AC power cable, Unshielded	No	1.8	Connect to AC power
4	DC output cable, Unshielded	Yes	1.5	Between the EUT and Adaptor
5	USB cable, Shielded	Yes	1.2	Between the EUT and PC
6	LCD Monitor cable, Shielded	Yes	1.8	Between the PC and LCD Monitor
7	Mouse cable, Shielded	No	1.5	PS/2 type
8	Mouse cable, Shielded	No	1.5	USB type
9	Keyboard cable, Shielded	No	1.5	PS/2 type

1.4 Test Software

- Pinging
 Not applicable

1.5 EUT Operating Mode(s)

Equipment under test was operated during the measurement under the following conditions:

- Test program (H-Pattern) Test program (color bar)
 Standby Test program (customer specific)
 Practice operation : PC mode (Downloading stored images)

1.6 Calibration Details of Equipment Used for Measurement

Test equipment and test accessories are calibrated on regular basis. The maximum time between calibrations is one year or what is recommended by the manufacturer, whichever is less. All test equipment calibrations are traceable to the Korea Research Institute of Standards and Science (KRISS), therefore, all test data recorded in this report is traceable to KRISS.

1.7 Test Facility

The measurement facility is located at 386-1, Ho-Dong, Yongin-City, Kyungki-Do, Korea 449-100. The sites are constructed in conformance with the requirements of ANSI C63.7, ANSI C63.4 and CISPR Publication 22.



1.8 Measurement Procedure





Preliminary AC power line conducted emissions tests were performed shielded room. To find worst mode, several typical mode and typical cable position were tested. Final AC power line conducted emissions test was performed shielded room. (location is same as Preliminary test)
Based on the preliminary tests of the EUT, final test was proceeded worst case test mode and cable configuration.

Preliminary radiated emissions test were performed anechoic chamber (Distance of antenna and EUT was 3 m). To find worst mode, several typical mode and typical cable position were tested and peak level and frequency were recorded.

Final radiated emissions test was performed Open Area Test Site. Based on the preliminary tests of the EUT, final test was proceeded worst case test mode and cable configuration.

* Measurement procedures was In accordance with ANSI C63.4-2001 7.2.3, 7.2.4, 8.3.1.1, 8.3.1.2

1.9 Laboratory Accreditations and Listings

Country	Agency	Scope of Accreditation	Logo
USA	FCC	3 and 10 meter Open Area Test Sites to perform FCC Part 15/18 measurements.	 93250
JAPAN	VCCI	10 meter Open Area Test Site and one conducted site.	 R-948, C-986
KOREA	MIC	EMI (CE, RE) EMS (ESD, Burst, RS, Surge, CS, Power-Frequency Susceptibility, Voltage Dips and Short Interruptions)	 No. 51, KR0025
International	KOLAS	EMC	 NO. 119
Europe	GLAS	EMC EN 55011, EN 55022, EN 55024, EN 61326, EN 50130-4, EN 50081-1, EN 50081-2, EN 50082-1, EN 50082-2, EN 61000-6-2, EN 61000-4-2, EN 61000-4-3, EN 61000-4-4, EN 61000-4-5, EN 61000-4-6, EN 61000-4-8, EN 61000-4-11, EN 61000-3-2, EN 61000-3-3	 No.13000796-02

2.0 Emissions Test Regulations

The emissions tests were performed according to following regulations:

- | | | |
|--|----------------------------------|---|
| <input type="checkbox"/> EN 50081-1:1992 | <input type="checkbox"/> Class A | <input type="checkbox"/> Class B |
| <input type="checkbox"/> EN 61000-6-3:2001 | <input type="checkbox"/> Class A | <input type="checkbox"/> Class B |
| <input type="checkbox"/> EN 50081-2:1993 | <input type="checkbox"/> Class A | <input type="checkbox"/> Class B |
| <input type="checkbox"/> EN 61000-6-4:2001 | <input type="checkbox"/> Class A | <input type="checkbox"/> Class B |
| <input type="checkbox"/> EN 50083-2:2001 | | |
| <input type="checkbox"/> EN 55011:1998 +A1:1999 | <input type="checkbox"/> Group 1 | <input type="checkbox"/> Group 2 |
| | <input type="checkbox"/> Class A | <input type="checkbox"/> Class B |
| <input type="checkbox"/> EN 55013:1990 +A12:1994 +A13:1996 +A14:1999 | | |
| <input type="checkbox"/> EN 55013:2001 | | |
| <input type="checkbox"/> EN 55014-1:2000 | | |
| <input type="checkbox"/> EN 55014-1:2000 +A1:2001 | | |
| <input type="checkbox"/> EN 55015:2000 | | |
| <input type="checkbox"/> EN 55015:2000 +A1:2001 | | |
| <input type="checkbox"/> EN 55022:1994 +A1:1995 +A2:1997 | <input type="checkbox"/> Class A | <input type="checkbox"/> Class B |
| <input type="checkbox"/> EN 55022:1998 | <input type="checkbox"/> Class A | <input type="checkbox"/> Class B |
| <input type="checkbox"/> EN 55022:1998 +A1:2000 | <input type="checkbox"/> Class A | <input type="checkbox"/> Class B |
| <input type="checkbox"/> EN 61000-3-2:1995 +A1:1998 +A2:1998 +A14:2000 | | |
| <input type="checkbox"/> EN 61000-3-2:2000 | | |
| <input type="checkbox"/> EN 61000-3-3:1995 | | |
| <input type="checkbox"/> EN 61000-3-3:1995 +A1:2001 | | |
| <input type="checkbox"/> VCCI V-3/2003.04 | <input type="checkbox"/> Class A | <input type="checkbox"/> Class B |
| <input type="checkbox"/> AS/NZS 3548:1995 +A1:1997 +A2:1997 | <input type="checkbox"/> Class A | <input type="checkbox"/> Class B |
| <input checked="" type="checkbox"/> FCC Part 15 Subpart B | <input type="checkbox"/> Class A | <input checked="" type="checkbox"/> Class B |
| <input checked="" type="checkbox"/> CISPR 22:1997 | <input type="checkbox"/> Class A | <input checked="" type="checkbox"/> Class B |
- The unit was tested to CISPR 22 and complied with the alternate methods allowed by FCC under paragraphs 15.107 and 15.109.
- | | | |
|---|----------------------------------|----------------------------------|
| <input type="checkbox"/> CISPR 22:1997 +A1:2000 | <input type="checkbox"/> Class A | <input type="checkbox"/> Class B |
|---|----------------------------------|----------------------------------|

2.1 Conducted Voltage Emissions

Test Date

April 6, 2004

Test Location

EMI-CE: Shielded Room

Test Instruments

<input checked="" type="checkbox"/> Field Strength Meter	Rohde & Schwarz	ESHS30	828144/002
--	-----------------	--------	------------

Test Accessories

<input checked="" type="checkbox"/> LISN	EMCO	3825/2	9409-2246
<input checked="" type="checkbox"/> LISN	EMCO	3825/2	9607-2574
<input checked="" type="checkbox"/> Control PC	HP	Vectra 500	SG72000192

Frequency Range of Measurement

- 150 kHz to 30 MHz
 450 kHz to 30 MHz

Instrument Settings

IF Band Width: 9 kHz

Test Results

The requirements are:

- | | |
|---|--|
| <input checked="" type="checkbox"/> MET | minimum margin is 6.0 dBuV (average) at 0.49 MHz |
| <input type="checkbox"/> NOT MET | limit exceeded by maximum of ____ dBuV at ____ MHz |
| <input type="checkbox"/> NOT APPLICABLE | |

Remarks

See Appendix A for test data.

2.2 Radiated Electric Field Emissions

Test Date

April 2, 2004

Test Location

- EMI-OATS: Testing was performed at a test distance of 10 m
 EMI-OATS: Testing was performed at a test distance of 3 m

Test Instruments

Field Strength Meter Rohde & Schwarz ESVS30 826638/008

Test Accessories

ULTRA Broadband Antenna Rohde & Schwarz HL562 361324/014
 Bi-conical Antenna Schwarzbeck BBA9106 41-00201
 Bi-conical Antenna EMCO 3110B 9607-2564
 Log-periodic Antenna EMCO 3146 9607-4567

Frequency Range of Measurement

30 MHz to 1 GHz

Instrument Settings

IF Band Width: 120 kHz

Test Results

The requirements are:

- MET minimum margin is 3.8 dBuV/m at 33.40 MHz
 NOT MET limit exceeded by maximum of ____ dBuV/m at ____ MHz
 NOT APPLICABLE

Remarks

See Appendix A for test data

Configuration

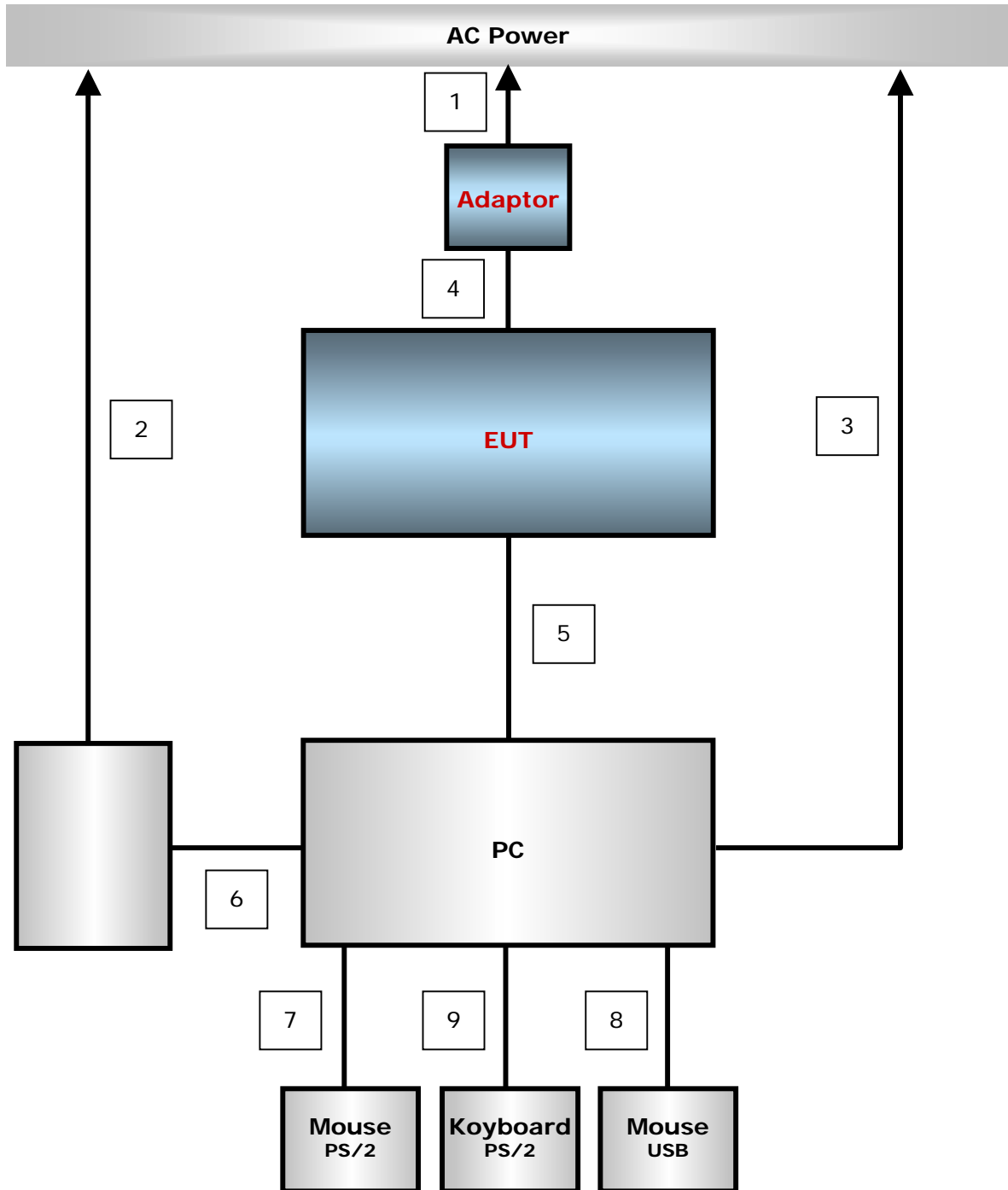

APPENDIX A – TEST DATA

Conducted Voltage Emissions (Quasi-Peak reading)

Frequency [MHz]	Correction Factor		Line	Quasi-peak				Average			
	LISN	Cable		Limit	Reading	Result	Margin	Limit	Reading	Result	Margin
				[dBuV]	[dBuV]	[dBuV]	[dB]	[dBuV]	[dBuV]	[dBuV]	[dB]
0.49	0.1	0.1	N	56.2	42.5	42.7	13.5	46.2	40.0	40.2	6.0
0.68	0.1	0.1	N	56.0	41.9	42.1	13.9	46.0	39.7	39.9	6.1
0.78	0.1	0.1	N	56.0	41.5	41.7	14.3	46.0	39.3	39.5	6.5
5.00	0.2	0.2	N	60.0	41.9	42.3	17.7	50.0	41.0	41.4	8.7
6.08	0.3	0.2	N	60.0	43.1	43.6	16.4	50.0	42.6	43.1	6.9
6.18	0.3	0.2	N	60.0	43.4	43.9	16.1	50.0	42.5	43.0	7.0
6.27	0.3	0.2	N	60.0	43.8	44.3	15.7	50.0	43.2	43.7	6.3
6.37	0.3	0.2	N	60.0	43.4	43.9	16.1	50.0	42.8	43.3	6.7

* If the average limit is met when a quasi-peak detector is used, the EUT shall be deemed to meet both limit and measurement with the average detector is unnecessary.

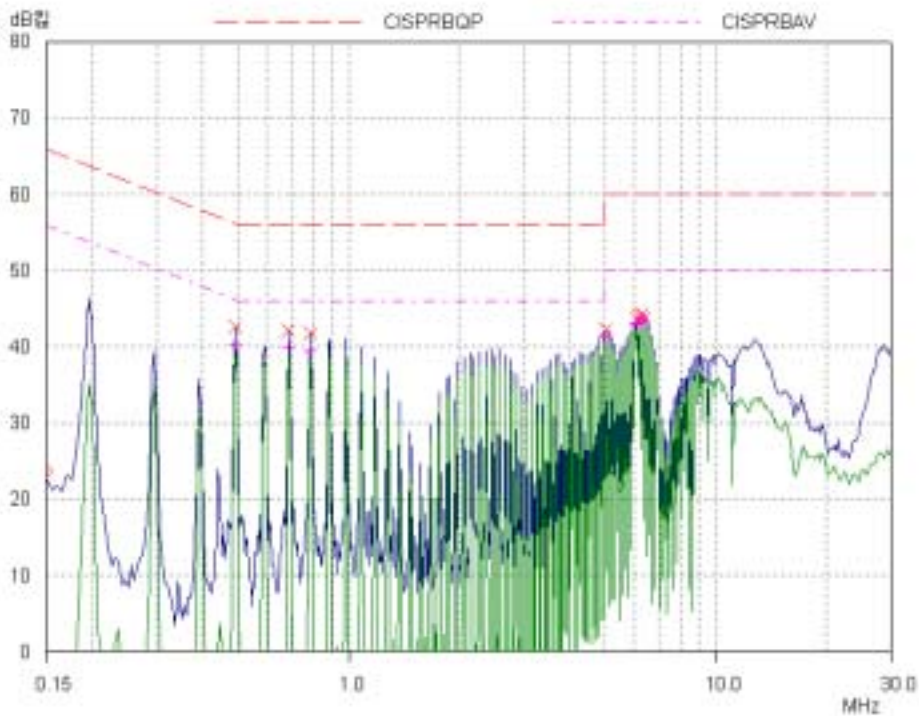
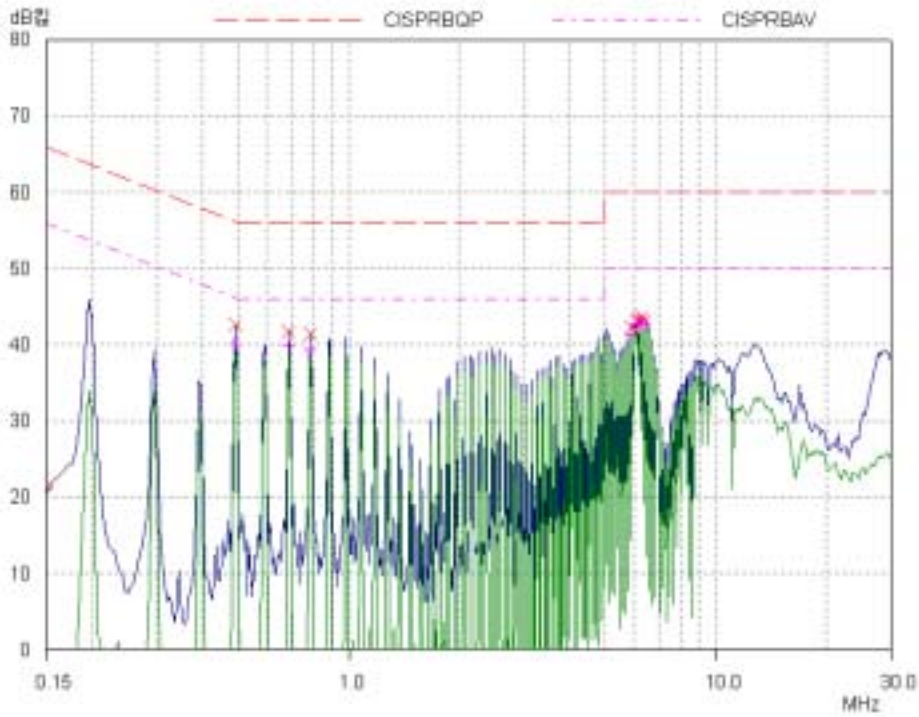

Radiated Electric Field Emissions (Quasi-Peak reading)

Frequency [MHz]	Reading [dBuV/m]	Pol.	Height [m]	Correction Factor		Limits [dBuV/m]	Result [dBuV/m]	Margin [dB]
				Antenna	Cable			
33.40	7.3	V	1.0	17.8	1.1	30.0	26.2	3.8
108.31	10.5	V	4.0	9.5	1.9	30.0	21.9	8.1
468.05	13.8	H	4.0	15.0	4.0	37.0	32.8	4.2
480.06	12.6	H	1.8	15.2	4.3	37.0	32.1	4.9
487.02	13.2	H	2.0	15.3	4.3	37.0	32.8	4.2
493.13	12.7	H	2.0	15.3	4.3	37.0	32.3	4.7
517.01	11.8	H	2.3	16.0	4.3	37.0	32.1	4.9