

Instructions

- Use this camera in the following order

Set up the camera driver

Before connecting the USB cable to the PC and this camera, you have to set up the camera driver. Install the camera driver that is contained in the Application SW CD-ROM. (p.110)

Take a picture

Take a picture (p.26)

Insert the USB cable

Insert the supplied USB cable into the PC USB port and the camera USB connection terminal.(p.99)

Check the camera power

Check the camera power. If the power is turned off, slide the camera switch to power it on.

Check [Removable Disk]

Open Window's EXPLORER and search for [Removable Disk].

Do not insert the cigar jack plug to the DC input connection point as this results in electric shock or severe damage to your camera.

WARNING



Contents

READY

- Getting to know your camera 5
- About the symbols 6
- Caution 6
- Warning 7
- Danger 8
- Special features 9
- This digital camera can be used for 10
- Manufacturer's contents 12
- Identification of features 13
- Front & Top 13
- Back & Bottom 13
- Side 14
- 5-function button 14
- Mode dial 15
- Connecting to Power 17
- Inserting the memory card 20
- Instructions on how to use the
memory card 21
- Selecting the date and time 23
- Language 25

RECORDING

- LCD monitor indicator 27
- Starting recording mode 29
- Using the camera button to adjust the
camera 32
- LCD button 32

- SHUTTER button 32
- WIDE / TELE button 33
- UP/ Voice memo button 35
- MACRO / SUPER MACRO button 36
- FLASH button 37
- SELF-TIMER / REMOTE button 40
- MENU/ OK button 42
- MF button 43
- +/- button 44
- Using the LCD monitor to adjust the
camera 46
- How to use the menu 48
- Size 49
- Quality 50
- A/S/M 51
- Metering 53
- Shooting 54
- White Balance 56
- Effect 57
- Sharpness 58
- My SET mode menu 59
- Mode 59
- Change 60

PLAY

- Starting the play mode 62
- LCD monitor indicator 64
- Information button 65

Contents

● Thumbnail & Wide / Tele & Trimming button	65	● Video	91
● Thumbnail / Enlargement / Trimming button	66	● Connecting to an external monitor	92
● UP / Voice memo button	67	● Quick view	93
● DOWN / LEFT / RIGHT button	68	● MyCAM menu	94
● MENU / OK button	68	● Start up image	94
● DELETE button	69	● Start up sound	95
● PLAY & PAUSE button	70	● Shutter sound	95
● Setting up the play back function using the LCD monitor	71	● List of camera function	96
● Slide show	72	● Starting PC mode	99
● Protect	73	● Important notes	101
● Resize	74	● Warning indicator	102
● Delete all	75	● Before contacting a service center	103
● DPOF : Standard	76	● Specifications	106
● DPOF : Index	77		
● DPOF : Cancel	78		
● Setup menu	79		
● File	80		
● Power off	81		
● Language	82		
● Format	83		
● Date set	85		
● Time set	86		
● Date type	87		
● Imprint	88		
● Sound	89		
● LCD brightness	90		

SOFTWARE

● Software Notes	108
● About the software	108
● Setting up the application software	110
● Removing the USB Driver for Windows 98SE	116
● Removable Disk	118
● Removing the removable disk	119
● Setting up the USB Driver for MAC	121
● Using the USB Driver for MAC	121
● Digimax Viewer	122
● MGI PhotoSuite III SE	123
● FAQ	138

Getting to know your camera

Thank you for buying a Samsung Digital Camera.

- Prior to using this camera, please read the user manual thoroughly.
- Keep the manual in a safe place.

About the symbols

This manual contains instructions on using this camera that will help you to use this camera safely and correctly. This will help prevent danger and injury to others.



DANGER

DANGER

DANGER indicates an imminently hazardous situation which, if not avoided, will result in death or serious injury.



WARNING

WARNING

WARNING indicates a potentially hazardous situation, which, if not avoided, could result in death or serious injury.



CAUTION

CAUTION

CAUTION indicates a potentially hazardous situation, which, if not avoided, may result in a minor or moderate injury.



NOTICE

NOTICE indicates a factor, which, if not avoided, may result in camera malfunction or poor image quality.

















INFORMATION

INFORMATION indicates a factor, which should assist further in the operation of the camera.

About the symbols

The camera mode icons will be marked on the right side of the title bar. The title is available only in the marked camera mode. Refer to below.

Icon	Mode dial	Camera working mode	Icon	Mode dial	Camera working mode
	EASY	Easy mode		PROG	Program mode
		Portrait mode			Night mode
	A/S/M	Aperture priority mode		A/S/M	Shutter priority mode
	A/S/M	Manual mode			Movie clip mode
	MySET	User set mode			Voice recording mode

	Play mode
---	-----------



Caution

- Leaking, overheating, or burst batteries could result in fire or injury.
 - Use batteries with the correct specification for the camera.
 - Do not short circuit, heat or dispose of batteries in fire.
 - Do not use old batteries with new ones, or mix brands of batteries.
 - Ensure the batteries are positioned correctly with regard to polarity (+ / -).
- When the camera is not in use for long periods, always unplug the camera from its power source.
- Do not fire the flash while it is in contact with hands or objects. Do not touch the flash after using it continuously. It may cause burns.
- Do not move the camera while it is switched on, if you are using the AC Power Adapter. After use, always switch off the camera before unplugging the adapter from the AC Power wall socket. Then make sure that any connector cords or cables to other devices are disconnected before moving the camera. Failure to do so may damage the cords or cables and cause a fire or electric shock.

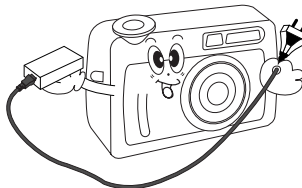



Warning

- Do not use the flash in close proximity to people or animals. Positioning the flash too close to your subject's eyes, may cause eyesight damage.

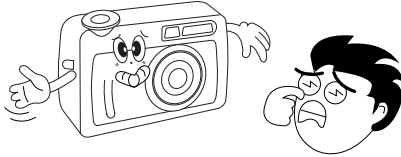

- When taking photographs, never point the lens of the camera directly into very strong light. This may result in permanent damage to the camera or your eyesight.

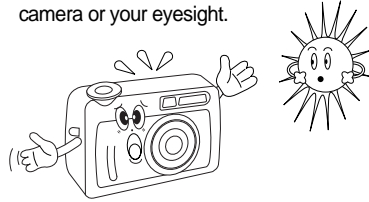

- For safety reasons keep this product and accessories out of reach of children or animals to prevent accidents e.g.:

- Swallowing batteries or small camera accessories. In case of accidents, please consult a doctor immediately.
- There is a risk of permanent eye damage if the flash is operated at a distance of less than one meter from a person's eyes.
- There is a possibility of injury from the camera's moving parts.

- Batteries and camera may become hot during prolonged use and it may result in camera malfunction. Should this be the case, allow the camera to sit idle for a few minutes to allow it time to cool.

- Do not leave this camera in places subject to extremely high temperatures, such as a sealed vehicle, direct sunlight or other places of extreme variances in temperature. Exposure to extreme temperatures may adversely affect the camera's internal components and could cause a fire.

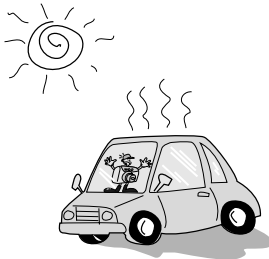

- When in use, do not cover the camera or AC Power Adapter. This may cause heat to build up and distort the camera body or cause a fire. Always use the camera and its accessories in a well-ventilated area.

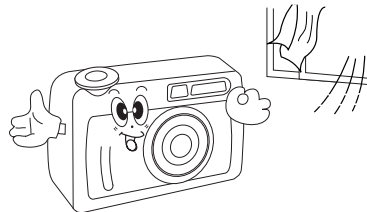



Danger

- Do not attempt to modify this camera in any way. This may result in fire, injury, electric shock or severe damage to you or your camera. Internal inspection, maintenance and repairs should be carried out by your dealer or Samsung Camera Service Center.

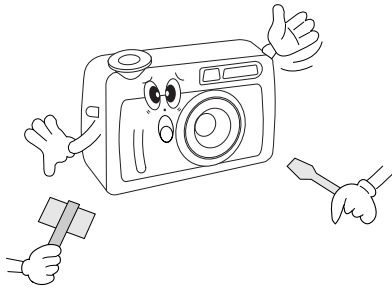

- Please do not use this product in close proximity to flammable or explosive gases, as this could increase the risk of explosion.

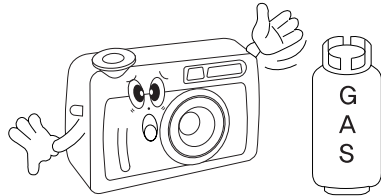

- Should any form of liquid or a foreign object enter the camera, do not use it. Switch off the camera, and then disconnect the power source (batteries or AC Power Adapter). You must contact your dealer or Samsung Camera Service Center. Do not continue to use the camera as this may cause a fire or electric shock.

- Do not insert or drop metallic or inflammable foreign objects into the camera through access points e.g. CARD slot and battery chamber. This may cause a fire or electric shock.

- Do not operate this camera with wet hands. This could pose a risk of electric shock.

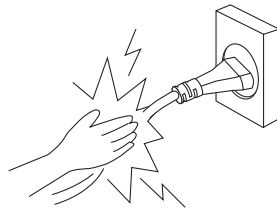

Special features

This digital camera has the following features.

- A fine resolution of 3.2 mega pixels
- A 3X optical and 4X digital zoom lens
- A superior Schneider lens
- 9 power source options (a world first!)
- A Super macro(6cm) function
- 3 different "My SET" modes

READY

An FCC warning

• This device has been tested in accordance with the limits of a class B digital device under item 15 of the FCC rules. These limits are designed to provide protection against harmful interference in commercial installation. This equipment generates, absorbs and can emit radio frequency energy. If it is not installed and used in accordance with the instructions, it may cause harmful interference to radio communication. There is however, no guarantee that interference will not occur in a some situations. Should any interference occur when this device is in operation, please try one or more of the following measures.

- Change the location and direction of any aerial.
 - Increase distance between camera and affected device.
 - Use a different socket away from the affected device.
 - Please contact a Samsung agent or a radio/TV engineer.
- This device complies with part 15 of the FCC Rules.

This digital camera can be used for



Printing images using a dedicated printer, DPOF-compatible printer or DPOF-equipped photo lab.(p.76)



Viewing images on a TV screen or external monitor (refer to page 92)



Taking a picture. (refer to page 26)



Down loading image files from camera to computer.(p.100)



Editing images on a PC.(p.123)

This digital camera can be used for

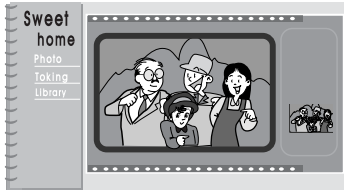

Creation of a digital photo album



Inserting images directly into any electronic document



Recording your voice
(refer to page 35)

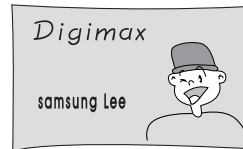

Taking a self-portrait and using the image to personalize name cards

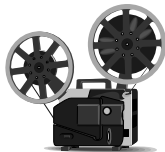

Recording a movie clip
(refer to page 30)

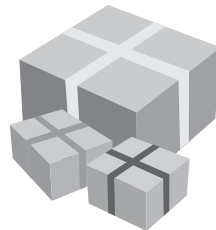

You can even create your own unique gift-wrap paper by using your digital images

Manufacturer's contents

Please check that you have the correct contents before using this product.

 marked contents are optional.

Digital Camera



Pouch



AV cable



USB cable



Camera strap



Software CD



User manual



Product warranty



SD memory card



CR-V3 battery

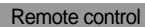

 Remote control

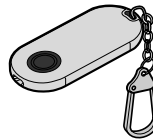

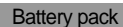
 Battery pack



Digimax Premium Power Pack : SLB-1437 KIT

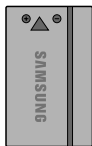

Rechargeable battery



Battery charger



Cigar jack for car



AC adapter

Identification of features

Front & Top

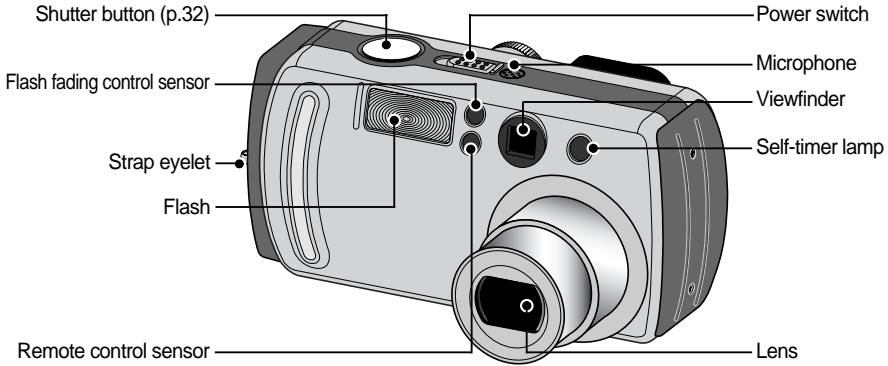

Back & Bottom

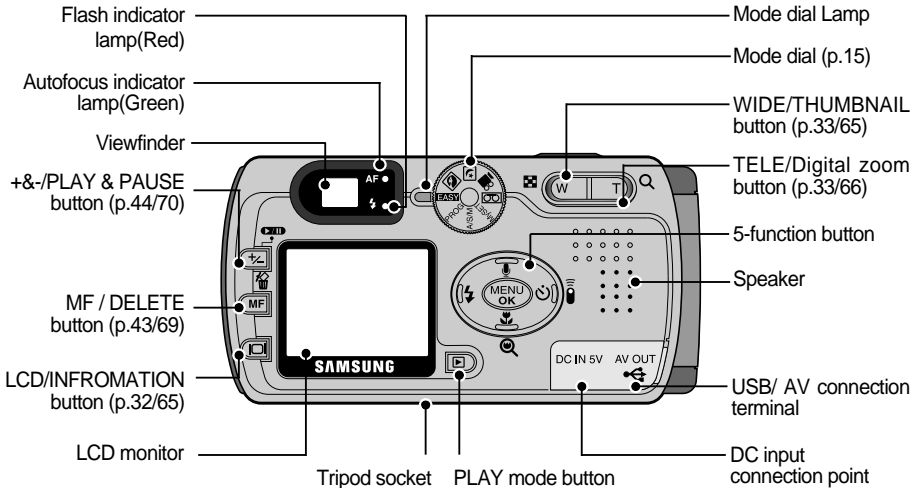

Identification of features

Side

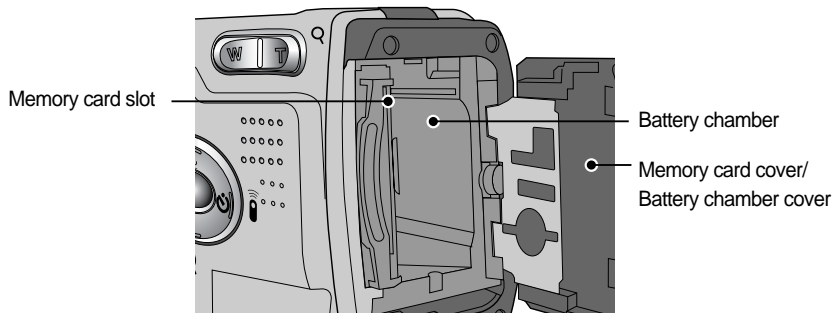

5-function button

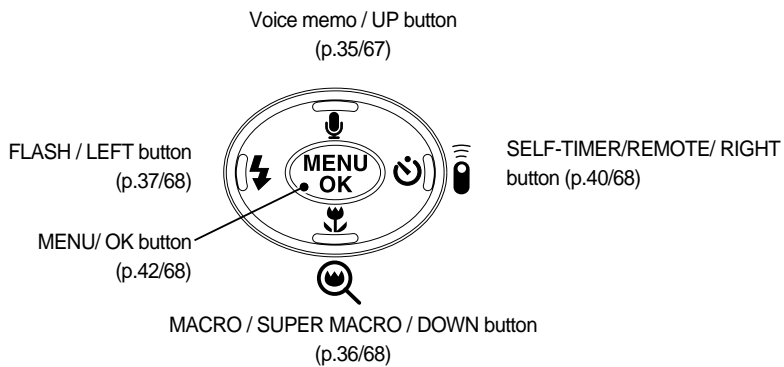

Mode dial

- You can select the desired working mode by using the mode dial located on the back of the camera.
- This digital camera has 8 working modes. These are listed below.

EASY

EASY

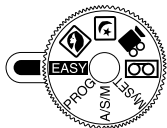

● Easy mode

To make camera operation easier, a bare minimum of camera settings are required in this mode, such as image size. (for printing, memo and email)

PROGRAM

PROG

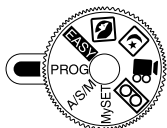

● Program mode

In program mode, you can take a properly exposed photograph. Moreover you can select all camera settings except aperture and shutter speed.

PORTRAIT

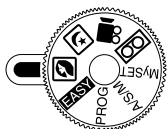

● Portrait mode

This is used for just portrait or both portrait and landscape shots.

NIGHT SCENE

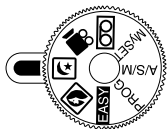

● Night scene mode

This mode is used at night or against a dark background.

Mode dial

A/S/M

A/S/M

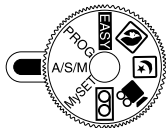

- Aperture priority / Shutter priority / Manual mode
The Aperture and Shutter can be set manually in the A/ S/ M mode.

MOVIE CLIP

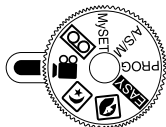

- Movie clip mode
A movie clip can be recorded as long as the available recording time allows.
Image size and type are listed below.
- Image size : 320 X 240
- File type : *.AVI

MySET

MySET

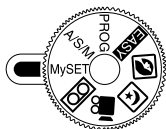

- User set mode
You can set your preferences and save them in this mode.
There are 3 kinds of user setting modes.

VOICE RECORDING

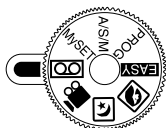

- Voice recording mode
You can do voice recording and other audio in this mode.

Connecting to Power

- There are two ways in which to provide the camera with power. You can use batteries (AA Alkaline, CR-V3, Ni-MH, Li-ion), or alternatively, you can use an AC(100 ~ 250V) Adapter (DC 5V 2.0A).

- Using the batteries

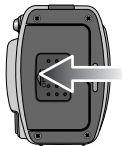

1. Open the battery chamber cover by pushing in the direction of the arrow.

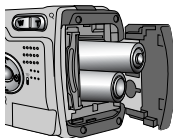

【 Inserting the AA type battery 】



【 Inserting the CR-V3 type battery 】

2. Insert the batteries taking note of the polarity (+ / -).

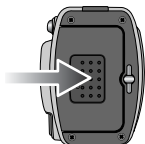

3. To close the battery chamber cover, push it until it clicks.

- Battery condition indicator

There are 3 indicators for battery condition that are displayed on the LCD monitor.



: The batteries are fully charged.



: Prepare new batteries.



: There is no battery capacity. Replace with new batteries.

Connecting to Power



INFORMATION

- ▶ This camera will automatically switch off when not in use for a period of time. Refer to [POWER OFF] function (p.81).
- ▶ We recommend batteries for digital camera (Within a year from the date of manufacture). The batteries are listed below.
 - Non rechargeable batteries : AA type - Alkaline, Ni-Mn, Ni-Zn, Lithium
CR-V3 type - Lithium
 - Rechargeable batteries : AA type - Ni-MH, Ni-Cd (over 1000mA)
Exclusive type - SLB-1437 (Digimax V3 only)
SBP-1103 (CR-V3 type)



NOTICE

- ▶ Important information about battery usage
 - It is easy to buy the alkaline batteries, but the duration for using batteries varies in accordance with the battery manufacturers or photography conditions.
 - Please remove the batteries if the camera will not be used for long periods. Batteries can lose power over time and are prone to leaking if kept inside the camera.
 - We recommend high capacity ALKALINE batteries as manganese batteries cannot deliver sufficient power.
 - Low temperatures (below 0°C) can affect the performance of the batteries and you may experience reduced battery life.
 - Batteries will usually recover at normal temperatures.
 - Do not use old and new batteries at the same time.
 - During extended use of the camera, the camera body may become warm. This is perfectly normal.
 - If you are planning to use this camera for long periods of time, it is advisable to use an AC adapter.

Connecting to Power

- Using the AC power adapter

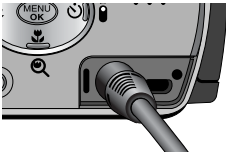

If you have access to a mains supply, using an AC Adapter allows the camera to be used for long periods of time. Plug the adapter into the connection point (DC IN 5V) on the camera. Remove the batteries when using the AC adapter.



DANGER

DANGER

- ▶ Always turn off the power before taking the AC adapter out of the mains supply.
- ▶ As with all mains powered devices, safety is important. Ensure that neither the camera nor adapter comes into contact with water or metallic materials.
- ▶ Please ensure that you use an AC adapter with the correct specification for the camera. Failure to do so may affect your warranty.

- Using the Digimax Premium Power Pack (Optional : SLB-1437 KIT)

The Digimax Premium Power Pack contains a rechargeable internal Li-ion battery, a battery charger, a cigar jack for car and an AC adapter for use with Digimax V3.

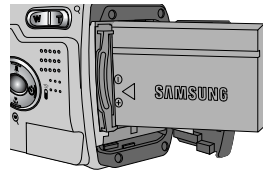

- Using the Digimax battery pack (Optional : SBP-3605, 5V)

The Digimax Battery Pack is a rechargeable external Li-ion battery for use with most digital cameras.

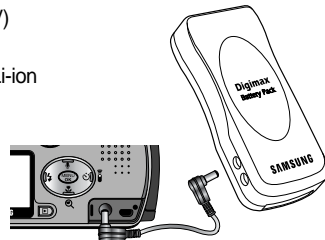

These optional battery packs provide long lasting power and their operating performances are much improved over Ni-MH and Alkaline batteries. This is due to the mass storage lithium ion cell. Contact your local dealer or the nearest authorized Samsung camera service center to buy the optional battery packs.

Inserting the memory card

1. Turn off the camera power and pull the memory card cover in the direction of the arrow to open.

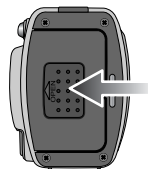

2. Insert the memory card all the way into the memory card slot. The Label stuck to the memory card and the front side of the camera should face in the same direction. The memory card pins and the LCD monitor should face in the same direction.

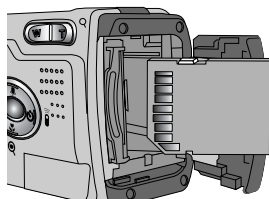

3. To close, push the card cover against the arrow until you hear a click.

If the card cover does not close, check that the memory card is inserted correctly. Do not force the memory card.

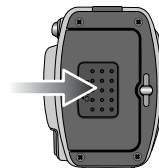

Removing the memory card

1. Turn the power off using the power switch. Open the memory card cover and press the memory card as shown in the image and release.

2. Remove the memory card and close the memory card cover.

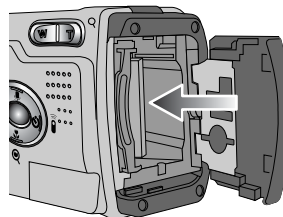

Instructions on how to use the memory card



NOTICE

- ▶ If you open the memory card cover when the camera power is turned on, the power will turn off automatically.
- ▶ Don't remove the memory card when the Autofocus indicator lamp(Green) is blinking as this may cause damage to data in the memory card.

- ▶ You can use both an SD memory card and Multi Media Card (MMC).
- ▶ We recommend using the SD memory card as the Multi-Media Card need more time to stored the image than the SD memory card.

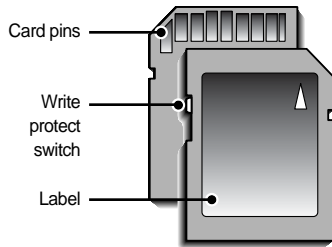

The SD memory card has a write protect switch that prevents image files from being deleted or formatted. By sliding the switch to the bottom of the SD memory card, the data will be protected. By sliding the switch to the top of the SD memory card, the data protection will be canceled. Check the switch position before taking an image.

[SD(Secure Digital) memory card]

- ▶ When using a 32MB SD memory card, the specified shooting capacity will be as follows. (These figures are intended as an indication of expected performance). These figures are approximate as image capacities can be affected by variables such as memory performance and subject matter.

Recorded image size	TIFF	Super fine	Fine	Normal
2048X1536 (Large)	3	16	33	67
2048X1360 (Photo)	3	19	38	76
1024X768 (Medium)	13	67	135	271
512X384 (Small)	54	271	542	1085
EASY mode	Print	Memo	E-mail	
	19	135	1085	

Instructions on how to use the memory card

■ Maintenance of the memory card

- Turn off the camera power whenever the memory card is being inserted or removed.
- Repeated use of the memory card will eventually reduce the memory card's performance. Should this be the case, you will need to purchase a new memory card.
- Wear and tear on the memory card is not covered by the Samsung warranty.
- The memory card is an electronic precision device. Do not bend, drop or subject the memory card to any heavy impact.
- Do not store the memory card in an environment with strong electronic or magnetic fields, e.g. near loud speakers or TV receivers.
- Please do not use or store in an environment where there are extremes in temperature.
- Do not allow the memory card to become dirty or to come into contact with any liquid. Should this happen, clean the memory card with a soft cloth.
- Please keep the memory card in its case when not in use.
- During and after periods of extended use, you may notice that the memory card is warm. This is perfectly normal.
- Do not use the memory card that is used in another digital camera or memory card reader.
- Do not use the memory card formatted by another digital camera or memory card reader.

■ Preserving the memory card data

- If the memory card is subjected to any of the following, the recorded data may become corrupted :
 - When the memory card is used incorrectly.
 - If the power is switched off or the memory card is removed while recording, deleting (formatting) or reading.
- Samsung cannot be held responsible for lost data.
- It is advisable to copy important data onto other media as back-up e.g. floppy disks, hard disks, CD etc.
- If there is insufficient memory available :
If you press the shutter button for the shot, [CARD FULL !] message is displayed and the camera will not operate. To optimize the amount of memory in the camera, replace the memory card or delete unnecessary images stored on the memory.

Selecting the date and time

- You can record the date and time with the image data in the memory card.

1. Turn on the power and press the MENU button.

The recording mode menu will be displayed in the RECORDING mode, and the play mode menu will be displayed in the PLAY mode.

(There is no associated menu in VOICE RECORDING mode.)

2. Select the [SETUP] tab by pressing the RIGHT button.

Select the [FORMAT] menu by pressing the DOWN/button.

Press the DOWN / button again and the next menu page will be displayed.

Press the UP or DOWN button and select [DATE SET].

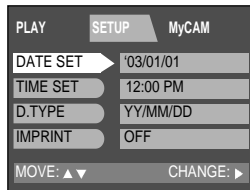

3. Shift the cursor to the [DATE SET] sub menu by pressing the RIGHT button.

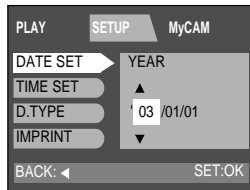

INFORMATION

- ▶ Date setting range : 2002/01/01 ~ 2050.12.31
(Leap years and months are corrected automatically)
- ▶ The default is 2003/01/01. 12:00 p.m.

Selecting the date and time

4. Select the correct date by pressing the 5-function button.
RIGHT button : selects YEAR/ MONTH/ DAY item.
UP or DOWN button : changes the value of each item.

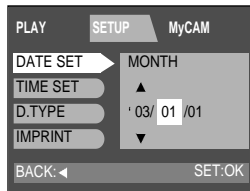

5. Press the OK button to confirm the setting.
To return to the main menu or cancel the setting, press the LEFT button.

6. To select the correct time, select [TIME SETUP] at step 2.
Press the MENU button again and the menu will be cancelled.

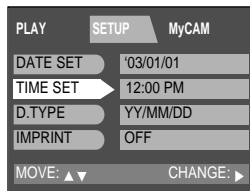

NOTICE

- ▶ If the batteries are removed, the date and time settings will remain for approximately 1 hour. After approximately 1 hour, the date and time will be changed to the default date and time.
- ▶ If the batteries are removed for a period longer than 1 hour, it may be necessary to reset the date and time.

Language

- There is a choice of languages that can be displayed on the LCD monitor.

1. Turn on the power and press the MENU button.

The recording mode menu will be displayed in RECORDING mode, and the play mode menu will be displayed in the PLAY mode. (There is no associated menu in VOICE RECORDING mode.)

2. Select the [SETUP] tab by pressing the RIGHT button.

Press the UP or DOWN button and select [LANGUAGE].

3. Shift the cursor to the [LANGUAGE] sub menu by pressing the RIGHT button and select the language that you want by pressing the UP or DOWN button.

4. Press the OK button to confirm the setting.

To return to the main menu or cancel the setting, press the LEFT button.

Press the MENU button again and the menu will be cancelled.

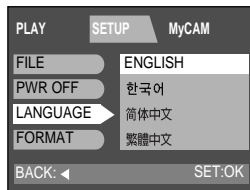
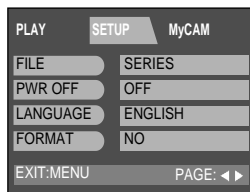

INFORMATION

- ▶ The default language is ENGLISH.
- ▶ You can select 15 languages. Those are listed below.
English, Korean, T. Chinese, S. Chinese, Japanese, Russian, Germany, Spanish, French, Italian, Danish, Dutch, Swedish, Finnish, Portuguese.
- ▶ Even if the camera is restarted, the language setting will be maintained.
- ▶ Even if the [SOUND] function is [ON], the sound will not activate in this menu.

Recording mode

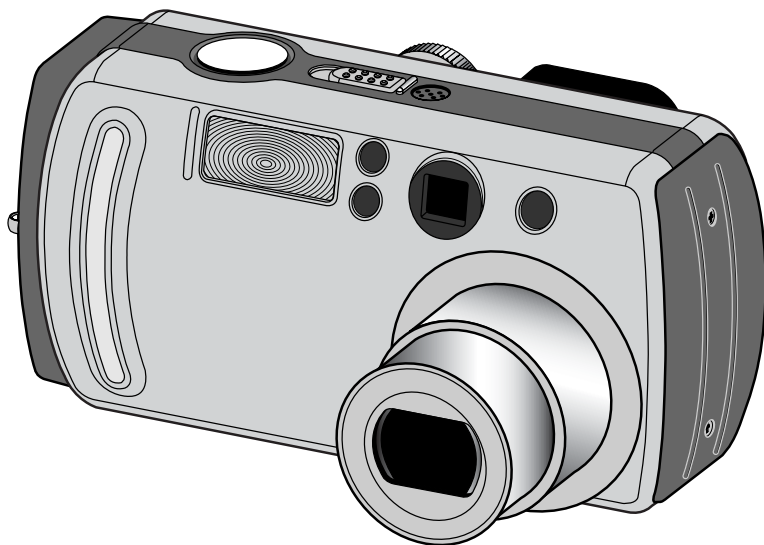

LCD monitor indicator

- The LCD monitor displays information about the shooting functions and selections.

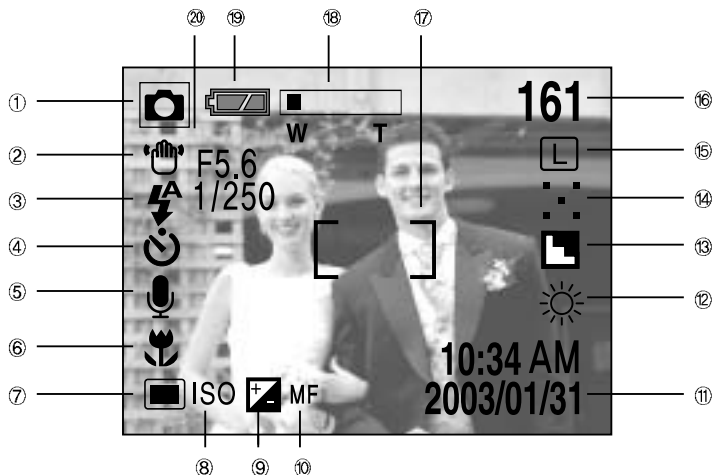



























【 Image & Full Status 】

RECORDING

No.	Description	Icons	Page
1	Recording mode		p.15
2	Camera shake warning		p.31
3	Flash		p.37
4	Self-timer, Remote		p.40
5	Voice memo		p.35
6	Macro/ Super macro		p.36

LCD monitor indicator

No.	Description	Icons	Page
7	Metering	 	p.53
8	ISO	ISO	p.55
9	Exposure compensation		p.44
	Aperture compensation	 F5.6	p.44
	Shutter speed compensation	 1/250	p.44
10	Manual focus	MF	p.43
11	Date / Time	2003/01/31 10:34 AM	
12	White Balance	AUTO    	p.56
13	Sharpness	  	p.58
14	Image quality	TIFF   	p.50
15	Image size	   /   	p.49
	Continuous shot, AEB	 	p.54
16	Number of available shots remaining	161	
	Remaining time(Movie clip/ Voice recording)	00:01:40 (hour : minute : second)	
17	Auto focus frame	[]	
18	Zoom / Digital Zoom	 x4.0	p.33
19	Battery	  	p.17
20	Aperture value	F5.6	p.45
	Shutter speed	1/250	p.45

Starting recording mode

■ Recording a still image

1. Insert the batteries (p.17).
Insert the batteries taking note of the polarity (+ / -).
2. Insert the memory card (p.20).
3. Close the memory card cover.
4. Slide the power switch to turn on the camera.
5. Select the PROGRAM mode by rotating the mode dial.
6. Point the camera towards the subject and compose the image by using either the viewfinder or LCD monitor.
7. Press the shutter button to capture an image.

* [DELETE] message may be displayed after taking a picture.
Refer to p.93 for more information about [DEL. ANSWER].

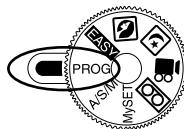

[PROGRAM mode]

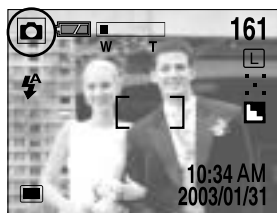

[PROGRAM mode]



NOTICE

- ▶ A Blinking autofocus indicator lamp means that the camera cannot focus on the subject.
Should this be the case, the camera is unable to capture an image clearly.



INFORMATION

- ▶ Manner mode
Pressing the power button over 2 seconds changes the buzzer and start-up sound setting to OFF, though you have set the settings to ON. If you wish to hear the buzzer sound and start-up sound, set the [SOUND] and [S.SOUND] settings in the SETUP mode to ON.
- ▶ There are two LED lamps (one green, one red) positioned next to the viewfinder.
 - If the camera is in focus when you press the shutter button halfway, the green LED will illuminate and you can take an image. If the camera can focus on the subject, the autofocus frame in the center of the LCD monitor will change from white to green.
 - If the red lamp illuminates, the flash can fire.
 - If the red lamp blinks, the flash is being charged.
 - When an image is being stored onto the memory card, the green lamp blinks slowly. When the image data has been stored, the green LED light will go out. After the green LED light has gone out, you can resume taking images.

Starting recording mode

■ Recording a Movie clip

Steps from 1-4 are the same as those for recording a still image.

5. Select the MOVIE CLIP mode by rotating the mode dial.

6. Point the camera towards the subject and compose the image by using either the viewfinder or LCD monitor.

7. Press the shutter button to take a movie clip.

- Press the shutter button once and movie clips are recorded for as long as the available recording time allows. Movie clips will still be recorded if the shutter button is released.
- If you wish to stop recording, press the shutter button again.
- Image size and type are listed below.
 - Image size : 320 x 240
 - File type : *.AVI

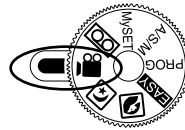

[MOVIE CLIP mode]

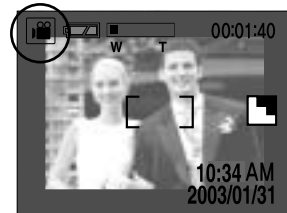

[MOVIE CLIP mode]



INFORMATION

- ▶ The available recording time may vary depending on shooting conditions and camera settings.

■ Recording audio

Steps from 1-4 are the same as those for recording a still image.

5. Select the VOICE RECORDING mode by rotating the mode dial.

6. Press the shutter button to record audio.

- Press the shutter button once and audio is recorded for as long as the available recording time allows. The recording time will be displayed on the LCD monitor.
- Audio will still be recorded if the shutter button is released.
- If you wish to stop recording, press the shutter button again.

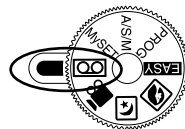

[VOICE RECORDING mode]

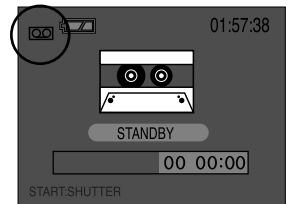

[VOICE RECORDING mode]

Starting recording mode



INFORMATION

- ▶ A distance of 40cm between you and the camera (microphone) is the best distance to record sound.



NOTICE

- ▶ Camera shake warning.
When the Flash Off or Slow synchro mode is selected in a low lighting condition, the camera shake warning indicator () may appear on the LCD monitor. In this case, use a tripod, support the camera on a solid surface or change the flash mode to flash shot mode.
- ▶ Backlight compensated shots
When taking an outdoor shot, avoid facing the sun, as the image may be dark because of the strong backlight. In backlight conditions, please use the exposure compensation in the PROGRAM or A/S/M mode. (refer to page 51).
- ▶ Avoid obstructing the lens or the flash when you capture an image.
- ▶ As there can be some differences between what is seen through the Viewfinder and the resulting image when taken at a range closer than 1.5m, it is recommended that you use the LCD monitor to compose these shots.
- ▶ Using the LCD monitor extensively will drain the batteries.
We recommend turning off the LCD monitor and using the optical viewfinder as often as possible in order to extend battery life.
- ▶ Under certain conditions the auto focus system may not perform as expected.
 - When photographing a subject that has little contrast.
 - If the subject is highly reflective or shiny.
 - If the subject is moving at high speed.
 - When there is strong reflected light, or when the background is very bright.
 - When the subject matter has only horizontal lines or the subject is very narrow (such as a stick or flagpole).
 - The subject is too dark.

Using the camera button to adjust the camera

LCD button



- You can check the recording status in the LCD monitor.

Pressing the LCD button in the RECORDING (EASY, PROGRAM, PORTRAIT, NIGHT SCENE, A/S/M, MOVIE CLIP, My SET) mode will change the display as shown below.

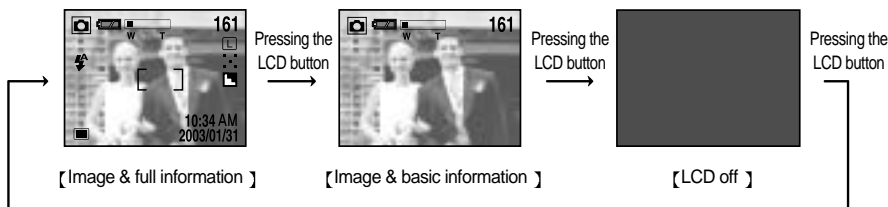
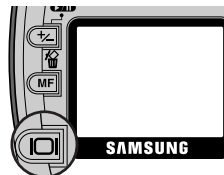

- The LCD monitor is not turned off in the VOICE RECORDING mode.

SHUTTER button



Used for taking an image or recording audio in the RECORDING (EASY, PROGRAM, PORTRAIT, NIGHT SCENE, A/S/M, MOVIE CLIP, USER SET, VOICE RECORDING) mode.

- In EASY, PROGRAM, PORTRAIT, NIGHT SCENE, A/S/M, MySET mode
 - Pressing the shutter button down halfway activates the autofocus and checks the condition of the flash.
 - Pressing the shutter down fully takes the image and stores the relevant data regarding the shot.
- In MOVIE CLIP, VOICE RECORDING mode
 - Pressing the shutter down fully takes the movie clip or records the audio. Press the shutter button once and the movie clip or the audio is recorded for as long as the available recording time allows. Movie clips or audio will still be recorded if the shutter button is released. If you wish to stop recording, press the shutter button again.

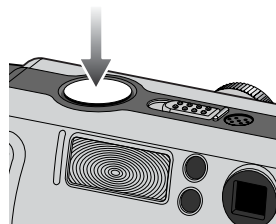

WIDE / TELE button



- Used for digital or optical zooming in / out.
- This camera has a 3X optical zoom and a 4X digital zoom function. Using both will offer a total zoom ratio of 12X.
- When you press the zoom (W/T) button, the zoom bar will display in the upper centre of the LCD monitor.

Zoom TELE

- Optical zoom TELE
 - Pressing the zoom button T.
 - This will zoom into the subject i.e. the subject will appear nearer.
- Digital zoom TELE
 - When the maximum (3X) optical zoom is selected, pressing the zoom button T activates the digital zoom software.
 - Releasing zoom button T stops the digital zooming at the required setting.
 - Once the maximum digital zoom (4X) is achieved, pressing the zoom button T will have no effect.
 - You can check the digital zoom rate with the [X1.1 ~ X 4.0] numerical mark next to the zoom bar.

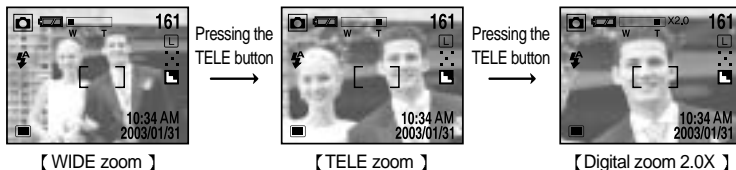

INFORMATION

- ▶ To use the digital zoom the LCD monitor has to be turned on.
- ▶ Images taken using the digital zoom may take a little longer for the camera to process. Allow time for this to take place.
- ▶ The digital zoom cannot be used in continuous shots, AEB shots and movie clip shots.
- ▶ You may notice a decrease in image quality when using the digital zoom.
- ▶ When the maximum (3X) optical zoom is selected, pressing the zoom button T increases the digital zoom ratio by 0.1 steps.
- ▶ If the movie clip is being recorded, the zoom operation cannot be activated.

WIDE / TELE button



Zoom WIDE

● Optical zoom WIDE

- Pressing the zoom button W.

This will zoom out from the subject i.e. the subject will appear further away.

- Pressing the W button continuously will set the camera to its minimum zoom setting i.e. the subject appears at its furthest from the camera.

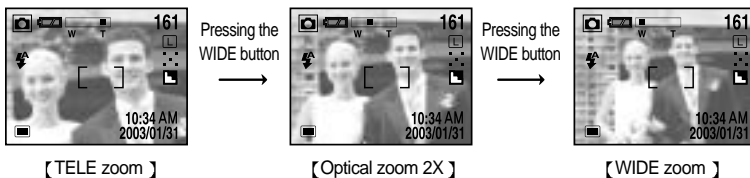

● Digital zoom WIDE

- When the digital zoom is in operation, pressing the zoom button W will reduce the digital zooming in steps.
- Releasing zoom button W stops digital zooming.
- Pressing the W button will reduce the digital zoom and then it will proceed to reduce the optical zoom until the minimum setting is reached.

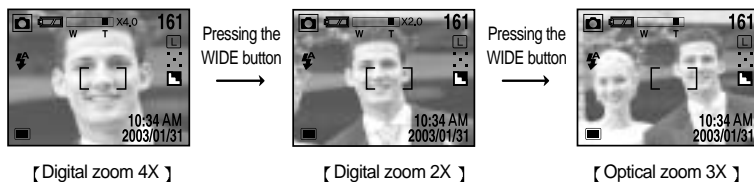

NOTICE

- ▶ Take care not to touch the lens to avoid taking an unclear image and possibly causing camera malfunction. If the image is dim, turn the camera power off and on again to modify the lens position.
- ▶ Take care not to press the lens as this may cause a camera malfunction.
- ▶ When the camera is turned on, take care not to touch the camera's moving lens parts as this may cause the resulting image to be dim and unclear.
- ▶ Take care not to touch the lens during the zoom operation as this may cause damage.

UP/ Voice memo () button



- When the menu is displayed on the LCD monitor, pressing the UP button makes the menu cursor move up or change the sub menu value.
- When the menu is not displayed on the LCD monitor, the UP button operates as the voice memo button. You can add your voice to a stored still image.

● Recording a voice memo

1. Rotate the mode dial to the RECORDING(except MOVIE CLIP, VOICE RECORDING) mode.
2. Press the VOICE MEMO button.
If the voice memo indicator is displayed on the LCD monitor, the setting is completed.
3. Press the shutter button and take a picture.
The picture is stored on the memory card.
4. Voice memo will be recorded for ten seconds from the moment the picture is stored.
In the middle of the sound recording, pressing the shutter button will stop the voice memo.

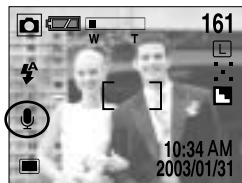

● Voice memo setting

Camera working mode	Setting
EASY	User can select the voice memo on / off
PROGRAM	
PORTRAIT	
NIGHT SCENE	
A/ S/ M, MySET	
MOVIE CLIP	User can select the sound recording on / off
VOICE RECORDING	Not Available



INFORMATION

- ▶ A distance of 40cm between you and the camera (microphone) is the best distance to record a voice memo.
- ▶ Voice memo function is inactivated after finishing a voice memo.
- ▶ If you record a new voice memo to an image that had a voice memo, the existing voice memo is deleted and a new voice memo will be recorded.

RECORDING

- When the menu is displayed on the LCD monitor, pressing the DOWN button makes the menu cursor move down or changes the sub menu value.
- When the menu is not displayed on the LCD monitor, the button operates as the MACRO (🌸) / SUPER MACRO (🔍) button. The photography range is 0.06m ~ 0.8m.
- Selecting the MACRO/ SUPER MACRO
 1. Rotate the mode dial to the RECORDING (except PORTRAIT, NIGHT SCENE, VOICE RECORDING) mode.
 2. Press the MACRO button. The macro indicator will be displayed on the LCD monitor. Press the MACRO button until the desired MACRO mode indicator displays on the LCD monitor. In the MOVIE CLIP mode, only the macro mode can be used.





[Selecting the macro mode]



[Selecting the super macro mode]

3. Take a picture with the desired macro mode.

● Macro mode type

Icon	Macro mode	Definition
	MACRO	Used for macro shots (0.3 m ~ 0.8m).
	SUPER MACRO	Used for macro shots (0.06m ~ 0.3m).



NOTICE

- ▶ The super macro can be activated only in the wide zoom mode.
- ▶ You cannot use the zoom(wide/tele) button in the super macro mode.

MACRO (🌸) / SUPER MACRO (🔍) button

● Macro mode setting

Camera working mode	Setting (<input type="checkbox"/> marked camera working mode is the default setting.)
EASY	<input type="checkbox"/> Normal → Macro → Super macro
PROGRAM	
PORTRAIT	<input type="checkbox"/> Normal (Fixed)
NIGHT SCENE	<input type="checkbox"/> Normal (Fixed)
A/ S/ M, USER SET	<input type="checkbox"/> Normal → Macro → Super macro
MOVIE CLIP	<input type="checkbox"/> Normal → Macro
VOICE RECORDING	Not Available



INFORMATION

- ▶ When the macro or super macro mode is selected, It is possible that camera shake will occur. If this is the case, use a tripod to eliminate this.
- ▶ When super macro is selected, the flash mode is changed to Flash off automatically.

RECORDING

FLASH (⚡) button



- When the menu is displayed on the LCD monitor, pressing the LEFT button makes the cursor shift to the main menu.
- When the menu is not displayed on the LCD monitor, the LEFT button operates as the FLASH (⚡) button.

● Selecting the flash mode

1. Rotate the mode dial to the RECORDING (except MOVIE CLIP, VOICE RECORDING) mode.
2. Press the FLASH (⚡) button until the desired FLASH mode indicator displays on the LCD monitor.
Use the correct flash to suit the environment.



[Selecting the Auto flash]

FLASH (⚡) button



● Flash mode indicator

Indicator	Flash mode	Indicator
	Definition	If the subject or background is dark, the camera flash will operate automatically.
	Red eye reduction	If a subject or background is dark, the camera flash will work automatically and will reduce the red-eye effect by using the red-eye reduction function.
	Fill in flash	The flash fires regardless of available light. The intensity of the flash will be controlled, according to the prevailing conditions. The brighter the background or subject is, the less intense the flash will be.
	Slow synchro	The flash will operate in conjunction with a slow shutter speed in order to obtain the correct exposure. We recommend using a tripod. When you take an image in a low light condition, the camera shake warning indicator () will display on the LCD monitor.
	Flash off	The flash does not fire. Select this mode when capturing images in a place or situation where flash photography is prohibited. When you take an image in a low light condition, the camera shake warning indicator () will display on the LCD monitor.



INFORMATION

- ▶ Using the flash frequently will reduce the life of the batteries.
- ▶ Under normal operating conditions the charging time for the flash is normally within 7 seconds. If the batteries are weak, the charging time will be longer.
- ▶ In super macro mode, continuous shot or AEB mode, the flash function will not operate.

FLASH () button



● Flash mode setting

Camera working mode	Setting (<input type="checkbox"/> marked camera working mode is the default setting.)
EASY	<input type="checkbox"/> Red eye reduction → Off
PROGRAM, MySET	<input type="checkbox"/> Auto → Red eye reduction → Fill in → Slow synchro → Off
PORTRAIT	<input type="checkbox"/> Red eye reduction → Fill in → Off
NIGHT SCENE	<input type="checkbox"/> Slow synchro → Off
A/ S/ M	<input type="checkbox"/> Off → Fill in → Slow synchro
MOVIE CLIP	<input type="checkbox"/> Flash off (Fixed)
VOICE RECORDING	Not Available



NOTICE

- ▶ Take photographs within the flash range.
- ▶ The flash ranges are listed below.

ISO		Auto	100	200	400
Normal focus	WIDE	0.8 ~ 3m	0.8 ~ 2.6m	1 ~ 3.7m	1 ~ 5.2m
	TELE	0.8 ~ 2m	0.8 ~ 1.5m	1 ~ 2.1m	1 ~ 2.9m
MACRO	WIDE	0.3 ~ 0.8m	0.3 ~ 0.8m	0.3 ~ 0.8m	0.3 ~ 0.8m
	TELE	0.3 ~ 0.8m	0.3 ~ 0.8m	0.3 ~ 0.8m	0.3 ~ 0.8m

- ▶ The image quality is not guaranteed if the subject is too close or highly reflective.
- ▶ The LCD monitor is turned off for a while after using the flash to recharge it.

SELF-TIMER / REMOTE button



- When the menu is displayed on the LCD monitor, pressing the RIGHT button makes the cursor shift to the sub menu.
- When the menu is not displayed on the LCD monitor, the RIGHT button operates as the SELF-TIMER (🕒) / REMOTE (📶) button.
- Selecting the self-timer
 1. Rotate the mode dial to the RECORDING (except VOICE RECORDING) mode.
 2. Press the SELF-TIMER button until the desired mode indicator displays on the LCD monitor.

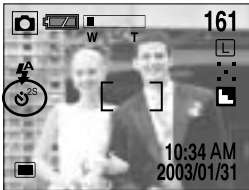

[Selecting the 2sec. self-timer mode]

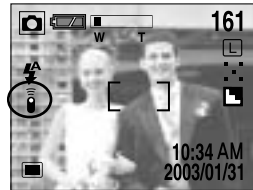

[Selecting the remote mode]

- Selecting the self-timer mode : Pressing the shutter button will allow an interval of ten seconds before the image is taken. After that, the self-timer is cancelled.
- Selecting the remote mode : Pressing the shutter button in the remote controller will allow an interval of 2 seconds before the image is taken. In the remote mode, you cannot use the shutter button.

● Self-timer/ remote mode definition

Indicator	Mode	Definition
🕒 ^{2s}	2s	Pressing the shutter button will allow an interval of 2 seconds before the image is taken.
🕒	10s	Pressing the shutter button will allow an interval of 10 seconds before the image is taken.
📶	Remote mode	You can take a picture with the remote controller.

SELF-TIMER / REMOTE button



● Self-timer/ remote mode setting

Camera working mode	Setting (<input type="checkbox"/> marked camera working mode is the default setting.)
EASY	<input type="checkbox"/> → 10s self-timer → Remote
PROGRAM	<input type="checkbox"/> → 2s self-timer → 10s self-timer → Remote
PORTRAIT	
NIGHT SCENE	
A/ S/ M, MySET	
MOVIE CLIP	<input type="checkbox"/> → Remote
VOICE RECORDING	Not Available



INFORMATION

▶ Self-timer lamp

- In 10s self-timer : For the first seven seconds, the LED blinks at one second intervals.
For the final three seconds, the LED blinks quickly at 0.5 second intervals.
- In 2s self-timer : The LED blinks at 2second intervals.

- ▶ If you operate the Power switch, Mode dial, and Self-timer button during the self-timer operation, the self-timer function is cancelled.
- ▶ Use a tripod to prevent the camera from shaking.

RECORDING

● Remote control range

When you take a picture by using the remote control, refer to the illustration as shown alongside about the remote control range.

[Shutter button on the remote control]

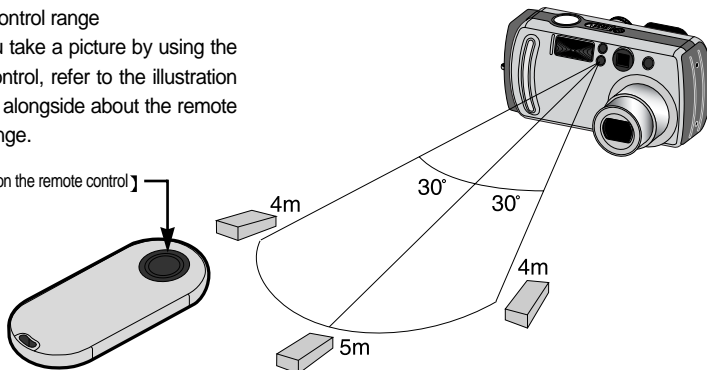

SELF-TIMER/ REMOTE button

● Changing the remote controller battery

Contact your dealer or Samsung camera service center to buy the battery. The battery type is CR2050S 3V.



MENU/ OK button

■ MENU button

- When you press the MENU button, a menu related to each camera mode will be displayed on the LCD monitor. Pressing it again will return the LCD to the initial display.
- A menu option can be displayed when the following are selected.
EASY, PROGRAM, PORTRAIT, NIGHT SCENE, A/S/M, MOVIE CLIP and MySET.
There is no menu available when the VOICE RECORDING mode is selected.



[menu off]

Pressing the
MENU button



[menu on]

■ OK button

- When the menu is displayed on the LCD monitor, this button is used for shifting the cursor to the sub menu or for confirming data.



INFORMATION

- ▶ The menu will not be displayed on the LCD monitor in the following circumstances:
 - When another button is being operated.
 - While image data is being processed. (when the green LED next to the viewfinder blinks)
 - When there is no battery capacity.
- ▶ When the menu is showing on the LCD monitor, it is not possible to operate the shutter button i.e. take an image. To take an image, simply cancel the menu display by pressing the MENU button.

MF button



- In dark conditions, the autofocus may not function. If this occurs, press the MF button and you can select manual focus.
- After changing the focus manually, the image can be dim. Take care when using this function.

While pressing the MF button, the MF bar will be displayed on the LCD monitor.

While pressing the MF button, select desired focus value by pressing the UP/ DOWN button and take a picture.

- Pressing the UP button : Focus at long range.
- Pressing the DOWN button : Focus at close range.

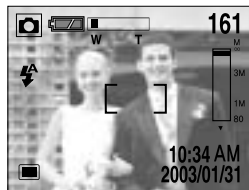

[Pressing the MF button]

Release the MF button and the MF bar will disappear. If you change the focus value, the MF indicator will be displayed at the bottom of the LCD monitor.

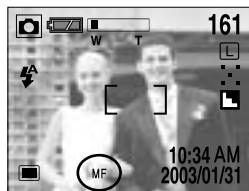

[After changing the focus value]



INFORMATION

- ▶ If you didn't change the focus value while pressing the MF button, the auto focus is activated.
- ▶ The manual focus function is disabled in the EASY and VOICE RECORDING mode.
- ▶ The MF bar is divided into 3 parts according to the photography range.

Part of the MF bar	Photography range
1st part	0.8m ~ infinity
2nd part	0.3m ~ 0.8m
3rd part (only in wide zoom mode)	0.06m ~ 0.3m

- ▶ When the photography range is within 0.06m ~ 0.3m, the flash mode is changed to FLASH OFF automatically.
- ▶ When you press the MF button, the numerical indicators will display on the right side of the LCD monitor. The figures are distances from the camera lens.
- ▶ The numerical indicators are just for your reference. Focus the subject by using the LCD monitor when using the manual focus.

+/- button



- This camera automatically adjusts the exposure according to the ambient lighting conditions. However, you can select the exposure value by using this button.
- You can select the shutter speed and aperture value in the A/S/M mode.

- In the PROGRAM, PORTRAIT, MySET mode
 - While pressing the +/- button, select the desired exposure value by pressing the LEFT/ RIGHT button.

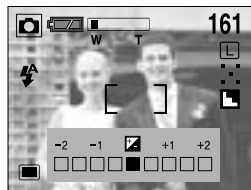

[RECORDING mode]

- Aperture priority mode(A)
 - While pressing the +/- button, select the desired aperture value by pressing the UP/ DOWN button.
 - While pressing the +/- button, select the desired exposure value by pressing the LEFT/ RIGHT button.

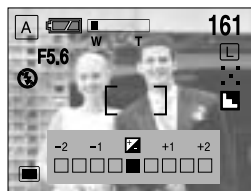

[Aperture priority mode]

- Shutter priority mode(S)
 - While pressing the +/- button, select the desired shutter speed by pressing the UP/ DOWN button.
 - While pressing the +/- button, select the desired exposure value by pressing the LEFT/ RIGHT button.

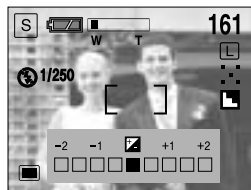

[Shutter priority mode]

+/- button



● Manual mode (M)

- While pressing the +/- button, select the desired shutter speed by pressing the UP/ DOWN button.
- While pressing the +/- button, select the desired aperture value by pressing the LEFT/ RIGHT button.

In the manual mode, the exposure value can't be compensated.

Refer to page 51 for information on selecting the aperture priority / shutter priority / manual mode.

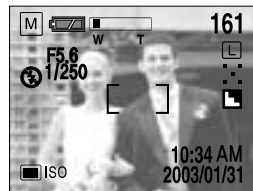

[Manual mode]



INFORMATION

- ▶ If you change the exposure value, the expose indicator () will be displayed on the bottom of the LCD monitor.
- ▶ When the camera is turned on again, the exposure compensation setting returns to 0.0EV (discarding the exposure compensation).
- ▶ Exposure compensation setting range : -2.0 ~ +2.0 EV (0.5 EV steps)
- ▶ If you increase the exposure value, the image will be brighter. If you decrease the exposure value, the image will be darker.
- ▶ The aperture value (Av) or shutter speed (Tv) can be selected according to the P/A/S/M mode in the MySET mode.
- ▶ Decreasing or increasing the exposure value may lead to images being under or over exposed (too dark or too bright).

Using the LCD monitor to adjust the camera

- Using the LCD monitor to adjust the camera

- Recording functions can be changed by using the LCD monitor.
- In the RECORDING (EASY, PROGRAM, PORTRAIT, NIGHT SCENE, A/S/M, MOVIE CLIP, MySET, VOICE RECORDING) mode, pressing the MENU button displays the menu on the LCD monitor.
- The following functions are available, depending on the mode you have selected.

Main menu	Sub menu	Secondary menu	Camera working mode
SIZE	PRINT(2048 x 1360 /SUPER FINE)		EASY
	MEMO(1024 x 768 /FINE)		
	E-MAIL(512 x 384 /NORMAL)		
	[L] 2048 x 1536		PROGRAM, PORTRAIT, NIGHT SCENE, A/S/M, MySET 1/2/3
	[P] 2048 x 1360		
	[M] 1024 x 768		
	[S] 512x 384		
QUALITY	TIFF		PROGRAM, PORTRAIT, NIGHT SCENE, A/S/M, MySET 1/2/3
	SUPER FINE		
	FINE		
	NORMAL		
P/A/S/M	P/A/S/M		MySET 1/2/3
A/S/M	APERTURE PRIORITY		A/S/M, MySET 1/2/3
	SHUTTER PRIORITY		
	MANUAL		
METERING	MULTI		PROGRAM, PORTRAIT, A/S/M, MySET 1/2/3
	SPOT		
SHOOT MODE	SINGLE	# of prints ▲ ▼	EASY, PROGRAM, PORTRAIT, MySET 1/2/3
	CONTINUOUS		
	AEB	±0.5 EV ▲ ▼	EASY, PROGRAM, PORTRAIT, MySET 1/2/3
ISO	AUTO		PROGRAM, A/S/M([AUTO] is not available), MySET 1/2/3
	100		
	200		
	400		

Using the LCD monitor to adjust the camera

Main menu	Sub menu	Secondary menu	Camera working mode
WHITE BALANCE	AUTO		PROGRAM, A/S/M, MOVIE CLIP, MySET 1/2/3
	DAYLIGHT		
	CLOUDY		
	FLUORESCENT		
	TUNGSTEN		
EFFECT	NORMAL		PROGRAM, A/S/M, MOVIE CLIP, MySET 1/2/3
	BLACK & WHITE		
	sRGB		
	SUNSET		
SHARPNESS	SOFT		PROGRAM, A/S/M, MOVIE CLIP, MySET 1/2/3
	NORMAL		
	VIVID		



INFORMATION

- ▶ The menu will not be displayed on the LCD monitor in the following circumstances:
 - When another button is being operated.
 - While image data is being processed. (when the green LED next to the viewfinder blinks)
 - When there is no battery capacity.
- ▶ When the menu is showing on the LCD monitor, it is not possible to operate the shutter button i.e. capture an image. To capture an image, simply cancel the menu display by pressing the MENU button.

How to use the menu

- Every camera working mode has [SETUP] and [MyCAM] tabs in their own menu.
- The main menus of the first tab are changed by different camera working modes.

1. Turn the camera power on and press the menu button. There are 3 tabs related to each camera mode in the menu. There is no menu available when the VOICE RECORDING mode is selected.
2. Shift the tab cursor by pressing the LEFT/ RIGHT button.

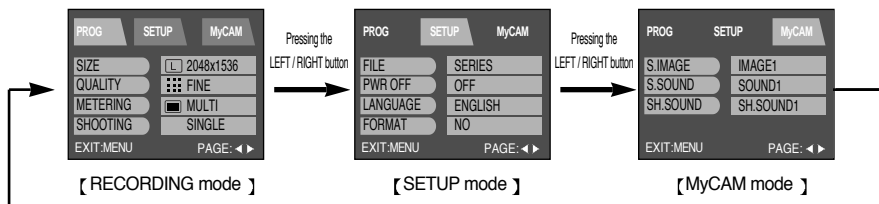

3. Select a menu by pressing the UP/ DOWN button.



4. Shift the cursor to the sub menu by pressing the RIGHT button. To shift the cursor to the main menu, press the LEFT button.
5. Select the desired sub menu by pressing the UP/ DOWN button. If there is another menu under the sub menu, press the RIGHT or OK button and the cursor shifts to another sub menu. To shift the cursor to the previous menu or cancel the menu setting, press the LEFT button.
6. Press the OK button to confirm the setting.
Press the menu button twice and the menu display will disappear.

Size



■ You can select the image size you require.

1. Rotate the mode dial to the RECORDING mode and press the MENU button.
2. Press the DOWN button and the cursor will be shifted to the main menu.
3. Select [SIZE] menu by pressing the UP/DOWN button.
4. Press the RIGHT button and the cursor will shift to the [SIZE] sub menu.

● EASY mode

Select the desired sub menu by pressing the UP/DOWN button.

- PRINT : [P] Taking a picture for printing
(2048 X 1360 / Super fine)
- MEMO : [M] Taking a picture for a web site image
(1024 X 768 / Fine)
- E-MAIL : [E] Taking a picture for e-mail
(512 X 384 / Normal)

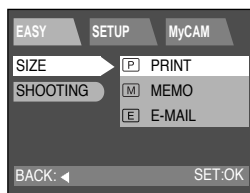

● PROGRAM, PORTRAIT, NIGHT SCENE, A/S/M, MySET 1/ 2/ 3 mode

Select the desired sub menu by pressing the UP/DOWN button.

- [L] 2048x1536 (LARGE)
- [P] 2048x1360 (PHOTO)
- [M] 1024x768 (MEDIUM)
- [S] 512x384 (SMALL)

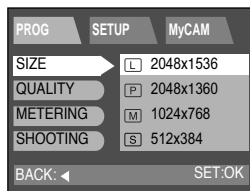

5. Press the OK button to confirm the setting.

Press the menu button twice and the menu display will be disappeared. Take a picture.



INFORMATION

- ▶ A large image uses more memory, so increasing the image size will reduce the total number of shots you can store in the memory.
- ▶ Even though the camera is restarted, the image size setting is maintained.

- In RECORDING mode, you can select the image quality (Data compression rate).

1. Rotate the mode dial to the RECORDING mode and press the MENU button.
2. Press the DOWN and the cursor will be shifted to the main menu.
3. Select [QUALITY] menu by pressing the UP/DOWN button.
4. Press the RIGHT button and the cursor will shift to the [QUALITY] sub menu.
5. Select the desired sub menu by pressing the UP/DOWN button.

- TIFF : TIFF - FINE :
- SUPER FINE : - NORMAL :

6. Press the OK button to confirm the setting.
Press the menu button twice and the menu display will disappear. Take a picture.

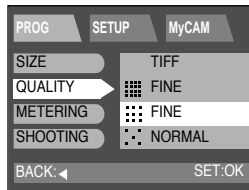

INFORMATION

- ▶ The higher the QUALITY setting, the better the final image will be. However, the high quality setting will require more memory and therefore reduce the number of images you can store on the memory.
- ▶ SUPER FINE is the highest quality and NORMAL is the lowest setting. Choose the setting appropriate for your needs.
- ▶ The image file is stored in *.jpg (Default). But, if you select TIFF in the quality menu, the image file is stored in *.tif.
- ▶ TIFF format is an uncompressed image file format for an expert. If you take a picture with the TIFF file format, the number of available shots is decreased and the time for recording the image file will be longer because the TIFF file size is bigger than the JPG file format.
- ▶ When the TIFF file is being recorded to the memory card, a [PLEASE WAIT!] message will be displayed on the LCD monitor.
- ▶ This file format complies with DCF(Design rule for Camera File system).
- ▶ Even if the camera should be restarted, the quality setting is maintained.
But, if you select TIFF quality, the quality setting will be changed to FINE after restarting the camera.
- ▶ When using the 32MB SD memory card, the specified shooting capacity will be as follows. (These figures are intended as an indication of expected performance)

QUALITY \ IMAGE SIZE		L	P	M	S
TIFF (1:1)		3	3	13	54
Super fine (4:1)		16	19	67	271
Fine (8:1)		33	38	135	542
Normal (12:1)		67	76	271	1085

- In this mode you can select the shutter speed or aperture value to your preference.

1. Rotate the mode dial to the A/ S/ M mode and press the MENU button.
2. Press the DOWN button and the cursor will be shifted to the main menu.
3. Select [A/S/M] menu by pressing the UP/DOWN button.
4. Press the RIGHT button and the cursor will shift to the [A/S/M] sub menu.
5. Select the desired sub menu by pressing the UP/DOWN button.



- Aperture priority (A) :

You can select the aperture value in this mode.

The camera calculates the best shutter speed automatically to the proper exposure value.

- Shutter priority (S) :

You can select the shutter speed in this mode.

The camera calculates the best aperture value automatically to the proper exposure value.

- Manual (M) :

You can select the shutter speed and the aperture value in this mode.

6. Press the OK button to confirm the setting.

Press the menu button twice and the menu display will disappear. Take a picture.

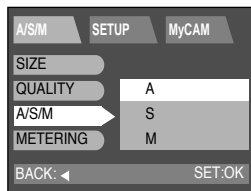

INFORMATION

- ▶ After pressing the shutter button half way down, the values that were changed in the A/S/M mode will be applied to the picture.
- ▶ If the aperture value or shutter speed is out of the limit of application, the value that is displayed on the LCD monitor will show as red. However, you will still be able to take a picture.

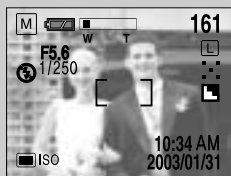

It warns that : To be the properly exposed, the aperture value should be smaller than F 2.8. The minimum aperture value that you can select is F 2.8.

● Aperture priority mode (A)

- The small aperture value is used for portraits to separate the subject from the background.
The large aperture value is used for landscape photographs to keep the foreground and background in focus.
- While pressing the +/- button, select the desired aperture value by pressing the UP/ DOWN button.
- To change the exposure value, press the LEFT/ RIGHT button by pressing the +/- button.
- Point the camera towards the subject and compose the image and take a picture.

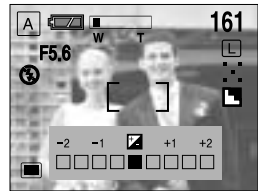

● Shutter priority mode (S)

- Fast shutter speeds are used in sport photography to capture action shots. Slow shutter speeds can be used to show the flow of motion such as water cascading over a waterfall.
- While pressing the +/- button, select the desired shutter speed by pressing the UP/ DOWN button.
- To change the exposure value, press the LEFT/ RIGHT button by pressing the +/- button.
- Point the camera towards the subject and compose the image and take a picture.

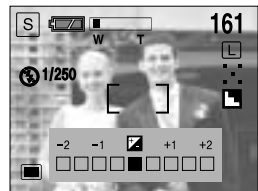

● Manual mode (M)

- You can select the shutter speed and the aperture value in this mode.
- While pressing the +/- button, select the desired shutter speed by pressing the UP/ DOWN button.
- While pressing the +/- button, select the desired aperture value by pressing the LEFT/ RIGHT button.
- Point the camera towards the subject and compose the image and take a picture.

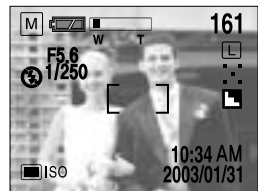

Metering



- When the camera cannot calculate a desired exposure, you can change the metering method.

1. Rotate the mode dial to the RECORDING mode and press the MENU button.
2. Press the DOWN button and the cursor will be shifted to the main menu.
3. Select the [METERING] menu by pressing the UP/DOWN button.
4. Press the RIGHT button and the cursor will shift to the [METERING] sub menu.
5. Select the desired sub menu by pressing the UP/DOWN button.

- Multi pattern metering :

Exposure will be calculated based on an average of the available light in the image area. However, the calculation will be biased towards the centre of the image area.

- Spot metering :

Use this function when there is backlight or when photographing a subject that has little contrast. In backlighting conditions adjust the light metering to suit the subject matter.

6. Press the OK button to confirm the setting.
Press the menu button twice and the menu display will disappear. Take a picture.

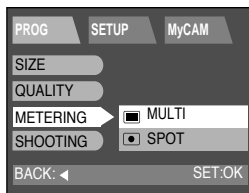

RECORDING



INFORMATION



- ▶ The default metering mode is Multi pattern metering.
- ▶ If the subject is not the centre of the focus, do not use the spot metering as there may be an exposure error. In this case, use exposure compensation.
- ▶ Even if the camera is restarted, the metering setting is maintained.

Shooting



- You can select the continuous shooting or AEB shooting in this menu.
 - AEB is not available in the A/S/M mode.
1. Rotate the mode dial to the RECORDING mode and press the MENU button.
 2. Press the DOWN button and the cursor will be shifted to the main menu.
 3. Select the [SHOOTING] menu by pressing the UP/DOWN button.
 4. Press the RIGHT button and the cursor will shift to the [SHOOTING] sub menu.
 5. Select the desired sub menu by pressing the UP/DOWN button.



- SINGLE : you can take only one picture at a time.
- CONTINUOUS :  In this mode, you can capture moving subjects continuously.
- AEB (Auto Exposure Bracket) :  In this mode, you can take a 3-image bracket of a scene.

There is an over exposed image, normally exposed image and under exposed image in a bracket.

When you select continuous shot or AEB, you can select the exposure bracket and the number of continuous shots in [SHOOTING] sub menu.

6. Press the OK button to confirm the setting.
Press the menu button twice and the menu display will disappear. Take a picture.



INFORMATION

- ▶ The flash mode is set to “flash off” in continuous shooting and AEB shooting. After completing the continuous or AEB shot, the shooting mode is changed to [SINGLE] automatically.
- ▶ Once a continuous sequence has begun, it will continue until the selected number of shots has been taken. Releasing the shutter button will not interrupt this function.
- ▶ The maximum number of shots in a sequence is governed by the image settings.
- ▶ Using a 32MB SD memory card, the specified shooting capacity will be as follows.
(These figures are intended as an indication of expected performance)

Quality \ Size	Large	Photo	Medium	Small
TIFF (1:1)	N/A	N/A	N/A	N/A
Super fine (4:1)	4	4	16	66
Fine (8:1)	8	9	32	99
Normal (12:1)	16	18	66	99

- ▶ If you change the image size or quality after selecting the continuous shot or AEB shot, the shooting mode will be turned to single shot mode automatically.



INFORMATION

- ▶ Continuous and AEB shots cannot be selected in the TIFF image quality format.
- ▶ To take the continuous shot, the number of available shots must be more than 2 because the minimum number of the continuous shots are 2. To take the AEB shots, the number of available shots must be more than 3 because of the same reason.
- ▶ Camera shake can be a problem when using the AEB shooting mode and it takes time to store the AEB image to the memory. We recommend using a tripod.

ISO



- You can select the camera's sensitivity to light by selecting the ISO sub menu. The speed or specific light-sensitivity of a camera is rated by ISO numbers.

1. Rotate the mode dial to the RECORDING mode and press the MENU button.
2. Press the DOWN button and the cursor will be shifted to the main menu.
3. Select the [SHOOTING] menu by pressing the UP/DOWN button.
4. Press the DOWN button on the [SHOOTING] menu and the next menu page will be displayed.
5. Select the [ISO] menu by pressing the UP/DOWN button.

6. Press the RIGHT button and the cursor will shift to the [ISO] sub menu.
7. Select the desired sub menu by pressing the UP/DOWN button.

- AUTO : The camera's sensitivity is automatically changed by variables such as lighting value or subject brightness.

- 100/ 200/ 400 : In the same lighting conditions, the higher the ISO value is, the faster the shutter speed will be. However, the images can be saturated in very bright conditions.

8. Press the OK button to confirm the setting.
Press the menu button twice and the menu display will disappear. Take a picture.

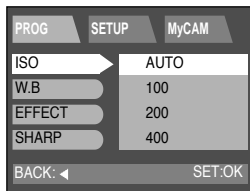

INFORMATION

- ▶ The higher the number, the more sensitive it is to light. As with film, the higher speeds usually induce more electronic noise so the image gets grainier.
- ▶ Even if the camera is restarted, the the ISO setting will be maintained.
- ▶ [AUTO] is not applied to A/S/M mode.

White Balance



- The white balance control allows you to adjust the colors to appear more natural looking.

1. Rotate the mode dial to the RECORDING mode and press the MENU button.
2. Press the DOWN button and the cursor will be shifted to the main menu.
3. Select the [SHOOTING] menu by pressing the UP/DOWN button.
4. Press the DOWN button on the [SHOOTING] menu and the next menu page will be displayed.
5. Select the [W.B] menu by pressing the UP/DOWN button.
6. Press the RIGHT button and the cursor will shift to the [W.B] sub menu.
7. Select the desired sub menu by pressing the UP/DOWN button.



- AUTO : The camera automatically selects the appropriate white balance settings, depending on the prevailing lighting conditions.
- DAYLIGHT : ☀ For taking images outside.
- CLOUDY : ☁ For taking images under a cloudy and overcast sky.
- FLUOR. : ⚡ For shooting under fluorescent lighting.
- TUNGSTEN : ⚡ For shooting under tungsten (standard light bulb) lighting.

8. Press the OK button to confirm the setting.

Press the menu button twice and the menu display will disappear. Take a picture.

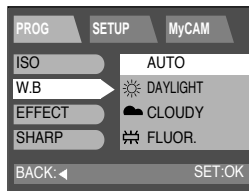

INFORMATION

- ▶ Different lighting conditions may cause a color cast on your images.
- ▶ Even if the camera is restarted, the white balance setting will be maintained.

Effect



- Using the camera's digital processor, it is possible to add special effects to your images.

1. Rotate the mode dial to the RECORDING mode and press the MENU button.
2. Press the DOWN button and the cursor will be shifted to the main menu.
3. Select the [SHOOTING] menu by pressing the UP/DOWN button.
4. Press the DOWN button on the [SHOOTING] menu and the next menu page will be displayed.
5. Select the [EFFECT] menu by pressing the UP/DOWN button.
6. Press the RIGHT button and the cursor will shift to the [EFFECT] sub menu.
7. Select the desired sub menu by pressing the UP/DOWN button.
 - NORMAL : No effect is added to the image.
 - B & W : Converts the image to black and white.
 - sRGB : sRGB is a device independent standard color model. Devices supporting sRGB can display the exact image color.
 - SUNSET : Used for capturing images at sunset
8. Press the OK button to confirm the setting.
Press the menu button twice and the menu display will disappear.
Take a picture.

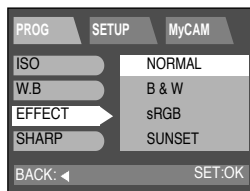
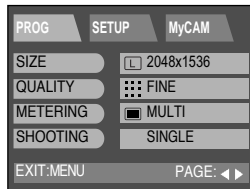

RECORDING



INFORMATION



- ▶ Even if the camera is restarted, the effect setting will be maintained.

Sharpness



- You can select the sharpness of still image.

1. Rotate the mode dial to the RECORDING mode and press the MENU button.
2. Press the DOWN button and the cursor will be shifted to the main menu.
3. Select the [SHOOTING] menu by pressing the UP/DOWN button.
4. Press the DOWN button on the [SHOOTING] menu and the next menu page will be displayed.
5. Select the [SHARP] menu by pressing the UP/DOWN button.
6. Press the RIGHT button and the cursor will shift to the [SHARP] sub menu.
7. Select the desired sub menu by pressing the UP/DOWN button.

- SOFT :  This gives smooth edges and the final image will have a soft appearance.
- NORMAL :  This setting will give a standard finish to the final image.
- VIVID :  This will give the image a crisp and clear appearance.

8. Press the OK button to confirm the setting.
Press the menu button twice and the menu display will disappear.
Take a picture.

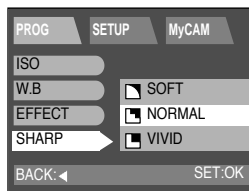

INFORMATION

- ▶ Even though the camera is restarted, the sharpness setting is maintained.

My SET mode menu

My1 My2 My3

- You can select your favorite settings and save them in this menu

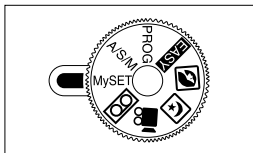

Main menu	Sub menu
MODE	MYSET1
	MYSET2
	MYSET3
CHANGE	NO
	YES

Mode

My1 My2 My3

- You can select your favorite settings that have been saved in this menu.

1. Rotate the mode dial to the MySET mode and press the MENU button.
2. Press the DOWN button and the cursor will be shifted to the main menu.
3. Select the [MODE] menu by pressing the UP/DOWN button.
4. Press the RIGHT button and the cursor will shift to the [MODE] sub menu.
5. Select the desired sub menu by pressing the UP/DOWN button.
6. Press the OK button to confirm the setting.

Press the menu button twice and the menu display will disappear. Take a picture

To apply this function to the camera, change the MySET mode menu or press the DOWN button and select the CHANGE menu.

Refer to the CHANGE menu.

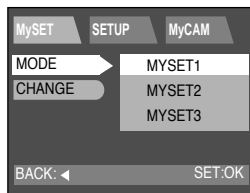
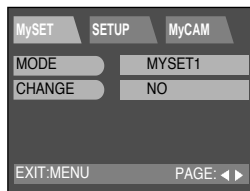

RECORDING

Change

- The loaded My SET setting will be applied to the camera from this menu.

1. Rotate the mode dial to the MySET mode and press the MENU button.
2. Press the DOWN button and the cursor will be shifted to the main menu.
3. Select the [CHANGE] menu by pressing the UP/DOWN button.
4. Press the RIGHT button and the cursor will shift to the [CHANGE] sub menu.
5. Select the desired sub menu by pressing the UP/DOWN button.
 - Selecting [NO] : The My SET menu will not be changed.
 - Selecting [YES] : You can change your favorite menus.
Refer to page 49 ~ 58 for information about the menus.
6. Press the OK button to confirm the setting.
Press the menu button twice and the menu display will disappear.
Take a picture

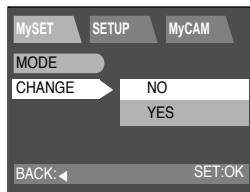
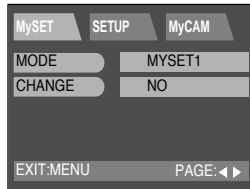

INFORMATION

- ▶ P/A/S/M in the main menu stands for Program mode(P), Aperture priority(A), Shutter priority(S) and Manual mode(M). You can save one of the camera modes in the My SET mode.

Play mode



PLAY

Starting the play mode

- Turn the camera on and select the Play mode by pressing the play mode button ().
The camera can now play back the images stored in a memory.
- You can set up the PLAY mode function by using the camera buttons and LCD monitor.

■ Playing back a still image

1. Select the PLAY mode by pressing the play mode button.



2. The last image stored on the memory is displayed on the LCD monitor.



3. Select an image that you want to play back by pressing the LEFT / RIGHT button.

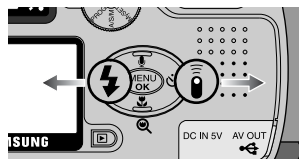



INFORMATION

- ▶ Even if the camera's power is off, you can start the play mode by pressing the play mode button.
- ▶ The LCD monitor will remain in operation until the camera is switched off in PLAY mode.
- ▶ To turn off the camera power, slide the power switch.
- ▶ The menu will not display on the LCD monitor under the following circumstances:
 - When another button is being pressed.
 - While image data is being processed
 - When there is no battery capacity.

Starting the play mode

■ Playing back a movie clip



Steps from 1-2 are the same as those to play back a still image.

3. Select the recorded movie clip that you want to play back by using the LEFT/RIGHT button. If you select a movie clip, the movie clip indicator () will be displayed on the LCD monitor.
4. Press the play & pause button () to play back a movie clip file.
 - To pause while playing back a movie clip file, press the play & pause button again.
 - Press the play & pause button and the movie clip file will restart.
 - To stop play back, press the LEFT/RIGHT button.



■ Playing back a recorded voice

Steps from 1-2 are the same as those to play back a still image.

3. Select the recorded voice that you want to play back by using the LEFT/RIGHT button. If you select a recorded voice file, the voice indicator () will be displayed on the LCD monitor.
4. Press the play & pause button () to play back a recorded voice.
 - To pause playing back a recorded voice, press the play & pause button again.
 - Press the play & pause button and the recorded voice will restart.
 - To stop play back, press the LEFT/RIGHT button.

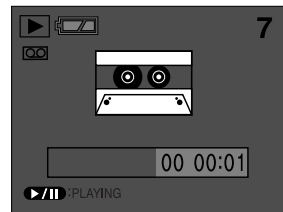

PLAY

LCD monitor indicator

The LCD monitor displays information about the shooting conditions.

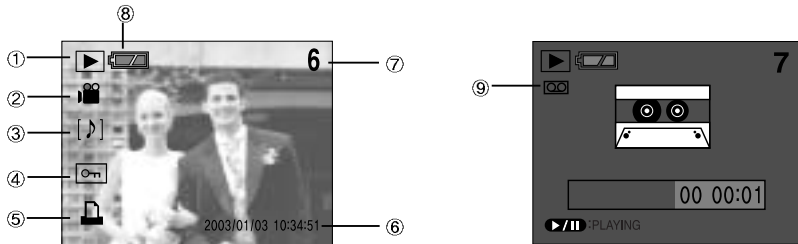

No.	Description	Icons	Page
1	Play mode		
2	Movie clip		
3	Voice memo		p.67
4	Protect indicator		p.73
5	DPOF indicator		p.76~78
6	Recording date	2003:01:31	
7	Stored image number	6	
8	Battery		
9	Voice recording		p.30

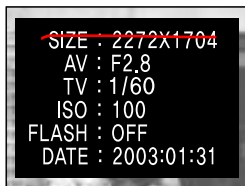

SIZE 2048X1536 : image size
 AV F2.8 : aperture value
 TV 1/60 : shutter speed
 ISO 100 : ISO sensitivity
 FLASH OFF : Whether using the flash or not
 DATE 2003:01:31 : recording date

Information button



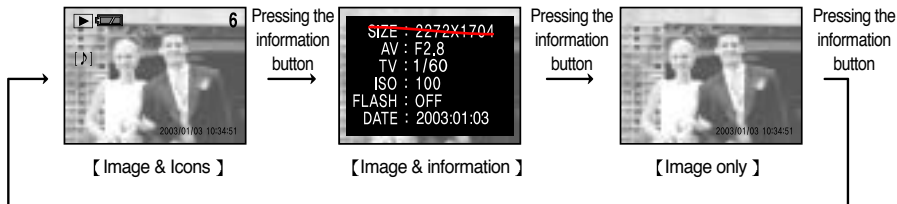

- The shooting information will be displayed on the LCD monitor.
The last image stored in the memory is displayed on the LCD monitor.
Pressing the LCD button in the PLAY mode will change the display as shown below.



Thumbnail & Wide / Tele & Trimming button



- You can view up to 9 images at a time and trim an image.
- The last image stored on the memory is displayed on the LCD monitor.
Press the 5 function button and you can play back another image.

- Thumbnail button ()
 - Press the thumbnail button.
 - The thumbnail display will highlight the image that had been showing at the time the thumbnail mode was selected.
 - Press the 5 function button to move to a desired image.
 - To view an image separately, press the enlargement button ().

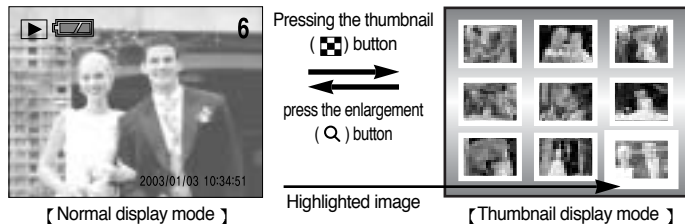

Thumbnail / Enlargement / Trimming button



● Image enlargement

- Select an image that you want to enlarge and press the enlargement button.
- Different parts of the image can be viewed by pressing the 5 function button.
- Pressing the thumbnail button will zoom back to the original full sized image.
- The location indicator is in the bottom left side of the LCD monitor.



● Trimming : You can extract part of the image that you want and save it separately.

- Select a section that you want to trim by pressing the 5 function button. Press the OK button and a message will be displayed as shown alongside.
- Select [YES] or [NO] by pressing the LEFT/ RIGHT button and press the OK button.
Selecting [YES] : a trimmed image that has the latest file name will be displayed on the LCD monitor.
Selecting [NO] : an initial image will be displayed.



INFORMATION

- ▶ The maximum enlargement rate in proportion to the image size.

Image size	Large (Photo)	Middle	Small
Maximum enlargement rate	X8.3	X4.3	X2.1

- ▶ If an image is enlarged, the enlargement indicator will be displayed in the bottom left of the LCD monitor.
- ▶ Movie clip, TIFF and WAV files can't be enlarged.
- ▶ You may notice a decrease in image quality when you enlarge them.
- ▶ The image size of the trimmed image cannot be defined as it extracts only the part of the image displayed on the LCD monitor.
- ▶ If there is little memory space to save the trimmed image, the image can't be trimmed.

UP / Voice memo button



- When the menu is displayed on the LCD monitor, pressing the UP button makes the menu cursor move up or change the sub menu value.
- When the menu is not displayed on the LCD monitor, the UP button operates as the voice memo button. You can add your audio to a stored still image.

1. Press the play mode button.
2. Press the 5 function button to select an image that you wish to add sound to.
3. Press the voice memo button () and the voice memo indicator will display. The camera is now ready to record audio.

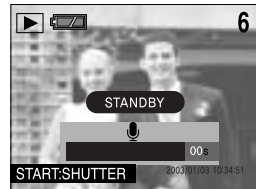

4. Press the shutter button to start recording.
The [RECORDING] message will be displayed on the LCD monitor (as shown) and audio is recorded to the still image for 10 seconds.
5. Recording can be stopped by pressing the shutter button again.



6. [] icon will be displayed on the LCD monitor after finishing the voice memo.



PLAY



INFORMATION

- ▶ Audio can't be recorded onto a movie clip file.
- ▶ When you press the shutter button to stop the audio recording, press the shutter button halfway and the buzzer sound will not be recorded.
- ▶ A distance of 40cm between you and the camera (microphone) is the best distance to record sound.

DOWN / LEFT / RIGHT button



■ DOWN / LEFT / RIGHT buttons activate the following.

● DOWN button

When the menu is displayed on the LCD monitor, pressing the DOWN button makes the menu cursor move down or change the sub menu value.

● LEFT button

When the menu is displayed on the LCD monitor, pressing the LEFT button makes the cursor shift to the main menu.

● RIGHT button

When the menu is displayed on the LCD monitor, pressing the RIGHT button makes the cursor shift to the sub menu.

MENU / OK button



● MENU button

When you press the MENU button, the play mode menu will be displayed on the LCD monitor. Pressing it again will return the LCD to the initial display.

● OK button

When the menu is displayed on the LCD monitor, the OK button is used for confirming data that is changed by using the 5 function button.



INFORMATION

- ▶ The menu will not be displayed on the LCD monitor in the following circumstances:
 - When another button is being operated.
 - While image data is being processed. (when the green LED next to the viewfinder blinks)
 - When there is no battery capacity.

DELETE () button



- This deletes an image stored on the memory card.
 1. Press the play mode button.
 2. Press the LEFT/ RIGHT button to select the image that you want to delete, and press the delete () button.
 3. A message as shown alongside will be displayed on the LCD monitor.

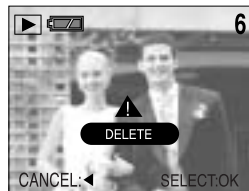

4. To cancel the deletion, press the LEFT button.
Press the OK button and a message as shown alongside will be displayed on the LCD monitor.
Select [DELETE] or [CANCEL] by pressing the UP/DOWN button and press the OK button.

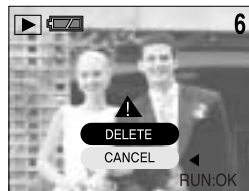

- Selecting [DELETE] : Once an image has been deleted, the previous image in the sequence will appear on the LCD monitor.
- Selecting [CANCEL] : The image will be displayed on the LCD monitor.



NOTICE

- ▶ Before deleting an image from the camera, you should download (p.100) the image to your computer or protect (p.73) the image, if you want to keep it.

PLAY & PAUSE () button



- When the menu is not displayed on the LCD monitor, press the PLAY & PAUSE button to play and pause the movie clip, or a still image that has a voice memo or audio recording file.

1. Press the play mode button.
2. Press the LEFT/ RIGHT button to select an image that has voice memo, movie clip or audio recording file.



3. Pressing the PLAY & PAUSE button activates the following.
 - If an image is showing, but there is no sound (or movement) : Plays the sound clip or starts the movie clip.
 - If the image is playing : The progress is paused.
 - If the PLAY & PAUSE button is pressed when the image is paused, the sound or movement will resume.



[Initial play mode]



[Playing]



[Pause]

To select another image, pause the progress and press the LEFT/RIGHT button.



INFORMATION

- ▶ The selected image plays back as a single image display.
- ▶ When the image is playing, the play & pause button, power switch and mode dial can be activated.
- ▶ When the image is paused, the left/ right button, power switch and mode dial can be activated.

Setting up the play back function using the LCD monitor

- PLAY mode functions can be changed by using the LCD monitor.
- In the PLAY mode, pressing the MENU button displays the menu on the LCD monitor.

Main menu	Sub menu	Secondary menu
SLIDE SHOW (Default : OFF)	▲ OFF, 01 ~ 10 SEC. ▼	
	REPEAT	ON
		OFF
PROTECT	ONE PICTURE	UNLOCK
		LOCK
	ALL PICTURES	UNLOCK
		LOCK
RESIZE	1024 x 768	
	640 x 480	
	320 x 240	
	LOGO	
DELETE ALL	NO	
	YES	
STANDARD	ONE PICTURE	▲ 00 ~ 30 PRINTS ▼
	ALL PICTURES	▲ 00 ~ 30 PRINTS ▼
INDEX PRINT	NO	
	YES	
CANCEL	STANDARD	
	INDEX	

PLAY

Slide show



- Images can be displayed continuously at pre-set intervals.
- You can view the slide show by connecting the camera to an external monitor.

1. Press the play mode button and press the menu button.
2. Press the DOWN button and the cursor will be shifted to the main menu.
3. Select the [SLIDE SHOW] menu by pressing the UP/DOWN button.
4. Press the RIGHT button and the cursor will shift to the [SLIDE SHOW] sub menu.
5. Select the desired sub menu by pressing the UP/DOWN button.
 - If you select [01 ~ 10SEC], you can select the [REPEAT] secondary menu.

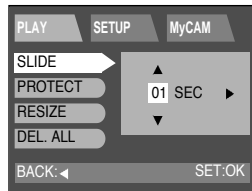

6. Select the desired menu by pressing the UP/DOWN button.
 - [OFF] : If a cycle is completed, the slide show will stop automatically.
 - [ON] : Even once a cycle(from the first image to the last image) is completed, the slide show will continue to repeat itself.

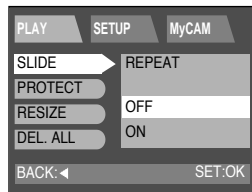

7. Press the OK button to confirm the setting. Press the menu button twice and the slide show will start.
8. To pause the slide show, press the play & pause button. To start the slide show again, press the play & pause button again. Press the menu button twice again and the slide show will stop.



INFORMATION

- ▶ The default is OFF and the loading time depends on the image size and quality.
- ▶ The slide show will start from an image that was displayed on the LCD monitor. The [POWER OFF] function can't be activated. While the slide show is playing, only the first frame of an AVI file is displayed.
- ▶ If there is only an image in the memory card, the slide show will not start.

Protect



- This is used to protect specific shots from being accidentally erased (LOCK). It also releases images that have been previously protected (UNLOCK).

1. Press the play mode button and press the menu button.
2. Press the DOWN button and the cursor will be shifted to the main menu.
3. Select the [PROTECT] menu by pressing the UP/DOWN button.
4. Press the RIGHT button and the cursor will shift to the [PROTECT] sub menu.
5. Select the desired sub menu by pressing the UP/DOWN button.
 - [ONE PIC.] : Only an image that is displayed on the LCD monitor is protected or unprotected.
 - [ALL PICS.] : All of the stored images are protected or unprotected.
6. Select [LOCK] or [UNLOCK] by pressing the UP/ DOWN button and press the OK button.
 - [UNLOCK] : Discards the protect function.
 - [LOCK] : Sets up the PROTECT function.If you need to protect another image, press the LEFT/ RIGHT button.(In case of selecting [ONE PIC])
7. Press the shutter button and the menu will disappear. If you protect an image, the protect icon will be displayed on the LCD monitor. (An unprotected image has no indicator)

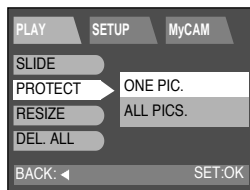
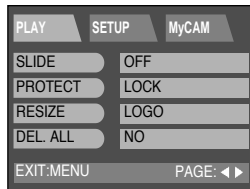

NOTICE

- ▶ An image in LOCK mode will be protected from [DELETE] or [DELETE ALL] functions, but will NOT be protected from the [FORMAT] function.

Resize



- The stored image size can be changed and used as logo image.
The resized image will have a new file name.

1. Press the play mode button and select an image that you want to resize by pressing the LEFT/ RIGHT button.
2. Press the menu button.
3. Press the DOWN button and the cursor will be shifted to the main menu.
4. Select the [RESIZE] menu by pressing the UP/DOWN button.
5. Press the RIGHT button and the cursor will shift to the [RESIZE] sub menu.
6. Select the desired sub menu by pressing the UP/DOWN button.
7. Press the OK button to confirm the setting.

Press the menu button twice and the menu display will disappear.

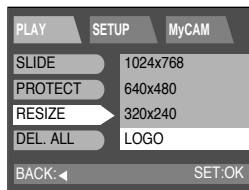
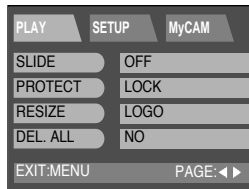

NOTICE

- ▶ Large sized images can be resized to be made smaller, but you may notice decreasing image quality when a small size image is resized to become larger.
- ▶ If you try to resize a Photo or Print size image, a [N/A] (Not available) sub menu will be displayed on the menu display.
- ▶ Only JPG images can be resized. TIFF, WAV files can't be resized.
- ▶ The different compression format image, however the image(.JPG file) size is in the ratio of four to three(2048X1536, 1024X768, 512X384..etc), can't be resized.
Only 4:2:2 compression format file can be resized.
- ▶ The resized image will have a new file name.
- ▶ If the memory capacity is insufficient to store the resized image, [N/A] message will display on the LCD monitor and the resized image will not be stored.
- ▶ The start-up image is stored not on the memory card but on the internal memory.

Delete all



- This enables you to clear all unprotected images from the memory.

1. Press the play mode button and press the menu button.
2. Press the DOWN button and the cursor will be shifted to the main menu.
3. Select the [DEL. ALL] menu by pressing the UP/DOWN button.
4. Press the RIGHT button and the cursor will shift to the [DEL. ALL] sub menu.
5. Select the desired sub menu by pressing the UP/DOWN button and press the OK button.
 - Selecting [NO] : The display returns to the initial menu.
 - Selecting [YES] : A [PLEASE WAIT!] message will display and all the unprotected images are deleted. If there aren't protected images, all the images are deleted and a [NO IMAGE!] message will display.
6. If you select [NO], press the menu button twice and the menu display will disappear.
If a [NO IMAGE!] message is displayed on the LCD monitor after selecting [YES], press the play mode button or rotate the mode dial. The message will disappear.



NOTICE

- ▶ Remember that this will permanently delete unprotected images. Important shots should be stored on a computer before deletion takes place.

DPOF : Standard

- DPOF(Digital Print Order Format) allows you to embed printing information on your memory card. Select the pictures to be printed and how many prints to make.(Print quantity : 0 ~ 30)
- The DPOF indicator will display on the LCD monitor when an image that has DPOF information plays back. Images can then be printed on DPOF printers, or at an increasing number of photo laboratories.
- This function is not available for Movie clips and WAV files.

- This function allows you to embed print quantity information on a stored image.

1. Press the play mode button and select an image that you want to embed a print quantity by pressing the LEFT/ RIGHT button.
2. Press the menu button.
3. Press the DOWN button and the cursor will be shifted to the main menu.
4. Select the [DEL. ALL] menu by pressing the UP/DOWN button.
5. Press the DOWN button on the [DEL. ALL] menu and the next menu page will be displayed.
6. Select [STANDARD] menu by pressing the UP/DOWN button.
7. Press the RIGHT button and the cursor will shift to the [STANDARD] sub menu.
8. Select the desired sub menu by pressing the UP/DOWN button.
 - [ONE PIC.] : Specifies the number of copies for a selected image. If you need to embed a print quantity on another image, press the LEFT/ RIGHT button.
 - [ALL PICS.] : Specifies the number of copies for all images except for movie clips and voice recording files.
9. Press the OK button and a display to select the quantity will display on the LCD monitor.
10. Select the print quantity by pressing the UP/DOWN button.
11. Press the OK button to confirm the setting.
12. If an image carries DPOF instructions, the DPOF indicator () will show.

Press the shutter button and the camera working mode is turned to the play mode.

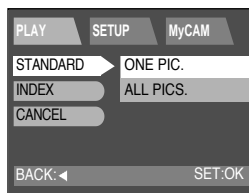



- This function will specify the number of copies (except for movie clips and sound clip) for index prints.

1. Press the play mode button and press the menu button.
2. Press the DOWN button and the cursor will be shifted to the main menu.
3. Select the [DEL. ALL] menu by pressing the UP/DOWN button.
4. Press the DOWN button on the [DEL. ALL] menu and the next menu page will be displayed.
5. Select [INDEX] menu by pressing the UP/DOWN button.
6. Press the RIGHT button and the cursor will shift to the [INDEX] sub menu.
7. Select the desired sub menu by pressing the UP/DOWN button.
8. Press the OK button to confirm the setting.
Press the menu button twice and the menu display will disappear.

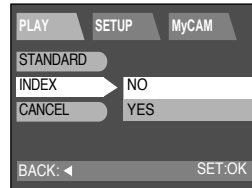

INFORMATION

- ▶ The number of copy is 1.
- ▶ There is no indicator for the index print.
- ▶ If the index print was set, the [INDEX] sub menu will be displayed as [YES] on the LCD monitor.
- ▶ The first printed image is the first stored image.

DPOF : Cancel



■ This is used for canceling the STANDARD or INDEX DPOF function.

1. Press the play mode button and press the menu button.
2. Press the DOWN button and the cursor will be shifted to the main menu.
3. Select the [DEL. ALL] menu by pressing the UP/DOWN button.
4. Press the DOWN button on the [DEL. ALL] menu and the next menu page will be displayed.
5. Select [CANCEL] menu by pressing the UP/DOWN button.
6. Press the RIGHT button and the cursor will shift to the [CANCEL] sub menu.
7. Select the desired sub menu by pressing the UP/DOWN button.
 - [STANDARD] : Pre-set print quantity is canceled.
 - [INDEX] : Index print is canceled.
8. Press the menu button twice and the menu display will disappear.

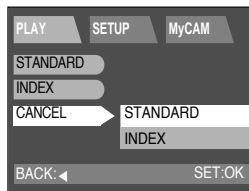

Setup menu

- In this mode, you can set up basic settings.

Every camera working mode has [SETUP] tab in their own menu.

Main menu	Sub menu	Secondary menu
FILE	RESET	
	SERIES	
POWER OFF (Default : 3 MIN)	OFF / 1~10MIN	
LANGUAGE	ENGLISH	FRENCH
	KOREAN	ITALIAN
	CHINESE 1	DUTCH
	CHINESE 2	DANISH
	JAPANESE	FINNISH
	RUSSIAN	SWEDISH
	GERMANY	PORTUGUESE
	SPANISH	
FORMAT	NO	
	YES	
DATA SET	2003/01/01	
TIME SET	12:00 AM/PM	
DATE TYPE	'YY/MM/DD	
	MM/DD/YY	
	DD/MM/YY	
IMPRINT	OFF	
	DATE	
	DATE&TIME	
SOUND	ON	
	OFF	
LCD BRIGHTNESS	LOW	
	NORMAL	
	HIGH	
VIDEO OUT	NTSC	
	PAL	
QUICK VIEW	OFF / 1~3SEC.	
	DEL.ANSWER	
		ON

File

■ This enables you to name files

1. Press the menu button and press the RIGHT button to select [SETUP](Second) tab.
2. Press the DOWN button and the cursor will be shifted to the main menu.
3. Select the [FILE] menu by pressing the UP/DOWN button.
4. Press the RIGHT button and the cursor will shift to the [FILE] sub menu.
5. Select the desired sub menu by pressing the UP/DOWN button.
 - [RESET] : Using reset, the next file name will be set from 0001 even after formatting, deleting all or inserting a new memory card.
 - [SERIES] : Under this system, the file name will directly follow the last stored file name, regardless of any actions such as file deletion or formatting.
6. Press the OK button to confirm the setting.
Press the menu button twice and the menu display will disappear.

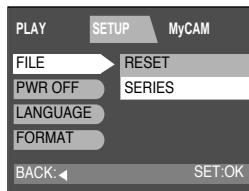
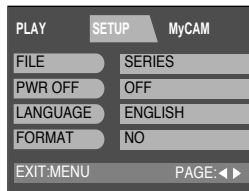

INFORMATION

- ▶ The first stored folder name is 100SSCAM, and first name is SV300001.
- ▶ Whenever you store an image, the file number is increased by 1.
- ▶ The file number is named from SV300001 to SV309999 automatically, 9999 files will be stored in a folder.
- ▶ Using SERIES, the sequence starts at 100SSCAM and increases in increments of 1.(e.g : 101SSCAM, 102SSCAM...)
- ▶ The files used with the memory card conform to the DCF(Design rule for Camera File system) format.

Power off

- This function switches the camera off after a set amount of time in order to prevent unnecessary battery drainage.

1. Press the menu button and press the RIGHT button to select [SETUP](Second) tab.
2. Press the DOWN button and the cursor will be shifted to the main menu.
3. Select the [PWR OFF] menu by pressing the UP/DOWN button.
4. Press the RIGHT button and the cursor will shift to the [PWR OFF] sub menu.
5. Select the desired sub menu by pressing the UP/DOWN button.
 - Selecting [OFF] : The power off function will not operate.
 - Selecting [ON] : A menu will be displayed on the LCD monitor as shown alongside.
6. Select the desired time by pressing the UP/DOWN button.
7. Press the OK button to confirm the setting.

Press the menu button twice and the menu display will disappear.

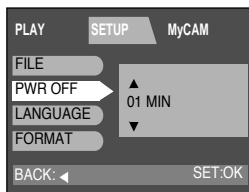
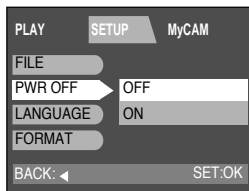
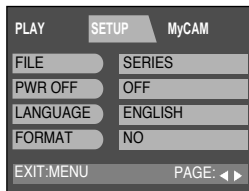

INFORMATION

- ▶ Even if the batteries or AC adapter are removed and inserted again, the power off setting will be preserved.
- ▶ Note that the automatic power off does not operate if the camera is in slide show or PC mode.

Language

- There is a choice of languages that can be displayed on the LCD monitor.

1. Press the menu button and press the RIGHT button to select [SETUP](Second) tab.
2. Press the DOWN button and the cursor will be shifted to the main menu.
3. Select the [LANGUAGE] menu by pressing the UP/DOWN button.
4. Press the RIGHT button and the cursor will shift to the [LANGUAGE] sub menu.
5. Select the desired sub menu by pressing the UP/DOWN button.
6. Press the OK button to confirm the setting.

Press the menu button and the menu display will disappear.

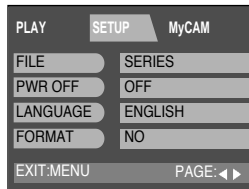

INFORMATION

- ▶ The default language is ENGLISH.
- ▶ You can select 15 languages. Those are listed below.
English, Korean, T. Chinese, S. Chinese, Japanese, Russian, Germany, Spanish, French, Italian, Portuguese, Danish, Swedish, Finnish, Dutch.
- ▶ Even if the camera is restarted, the language setting will be maintained.
- ▶ Even if the [SOUND] function is [ON], the sound will not activate in this menu.

Format

- This is used for formatting the memory card.

1. Press the menu button and press the RIGHT button to select [SETUP](Second) tab.
2. Press the DOWN button and the cursor will be shifted to the main menu.
3. Select the [FORMAT] menu by pressing the UP/DOWN button.
4. Press the RIGHT button and the cursor will shift to the [FORMAT] sub menu.
5. Select the desired sub menu by pressing the UP/DOWN button.
 - Selecting [NO] : The image will be displayed on the LCD monitor. Press the menu button twice and the menu display will disappear.
 - Selecting [YES] : The memory card is formatted. (A [NO IMAGE !] message will be displayed after formatting in play mode)

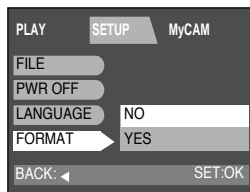
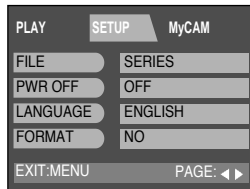

INFORMATION

- ▶ Before using the memory card, it must be initialized.
 - New memory card, unformatted memory card.
 - A memory card that has a file this camera can't recognize or one that has been taken from another camera.



NOTICE

- ▶ All the files in the memory are deleted by the [FORMAT] function. Before formatting the memory, it is advisable to copy important data onto other media as back-up e.g. floppy disks, hard disks, CD etc.
- ▶ Do not use the memory card formatted by another digital camera or memory card reader.

Format



NOTICE

- ▶ When you format the memory card in your PC that runs on Windows 2000 or XP, please select the FAT file system.

■ Formatting on a PC

1. Select [Removable Disk] in the [Windows Explorer].



2. Press the right mouse button and select [Format].



3. Select [FAT] file format type and click the [Start] button.



Date set

- You can change the imprinted date.

1. Press the menu button and press the RIGHT button to select [SETUP](Second) tab.
2. Press the DOWN button and the cursor will be shifted to the main menu.
3. Select the [FORMAT] menu by pressing the UP/DOWN button.
4. Press the DOWN button on the [FORMAT] menu and the next menu page will be displayed.
5. Select the [DATE SET] menu by pressing the UP/DOWN button.
6. Press the RIGHT button and the cursor will shift to the [DATE SET] sub menu.
7. Select the desired sub menu by pressing the UP/DOWN button.
RIGHT button : selects YEAR/ MONTH/ DAY item.
UP/ DOWN button : changes the value of each item.
8. Press the OK button to confirm the setting.
Press the menu button twice and the menu display will disappear.

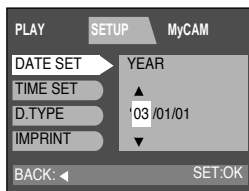
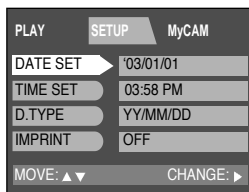
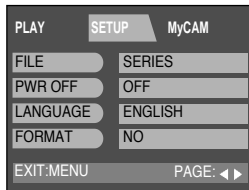

PLAY

Time set

- You can change the imprinted time.

1. Press the menu button and press the RIGHT button to select [SETUP](Second) tab.
2. Press the DOWN button and the cursor will be shifted to the main menu.
3. Select the [FORMAT] menu by pressing the UP/DOWN button.
4. Press the DOWN button on the [FORMAT] menu and the next menu page will be displayed.
5. Select [TIME SET] menu by pressing the UP/DOWN button.
6. Press the RIGHT button and the cursor will shift to the [TIME SET] sub menu.
7. Select the desired sub menu by pressing the UP/DOWN button.
RIGHT button : selects HOUR, MINUTE, AM/PM item.
UP/ DOWN button : changes the value of each item.
8. Press the OK button to confirm the setting.
Press the menu button twice and the menu display will disappear.

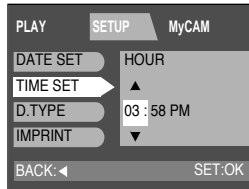
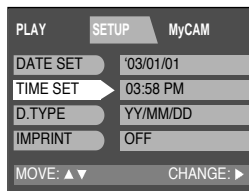
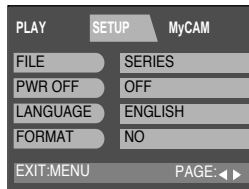

Date type

- You can select date type that is imprinted on the image.

1. Press the menu button and press the RIGHT button to select [SETUP](Second) tab.
2. Press the DOWN button and the cursor will be shifted to the main menu.
3. Select the [FORMAT] menu by pressing the UP/DOWN button.
4. Press the DOWN button on the [FORMAT] menu and the next menu page will be displayed.
5. Select [D.TYPE] menu by pressing the UP/DOWN button.
6. Press the RIGHT button and the cursor will shift to the [D.TYPE] sub menu.
7. Select the desired sub menu by pressing the UP/DOWN button.
 - ‘YY/ MM/ DD: Year/ Month/ Day
 - MM/ DD/ ‘YY: Month/ Day/ Year
 - DD/ MM/ ‘YY: Day/ Month/ Year
8. Press the OK button to confirm the setting.
Press the menu button twice and the menu display will disappear.

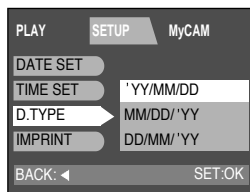
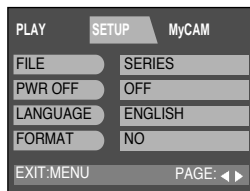

Imprint

- There is an option to include DATE/TIME on still images.

1. Press the menu button and press the RIGHT button to select [SETUP](Second) tab.
2. Press the DOWN button and the cursor will be shifted to the main menu.
3. Select [FORMAT] menu by pressing the UP/DOWN button.
4. Press the DOWN button on the [FORMAT] menu and the next menu page will be displayed.
5. Select the [IMPRINT] menu by pressing the UP/DOWN button.
6. Press the RIGHT button and the cursor will shift to the [IMPRINT] sub menu.
7. Select the desired sub menu by pressing the UP/DOWN button.
 - OFF : DATE & TIME will not be stamped on the image file.
 - DATE : Only DATE will be stamped on the image file.
 - DATE&TIME : DATE & TIME will be stamped on the image file.
8. Press the OK button to confirm the setting.
Press the menu button twice and the menu display will disappear.

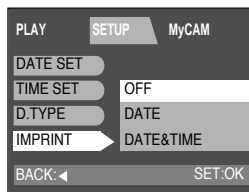
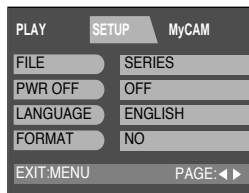

INFORMATION

- ▶ Date & Time are imprinted at the bottom right side of the LCD monitor.
- ▶ Date will be imprinted as DATE TYPE setting.
- ▶ TIME is imprinted in the following way : [Hour / Minute/ Second] and hours are shown using the 12 hour clock.
- ▶ The imprint function is unaffected by the camera being switched on and off.
- ▶ Date & Time is imprinted as you set it in the DATE SET, TIME SET menu.
- ▶ The imprint function is applied only to the still image.

Sound

- A beep will sound when you press the camera button and an error takes place. You can check the camera condition with this function.

1. Press the menu button and press the RIGHT button to select [SETUP](Second) tab.
2. Press the DOWN button and the cursor will be shifted to the main menu.
3. Select the [FORMAT] menu by pressing the UP/DOWN button.
4. Press the DOWN button on the [FORMAT] menu and the next menu page will be displayed.
5. Select the [IMPRINT] menu by pressing the UP/DOWN button.
6. Press the DOWN button on the [IMPRINT] menu and the next menu page will be displayed.
7. Select the [SOUND] menu by pressing the UP/DOWN button.
8. Press the RIGHT button and the cursor will shift to the [SOUND] sub menu.
9. Select the desired sub menu by pressing the UP/DOWN button.
 - [ON] : The sound function is activated.
 - [OFF] : The sound function is not activated.
10. Press the OK button to confirm the setting.

Press the menu button twice and the menu display will disappear.

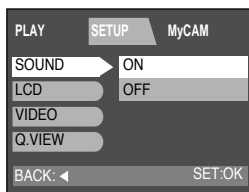
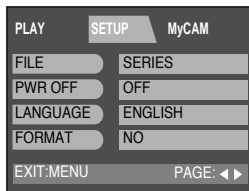

INFORMATION

- ▶ Even though the SOUND function is set to [OFF], you can hear Movie clip, voice memo and sound clip file.

LCD brightness

■ You may adjust the LCD brightness

1. Press the menu button and press the RIGHT button to select [SETUP](Second) tab.
2. Press the DOWN button and the cursor will be shifted to the main menu.
3. Select the [FORMAT] menu by pressing the UP/DOWN button.
4. Press the DOWN button on the [FORMAT] menu and the next menu page will be displayed.
5. Select the [IMPRINT] menu by pressing the UP/DOWN button.
6. Press the DOWN button on the [IMPRINT] menu and the next menu page will be displayed.
7. Select [LCD] menu by pressing the UP/DOWN button.
8. Press the RIGHT button and the cursor will shift to the [LCD] sub menu.
9. Select the desired sub menu by pressing the UP/DOWN button.
There are LOW, NORMAL and HIGH sub menu in the [LCD] menu.
10. Press the OK button to confirm the setting.

Press the menu button twice and the menu display will disappear.

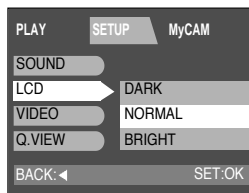
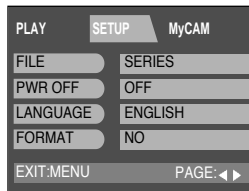

Video

- The Movie output signal from the camera can be NTSC or PAL. Your choice of output will be governed by the type of machine (monitor or TV, etc.) to which the camera is connected.

1. Press the menu button and press the RIGHT button to select [SETUP](Second) tab.
2. Press the DOWN button and the cursor will be shifted to the main menu.
3. Select the [FORMAT] menu by pressing the UP/DOWN button.
4. Press the DOWN button on the [FORMAT] menu and the next menu page will be displayed.
5. Select the [IMPRINT] menu by pressing the UP/DOWN button.
6. Press the DOWN button on the [IMPRINT] menu and the next menu page will be displayed.
7. Select [VIDEO] menu by pressing the UP/DOWN button.
8. Press the RIGHT button and the cursor will shift to the [VIDEO] sub menu.
9. Select the desired sub menu by pressing the UP/DOWN button.
10. Press the OK button to confirm the setting.
Press the menu button twice and the menu display will disappear.

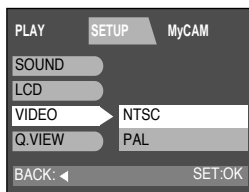
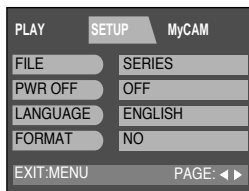

INFORMATION

- ▶ Select the correct movie standard for the outer monitor. PAL mode can support only BDGHI
- ▶ NTSC : U.S.A, Canada, Japan, South Korea, Taiwan, Mexico.
- ▶ PAL : Australia, Austria, Belgium, China, Denmark, Finland, Germany, U.K., Holland, Italy, Kuwait, Malaysia, New Zealand, Singapore, Spain, Sweden, Switzerland, Thailand, Norway.
- ▶ Even if the [SOUND] function is [ON], the sound will not activate in this menu.

Connecting to an external monitor

▶ Connecting to an external monitor

In RECORDING/ PLAY mode, you can view the stored still images or movie clips by connecting the camera to an external monitor via the video cable. When the camera is connected to an external monitor, the LCD monitor will be turned off automatically.

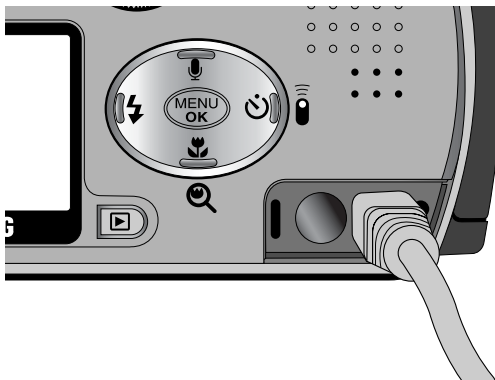

INFORMATION

- ▶ When using a TV as an external monitor, you will need to select the external or AV channel of the TV.
- ▶ There will be a digital noise on the external monitor, but it is not a malfunction.
- ▶ If the image is not in the centre of the screen, use the TV controls to centre it.
- ▶ When the camera is connected to an external monitor, the menu will be visible on the external monitor and the menu functions are the same as those indicated on the LCD monitor.

Quick view

- You can briefly review the last image captured during the pre-set time.

1. Press the menu button and press the RIGHT button to select [SETUP](Second) tab.
2. Press the DOWN and the cursor will be shifted to the main menu.
3. Press the DOWN button until the [Q. VIEW] menu is selected.
4. Press the RIGHT button and the cursor will shift to the [Q.VIEW] sub menu.
5. Select the desired sub menu by pressing the UP/DOWN button.
 - [OFF] : The quick view function can't be activated.
 - [1 ~ 3 SEC] : The captured image is briefly displayed during the selected time.
6. Press the OK button to confirm the setting.

Press the menu button twice and the menu display will be disappeared.

* Setting up the [DEL, ANSWER] function

If you select [1~3SEC] sub menu at the step 5, press the RIGHT button and the [DEL. ANSWER] menu will be displayed.

Select the desired [DEL. ANSWER] sub menu by pressing the UP/DOWN button.

- Selecting [OFF] : A [DEL. ANSWER] message will not display.
- Selecting [ON] : You can delete the captured image at once.

* Using the [DEL.ANSWER] menu

If you select [ON] at the [DEL.ANSWER] menu, a message as shown alongside will be displayed after taking a picture.

- Selecting [YES] : the captured image is deleted.
- Selecting [NO] : the captured image is stored.

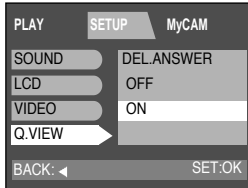
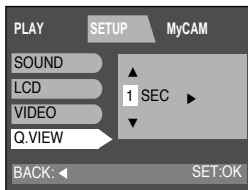
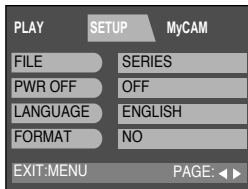

INFORMATION

- ▶ The quick view function doesn't apply to the movie clip and sound clip file.
- ▶ [Q.VIEW] function is not adjusted to the TIFF file type.

MyCAM menu

- You can set up a start up image, start up sound and shutter sound.
- Every camera working mode has the My CAM menu

Start up image

- You can select the image that is first displayed on the LCD monitor whenever the camera is turned on.

1. Press the menu button and press the RIGHT button twice to select [My CAM](Third) tab.
2. Press the DOWN button and the cursor will be shifted to the main menu.
3. Select the [S. IMAGE] menu by pressing the UP/DOWN button.
4. Press the RIGHT button and the cursor will shift to the [S. IMAGE] sub menu.
5. Select the desired sub menu by pressing the UP/DOWN button.
6. Press the OK button to confirm the setting.

Press the menu button twice and the menu display will disappear.

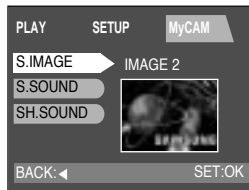
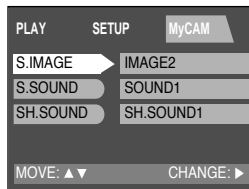

NOTICE

- ▶ Only a image that is save as a LOGO at the [RESIZE] sub menu can be used as the USER IMAGE.
- ▶ If the USER IMAGE was not saved, no image will be displayed on the LCD monitor at the time of camera power on. Refer to p.74 for selecting the USER IMAGE.
- ▶ The USER IMAGE will not be deleted by the [DEL.ALL] or [FORMAT] menu.

Start up sound

- You can select the sound that is activated whenever the camera is turned on.

1. Press the menu button and press the RIGHT button twice to select [MyCAM](Third) tab.
2. Press the DOWN button and the cursor will be shifted to the main menu.
3. Select the [S. SOUND] menu by pressing the UP/DOWN button.
4. Press the RIGHT button and the cursor will shift to the [S. SOUND] sub menu.
5. Select the desired sub menu by pressing the UP/DOWN button.
6. Press the OK button to confirm the setting.
Press the menu button twice and the menu display will disappear.

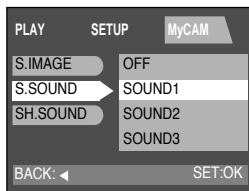
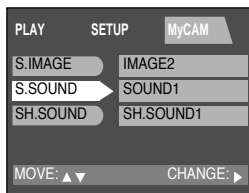

Shutter sound

- You can select the shutter sound.

1. Press the menu button and press the RIGHT button twice to select [MyCAM](Third) tab.
2. Press the DOWN button and the cursor will be shifted to the main menu.
3. Select the [SH. SOUND] menu by pressing the UP/DOWN button.
4. Press the RIGHT button and the cursor will shift to the [SH. SOUND] sub menu.
5. Select the desired sub menu by pressing the UP/DOWN button.
6. Press the OK button to confirm the setting.
Press the menu button twice and the menu display will disappear.

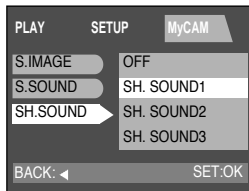
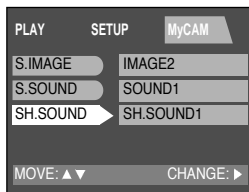

List of camera function

■: Default, ◆: After restarting the camera, ●: Selectable, X: Not Available, -: Not Selectable

Function		MODE DIAL										▶		
		EASY	PROG			A	S	M		MySEF		JPEG	AVI	WAV
SIZE	Print(Photo / Super Fine)	● (■)	-	-	-	-	-	-	-	-	-	-	-	-
	Memo(Middle / Fine)	●	-	-	-	-	-	-	-	-	-	-	-	-
	E-mail (Small / Normal)	●	-	-	-	-	-	-	-	-	-	-	-	-
	Large	X	● (■)	● (■)	● (■)	● (■)	● (■)	● (■)	● (■)	-	● (■)	-	-	-
	Photo	X	●	●	●	●	●	●	●	-	●	-	-	-
	Middle	X	●	●	●	●	●	●	-	●	-	-	-	-
	Small	X	●	●	●	●	●	●	-	●	-	-	-	-
	320 x 240pixels	-	-	-	-	-	-	-	◆ (■)	-	-	-	-	-
QUALITY	Tiff (1:1)	X	●	●	●	●	●	●	-	●	-	-	-	-
	Super Fine(1:4)	X	●	●	●	●	●	●	-	●	-	-	-	-
	Fine (1:8)	X	● (■)	● (■)	● (■)	● (■)	● (■)	● (■)	-	● (■)	-	-	-	-
	Normal (1:12)	X	●	●	●	●	●	●	-	●	-	-	-	-
	1:12	-	-	-	-	-	-	-	-	◆ (■)	-	-	-	-
ZOOM	Optical ZOOM	●	●	●	●	●	●	●	●	●	-	-	-	-
	Digital ZOOM	●	●	●	●	●	●	●	X	●	-	●	X	-
METERING	Multi-Pattern	◆ (■)	◆ (■)	◆ (■)	◆ (■)	◆ (■)	◆ (■)	◆ (■)	◆ (■)	◆ (■)	-	-	-	-
	Spot	X	●	●	X	●	●	●	X	●	-	-	-	-
FOCUS	AF	◆ (■)	◆ (■)	◆ (■)	◆ (■)	◆ (■)	◆ (■)	◆ (■)	◆ (■)	◆ (■)	-	-	-	-
	MF (indicator)	X	●	●	●	●	●	●	●	●	-	-	-	-
SHOOTING	Single	◆ (■)	◆ (■)	◆ (■)	◆ (■)	◆ (■)	◆ (■)	◆ (■)	X	◆ (■)	-	-	-	-
	Continuous	●	●	●	X	●	●	●	X	●	-	-	-	-
	AEB	●	●	●	X	X	X	X	X	●	-	-	-	-
ISO	AUTO	◆ (■)	◆ (■)	◆ (■)	◆ (■)	X	X	X	◆	● (■)	-	-	-	-
	100	X	●	X	X	◆ (■)	◆ (■)	◆ (■)	X	●	-	-	-	-
	200	X	●	X	X	●	●	●	X	●	-	-	-	-
	400	X	●	X	X	●	●	●	X	●	-	-	-	-
W.BALANCE	Auto	◆ (■)	◆ (■)	◆ (■)	◆ (■)	◆ (■)	◆ (■)	◆ (■)	◆ (■)	◆ (■)	-	-	-	-
	Daylight	X	●	X	X	●	●	●	●	●	-	-	-	-
	Cloudy	X	●	X	X	●	●	●	●	●	-	-	-	-
	Fluorescent	X	●	X	X	●	●	●	●	●	-	-	-	-
	Tungsten	X	●	X	X	●	●	●	●	●	-	-	-	-
EFFECT	Normal	◆ (■)	◆ (■)	◆ (■)	◆ (■)	◆ (■)	◆ (■)	◆ (■)	◆ (■)	◆ (■)	-	-	-	-
	B&W	X	●	X	X	●	●	●	●	●	-	-	-	-
	sRGB	X	●	X	X	●	●	●	●	●	-	-	-	-
	Sunset	X	●	X	X	●	●	●	●	●	-	-	-	-
SHARPNESS	Soft	X	●	X	X	●	●	●	●	●	-	-	-	-
	Normal	◆ (■)	◆ (■)	◆ (■)	◆ (■)	◆ (■)	◆ (■)	◆ (■)	◆ (■)	◆ (■)	-	-	-	-
	Vivid	X	●	X	X	●	●	●	●	●	-	-	-	-

List of camera function

Function		MODE DIAL											▶		
		EASY	PROG			A	S	M		MySEF		JPEG	AVI	WAV	
FLASH	Auto	×	◆(■)	×	×	×	×	×	×	●(■)	-	-	-	-	
	Red eye (with Auto)	◆(■)	●	◆(■)	×	×	×	×	×	●	-	-	-	-	
	Fill-in	×	●	●	×	●	●	●	×	●	-	-	-	-	
	Slow sync.(with Red eye)	×	●	×	◆(■)	●	●	●	×	●	-	-	-	-	
	Off	●	●	●	●	◆(■)	◆(■)	◆(■)	◆(■)	●	-	-	-	-	
EVC	-0.5 ~ -2.0EV (1/2 EV step)	×	●	●	×	●	●	●	×	●	-	-	-	-	
	0.0EV	◆(■)	◆(■)	◆(■)	◆(■)	◆(■)	◆(■)	◆(■)	◆	●(■)	-	-	-	-	
	+0.5 ~ +2.0EV (1/2 EV step)	×	●	●	×	●	●	●	×	●	-	-	-	-	
SELFTIMER	Off	◆(■)	◆(■)	◆(■)	◆(■)	◆(■)	◆(■)	◆(■)	◆(■)	◆(■)	-	-	-	-	
	2 sec.	×	●	●	●	●	●	●	×	●	-	-	-	-	
	10 sec.	●	●	●	●	●	●	●	×	●	-	-	-	-	
	Remote control	●	●	●	●	●	●	●	●	●	-	-	-	-	
AF ZONE	Normal (80cm ~ ∞)	◆(■)	◆(■)	◆(■)	◆(■)	◆(■)	◆(■)	◆(■)	◆(■)	◆(■)	-	-	-	-	
	Macro (30 ~80cm)	●	●	×	×	●	●	●	●	●	-	-	-	-	
	Super Macro (6 ~30cm)	●	●	×	×	●	●	●	×	●	-	-	-	-	
AUDIO (Voice memo)	Off	◆(■)	◆(■)	◆(■)	◆(■)	◆(■)	◆(■)	◆(■)	●	◆(■)	-	-	-	-	
	On	●	●	●	●	●	●	●	◆(■)	●	-	-	-	-	
A/S/M	A/S/M	×	×	×	×	●(A)		×	●(P)	-	-	-	-		
SET	Av	×	×	×	×	◆(F5.6)	×	◆(F5.6)	×	◆(F5.6)	-	-	-	-	
	Tv	×	×	×	×	◆(1/250)	×	◆(1/250)	×	◆(1/250)	-	-	-	-	
SLIDE SHOW	OFF /1~10 sec.(1sec step)	-	-	-	-	-	-	-	-	-	-	-	-	●(OFF)	
	Repeat Off	-	-	-	-	-	-	-	-	-	-	-	-	◆(■)	
	Repeat On	-	-	-	-	-	-	-	-	-	-	-	-	●	
PROTECT	Unlock	-	-	-	-	-	-	-	-	-	-	-	-	●(■)	
	Lock	-	-	-	-	-	-	-	-	-	-	-	-	●	
DPOF	Index (1 print)	-	-	-	-	-	-	-	-	-	●	×	×	×	
	Standard (0 ~30 prints)	-	-	-	-	-	-	-	-	-	●	×	×	×	
EDIT	Trimming	-	-	-	-	-	-	-	-	-	●	×	×	×	
	Resize	-	-	-	-	-	-	-	-	-	●	×	×	×	
DELETE ALL		-	-	-	-	-	-	-	-	-	-	-	-	●	
FILE NAME	Reset	●(■)													
	Series	●													
POWER OFF	OFF /1~10 min.	●(3 min)													
LANGUAGE	15 Languages	●(English)													
DATE	2002.01.01 ~2050.12.31	●(2003.01.01)													

List of camera function

Function		MODE DIAL										▶		
		EASY	PROG			A	S	M		MySE		JPEG	AVI	WAV
IMPRINT	Off							●(■)						
	Date							●						
	Date &Time							●						
DATE TYPE	YYYY/MM/DD							●(■)						
	DD/MM/YYYY							●						
	MM/DD/YYYY							●						
SOUND EFFECT	On							●(■)						
	Off							●						
START-UP IMAGE	Off							●						
	IMAGE 1							●(■)						
	IMAGE 2							●						
	IMAGE 3							●						
	USER IMAGE							●						
START-UP SOUND	Off							●						
	SOUND 1							●(■)						
	SOUND 2							●						
	SOUND 3							●						
SHUTTER SOUND	Off							●						
	SH.SOUND 1							●(■)						
	SH.SOUND 2							●						
	SH.SOUND 3							●						
LCD BRIGHTNESS	0 ~2 Level							●(1 Level)						
VIDEO OUT	NTSC							●(■)						
	PAL							●						
QUICK VIEW	Off /1~3 sec							●(1 sec)						
	Delete answering On							●						
	Delete answering Off							●(■)						

Starting PC mode

- If you insert the USB cable into the USB connection terminal, the camera working mode will change to the PC mode automatically.
- In this mode, you can download stored images to your PC through the USB cable.
- The LCD monitor is always turned off in PC mode.
- The autofocus indicator lamp(red) lamp blinks when the files are transferring via the USB connection.

■ Connecting the camera to PC

1. Turn the PC power on.
2. Turn the camera power on.
3. Connect the PC and the camera via the USB cable.
 - Insert the small plug of the USB cable into the camera USB connection terminal.
 - Insert the large connector of the USB cable into the USB port of the PC
 - The plugs must be firmly inserted.

■ Disconnecting the camera and PC

Refer to the following page

- WIN 98SE : p.119
- WIN 2000/ME/XP : p.119

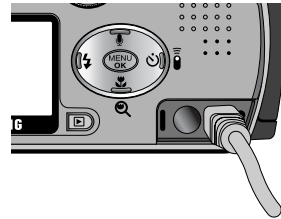

INFORMATION

- ▶ The camera driver must be installed before using PC mode.
- ▶ To save battery power, it is recommended that you use an AC adaptor(Optional) when connecting the camera to a computer.

Starting PC mode

■ Downloading stored images

Once you have downloaded images to your PC, they can be edited and printed.

1. Connect the camera to your PC with the USB cable.
2. On your computer's desktop display, select [My computer] and double click [Removable Disk → DCIM → 100SSCAM].
The image files will then be displayed.



3. Select an image and press the right mouse button.

4. A pop-up menu will open.
Click [Cut] or [Copy] menu
[Cut] : cuts a selected file.
[Copy] : copies files.



5. Click a folder that you want to paste the file.

6. Press the right mouse button and a pop-up menu will open.
Click [Paste].



7. An image file is transferred from camera to your PC.



- By using [Digimax Viewer], you can see the stored images in the memory directly on the PC monitor and you can copy or move the image files.

Important notes

- Your new Samsung camera is a precision instrument. Whilst it is designed to withstand general wear and tear, there are some important points that will help you get maximum service and reliability from your camera. The following should be avoided :
 - Severe changes in temperature and humidity.
 - Dust and dirt.
 - Direct sunlight or the inside of a vehicle in hot weather.
 - Environments where there is high magnetism or excessive vibration.
 - Areas with high explosives or which are highly flammable materials.
 - Pesticides, etc.
- Sand can be particularly troublesome to cameras.
 - Sand or other small particulates can cause severe malfunctions.
 - Ensure that there is no contact with sand or similar particles.
- Extremes in temperature may cause problems.
 - If the camera is transferred from a cold to a warm and humid environment, condensation can form on the delicate electronic circuitry. If this occurs, turn the camera off and wait for at least 1 hour until all moisture is dispersed. Moisture build up can also occur in the MEMORY CARD. If this happens, turn off the camera and remove the MEMORY CARD. Wait until the moisture has dispersed.
- If the digital camera is not used for a long period, an electric discharge can occur. It is a good idea to remove the batteries and the MEMORY CARD, the camera is not used for some time.
- If the camera is exposed to electronic interference, it will turn itself off to protect the MEMORY CARD.
- Maintenance
 - Use a soft brush (available from photo stores) to GENTLY clean the lens and LCD assemblies. If this does not work, lens-cleaning paper with lens cleaning fluid can be used.
 - Clean the camera body with a soft cloth. Do not allow this camera to come into contact with solvent materials such as benzol, insecticide, thinners etc.
 - This may damage the body shell of the camera and also affect its performance.
 - Rough handling can damage the LCD monitor. Take care to avoid damage and keep the camera in its protective carry case at all times when not in use.
- DO NOT attempt to disassemble or modify the camera. It contains delicate parts and there are high voltage circuits that can cause electric shocks.
- Under certain conditions, static electricity can cause the flash unit to fire.
 - This is not harmful to the camera and is not a malfunction.
- When images are uploaded or downloaded, the data transfer may be affected by static electricity. In this case, disconnect and re-connect the USB cable before trying the transfer again.

Warning indicator

There are several warnings that may appear in the LCD display

Warning indicator	Causes	Remedy
CARD ERROR !	<ul style="list-style-type: none">- Card error	<ul style="list-style-type: none">- Turn off the camera power and turn it on again- Insert the memory card again- Format the memory card (p.83)
CARD FULL !	<ul style="list-style-type: none">- There is insufficient memory capacity to take an image	<ul style="list-style-type: none">- Insert a new memory card- Delete unnecessary image files to free up some memory
NO IMAGE !	<ul style="list-style-type: none">- There are no images stored on the memory card	<ul style="list-style-type: none">- Take images- Insert a memory card that is holding some images
NO CARD !	<ul style="list-style-type: none">- A memory card is not inserted- The camera can't recognize the memory card	<ul style="list-style-type: none">- Insert a memory card- Insert the memory card again- Turn off the camera power and turn it on again
FILE ERROR !	<ul style="list-style-type: none">- Memory card error	<ul style="list-style-type: none">- Insert a new memory card- Contact camera service center
LOW BATTERY !	<ul style="list-style-type: none">- There is low battery capacity	<ul style="list-style-type: none">- Insert fresh batteries
CARD LOCKED !	<ul style="list-style-type: none">- The SD memory card is locked	<ul style="list-style-type: none">- Slide the write protect switch to the top of the SD memory card

Before contacting a service center

Symptom	Causes	Remedy
The camera doesn't switch on	<ul style="list-style-type: none"> - There is low battery capacity - An AC Power Adapter is not connected 	<ul style="list-style-type: none"> - Insert fresh batteries - Connect an AC Power Adapter
The camera power is down whilst in use	<ul style="list-style-type: none"> - The batteries are exhausted - The Camera is turned off automatically due to the Auto power off function - The Adapter plug is not connected securely 	<ul style="list-style-type: none"> - Insert fresh batteries - Slide the power switch to reactivate camera - Remove and re-insert the plug
Batteries drain quickly	<ul style="list-style-type: none"> - The Camera is being used in low temperatures - Mixing old and new batteries or battery types 	<ul style="list-style-type: none"> - Keep the camera in warm conditions (i.e. inside a coat or jacket) and only remove it in order to take images - Insert fresh batteries (all of which should be of the same type)
Camera does not take images when pressing the Shutter button	<ul style="list-style-type: none"> - The memory card is not inserted - There is insufficient memory capacity - The memory card has not been formatted - The memory card is exhausted - The camera power is off - The batteries are exhausted - The SD card is locked 	<ul style="list-style-type: none"> - After turning the camera off, insert a new memory card - Delete unnecessary image files - Format the memory card (p.83) - Insert a new memory card - Turn the camera power on - Insert fresh batteries - Slide the write protect switch to the top of the SD memory card



Before contacting a service center

Symptom	Causes	Remedy
The images are unclear	<ul style="list-style-type: none">- The focus mode is not correct.- The autofocus was not activated- Taking a picture beyond the flash range- The lens is smudged or dirty.	<ul style="list-style-type: none">- If the subject is closer than 0.8m, select macro shot mode.- Use Fixed focus when you can't use auto focus mode.- Take a picture within the flash range- Clean the lens
The flash does not fire	<ul style="list-style-type: none">- FLASH OFF mode have been selected	<ul style="list-style-type: none">- Dis-engage FLASH OFF mode
Incorrect date and time is displayed	<ul style="list-style-type: none">- The date and time have been set incorrectly or the camera has adopted the default settings	<ul style="list-style-type: none">- Reset the date and time correctly
The camera buttons do not operate	<ul style="list-style-type: none">- Camera malfunction	<ul style="list-style-type: none">- Remove /re-insert batteries and switch camera on
Memory card error	<ul style="list-style-type: none">- Incorrect memory card format	<ul style="list-style-type: none">- Re-format the memory card (p.83)

Before contacting a service center

Symptom	Causes	Remedy
Color of image different to original scene	- White balance setting is incorrect	- Select appropriate White balance
Images are too bright	- Exposure is excessive	- Reset exposure compensation
No image on external monitor	- The external monitor has not been connected properly with the camera - There are incorrect files in the memory card	- Check the connection cables - Insert a memory card that have correct files
When using the PC's explorer, 'Removable Disk' file does not show	- Cable connection is incorrect - The camera is off - There are no batteries, the batteries are exhausted or the AC adapter is not connected - The operating system is not Windows 98, 98SE, 2000, ME, XP/ Mac OS 9.0~10.2. Alternatively the PC does not support USB - USB driver is not installed	- Check the connection - Turn the camera on - Insert new batteries or check the adapter connection - Install Windows 98, 98SE, 2000, ME, XP/ Mac OS 9.0~10.2 to PC that supports USB - Install "USB Storage Driver"

Specifications

Image Sensor	Type	1/1.8" CCD
	Effective Pixels	Approx. 3.2 Mega pixels
	Total Pixels	Approx. 3.3 Mega pixels
Lens	Focal Length	Schneider Lens f = 7.7 ~ 23.1mm (35mm film equivalent : 38~114mm)
	F No.	F2.7 ~ F4.9
	Digital Zoom	Still Image mode : 1.0X ~ 4.0X Play mode : 1.0X ~ 8.3X (depends on image size)
Viewfinder	Optical Viewfinder	Real image optical viewfinder
	LCD Monitor	1.5" color TFT LCD (78,000 dots)
Focusing	Type	TTL auto focus, Manual focus
	Range	Normal : 80cm ~ infinity, Macro : 30 ~ 80cm, Super Macro : 6 ~ 30cm (Wide only)
Shutter	Type	Mechanical and Electronic shutter
	Speed	4 ~ 1/2,000 sec. (Manual : max. 15 sec.)
Exposure	Control	Program AE, Shutter Priority AE, Aperture Priority AE or Manual Exposure / Metering : Multi, Spot
	Compensation	±2.0EV (0.5EV steps)
	ISO Equivalent	Auto, 100, 200, 400
Flash	Modes	Auto, Auto & Red-eye reduction, Fill-in flash, Slow sync, Flash off
	Range	Wide : 0.3 ~ 3.0m, Tele : 0.3 ~ 2.0m
	Recharging Time	Approx. 7 sec.
Sharpness		Soft, Normal, Vivid
Effect		Normal, B&W, sRGB, Sunset
White Balance		Auto, Daylight, Cloudy, Fluorescent, Tungsten
Voice Recording		Voice Recording (max. 2 hour) Voice Memo on Still Image (max. 10 sec.)
Date Imprinting		Date&Time, Date, Off (user selectable)
Shooting	Still Image	Modes : Easy, Program, A/S/M, My Set, Night Scene, Portrait Macro : Macro, Super Macro Continuous : Single, Continuous, AEB Self-timer : 10 sec., 2 sec., Remote control (optional)
	Movie Clip	Voice On, Off (user selectable) Size : 320x240 (Recording time : memory capacity dependent)
Storage	Media	SD / MMC card (up to 256MB guaranteed)
	File Format	Still Image : TIFF, JPEG (DCF), DPOF Movie Clip : AVI (MJPEG) Voice : WAV

Specifications

	Image Size	Large : 2048x1536 pixels, Medium : 1024x768 pixels, Small : 512x384 pixels, Photo : 2048x1360 pixels
	Capacity (32MB)	Large : Super fine 16, Fine 33, Normal 67, TIFF 3 Medium : Super fine 67, Fine 135, Normal 271, TIFF 13 Small : Super fine 271, Fine 542, Normal 1085, TIFF 54 Photo : Super fine 19, Fine 38, Normal 76, TIFF 3 * These figures are measured under Samsung's standard conditions and may vary depending on shooting conditions and camera settings.
Image Play		Single image, Thumbnails, Slide show, Movie Clip
Interface		Digital output connector : USB Audio : Mono Video output : NTSC, PAL (user selectable) DC power input connector : 5.0V
Power Source		Included : CR-V3 battery Optional : 2x AA alkaline, Lithium, Ni-Mn, Ni-Zn, Ni-MH, Ni-Cd batteries. Rechargeable Li ion battery - SLB-1437 or SBP-1103 AC adapter
Dimensions (WxHxD)		105.5 x 54.6x 38 mm
Weight		165g (without batteries and card)
Software	Camera Driver	Storage Driver (Windows98/98SE/2000/ME/XP, Mac OS 9.x ~ 10.2)
	Application	MGI PhotoSuite, Digimax Viewer 2.0

System Requirements	Digimax
For Windows	PC with processor better than MMX Pentium 233MHz (XP : Pentium II 300MHz) Windows 98/98SE/2000/ME/XP Minimum 32MB RAM (XP : 128MB) 140MB of available hard-disk space USB port CD-ROM drive 800x600 pixels, 16-bit color display compatible monitor (24-bit color display recommended)
For Macintosh	Power Mac G3 or later Mac OS 9.x ~ 10.2 Minimum 64MB RAM 110MB of available hard-disk space USB port CD-ROM drive QuickTime 4.0 or later for Movie Clip

※ Specifications are subject to change without prior notice.

Software Notes

Please ensure that you read the instruction manual carefully before use.

- The attached software is a camera driver and image editing software tool for Windows.
 - Under no circumstances should all or part of either the software or the user manual be reproduced.
 - Copyright for both software is licensed only for use with a camera.
 - In the unlikely event of a manufacturing fault, we will repair or exchange your camera. We cannot, however, be held responsible in any way for damage caused by inappropriate use.
 - Using a Hand-made PC or a PC that has not been guaranteed by the manufacturer is not covered by the Samsung warranty.
 - Before reading this manual, you should have a basic knowledge of computers and O/S (Operating Systems).
- ※ Windows is a registered trademark of Microsoft.
※ Macintosh, Mac is the registered trademark of Apple computer, USA.

About the software

After inserting the CD-ROM provided with this camera into the CD-ROM drive, the following window should automatically run. Before connecting the camera to the PC, you should first install the camera driver.

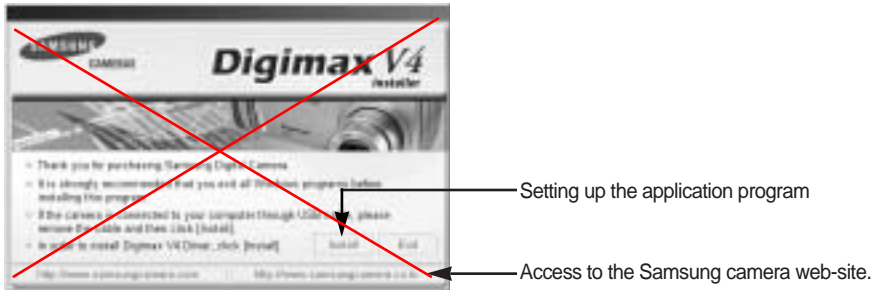

Click the [Install] menu on the Autorun frame and all of application software is installed.

- Camera driver : This enables images to transfer between the camera and PC.
This camera uses the USB Storage Driver as the camera driver. You can use the camera as a USB card reader. After installing the driver and connecting this camera to the PC, you can find [Removable Disk] in [Windows Explorer] or [My computer]. A USB Storage Driver is provided only for Windows. A USB Driver for MAC is not included with the Application CD. But you can use the camera with Mac OS 9.0~10.2.
- Setting up the camera driver for WINDOWS (p.110)

About the software

■ Digimax Viewer 2.0 :

This is a program for viewing stored images. You can see the stored images in the memory directly on a PC monitor. You can also copy, move or delete the images and enlarge /downscale the image sizes with Digimax Viewer.

For windows only.

- Setting up Digimax Viewer (p.111)
- Using Digimax Viewer (p.122)

■ MGI PhotoSuite III SE : Image editing program

Image editing program for downloaded images. For Windows only.

- Setting up MGI PhotoSuite III SE (p.112)
- Using MGI PhotoSuite III SE (p.123)

■ Internet link : You can visit the Samsung web-site through the internet.

- <http://www.samsungcamera.com> : English
- <http://www.samsungcamera.co.kr> : Korean



INFORMATION

- ▶ Check the system requirements (p.107) before setting up the driver.
- ▶ You should allow 5-10 seconds for running the automatic setup program according to the capability of the computer. If the frame does not show, run the [Windows Explorer] and select [Samsung.exe] in the CD-ROM Drive root directory.

Setting up the application software

To use this camera with a PC, install the application software first. After this has been done, the stored images in the camera can be moved to the PC and can be edited by an image editing program.



NOTICE

- ▶ Disable other programs before installing the application software.
- ▶ Before installing the application software, disconnect the USB connection.

You can visit the Samsung web-site through the internet.

<http://www.samsungcamera.com> : English

<http://www.samsungcamera.co.kr> : Korean

1. Click the [Install] menu in the Autorun frame.
The Digimax V camera driver is installed automatically.

[Click !]

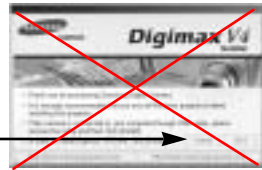

2. Installation is complete.
Click the [Finish] button.

[Click !]



3. A window for which you can select application software will be displayed. Select the application program and click the [Install] button.
Refer to page.106 for more information about the application program.

[Click !]



INFORMATION

- ▶ If you select [Cancel] at step 3, the application program installation will be cancelled.

Setting up the application program

4. The [Digimax Viewer 2.0] installation window will be displayed as shown below. Click the [Next] button.



INFORMATION

- If you select [Cancel] at step 4, a window for installing MGI PhotoSuite III SE will be displayed.

5. The Software License Agreement window will be displayed. If you agree to this, click [Yes], the window will then move to the next step. If you disagree, click [No] and the install program will be canceled.

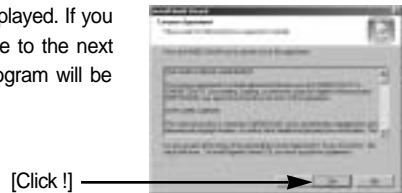

6. Select a destination folder and click [Next].

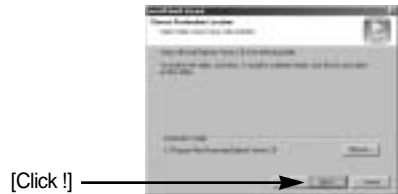

7. Select the Program folder and click [Next].

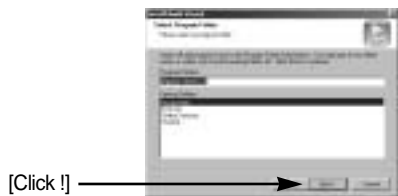

Setting up the application program

8. Installation is completed. Click the [Finish] button and a window for installing MGI PhotoSuite III SE will be displayed.



[Click !]

9. The [MGI PhotoSuite III SE] installation window will be displayed as shown below. Click the [OK] button.



[Click !]



INFORMATION

- If you select [Cancel] at the step 9, a window for restarting the computer will be displayed.

10. A [Welcome] window will be displayed.
Click the [Next] button.

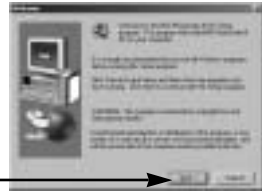

[Click !]

11. The Software License Agreement window will be displayed. If you agree to this, click [Yes], the window will then move to the next step. If you disagree, click [No] and the install program will be canceled.

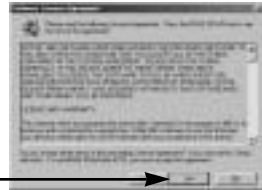

[Click !]

Setting up the application program

12. Select a setup type and click the [Next >] button.
Full : the program will be installed with all the options.
Custom : you can choose what you would like to install.

[Click !]



13. If installation is completed correctly, Autoplay is registered automatically into the start menu program as shown alongside. Click the [Next>] button.

[Click !]



14. The MGI Registration window will be displayed. Click the [Continue] button.

[Click !]



15. The [Online Registration Utility] window will be displayed. Fill in the blanks and click the [Register] button.

[Click !]

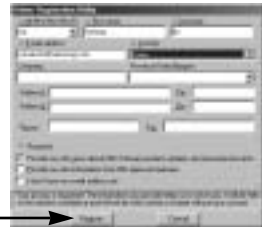

16. Installation is complete. Click the [Finish] button.

[Click !]



Setting up the application program



INFORMATION

▶ A [Read me] file will open. Click the Close button to close the file.

17. To use the [REMOVABLE DISK], you have to restart your computer. Click [Finish] button and the computer will restart.



[Click !]

18. After restarting the computer, connect the PC to the camera with the USB cable.

19. Turn the camera power on. [Found New Hardware Wizard] will open and the computer will recognize the camera.

* If you have ever installed an image viewer program or your OS is Windows XP, an image viewer program will open. If the image viewer program opens, the camera driver was setup successfully.



20. If you can see [Removable Disk] under [My computer], the camera driver installation is successful. Now you can transfer image files from the camera to PC via the USB cable.



Setting up the application program



INFORMATION

- ▶ If you have installed the camera driver, [Found New Hardware Wizard] may not open.
- ▶ After the [Found New Hardware Wizard] window opens, a window may open to select the camera driver file location. In this case, select the [C:\WINDOWS\INF\OTHER] folder.
If you can't find the [INF\OTHER] folder, check the [Show all files] button in [Window's Explorer → View → Folder option → View].
- ▶ Before connecting the camera to the PC, You should first install the camera driver.
- ▶ After installing the camera driver, you have to restart your PC.
- ▶ If you connect the camera to the PC before installing the camera driver, the [Found New Hardware Wizard] will open. In this case, cancel the [Found New Hardware Wizard] and disconnect the camera. Install the camera driver and connect the camera to the PC again.
- ▶ Should the computer not find the camera driver after installation, please try one or more of the following measures.
 1. Delete the camera driver (p.116), and re-install the driver.
 2. Refer to FAQ (p.138) to check for a possible solution to the problem.
 3. If your PC's central processing unit is VIA chip (This is shown in the USB Host Controller), download the patch file from the Samsung Camera web page.
(<http://www.samsungcamera.com>)



Removing the USB Driver for Windows 98SE

■ To remove the USB driver, refer to the process shown below.

1. Trace [Start → Settings] and click [Control Panel]



2. Double-click [Add/Remove programs].



Removing the USB Driver for Windows 98SE

3. The [Add/Remove Programs Properties] window will open. Click [Digimax V] and click the [Add/Remove] button.

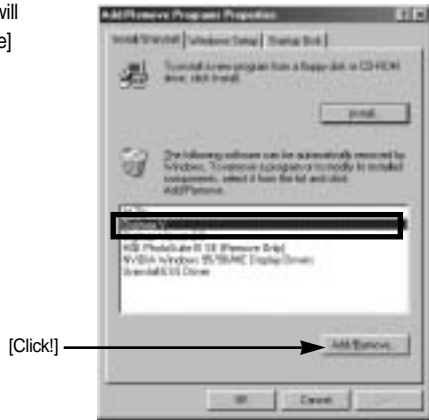

4. A window will open. Click the [OK] button and the camera driver will be removed.



5. Uninstall is complete.
Click the [Finish] button and the window will disappear.



Removable Disk

To use this camera as a Removable Disk, install (p.110) the USB Driver.

1. Before turning the camera power on, connect the camera to the PC with the USB cable.
2. Click [Removable Disk] under [My computer] or [Windows Explorer].
3. Image files stored in the Removable Disk (DCIM → 100SSCAM) can be transferred to the PC.



NOTICE

Important information whilst using the Removable Disk

- ▶ The [Removable Disk] indicator will not show when the camera power is off.
- ▶ We recommend that you should copy the images to the PC to view them. Opening images directly from the removable disk may be subject to unexpected disconnection.
- ▶ When uploading images from the PC to the camera, ensure that the uploaded file names are not the same as those already stored on the memory.
- ▶ When you upload a file that is not taken by this camera to Removable Disk, the [FILE ERROR!] message will be displayed on the LCD monitor in the PLAY mode, and nothing is displayed in THUMBNAIL mode.
- ▶ The green lamp next to the viewfinder will blink, when a file is transferred (copy or deletion) between the PC and the camera. Do not remove the USB cable until the lamp stops blinking. To remove the USB cable in Windows 2000/ME/XP, use the [Unplug or Eject Hardware] icon on the task bar.



Removing the removable disk

■ Windows 98SE

1. Check whether the camera and PC are transferring a file. If the green lamp (next to viewfinder) blinks, you have to wait until the LED illuminates.
2. Unplug the USB cable.

■ Windows 2000/ME/XP

(The illustrations may be different from the real display in accordance with the Windows O/S.)

1. Check whether the camera and PC are transferring a file.
If the green lamp (next to viewfinder) blinks, you have to wait until the LED illuminates.

2. Double-click the [Unplug or Eject Hardware] icon on the task bar.



[Double-click]

3. The [Unplug or Eject Hardware] window will open.
Select the [USB Mass Storage Device] and click the [Stop] button.



[Click!]

Removing the removable disk

4. The [Stop a Hardware device] window will open.
Select the [SAMSUNG DIGIMAX V3 USB Device]
and click the [OK] button.

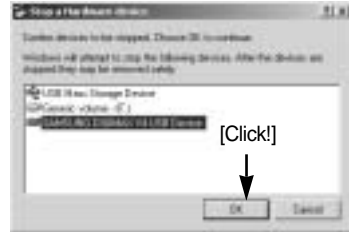

5. A [Safe to Remove Hardware] window will open.
Click the [OK] button.



6. A [Unplug or Eject Hardware] window will open.
Click the [Close] button and the removable disk will
be removed safely.



7. Unplug the USB cable.

Setting up the USB Driver for MAC

1. A USB Driver for MAC is not included with the Application CD as MAC OS supports the camera driver.
2. Check the MAC OS. You can check the MAC OS version during MAC OS start-up.
This camera is compatible with MAC OS 9.X-10.2.
3. Connect the camera to the Macintosh and turn the camera power on in PC mode.
4. A new icon (Untitled) will be displayed on the desktop after connecting the camera to the MAC.

Using the USB Driver for MAC

1. Double click a new icon (Untitled) on the desktop and the folder in the memory will be displayed.
2. Select an image file and copy or move it to MAC.



NOTICE

- ▶ If you use Mac OS 10.0 or later, you may experience an error occurring when you transfer files from the PC to the camera.

Digimax Viewer

This software is only compatible with Windows.



1. To open Digimax Viewer, click the [Start → Programs → Samsung → Digimax Viewer 2.0 → Digimax Viewer 2.0] and Digimax Viewer 2.0 will then open.



2. If the [Auto Launch] option is selected, this program will be executed automatically with recognizing the camera.



3. You can easily use the Digimax viewer program as it offers FILE menu and TOOL bar. And, you can use the pop up menu. Click an image and press the right mouse button.

Digimax Viewer functions are listed below.

- Basic function : Copy, Move, Delete, Rotate, Rename, changing file type, Resize, Property.
- Advanced function : Print, Slide show, Export, Sending e-mail, On-line print, Web album etc.



INFORMATION

- ▶ Refer to the [Help] menu in Digimax viewer 2.0 for further information.

MGI PhotoSuite III SE







This software is only compatible with Windows.

To open MGI PhotoSuite III SE, click the [Start → Programs → MGI PhotoSuite III SE → MGI PhotoSuite III SE] and MGI PhotoSuite III SE will then open.



MGI PhotoSuite III SE











■ An introduction to the Welcome screen

	<p>Get</p> <p>Get images.</p>
	<p>Prepare</p> <p>A number of photo editing activities can be performed within this module.</p>
	<p>Compose</p> <p>Use your photos in a variety of fun, creative and interesting ways.</p>
	<p>Organize</p> <p>Organize your photos and other media files into albums.</p>
	<p>Share</p> <p>Save your results to show to others.</p>
	<p>Print</p> <p>Print hard copies of photos and projects.</p>

MGI PhotoSuite III SE

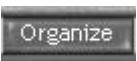
■ Introduction to navigation bar



	Back Return to the previous step.
	Home Return to Welcome screen.
	Help Display help window.
	Get Get images.
	Prepare A number of photo editing activities can be performed within this module.
	Compose Use your photos in a variety of fun and interesting ways.
	Organize Organize your photos and other media files into albums.
	Share Save your results to show to others.
	Print Print hard copies of photos and projects.
	Browse Browse the web site.

MGI PhotoSuite III SE

GET

■ To obtain images from the computer

1. To acquire images, Click the large [Get] button on the Welcome screen, or the [Get] button on the Navigation bar. Click [Computer] from the list of options displayed on the activity panel.



2. The Open file selector is displayed. Now select the image file and click [open].



3. The Welcome screen will change to the next work step, with the selected image displayed.



MGI PhotoSuite III SE

■ When you obtain images from the digital camera.

Before transferring an image file, check the USB connection.

1. To acquire images, click the large [Get] button on the Welcome screen, or the [Get] button on the Navigation bar. Click [Computer] from the list of options displayed on the activity panel.



2. The Open file selector is displayed. Click [Look in :] to choose [Removable Disk (:)] and click [open] for the open file window to be displayed.



3. Select the [DCIM → 100sscam] folder. Then select an image and click [Open].



MGI PhotoSuite III SE

4. The Welcome screen will change to the next work step, with the selected image displayed.

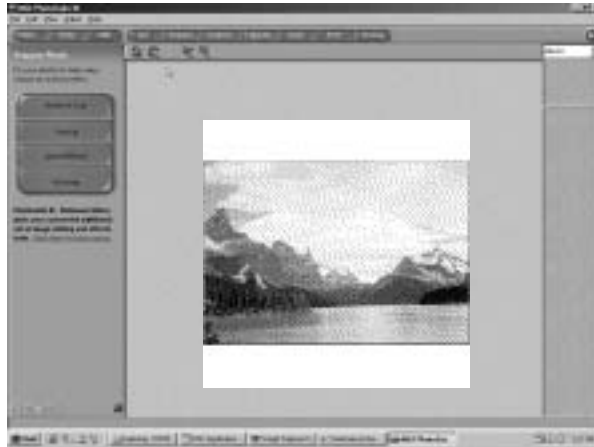

NOTICE

When you use the Digimax camera, only [Computer] and [Album] from the list of options displayed are available. You will be able to obtain images from the digital camera.



[Computer and Album Only]

MGI PhotoSuite III SE

■ Acquiring images from an Album.

1. To acquire images, click the large [Get] button on the Welcome screen, or the [Get] button on the Navigation bar. Click [Album] from the list of options displayed on the activity panel.



2. After selecting Album on the [1 Choose a photo album], click an image in the album and click [Open].



3. The Welcome screen will change to the next work step, with the selected image displayed.

※ Refer to page 133 for more information about creating an Album.

MGI PhotoSuite III SE

PREPARE

When the image is loaded, the step changes to Prepare automatically.

■ Menu for [PREPARE] steps

Rotate & Crop

You can rotate, flip or crop images along with a host of others.



Touchup

Remove Red eye, Remove Scratches etc.. are available in this menu.

Special Effects

A number of special effects can be applied.

Stitching

Join a series of photos together to create a sweeping panoramic effect.

MGI PhotoSuite III SE

COMPOSE

Add text, Compound Images etc. are available in this step.

■ Menu of [COMPOSE] steps

- Collages** : A collage consists of several photos or sections of photos arranged together on a common background.
- Photo Layouts** : The Photo Layouts activity includes many collage and layout options.
- Cards & tags** : Use your photos to create items such as Gift Tags, Greeting Cards, Invitations, Postcards, and Sports Cards.
- Calendars** : Use your photos to create a variety of calendars (monthly, quarterly, seasonal, yearly).
- Collections** : Photos can also be used to create a variety of items for business purposes.
- Fun stuff** : You can create magazine covers, Backgrounds etc. in this menu.
- Business** : You can make business items such as business cards, certificates, signs, labels, promotions, name tags, stationary
- Frames & Edges** : Add frames and edge effects to your photos according to predefined templates.



MGI PhotoSuite III SE

ORGANIZE

Organize your photos and other media files into albums.

■ Menu of [ORGANIZE] steps

[① Choose a photo album to view or edit]

Select Album : To create an Album, click [Organize] in the welcome screen or navigation bar.

Album.. : Open Master Album.

[② Select a photo, and choose an action below.]

- Open : Open selected image.
- Delete : Delete selected image.
- Properties... : view image information.

[③ Choose an action to manage your album.]

- Add : click [Add] to add an image to an Album.
- Sort : click [Sort] to Sort saved images.
- Search : click [Search] to Search saved images.
- Reset : click [Reset] to reset the setting.
- Update : click [Update] to update images.
- Create Slide Show : click [Create Slide Show] to create a Slide Show.

Always start on this page : If you select this option, the program will start in [Organize].

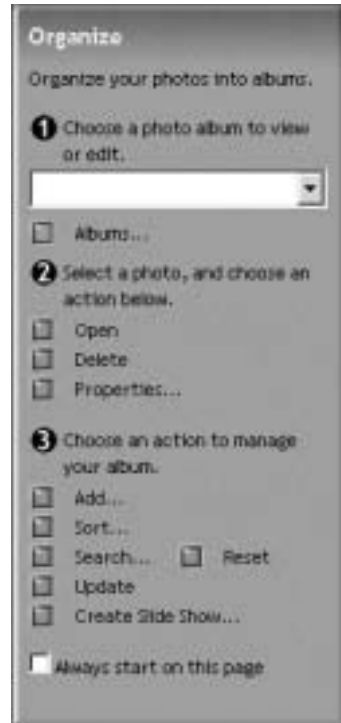

MGI PhotoSuite III SE

■ Creating an Album

1. To create an Album, click the large Organize button on the Welcome screen, or the Organize button on the Navigation bar.
2. Click [Album..] in [①Choose a photo album to view or edit.]
3. The Master Album window will be displayed, then click [New..].
4. Put a new Album name in the New Album window and click [OK]. A new album will now be created.
5. A [Master Album] window will open. Click the [OK] button.



MGI PhotoSuite III SE

■ Add images to the album

1. Select [③Choose an action to manage your album. → Add..] to add images to the album.

[Click!]



2. Click [Computer] in Add Photos menu.

[Click!]

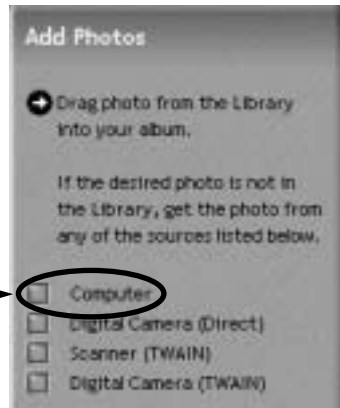

NOTICE

[Digital Camera(Direct)], [Scanner(TWAIN)], [Digital Camera(TWAIN)] sources can't be used.

MGI PhotoSuite III SE

3. A [Add photo to Album] window will open. Select images that you want to add. Click the [Add] button.



[Click!]

4. Adding images is complete.



MGI PhotoSuite III SE

SHARE

Saving or sharing images.

■ Menu of [SHARE] steps

Save

To save the active file according to its current name and path.

Save As

To assign a new name or path to the file.

Send E-mail

e-mailing images.

Slide Show

Viewing images as a slide show.



MGI PhotoSuite III SE

PRINT

You can print images.

■ Menu for the [PRINT] steps

Print

Printing images.

Print Multiples

Print multiple copies of a photo or project, or one copy of each of the photos included in an album, according to a predefined template.

- * Choose a printer, an orientation, the print size, and the number of copies. You can then print the images.



INFORMATION

For more information, please refer to the Help file in [Help MGI PhotoSuite III help].

FAQ

Please check the following if the USB connection malfunctions.

- [Case 1] The camera power is off.
→ Turn the camera power on. We recommend using an AC power adapter in PC mode.
If you use batteries, check the battery condition.
- [Case 2] USB Driver is not installed correctly.
→ Install the USB Driver correctly. Refer to page 110.
- [Case 3] The USB cable is not connected or you are using a cable with an incorrect specification.
→ Use a USB cable with the correct specification.
- [Case 4] Occasionally the computer recognizes the USB as another device.
→ Install the camera driver correctly. Turn the camera power off and remove the USB cable.
Connect the USB cable again and turn the camera power on. The computer should now recognize the camera.
- [Case 5] There is an unexpected error during file transfer.
→ Turn the camera power off and on again. Transfer the file again.

[Case 6] How do I know my computer supports a USB Interface?

- Check the USB port in your computer or keyboard.
- Check OS version. USB Interface is available in Windows 98, 98SE, 2000, ME .XP.
- Check [Universal serial bus controller] in Device Manager. Do the following to check [Universal serial bus controller].

Win 98/ME : Trace [Start → Setting → Controller → System → Device Manager → Universal serial bus controller]

Win 2K : Trace [Start → Setting → Controller → System → Hardware Device Manager → Universal serial bus controller].

Win XP : Trace [Start → Control Panel → Performance and Maintenance → System → Hardware Device Manager → Universal Serial Bus controller].

There must be USB Host Controller and USB root hub under [Universal serial bus controller].

- When all the conditions mentioned above are met, the computer can support the USB interface.

[Case 7] When using the USB hub.

- There may be a problem in connecting the camera to the PC through the USB hub if the PC and the hub are not compatible. Wherever possible, connect the camera to the PC directly.

[Case 8] Are other USB cables connected to the PC?

- The camera may malfunction when it is connected to the PC at the same time as another USB cable. In this case, disconnect the other USB cable, and connect only one USB cable to the camera.