

FCC Test Report

(Co-Located)

Report No.: RFBGSN-WTW-P20080589-8

FCC ID: NKS-PA1

Test Model: Trimble Gateway-PA1

Received Date: Aug. 29, 2020

Test Date: Oct. 22, 2020

Issued Date: Nov. 03, 2020

Applicant: PeopleNet Communications Corporation

Address: 4400 Baker Road, Minnetonka Minnesota 55343-8684 United States

Issued By: Bureau Veritas Consumer Products Services (H.K.) Ltd., Taoyuan Branch
Lin Kou Laboratories

Lab Address: No. 47-2, 14th Ling, Chia Pau Vil., Lin Kou Dist., New Taipei City, Taiwan

Test Location: No.19, Hwa Ya 2nd Rd., Wen Hwa Vil., Kwei Shan Dist., Taoyuan City
33383, Taiwan

**FCC Registration /
Designation Number:** 788550 / TW0003



This report is for your exclusive use. Any copying or replication of this report to or for any other person or entity, or use of our name or trademark, is permitted only with our prior written permission. This report sets forth our findings solely with respect to the test samples identified herein. The results set forth in this report are not indicative or representative of the quality or characteristics of the lot from which a test sample was taken or any similar or identical product unless specifically and expressly noted. Our report includes all of the tests requested by you and the results thereof based upon the information that you provided to us. You have 60 days from date of issuance of this report to notify us of any material error or omission caused by our negligence, provided, however, that such notice shall be in writing and shall specifically address the issue you wish to raise. A failure to raise such issue within the prescribed time shall constitute your unqualified acceptance of the completeness of this report, the tests conducted and the correctness of the report contents. Unless specific mention, the uncertainty of measurement has been explicitly taken into account to declare the compliance or non-compliance to the specification.

Table of Contents

Release Control Record	3
1 Certificate of Conformity	4
2 Summary of Test Results.....	5
2.1 Measurement Uncertainty	5
2.2 Modification Record.....	5
3 General Information	6
3.1 General Description of EUT	6
3.2 Description of Test Modes.....	9
3.2.1 Test Mode Applicability and Tested Channel Detail	12
3.3 Description of Support Units	13
Configuration of System under Test.....	13
3.4 General Description of Applied Standards.....	14
4 Test Types and Results	15
4.1 Radiated Emission Measurement.....	15
4.1.1 Limits of Radiated Emission Measurement	15
4.1.2 Test Instruments	17
4.1.3 Test Procedures.....	18
4.1.4 Deviation from Test Standard	19
4.1.5 Test Set Up	20
4.1.6 EUT Operating Conditions.....	21
4.1.7 Test Results	22
5 Pictures of Test Arrangements.....	34
Appendix – Information of the Testing Laboratories	35

Release Control Record

Issue No.	Description	Date Issued
RFBGSN-WTW-P20080589-8	Original Release	Nov. 03, 2020

1 Certificate of Conformity

Product: Trimble Gateway NA
Brand: Trimble
Test Model: Trimble Gateway-PA1
Sample Status: Engineering Sample
Applicant: PeopleNet Communications Corporation
Test Date: Oct. 22, 2020
Standards: 47 CFR FCC Part 15, Subpart C (Section 15.247)
47 CFR FCC Part 15, Subpart E (Section 15.407)
ANSI C63.10:2013
FCC Part 22, Subpart H
FCC Part 24, Subpart E
FCC Part 27, Subpart C, H, L

The above equipment has been tested by **Bureau Veritas Consumer Products Services (H.K.) Ltd., Taoyuan Branch**, and found compliance with the requirement of the above standards. The test record, data evaluation & Equipment Under Test (EUT) configurations represented herein are true and accurate accounts of the measurements of the sample's RF characteristics under the conditions specified in this report.

Prepared by : , **Date:** Nov. 03, 2020
Vera Huang / Specialist

Approved by : , **Date:** Nov. 03, 2020
Dylan Chiou / Senior Project Engineer

2 Summary of Test Results

47 CFR FCC Part 15, Subpart C (Section 15.247) 47 CFR FCC Part 15, Subpart E (Section 15.407) ANSI C63.10:2013 FCC Part 22, Subpart H FCC Part 24, Subpart E FCC Part 27, Subpart C, H, L			
FCC Clause	Test Item	Result	Remarks
15.205 / 15.209 / 15.247(d)	Radiated Emissions and Band Edge Measurement	Pass	Meet the requirement of limit. Minimum passing margin is -5.14 dB at 2390 MHz.
15.407(b) (1/2/3/4(i/ii)/6)	Radiated Emissions & Band Edge Measurement	Pass	Meet the requirement of limit. Minimum passing margin is -0.43 dB at 5150 MHz.
2.1053 27.53(h)	Radiated Spurious Emissions	Pass	Meet the requirement of limit. Minimum passing margin is -17.57 dB at 5160.00 MHz.

Note:

- Determining compliance based on the results of the compliance measurement, not taking into account measurement instrumentation uncertainty.

2.1 Measurement Uncertainty

Where relevant, the following measurement uncertainty levels have been estimated for tests performed on the EUT as specified in CISPR 16-4-2:

Measurement	Frequency	Expanded Uncertainty (k=2) (\pm)
Radiated Emissions up to 1 GHz	9 kHz ~ 30 MHz	3.04 dB
	30 MHz ~ 200 MHz	2.93 dB
	200 MHz ~ 1000 MHz	2.95 dB
Radiated Emissions above 1 GHz	1 GHz ~ 18 GHz	2.26 dB
	18 GHz ~ 40 GHz	1.94 dB

2.2 Modification Record

There were no modifications required for compliance.

3 General Information

3.1 General Description of EUT

Product	Trimble Gateway NA			
Brand	Trimble			
Test Model (HVIN)	Trimble Gateway-PA1			
Status of EUT	Engineering Sample			
Power Supply Rating	12 Vdc (adapter)			
Modulation Type	WLAN	CCK, DQPSK, DBPSK for DSSS 256QAM, 64QAM, 16QAM, QPSK, BPSK for OFDM		
	BT EDR	GFSK, $\pi/4$ -DQPSK, 8DPSK		
	BT LE	GFSK		
	WCDMA	BPSK, QPSK		
	LTE	QPSK, 16QAM		
Operating Frequency	WLAN	2412 ~ 2462 MHz 5180 ~ 5240 MHz, 5260 ~ 5320 MHz, 5500 ~ 5700 MHz, 5745 ~ 5825 MHz		
	WCDMA	WCDMA II	1852.4 ~ 1907.6 MHz	
		WCDMA IV	1712.4 ~ 1752.6 MHz	
		WCDMA V	826.4 ~ 846.6 MHz	
	LTE	LTE Band 2	Channel Bandwidth: 1.4 MHz	1850.7 ~ 1909.3 MHz
			Channel Bandwidth: 3 MHz	1851.5 ~ 1908.5 MHz
			Channel Bandwidth: 5 MHz	1852.5 ~ 1907.5 MHz
			Channel Bandwidth: 10 MHz	1855.0 ~ 1905.0 MHz
			Channel Bandwidth: 15 MHz	1857.5 ~ 1902.5 MHz
			Channel Bandwidth: 20 MHz	1860.0 ~ 1900.0 MHz
		LTE Band 4	Channel Bandwidth: 1.4 MHz	1710.7 ~ 1754.3 MHz
			Channel Bandwidth: 3 MHz	1711.5 ~ 1753.5 MHz
			Channel Bandwidth: 5 MHz	1712.5 ~ 1752.5 MHz
			Channel Bandwidth: 10 MHz	1715.0 ~ 1750.0 MHz
			Channel Bandwidth: 15 MHz	1717.5 ~ 1747.5 MHz
Channel Bandwidth: 20 MHz			1720.0 ~ 1745.0 MHz	
LTE Band 12	Channel Bandwidth: 1.4 MHz	699.7 ~ 715.3 MHz		
	Channel Bandwidth: 3 MHz	700.5 ~ 714.5 MHz		
	Channel Bandwidth: 5 MHz	701.5 ~ 713.5 MHz		
	Channel Bandwidth: 10 MHz	704.0 ~ 711.0 MHz		
BT EDR	2402 ~ 2480 MHz			
BT LE	2402 ~ 2480 MHz			

Number of Channel	<p>2.4 GHz: 11 for 802.11b, 802.11g, 802.11n (HT20)</p> <p>5GHz:</p> <p>5180 ~ 5240 MHz: 4 for 802.11a, 802.11n (HT20), 802.11ac (VHT20) 2 for 802.11n (HT40), 802.11ac (VHT40) 1 for 802.11ac (VHT80)</p> <p>5260 ~ 5320 MHz: 4 for 802.11a, 802.11n (HT20), 802.11ac (VHT20) 2 for 802.11n (HT40), 802.11ac (VHT40) 1 for 802.11ac (VHT80)</p> <p>5500 ~ 5700 MHz: 11 for 802.11a, 802.11n (HT20), 802.11ac (VHT20) 5 for 802.11n (HT40), 802.11ac (VHT40) 2 for 802.11ac (VHT80)</p> <p>5745 ~ 5825 MHz: 5 for 802.11a, 802.11n (HT20), 802.11ac (VHT20) 2 for 802.11n (HT40), 802.11ac (VHT40) 1 for 802.11ac (VHT80)</p> <p>BT EDR: 79</p> <p>BT LE: 40</p>
Antenna Type	Refer to Note as below
Antenna Connector	N/A
Accessory Device	N/A
Data Cable Supplied	N/A

Note:

1. The EUT provides one completed transmitter and one receiver.

Modulation Mode	Tx Function
802.11b	1TX
802.11g	1TX
802.11a	1TX
802.11n (HT20)	1TX
802.11n (HT40)	1TX
802.11ac (VHT20)	1TX
802.11ac (VHT40)	1TX
802.11ac (VHT80)	1TX

* The modulation and bandwidth are similar for 802.11n mode for HT20 / HT40 and 802.11ac mode for VHT20 / VHT40, therefore investigated worst case to representative mode in test report. (Final test mode refer section 3.2.1)

2. The antenna information is listed as below.

WWAN Antenna								
Ant.	Brand	Model	Antenna Type	Antenna Gain (dBi)				Remark
				WDMAN II/LTE 2	WCDMA IV/LTE 4	WCDMA V	LTE 12	
1	TAOGLAS	PCS.06.A	SMD Antenna	3.58	3.82	0.53	-0.03	Internal, Main Antenna
2	TAOGLAS	PCS.06.B	SMD Antenna	3.81	4.04	0.75	0.06	Internal, Aux. Antenna
3	TAOGLAS	MA240.LBI.001	Adhesive Mount Combination Antenna	2.51	1.93	0.94	1.6	External, Main Antenna
4	TAOGLAS	MA240.LBI.001	Adhesive Mount Combination Antenna	1.77	1.2	1	1.2	External, Aux. Antenna

WLAN Antenna							
Brand	Model	Antenna Type	Antenna Gain (dBi)				
			BT/WLAN 2.4 GHz	WLAN 5.15~5.35 GHz	WLAN 5.47~5.725 GHz	WLAN 5.725~5.85 GHz	
TAOGLAS	FXP826.07.0120C	FPC Antenna	0.75	1.22	3.58	3.52	

3. The above Antenna information is declared by manufacturer and for more detailed features description, please refer to the manufacturer's specifications, the laboratory shall not be held responsible.
4. The above EUT information is declared by manufacturer and for more detailed features description, please refers to the manufacturer's specifications or user's manual.

3.2 Description of Test Modes

WLAN 2.4GHz:

11 channels are provided for 802.11b, 802.11g and 802.11n (HT20):

Channel	Frequency (MHz)	Channel	Frequency (MHz)
1	2412	7	2442
2	2417	8	2447
3	2422	9	2452
4	2427	10	2457
5	2432	11	2462
6	2437		

WLAN 5GHz:

For 5180 ~ 5240 MHz

4 channels are provided for 802.11a, 802.11n (HT20), 802.11ac (VHT20):

Channel	Frequency (MHz)	Channel	Frequency (MHz)
36	5180	44	5220
40	5200	48	5240

2 channels are provided for 802.11n (HT40), 802.11ac (VHT40):

Channel	Frequency (MHz)	Channel	Frequency (MHz)
38	5190	46	5230

1 channel is provided for 802.11ac (VHT80):

Channel	Frequency (MHz)
42	5210

For 5260 ~ 5320 MHz

4 channels are provided for 802.11a, 802.11n (HT20), 802.11ac (VHT20):

Channel	Frequency (MHz)	Channel	Frequency (MHz)
52	5260	60	5300
56	5280	64	5320

2 channels are provided for 802.11n (HT40), 802.11ac (VHT40):

Channel	Frequency (MHz)	Channel	Frequency (MHz)
54	5270	62	5310

1 channel is provided for 802.11ac (VHT80):

Channel	Frequency (MHz)
58	5290

For 5500 ~ 5700 MHz

11 channels are provided for 802.11a, 802.11n (HT20), 802.11ac (VHT20):

Channel	Frequency (MHz)	Channel	Frequency (MHz)
100	5500	124	5620
104	5520	128	5640
108	5540	132	5660
112	5560	136	5680
116	5580	140	5700
120	5600		

5 channels are provided for 802.11n (HT40), 802.11ac (VHT40):

Channel	Frequency (MHz)	Channel	Frequency (MHz)
102	5510	126	5630
110	5550	134	5670
118	5590		

2 channels are provided for 802.11ac (VHT80):

Channel	Frequency (MHz)	Channel	Frequency (MHz)
106	5530	122	5610

For 5745 ~ 5825 MHz:

5 channels are provided for 802.11a, 802.11n (HT20), 802.11ac (VHT20):

Channel	Frequency (MHz)	Channel	Frequency (MHz)
149	5745	161	5805
153	5765	165	5825
157	5785		

2 channels are provided for 802.11n (HT40), 802.11ac (VHT40):

Channel	Frequency (MHz)	Channel	Frequency (MHz)
151	5755	159	5795

1 channel is provided for 802.11ac (VHT80):

Channel	Frequency (MHz)
155	5775

BT EDR:

79 channels are provided to this EUT:

Channel	Freq. (MHz)	Channel	Freq. (MHz)	Channel	Freq. (MHz)	Channel	Freq. (MHz)
0	2402	20	2422	40	2442	60	2462
1	2403	21	2423	41	2443	61	2463
2	2404	22	2424	42	2444	62	2464
3	2405	23	2425	43	2445	63	2465
4	2406	24	2426	44	2446	64	2466
5	2407	25	2427	45	2447	65	2467
6	2408	26	2428	46	2448	66	2468
7	2409	27	2429	47	2449	67	2469
8	2410	28	2430	48	2450	68	2470
9	2411	29	2431	49	2451	69	2471
10	2412	30	2432	50	2452	70	2472
11	2413	31	2433	51	2453	71	2473
12	2414	32	2434	52	2454	72	2474
13	2415	33	2435	53	2455	73	2475
14	2416	34	2436	54	2456	74	2476
15	2417	35	2437	55	2457	75	2477
16	2418	36	2438	56	2458	76	2478
17	2419	37	2439	57	2459	77	2479
18	2420	38	2440	58	2460	78	2480
19	2421	39	2441	59	2461		

BT LE:

40 channels are provided to this EUT:

Channel	Freq. (MHz)	Channel	Freq. (MHz)	Channel	Freq. (MHz)	Channel	Freq. (MHz)
0	2402	10	2422	20	2442	30	2462
1	2404	11	2424	21	2444	31	2464
2	2406	12	2426	22	2446	32	2466
3	2408	13	2428	23	2448	33	2468
4	2410	14	2430	24	2450	34	2470
5	2412	15	2432	25	2452	35	2472
6	2414	16	2434	26	2454	36	2474
7	2416	17	2436	27	2456	37	2476
8	2418	18	2438	28	2458	38	2478
9	2420	19	2440	29	2460	39	2480

3.2.1 Test Mode Applicability and Tested Channel Detail

EUT Configure Mode	Applicable To		Description
	RE \geq 1G	RE<1G	
-	√	√	-

Where **RE \geq 1G**: Radiated Emission above 1 GHz **RE<1G**: Radiated Emission below 1 GHz

Note: Radiated Emission and Conducted Out-Band Emission test items chosen the worst maximum power 2.4G and 5G Radio channel.

Radiated Emission Test (Above 1 GHz):

- Pre-Scan has been conducted to determine the worst-case mode from all possible combinations between available modulations, data rates and antenna ports (if EUT with antenna diversity architecture).
- Following channel(s) was (were) selected for the final test as listed below.

EUT Configure Mode	Mode	Freq. Range (MHz)	Available Channel	Tested Channel	Modulation Technology
-	802.11g + LTE Band 4	2412 ~ 2462 1720.0 ~ 1745.0	1 to 11 20050 to 20300	1 + 20050	OFDM · QPSK
	802.11n (HT40) + LTE Band 4	5180 ~ 5240 1720.0 ~ 1745.0	38 to 46 20050 to 20300	38 + 20050	OFDM · QPSK

Radiated Emission Test (Below 1 GHz):

- Pre-Scan has been conducted to determine the worst-case mode from all possible combinations between available modulations, data rates and antenna ports (if EUT with antenna diversity architecture).
- Following channel(s) was (were) selected for the final test as listed below.

EUT Configure Mode	Mode	Freq. Range (MHz)	Available Channel	Tested Channel	Modulation Technology
-	WLAN 2.4G, 802.11g	2412 ~ 2462	1 to 11	1	OFDM
-	WLAN 5G, 802.11n (HT40)	5180 ~ 5240	38 to 46	38	OFDM

Test Condition:

Applicable To	Environmental Conditions	Input Power	Tested by
RE \geq 1G	25 deg. C, 65 % RH	120 Vac, 60 Hz	Getaz Yang,
RE<1G	25 deg. C, 65 % RH	120 Vac, 60 Hz	Getaz Yang

3.3 Description of Support Units

Configuration of System under Test

For WLAN



Remote site

For WWAN

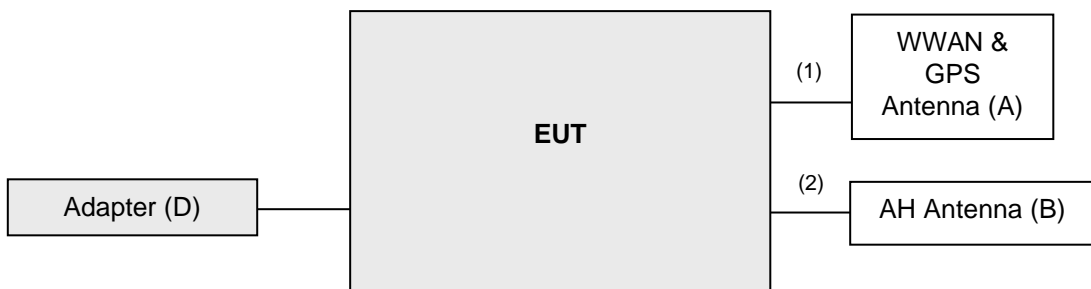

Remote site

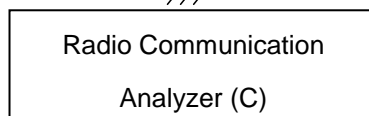

3.4 General Description of Applied Standards

The EUT is a RF Product. According to the specifications of the manufacturer, it must comply with the requirements of the following standards:

Test Standard:

FCC Part 15, Subpart C (15.247)

FCC Part 15, Subpart E (15.407)

FCC 47 CFR Part 2

FCC 47 CFR Part 22

FCC 47 CFR Part 24

FCC 47 CFR Part 27

ANSI 63.26-2015

All test items have been performed and recorded as per the above standards.

References Test Guidance:

KDB 558074 D01 Meas Guidance v05r02

KDB 789033 D02 General UNII Test Procedures New Rules v02r01

KDB 971168 D01 Power Meas License Digital Systems v03r01

ANSI/TIA/EIA-603-E 2016

All test items have been performed as a reference to the above KDB test guidance.

4 Test Types and Results

4.1 Radiated Emission Measurement

4.1.1 Limits of Radiated Emission Measurement

For WLAN & BT

Radiated emissions which fall in the restricted bands must comply with the radiated emission limits specified as below table. Other emissions shall be at least 20 dB below the highest level of the desired power:

Radiated emissions which fall in the restricted bands must comply with the radiated emission limits specified as below table.

Frequencies (MHz)	Field Strength (microvolts/meter)	Measurement Distance (meters)
0.009 ~ 0.490	2400/F (kHz)	300
0.490 ~ 1.705	24000/F (kHz)	30
1.705 ~ 30.0	30	30
30 ~ 88	100	3
88 ~ 216	150	3
216 ~ 960	200	3
Above 960	500	3

Note:

1. The lower limit shall apply at the transition frequencies.
2. Emission level (dBuV/m) = 20 log Emission level (uV/m).
3. For frequencies above 1000 MHz, the field strength limits are based on average detector, however, the peak field strength of any emission shall not exceed the maximum permitted average limits, specified above by more than 20 dB under any condition of modulation.

Limits of Unwanted Emission Out of the Restricted Bands

Applicable To		Limit	
789033 D02 General UNII Test Procedures New Rules v02r01		Field Strength at 3 m	
		PK: 74 (dBµV/m)	AV: 54 (dBµV/m)
Frequency Band	Applicable To	EIRP Limit	Equivalent Field Strength at 3 m
5150~5250 MHz	15.407(b)(1)	PK: -27 (dBm/MHz)	PK: 68.2 (dBµV/m)
5250~5350 MHz	15.407(b)(2)		
5470~5725 MHz	15.407(b)(3)		
5725~5850 MHz	<input checked="" type="checkbox"/> 15.407(b)(4)(i)	PK:-27 (dBm/MHz) *1 PK:10 (dBm/MHz) *2 PK:15.6 (dBm/MHz) *3 PK:27 (dBm/MHz) *4	PK: 68.2 (dBµV/m) *1 PK:105.2 (dBµV/m) *2 PK: 110.8 (dBµV/m) *3 PK:122.2 (dBµV/m) *4
	<input type="checkbox"/> 15.407(b)(4)(ii)	Emission limits in section 15.247(d)	
<p>*1 beyond 75 MHz or more above of the band edge.</p> <p>*2 below the band edge increasing linearly to 10 dBm/MHz at 25 MHz above.</p> <p>*3 below the band edge increasing linearly to a level of 15.6 dBm/MHz at 5 MHz above.</p> <p>*4 from 5 MHz above or below the band edge increasing linearly to a level of 27 dBm/MHz at the band edge.</p>			

Note:

The following formula is used to convert the equipment isotropic radiated power (eirp) to field strength:

$$E = \frac{1000000\sqrt{30P}}{3} \mu\text{V/m, where P is the eirp (Watts).$$

For WCDMA & LTE

The power of any emission outside of the authorized operating frequency ranges must be attenuated below the transmitting power (P) by a factor of at least 43 + 10 log(P) dB. The emission limit is equal to -13 dBm.

4.1.2 Test Instruments

Description & Manufacturer	Model No.	Serial No.	Date of Calibration	Due Date of Calibration
Test Receiver Agilent	N9038A	MY51210203	Mar. 18, 2020	Mar. 17, 2021
Spectrum Analyzer Agilent	N9010A	MY52220314	Dec. 12, 2019	Dec. 11, 2020
Spectrum Analyzer ROHDE & SCHWARZ	FSU43	101261	Apr. 16, 2020	Apr. 15, 2021
Broadband Horn Antenna SCHWARZBECK	BBHA 9170	148	Nov. 24, 2019	Nov. 23, 2020
HORN Antenna SCHWARZBECK	BBHA 9120D	9120D-969	Nov. 24, 2019	Nov. 23, 2020
BILOG Antenna SCHWARZBECK	VULB 9168	9168-472	Nov. 08, 2019	Nov. 07, 2020
Fixed Attenuator WOKEN	MDCS18N-10	MDCS18N-10-01	Apr. 14, 2020	Apr. 13, 2021
Loop Antenna	EM-6879	269	Sep. 17, 2020	Sep. 16, 2021
Preamplifier EMCI	EMC001340	980201	Oct. 21, 2020	Oct. 20, 2021
Preamplifier EMCI	EMC 012645	980115	Oct. 07, 2020	Oct. 06, 2021
Preamplifier EMCI	EMC 184045	980116	Oct. 07, 2020	Oct. 06, 2021
Preamplifier EMCI	EMC 330H	980112	Oct. 07, 2020	Oct. 06, 2021
Power Meter Anritsu	ML2495A	1012010	Sep. 01, 2020	Aug. 31, 2021
Power Sensor Anritsu	MA2411B	1315050	Sep. 01, 2020	Aug. 31, 2021
RF Coaxial Cable EMCI	EMC104-SM-SM-8000	180409	Jan. 18, 2020	Jan. 17, 2021
RF Coaxial Cable HUBER+SUHNNER	SUCOFLEX 104	EMC104-SM-SM-1000(140807)	Oct. 07, 2020	Oct. 06, 2021
RF Coaxial Cable WOKEN	8D-FB	Cable-Ch10-01	Oct. 07, 2020	Oct. 06, 2021
Boresight Antenna Fixture	FBA-01	FBA-SIP01	NA	NA
Software BV ADT	E3 6.120103	NA	NA	NA
Antenna Tower MF	MFA-440H	NA	NA	NA
Turn Table MF	MFT-201SS	NA	NA	NA
Antenna Tower & Turn Table Controller MF	MF-7802	NA	NA	NA

- Note: 1. The calibration interval of the above test instruments is 12 months and the calibrations are traceable to NML/ROC and NIST/USA.
2. The test was performed in HwaYa Chamber 10.

4.1.3 Test Procedures

For WLAN & BT

For Radiated Emission below 30 MHz

- a. The EUT was placed on the top of a rotating table 0.8 meters above the ground at a 3 meter chamber room. The table was rotated 360 degrees to determine the position of the highest radiation.
- b. The EUT was set 3 meters away from the interference-receiving antenna, which was mounted on the top of a variable-height antenna tower.
- c. Parallel, perpendicular, and ground-parallel orientations of the antenna are set to make the measurement.
- d. For each suspected emission, the EUT was arranged to its worst case and the rotatable table was turned from 0 degrees to 360 degrees to find the maximum reading.
- e. The test-receiver system was set to Quasi-Peak Detect Function and Specified Bandwidth with Maximum Hold Mode.

Note:

1. The resolution bandwidth and video bandwidth of test receiver/spectrum analyzer is 9 kHz at frequency below 30 MHz.

For Radiated Emission above 30 MHz

- a. The EUT was placed on the top of a rotating table 0.8 meters (for 30 MHz ~ 1 GHz) / 1.5 meters (for above 1 GHz) above the ground at 3 meter chamber room for test. The table was rotated 360 degrees to determine the position of the highest radiation.
- b. The EUT was set 3 meters away from the interference-receiving antenna, which was mounted on the top of a variable-height antenna tower.
- c. The height of antenna is varied from one meter to four meters above the ground to determine the maximum value of the field strength. Both horizontal and vertical polarizations of the antenna are set to make the measurement.
- d. For each suspected emission, the EUT was arranged to its worst case and then the antenna was tuned to heights from 1 meter to 4 meters and the rotatable table was turned from 0 degrees to 360 degrees to find the maximum reading.
- e. The test-receiver system was set to quasi-peak detect function and specified bandwidth with maximum hold mode when the test frequency is below 1 GHz.
- f. The test-receiver system was set to peak and average detected function and specified bandwidth with maximum hold mode when the test frequency is above 1 GHz. If the peak reading value also meets average limit, measurement with the average detector is unnecessary.

Note:

1. The resolution bandwidth and video bandwidth of test receiver/spectrum analyzer is 120 kHz for Quasi-peak detection (QP) or Peak detection (PK) at frequency below 1 GHz.
2. The resolution bandwidth of test receiver/spectrum analyzer is 1 MHz and the video bandwidth is 3 MHz for Peak detection (PK) at frequency above 1 GHz.
3. The resolution bandwidth of test receiver/spectrum analyzer is 1 MHz and the video bandwidth is $\geq 1/T$ (Duty cycle < 98 %) or 10 Hz (Duty cycle ≥ 98 %) for Average detection (AV) at frequency above 1 GHz.
4. All modes of operation were investigated and the worst-case emissions are reported.

For WCDMA & LTE

- a. Substitution method is used for E.I.R.P measurement. In the semi-anechoic chamber, EUT placed on the 0.8 m (below or equal 1 GHz) and/or 1.5 m (above 1 GHz) height of Turn Table, rotated the table around 360 degrees to search the maximum radiation power and receiver antenna shall be rotated vertical and horizontal polarization and moved height from 1 m to 4 m to find the maximum polar radiated power. The “Read Value” is the spectrum reading the maximum power value.
- b. EIRP = Output power level of S.G – TX cable loss + Antenna gain of substitution horn.
- c. E.R.P power can be calculated form E.I.R.P power by subtracting the gain of dipole, E.R.P power = E.I.R.P power - 2.15 dB.

Note:

1. The resolution bandwidth and video bandwidth of test receiver/spectrum analyzer is 1 MHz/3 MHz.
2. The emission levels were against the limit of frequency range 9 kHz ~ 30 MHz:
The amplitude of spurious emissions attenuated more than 20 dB below the permissible value is not required to be report.

4.1.4 Deviation from Test Standard

No deviation.

4.1.5 Test Set Up

<Radiated Emission below 30 MHz>

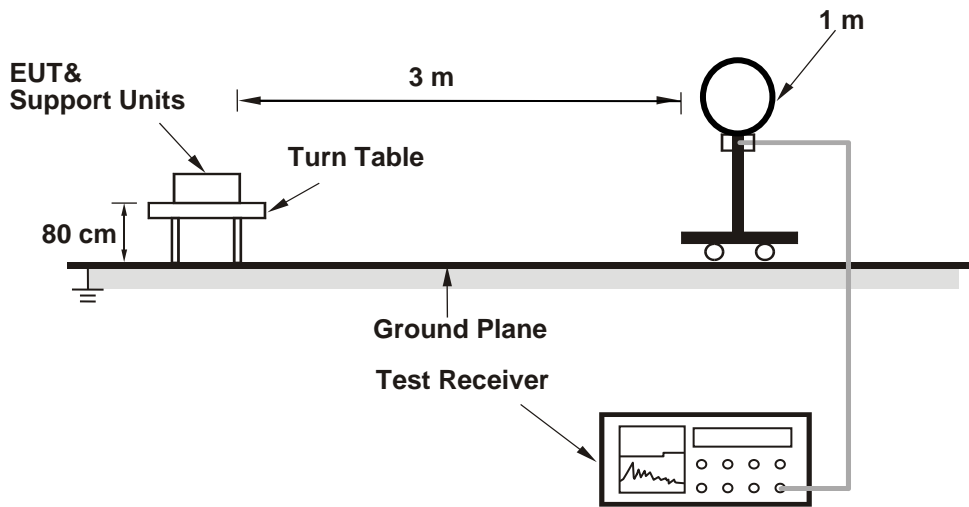

<Radiated Emission 30 MHz to 1 GHz>

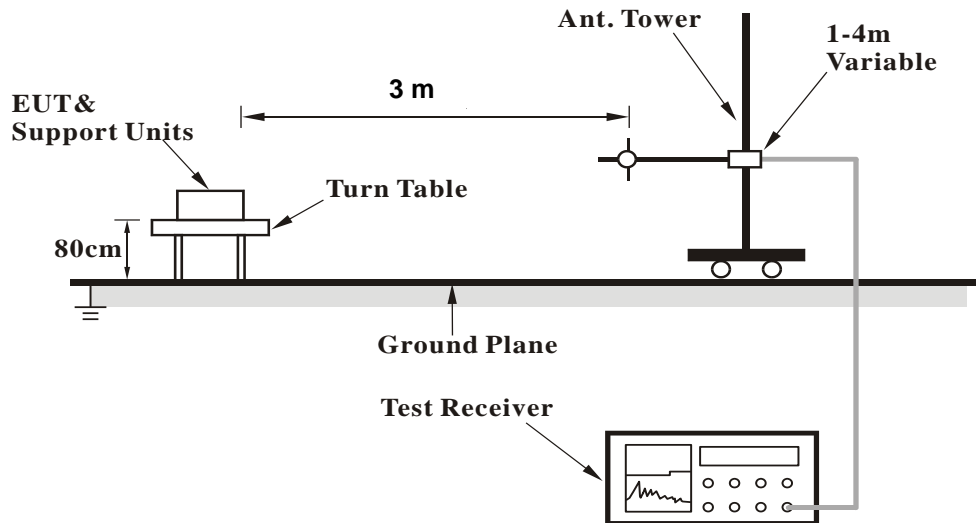

<Radiated Emission above 1 GHz>

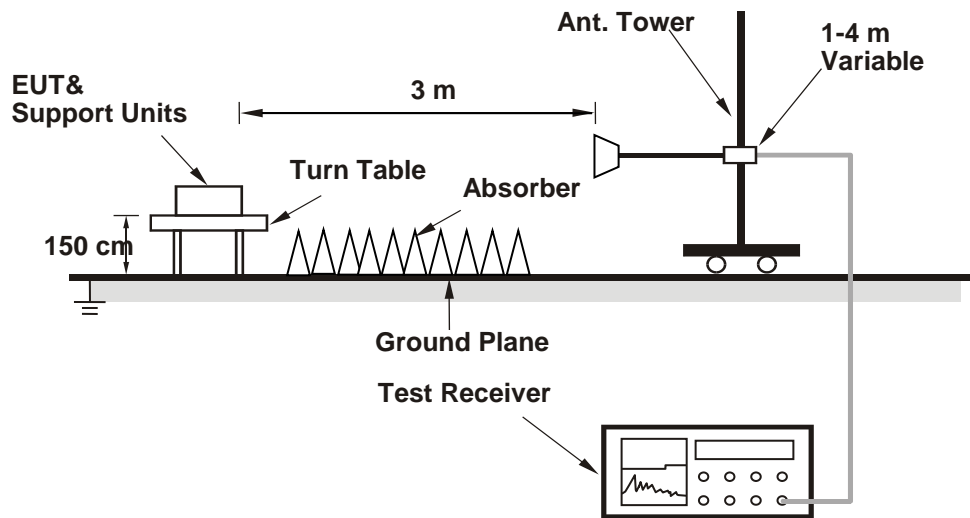

For the actual test configuration, please refer to the attached file (Test Setup Photo).

4.1.6 EUT Operating Conditions

- a. Placed the EUT on a testing table.
- b. Use the software to control the EUT under transmission condition continuously at specific channel frequency.

4.1.7 Test Results

Above 1 GHz Data :
802.11g + LTE Band 4

EUT Test Condition		Measurement Detail	
Channel	Channel 1	Frequency Range	1 GHz ~ 25 GHz
Input Power	120 Vac, 60 Hz	Detector Function	Peak (PK) Average (AV)
Environmental Conditions	25 deg. C, 65 % RH	Tested By	Getaz Yang

Horizontal

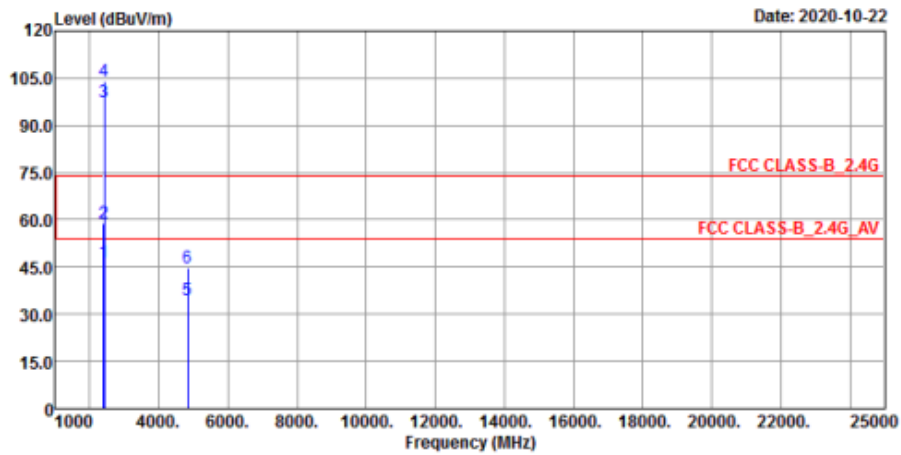

Vertical

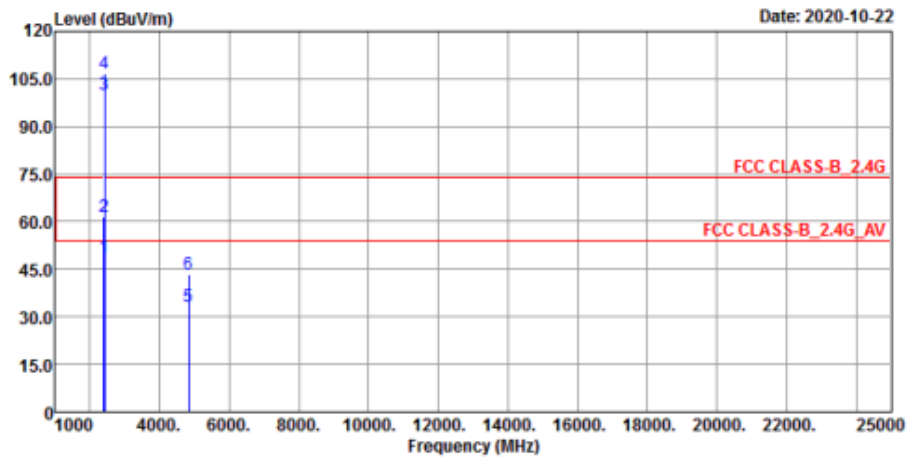

Antenna Polarity & Test Distance: Horizontal at 3 m

Frequency (MHz)	Emission Level (dBuV/m)	Read Level (dBuV)	Factor (dB/m)	Limit (dBuV/m)	Margin (dB)	Antenna Height (cm)	Table Angle (Degree)	Remark
2390	46.4	52.32	-5.92	54	-7.6	164	342	Average
2390	59.01	64.93	-5.92	74	-14.99	164	342	Peak
2412	97.44	103.39	-5.95	-----	-----	164	342	Average
2412	104.07	110.02	-5.95	-----	-----	164	342	Peak
4824	34.64	50.26	-15.62	54	-19.36	166	201	Average
4824	44.78	60.4	-15.62	74	-29.22	166	201	Peak

Antenna Polarity & Test Distance: Vertical at 3 m

Frequency (MHz)	Emission Level (dBuV/m)	Read Level (dBuV)	Factor (dB/m)	Limit (dBuV/m)	Margin (dB)	Antenna Height (cm)	Table Angle (Degree)	Remark
2390	48.86	54.78	-5.92	54	-5.14	102	4	Average
2390	61.34	67.26	-5.92	74	-12.66	102	4	Peak
2412	100.13	106.08	-5.95	-----	-----	102	4	Average
2412	106.71	112.66	-5.95	-----	-----	102	4	Peak
4824	33.41	49.03	-15.62	54	-20.59	177	134	Average
4824	43.61	59.23	-15.62	74	-30.39	177	134	Peak

Remarks:

- Emission Level = Read Level + Factor
Margin value = Emission level – Limit value
- 2412 MHz: Fundamental frequency.
- The emission levels of other frequencies were very low against the limit.

802.11n (HT40) + LTE Band 4

EUT Test Condition		Measurement Detail	
Channel	Channel 38	Frequency Range	1 GHz ~ 40 GHz
Input Power	120 Vac, 60 Hz	Detector Function	Peak (PK) Average (AV)
Environmental Conditions	25 deg. C, 65 % RH	Tested By	Getaz Yang

Horizontal

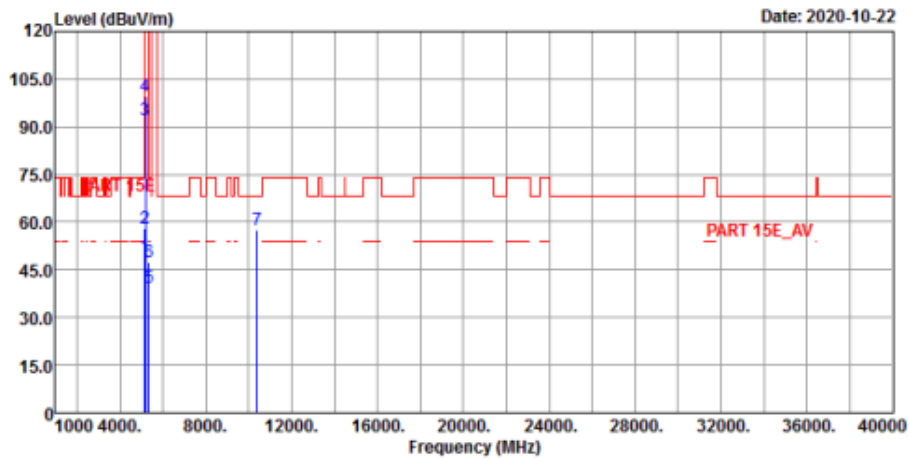

Vertical

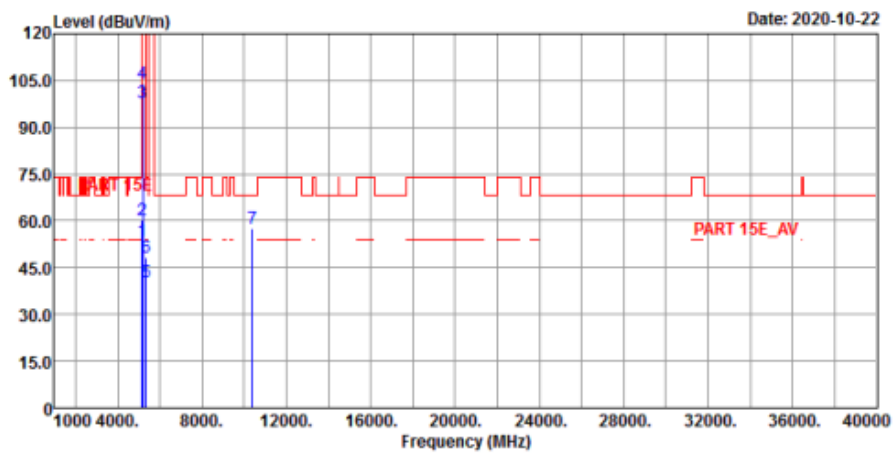

Antenna Polarity & Test Distance: Horizontal at 3 m

Frequency (MHz)	Emission Level (dBuV/m)	Read Level (dBuV)	Factor (dB/m)	Limit (dBuV/m)	Margin (dB)	Antenna Height (cm)	Table Angle (Degree)	Remark
5150	49.35	48.93	0.42	54	-4.65	118	98	Average
5150	57.83	57.41	0.42	74	-16.17	118	98	Peak
5190	92.09	91.89	0.2	-----	-----	118	98	Average
5190	99.46	99.26	0.2	-----	-----	118	98	Peak
5350	39.46	39.13	0.33	54	-14.54	118	98	Average
5350	47.17	46.84	0.33	74	-26.83	118	98	Peak
*10380	57.42	59.28	-1.86	68.2	-10.78	155	163	Peak

Antenna Polarity & Test Distance: Vertical at 3 m

Frequency (MHz)	Emission Level (dBuV/m)	Read Level (dBuV)	Factor (dB/m)	Limit (dBuV/m)	Margin (dB)	Antenna Height (cm)	Table Angle (Degree)	Remark
5150	53.57	53.15	0.42	54	-0.43	255	266	Average
5150	60.35	59.93	0.42	74	-13.65	255	266	Peak
5190	98.06	97.86	0.2	-----	-----	255	266	Average
5190	104.24	104.04	0.2	-----	-----	255	266	Peak
5350	40.22	39.89	0.33	54	-13.78	255	266	Average
5350	48.16	47.83	0.33	74	-25.84	255	266	Peak
*10380	57.57	59.43	-1.86	68.2	-10.63	192	162	Peak

Remarks:

- Emission Level = Read Level + Factor
Margin value = Emission level – Limit value
- 5190 MHz: Fundamental frequency.
- The emission levels of other frequencies were very low against the limit.
- *: Out of Restricted Band

LTE Band 4 + 802.11g



Bureau Veritas Consumer Products Services Ltd., Taoyuan Branch

A D T

Data: 5

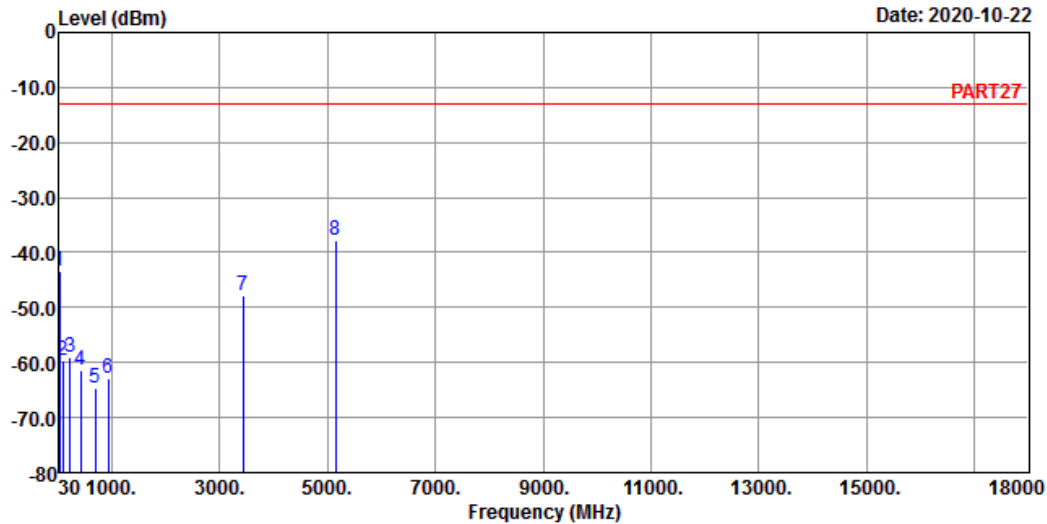

Site : 966 Chamber 5
 Condition: PART27 HORIZONTAL
 Remak : 11G_TX_CH01+
 : LTE Band 4 QPSK_20M Link_L-CH
 Tested by: Getaz Yang

	Freq	Level	Read Level	Limit	Line Factor	Over Limit	Remark
	MHz	dBm	dBm	dBm	dB	dB	
1	41.64	-43.32	-42.91	-13.00	-0.41	-30.32	Peak
2	93.05	-59.74	-48.79	-13.00	-10.95	-46.74	Peak
3	228.85	-59.15	-52.30	-13.00	-6.85	-46.15	Peak
4	419.94	-61.47	-55.68	-13.00	-5.79	-48.47	Peak
5	690.57	-64.57	-64.32	-13.00	-0.25	-51.57	Peak
6	931.13	-63.00	-64.34	-13.00	1.34	-50.00	Peak
7	3440.00	-47.88	-39.66	-13.00	-8.22	-34.88	Peak
8	5160.00	-37.82	-35.91	-13.00	-1.91	-24.82	Peak



Bureau Veritas Consumer Products Services Ltd., Taoyuan Branch

A D T

Data: 6

Date: 2020-10-22

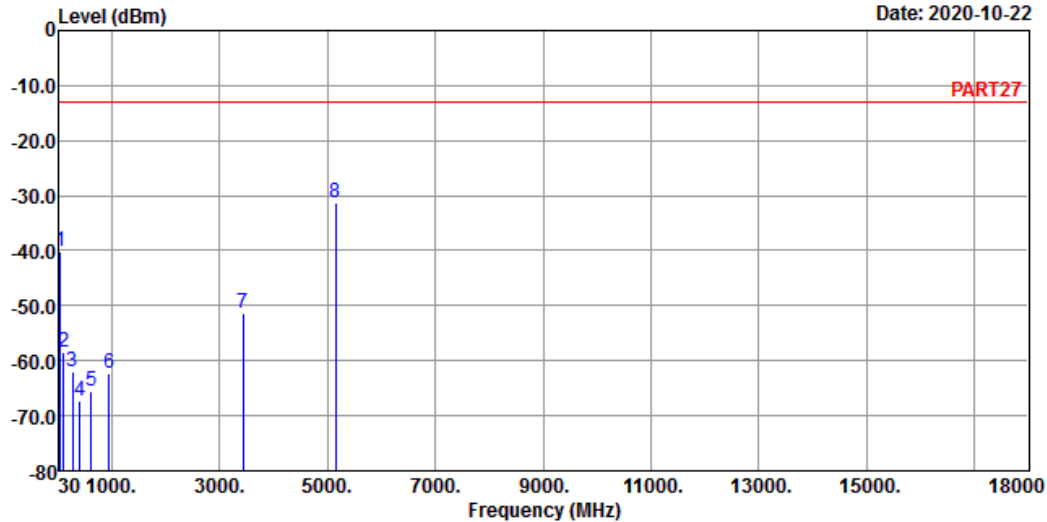

Site : 966 Chamber 5
 Condition: PART27 VERTICAL
 Remak : 11G_TX_CH01+
 : LTE Band 4 QPSK_20M Link_L-CH
 Tested by: Getaz Yang

	Freq	Level	Read Level	Limit Line	Over Factor	Over Limit	Remark
	MHz	dBm	dBm	dBm	dB	dB	
1	44.55	-40.13	-38.14	-13.00	-1.99	-27.13	Peak
2	105.66	-58.31	-47.89	-13.00	-10.42	-45.31	Peak
3	269.59	-62.13	-55.74	-13.00	-6.39	-49.13	Peak
4	406.36	-67.25	-61.36	-13.00	-5.89	-54.25	Peak
5	625.58	-65.48	-64.66	-13.00	-0.82	-52.48	Peak
6	960.23	-62.37	-64.55	-13.00	2.18	-49.37	Peak
7	3440.00	-51.22	-43.00	-13.00	-8.22	-38.22	Peak
8 pp	5160.00	-31.36	-29.45	-13.00	-1.91	-18.36	Peak

LTE Band 4 + 802.11n (HT40)



Bureau Veritas Consumer Products Services Ltd., Taoyuan Branch

A D T

Data: 5

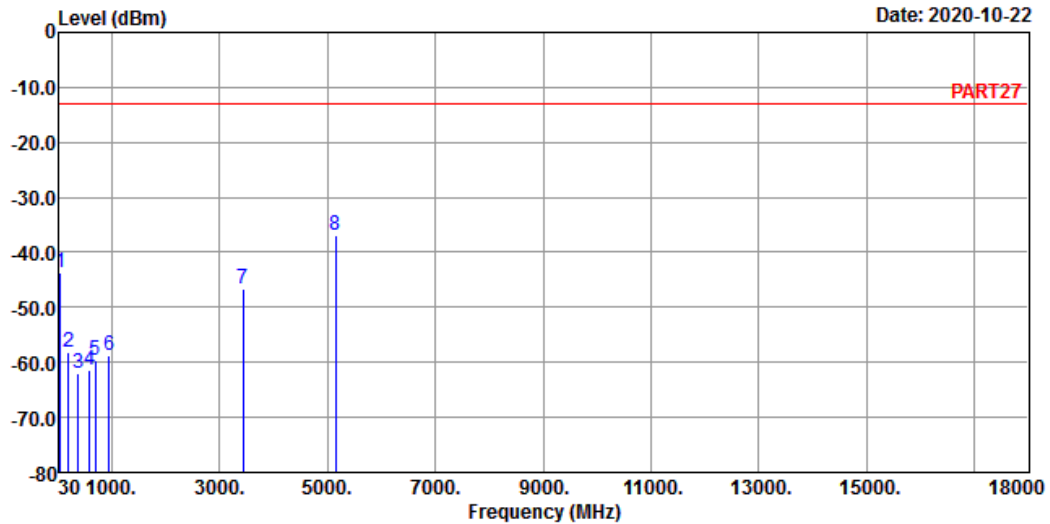

Site : 966 Chamber 5
 Condition: PART27 HORIZONTAL
 Remak : 11N_HT40_TX_CH38+
 : LTE Band 4 QPSK_20M Link_L-CH
 Tested by: Getaz Yang

	Freq	Level	Read Level	Limit	Line Factor	Over Limit	Remark
	MHz	dBm	dBm	dBm	dB	dB	
1	43.58	-43.84	-42.37	-13.00	-1.47	-30.84	Peak
2	207.51	-58.10	-50.39	-13.00	-7.71	-45.10	Peak
3	385.02	-61.99	-55.96	-13.00	-6.03	-48.99	Peak
4	592.60	-61.46	-60.38	-13.00	-1.08	-48.46	Peak
5	690.57	-59.57	-59.32	-13.00	-0.25	-46.57	Peak
6	958.29	-58.78	-60.89	-13.00	2.11	-45.78	Peak
7	3440.00	-46.71	-38.49	-13.00	-8.22	-33.71	Peak
8 pp	5160.00	-36.79	-34.88	-13.00	-1.91	-23.79	Peak



Bureau Veritas Consumer Products Services Ltd., Taoyuan Branch

A D T

Data: 6

Date: 2020-10-22

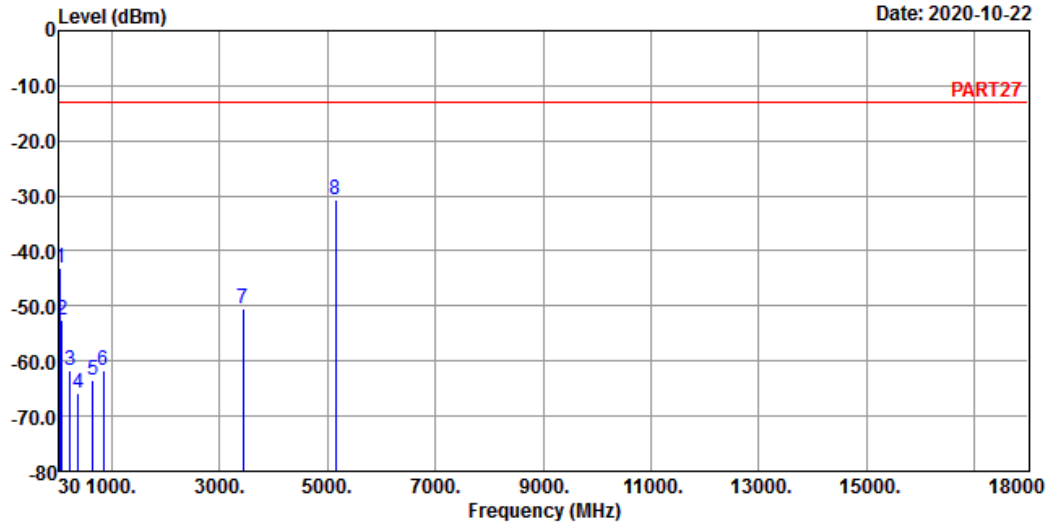

Site : 966 Chamber 5
 Condition: PART27 VERTICAL
 Remak : 11N_HT40_TX_CH38+
 : LTE Band 4 QPSK_20M Link_L-CH
 Tested by: Getaz Yang

	Freq	Level	Read Level	Limit Line	Over Factor	Over Limit	Remark
	MHz	dBm	dBm	dBm	dB	dB	
1	44.55	-43.13	-41.14	-13.00	-1.99	-30.13	Peak
2	84.32	-52.50	-41.53	-13.00	-10.97	-39.50	Peak
3	228.85	-61.81	-54.96	-13.00	-6.85	-48.81	Peak
4	379.20	-65.78	-59.71	-13.00	-6.07	-52.78	Peak
5	645.95	-63.61	-62.74	-13.00	-0.87	-50.61	Peak
6	848.68	-61.81	-62.11	-13.00	0.30	-48.81	Peak
7	3440.00	-50.43	-42.21	-13.00	-8.22	-37.43	Peak
8 pp	5160.00	-30.57	-28.66	-13.00	-1.91	-17.57	Peak

9 kHz ~ 30 MHz Data:

The amplitude of spurious emissions attenuated more than 20 dB below the permissible value is not required to be report.

30 MHz ~ 1 GHz Worst-Case Data:

WLAN 2.4G

EUT Test Condition		Measurement Detail	
Channel	Channel 1	Frequency Range	30 MHz ~ 1 GHz
Input Power	120 Vac, 60 Hz	Detector Function	Peak (PK) Quasi-peak (QP)
Environmental Conditions	25 deg. C, 65 % RH	Tested By	Getaz Yang

Antenna Polarity & Test Distance: Horizontal at 3 m								
Frequency (MHz)	Emission Level (dBuV/m)	Read Level (dBuV)	Factor (dB/m)	Limit (dBuV/m)	Margin (dB)	Antenna Height (cm)	Table Angle (Degree)	Remark
43.58	30.99	42.91	-11.92	40	-9.01	115	268	QP
136.7	27.45	39.76	-12.31	43.5	-16.05	100	334	QP
220.12	31.69	46.72	-15.03	46	-14.31	140	259	QP
346.22	34.61	44.49	-9.88	46	-11.39	133	0	QP
480.08	30.42	36.23	-5.81	46	-15.58	111	15	QP
877.78	35.5	32.73	2.77	46	-10.5	130	111	QP
Antenna Polarity & Test Distance: Vertical at 3 m								
Frequency (MHz)	Emission Level (dBuV/m)	Read Level (dBuV)	Factor (dB/m)	Limit (dBuV/m)	Margin (dB)	Antenna Height (cm)	Table Angle (Degree)	Remark
46.49	30.91	42.68	-11.77	40	-9.09	138	277	QP
144.46	33.35	45.19	-11.84	43.5	-10.15	129	308	QP
376.29	32.01	40.83	-8.82	46	-13.99	101	342	QP
500.45	36.31	41.75	-5.44	46	-9.69	115	192	QP
644.98	39.94	41.57	-1.63	46	-6.06	130	58	QP
899.12	42.73	39.77	2.96	46	-3.27	116	79	QP

Remarks:

- Emission Level = Read Level + Factor
Margin value = Emission level – Limit value
- The emission levels of other frequencies were very low against the limit

Horizontal

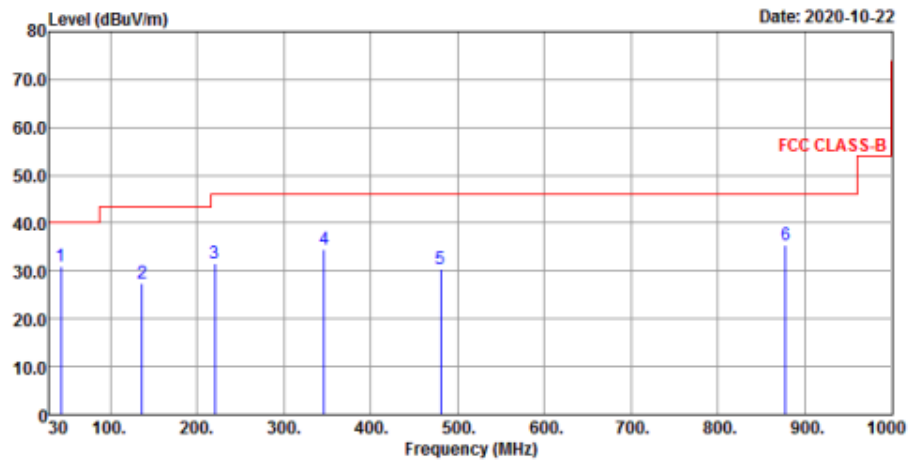

Vertical

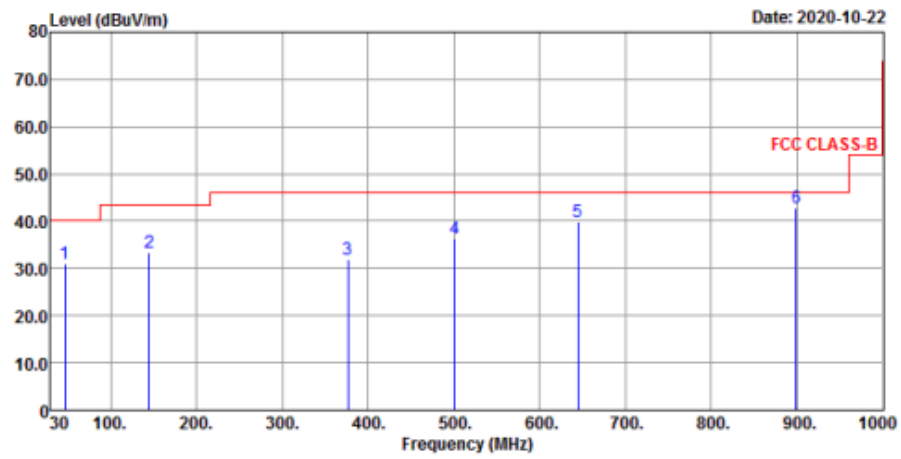

WLAN 5G

EUT Test Condition		Measurement Detail	
Channel	Channel 38	Frequency Range	30 MHz ~ 1 GHz
Input Power	120 Vac, 60 Hz	Detector Function	Peak (PK) Quasi-peak (QP)
Environmental Conditions	25 deg. C, 65 % RH	Tested By	Getaz Yang

Antenna Polarity & Test Distance: Horizontal at 3 m								
Frequency (MHz)	Emission Level (dBuV/m)	Read Level (dBuV)	Factor (dB/m)	Limit (dBuV/m)	Margin (dB)	Antenna Height (cm)	Table Angle (Degree)	Remark
40.67	27.9	39.96	-12.06	40	-12.1	126	149	QP
118.27	26.04	39.99	-13.95	43.5	-17.46	137	276	QP
288.02	29.88	41.37	-11.49	46	-16.12	127	137	QP
408.3	29.31	37.45	-8.14	46	-16.69	132	359	QP
576.11	32.2	35.74	-3.54	46	-13.8	120	276	QP
877.78	34.5	31.73	2.77	46	-11.5	109	248	QP
Antenna Polarity & Test Distance: Vertical at 3 m								
Frequency (MHz)	Emission Level (dBuV/m)	Read Level (dBuV)	Factor (dB/m)	Limit (dBuV/m)	Margin (dB)	Antenna Height (cm)	Table Angle (Degree)	Remark
43.58	28.82	40.74	-11.92	40	-11.18	119	347	QP
113.42	33.21	47.62	-14.41	43.5	-10.29	133	49	QP
305.48	32.36	43.33	-10.97	46	-13.64	116	289	QP
499.48	36.87	42.33	-5.46	46	-9.13	126	17	QP
644.98	37.94	39.57	-1.63	46	-8.06	109	246	QP
855.47	38.58	36.07	2.51	46	-7.42	119	147	QP

Remarks:

- Emission Level = Read Level + Factor
Margin value = Emission level – Limit value
- The emission levels of other frequencies were very low against the limit

Horizontal

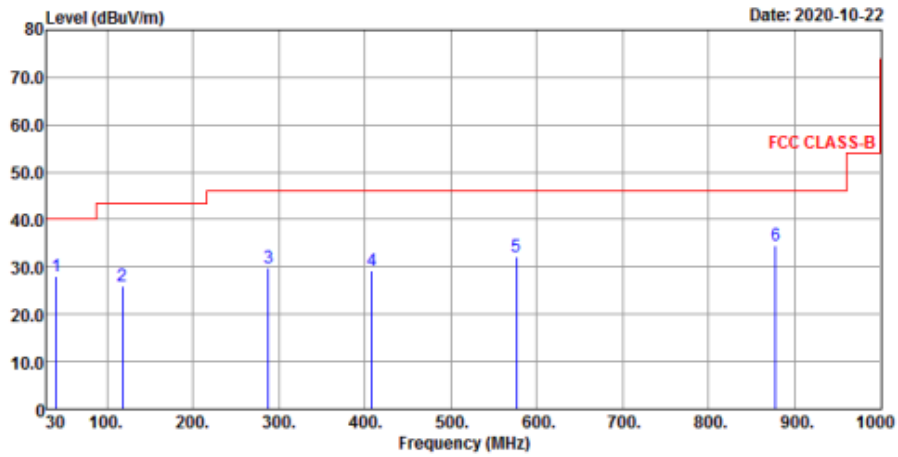

Vertical

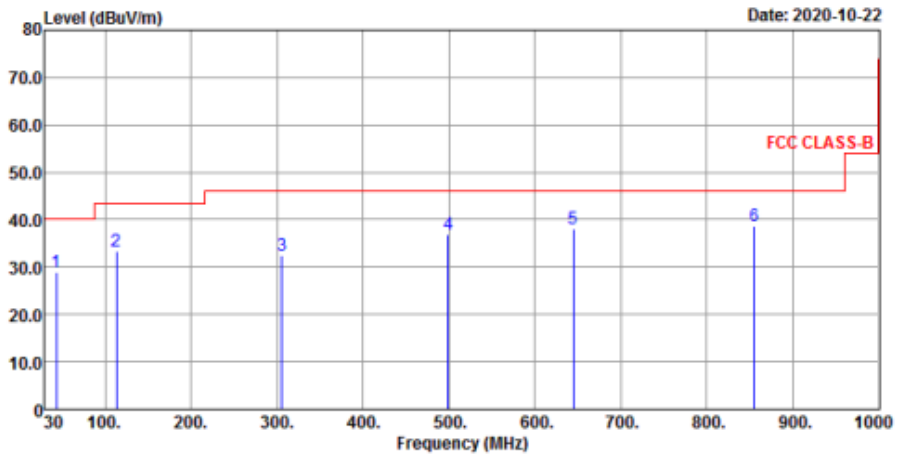

5 Pictures of Test Arrangements

Please refer to the attached file (Test Setup Photo).

Appendix – Information of the Testing Laboratories

We, Bureau Veritas Consumer Products Services (H.K.) Ltd., Taoyuan Branch, were founded in 1988 to provide our best service in EMC, Radio, Telecom and Safety consultation. Our laboratories are FCC recognized accredited test firms and accredited according to ISO/IEC 17025.

If you have any comments, please feel free to contact us at the following:

Lin Kou EMC/RF Lab

Tel: 886-2-26052180

Fax: 886-2-26051924

Hsin Chu EMC/RF/Telecom Lab

Tel: 886-3-6668565

Fax: 886-3-6668323

Hwa Ya EMC/RF/Safety Lab

Tel: 886-3-3183232

Fax: 886-3-3270892

Email: service.adt@tw.bureauveritas.com

Web Site: www.bureauveritas-adt.com

The address and road map of all our labs can be found in our web site also.

--- END ---