

FCC Test Report

(PART 24)

Report No.: RFBGSN-WTW-P20080589-1

FCC ID: NKS-PA1

Test Model: Trimble Gateway-PA1

Received Date: Aug. 29, 2020

Test Date: Sep. 23, 2020 ~ Oct. 19, 2020

Issued Date: Oct. 28, 2020

Applicant: PeopleNet Communications Corporation

Address: 4400 Baker Road, Minnetonka Minnesota 55343-8684 United States

Issued By: Bureau Veritas Consumer Products Services (H.K.) Ltd., Taoyuan Branch
Lin Kou Laboratories

Lab Address: No. 47-2, 14th Ling, Chia Pau Vil., Lin Kou Dist., New Taipei City, Taiwan

Test Location: No.19, Hwa Ya 2nd Rd., Wen Hwa Vil., Kwei Shan Dist., Taoyuan City
33383, Taiwan

**FCC Registration /
Designation Number:** 788550 / TW0003



This report is for your exclusive use. Any copying or replication of this report to or for any other person or entity, or use of our name or trademark, is permitted only with our prior written permission. This report sets forth our findings solely with respect to the test samples identified herein. The results set forth in this report are not indicative or representative of the quality or characteristics of the lot from which a test sample was taken or any similar or identical product unless specifically and expressly noted. Our report includes all of the tests requested by you and the results thereof based upon the information that you provided to us. You have 60 days from date of issuance of this report to notify us of any material error or omission caused by our negligence, provided, however, that such notice shall be in writing and shall specifically address the issue you wish to raise. A failure to raise such issue within the prescribed time shall constitute your unqualified acceptance of the completeness of this report, the tests conducted and the correctness of the report contents. Unless specific mention, the uncertainty of measurement has been explicitly taken into account to declare the compliance or non-compliance to the specification.

Table of Contents

Release Control Record	4
1 Certificate of Conformity	5
2 Summary of Test Results	6
2.1 Measurement Uncertainty	6
2.2 Test Site and Instruments	7
3 General Information	8
3.1 General Description of EUT	8
3.2 Configuration of System under Test	10
3.2.1 Description of Support Units	10
3.3 Test Mode Applicability and Tested Channel Detail	11
3.4 EUT Operating Conditions	14
3.5 General Description of Applied Standards and references	14
4 Test Types and Results	15
4.1 Output Power Measurement	15
4.1.1 Limits of Output Power Measurement	15
4.1.2 Test Procedures	15
4.1.3 Test Setup	16
4.1.4 Test Results	17
4.2 Modulation Characteristics Measurement	27
4.2.1 Limits of Modulation Characteristics	27
4.2.2 Test Setup	27
4.2.3 Test Procedure	27
4.2.4 Test Results	27
4.3 Frequency Stability Measurement	28
4.3.1 Limits of Frequency Stability Measurement	28
4.3.2 Test Procedure	28
4.3.3 Test Setup	28
4.3.4 Test Results	29
4.4 Occupied Bandwidth Measurement	36
4.4.1 Test Procedure	36
4.4.2 Test Setup	36
4.4.3 Test Result	36
4.5 Band Edge Measurement	40
4.5.1 Limits of Band Edge Measurement	40
4.5.2 Test Setup	40
4.5.3 Test Procedures	40
4.5.4 Test Results	41
4.6 Peak to Average Ratio	47
4.6.1 Limits of Peak to Average Ratio Measurement	47
4.6.2 Test Setup	47
4.6.3 Test Procedures	47
4.6.4 Test Results	47
4.7 Conducted Spurious Emissions	51
4.7.1 Limits of Conducted Spurious Emissions Measurement	51
4.7.2 Test Setup	51
4.7.3 Test Procedure	51
4.7.4 Test Results	52
4.8 Radiated Emission Measurement	59
4.8.1 Limits of Radiated Emission Measurement	59
4.8.2 Test Procedure	59
4.8.3 Deviation from Test Standard	59
4.8.4 Test Setup	60
4.8.5 Test Results	61

5 Pictures of Test Arrangements.....	109
Appendix – Information of the Testing Laboratories	110

Release Control Record

Issue No.	Description	Date Issued
RFBGSN-WTW-P20080589-1	Original Release	Oct. 28, 2020

1 Certificate of Conformity

Product: Trimble Gateway NA

Brand: Trimble

Test Model: Trimble Gateway-PA1

Sample Status: Engineering Sample

Applicant: PeopleNet Communications Corporation

Test Date: Sep. 23, 2020 ~ Oct. 19, 2020

Standards: FCC Part 24, Subpart E

The above equipment has been tested by **Bureau Veritas Consumer Products Services (H.K.) Ltd., Taoyuan Branch**, and found compliance with the requirement of the above standards. The test record, data evaluation & Equipment Under Test (EUT) configurations represented herein are true and accurate accounts of the measurements of the sample's RF characteristics under the conditions specified in this report.

Prepared by : , **Date:** Oct. 28, 2020
Vera Huang / Specialist

Approved by : , **Date:** Oct. 28, 2020
Dylan Chiou / Senior Project Engineer

2 Summary of Test Results

Applied Standard: FCC Part 24 & Part 2			
FCC Clause	Test Item	Result	Remarks
2.1046 24.232	Effective Isotropic Radiated Power	Pass	Meet the requirement of limit.
2.1047	Modulation Characteristics	Pass	Meet the requirement.
24.232(d)	Peak to Average Ratio	Pass	Meet the requirement of limit.
2.1055 24.235	Frequency Stability	Pass	Meet the requirement of limit.
2.1049	Occupied Bandwidth	Pass	Meet the requirement of limit.
24.238	Band Edge Measurements	Pass	Meet the requirement of limit.
2.1051 24.238	Conducted Spurious Emissions	Pass	Meet the requirement of limit.
2.1053 24.238	Radiated Spurious Emissions	Pass	Meet the requirement of limit. Minimum passing margin is -18.46 dB at 5700.00 MHz.

Note: Determining compliance based on the results of the compliance measurement, not taking into account measurement instrumentation uncertainty.

2.1 Measurement Uncertainty

Where relevant, the following measurement uncertainty levels have been estimated for tests performed on the EUT as specified in CISPR 16-4-2:

Measurement	Frequency	Expanded Uncertainty (k=2) (\pm)
Radiated Emissions up to 1 GHz	9 kHz ~ 30 MHz	3.04 dB
	30 MHz ~ 200 MHz	2.93 dB
	200 MHz ~ 1000 MHz	2.95 dB
Radiated Emissions above 1 GHz	1 GHz ~ 18 GHz	2.26 dB
	18 GHz ~ 40 GHz	1.94 dB

2.2 Test Site and Instruments

Description & Manufacturer	Model No.	Serial No.	Date of Calibration	Due Date of Calibration
Test Receiver Agilent	N9038A	MY51210203	Mar. 18, 2020	Mar. 17, 2021
Spectrum Analyzer Agilent	N9010A	MY52220314	Dec. 12, 2019	Dec. 11, 2020
Spectrum Analyzer ROHDE & SCHWARZ	FSU43	101261	Apr. 16, 2020	Apr. 15, 2021
HORN Antenna SCHWARZBECK	BBHA 9120D	9120D-969	Nov. 24, 2019	Nov. 23, 2020
BILOG Antenna SCHWARZBECK	VULB 9168	9168-472	Nov. 08, 2019	Nov. 07, 2020
Fixed Attenuator WOKEN	MDCS18N-10	MDCS18N-10-01	Apr. 14, 2020	Apr. 13, 2021
HORN Antenna SCHWARZBECK	9120D	9120D-1169	Nov. 24, 2019	Nov. 23, 2020
MXG Vector signal generator Agilent	N5182B	MY53050430	Oct. 25, 2019	Oct. 24, 2020
Preamplifier EMCI	EMC001340	980201	Oct. 14, 2019	Oct. 13, 2020
			Oct. 21, 2020	Oct. 20, 2021
Preamplifier EMCI	EMC 012645	980115	Oct. 08, 2019	Oct. 07, 2020
			Oct. 07, 2020	Oct. 06, 2021
Preamplifier EMCI	EMC 330H	980112	Oct. 08, 2019	Oct. 07, 2020
			Oct. 07, 2020	Oct. 06, 2021
RF Coaxial Cable EMCI	EMC104-SM-SM-8000	180409	Jan. 18, 2020	Jan. 17, 2021
RF Coaxial Cable HUBER+SUHNNER	SUCOFLEX 104	EMC104-SM-SM-1000(140807)	Oct. 08, 2019	Oct. 07, 2020
			Oct. 07, 2020	Oct. 06, 2021
RF Coaxial Cable WOKEN	8D-FB	Cable-Ch10-01	Oct. 08, 2019	Oct. 07, 2020
			Oct. 07, 2020	Oct. 06, 2021
Boresight Antenna Fixture	FBA-01	FBA-SIP01	NA	NA
Software BV ADT	E3 6.120103	NA	NA	NA
Antenna Tower MF	MFA-440H	NA	NA	NA
Turn Table MF	MFT-201SS	NA	NA	NA
Antenna Tower & Turn Table Controller MF	MF-7802	NA	NA	NA
Communications Tester- Wireless Agilent	8960 Series 10	MY53201073	Jul. 01, 2019	Jun. 30, 2021
Radio Communication Analyzer Anritsu	MT8820C	6201300640	Aug. 19, 2019	Aug. 18, 2021
Radio Communication Analyzer Anritsu	MT8821C	6201462755	Feb. 13, 2020	Feb. 12, 2021
Temperature & Humidity Chamber	GTH-120-40-CP-AR	MAA1306-019	Sep. 09, 2020	Sep. 08, 2021
DC Power Supply Topward	33010D	807748	NA	NA

Note: 1. The calibration interval of the above test instruments is 12 / 24 months and the calibrations are traceable to NML/ROC and NIST/USA.

2. The test was performed in HwaYa Chamber 10.

3 General Information

3.1 General Description of EUT

Product	Trimble Gateway NA	
Brand	Trimble	
Test Model	Trimble Gateway-PA1	
Status of EUT	Engineering Sample	
Power Supply Rating	12 Vdc (adapter)	
Modulation Type	WCDMA	QPSK
	LTE	QPSK, 16QAM
Frequency Range	WCDMA	1852.4 ~ 1907.6 MHz
	LTE Band 2 (Channel Bandwidth: 1.4 MHz)	1850.7 ~ 1909.3 MHz
	LTE Band 2 (Channel Bandwidth: 3 MHz)	1851.5 ~ 1908.5 MHz
	LTE Band 2 (Channel Bandwidth: 5 MHz)	1852.5 ~ 1907.5 MHz
	LTE Band 2 (Channel Bandwidth: 10 MHz)	1855.0 ~ 1905.0 MHz
	LTE Band 2 (Channel Bandwidth: 15 MHz)	1857.5 ~ 1902.5 MHz
	LTE Band 2 (Channel Bandwidth: 20 MHz)	1860.0 ~ 1900.0 MHz
Max. EIRP Power (Mode A)	WCDMA	452.90 mW
	LTE Band 2 (Channel Bandwidth: 1.4 MHz)	374.97 mW
	LTE Band 2 (Channel Bandwidth: 3 MHz)	377.57 mW
	LTE Band 2 (Channel Bandwidth: 5 MHz)	391.74 mW
	LTE Band 2 (Channel Bandwidth: 10 MHz)	406.44 mW
	LTE Band 2 (Channel Bandwidth: 15 MHz)	414.95 mW
	LTE Band 2 (Channel Bandwidth: 20 MHz)	424.62 mW
Max. EIRP Power (Mode B)	WCDMA	326.59 mW
	LTE Band 2 (Channel Bandwidth: 1.4 MHz)	271.02 mW
	LTE Band 2 (Channel Bandwidth: 3 MHz)	272.90 mW
	LTE Band 2 (Channel Bandwidth: 5 MHz)	283.14 mW
	LTE Band 2 (Channel Bandwidth: 10 MHz)	293.09 mW
	LTE Band 2 (Channel Bandwidth: 15 MHz)	294.44 mW
	LTE Band 2 (Channel Bandwidth: 20 MHz)	308.32 mW
Emission Designator	WCDMA	4M16F9W
	LTE Band 2 (Channel Bandwidth: 1.4 MHz)	1M09D7W
	LTE Band 2 (Channel Bandwidth: 3 MHz)	2M71D7W
	LTE Band 2 (Channel Bandwidth: 5 MHz)	4M50D7W
	LTE Band 2 (Channel Bandwidth: 10 MHz)	8M97D7W
	LTE Band 2 (Channel Bandwidth: 15 MHz)	13M4G7D
	LTE Band 2 (Channel Bandwidth: 20 MHz)	17M9G7D
Antenna Type	Refer to Note as below	
Accessory Device	N/A	
Data Cable Supplied	N/A	

Note:

1. The information of module collocated in this EUT is listed as below.

Product	Brand	Model
BT/WLAN Module	msi	BM25
WWAN Module	Quectel	EC25-A
AH Module	silex	SX-NEWAH

2. The antenna information is listed as below.

Ant.	Brand	Model	Antenna Type	Antenna Gain (dBi)	Remark
1	TAOGLAS	PCS.06.A	SMD Antenna	3.58	Internal, Main Antenna
2	TAOGLAS	PCS.06.B	SMD Antenna	3.81	Internal, Aux. Antenna
3	TAOGLAS	MA240.LBI.001	Adhesive Mount Combination Antenna	2.51	External, Main Antenna
4	TAOGLAS	MA240.LBI.001	Adhesive Mount Combination Antenna	1.77	External, Aux. Antenna

3. The above Antenna information is declared by manufacturer and for more detailed features description, please refer to the manufacturer's specifications, the laboratory shall not be held responsible.

4. The above EUT information is declared by manufacturer and for more detailed features description, please refers to the manufacturer's specifications or user's manual.

3.2 Configuration of System under Test

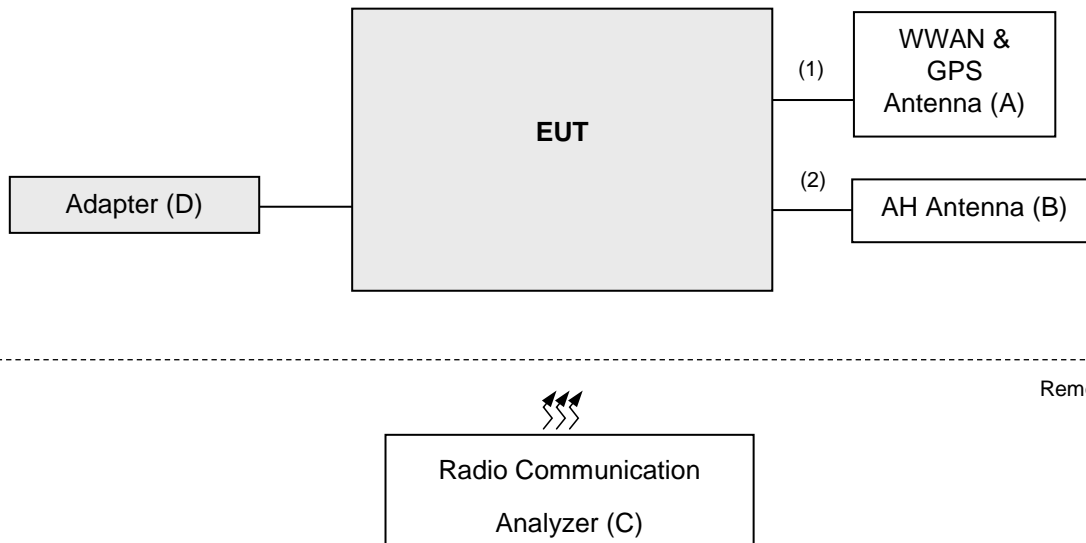

3.2.1 Description of Support Units

The EUT has been tested as an independent unit together with other necessary accessories or support units. The following support units or accessories were used to form a representative test configuration during the tests.

ID	Product	Brand	Model No.	Serial No.	FCC ID	Remarks
A	WWAN & GPS Antenna	TAOGLAS	MA240.LBI.001	NA	NA	Provided by client
B	AH Antenna	TAOGLAS	IS.05.B.301111	NA	NA	Provided by client
C	Radio Communication Analyzer	ANRITSU	MT8821C	6201462755	NA	--
D	Adapter	TPT	PMW120300W8	NA	NA	Provided by client AC Input: 100-240V~, 50-60Hz, 1.1A MAX DC Output: 12V, 3.0A

Note:

1. All power cords of the above support units are non-shielded (1.8m).
2. Item C acted as a communication partner to transfer data.

ID	Descriptions	Qty.	Length (m)	Shielding (Yes/No)	Cores (Qty.)	Remarks
1.	RF Cable	3	3	N	0	-
2.	RF Cable	1	3	N	0	-

3.3 Test Mode Applicability and Tested Channel Detail

Pre-Scan has been conducted to determine the worst-case mode from all possible combinations between available modulations, data rates, XYZ axis, and antenna ports.

The worst case was found when positioned as the table below. Following channel(s) was (were) selected for the final test as listed below:

EUT Configure Mode	Description
A	EUT + Antenna 1 & 2
B	EUT + Antenna 3 & 4

Band	EUT Configure Mode	ERP	Radiated Emission
WCDMA	A	Y-plane	Y-axis
	B	Z-plane	Z-axis
LTE	A	Y-plane	Y-axis
	B	X-plane	X-axis

WCDMA

EUT Configure Mode	Test Item	Available Channel	Tested Channel	Mode
A, B	EIRP	9262 to 9538	9262, 9400, 9538	WCDMA
-	Modulation Characteristics	9262 to 9538	9400	WCDMA
-	Frequency Stability	9262 to 9538	9262, 9538	WCDMA
-	Occupied Bandwidth	9262 to 9538	9262, 9400, 9538	WCDMA
-	Band Edge	9262 to 9538	9262, 9538	WCDMA
-	Peak to Average Ratio	9262 to 9538	9262, 9400, 9538	WCDMA
-	Conducted Emission	9262 to 9538	9262, 9400, 9538	WCDMA
A, B	Radiated Emission	9262 to 9538	9262, 9400, 9538	WCDMA

Note:

1. This device was tested under all modulations. The worst case of conducted output power was found in WCDMA modulation. Therefore, all test items were performed under WCDMA mode only.
2. For radiated emissions below 1 GHz, select the worst radiated emission channel (above 1GHz) for final testing.

LTE Band 2

EUT Configure Mode	Test Item	Available Channel	Tested Channel	Channel Bandwidth	Modulation	Mode
A, B	EIRP	18607 to 19193	18607, 18900, 19193	1.4 MHz	QPSK, 16QAM	1 RB / 0 RB Offset
		18615 to 19185	18615, 18900, 19185	3 MHz	QPSK, 16QAM	1 RB / 0 RB Offset
		18625 to 19175	18625, 18900, 19175	5 MHz	QPSK, 16QAM	1 RB / 0 RB Offset
		18650 to 19150	18650, 18900, 19150	10 MHz	QPSK, 16QAM	1 RB / 0 RB Offset
		18675 to 19125	18675, 18900, 19125	15 MHz	QPSK, 16QAM	1 RB / 0 RB Offset
		18700 to 19100	18700, 18900, 19100	20 MHz	QPSK, 16QAM	1 RB / 0 RB Offset
-	Modulation Characteristics	18700 to 19100	18900	20 MHz	QPSK, 16QAM	100 RB / 0 RB Offset
-	Frequency Stability	18607 to 19193	18607, 19193	1.4 MHz	QPSK	6 RB / 0 RB Offset
		18615 to 19185	18615, 19185	3 MHz	QPSK	15 RB / 0 RB Offset
		18625 to 19175	18625, 19175	5 MHz	QPSK	25 RB / 0 RB Offset
		18650 to 19150	18650, 19150	10 MHz	QPSK	50 RB / 0 RB Offset
		18675 to 19125	18675, 19125	15 MHz	QPSK	75 RB / 0 RB Offset
		18700 to 19100	18700, 19100	20 MHz	QPSK	100 RB / 0 RB Offset
-	Occupied Bandwidth	18607 to 19193	18607, 18900, 19193	1.4 MHz	QPSK, 16QAM	6 RB / 0 RB Offset
		18615 to 19185	18615, 18900, 19185	3 MHz	QPSK, 16QAM	15 RB / 0 RB Offset
		18625 to 19175	18625, 18900, 19175	5 MHz	QPSK, 16QAM	25 RB / 0 RB Offset
		18650 to 19150	18650, 18900, 19150	10 MHz	QPSK, 16QAM	50 RB / 0 RB Offset
		18675 to 19125	18675, 18900, 19125	15 MHz	QPSK, 16QAM	75 RB / 0 RB Offset
		18700 to 19100	18700, 18900, 19100	20 MHz	QPSK, 16QAM	100 RB / 0 RB Offset
-	Peak to Average Ratio	18607 to 19193	18607, 18900, 19193	1.4 MHz	QPSK, 16QAM	1 RB / 0 RB Offset
		18615 to 19185	18615, 18900, 19185	3 MHz	QPSK, 16QAM	1 RB / 0 RB Offset
		18625 to 19175	18625, 18900, 19175	5 MHz	QPSK, 16QAM	1 RB / 0 RB Offset
		18650 to 19150	18650, 18900, 19150	10 MHz	QPSK, 16QAM	1 RB / 0 RB Offset
		18675 to 19125	18675, 18900, 19125	15 MHz	QPSK, 16QAM	1 RB / 0 RB Offset
		18700 to 19100	18700, 18900, 19100	20 MHz	QPSK, 16QAM	1 RB / 0 RB Offset
-	Band Edge	18607 to 19193	18607	1.4 MHz	QPSK	1 RB / 0 RB Offset
			19193	1.4 MHz	QPSK	6 RB / 0 RB Offset
		18615 to 19185	18615	3 MHz	QPSK	1 RB / 5 RB Offset
			19185	3 MHz	QPSK	6 RB / 0 RB Offset
		18625 to 19175	18615	3 MHz	QPSK	1 RB / 0 RB Offset
			19185	3 MHz	QPSK	15 RB / 0 RB Offset
		18625 to 19175	18625	5 MHz	QPSK	1 RB / 14 RB Offset
			19175	5 MHz	QPSK	15 RB / 0 RB Offset
		18650 to 19150	18625	5 MHz	QPSK	1 RB / 0 RB Offset
			19175	5 MHz	QPSK	25 RB / 0 RB Offset
		18650 to 19150	18650	10 MHz	QPSK	1 RB / 24 RB Offset
			19150	10 MHz	QPSK	25 RB / 0 RB Offset
		18675 to 19125	18650	10 MHz	QPSK	1 RB / 0 RB Offset
			19150	10 MHz	QPSK	50 RB / 0 RB Offset
		18675 to 19125	18675	15 MHz	QPSK	1 RB / 49 RB Offset
			19125	15 MHz	QPSK	50 RB / 0 RB Offset
		18700 to 19100	18675	15 MHz	QPSK	1 RB / 0 RB Offset
			19125	15 MHz	QPSK	75 RB / 0 RB Offset
		18700 to 19100	18700	20 MHz	QPSK	1 RB / 74 RB Offset
			19100	20 MHz	QPSK	75 RB / 0 RB Offset
		18700 to 19100	18700	20 MHz	QPSK	1 RB / 0 RB Offset
			19100	20 MHz	QPSK	100 RB / 0 RB Offset
		18700 to 19100	18700	20 MHz	QPSK	1 RB / 99 RB Offset
			19100	20 MHz	QPSK	100 RB / 0 RB Offset

EUT Configure Mode	Test Item	Available Channel	Tested Channel	Channel Bandwidth	Modulation	Mode
	Conducted Emission	18607 to 19193	18607, 18900, 19193	1.4 MHz	QPSK	1 RB / 0 RB Offset
		18615 to 19185	18615, 18900, 19185	3 MHz	QPSK	1 RB / 0 RB Offset
		18625 to 19175	18625, 18900, 19175	5 MHz	QPSK	1 RB / 0 RB Offset
		18650 to 19150	18650, 18900, 19150	10 MHz	QPSK	1 RB / 0 RB Offset
		18675 to 19125	18675, 18900, 19125	15 MHz	QPSK	1 RB / 0 RB Offset
		18700 to 19100	18700, 18900, 19100	20 MHz	QPSK	1 RB / 0 RB Offset
A, B	Radiated Emission	18607 to 19193	18607, 18900, 19193	1.4 MHz	QPSK	1 RB / 0 RB Offset
		18625 to 19175	18625, 18900, 19175	5 MHz	QPSK	1 RB / 0 RB Offset
		18700 to 19100	18700, 18900, 19100	20 MHz	QPSK	1 RB / 0 RB Offset

Note:

1. This device was tested under all bandwidths, RB configurations and modulations. The worst case was found in QPSK modulation. Therefore, only EIRP, modulation characteristics, occupied bandwidth and peak to average ratio items had been tested under QPSK, 16QAM mode, the other items were performed under QPSK mode only.
2. For radiated emission above 1 GHz, according to 3GPP 36.521 Section 6.6.3.1.4, choose the lowest, 5 MHz & highest channel bandwidth for final test.
3. For radiated emissions below 1 GHz, select the worst radiated emission channel (above 1GHz) for final testing.

Test Condition:

Test Item	Environmental Conditions	Input Power	Tested By
EIRP	26 deg. C, 58 % RH	12 Vdc	Cyril Chen / Tim Chen
Modulation Characteristics	26 deg. C, 58 % RH	12 Vdc	Getaz Yang
Frequency Stability	26 deg. C, 58 % RH	12 Vdc	Getaz Yang
Occupied Bandwidth	26 deg. C, 58 % RH	12 Vdc	Getaz Yang
Band Edge	26 deg. C, 58 % RH	12 Vdc	Getaz Yang
Peak to Average Ratio	26 deg. C, 58 % RH	12 Vdc	Getaz Yang
Conducted Emission	26 deg. C, 58 % RH	12 Vdc	Getaz Yang
Radiated Emission	25 deg. C, 65 % RH	120 Vac, 60 Hz	Cyril Chen / Tim Chen

3.4 EUT Operating Conditions

The EUT makes a call to the communication simulator. The communication simulator station system controlled a EUT to export maximum output power under transmission mode and specific channel frequency

3.5 General Description of Applied Standards and references

The EUT is a RF Product. According to the specifications of the manufacturer, it must comply with the requirements of the following standards and references:

Test Standard:

FCC 47 CFR Part 2

FCC 47 CFR Part 24

ANSI 63.26-2015

NOTE: All test items have been performed and recorded as per the above standards.

References Test Guidance:

KDB 971168 D01 Power Meas License Digital Systems v03r01

ANSI/TIA/EIA-603-E 2016

NOTE: All test items have been performed as a reference to the above KDB test guidance.

4 Test Types and Results

4.1 Output Power Measurement

4.1.1 Limits of Output Power Measurement

Mobile / Portable station are limited to 2 watts e.i.r.p.

4.1.2 Test Procedures

EIRP / ERP Measurement:

- a. All measurements were done at low, middle and high operational frequency range. RBW and VBW is 5 MHz for WCDMA, and 1.4 MHz 、 3 MHz 、 5 MHz 、 10 MHz 、 15 MHz 、 20 MHz for LTE mode, and $VBW \geq 3 \times RBW$.
- b. Substitution method is used for E.I.R.P measurement. In the semi-anechoic chamber, EUT placed on the 0.8 m (below or equal 1 GHz) and/or 1.5 m (above 1 GHz) height of Turn Table, rotated the table around 360 degrees to search the maximum radiation power and receiver antenna shall be rotated vertical and horizontal polarization and moved height from 1 m to 4 m to find the maximum polar radiated power. The "Read Value" is the spectrum reading the maximum power value.
- c. $EIRP = \text{Output power level of S.G} - \text{TX cable loss} + \text{Antenna gain of substitution horn}$. E.R.P power can be calculated form E.I.R.P power by subtracting the gain of dipole, $E.R.P \text{ power} = E.I.R.P \text{ power} - 2.15 \text{ dB}$.

Conducted Power Measurement:

The EUT was set up for the maximum power with WCDMA, and LTE link data modulation and link up with simulator. Set the EUT to transmit under low, middle and high channel and record the power level shown on simulator.

4.1.3 Test Setup

EIRP / ERP Measurement:

<Radiated Emission below or equal 1 GHz>

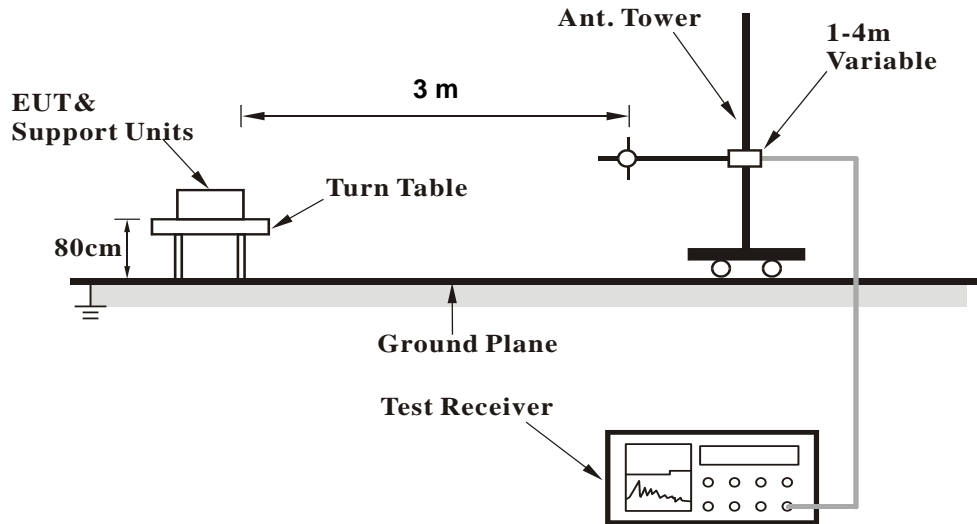

<Radiated Emission above 1 GHz>

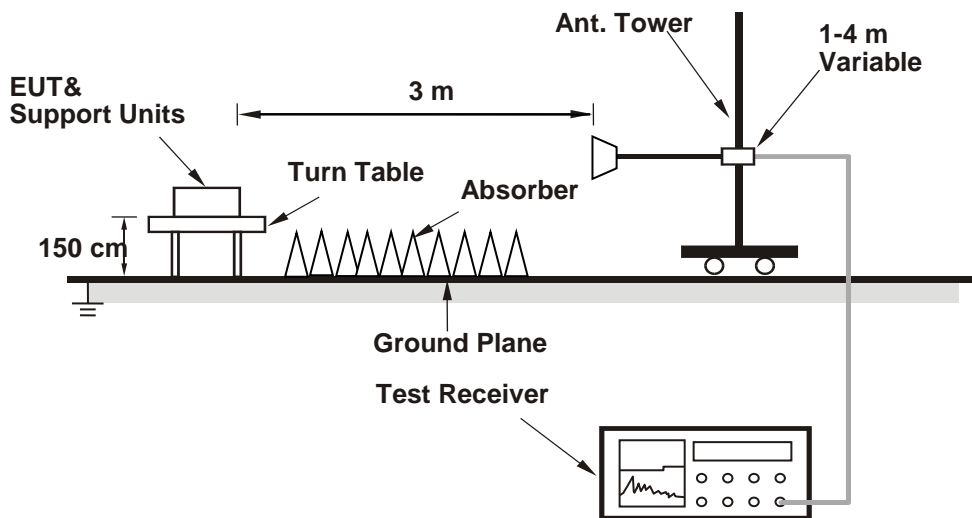

For the actual test configuration, please refer to the attached file (Test Setup Photo).

Conducted Power Measurement:



4.1.4 Test Results

Conducted Output Power (dBm)

Band	WCDMA II		
Channel	9262	9400	9538
Frequency (MHz)	1852.4	1880.0	1907.6
RMC 12.2K	22.61	22.33	22.66
HSDPA Subtest-1	21.75	21.45	21.79
HSDPA Subtest-2	21.68	21.41	21.74
HSDPA Subtest-3	21.61	21.38	21.68
HSDPA Subtest-4	21.58	21.37	21.61
HSUPA Subtest-1	21.72	21.40	21.74
HSUPA Subtest-2	19.79	19.34	19.78
HSUPA Subtest-3	20.65	20.31	20.80
HSUPA Subtest-4	19.71	19.31	19.73
HSUPA Subtest-5	21.70	21.35	21.72

Band / BW	RB Size	RB Offset	QPSK			3GPP MPR (dB)	16QAM			3GPP MPR (dB)
			Low Ch 18607	Mid Ch 18900	High Ch 19193		Low Ch 18607	Mid Ch 18900	High Ch 19193	
			1850.7 MHz	1880.0 MHz	1909.3 MHz		1850.7 MHz	1880.0 MHz	1909.3 MHz	
2 / 1.4M	1	0	21.81	21.65	21.64	0	20.69	20.75	20.47	1
	1	2	21.55	21.62	21.51	0	20.67	20.50	20.38	1
	1	5	21.44	21.44	21.35	0	20.35	20.31	20.13	1
	3	0	21.39	21.53	21.35	0	20.48	20.38	20.24	1
	3	1	21.28	21.33	21.23	0	20.24	20.19	19.96	1
	3	3	21.29	21.41	21.24	0	20.38	20.19	20.06	1
	6	0	20.64	20.59	20.51	1	19.51	19.57	19.32	2

Band / BW	RB Size	RB Offset	QPSK			3GPP MPR (dB)	16QAM			3GPP MPR (dB)
			Low Ch 18615	Mid Ch 18900	High Ch 19185		Low Ch 18615	Mid Ch 18900	High Ch 19185	
			1851.5 MHz	1880.0 MHz	1908.5 MHz		1851.5 MHz	1880.0 MHz	1908.5 MHz	
2 / 3M	1	0	21.86	21.86	21.81	0	20.80	20.75	20.71	1
	1	7	21.80	21.74	21.62	0	20.67	20.69	20.55	1
	1	14	21.59	21.69	21.38	0	20.49	20.37	20.41	1
	8	0	20.76	20.72	20.68	1	19.64	19.62	19.61	2
	8	3	20.60	20.57	20.40	1	19.51	19.48	19.48	2
	8	7	20.47	20.47	20.31	1	19.41	19.40	19.40	2
	15	0	20.70	20.68	20.59	1	19.63	19.57	19.55	2

Band / BW	RB Size	RB Offset	QPSK			3GPP MPR (dB)	16QAM			3GPP MPR (dB)
			Low Ch 18625	Mid Ch 18900	High Ch 19175		Low Ch 18625	Mid Ch 18900	High Ch 19175	
			1852.5 MHz	1880.0 MHz	1907.5 MHz		1852.5 MHz	1880.0 MHz	1907.5 MHz	
2 / 5M	1	0	21.98	21.91	21.80	0	21.00	20.94	20.88	1
	1	12	21.85	21.86	21.72	0	20.84	20.71	20.75	1
	1	24	21.65	21.56	21.51	0	20.66	20.71	20.57	1
	12	0	20.91	20.91	20.75	1	19.73	19.59	19.78	2
	12	6	20.64	20.70	20.60	1	19.62	19.61	19.54	2
	12	13	20.63	20.59	20.42	1	19.51	19.42	19.47	2
	25	0	20.92	20.79	20.76	1	19.75	19.76	19.56	2

Band / BW	RB Size	RB Offset	QPSK			3GPP MPR (dB)	16QAM			3GPP MPR (dB)
			Low Ch 18650	Mid Ch 18900	High Ch 19150		Low Ch 18650	Mid Ch 18900	High Ch 19150	
			1855.0 MHz	1880.0 MHz	1905.0 MHz		1855.0 MHz	1880.0 MHz	1905.0 MHz	
2 / 10M	1	0	22.15	22.06	22.01	0	21.01	21.06	20.93	1
	1	24	22.05	21.98	21.82	0	20.98	20.89	20.82	1
	1	49	21.88	21.78	21.72	0	20.62	20.78	20.60	1
	25	0	21.01	20.96	20.92	1	19.97	19.88	19.80	2
	25	12	20.81	20.77	20.71	1	19.73	19.71	19.60	2
	25	25	20.73	20.69	20.60	1	19.61	19.69	19.45	2
	50	0	20.85	20.88	20.79	1	19.92	19.84	19.72	2

Band / BW	RB Size	RB Offset	QPSK			3GPP MPR (dB)	16QAM			3GPP MPR (dB)
			Low Ch 18675	Mid Ch 18900	High Ch 19125		Low Ch 18675	Mid Ch 18900	High Ch 19125	
			1857.5 MHz	1880.0 MHz	1902.5 MHz		1857.5 MHz	1880.0 MHz	1902.5 MHz	
2 / 15M	1	0	22.26	22.20	22.12	0	21.15	21.13	21.06	1
	1	37	22.14	22.06	22.05	0	21.17	21.01	20.91	1
	1	74	22.01	21.94	21.90	0	20.86	20.86	20.68	1
	36	0	21.10	21.05	21.01	1	19.97	19.95	19.83	2
	36	19	20.95	20.88	20.82	1	19.84	19.79	19.81	2
	36	39	20.78	20.77	20.83	1	19.74	19.80	19.74	2
	75	0	21.15	21.09	20.94	1	20.03	20.07	19.81	2

Band / BW	RB Size	RB Offset	QPSK			3GPP MPR (dB)	16QAM			3GPP MPR (dB)
			Low Ch 18700	Mid Ch 18900	High Ch 19100		Low Ch 18700	Mid Ch 18900	High Ch 19100	
			1860.0 MHz	1880.0 MHz	1900.0 MHz		1860.0 MHz	1880.0 MHz	1900.0 MHz	
2 / 20M	1	0	22.37	22.34	22.25	0	21.29	21.28	21.24	1
	1	50	22.28	22.25	22.13	0	21.17	21.16	21.12	1
	1	99	22.11	21.96	21.90	0	21.02	21.01	20.80	1
	50	0	21.22	21.25	21.14	1	20.15	20.15	20.01	2
	50	25	21.01	21.07	20.96	1	19.99	20.00	19.90	2
	50	50	20.90	20.95	20.86	1	19.96	19.83	19.81	2
	100	0	21.21	21.20	21.09	1	20.17	20.11	20.09	2

Mode A

EIRP Power (dBm)

WCDMA							
Plane	Channel	Frequency (MHz)	Reading (dBm)	Correction Factor (dB)	EIRP (dBm)	EIRP (mW)	Polarization (H/V)
Y	9262	1852.4	-10.13	36.57	26.44	440.55	H
	9400	1880.0	-10.71	37.22	26.51	447.71	
	9538	1907.6	-10.62	37.18	26.56	452.90	
	9262	1852.4	-19.03	37.65	18.62	72.78	V
	9400	1880.0	-18.91	37.58	18.67	73.62	
	9538	1907.6	-18.75	37.48	18.73	74.64	

Note: EIRP (dBm) = Reading (dBm) + Correction Factor (dB)

LTE Band 2							
Channel Bandwidth: 1.4 MHz / QPSK							
Plane	Channel	Frequency (MHz)	Reading (dBm)	Correction Factor (dB)	EIRP (dBm)	EIRP (mW)	Polarization (H/V)
Y	18607	1850.7	-11.61	36.57	24.96	313.33	H
	18900	1880.0	-11.87	37.22	25.35	342.77	
	19193	1909.3	-11.44	37.18	25.74	374.97	
	18607	1850.7	-20.82	37.65	16.83	48.19	V
	18900	1880.0	-20.32	37.58	17.26	53.21	
	19193	1909.3	-19.80	37.48	17.68	58.61	
Channel Bandwidth: 1.4 MHz / 16QAM							
Y	18607	1850.7	-12.70	36.57	23.87	243.78	H
	18900	1880.0	-12.96	37.22	24.26	266.69	
	19193	1909.3	-12.49	37.18	24.69	294.44	
	18607	1850.7	-21.77	37.65	15.88	38.73	V
	18900	1880.0	-21.26	37.58	16.32	42.85	
	19193	1909.3	-20.75	37.48	16.73	47.10	

Note: EIRP (dBm) = Reading (dBm) + Correction Factor (dB)

LTE Band 2							
Channel Bandwidth: 3 MHz / QPSK							
Plane	Channel	Frequency (MHz)	Reading (dBm)	Correction Factor (dB)	EIRP (dBm)	EIRP (mW)	Polarization (H/V)
Y	18615	1851.5	-11.62	36.57	24.95	312.61	H
	18900	1880.0	-11.86	37.22	25.36	343.56	
	19185	1908.5	-11.41	37.18	25.77	377.57	
	18615	1851.5	-20.68	37.65	16.97	49.77	V
	18900	1880.0	-20.20	37.58	17.38	54.70	
	19185	1908.5	-19.67	37.48	17.81	60.39	
Channel Bandwidth: 3 MHz / 16QAM							
Y	18615	1851.5	-12.60	36.57	23.97	249.46	H
	18900	1880.0	-12.87	37.22	24.35	272.27	
	19185	1908.5	-12.45	37.18	24.73	297.17	
	18615	1851.5	-21.71	37.65	15.94	39.26	V
	18900	1880.0	-21.26	37.58	16.32	42.85	
	19185	1908.5	-20.77	37.48	16.71	46.88	

Note: EIRP (dBm) = Reading (dBm) + Correction Factor (dB)

LTE Band 2							
Channel Bandwidth: 5 MHz / QPSK							
Plane	Channel	Frequency (MHz)	Reading (dBm)	Correction Factor (dB)	EIRP (dBm)	EIRP (mW)	Polarization (H/V)
Y	18625	1852.5	-11.46	36.57	25.11	324.34	H
	18900	1880.0	-11.70	37.22	25.52	356.45	
	19175	1907.5	-11.25	37.18	25.93	391.74	
	18625	1852.5	-20.60	37.65	17.05	50.70	V
	18900	1880.0	-20.15	37.58	17.43	55.34	
	19175	1907.5	-19.60	37.48	17.88	61.38	
Channel Bandwidth: 5 MHz / 16QAM							
Y	18625	1852.5	-12.46	36.57	24.11	257.63	H
	18900	1880.0	-12.71	37.22	24.51	282.49	
	19175	1907.5	-12.24	37.18	24.94	311.89	
	18625	1852.5	-21.48	37.65	16.17	41.40	V
	18900	1880.0	-21.02	37.58	16.56	45.29	
	19175	1907.5	-20.53	37.48	16.95	49.55	

Note: EIRP (dBm) = Reading (dBm) + Correction Factor (dB)

LTE Band 2							
Channel Bandwidth: 10 MHz / QPSK							
Plane	Channel	Frequency (MHz)	Reading (dBm)	Correction Factor (dB)	EIRP (dBm)	EIRP (mW)	Polarization (H/V)
Y	18650	1855.0	-11.29	36.57	25.28	337.29	H
	18900	1880.0	-11.56	37.22	25.66	368.13	
	19150	1905.0	-11.09	37.18	26.09	406.44	
	18650	1855.0	-20.47	37.65	17.18	52.24	V
	18900	1880.0	-20.02	37.58	17.56	57.02	
	19150	1905.0	-19.51	37.48	17.97	62.66	
Channel Bandwidth: 10 MHz / 16QAM							
Y	18650	1855.0	-12.40	36.57	24.17	261.22	H
	18900	1880.0	-12.67	37.22	24.55	285.10	
	19150	1905.0	-12.19	37.18	24.99	315.50	
	18650	1855.0	-21.53	37.65	16.12	40.93	V
	18900	1880.0	-21.07	37.58	16.51	44.77	
	19150	1905.0	-20.54	37.48	16.94	49.43	

Note: EIRP (dBm) = Reading (dBm) + Correction Factor (dB)

LTE Band 2							
Channel Bandwidth: 15 MHz / QPSK							
Plane	Channel	Frequency (MHz)	Reading (dBm)	Correction Factor (dB)	EIRP (dBm)	EIRP (mW)	Polarization (H/V)
Y	18675	1857.5	-11.18	36.57	25.39	345.94	H
	18900	1880.0	-11.44	37.22	25.78	378.44	
	19125	1902.5	-11.00	37.18	26.18	414.95	
	18675	1857.5	-20.38	37.65	17.27	53.33	V
	18900	1880.0	-19.89	37.58	17.69	58.75	
	19125	1902.5	-19.46	37.48	18.02	63.39	
Channel Bandwidth: 15 MHz / 16QAM							
Y	18675	1857.5	-12.29	36.57	24.28	267.92	H
	18900	1880.0	-12.56	37.22	24.66	292.42	
	19125	1902.5	-12.11	37.18	25.07	321.37	
	18675	1857.5	-21.38	37.65	16.27	42.36	V
	18900	1880.0	-20.90	37.58	16.68	46.56	
	19125	1902.5	-20.47	37.48	17.01	50.23	

Note: EIRP (dBm) = Reading (dBm) + Correction Factor (dB)

LTE Band 2							
Channel Bandwidth: 20 MHz / QPSK							
Plane	Channel	Frequency (MHz)	Reading (dBm)	Correction Factor (dB)	EIRP (dBm)	EIRP (mW)	Polarization (H/V)
Y	18700	1860.0	-11.14	36.57	25.43	349.14	H
	18900	1880.0	-11.35	37.22	25.87	386.37	
	19100	1900.0	-10.90	37.18	26.28	424.62	
	18700	1860.0	-19.76	37.65	17.89	61.52	V
	18900	1880.0	-19.36	37.58	18.22	66.37	
	19100	1900.0	-18.85	37.48	18.63	72.95	
Channel Bandwidth: 20 MHz / 16QAM							
Y	18700	1860.0	-12.16	36.57	24.41	276.06	H
	18900	1880.0	-12.39	37.22	24.83	304.09	
	19100	1900.0	-11.96	37.18	25.22	332.66	
	18700	1860.0	-21.13	37.65	16.52	44.87	V
	18900	1880.0	-20.61	37.58	16.97	49.77	
	19100	1900.0	-20.15	37.48	17.33	54.08	

Note: EIRP (dBm) = Reading (dBm) + Correction Factor (dB)

Mode B

EIRP Power (dBm)

WCDMA							
Plane	Channel	Frequency (MHz)	Reading (dBm)	Correction Factor (dB)	EIRP (dBm)	EIRP (mW)	Polarization (H/V)
Z	9262	1852.4	-17.89	36.57	18.68	73.79	H
	9400	1880.0	-18.49	37.22	18.73	74.64	
	9538	1907.6	-18.39	37.18	18.79	75.68	
	9262	1852.4	-12.63	37.65	25.02	317.69	V
	9400	1880.0	-12.49	37.58	25.09	322.85	
	9538	1907.6	-12.34	37.48	25.14	326.59	

Note: EIRP (dBm) = Reading (dBm) + Correction Factor (dB)

LTE Band 2							
Channel Bandwidth: 1.4 MHz / QPSK							
Plane	Channel	Frequency (MHz)	Reading (dBm)	Correction Factor (dB)	EIRP (dBm)	EIRP (mW)	Polarization (H/V)
X	18607	1850.7	-20.15	36.57	16.42	43.85	H
	18900	1880.0	-20.39	37.22	16.83	48.19	
	19193	1909.3	-19.90	37.18	17.28	53.46	
	18607	1850.7	-14.20	37.65	23.45	221.31	V
	18900	1880.0	-13.69	37.58	23.89	244.91	
	19193	1909.3	-13.15	37.48	24.33	271.02	
Channel Bandwidth: 1.4 MHz / 16QAM							
X	18607	1850.7	-21.26	36.57	15.31	33.96	H
	18900	1880.0	-21.49	37.22	15.73	37.41	
	19193	1909.3	-20.99	37.18	16.19	41.59	
	18607	1850.7	-15.24	37.65	22.41	174.18	V
	18900	1880.0	-14.74	37.58	22.84	192.31	
	19193	1909.3	-14.20	37.48	23.28	212.81	

Note: EIRP (dBm) = Reading (dBm) + Correction Factor (dB)

LTE Band 2							
Channel Bandwidth: 3 MHz / QPSK							
Plane	Channel	Frequency (MHz)	Reading (dBm)	Correction Factor (dB)	EIRP (dBm)	EIRP (mW)	Polarization (H/V)
X	18615	1851.5	-20.14	36.57	16.43	43.95	H
	18900	1880.0	-20.41	37.22	16.81	47.97	
	19185	1908.5	-19.90	37.18	17.28	53.46	
	18615	1851.5	-14.14	37.65	23.51	224.39	V
	18900	1880.0	-13.64	37.58	23.94	247.74	
	19185	1908.5	-13.12	37.48	24.36	272.90	
Channel Bandwidth: 3 MHz / 16QAM							
X	18615	1851.5	-20.84	36.57	15.73	37.41	H
	18900	1880.0	-21.21	37.22	16.01	39.90	
	19185	1908.5	-20.76	37.18	16.42	43.85	
	18615	1851.5	-15.18	37.65	22.47	176.60	V
	18900	1880.0	-14.72	37.58	22.86	193.20	
	19185	1908.5	-14.17	37.48	23.31	214.29	

Note: EIRP (dBm) = Reading (dBm) + Correction Factor (dB)

LTE Band 2							
Channel Bandwidth: 5 MHz / QPSK							
Plane	Channel	Frequency (MHz)	Reading (dBm)	Correction Factor (dB)	EIRP (dBm)	EIRP (mW)	Polarization (H/V)
X	18625	1852.5	-19.99	36.57	16.58	45.50	H
	18900	1880.0	-20.20	37.22	17.02	50.35	
	19175	1907.5	-19.73	37.18	17.45	55.59	
	18625	1852.5	-13.96	37.65	23.69	233.88	V
	18900	1880.0	-13.50	37.58	24.08	255.86	
	19175	1907.5	-12.96	37.48	24.52	283.14	
Channel Bandwidth: 5 MHz / 16QAM							
X	18625	1852.5	-21.08	36.57	15.49	35.40	H
	18900	1880.0	-21.35	37.22	15.87	38.64	
	19175	1907.5	-20.86	37.18	16.32	42.85	
	18625	1852.5	-15.04	37.65	22.61	182.39	V
	18900	1880.0	-14.52	37.58	23.06	202.30	
	19175	1907.5	-14.00	37.48	23.48	222.84	

Note: EIRP (dBm) = Reading (dBm) + Correction Factor (dB)

LTE Band 2							
Channel Bandwidth: 10 MHz / QPSK							
Plane	Channel	Frequency (MHz)	Reading (dBm)	Correction Factor (dB)	EIRP (dBm)	EIRP (mW)	Polarization (H/V)
X	18650	1855.0	-19.79	36.57	16.78	47.64	H
	18900	1880.0	-20.01	37.22	17.21	52.60	
	19150	1905.0	-19.54	37.18	17.64	58.08	
	18650	1855.0	-13.84	37.65	23.81	240.44	V
	18900	1880.0	-13.35	37.58	24.23	264.85	
	19150	1905.0	-12.81	37.48	24.67	293.09	
Channel Bandwidth: 10 MHz / 16QAM							
X	18650	1855.0	-20.81	36.57	15.76	37.67	H
	18900	1880.0	-21.05	37.22	16.17	41.40	
	19150	1905.0	-20.57	37.18	16.61	45.81	
	18650	1855.0	-14.92	37.65	22.73	187.50	V
	18900	1880.0	-14.40	37.58	23.18	207.97	
	19150	1905.0	-13.91	37.48	23.57	227.51	

Note: EIRP (dBm) = Reading (dBm) + Correction Factor (dB)

LTE Band 2							
Channel Bandwidth: 15 MHz / QPSK							
Plane	Channel	Frequency (MHz)	Reading (dBm)	Correction Factor (dB)	EIRP (dBm)	EIRP (mW)	Polarization (H/V)
X	18675	1857.5	-19.73	36.57	16.84	48.31	H
	18900	1880.0	-20.01	37.22	17.21	52.60	
	19125	1902.5	-19.55	37.18	17.63	57.94	
	18675	1857.5	-13.77	37.65	23.88	244.34	V
	18900	1880.0	-13.31	37.58	24.27	267.30	
	19125	1902.5	-12.79	37.48	24.69	294.44	
Channel Bandwidth: 15 MHz / 16QAM							
X	18675	1857.5	-20.86	36.57	15.71	37.24	H
	18900	1880.0	-21.05	37.22	16.17	41.40	
	19125	1902.5	-20.65	37.18	16.53	44.98	
	18675	1857.5	-14.82	37.65	22.83	191.87	V
	18900	1880.0	-14.33	37.58	23.25	211.35	
	19125	1902.5	-13.80	37.48	23.68	233.35	

Note: EIRP (dBm) = Reading (dBm) + Correction Factor (dB)

LTE Band 2							
Channel Bandwidth: 20 MHz / QPSK							
Plane	Channel	Frequency (MHz)	Reading (dBm)	Correction Factor (dB)	EIRP (dBm)	EIRP (mW)	Polarization (H/V)
X	18700	1860.0	-19.56	36.57	17.01	50.23	H
	18900	1880.0	-19.79	37.22	17.43	55.34	
	19100	1900.0	-19.32	37.18	17.86	61.09	
	18700	1860.0	-13.62	37.65	24.03	252.93	V
	18900	1880.0	-13.12	37.58	24.46	279.25	
	19100	1900.0	-12.59	37.48	24.89	308.32	
Channel Bandwidth: 20 MHz / 16QAM							
X	18700	1860.0	-20.60	36.57	15.97	39.54	H
	18900	1880.0	-20.82	37.22	16.40	43.65	
	19100	1900.0	-20.37	37.18	16.81	47.97	
	18700	1860.0	-14.68	37.65	22.97	198.15	V
	18900	1880.0	-14.24	37.58	23.34	215.77	
	19100	1900.0	-13.70	37.48	23.78	238.78	

Note: EIRP (dBm) = Reading (dBm) + Correction Factor (dB)

4.2 Modulation Characteristics Measurement

4.2.1 Limits of Modulation Characteristics

N/A

4.2.2 Test Setup



4.2.3 Test Procedure

Connect the EUT to Communication Simulator via the antenna connector. The frequency band is set as EUT supported Modulation and Channels, the EUT output is matched with 50 ohm load, the waveform quality and constellation of the EUT was tested.

4.2.4 Test Results

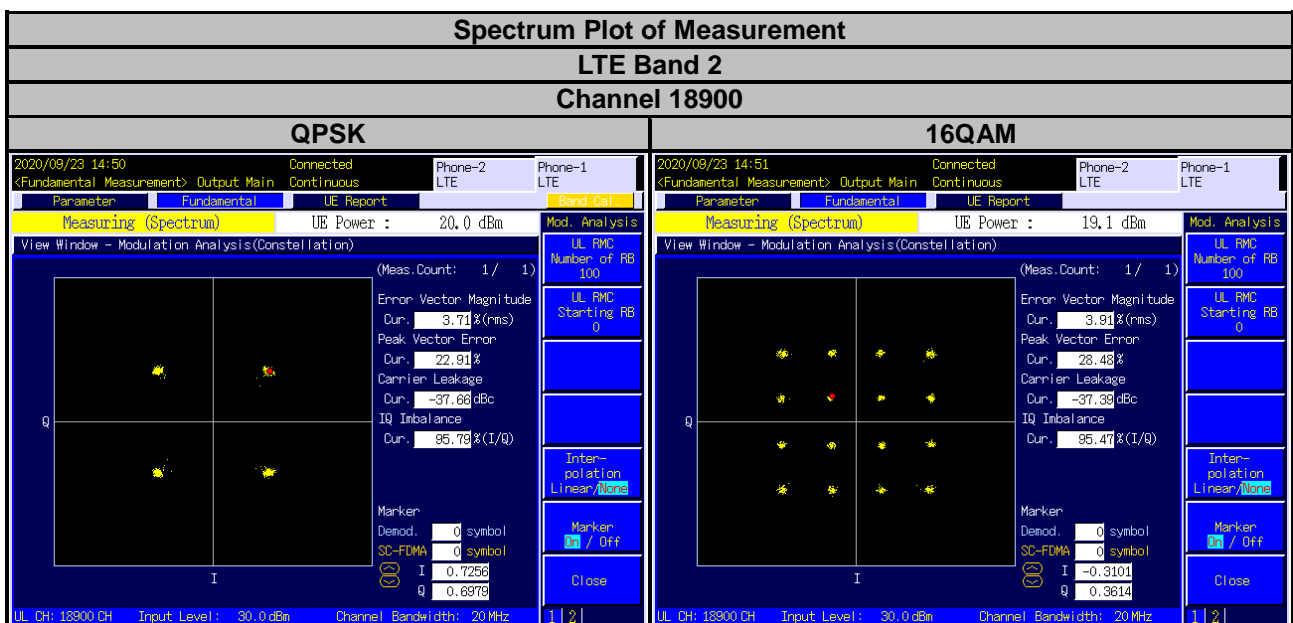
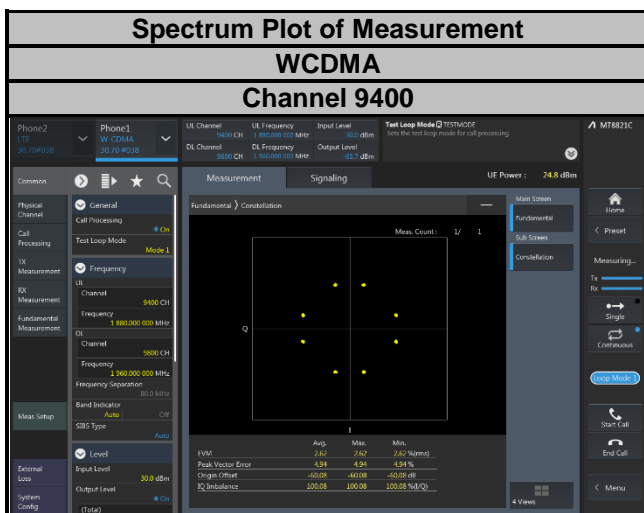

4.3 Frequency Stability Measurement

4.3.1 Limits of Frequency Stability Measurement

The frequency stability shall be sufficient to ensure that the fundamental emission stays within the authorized frequency block.

4.3.2 Test Procedure

- Device is placed at the oven room. The oven room could control the temperatures and humidity. Power warm up is at least 15 min and power applied should perform before recording frequency error.
- EUT is connected the external power supply to control the DC input power. The test voltage range is from minimum to maximum working voltage. Each step shall be record the frequency error rate.
- The temperature range step is 10 degrees in this test items. All temperature levels shall be hold the $\pm 0.5^\circ\text{C}$ during the measurement testing. The each temperature step shall be at least 0.5 hours, consider the EUT could be test under the stability condition.

NOTE: The frequency error was recorded frequency error from the communication simulator.

4.3.3 Test Setup

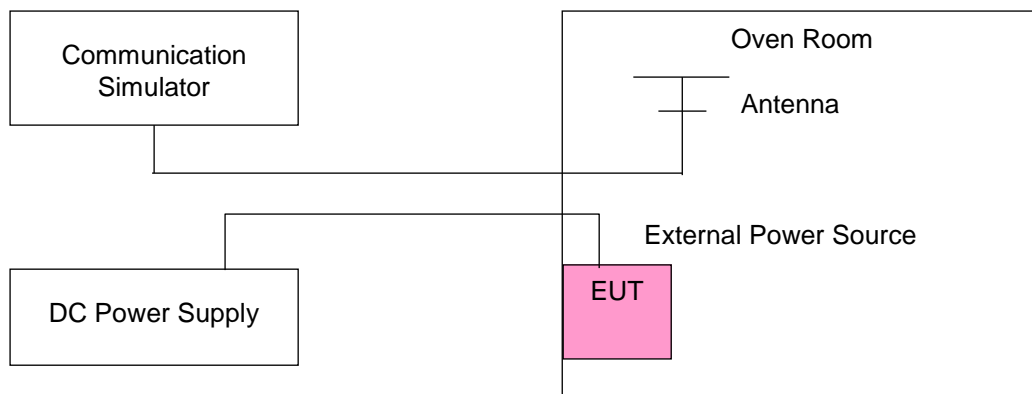

4.3.4 Test Results

Frequency Error vs. Voltage

Voltage (Volts)	WCDMA			
	Low Channel		High Channel	
	Frequency (MHz)	Frequency Error (ppm)	Frequency (MHz)	Frequency Error (ppm)
12	1852.400003	0.001	1907.600001	0.001
10.2	1852.400003	0.002	1907.600004	0.002
13.8	1852.400003	0.001	1907.600002	0.001

Note: The applicant defined the normal working voltage is from 10.2 Vdc to 13.8 Vdc.

Frequency Error vs. Temperature

Temp. (°C)	WCDMA			
	Low Channel		High Channel	
	Frequency (MHz)	Frequency Error (ppm)	Frequency (MHz)	Frequency Error (ppm)
-40	1852.400003	0.001	1907.600004	0.002
-30	1852.400002	0.001	1907.600004	0.002
-20	1852.400001	0.001	1907.600003	0.002
-10	1852.400003	0.001	1907.600003	0.002
0	1852.400002	0.001	1907.600002	0.001
10	1852.399999	-0.001	1907.599997	-0.002
20	1852.399996	-0.002	1907.599998	-0.001
30	1852.399996	-0.002	1907.599998	-0.001
40	1852.399998	-0.001	1907.599999	-0.001
50	1852.399997	-0.002	1907.599996	-0.002
60	1852.399997	-0.001	1907.599998	-0.001
70	1852.399997	-0.002	1907.599998	-0.001
80	1852.399998	-0.001	1907.599999	-0.001
85	1852.399998	-0.001	1907.599998	-0.001

Note:

1. The applicant declared that the normal operating temperature of the EUT is from -40°C to 85°C.
2. The EUT would shut down automatically as below -40°C.

Frequency Error vs. Voltage

Voltage (Volts)	LTE Band 2			
	Channel Bandwidth: 1.4 MHz			
	Low Channel		High Channel	
	Frequency (MHz)	Frequency Error (ppm)	Frequency (MHz)	Frequency Error (ppm)
12	1850.700003	0.002	1909.300000	-0.002
10.2	1850.700002	0.001	1909.299998	-0.001
13.8	1850.700002	0.001	1909.299998	-0.001

Note: The applicant defined the normal working voltage is from 10.2 Vdc to 13.8 Vdc.

Frequency Error vs. Temperature

Temp. (°C)	LTE Band 2			
	Channel Bandwidth: 1.4 MHz			
	Low Channel		High Channel	
	Frequency (MHz)	Frequency Error (ppm)	Frequency (MHz)	Frequency Error (ppm)
-40	1850.700002	0.001	1909.300002	0.001
-30	1850.700002	0.001	1909.300003	0.002
-20	1850.700003	0.002	1909.300003	0.002
-10	1850.700004	0.002	1909.300001	0.001
0	1850.700002	0.001	1909.300002	0.001
10	1850.699998	-0.001	1909.300002	0.001
20	1850.699999	-0.001	1909.300004	0.002
30	1850.699996	-0.002	1909.300003	0.002
40	1850.699999	-0.001	1909.299999	-0.001
50	1850.699999	-0.001	1909.299996	-0.002
60	1850.699997	-0.002	1909.299999	-0.001
70	1850.699998	-0.001	1909.299999	-0.001
80	1850.699997	-0.002	1909.299998	-0.001
85	1850.699999	-0.001	1909.299997	-0.002

Note:

1. The applicant declared that the normal operating temperature of the EUT is from -40°C to 85°C.
2. The EUT would shut down automatically as below -40°C.

Frequency Error vs. Voltage

Voltage (Volts)	LTE Band 2			
	Channel Bandwidth: 3 MHz			
	Low Channel		High Channel	
	Frequency (MHz)	Frequency Error (ppm)	Frequency (MHz)	Frequency Error (ppm)
12	1851.500003	0.002	1908.499999	-0.001
10.2	1851.500002	0.001	1908.499997	-0.001
13.8	1851.500004	0.002	1908.499996	-0.002

Note: The applicant defined the normal working voltage is from 10.2 Vdc to 13.8 Vdc.

Frequency Error vs. Temperature

Temp. (°C)	LTE Band 2			
	Channel Bandwidth: 3 MHz			
	Low Channel		High Channel	
	Frequency (MHz)	Frequency Error (ppm)	Frequency (MHz)	Frequency Error (ppm)
-40	1851.500003	0.001	1908.500002	0.001
-30	1851.500004	0.002	1908.500002	0.001
-20	1851.500002	0.001	1908.500003	0.002
-10	1851.500003	0.001	1908.500001	0.001
0	1851.500002	0.001	1908.500002	0.001
10	1851.499997	-0.002	1908.500002	0.001
20	1851.499999	-0.001	1908.500003	0.002
30	1851.499998	-0.001	1908.500003	0.002
40	1851.499997	-0.002	1908.499998	-0.001
50	1851.499998	-0.001	1908.499996	-0.002
60	1851.499999	-0.001	1908.499997	-0.002
70	1851.499997	-0.002	1908.499996	-0.002
80	1851.499998	-0.001	1908.499997	-0.002
85	1851.499996	-0.002	1908.499998	-0.001

Note:

1. The applicant declared that the normal operating temperature of the EUT is from -40°C to 85°C.
2. The EUT would shut down automatically as below -40°C.

Frequency Error vs. Voltage

Voltage (Volts)	LTE Band 2			
	Channel Bandwidth: 5 MHz			
	Low Channel		High Channel	
	Frequency (MHz)	Frequency Error (ppm)	Frequency (MHz)	Frequency Error (ppm)
12	1852.500002	0.001	1907.499998	-0.001
10.2	1852.500003	0.002	1907.499996	-0.002
13.8	1852.500001	0.001	1907.499997	-0.002

Note: The applicant defined the normal working voltage is from 10.2 Vdc to 13.8 Vdc.

Frequency Error vs. Temperature

Temp. (°C)	LTE Band 2			
	Channel Bandwidth: 5 MHz			
	Low Channel		High Channel	
	Frequency (MHz)	Frequency Error (ppm)	Frequency (MHz)	Frequency Error (ppm)
-40	1852.500003	0.001	1907.500004	0.002
-30	1852.500002	0.001	1907.500004	0.002
-20	1852.500001	0.001	1907.500003	0.001
-10	1852.500003	0.002	1907.500002	0.001
0	1852.500001	0.001	1907.500002	0.001
10	1852.499998	-0.001	1907.500002	0.001
20	1852.499997	-0.001	1907.500003	0.001
30	1852.499998	-0.001	1907.500002	0.001
40	1852.499997	-0.002	1907.499998	-0.001
50	1852.499999	-0.001	1907.499997	-0.001
60	1852.499998	-0.001	1907.499996	-0.002
70	1852.499999	-0.001	1907.499997	-0.002
80	1852.499996	-0.002	1907.499997	-0.001
85	1852.499996	-0.002	1907.499998	-0.001

Note:

1. The applicant declared that the normal operating temperature of the EUT is from -40°C to 85°C.
2. The EUT would shut down automatically as below -40°C.

Frequency Error vs. Voltage

Voltage (Volts)	LTE Band 2			
	Channel Bandwidth: 10 MHz			
	Low Channel		High Channel	
	Frequency (MHz)	Frequency Error (ppm)	Frequency (MHz)	Frequency Error (ppm)
12	1855.000002	0.001	1904.999997	-0.002
10.2	1855.000002	0.001	1904.999998	-0.001
13.8	1855.000004	0.002	1904.999997	-0.002

Note: The applicant defined the normal working voltage is from 10.2 Vdc to 13.8 Vdc.

Frequency Error vs. Temperature

Temp. (°C)	LTE Band 2			
	Channel Bandwidth: 10 MHz			
	Low Channel		High Channel	
	Frequency (MHz)	Frequency Error (ppm)	Frequency (MHz)	Frequency Error (ppm)
-40	1855.000002	0.001	1905.000003	0.001
-30	1855.000004	0.002	1905.000003	0.001
-20	1855.000003	0.002	1905.000002	0.001
-10	1855.000004	0.002	1905.000004	0.002
0	1855.000001	0.001	1905.000002	0.001
10	1854.999997	-0.001	1905.000003	0.001
20	1854.999999	-0.001	1905.000003	0.001
30	1854.999997	-0.002	1905.000001	0.001
40	1854.999998	-0.001	1904.999998	-0.001
50	1854.999997	-0.002	1904.999999	-0.001
60	1854.999997	-0.001	1904.999997	-0.002
70	1854.999996	-0.002	1904.999997	-0.001
80	1854.999998	-0.001	1904.999999	-0.001
85	1854.999998	-0.001	1904.999999	-0.001

Note:

1. The applicant declared that the normal operating temperature of the EUT is from -40°C to 85°C.
2. The EUT would shut down automatically as below -40°C.

Frequency Error vs. Voltage

Voltage (Volts)	LTE Band 2			
	Channel Bandwidth: 15 MHz			
	Low Channel		High Channel	
	Frequency (MHz)	Frequency Error (ppm)	Frequency (MHz)	Frequency Error (ppm)
12	1857.500002	0.001	1902.499997	-0.002
10.2	1857.500003	0.001	1902.499997	-0.002
13.8	1857.500002	0.001	1902.499999	-0.001

Note: The applicant defined the normal working voltage is from 10.2 Vdc to 13.8 Vdc.

Frequency Error vs. Temperature

Temp. (°C)	LTE Band 2			
	Channel Bandwidth: 15 MHz			
	Low Channel		High Channel	
	Frequency (MHz)	Frequency Error (ppm)	Frequency (MHz)	Frequency Error (ppm)
-40	1857.500002	0.001	1902.500004	0.002
-30	1857.500003	0.002	1902.500002	0.001
-20	1857.500004	0.002	1902.500002	0.001
-10	1857.500003	0.002	1902.500001	0.001
0	1857.500001	0.001	1902.500002	0.001
10	1857.499998	-0.001	1902.500003	0.002
20	1857.499996	-0.002	1902.500004	0.002
30	1857.499996	-0.002	1902.500002	0.001
40	1857.499997	-0.001	1902.499997	-0.001
50	1857.499997	-0.001	1902.499996	-0.002
60	1857.499998	-0.001	1902.499998	-0.001
70	1857.499999	-0.001	1902.499997	-0.002
80	1857.499998	-0.001	1902.499998	-0.001
85	1857.499998	-0.001	1902.499998	-0.001

Note:

1. The applicant declared that the normal operating temperature of the EUT is from -40°C to 85°C.
2. The EUT would shut down automatically as below -40°C.

Frequency Error vs. Voltage

Voltage (Volts)	LTE Band 2			
	Channel Bandwidth: 20 MHz			
	Low Channel		High Channel	
	Frequency (MHz)	Frequency Error (ppm)	Frequency (MHz)	Frequency Error (ppm)
12	1860.000003	0.002	1899.999999	-0.001
10.2	1860.000002	0.001	1899.999997	-0.002
13.8	1860.000002	0.001	1899.999998	-0.001

Note: The applicant defined the normal working voltage is from 10.2 Vdc to 13.8 Vdc.

Frequency Error vs. Temperature

Temp. (°C)	LTE Band 2			
	Channel Bandwidth: 20 MHz			
	Low Channel		High Channel	
	Frequency (MHz)	Frequency Error (ppm)	Frequency (MHz)	Frequency Error (ppm)
-40	1860.000001	0.001	1900.000004	0.002
-30	1860.000001	0.001	1900.000004	0.002
-20	1860.000003	0.002	1900.000001	0.001
-10	1860.000002	0.001	1900.000001	0.001
0	1860.000003	0.001	1900.000001	0.001
10	1859.999997	-0.002	1900.000003	0.001
20	1859.999996	-0.002	1900.000003	0.002
30	1859.999997	-0.002	1900.000002	0.001
40	1859.999996	-0.002	1899.999999	-0.001
50	1859.999997	-0.001	1899.999997	-0.002
60	1859.999998	-0.001	1899.999997	-0.002
70	1859.999996	-0.002	1899.999997	-0.002
80	1859.999997	-0.002	1899.999997	-0.002
85	1859.999997	-0.002	1899.999997	-0.002

Note:

1. The applicant declared that the normal operating temperature of the EUT is from -40°C to 85°C.
2. The EUT would shut down automatically as below -40°C.

4.4 Occupied Bandwidth Measurement

4.4.1 Test Procedure

The EUT makes a call to the communication simulator. All measurements were done at low, middle and high operational frequency range. The communication simulator station system controlled a EUT to export maximum output power under transmission mode and specific channel frequency. Use OBW measurement function of Spectrum analyzer to measure 99 % occupied bandwidth.

4.4.2 Test Setup

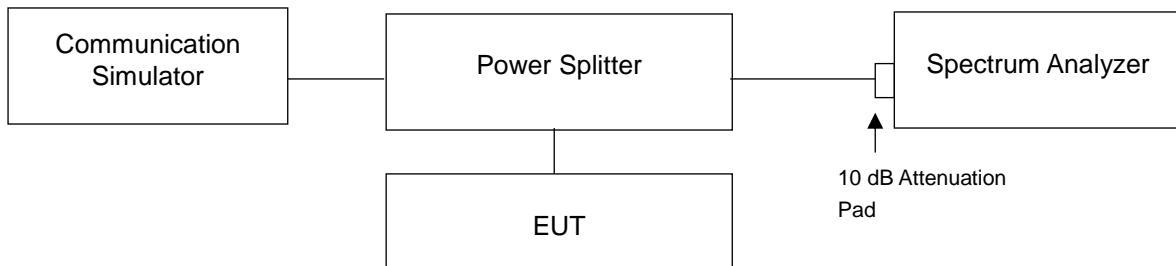

4.4.3 Test Result

WCDMA			
Channel	Frequency (MHz)	99 % Occupied Bandwidth (MHz)	26 dB Bandwidth (MHz)
9262	1852.4	4.1592	4.769
9400	1880.0	4.1522	4.754
9538	1907.6	4.1509	4.740

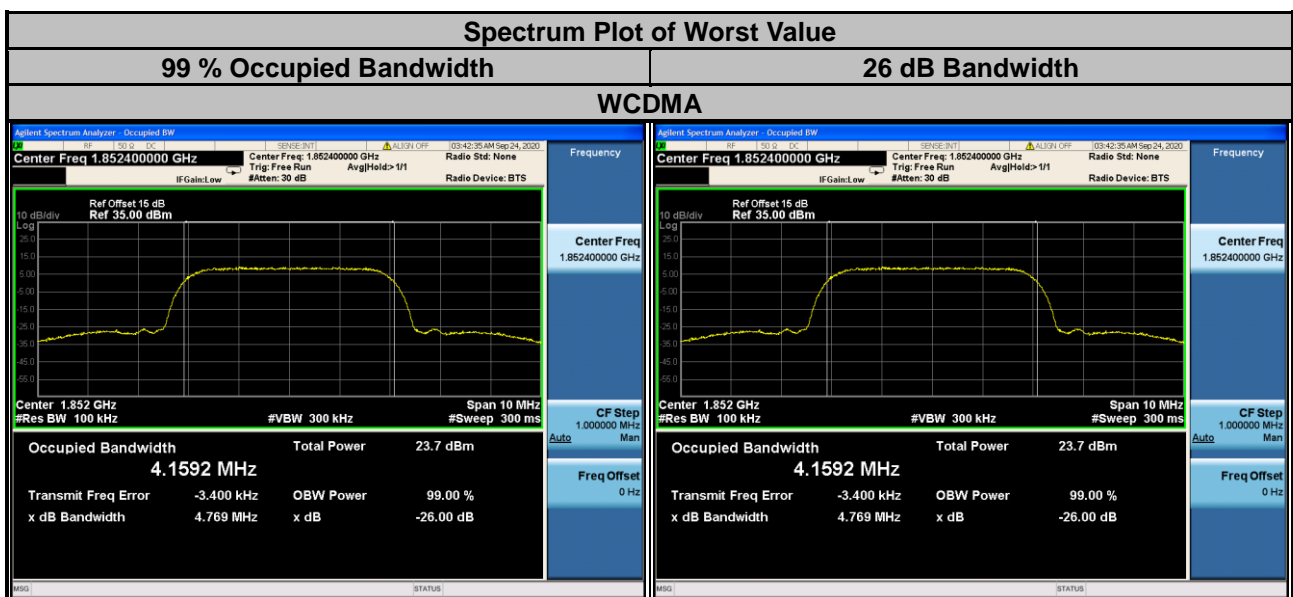

LTE Band 2					
Channel Bandwidth: 1.4 MHz					
Channel	Frequency (MHz)	99 % Occupied Bandwidth (MHz)		26 dB Bandwidth (MHz)	
		QPSK	16QAM	QPSK	16QAM
18607	1850.7	1.0877	1.0906	1.268	1.282
18900	1880.0	1.0899	1.0911	1.267	1.277
19193	1909.3	1.0890	1.0912	1.261	1.248

Channel Bandwidth: 3 MHz					
Channel	Frequency (MHz)	99 % Occupied Bandwidth (MHz)		26 dB Bandwidth (MHz)	
		QPSK	16QAM	QPSK	16QAM
18615	1851.5	2.6982	2.7027	2.920	2.939
18900	1880.0	2.7023	2.7059	2.935	2.930
19185	1908.5	2.7039	2.6978	2.931	2.910

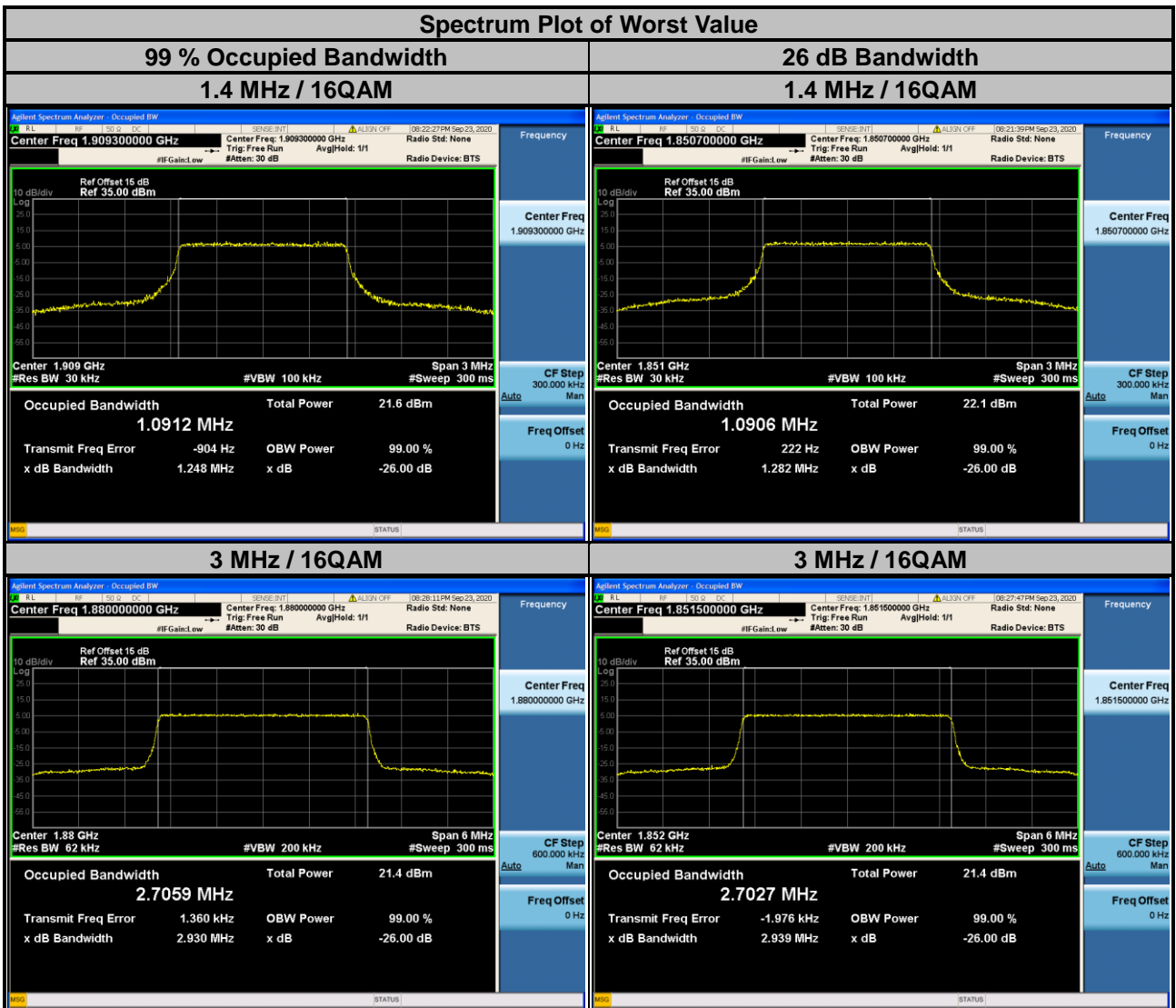

LTE Band 2					
Channel Bandwidth: 5 MHz					
Channel	Frequency (MHz)	99 % Occupied Bandwidth (MHz)		26 dB Bandwidth (MHz)	
		QPSK	16QAM	QPSK	16QAM
18625	1852.5	4.4969	4.4950	4.865	4.858
18900	1880.0	4.4948	4.4956	4.823	4.846
19175	1907.5	4.4942	4.4982	4.825	4.816

Channel Bandwidth: 10 MHz					
Channel	Frequency (MHz)	99 % Occupied Bandwidth (MHz)		26 dB Bandwidth (MHz)	
		QPSK	16QAM	QPSK	16QAM
18650	1855.0	8.9653	8.9667	9.542	9.568
18900	1880.0	8.9620	8.9652	9.545	9.522
19150	1905.0	8.9541	8.9483	9.532	9.512



LTE Band 2					
Channel Bandwidth: 15 MHz					
Channel	Frequency (MHz)	99 % Occupied Bandwidth (MHz)		26 dB Bandwidth (MHz)	
		QPSK	16QAM	QPSK	16QAM
18675	1857.5	13.436	13.434	14.26	14.24
18900	1880.0	13.429	13.433	14.27	14.24
19125	1902.5	13.401	13.406	14.22	14.22

Channel Bandwidth: 20 MHz					
Channel	Frequency (MHz)	99 % Occupied Bandwidth (MHz)		26 dB Bandwidth (MHz)	
		QPSK	16QAM	QPSK	16QAM
18700	1860.0	17.900	17.898	19.01	19.01
18900	1880.0	17.910	17.907	19.01	19.00
19100	1900.0	17.861	17.870	18.98	18.98

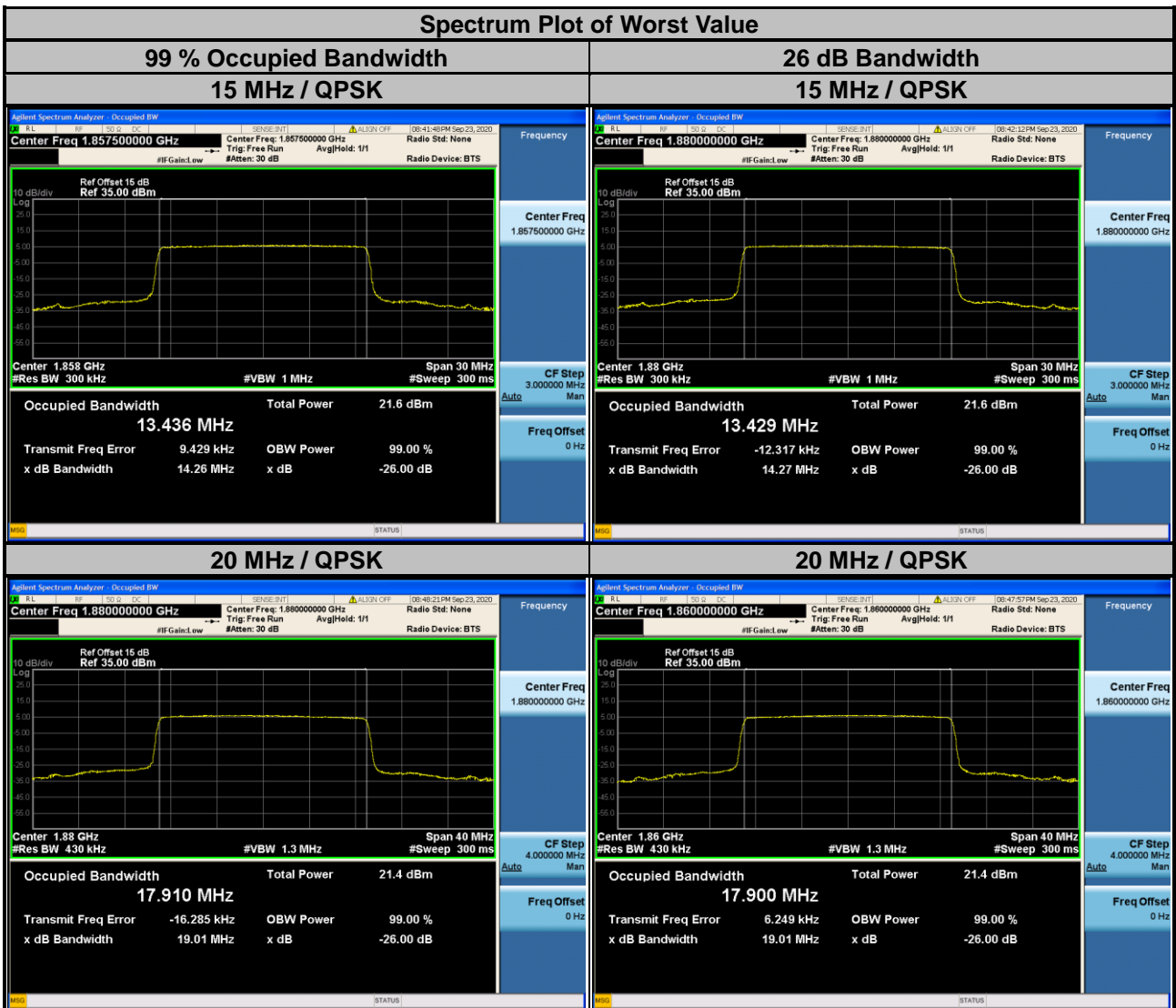

4.5 Band Edge Measurement

4.5.1 Limits of Band Edge Measurement

Power of any emission outside of the authorized operating frequency ranges must be attenuated below the transmitting power (P) by a factor of at least $43 + 10 \log(P)$ dB. In the 1 MHz bands immediately outside and adjacent to the frequency block a resolution bandwidth of at least one percent of the emission bandwidth of the fundamental emission of the transmitter may be employed.

4.5.2 Test Setup

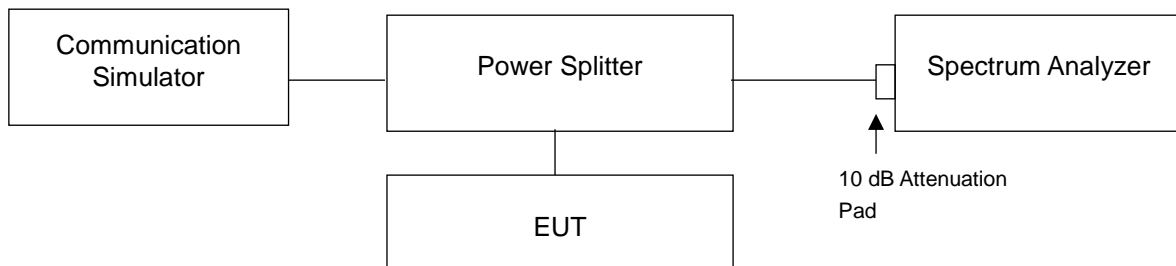

4.5.3 Test Procedures

- All measurements were done at low and high operational frequency range.
- The center frequency of spectrum is the band edge frequency and span is 5 MHz. RB of the spectrum is 51 kHz and VB of the spectrum is 160 kHz (WCDMA).
- The center frequency of spectrum is the band edge frequency and span is 1 MHz. RB of the spectrum is 15 kHz and VB of the spectrum is 51 kHz (LTE Bandwidth 1.4 MHz).
- The center frequency of spectrum is the band edge frequency and span is 1 MHz. RB of the spectrum is 30 kHz and VB of the spectrum is 100 kHz (LTE Bandwidth 3 MHz).
- The center frequency of spectrum is the band edge frequency and span is 1 MHz. RB of the spectrum is 51 kHz and VB of the spectrum is 160 kHz (LTE Bandwidth 5 MHz).
- The center frequency of spectrum is the band edge frequency and span is 1 MHz. RB of the spectrum is 100 kHz and VB of the spectrum is 300 kHz (LTE Bandwidth 10 MHz).
- The center frequency of spectrum is the band edge frequency and span is 1 MHz. RB of the spectrum is 150 kHz and VB of the spectrum is 470 kHz (LTE Bandwidth 15 MHz).
- The center frequency of spectrum is the band edge frequency and span is 1 MHz. RB of the spectrum is 200 kHz and VB of the spectrum is 1 MHz (LTE Bandwidth 20 MHz).
- Record the max trace plot into the test report.

4.5.4 Test Results

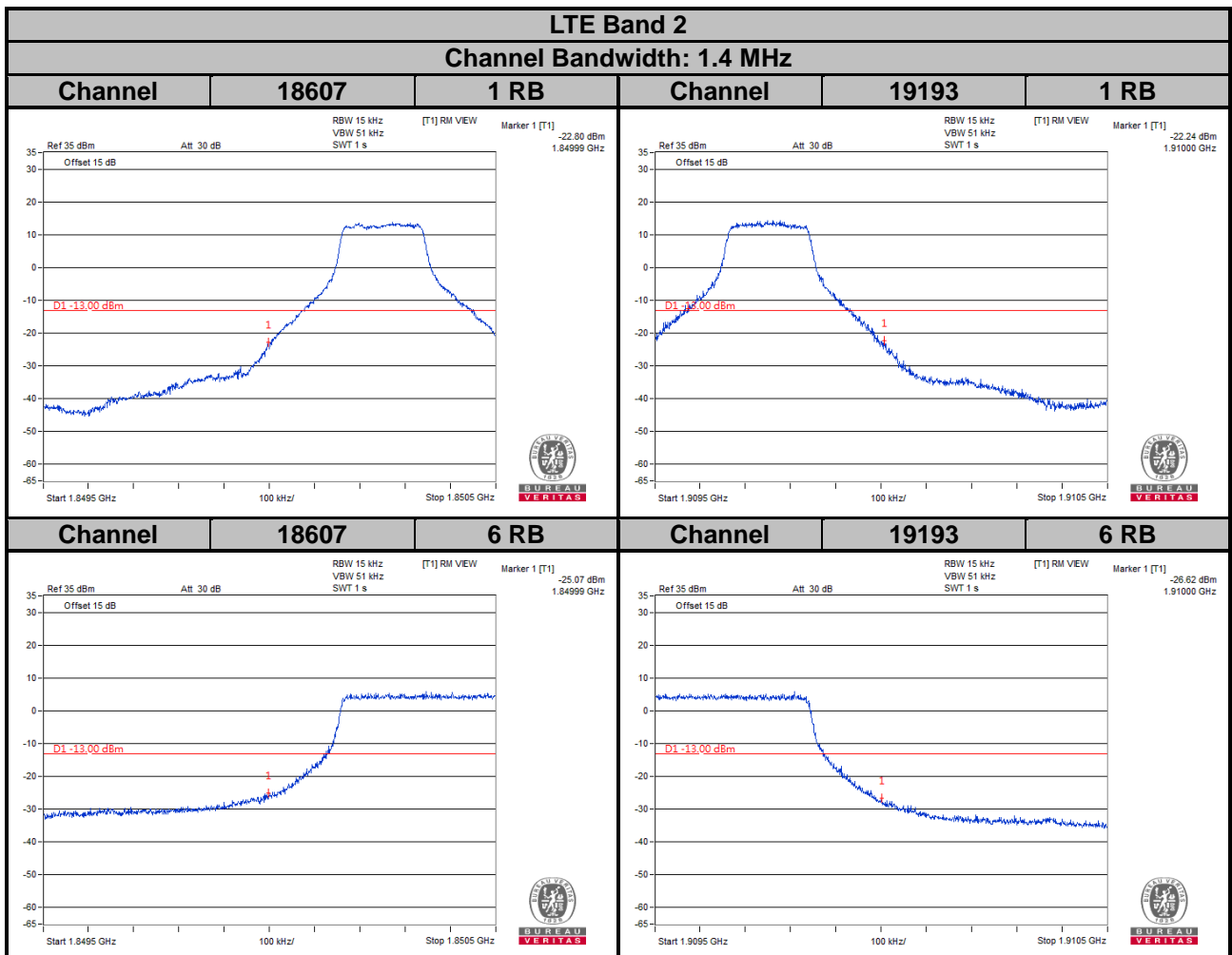
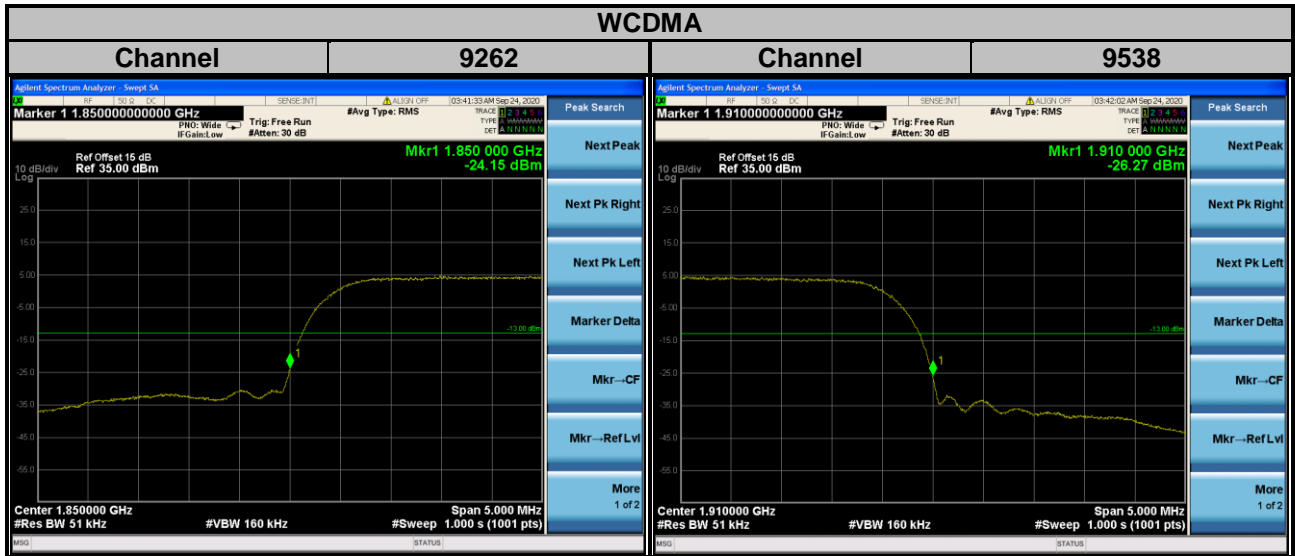

LTE Band 2

Channel Bandwidth: 3 MHz

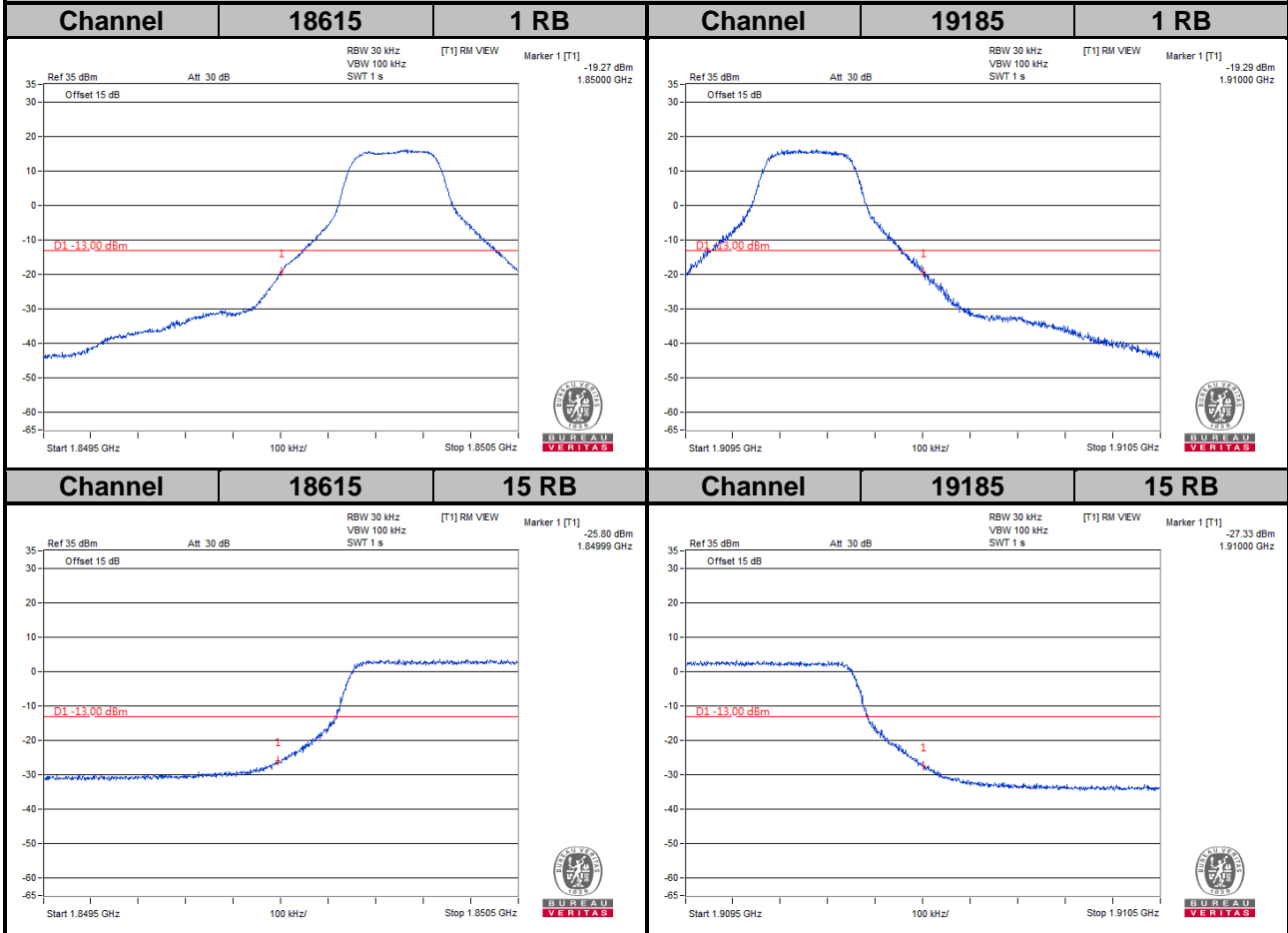

LTE Band 2
Channel Bandwidth: 5 MHz

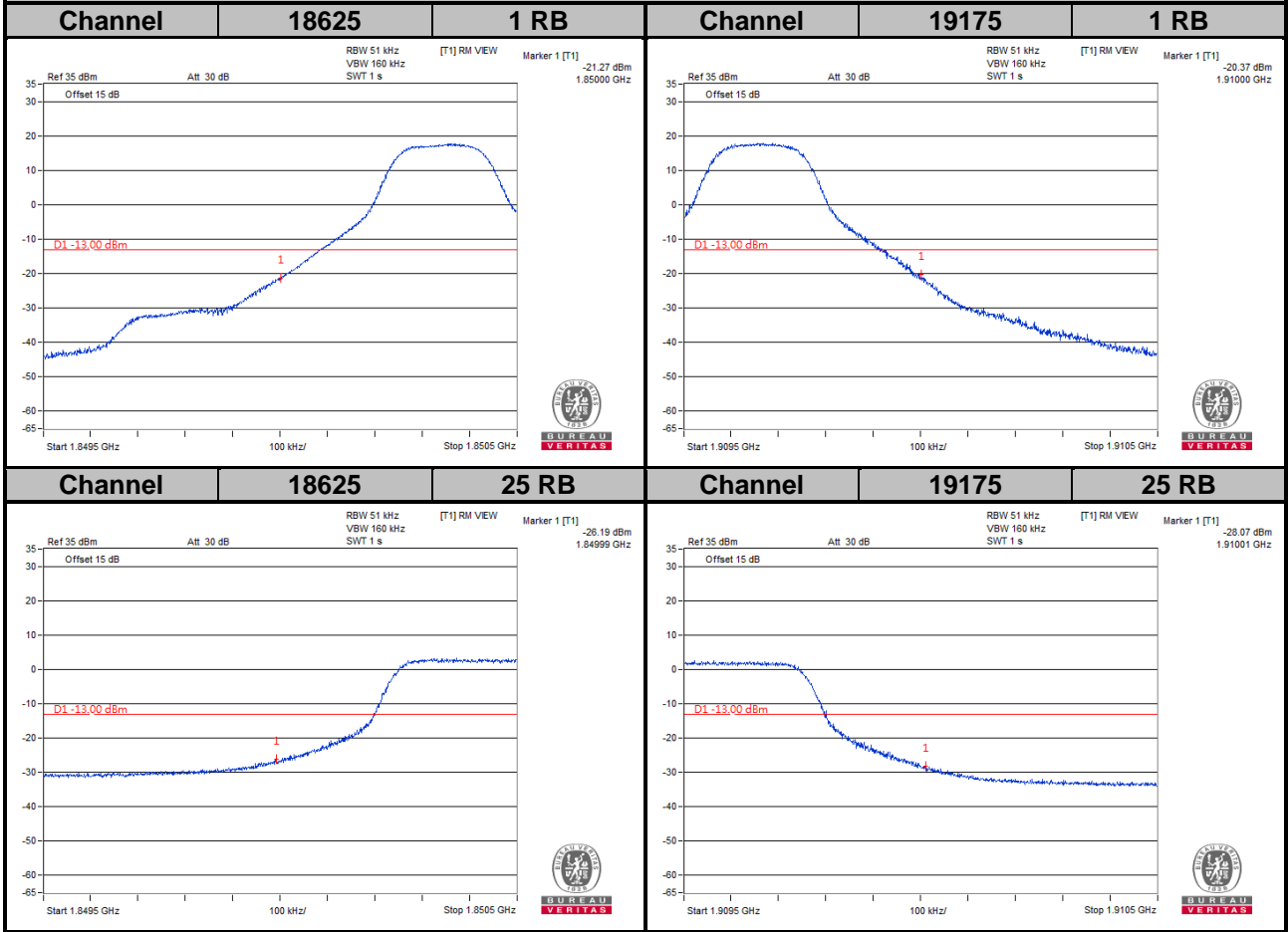

LTE Band 2

Channel Bandwidth: 10 MHz

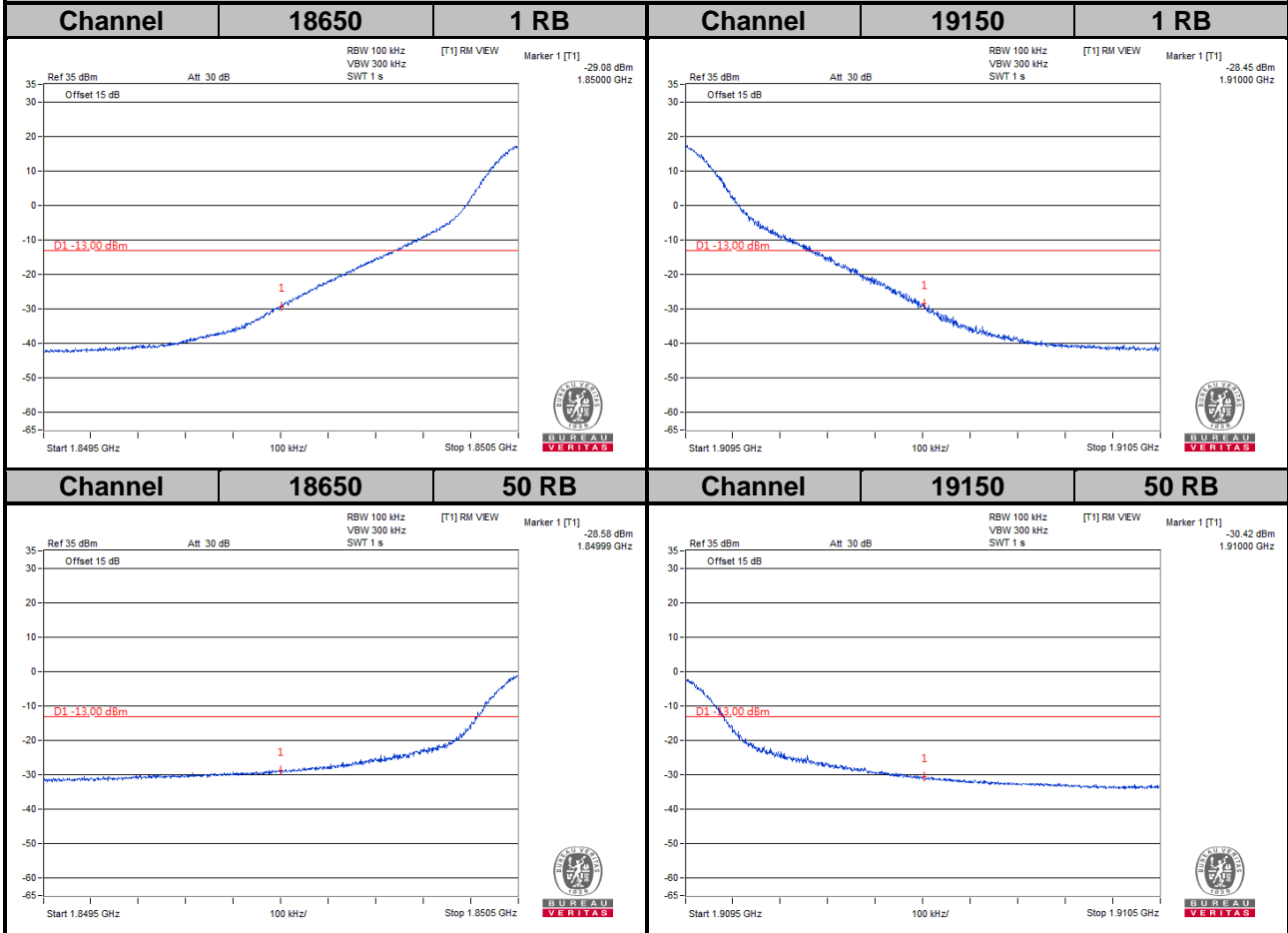

LTE Band 2

Channel Bandwidth: 15 MHz

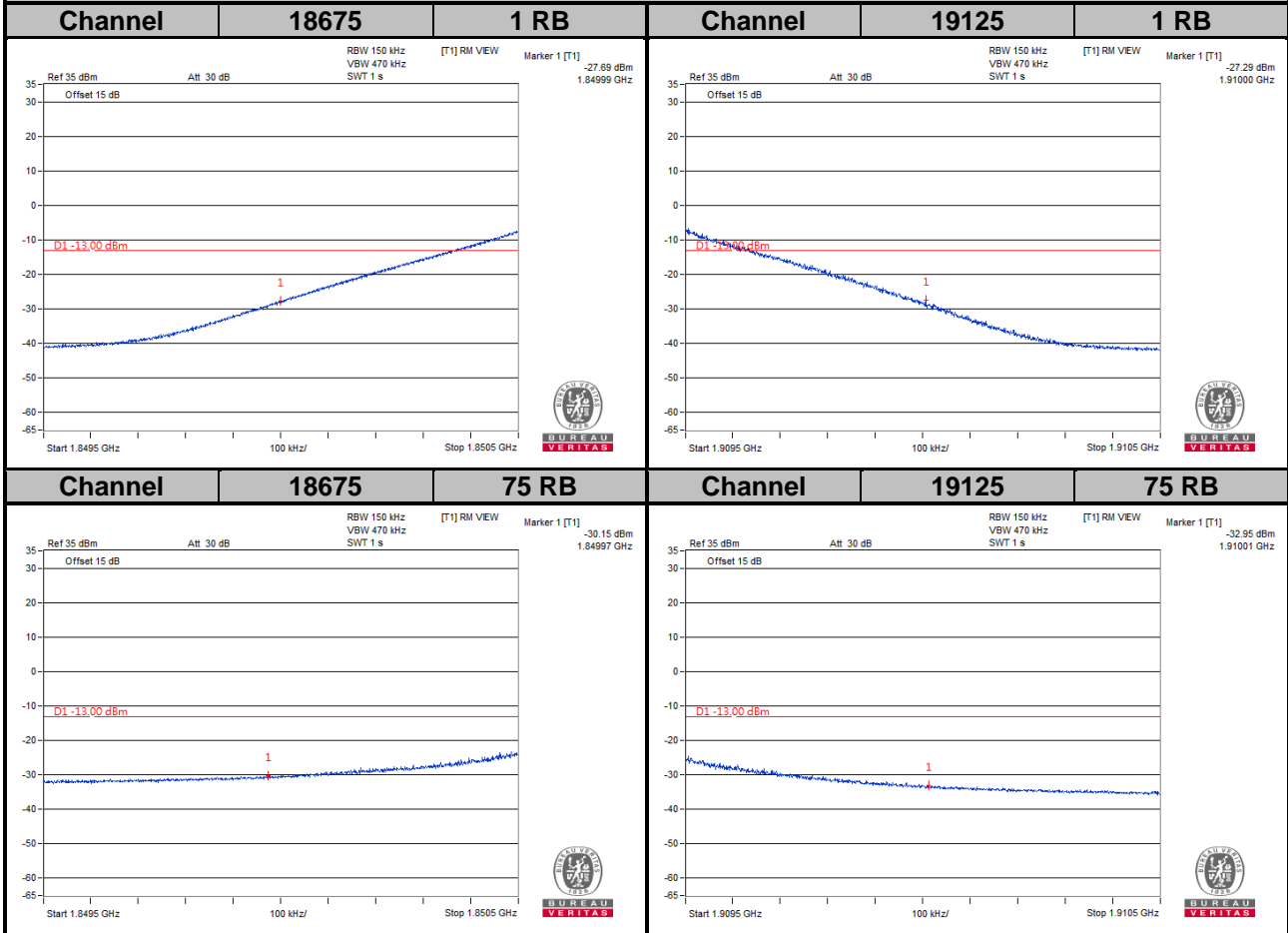

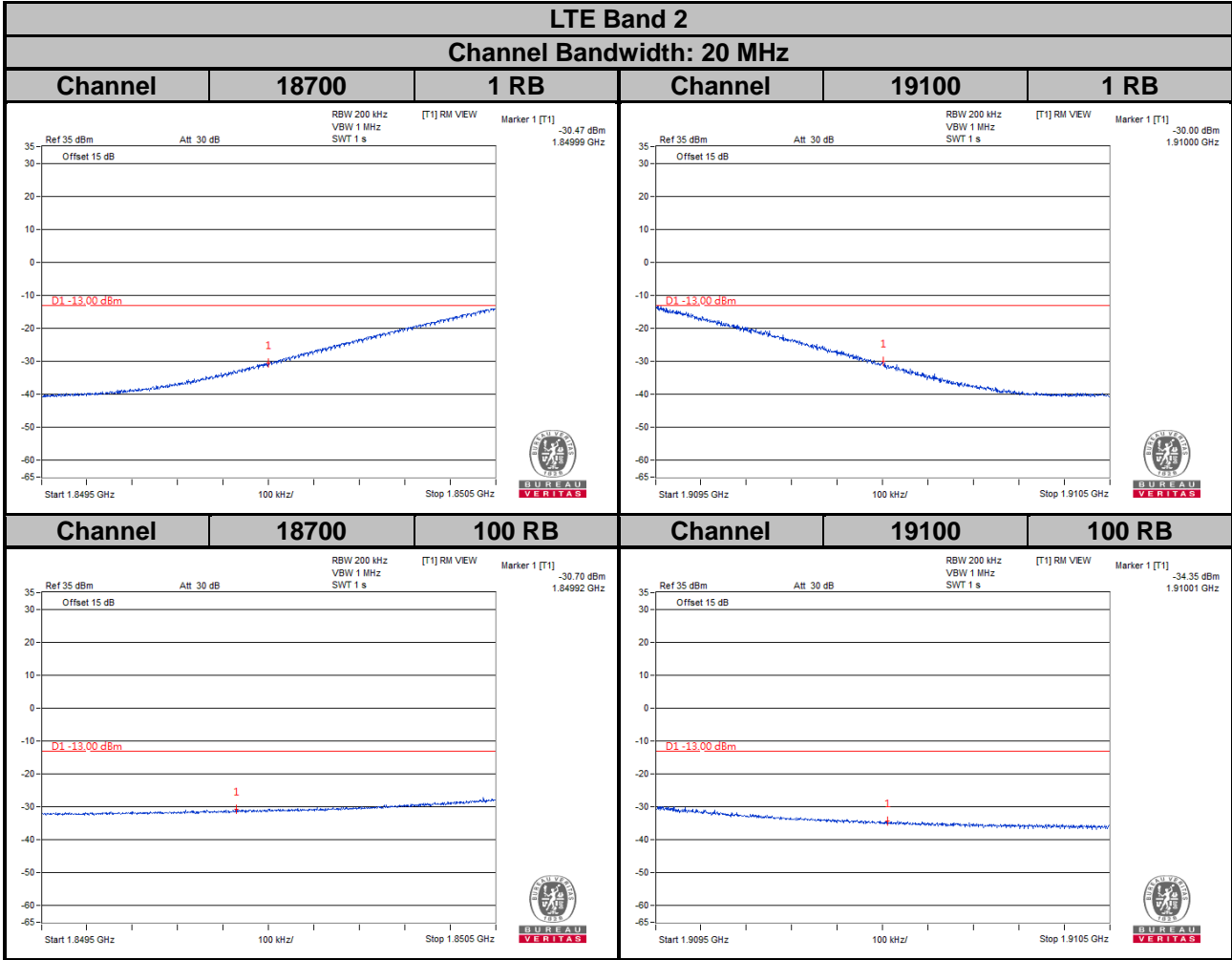

4.6 Peak to Average Ratio

4.6.1 Limits of Peak to Average Ratio Measurement

In measuring transmissions in this band using an average power technique, the peak to-average ratio (PAR) of the transmission may not exceed 13 dB.

4.6.2 Test Setup

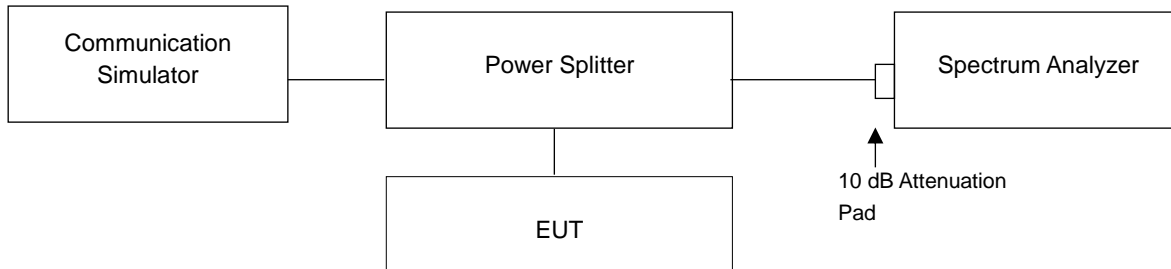

4.6.3 Test Procedures

1. Set resolution/measurement bandwidth \geq signal's occupied bandwidth;
2. Set the number of counts to a value that stabilizes the measured CCDF curve;
3. Record the maximum PAPR level associated with a probability of 0.1 %.

4.6.4 Test Results

Channel	Frequency (MHz)	Peak to Average Ratio (dB)
		WCDMA
9262	1852.4	2.68
9400	1880.0	2.87
9538	1907.6	2.73

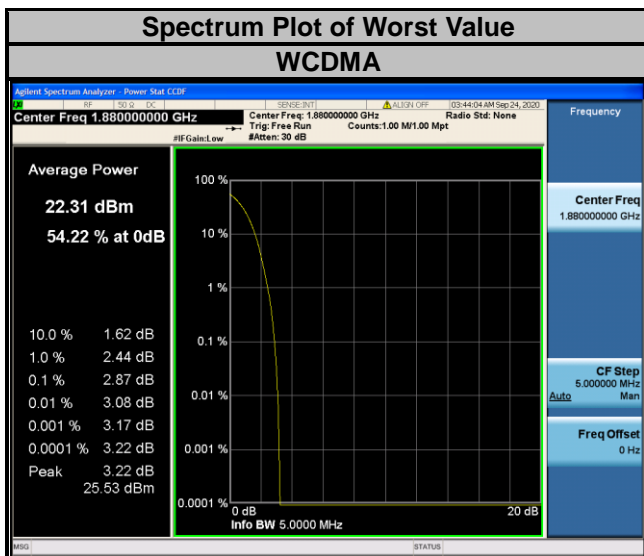

LTE Band 2							
Channel Bandwidth: 1.4 MHz				Channel Bandwidth: 3 MHz			
Channel	Frequency (MHz)	Peak to Average Ratio (dB)		Channel	Frequency (MHz)	Peak to Average Ratio (dB)	
		QPSK	16QAM			QPSK	16QAM
18607	1850.7	3.81	4.63	18615	1851.5	3.79	4.66
18900	1880.0	4.04	4.87	18900	1880.0	4.00	4.90
19193	1909.3	3.57	4.56	19185	1908.5	3.62	4.75

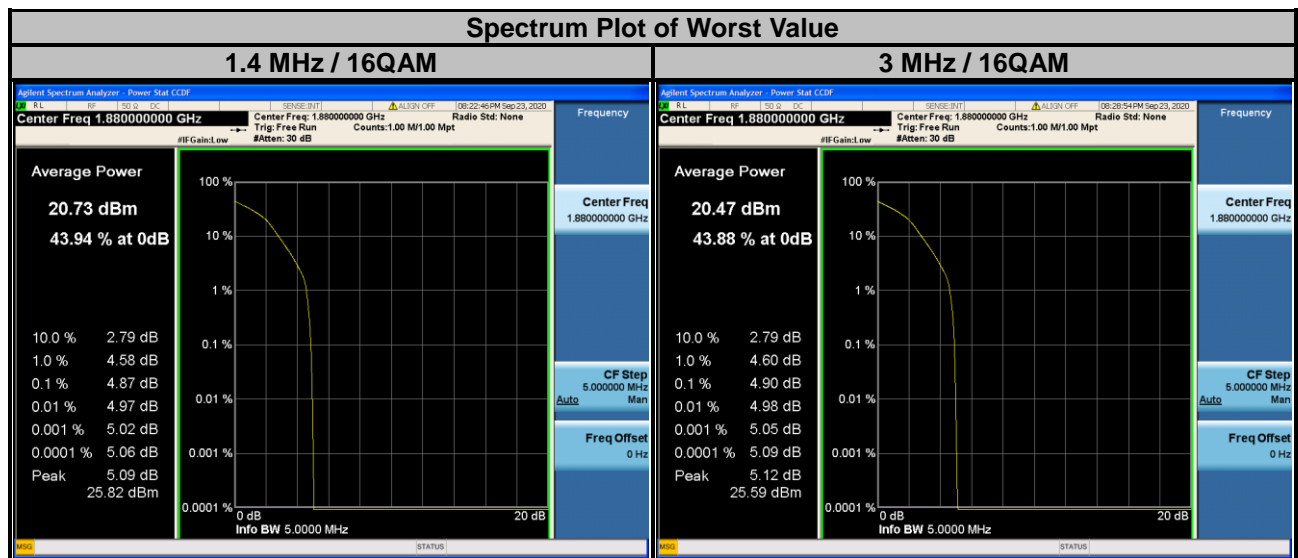

LTE Band 2							
Channel Bandwidth: 5 MHz				Channel Bandwidth: 10 MHz			
Channel	Frequency (MHz)	Peak to Average Ratio (dB)		Channel	Frequency (MHz)	Peak to Average Ratio (dB)	
		QPSK	16QAM			QPSK	16QAM
18625	1852.5	3.77	4.71	18650	1855.0	3.88	4.62
18900	1880.0	4.03	4.87	18900	1880.0	3.95	4.81
19175	1907.5	3.95	4.73	19150	1905.0	4.13	4.99

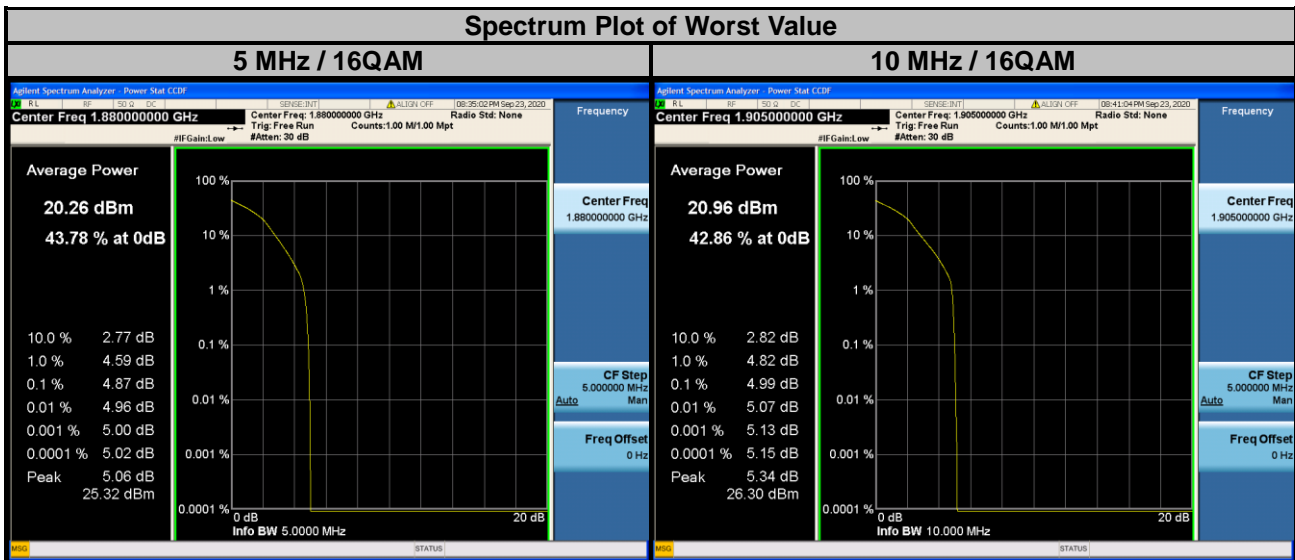

LTE Band 2							
Channel Bandwidth: 15 MHz				Channel Bandwidth: 20 MHz			
Channel	Frequency (MHz)	Peak to Average Ratio (dB)		Channel	Frequency (MHz)	Peak to Average Ratio (dB)	
		QPSK	16QAM			QPSK	16QAM
18675	1857.5	3.78	4.67	18700	1860.0	3.82	4.58
18900	1880.0	3.95	4.83	18900	1880.0	3.95	4.77
19125	1902.5	4.37	5.21	19100	1900.0	4.35	5.35

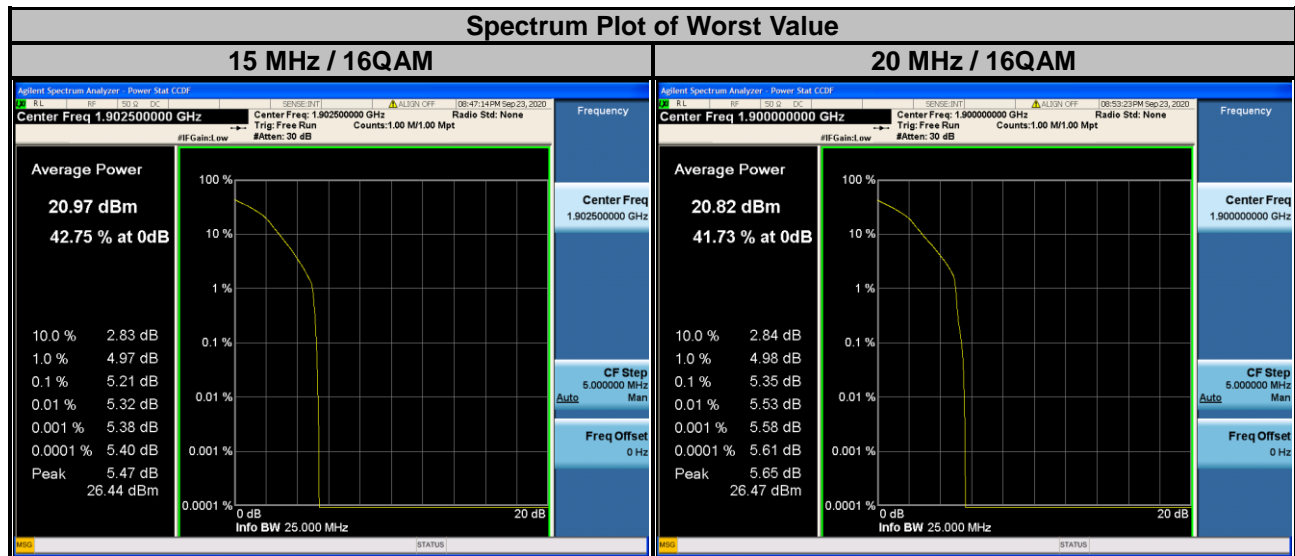

4.7 Conducted Spurious Emissions

4.7.1 Limits of Conducted Spurious Emissions Measurement

The power of any emission outside of the authorized operating frequency ranges must be attenuated below the transmitting power (P) by a factor of at least $43 + 10 \log(P)$ dB. The emission limit equal to -13 dBm.

4.7.2 Test Setup

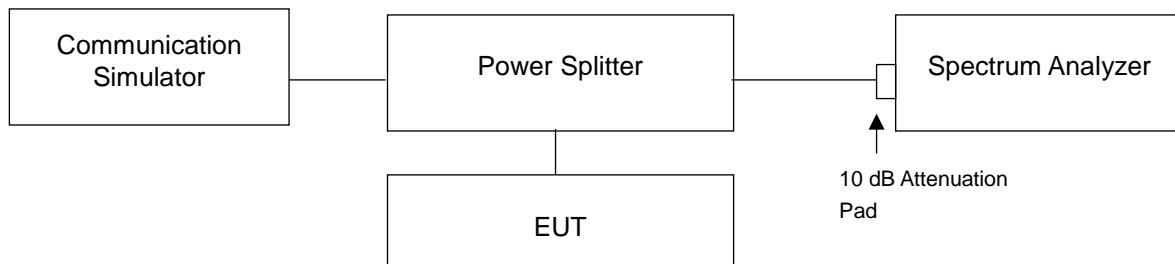

4.7.3 Test Procedure

- The EUT makes a phone call to the communication simulator. All measurements were done at low, middle and high operational frequency range.
- Measuring frequency range is from 9 kHz to 1 GHz. 10 dB attenuation pad is connected with spectrum. RBW = 1 MHz and VBW = 3 MHz is used for conducted emission measurement.
- Measuring frequency range is from 1 GHz to 20 GHz. 10 dB attenuation pad is connected with spectrum. RBW = 1 MHz and VBW = 3 MHz is used for conducted emission measurement.

4.7.4 Test Results

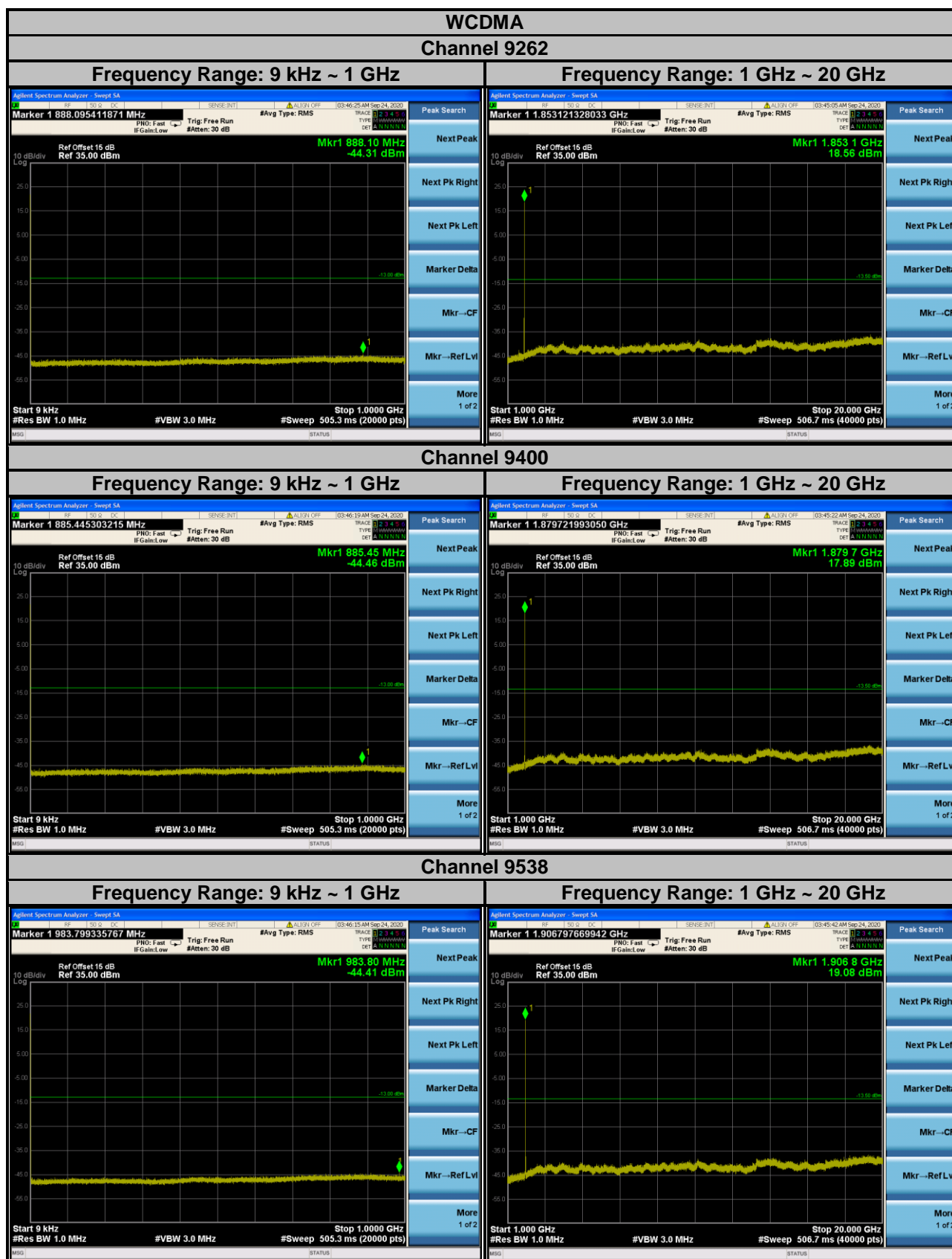

Note: The signal over the limit in 9 kHz is from spectrum analyzer.

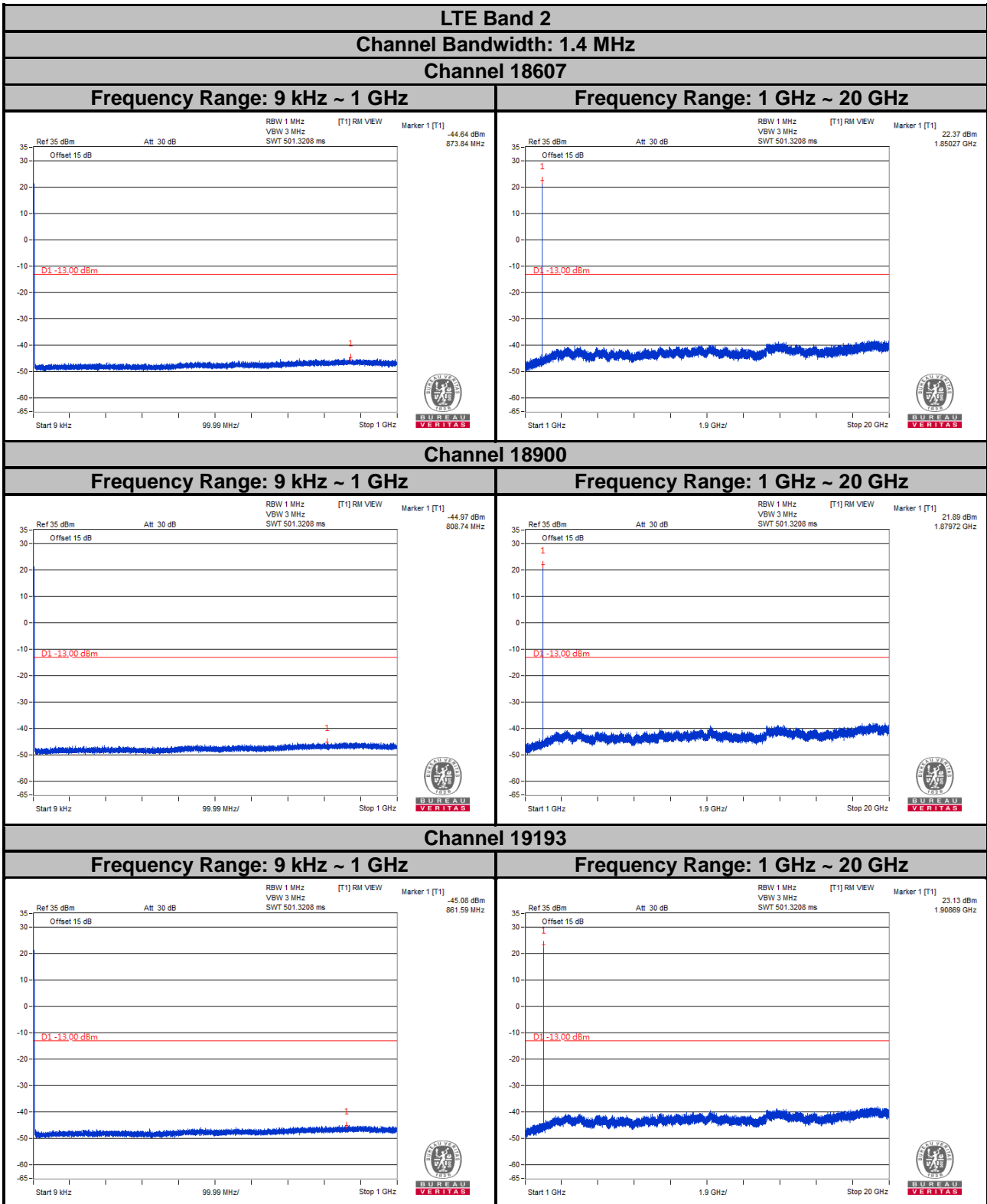

Note: The signal over the limit in 9 kHz is from spectrum analyzer.

LTE Band 2
Channel Bandwidth: 3 MHz

Channel 18615

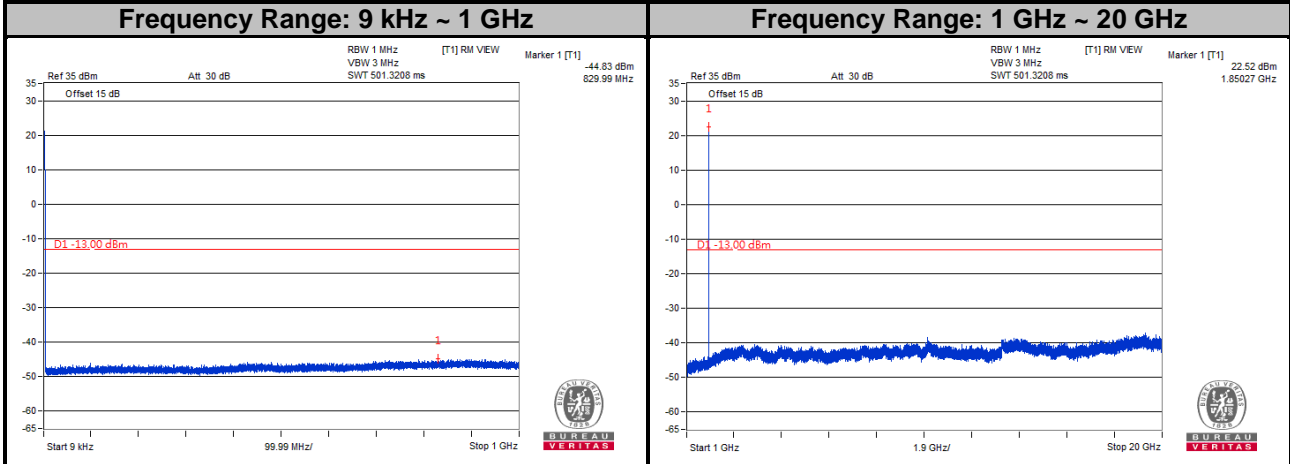

Channel 18900

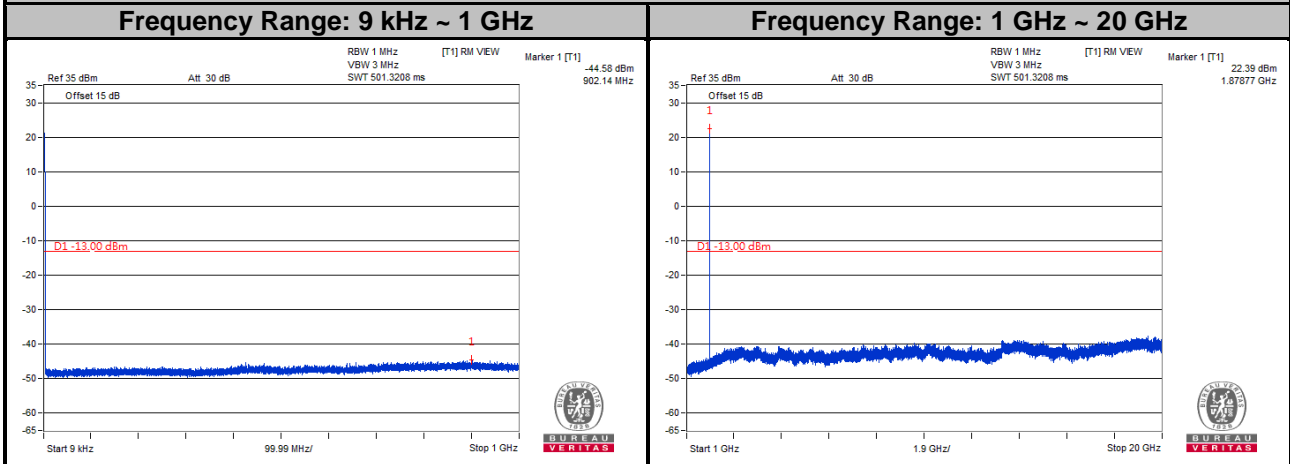

Channel 19185

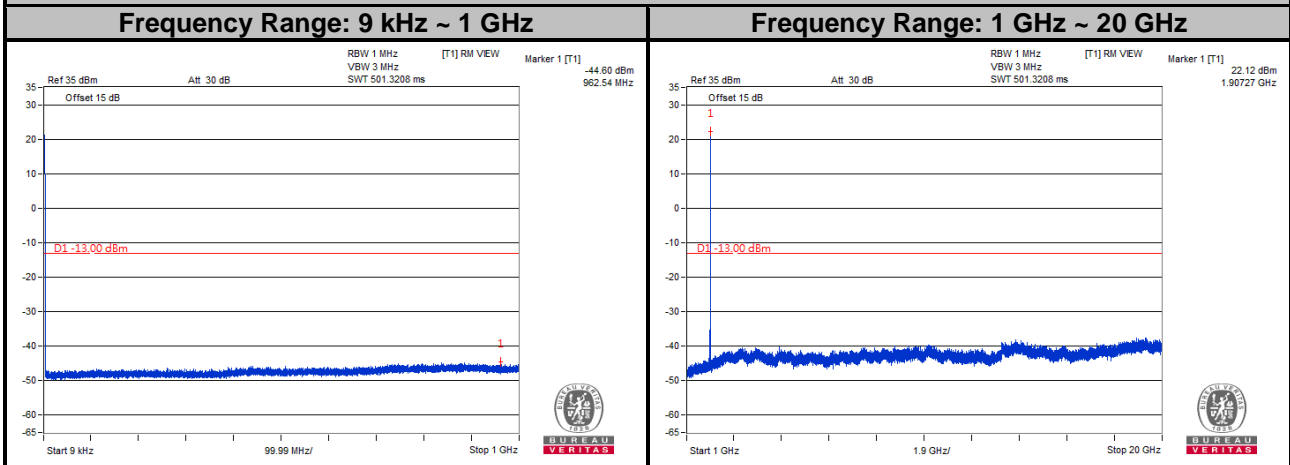

Note: The signal over the limit in 9 kHz is from spectrum analyzer.

LTE Band 2
Channel Bandwidth: 5 MHz

Channel 18625

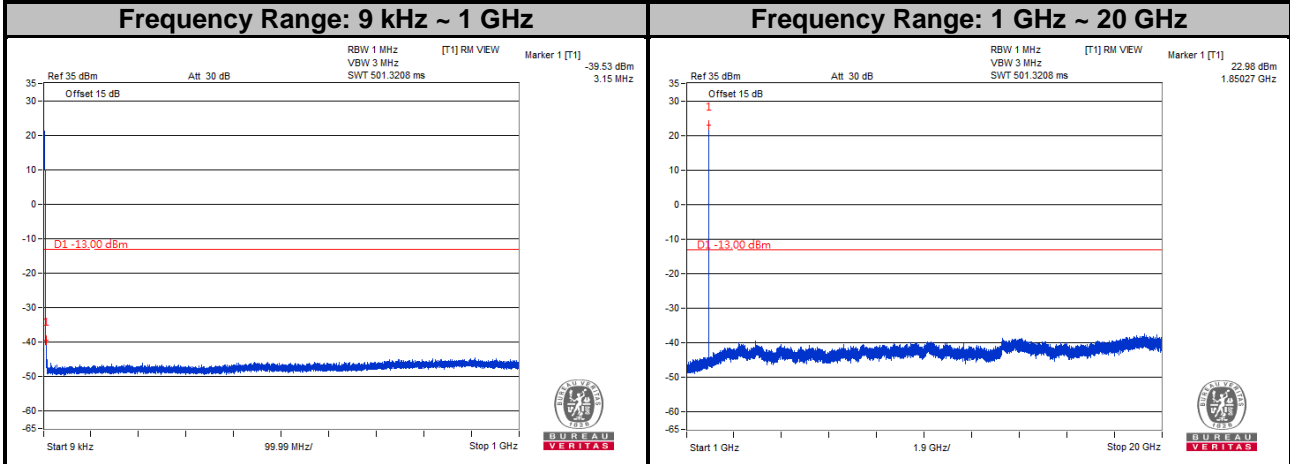

Channel 18900

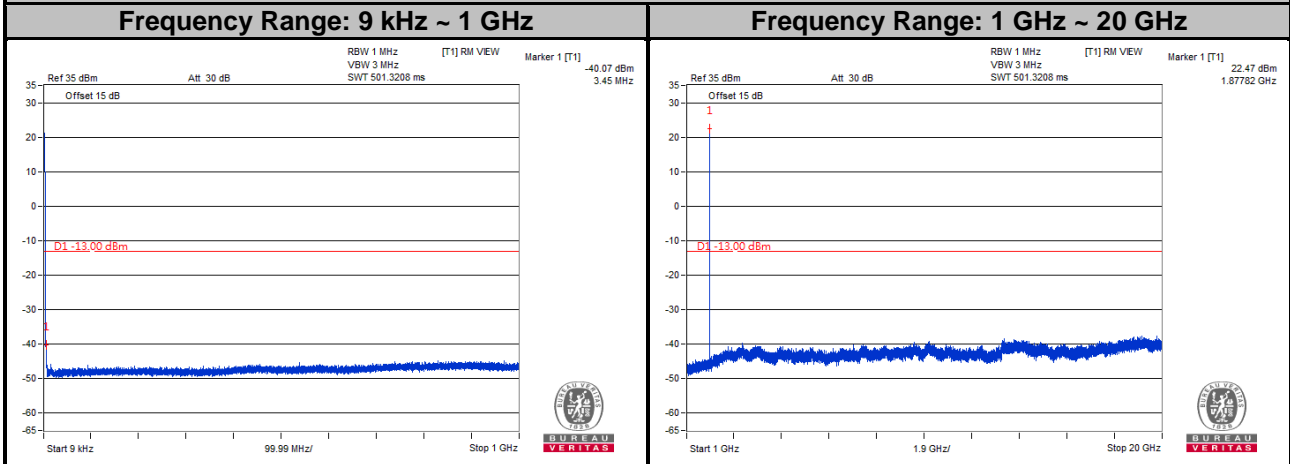

Channel 19175

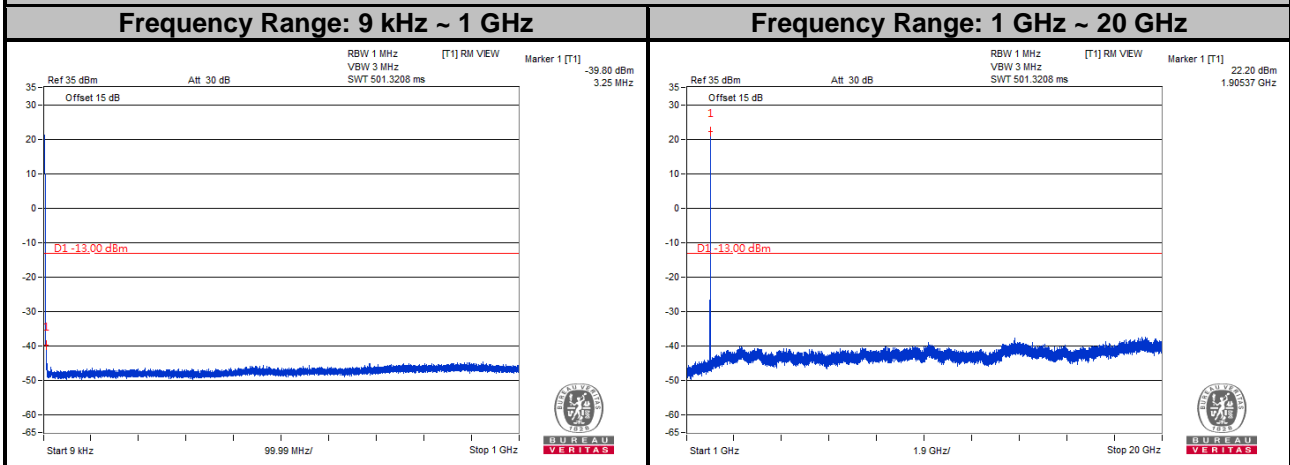

Note: The signal over the limit in 9 kHz is from spectrum analyzer.

LTE Band 2
Channel Bandwidth: 10 MHz

Channel 18650

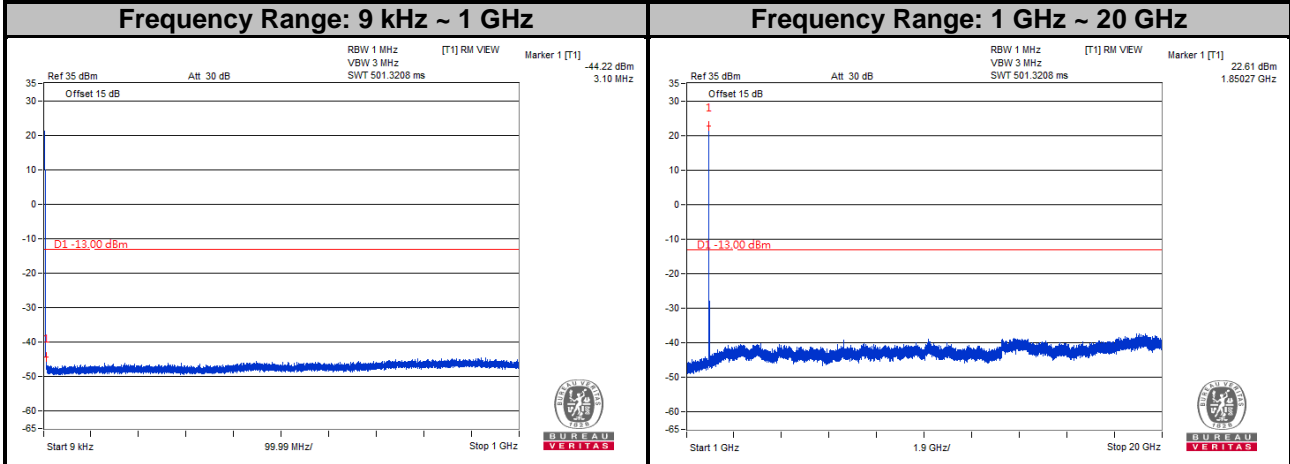

Channel 18900

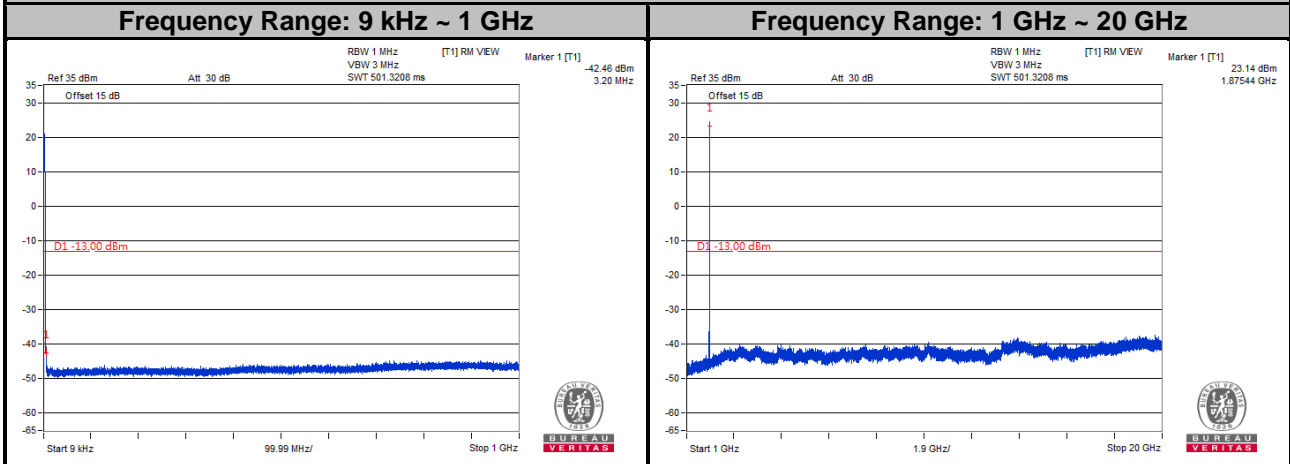

Channel 19150

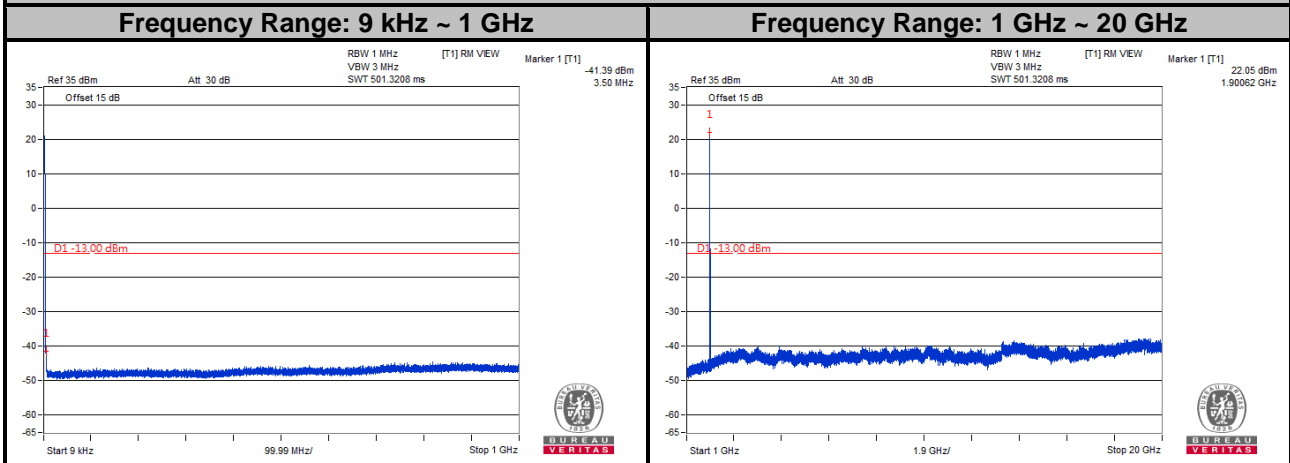

Note: The signal over the limit in 9 kHz is from spectrum analyzer.

LTE Band 2
Channel Bandwidth: 15 MHz
Channel 18675

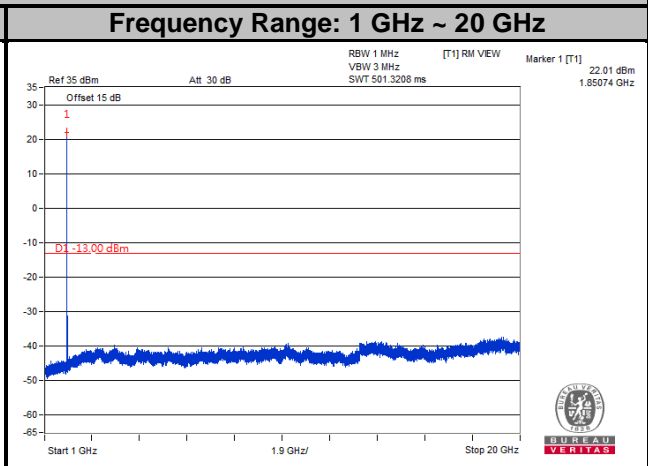
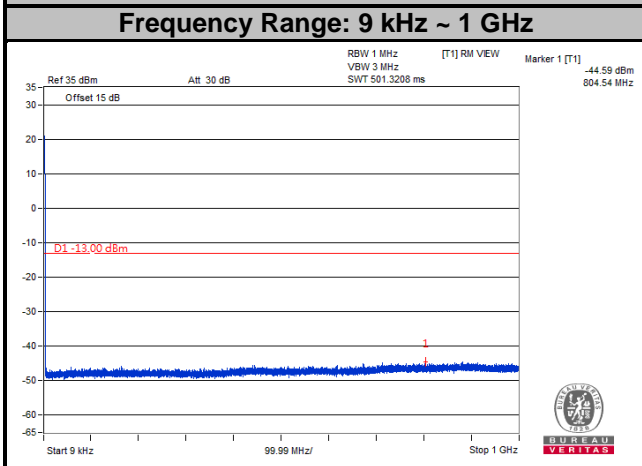

Channel 18900

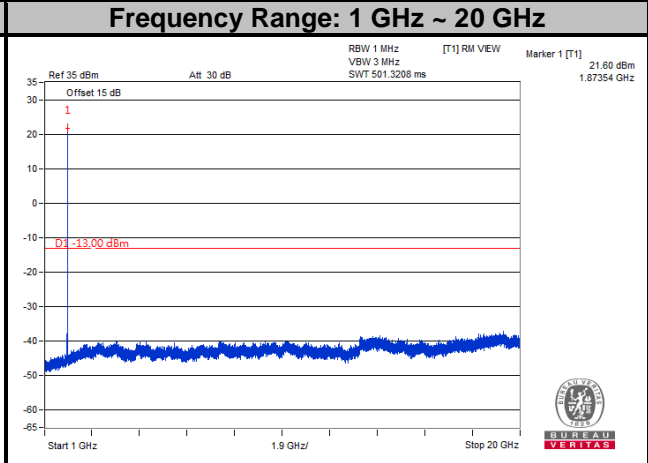
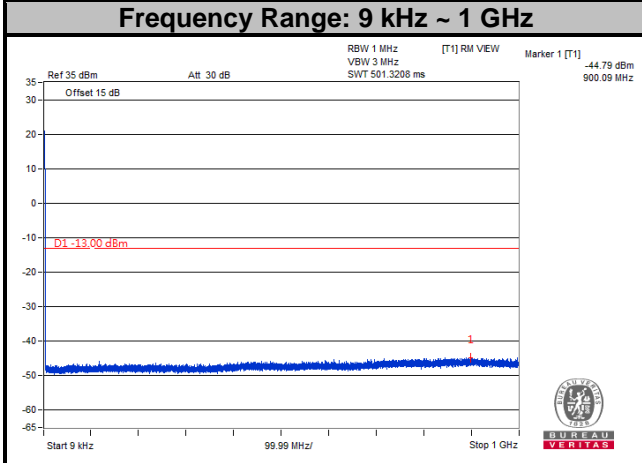

Channel 19125

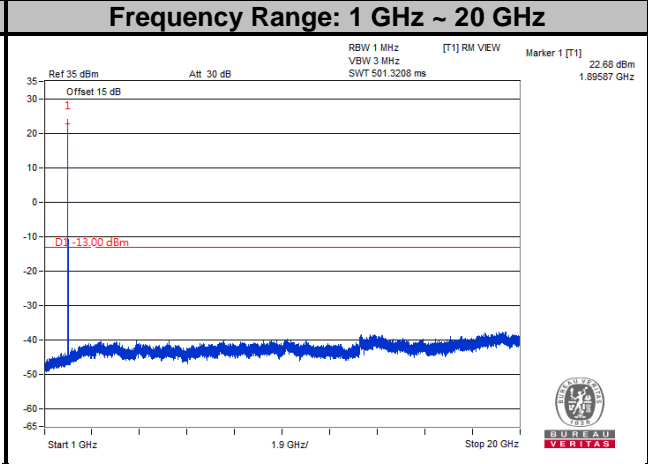
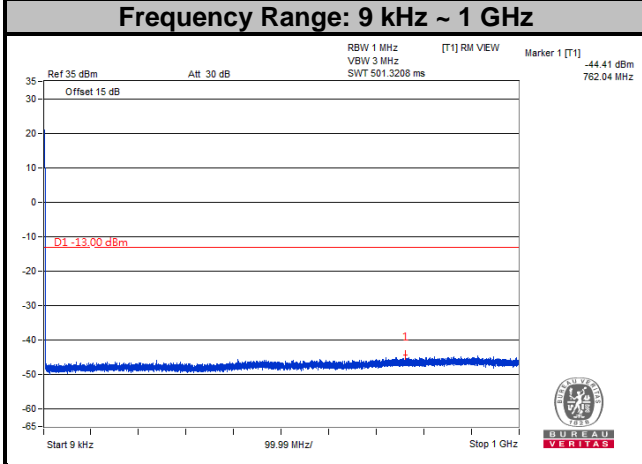

Note: The signal over the limit in 9 kHz is from spectrum analyzer.

LTE Band 2
Channel Bandwidth: 20 MHz
Channel 18700

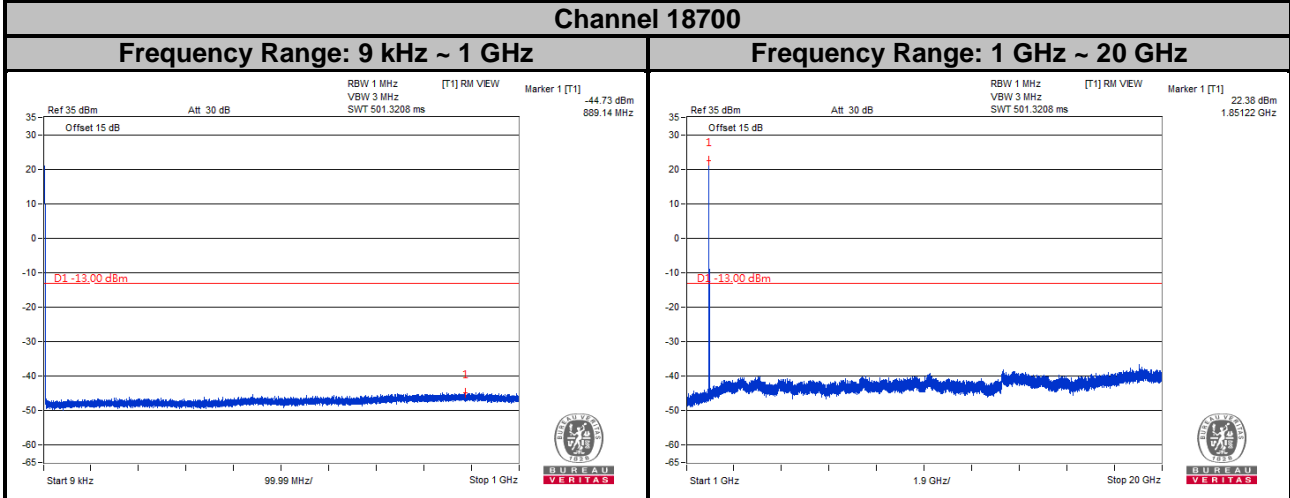

Channel 18900

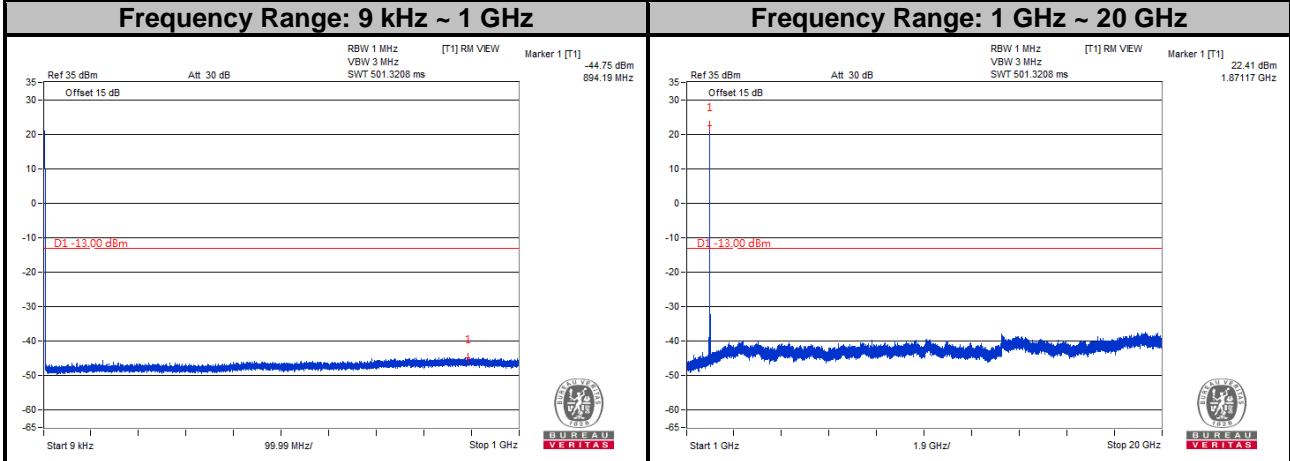

Channel 19100

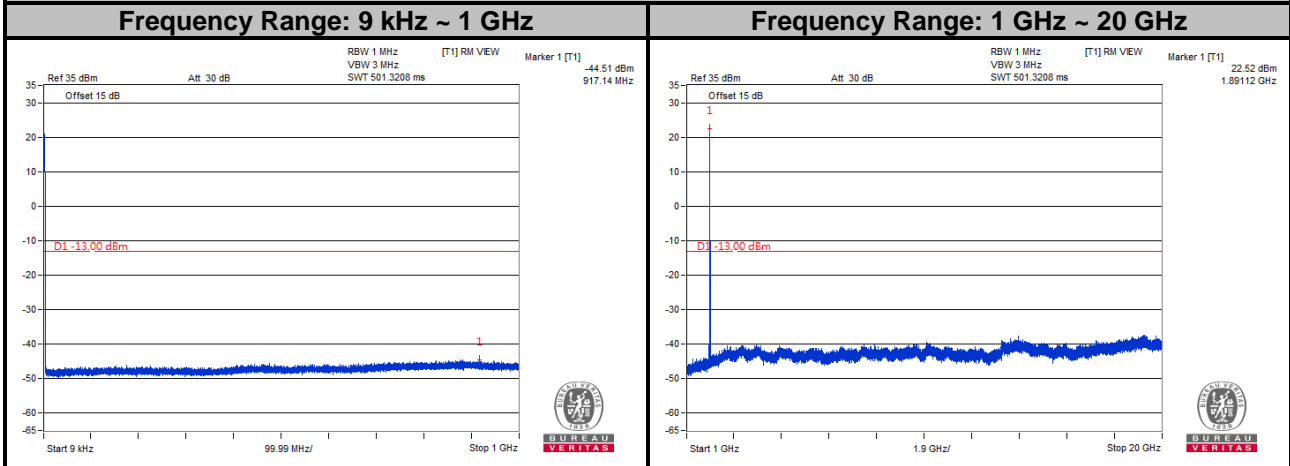

Note: The signal over the limit in 9 kHz is from spectrum analyzer.

4.8 Radiated Emission Measurement

4.8.1 Limits of Radiated Emission Measurement

The power of any emission outside of the authorized operating frequency ranges must be attenuated below the transmitting power (P) by a factor of at least $43 + 10 \log(P)$ dB. The emission limit is equal to -13 dBm.

4.8.2 Test Procedure

- a. Substitution method is used for E.I.R.P measurement. In the semi-anechoic chamber, EUT placed on the 0.8 m (below or equal 1 GHz) and/or 1.5 m (above 1 GHz) height of Turn Table, rotated the table around 360 degrees to search the maximum radiation power and receiver antenna shall be rotated vertical and horizontal polarization and moved height from 1 m to 4 m to find the maximum polar radiated power. The "Read Value" is the spectrum reading the maximum power value.
- b. EIRP = Output power level of S.G – TX cable loss + Antenna gain of substitution horn.
- c. E.R.P power can be calculated form E.I.R.P power by subtracting the gain of dipole, E.R.P power = E.I.R.P power - 2.15 dB.

NOTE:

1. The resolution bandwidth and video bandwidth of test receiver/spectrum analyzer is 1 MHz/3 MHz.
2. The emission levels were against the limit of frequency range 9 kHz ~ 30 MHz:

The amplitude of spurious emissions attenuated more than 20 dB below the permissible value is not required to be report

4.8.3 Deviation from Test Standard

No deviation.

4.8.4 Test Setup

<Radiated Emission below or equal 1 GHz>

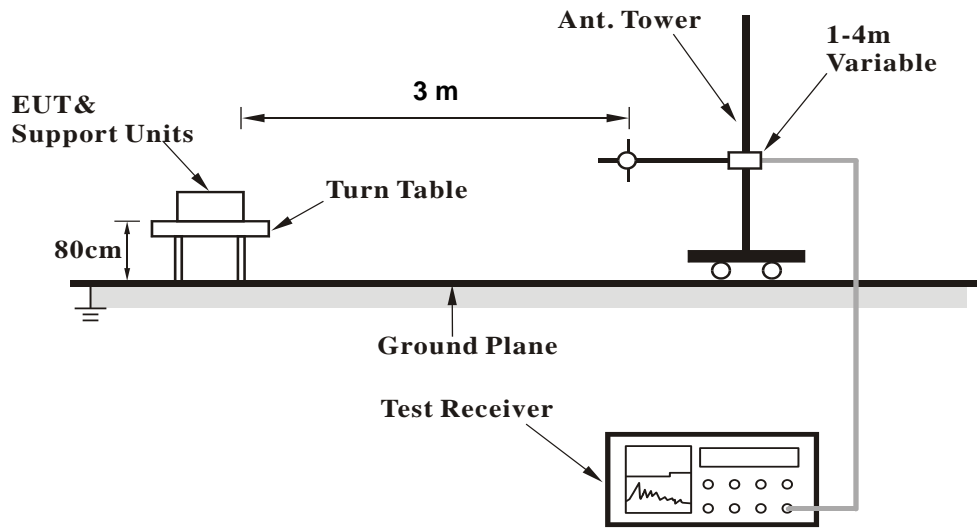

<Radiated Emission above 1 GHz>

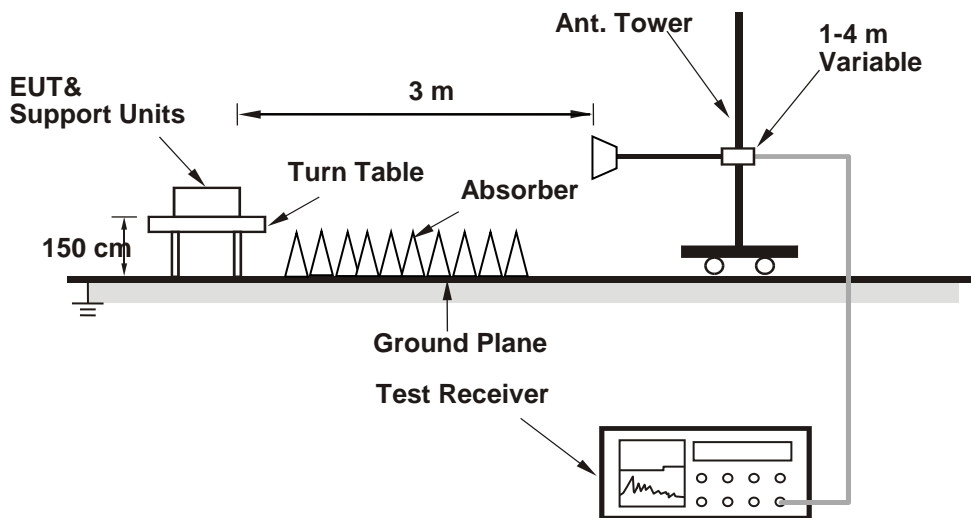

For the actual test configuration, please refer to the attached file (Test Setup Photo).

4.8.5 Test Results

Mode A

WCDMA:

Low Channel



Bureau Veritas Consumer Products Services Ltd., Taoyuan Branch

A D T

Data: 3

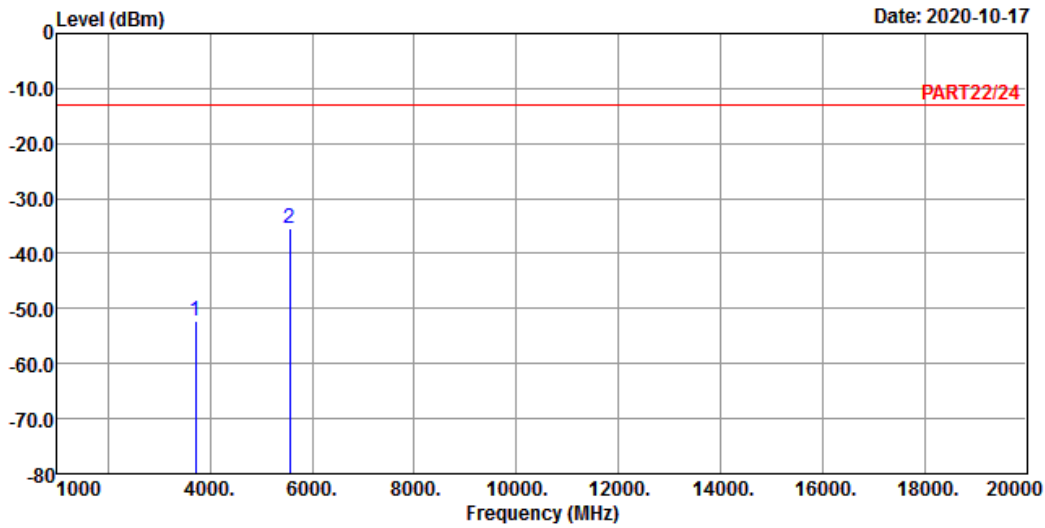

Site : 966 Chamber 5
 Condition: PART22/24 HORIZONTAL
 Remak : WCDMA Band 2 Link_L-CH
 Tested by: tim-chen

	Freq	Level	Read Level	Limit	Line Factor	Over Limit	Remark
	MHz	dBm	dBm	dBm	dB	dB	
1	3704.80	-52.26	-45.33	-13.00	-6.93	-39.26	Peak
2	5557.20	-35.50	-33.59	-13.00	-1.91	-22.50	Peak



Bureau Veritas Consumer Products Services Ltd., Taoyuan Branch

A D T

Data: 4

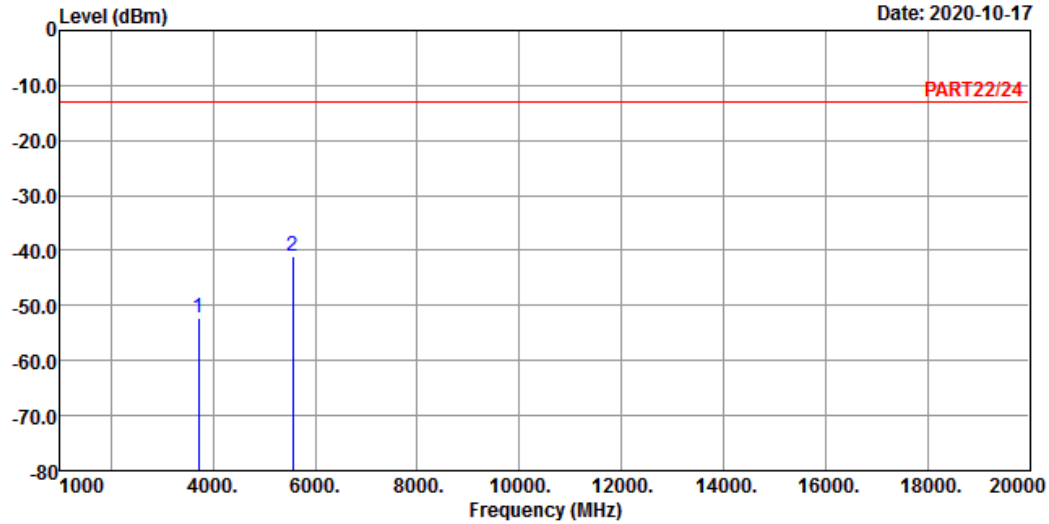

Site : 966 Chamber 5
 Condition: PART22/24 VERTICAL
 Remak : WCDMA Band 2 Link_L-CH
 Tested by: tim-chen

	Freq	Level	Read Level	Limit	Line Factor	Over Limit	Remark
	MHz	dBm	dBm	dBm	dB	dB	
1	3704.80	-52.20	-45.27	-13.00	-6.93	-39.20	Peak
2	5557.20	-40.95	-39.04	-13.00	-1.91	-27.95	Peak

Middle Channel



Bureau Veritas Consumer Products Services Ltd., Taoyuan Branch

A D T

Data: 3

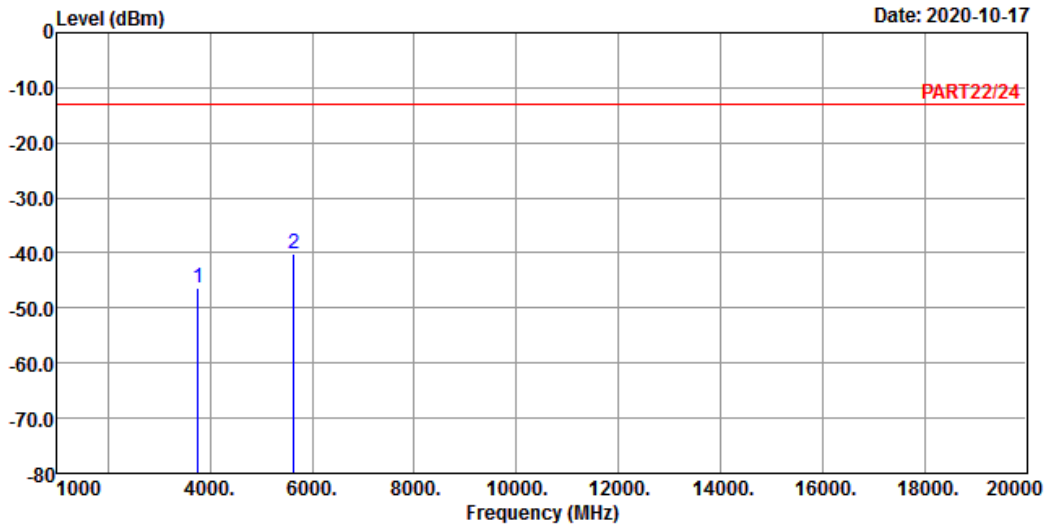

Site : 966 Chamber 5
 Condition: PART22/24 HORIZONTAL
 Remak : WCDMA Band 2 Link_M-CH
 Tested by: tim-chen

	Freq	Level	Read Level	Limit	Line Factor	Over Limit	Remark
	MHz	dBm	dBm	dBm	dB	dB	
1	3760.00	-46.34	-39.69	-13.00	-6.65	-33.34	Peak
2 pp	5640.00	-40.03	-38.17	-13.00	-1.86	-27.03	Peak



Bureau Veritas Consumer Products Services Ltd., Taoyuan Branch

A D T

Data: 4

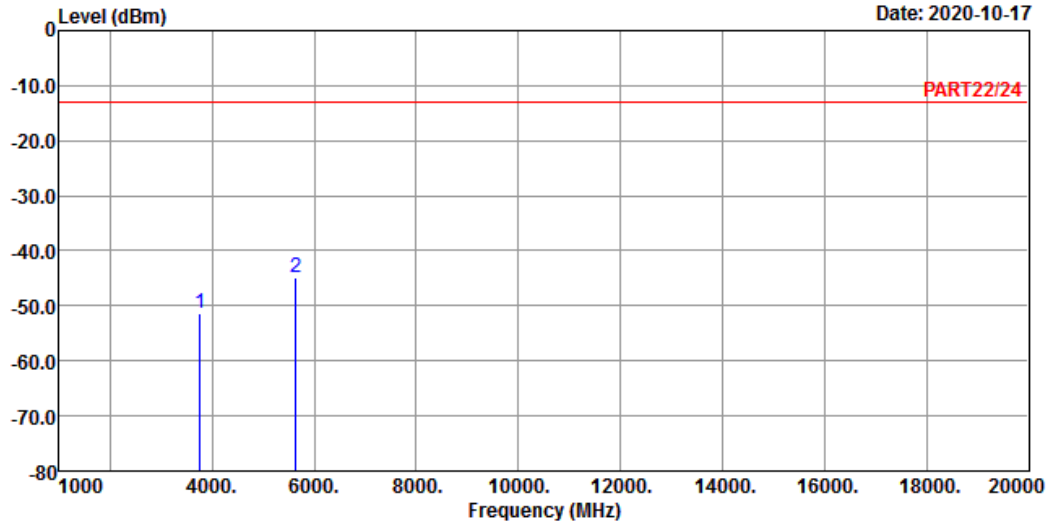

Site : 966 Chamber 5
 Condition: PART22/24 VERTICAL
 Remak : WCDMA Band 2 Link_M-CH
 Tested by: tim-chen

	Freq	Level	Read Level	Limit	Line Factor	Over Limit	Remark
	MHz	dBm	dBm	dBm	dB	dB	
1	3760.00	-51.38	-44.73	-13.00	-6.65	-38.38	Peak
2 pp	5640.00	-44.93	-43.07	-13.00	-1.86	-31.93	Peak

High Channel



Bureau Veritas Consumer Products Services Ltd., Taoyuan Branch

A D T

Data: 5

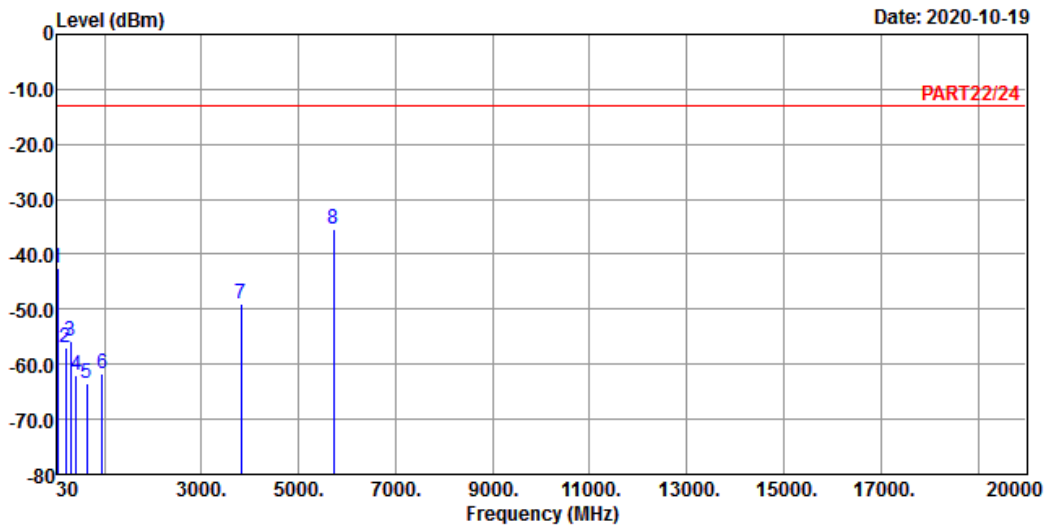

Site : 966 Chamber 5
 Condition: PART22/24 HORIZONTAL
 Remak : WCDMA Band 2 Link_H-CH
 Tested by: tim-chen

	Freq	Level	Read Level	Limit Line	Over Factor	Over Limit	Remark
	MHz	dBm	dBm	dBm	dB	dB	
1	42.61	-42.39	-41.45	-13.00	-0.94	-29.39	Peak
2	210.42	-56.90	-49.31	-13.00	-7.59	-43.90	Peak
3	310.33	-55.71	-48.86	-13.00	-6.85	-42.71	Peak
4	426.73	-62.08	-56.35	-13.00	-5.73	-49.08	Peak
5	640.13	-63.61	-62.75	-13.00	-0.86	-50.61	Peak
6	955.38	-61.78	-63.78	-13.00	2.00	-48.78	Peak
7	3815.20	-48.90	-42.50	-13.00	-6.40	-35.90	Peak
8 pp	5722.80	-35.36	-33.67	-13.00	-1.69	-22.36	Peak



Bureau Veritas Consumer Products Services Ltd., Taoyuan Branch

A D T

Data: 6

Date: 2020-10-19

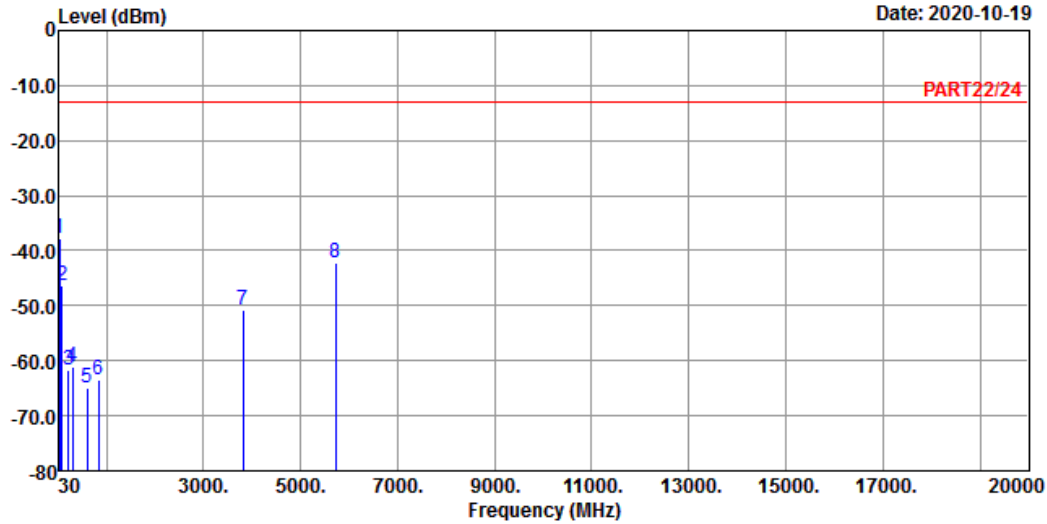

Site : 966 Chamber 5
 Condition: PART22/24 VERTICAL
 Remak : WCDMA Band 2 Link_H-CH
 Tested by: tim-chen

	Freq	Level	Read Level	Limit Line	Over Factor	Over Limit	Remark
	MHz	dBm	dBm	dBm	dB	dB	
1 pp	42.61	-37.69	-36.75	-13.00	-0.94	-24.69	Peak
2	77.53	-46.45	-36.25	-13.00	-10.20	-33.45	Peak
3	220.12	-61.79	-54.59	-13.00	-7.20	-48.79	Peak
4	307.42	-61.09	-54.20	-13.00	-6.89	-48.09	Peak
5	599.39	-64.86	-64.07	-13.00	-0.79	-51.86	Peak
6	831.22	-63.39	-63.85	-13.00	0.46	-50.39	Peak
7	3815.20	-50.91	-44.51	-13.00	-6.40	-37.91	Peak
8	5722.80	-42.35	-40.66	-13.00	-1.69	-29.35	Peak

LTE Band 2
 Channel Bandwidth: 1.4 MHz / QPSK
 Low Channel



Bureau Veritas Consumer Products Services Ltd., Taoyuan Branch

A D T

Data: 3

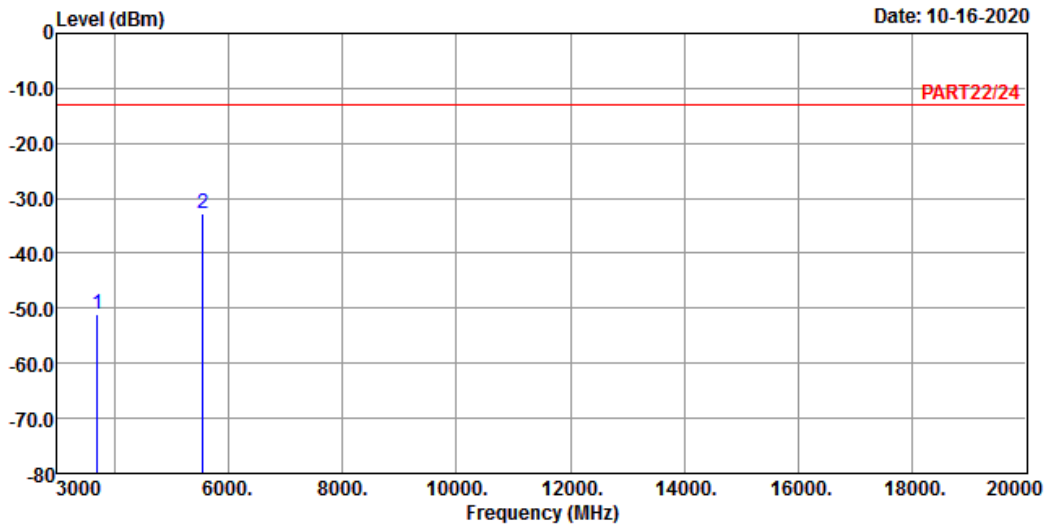

Site : 966 Chamber 5
 Condition: PART22/24 HORIZONTAL
 Remak : LTE Band 2 QPSK_1.4M Link_L-CH
 Tested by: Cyril Chen

	Freq	Level	Read Level	Limit	Line Factor	Over Limit	Remark
	MHz	dBm	dBm	dBm	dB	dB	
1	3701.40	-50.97	-44.04	-13.00	-6.93	-37.97	Peak
2	5552.10	-32.87	-30.97	-13.00	-1.90	-19.87	Peak



Bureau Veritas Consumer Products Services Ltd., Taoyuan Branch

A D T

Data: 4

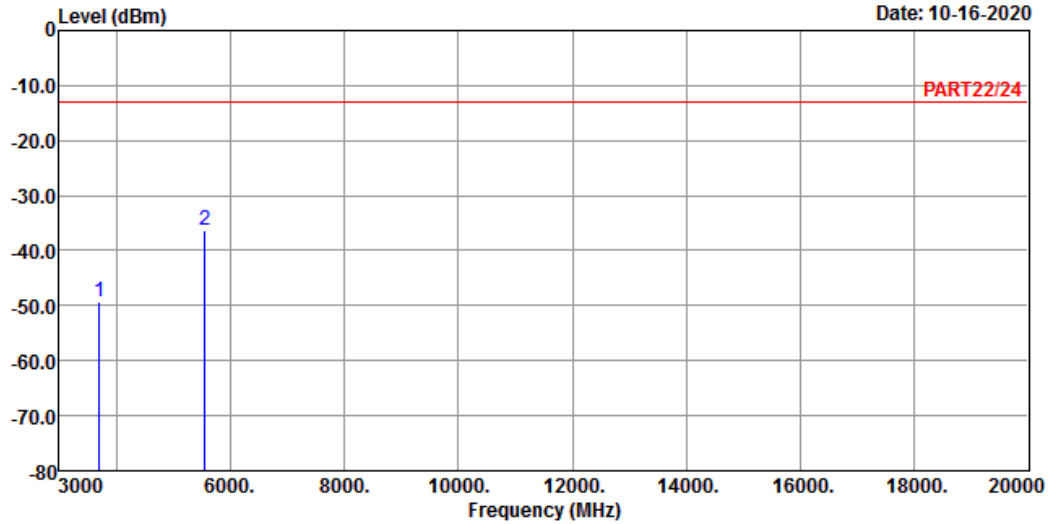

Site : 966 Chamber 5
 Condition: PART22/24 VERTICAL
 Remak : LTE Band 2 QPSK_1.4M Link_L-CH
 Tested by: Cyril Chen

	Freq	Level	Read Level	Limit	Line Factor	Over Limit	Remark
	MHz	dBm	dBm	dBm	dB	dB	
1	3701.40	-49.20	-42.27	-13.00	-6.93	-36.20	Peak
2	5552.10	-36.27	-34.37	-13.00	-1.90	-23.27	Peak

Middle Channel



Bureau Veritas Consumer Products Services Ltd., Taoyuan Branch

A D T

Data: 3

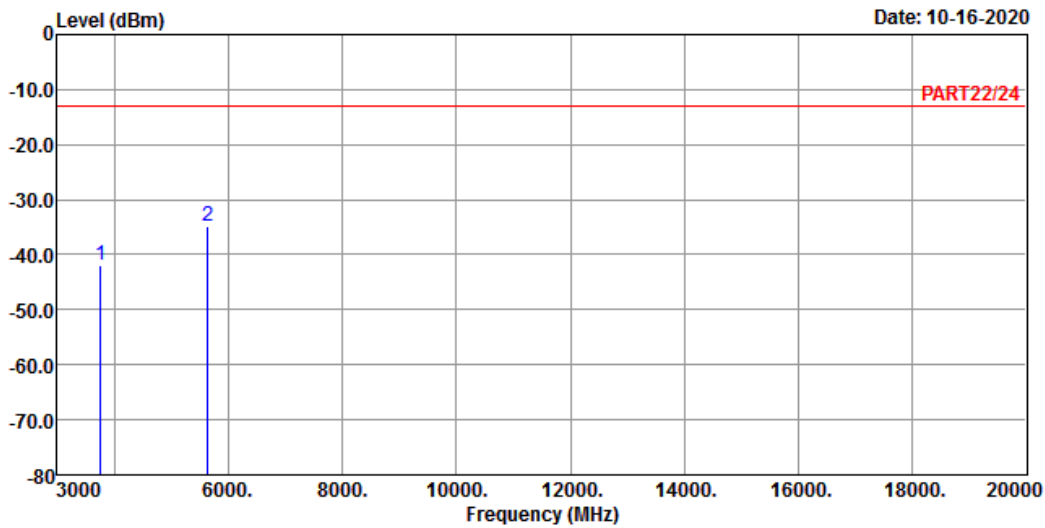

Site : 966 Chamber 5
 Condition: PART22/24 HORIZONTAL
 Remak : LTE Band 2 QPSK_1.4M Link_M-CH
 Tested by: Cyril Chen

	Freq	Level	Read Level	Limit	Line Factor	Over Limit	Remark
	MHz	dBm	dBm	dBm	dB	dB	
1	3760.00	-42.00	-35.35	-13.00	-6.65	-29.00	Peak
2 pp	5640.00	-34.85	-32.99	-13.00	-1.86	-21.85	Peak



Bureau Veritas Consumer Products Services Ltd., Taoyuan Branch

A D T

Data: 4

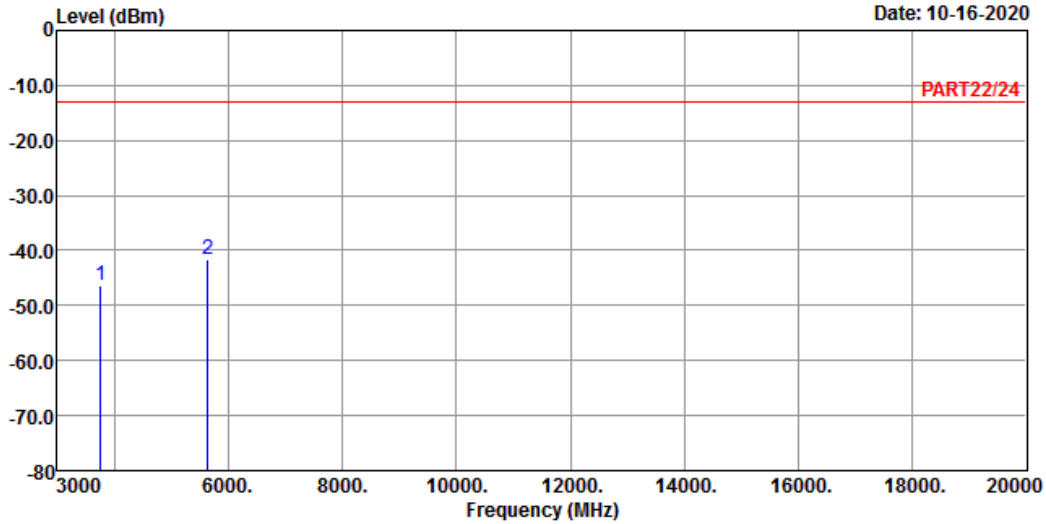

Site : 966 Chamber 5
 Condition: PART22/24 VERTICAL
 Remak : LTE Band 2 QPSK_1.4M Link_M-CH
 Tested by: Cyril Chen

	Read	Limit	Over			
Freq	Level	Level	Line	Factor	Limit	Remark
MHz	dBm	dBm	dBm	dB	dB	
1	3760.00	-46.28	-39.63	-13.00	-6.65	-33.28 Peak
2 pp	5640.00	-41.57	-39.71	-13.00	-1.86	-28.57 Peak

High Channel



Bureau Veritas Consumer Products Services Ltd., Taoyuan Branch

A D T

Data: 3

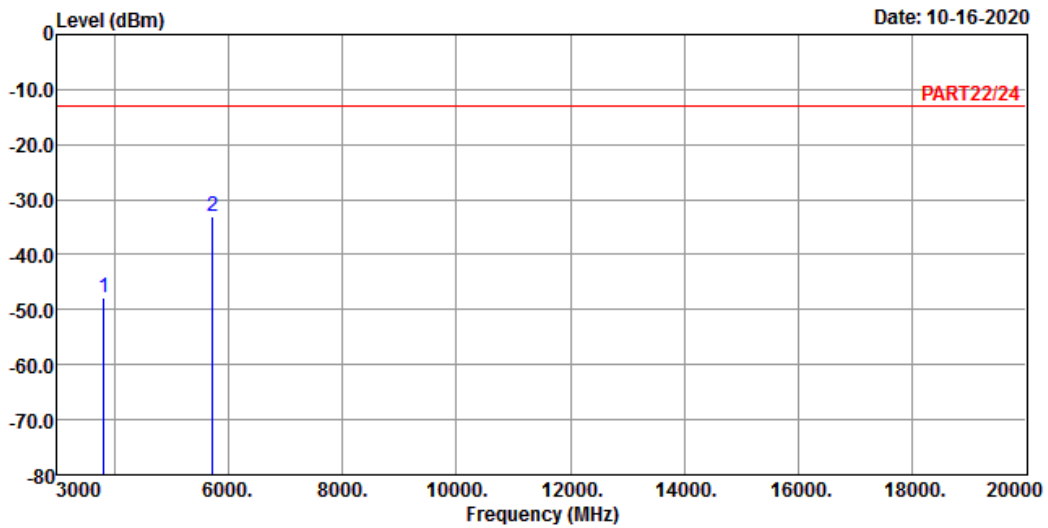

Site : 966 Chamber 5
 Condition: PART22/24 HORIZONTAL
 Remak : LTE Band 2 QPSK_1.4M Link_H-CH
 Tested by: Cyril Chen

	Freq	Level	Read Level	Limit	Line Factor	Over Limit	Remark
	MHz	dBm	dBm	dBm	dB	dB	
1	3818.60	-47.70	-41.30	-13.00	-6.40	-34.70	Peak
2 pp	5727.90	-33.14	-31.49	-13.00	-1.65	-20.14	Peak



Bureau Veritas Consumer Products Services Ltd., Taoyuan Branch

A D T

Data: 4

Date: 10-16-2020

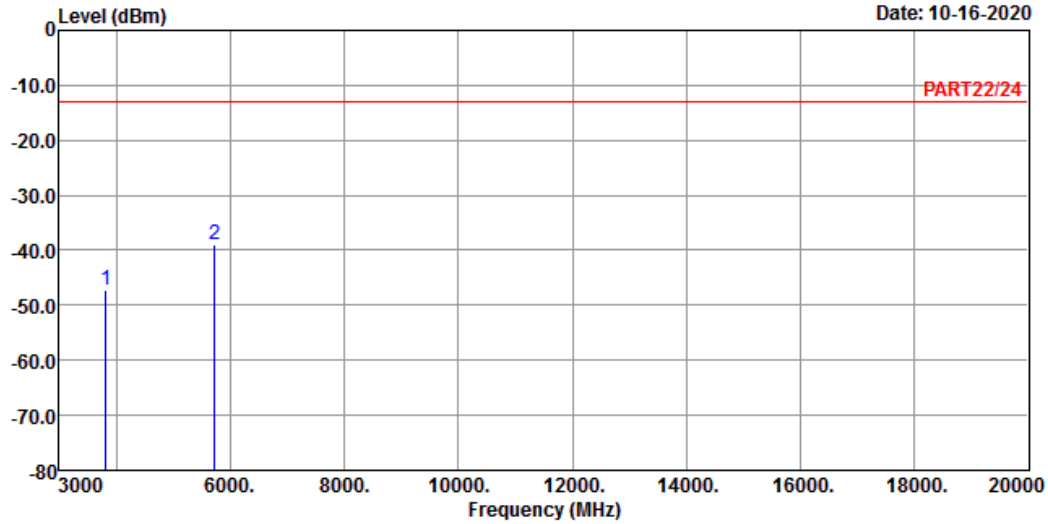

Site : 966 Chamber 5
 Condition: PART22/24 VERTICAL
 Remak : LTE Band 2 QPSK_1.4M Link_H-CH
 Tested by: Cyril Chen

	Freq	Level	Read Level	Limit	Line Factor	Over Limit	Remark
	MHz	dBm	dBm	dBm	dB	dB	
1	3818.60	-47.34	-40.94	-13.00	-6.40	-34.34	Peak
2	5727.90	-38.98	-37.33	-13.00	-1.65	-25.98	Peak

Channel Bandwidth: 5 MHz / QPSK
 Low Channel



Bureau Veritas Consumer Products Services Ltd., Taoyuan Branch

A D T

Data: 3

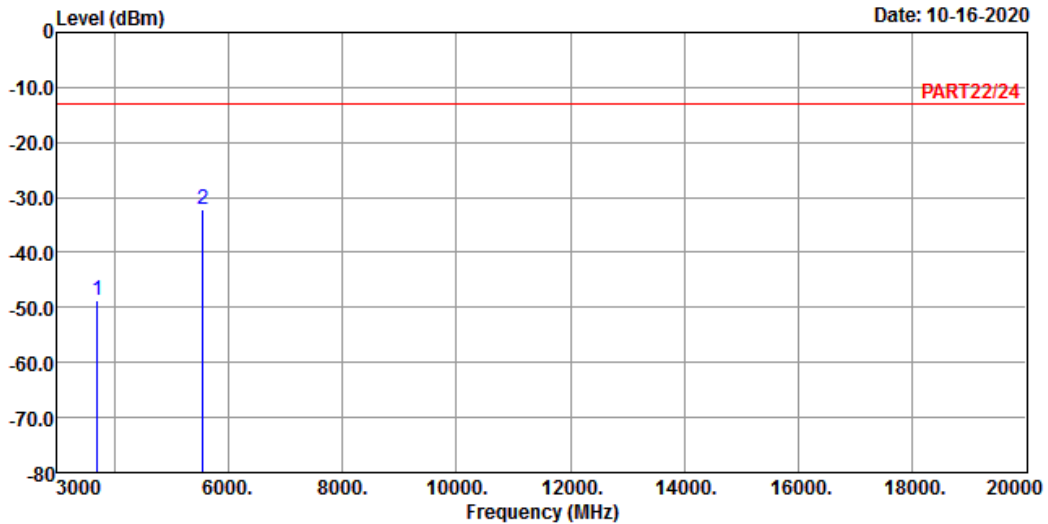

Site : 966 Chamber 5
 Condition: PART22/24 HORIZONTAL
 Remak : LTE Band 2 QPSK_5M Link_L-CH
 Tested by: Cyril Chen

	Freq	Level	Read Level	Limit	Line Factor	Over Limit	Remark
	MHz	dBm	dBm	dBm	dB	dB	
1	3705.00	-48.77	-41.84	-13.00	-6.93	-35.77	Peak
2 pp	5557.50	-32.21	-30.30	-13.00	-1.91	-19.21	Peak



Bureau Veritas Consumer Products Services Ltd., Taoyuan Branch

A D T

Data: 4

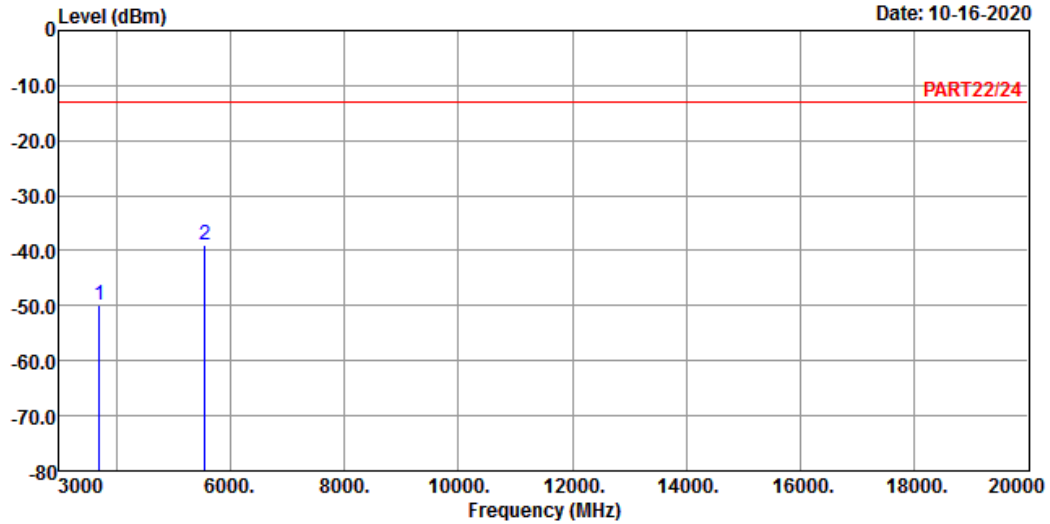

Site : 966 Chamber 5
 Condition: PART22/24 VERTICAL
 Remak : LTE Band 2 QPSK_5M Link_L-CH
 Tested by: Cyril Chen

	Freq	Level	Read Level	Limit	Line Factor	Over Limit	Remark
	MHz	dBm	dBm	dBm	dB	dB	
1	3705.00	-49.95	-43.02	-13.00	-6.93	-36.95	Peak
2	5557.50	-38.98	-37.07	-13.00	-1.91	-25.98	Peak

Middle Channel



Bureau Veritas Consumer Products Services Ltd., Taoyuan Branch

A D T

Data: 3

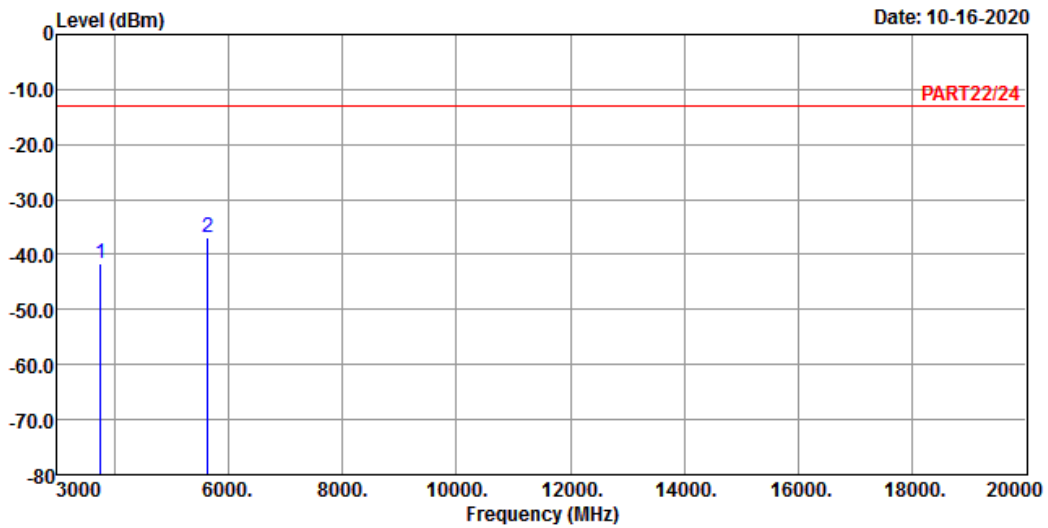

Site : 966 Chamber 5
 Condition: PART22/24 HORIZONTAL
 Remak : LTE Band 2 QPSK_5M Link_M-CH
 Tested by: Cyril Chen

	Freq MHz	Level dBm	Read	Limit	Over		Remark
			Level dBm	Line dBm	Factor dB	Limit dB	
1	3760.00	-41.76	-35.11	-13.00	-6.65	-28.76	Peak
2 pp	5640.00	-36.76	-34.90	-13.00	-1.86	-23.76	Peak



Bureau Veritas Consumer Products Services Ltd., Taoyuan Branch

A D T

Data: 4

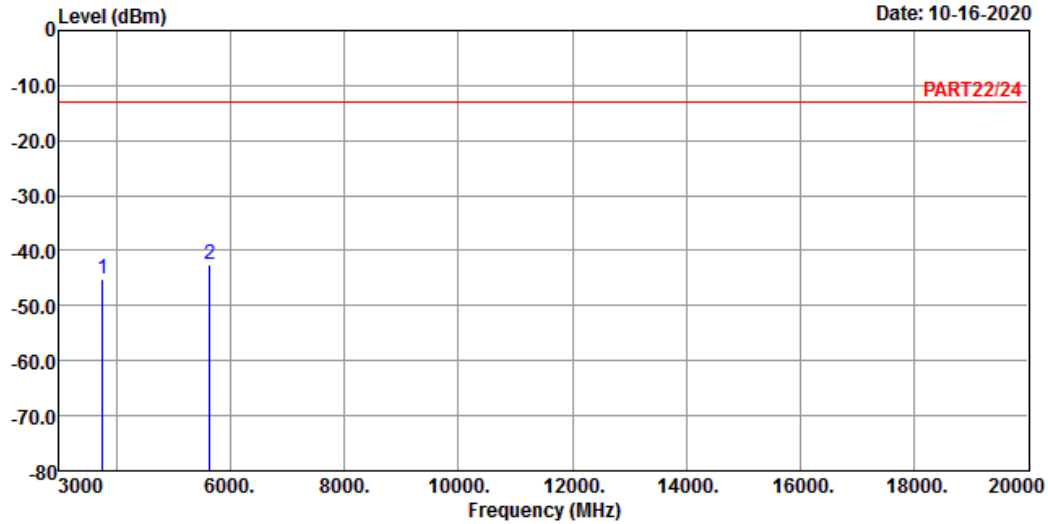

Site : 966 Chamber 5
 Condition: PART22/24 VERTICAL
 Remak : LTE Band 2 QPSK_5M Link_M-CH
 Tested by: Cyril Chen

	Freq	Level	Read Level	Limit	Line	Factor	Over Limit	Remark
	MHz	dBm	dBm	dBm		dB	dB	
1	3760.00	-45.14	-38.49	-13.00		-6.65	-32.14	Peak
2	5640.00	-42.60	-40.74	-13.00		-1.86	-29.60	Peak

High Channel



Bureau Veritas Consumer Products Services Ltd., Taoyuan Branch

A D T

Data: 3

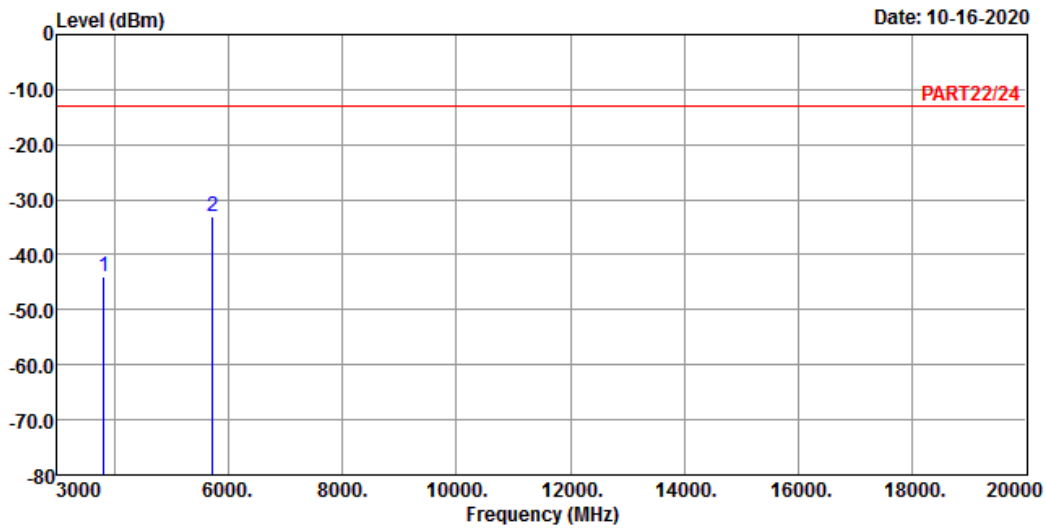

Site : 966 Chamber 5
 Condition: PART22/24 HORIZONTAL
 Remak : LTE Band 2 QPSK_5M Link_H-CH
 Tested by: Cyril Chen

	Freq	Level	Read	Limit	Over		Remark
			Level	Line	Factor	Limit	
	MHz	dBm	dBm	dBm	dB	dB	
1	3815.00	-43.84	-37.44	-13.00	-6.40	-30.84	Peak
2 pp	5722.50	-32.92	-31.23	-13.00	-1.69	-19.92	Peak



Bureau Veritas Consumer Products Services Ltd., Taoyuan Branch

A D T

Data: 4

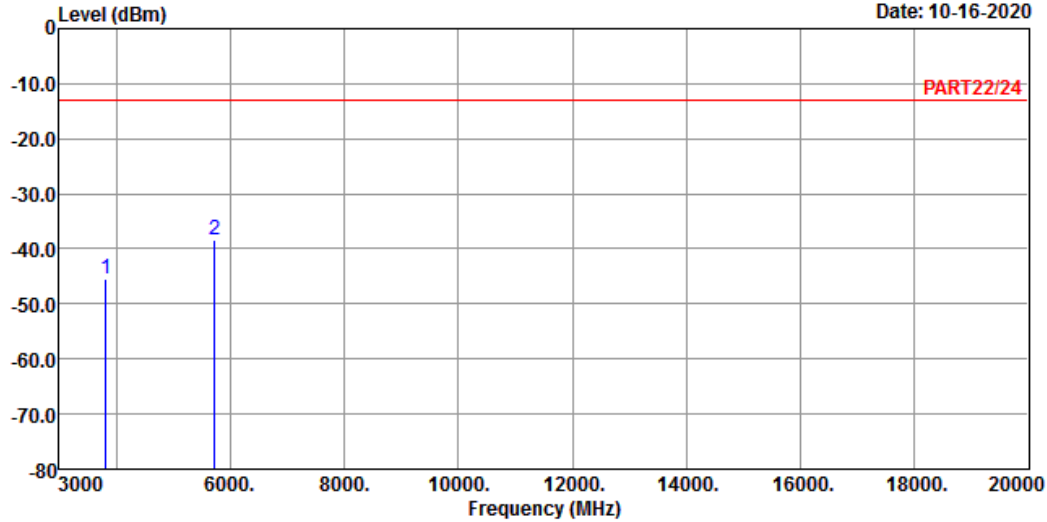

Site : 966 Chamber 5
 Condition: PART22/24 VERTICAL
 Remak : LTE Band 2 QPSK_5M Link_H-CH
 Tested by: Cyril Chen

	Freq	Level	Read Level	Limit	Line Factor	Over Limit	Remark
	MHz	dBm	dBm	dBm	dB	dB	
1	3815.00	-45.34	-38.94	-13.00	-6.40	-32.34	Peak
2	5722.50	-38.49	-36.80	-13.00	-1.69	-25.49	Peak

Channel Bandwidth: 20 MHz / QPSK
Low Channel



Bureau Veritas Consumer Products Services Ltd., Taoyuan Branch

A D T

Data: 3

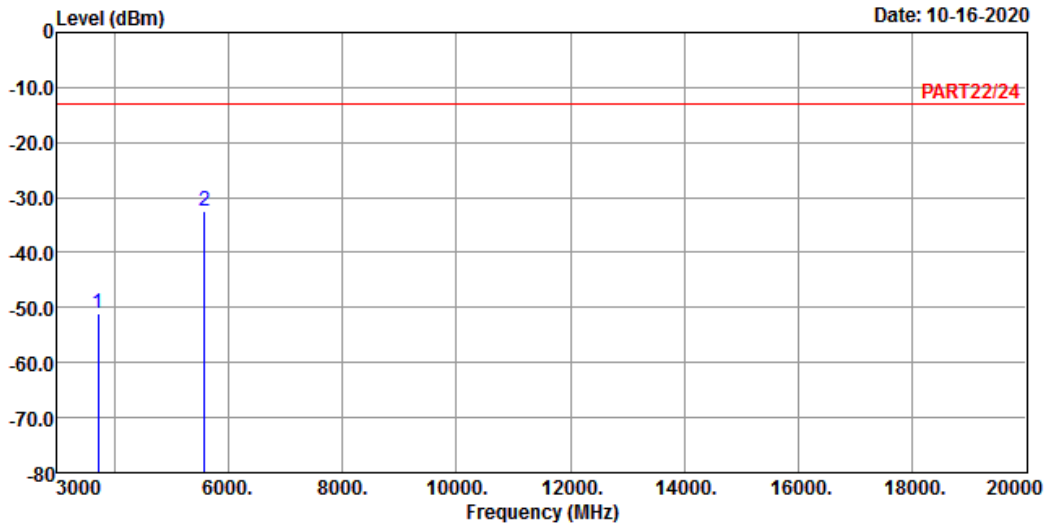

Site : 966 Chamber 5
Condition: PART22/24 HORIZONTAL
Remak : LTE Band 2 QPSK_20M Link_L-CH
Tested by: Cyril Chen

	Freq	Level	Read Level	Limit	Line Factor	Over Limit	Remark
	MHz	dBm	dBm	dBm	dB	dB	
1	3720.00	-50.94	-44.12	-13.00	-6.82	-37.94	Peak
2 pp	5580.00	-32.41	-30.49	-13.00	-1.92	-19.41	Peak



Bureau Veritas Consumer Products Services Ltd., Taoyuan Branch

A D T

Data: 4

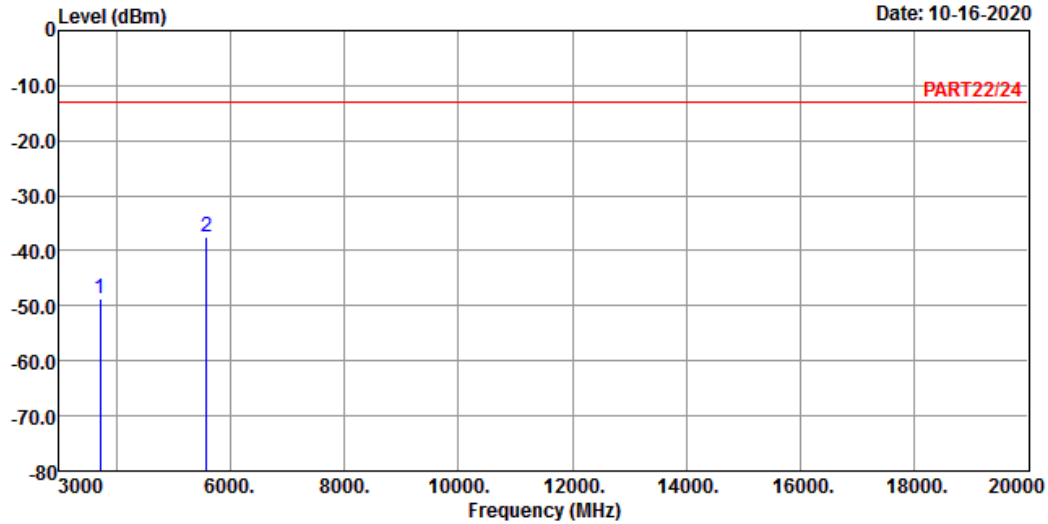

Site : 966 Chamber 5
 Condition: PART22/24 VERTICAL
 Remak : LTE Band 2 QPSK_20M Link_L-CH
 Tested by: Cyril Chen

	Freq	Level	Read Level	Limit	Line Factor	Over Limit	Remark
	MHz	dBm	dBm	dBm	dB	dB	
1	3720.00	-48.78	-41.96	-13.00	-6.82	-35.78	Peak
2	5580.00	-37.58	-35.66	-13.00	-1.92	-24.58	Peak

Middle Channel



Bureau Veritas Consumer Products Services Ltd., Taoyuan Branch

A D T

Data: 3

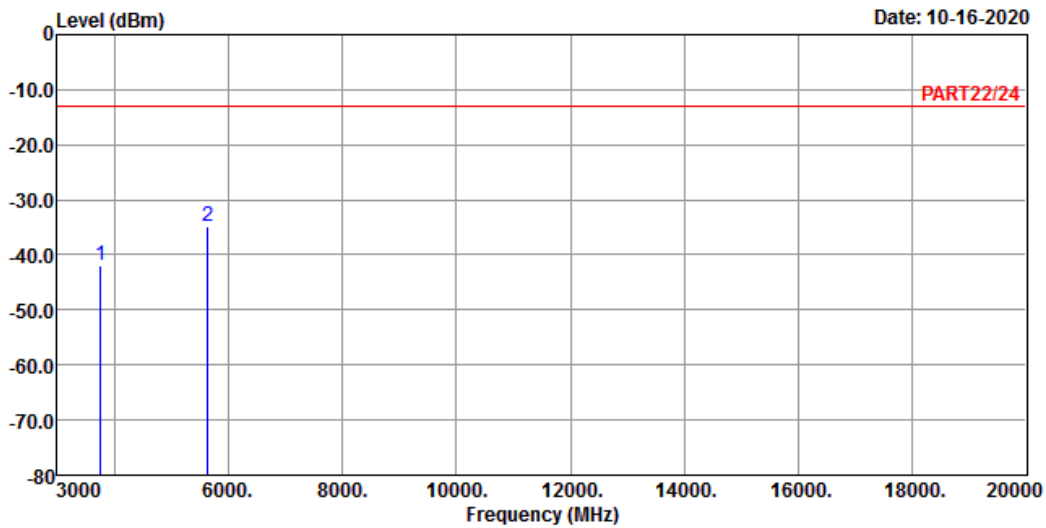

Site : 966 Chamber 5
 Condition: PART22/24 HORIZONTAL
 Remak : LTE Band 2 QPSK_20M Link_M-CH
 Tested by: Cyril Chen

	Freq MHz	Level dBm	Read	Limit	Over		Remark
			Level dBm	Line dBm	Factor dB	Limit dB	
1	3760.00	-42.00	-35.35	-13.00	-6.65	-29.00	Peak
2 pp	5640.00	-34.89	-33.03	-13.00	-1.86	-21.89	Peak



Bureau Veritas Consumer Products Services Ltd., Taoyuan Branch

A D T

Data: 4

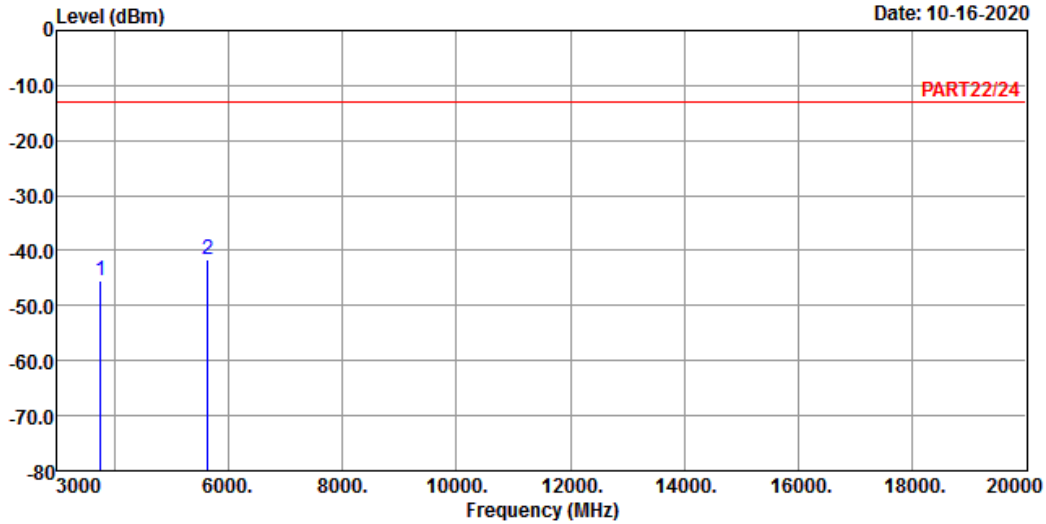

Site : 966 Chamber 5
 Condition: PART22/24 VERTICAL
 Remak : LTE Band 2 QPSK_20M Link_M-CH
 Tested by: Cyril Chen

	Freq	Level	Read Level	Limit	Line Factor	Over Limit	Remark
	MHz	dBm	dBm	dBm	dB	dB	
1	3760.00	-45.48	-38.83	-13.00	-6.65	-32.48	Peak
2 pp	5640.00	-41.77	-39.91	-13.00	-1.86	-28.77	Peak

High Channel



Bureau Veritas Consumer Products Services Ltd., Taoyuan Branch

A D T

Data: 5

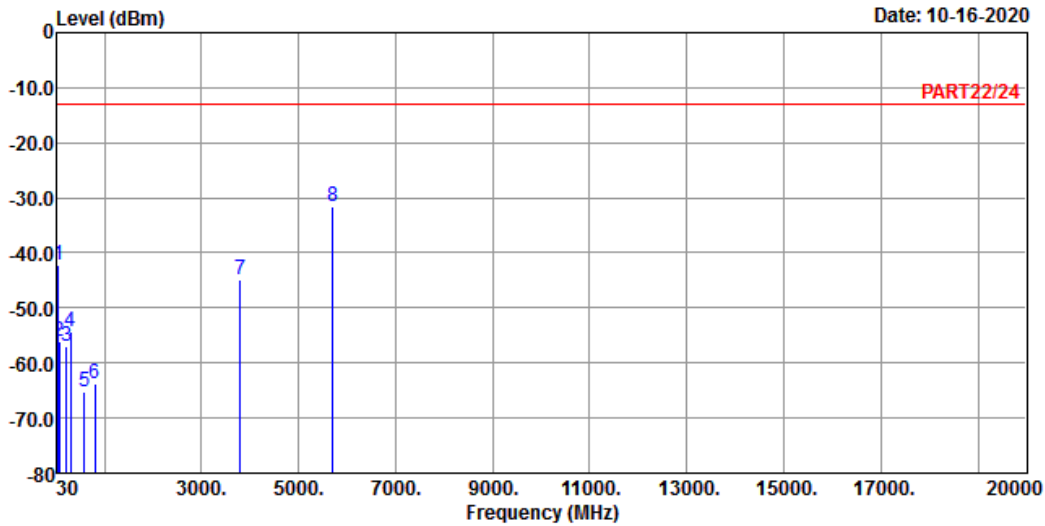

Site : 966 Chamber 5
 Condition: PART22/24 HORIZONTAL
 Remak : LTE Band 2 QPSK_20M Link_H-CH
 Tested by: Cyril Chen

	Freq	Level	Read Level	Limit	Line Factor	Over Limit	Remark
	MHz	dBm	dBm	dBm	dB	dB	
1	43.58	-42.15	-40.68	-13.00	-1.47	-29.15	Peak
2	76.56	-56.03	-46.05	-13.00	-9.98	-43.03	Peak
3	211.39	-56.95	-49.40	-13.00	-7.55	-43.95	Peak
4	308.39	-54.39	-47.51	-13.00	-6.88	-41.39	Peak
5	592.60	-65.33	-64.25	-13.00	-1.08	-52.33	Peak
6	810.85	-63.77	-64.41	-13.00	0.64	-50.77	Peak
7	3800.00	-44.73	-38.30	-13.00	-6.43	-31.73	Peak
8 pp	5700.00	-31.46	-29.73	-13.00	-1.73	-18.46	Peak



Bureau Veritas Consumer Products Services Ltd., Taoyuan Branch

A D T

Data: 6

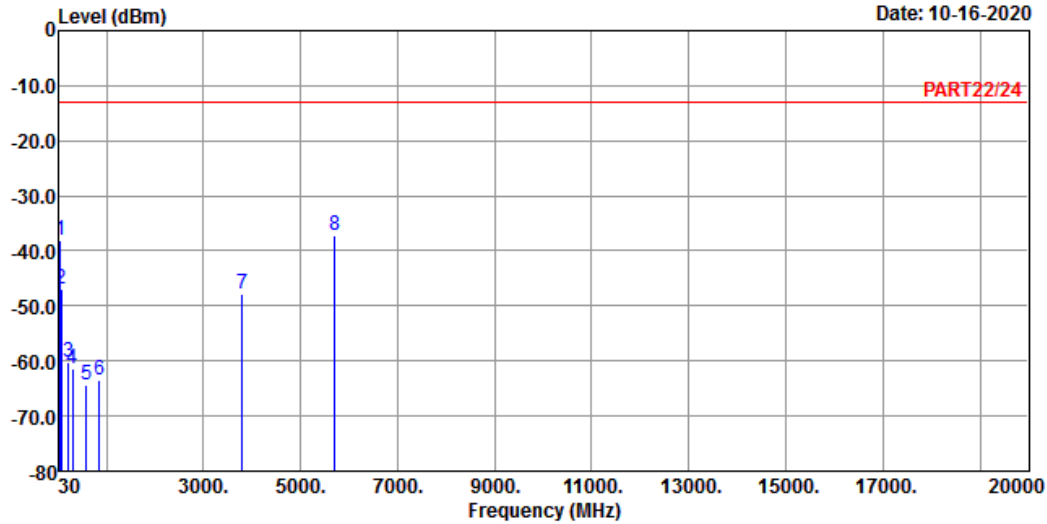

Site : 966 Chamber 5
 Condition: PART22/24 VERTICAL
 Remak : LTE Band 2 QPSK_20M Link_H-CH
 Tested by: Cyril Chen

	Freq	Level	Read Level	Limit Line	Over Factor	Over Limit	Remark
	MHz	dBm	dBm	dBm	dB	dB	
1	43.58	-37.94	-36.47	-13.00	-1.47	-24.94	Peak
2	76.56	-46.84	-36.86	-13.00	-9.98	-33.84	Peak
3	220.12	-60.22	-53.02	-13.00	-7.20	-47.22	Peak
4	310.33	-61.33	-54.48	-13.00	-6.85	-48.33	Peak
5	587.75	-64.41	-63.13	-13.00	-1.28	-51.41	Peak
6	849.65	-63.60	-63.89	-13.00	0.29	-50.60	Peak
7	3800.00	-47.89	-41.46	-13.00	-6.43	-34.89	Peak
8 pp	5700.00	-37.14	-35.41	-13.00	-1.73	-24.14	Peak

Mode B
WCDMA:
Low Channel



Bureau Veritas Consumer Products Services Ltd., Taoyuan Branch

A D T

Data: 3

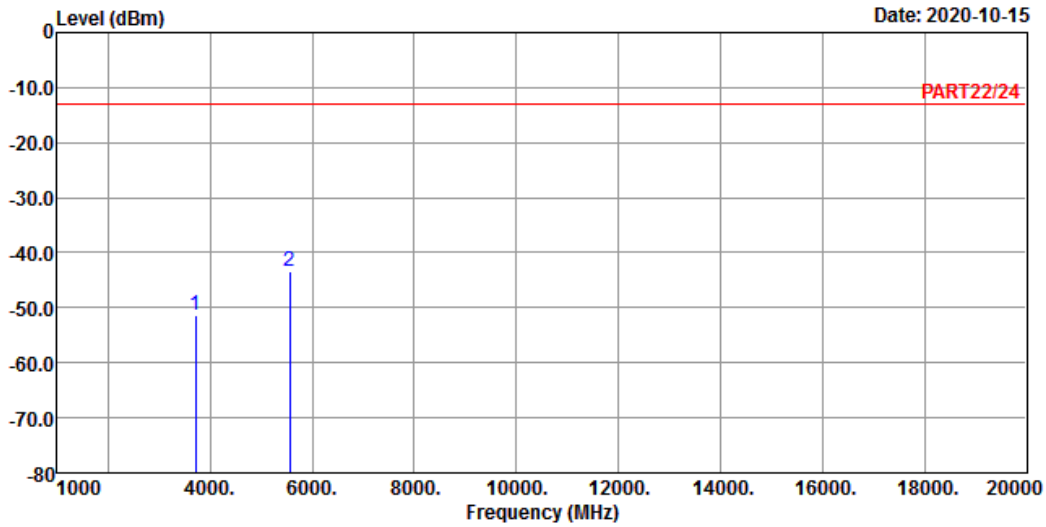

Site : 966 Chamber 5
Condition: PART22/24 HORIZONTAL
Remak : WCDMA Band 2 Link_L-CH
Tested by: tim-chen

	Freq	Level	Read Level	Limit	Line Factor	Over Limit	Remark
	MHz	dBm	dBm	dBm	dB	dB	
1	3704.80	-51.32	-44.39	-13.00	-6.93	-38.32	Peak
2 pp	5557.20	-43.26	-41.35	-13.00	-1.91	-30.26	Peak



Bureau Veritas Consumer Products Services Ltd., Taoyuan Branch

A D T

Data: 4

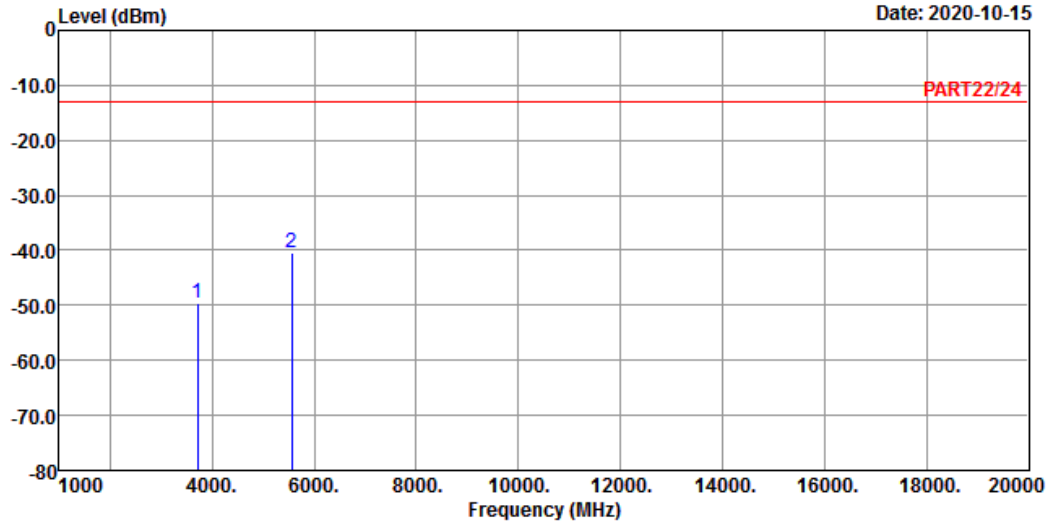

Site : 966 Chamber 5
 Condition: PART22/24 VERTICAL
 Remak : WCDMA Band 2 Link_L-CH
 Tested by: tim-chen

	Freq	Level	Read Level	Limit	Line Factor	Over Limit	Remark
	MHz	dBm	dBm	dBm	dB	dB	
1	3704.80	-49.73	-42.80	-13.00	-6.93	-36.73	Peak
2	5557.20	-40.40	-38.49	-13.00	-1.91	-27.40	Peak

Middle Channel



Bureau Veritas Consumer Products Services Ltd., Taoyuan Branch

A D T

Data: 3

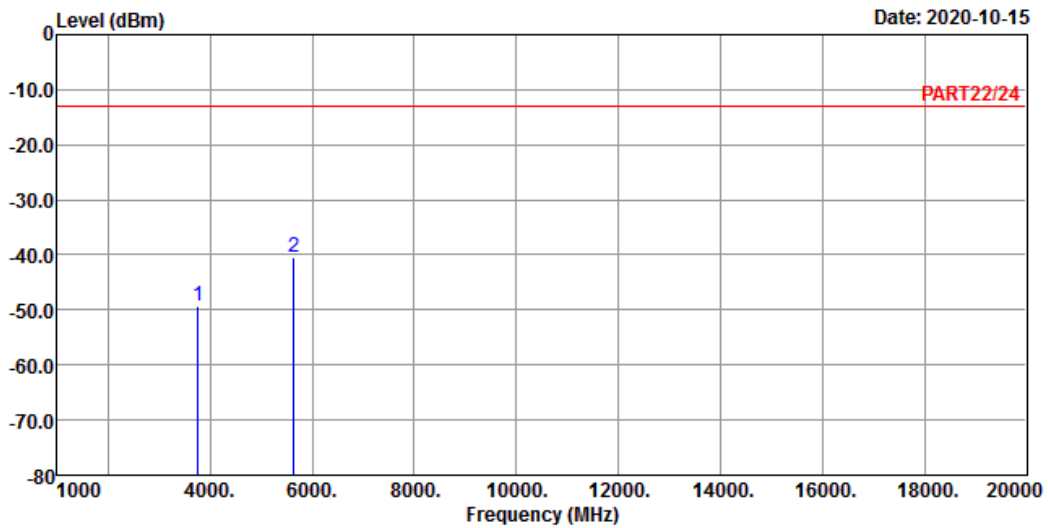

Site : 966 Chamber 5
 Condition: PART22/24 HORIZONTAL
 Remak : WCDMA Band 2 Link_M-CH
 Tested by: tim-chen

	Freq	Level	Read	Limit	Over		Remark
			Level	Line	Factor	Limit	
	MHz	dBm	dBm	dBm	dB	dB	
1	3760.00	-49.30	-42.65	-13.00	-6.65	-36.30	Peak
2 pp	5640.00	-40.42	-38.56	-13.00	-1.86	-27.42	Peak



Bureau Veritas Consumer Products Services Ltd., Taoyuan Branch

A D T

Data: 4

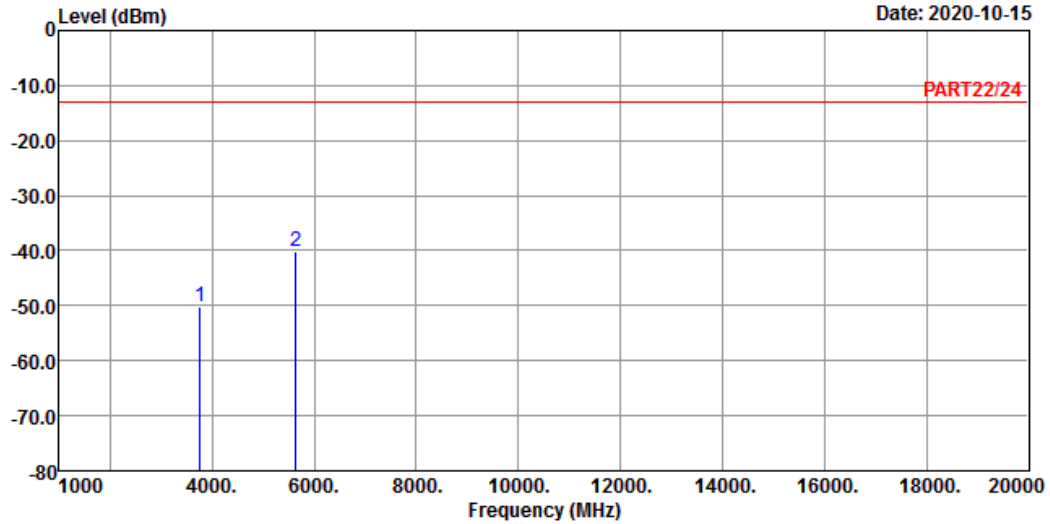

Site : 966 Chamber 5
 Condition: PART22/24 VERTICAL
 Remak : WCDMA Band 2 Link_M-CH
 Tested by: tim-chen

	Freq	Level	Read Level	Limit	Line Factor	Over Limit	Remark
	MHz	dBm	dBm	dBm	dB	dB	
1	3760.00	-50.17	-43.52	-13.00	-6.65	-37.17	Peak
2 pp	5640.00	-40.28	-38.42	-13.00	-1.86	-27.28	Peak

High Channel



Bureau Veritas Consumer Products Services Ltd., Taoyuan Branch

A D T

Data: 5

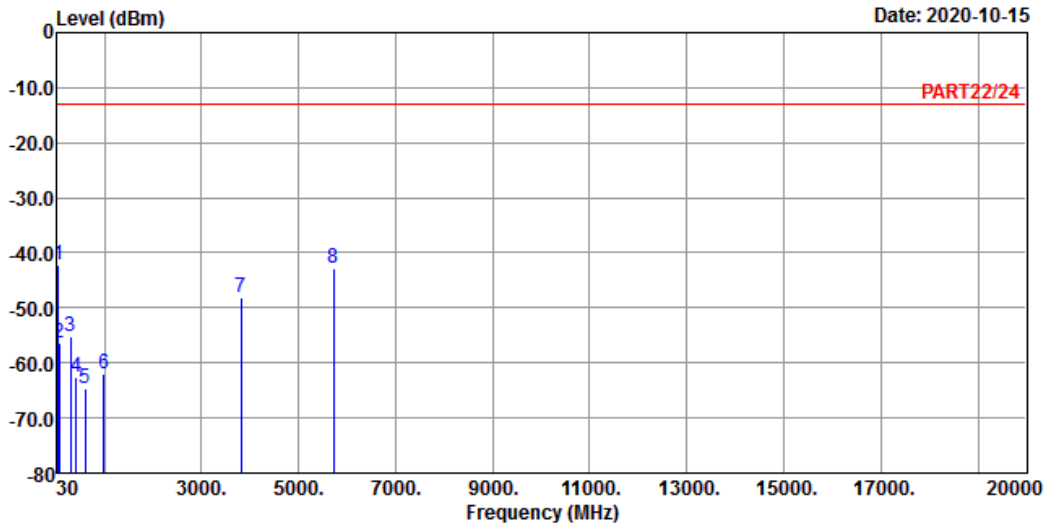

Site : 966 Chamber 5
 Condition: PART22/24 HORIZONTAL
 Remak : WCDMA Band 2 Link_H-CH
 Tested by: tim-chen

	Freq	Level	Read Level	Limit	Line Factor	Over Limit	Remark
	MHz	dBm	dBm	dBm	dB	dB	
1 pp	43.58	-42.30	-40.83	-13.00	-1.47	-29.30	Peak
2	76.56	-56.40	-46.42	-13.00	-9.98	-43.40	Peak
3	310.33	-55.15	-48.30	-13.00	-6.85	-42.15	Peak
4	419.94	-62.57	-56.78	-13.00	-5.79	-49.57	Peak
5	602.30	-64.66	-63.90	-13.00	-0.76	-51.66	Peak
6	993.21	-62.07	-65.41	-13.00	3.34	-49.07	Peak
7	3815.20	-48.25	-41.85	-13.00	-6.40	-35.25	Peak
8	5722.80	-42.74	-41.05	-13.00	-1.69	-29.74	Peak



Bureau Veritas Consumer Products Services Ltd., Taoyuan Branch

A D T

Data: 6

Date: 2020-10-15

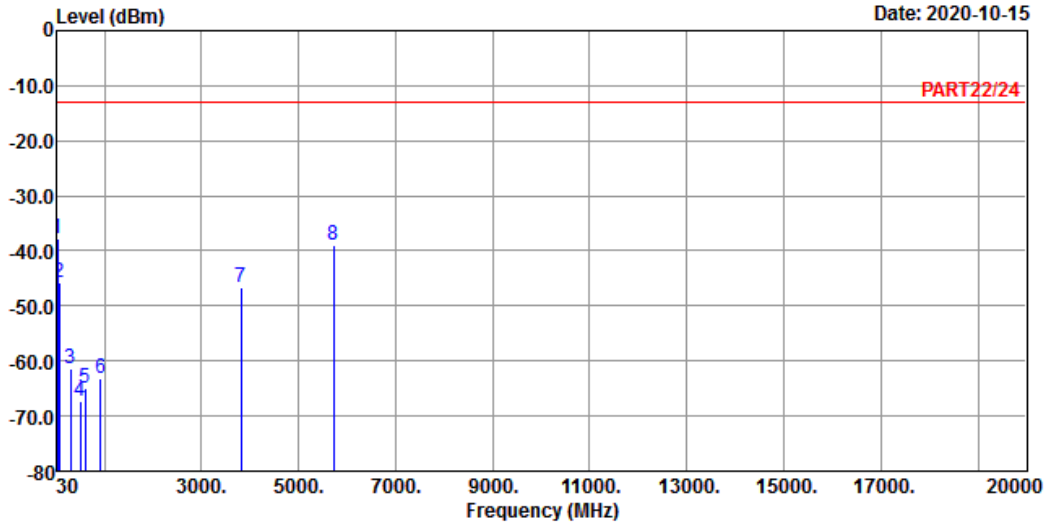

Site : 966 Chamber 5
 Condition: PART22/24 VERTICAL
 Remak : WCDMA Band 2 Link_H-CH
 Tested by: tim-chen

	Freq	Level	Read Level	Limit Line	Over Factor	Over Limit	Remark
	MHz	dBm	dBm	dBm	dB	dB	
1 pp	42.61	-37.74	-36.80	-13.00	-0.94	-24.74	Peak
2	76.56	-45.76	-35.78	-13.00	-9.98	-32.76	Peak
3	308.39	-61.36	-54.48	-13.00	-6.88	-48.36	Peak
4	509.18	-67.23	-62.93	-13.00	-4.30	-54.23	Peak
5	605.21	-64.98	-64.21	-13.00	-0.77	-51.98	Peak
6	929.19	-63.21	-64.50	-13.00	1.29	-50.21	Peak
7	3815.20	-46.59	-40.19	-13.00	-6.40	-33.59	Peak
8	5722.80	-38.96	-37.27	-13.00	-1.69	-25.96	Peak

LTE Band 2
 Channel Bandwidth: 1.4 MHz / QPSK
 Low Channel



Bureau Veritas Consumer Products Services Ltd., Taoyuan Branch

A D T

Data: 3

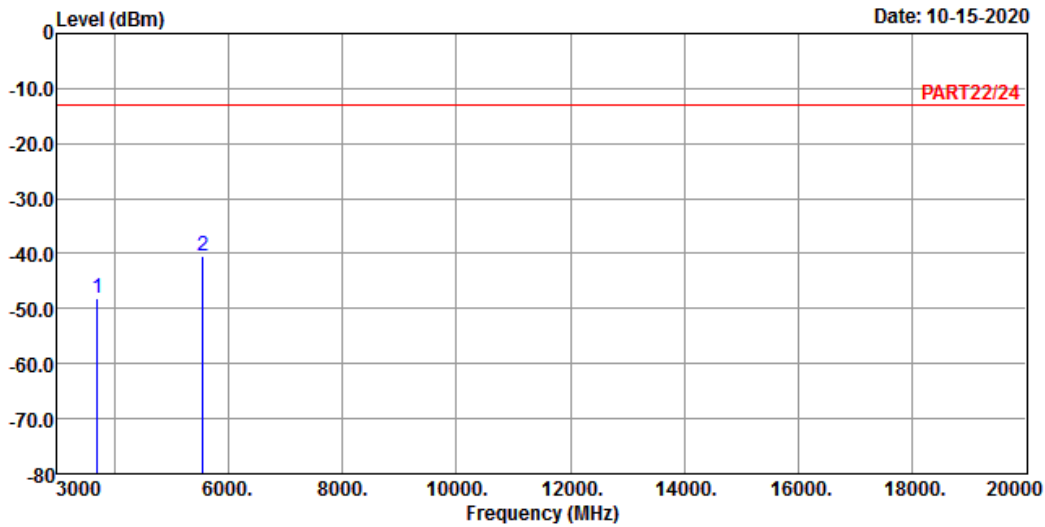

Site : 966 Chamber 5
 Condition: PART22/24 HORIZONTAL
 Remak : LTE Band 2 QPSK_1.4M Link_L-CH
 Tested by: Cyril Chen

	Read	Limit	Over		
Freq	Level	Level	Line	Factor	Limit Remark
MHz	dBm	dBm	dBm	dB	dB
1	3701.40	-48.16	-41.23	-13.00	-6.93 -35.16 Peak
2 pp	5552.10	-40.46	-38.56	-13.00	-1.90 -27.46 Peak



Bureau Veritas Consumer Products Services Ltd., Taoyuan Branch

A D T

Data: 4

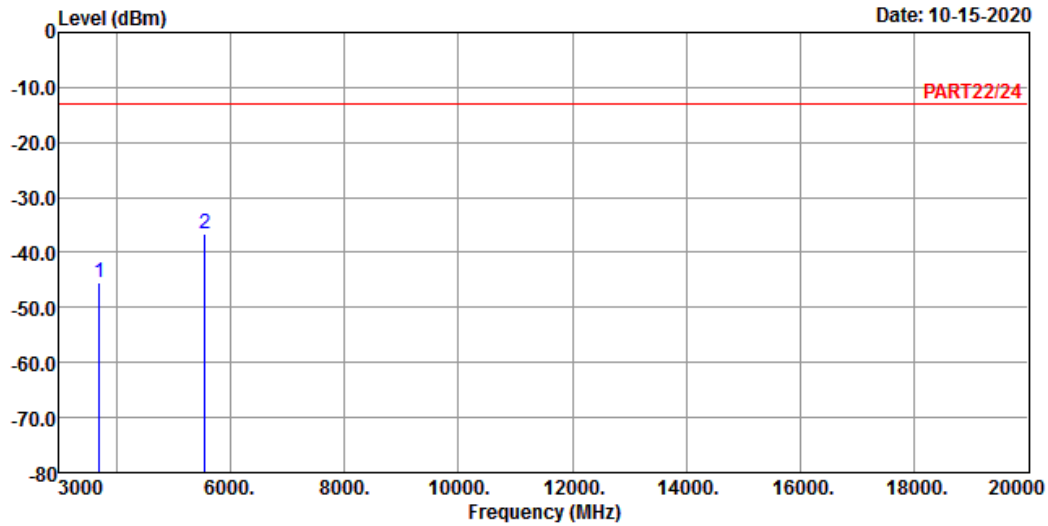

Site : 966 Chamber 5
 Condition: PART22/24 VERTICAL
 Remak : LTE Band 2 QPSK_1.4M Link_L-CH
 Tested by: Cyril Chen

	Freq	Level	Read Level	Limit	Line Factor	Over Limit	Remark
	MHz	dBm	dBm	dBm	dB	dB	
1	3701.40	-45.41	-38.48	-13.00	-6.93	-32.41	Peak
2	5552.10	-36.48	-34.58	-13.00	-1.90	-23.48	Peak

Middle Channel



Bureau Veritas Consumer Products Services Ltd., Taoyuan Branch

A D T

Data: 3

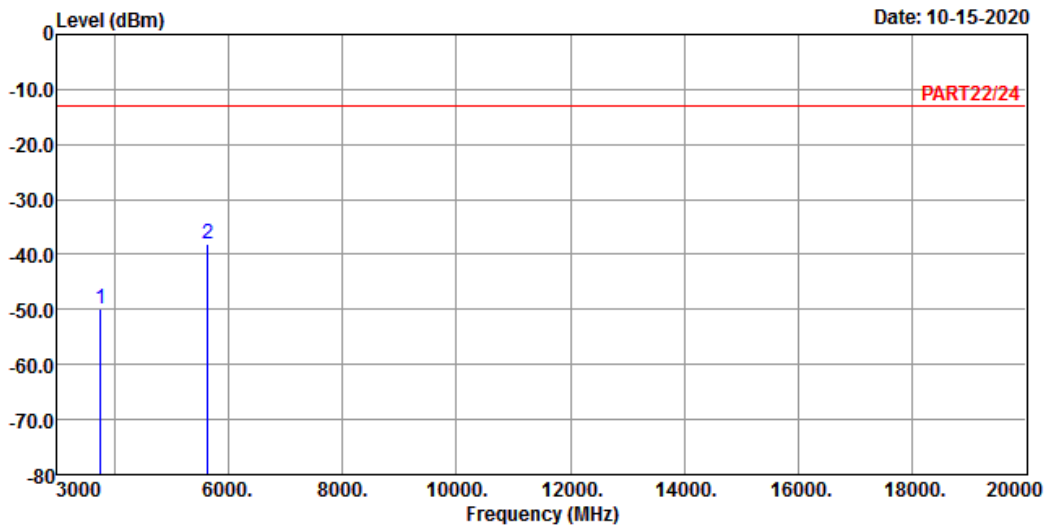

Site : 966 Chamber 5
 Condition: PART22/24 HORIZONTAL
 Remak : LTE Band 2 QPSK_1.4M Link_M-CH
 Tested by: Cyril Chen

	Freq	Level	Read	Limit	Over		Remark
			Level	Line	Factor	Limit	
	MHz	dBm	dBm	dBm	dB	dB	
1	3760.00	-49.85	-43.20	-13.00	-6.65	-36.85	Peak
2 pp	5640.00	-38.21	-36.35	-13.00	-1.86	-25.21	Peak



Bureau Veritas Consumer Products Services Ltd., Taoyuan Branch

A D T

Data: 4

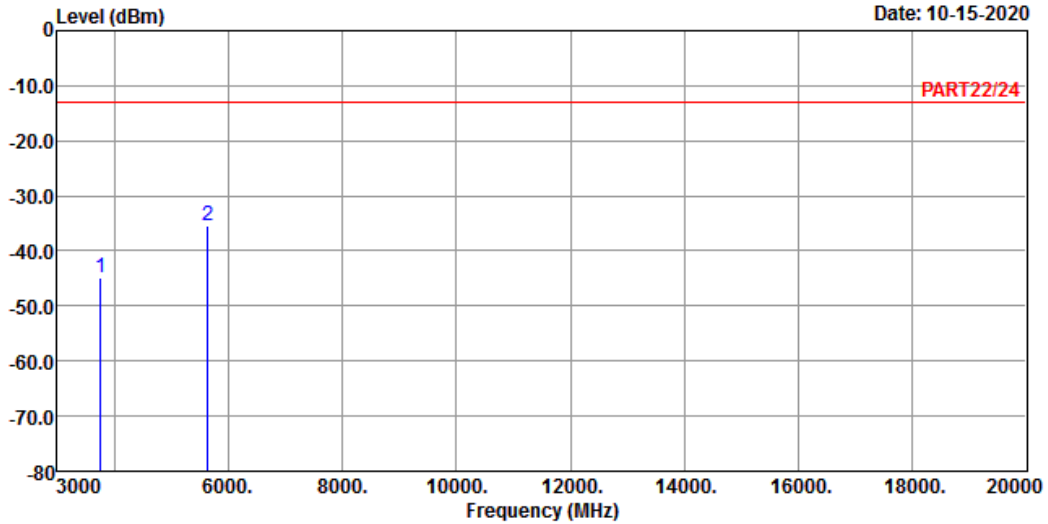

Site : 966 Chamber 5
 Condition: PART22/24 VERTICAL
 Remak : LTE Band 2 QPSK_1.4M Link_M-CH
 Tested by: Cyril Chen

	Freq	Level	Read Level	Limit	Line Factor	Over Limit	Remark
	MHz	dBm	dBm	dBm	dB	dB	
1	3760.00	-44.98	-38.33	-13.00	-6.65	-31.98	Peak
2 pp	5640.00	-35.37	-33.51	-13.00	-1.86	-22.37	Peak

High Channel



Bureau Veritas Consumer Products Services Ltd., Taoyuan Branch

A D T

Data: 3

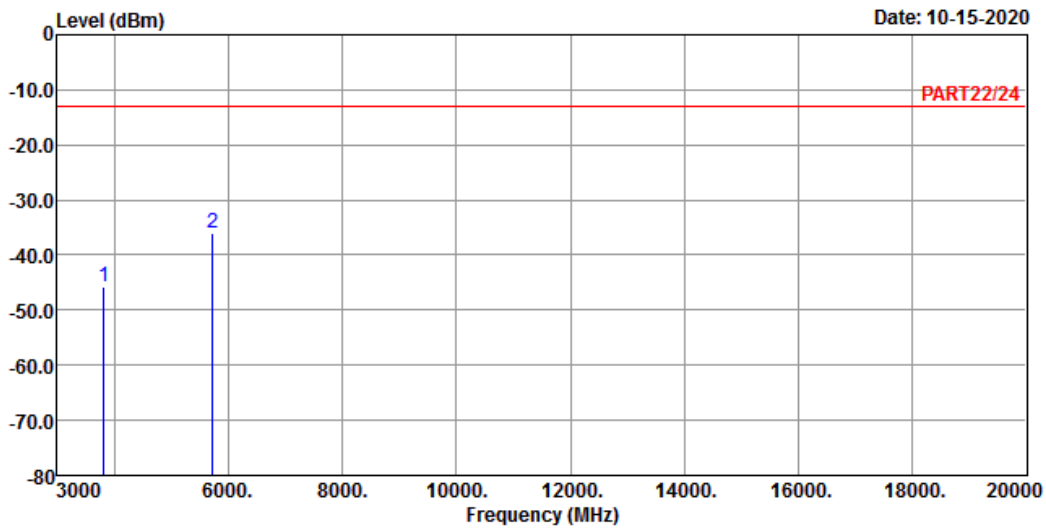

Site : 966 Chamber 5
 Condition: PART22/24 HORIZONTAL
 Remak : LTE Band 2 QPSK_1.4M Link_H-CH
 Tested by: Cyril Chen

	Freq	Level	Read Level	Limit	Line Factor	Over Limit	Remark
	MHz	dBm	dBm	dBm	dB	dB	
1	3818.60	-45.80	-39.40	-13.00	-6.40	-32.80	Peak
2 pp	5727.90	-35.87	-34.22	-13.00	-1.65	-22.87	Peak



Bureau Veritas Consumer Products Services Ltd., Taoyuan Branch

A D T

Data: 4

Date: 10-15-2020

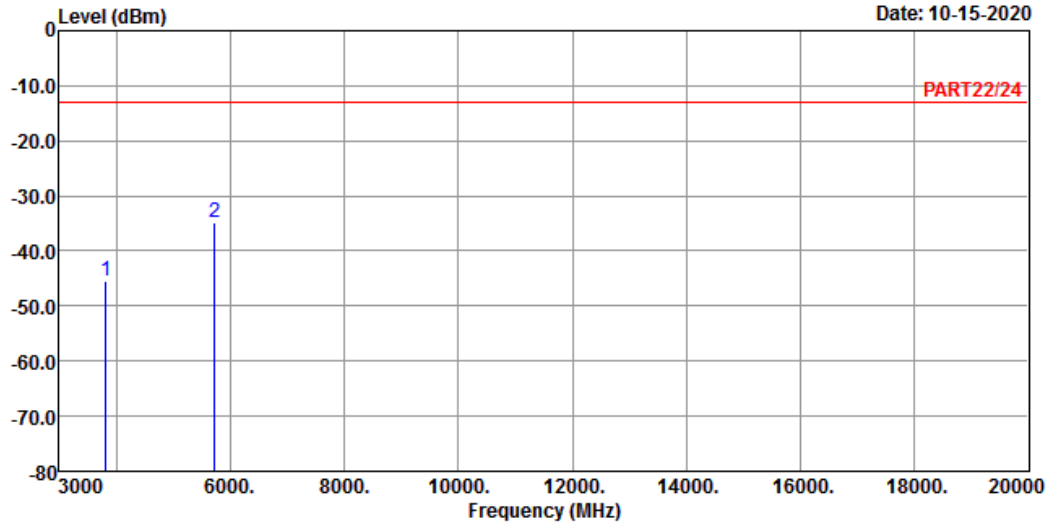

Site : 966 Chamber 5
 Condition: PART22/24 VERTICAL
 Remak : LTE Band 2 QPSK_1.4M Link_H-CH
 Tested by: Cyril Chen

	Freq	Level	Read Level	Limit	Line Factor	Over Limit	Remark
	MHz	dBm	dBm	dBm	dB	dB	
1	3818.60	-45.58	-39.18	-13.00	-6.40	-32.58	Peak
2	5727.90	-34.87	-33.22	-13.00	-1.65	-21.87	Peak

Channel Bandwidth: 5 MHz / QPSK
 Low Channel



Bureau Veritas Consumer Products Services Ltd., Taoyuan Branch

A D T

Data: 3

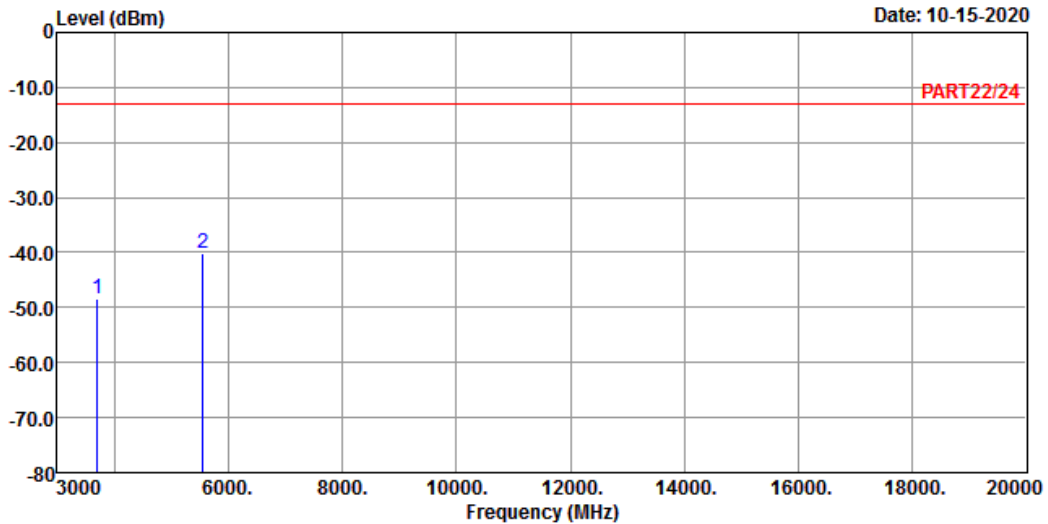

Site : 966 Chamber 5
 Condition: PART22/24 HORIZONTAL
 Remak : LTE Band 2 QPSK_5M Link_L-CH
 Tested by: Cyril Chen

	Freq	Level	Read Level	Limit	Line Factor	Over Limit	Remark
	MHz	dBm	dBm	dBm	dB	dB	
1	3705.00	-48.34	-41.41	-13.00	-6.93	-35.34	Peak
2 pp	5557.50	-40.07	-38.16	-13.00	-1.91	-27.07	Peak



Bureau Veritas Consumer Products Services Ltd., Taoyuan Branch

A D T

Data: 4

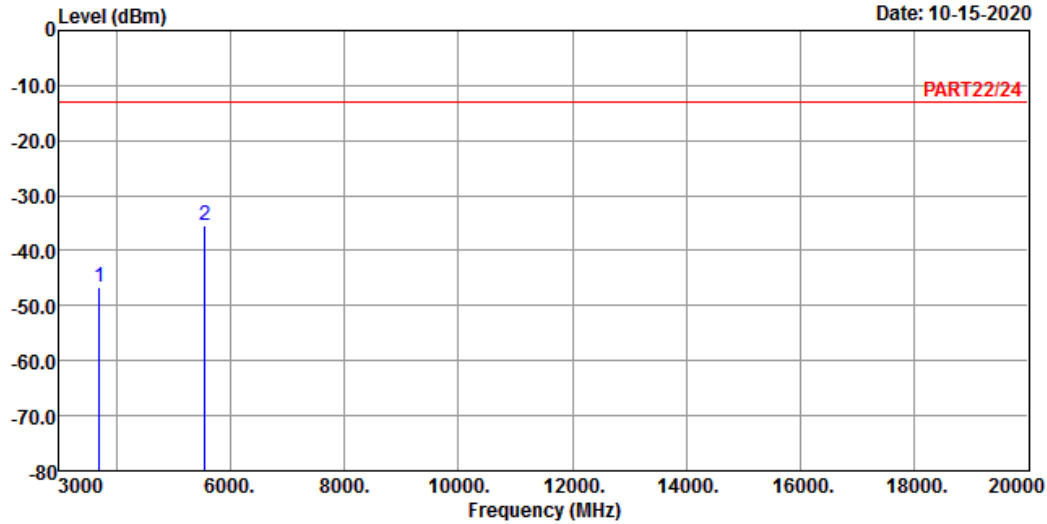

Site : 966 Chamber 5
 Condition: PART22/24 VERTICAL
 Remak : LTE Band 2 QPSK_5M Link_L-CH
 Tested by: Cyril Chen

	Freq	Level	Read Level	Limit	Line Factor	Over Limit	Remark
	MHz	dBm	dBm	dBm	dB	dB	
1	3705.00	-46.50	-39.57	-13.00	-6.93	-33.50	Peak
2	5557.50	-35.30	-33.39	-13.00	-1.91	-22.30	Peak

Middle Channel



Bureau Veritas Consumer Products Services Ltd., Taoyuan Branch

A D T

Data: 3

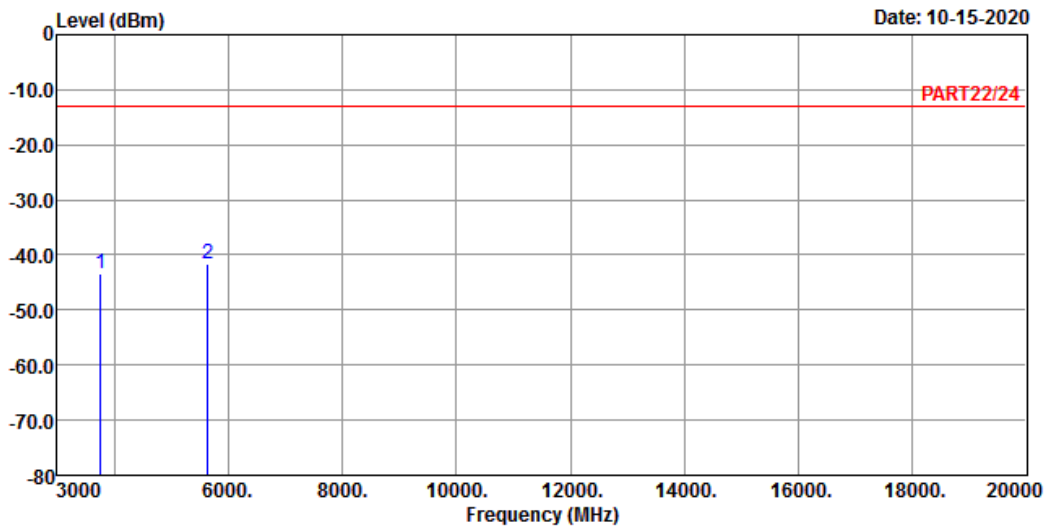

Site : 966 Chamber 5
 Condition: PART22/24 HORIZONTAL
 Remak : LTE Band 2 QPSK_5M Link_M-CH
 Tested by: Cyril Chen

	Freq	Level	Read Level	Limit	Line	Factor	Over Limit	Remark
1	3760.00	-43.51	-36.86	-13.00	-6.65	-30.51	Peak	
2 pp	5640.00	-41.51	-39.65	-13.00	-1.86	-28.51	Peak	



Bureau Veritas Consumer Products Services Ltd., Taoyuan Branch

A D T

Data: 4

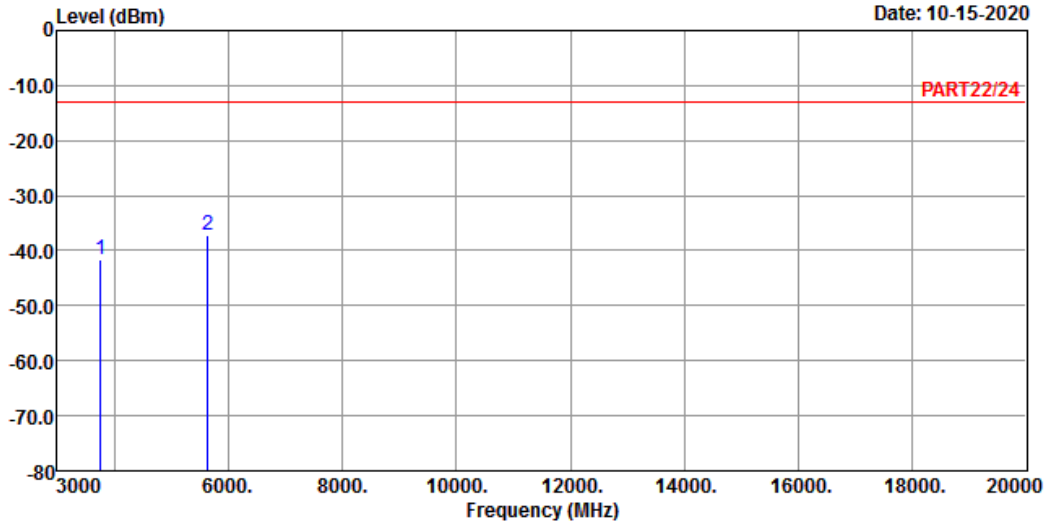

Site : 966 Chamber 5
 Condition: PART22/24 VERTICAL
 Remak : LTE Band 2 QPSK_5M Link_M-CH
 Tested by: Cyril Chen

	Freq	Level	Read Level	Limit	Line Factor	Over Limit	Remark
	MHz	dBm	dBm	dBm	dB	dB	
1	3760.00	-41.61	-34.96	-13.00	-6.65	-28.61	Peak
2	5640.00	-37.19	-35.33	-13.00	-1.86	-24.19	Peak

High Channel



Bureau Veritas Consumer Products Services Ltd., Taoyuan Branch

A D T

Data: 3

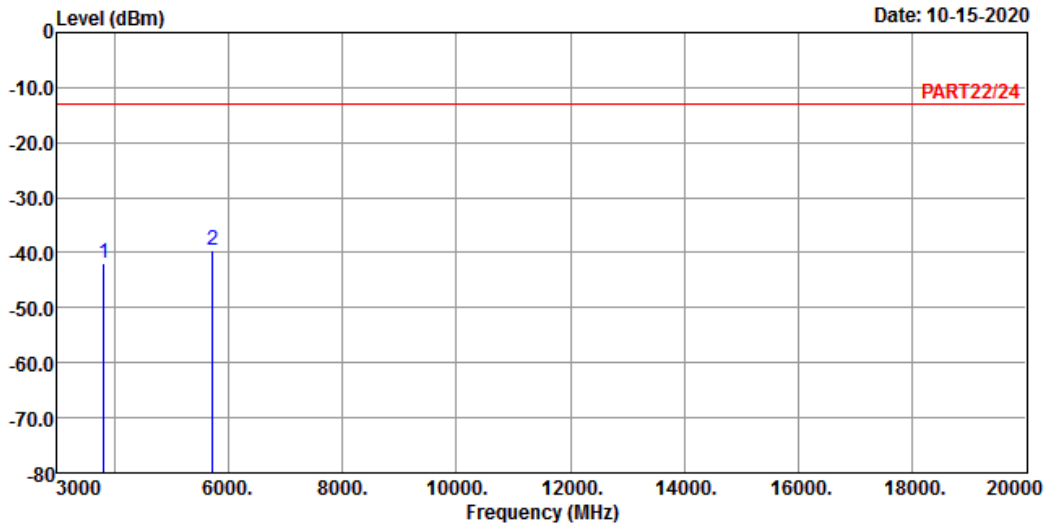

Site : 966 Chamber 5
 Condition: PART22/24 HORIZONTAL
 Remak : LTE Band 2 QPSK_5M Link_H-CH
 Tested by: Cyril Chen

	Freq	Level	Read Level	Limit	Line Factor	Over Limit	Remark
	MHz	dBm	dBm	dBm	dB	dB	
1	3815.00	-41.80	-35.40	-13.00	-6.40	-28.80	Peak
2 pp	5722.50	-39.49	-37.80	-13.00	-1.69	-26.49	Peak



Bureau Veritas Consumer Products Services Ltd., Taoyuan Branch

A D T

Data: 4

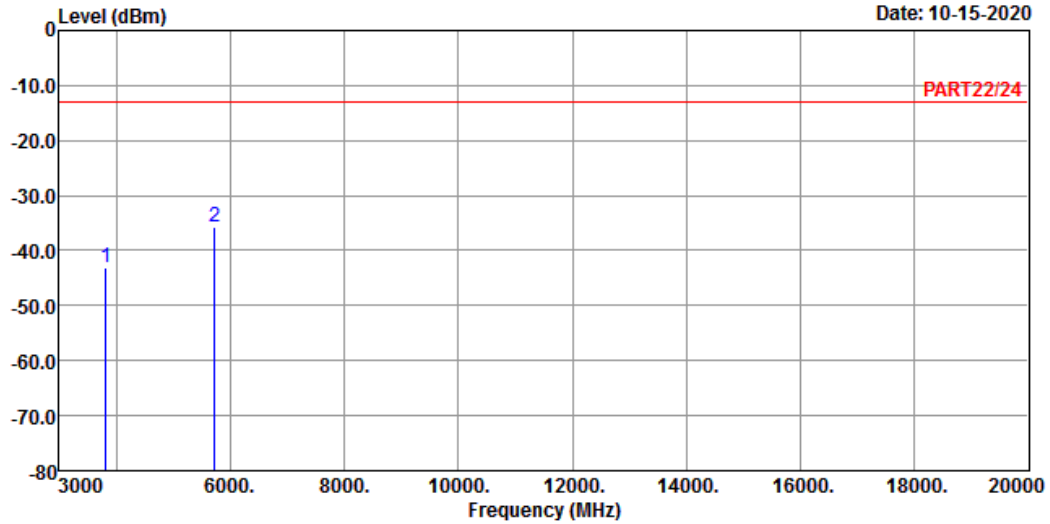

Site : 966 Chamber 5
 Condition: PART22/24 VERTICAL
 Remak : LTE Band 2 QPSK_5M Link_H-CH
 Tested by: Cyril Chen

	Freq	Level	Read Level	Limit	Line Factor	Over Limit	Remark
	MHz	dBm	dBm	dBm	dB	dB	
1	3815.00	-43.03	-36.63	-13.00	-6.40	-30.03	Peak
2	5722.50	-35.67	-33.98	-13.00	-1.69	-22.67	Peak

Channel Bandwidth: 20 MHz / QPSK
Low Channel



Bureau Veritas Consumer Products Services Ltd., Taoyuan Branch

A D T

Data: 3

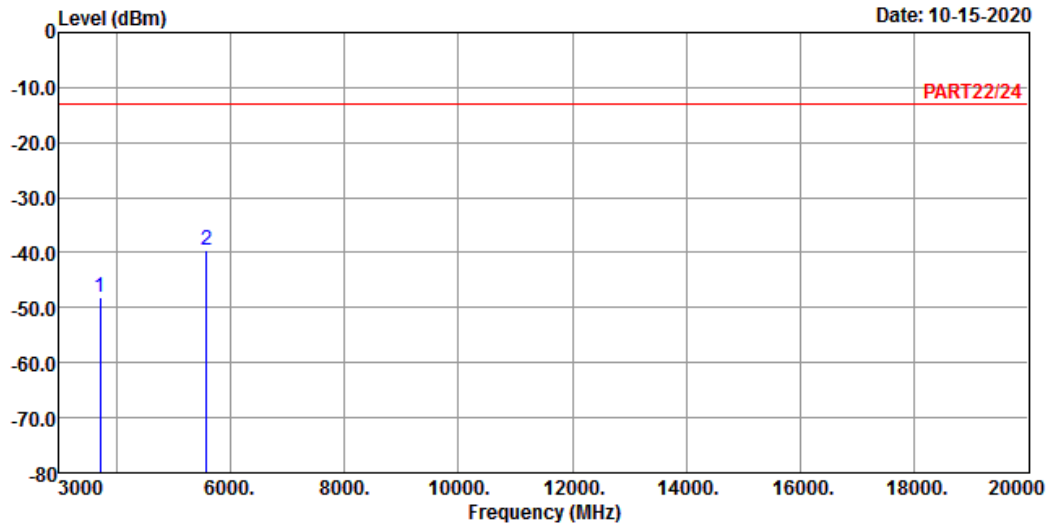

Site : 966 Chamber 5
 Condition: PART22/24 HORIZONTAL
 Remak : LTE Band 2 QPSK_20M Link_L-CH
 Tested by: Cyril Chen

	Freq	Level	Read Level	Limit	Line Factor	Over Limit	Remark
	MHz	dBm	dBm	dBm	dB	dB	
1	3720.00	-48.14	-41.32	-13.00	-6.82	-35.14	Peak
2 pp	5580.00	-39.64	-37.72	-13.00	-1.92	-26.64	Peak



Bureau Veritas Consumer Products Services Ltd., Taoyuan Branch

A D T

Data: 4

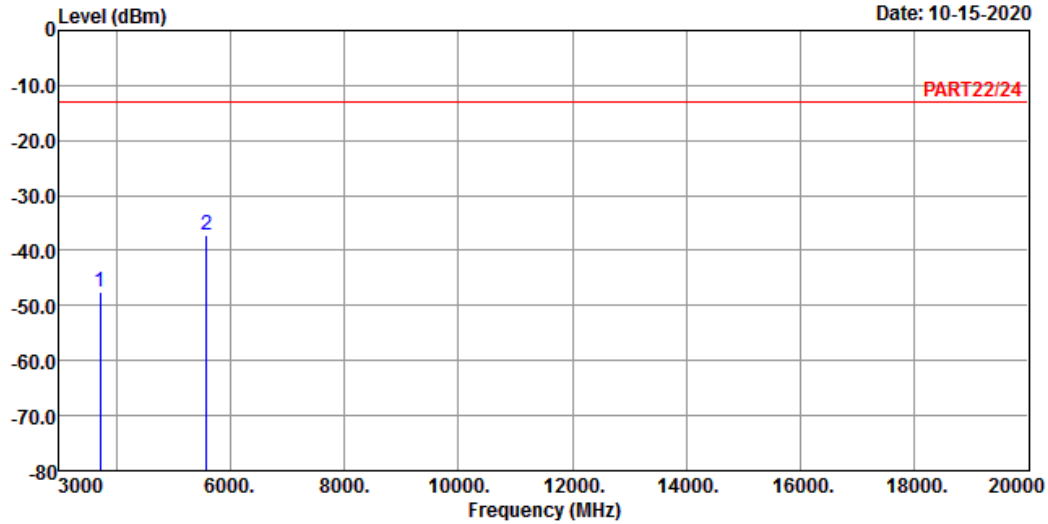

Site : 966 Chamber 5
 Condition: PART22/24 VERTICAL
 Remak : LTE Band 2 QPSK_20M Link_L-CH
 Tested by: Cyril Chen

	Freq	Level	Read Level	Limit	Line Factor	Over Limit	Remark
	MHz	dBm	dBm	dBm	dB	dB	
1	3720.00	-47.46	-40.64	-13.00	-6.82	-34.46	Peak
2 pp	5580.00	-37.17	-35.25	-13.00	-1.92	-24.17	Peak

Middle Channel



Bureau Veritas Consumer Products Services Ltd., Taoyuan Branch

A D T

Data: 3

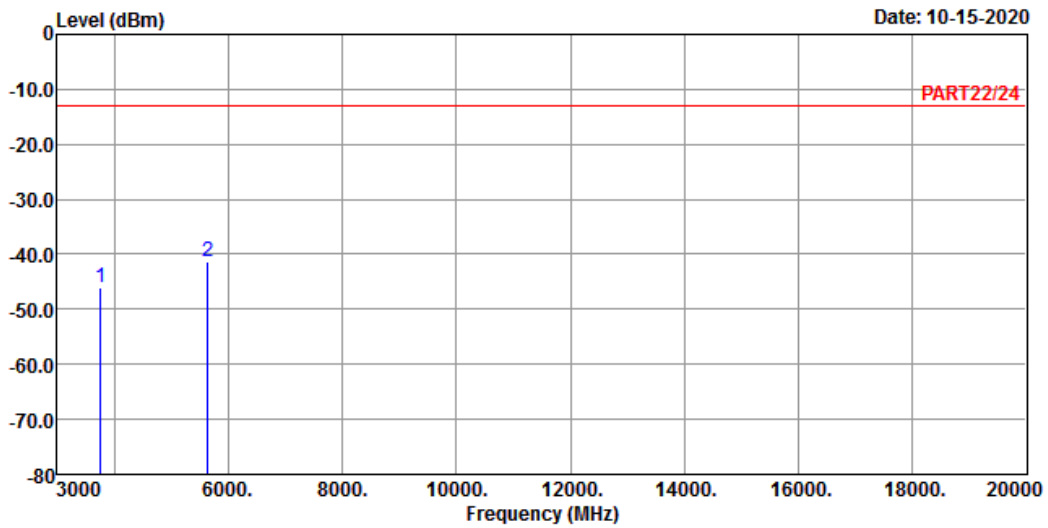

Site : 966 Chamber 5
 Condition: PART22/24 HORIZONTAL
 Remak : LTE Band 2 QPSK_20M Link_M-CH
 Tested by: Cyril Chen

	Freq	Level	Read Level	Limit	Line Factor	Over Limit	Remark
	MHz	dBm	dBm	dBm	dB	dB	
1	3760.00	-46.14	-39.49	-13.00	-6.65	-33.14	Peak
2 pp	5640.00	-41.36	-39.50	-13.00	-1.86	-28.36	Peak



Bureau Veritas Consumer Products Services Ltd., Taoyuan Branch

A D T

Data: 4

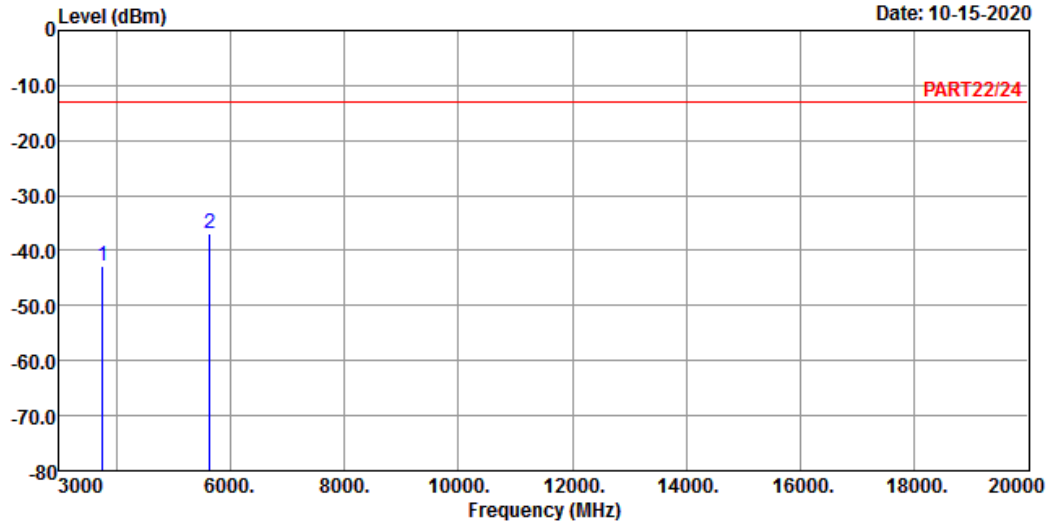

Site : 966 Chamber 5
 Condition: PART22/24 VERTICAL
 Remak : LTE Band 2 QPSK_20M Link_M-CH
 Tested by: Cyril Chen

	Freq	Level	Read Level	Limit	Line Factor	Over Limit	Remark
	MHz	dBm	dBm	dBm	dB	dB	
1	3760.00	-42.87	-36.22	-13.00	-6.65	-29.87	Peak
2	5640.00	-36.89	-35.03	-13.00	-1.86	-23.89	Peak

High Channel



Bureau Veritas Consumer Products Services Ltd., Taoyuan Branch

A D T

Data: 5

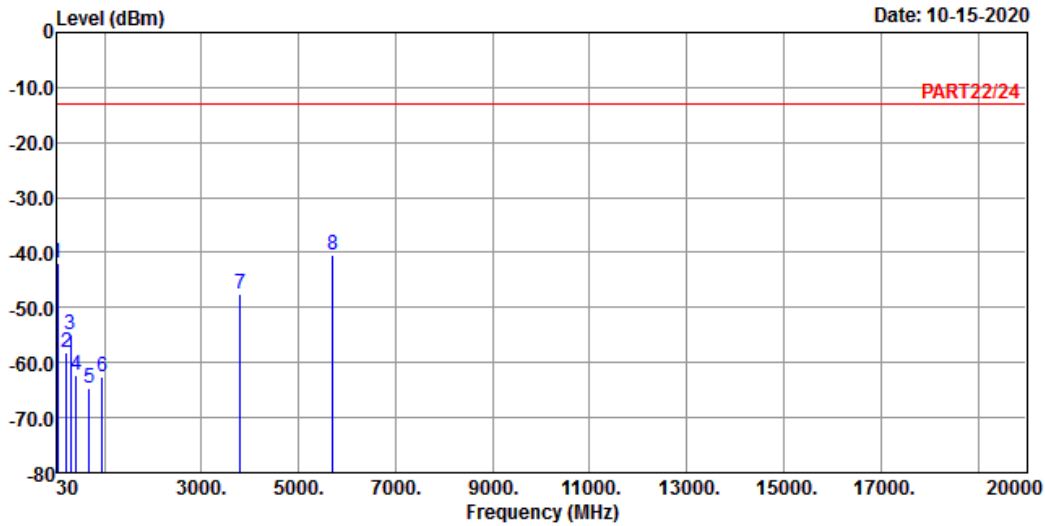

Site : 966 Chamber 5
 Condition: PART22/24 HORIZONTAL
 Remak : LTE Band 2 QPSK_20M Link_H-CH
 Tested by: Cyril Chen

	Freq	Level	Read Level	Limit	Line Factor	Over Limit	Remark
	MHz	dBm	dBm	dBm	dB	dB	
1	42.61	-42.00	-41.06	-13.00	-0.94	-29.00	Peak
2	211.39	-58.04	-50.49	-13.00	-7.55	-45.04	Peak
3	307.42	-54.79	-47.90	-13.00	-6.89	-41.79	Peak
4	426.73	-62.39	-56.66	-13.00	-5.73	-49.39	Peak
5	687.66	-64.79	-64.49	-13.00	-0.30	-51.79	Peak
6	958.29	-62.69	-64.80	-13.00	2.11	-49.69	Peak
7	3800.00	-47.52	-41.09	-13.00	-6.43	-34.52	Peak
8 pp	5700.00	-40.53	-38.80	-13.00	-1.73	-27.53	Peak



Bureau Veritas Consumer Products Services Ltd., Taoyuan Branch

A D T

Data: 6

Date: 10-15-2020

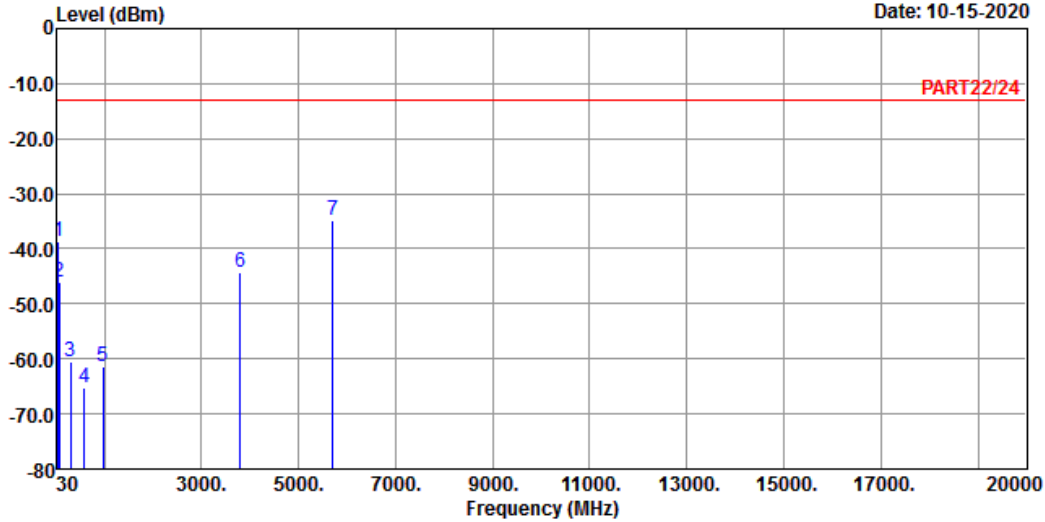

Site : 966 Chamber 5
 Condition: PART22/24 VERTICAL
 Remak : LTE Band 2 QPSK_20M Link_H-CH
 Tested by: Cyril Chen

	Read	Limit	Over			
Freq	Level	Level	Line	Factor	Limit	Remark
MHz	dBm	dBm	dBm	dB	dB	
1	44.55	-38.57	-36.58	-13.00	-1.99	-25.57 Peak
2	69.77	-46.02	-37.62	-13.00	-8.40	-33.02 Peak
3	309.36	-60.52	-53.66	-13.00	-6.86	-47.52 Peak
4	585.81	-65.36	-64.00	-13.00	-1.36	-52.36 Peak
5	970.90	-61.51	-64.06	-13.00	2.55	-48.51 Peak
6	3800.00	-44.31	-37.88	-13.00	-6.43	-31.31 Peak
7 pp	5700.00	-34.77	-33.04	-13.00	-1.73	-21.77 Peak

5 Pictures of Test Arrangements

Please refer to the attached file (Test Setup Photo).

Appendix – Information of the Testing Laboratories

We, Bureau Veritas Consumer Products Services (H.K.) Ltd., Taoyuan Branch, were founded in 1988 to provide our best service in EMC, Radio, Telecom and Safety consultation. Our laboratories are FCC recognized accredited test firms and accredited according to ISO/IEC 17025.

If you have any comments, please feel free to contact us at the following:

Lin Kou EMC/RF Lab

Tel: 886-2-26052180

Fax: 886-2-26051924

Hsin Chu EMC/RF/Telecom Lab

Tel: 886-3-6668565

Fax: 886-3-6668323

Hwa Ya EMC/RF/Safety Lab

Tel: 886-3-3183232

Fax: 886-3-3270892

Email: service.adt@tw.bureauveritas.com

Web Site: www.bureauveritas-adt.com

The address and road map of all our labs can be found in our web site also.

--- END ---