

Partial FCC Test Report

Report No.: RFBGSN-WTW-P20080589-13

FCC ID: NKS-MA1BA1TE1

Test Model: Trimble Gateway-MA1, Trimble Gateway-BA1, Trimble Gateway-TE1
(refer to item 3.1 for more details)

Received Date: Aug. 29, 2020

Test Date: Oct. 23, 2020 ~ Nov. 04, 2020

Issued Date: Nov. 13, 2020

Applicant: PeopleNet Communications Corporation

Address: 4400 Baker Road, Minnetonka Minnesota 55343-8684 United States

Issued By: Bureau Veritas Consumer Products Services (H.K.) Ltd., Taoyuan Branch
Lin Kou Laboratories

Lab Address: No. 47-2, 14th Ling, Chia Pau Vil., Lin Kou Dist., New Taipei City, Taiwan

Test Location: No.19, Hwa Ya 2nd Rd., Wen Hwa Vil., Kwei Shan Dist., Taoyuan City
33383, Taiwan

**FCC Registration /
Designation Number:** 788550 / TW0003



This report is for your exclusive use. Any copying or replication of this report to or for any other person or entity, or use of our name or trademark, is permitted only with our prior written permission. This report sets forth our findings solely with respect to the test samples identified herein. The results set forth in this report are not indicative or representative of the quality or characteristics of the lot from which a test sample was taken or any similar or identical product unless specifically and expressly noted. Our report includes all of the tests requested by you and the results thereof based upon the information that you provided to us. You have 60 days from date of issuance of this report to notify us of any material error or omission caused by our negligence, provided, however, that such notice shall be in writing and shall specifically address the issue you wish to raise. A failure to raise such issue within the prescribed time shall constitute your unqualified acceptance of the completeness of this report, the tests conducted and the correctness of the report contents. Unless specific mention, the uncertainty of measurement has been explicitly taken into account to declare the compliance or non-compliance to the specification.

Table of Contents

Release Control Record	3
1 Certificate of Conformity	4
2 Summary of Test Results.....	5
2.1 Measurement Uncertainty.....	5
2.2 Modification Record	5
3 General Information	6
3.1 General Description of EUT	6
3.2 Description of Test Modes.....	7
3.2.1 Test Mode Applicability and Tested Channel Detail.....	8
3.3 Description of Support Units	9
3.3.1 Configuration of System under Test	9
3.4 General Description of Applied Standards and References	10
4 Test Types and Results	11
4.1 Radiated Emission and Bandedge Measurement	11
4.1.1 Limits of Radiated Emission and Bandedge Measurement	11
4.1.2 Test Instruments	12
4.1.3 Test Procedures.....	13
4.1.4 Deviation from Test Standard	13
4.1.5 Test Set Up	14
4.1.6 EUT Operating Conditions.....	14
4.1.7 Test Results	15
4.2 Conducted Emission Measurement.....	21
4.2.1 Limits of Conducted Emission Measurement	21
4.2.2 Test Instruments	21
4.2.3 Test Procedures.....	22
4.2.4 Deviation from Test Standard	22
4.2.5 Test Setup.....	22
4.2.6 EUT Operating Condition	22
4.2.7 Test Results	23
5 Pictures of Test Arrangements.....	29
Appendix – Information of the Testing Laboratories	30



Release Control Record

Issue No.	Description	Date Issued
RFBGSN-WTW-P20080589-13	Original Release	Nov. 13, 2020

1 Certificate of Conformity

Product: Trimble Gateway NA

Brand: Trimble

Test Model: Trimble Gateway-MA1, Trimble Gateway-BA1, Trimble Gateway-TE1
(refer to item 3.1 for more details)

Sample Status: Engineering Sample

Applicant: PeopleNet Communications Corporation

Test Date: Oct. 23, 2020 ~ Nov. 04, 2020

Standards: 47 CFR FCC Part 15, Subpart C (Section 15.247)
ANSI C63.10:2013

The above equipment has been tested by **Bureau Veritas Consumer Products Services (H.K.) Ltd., Taoyuan Branch**, and found compliance with the requirement of the above standards. The test record, data evaluation & Equipment Under Test (EUT) configurations represented herein are true and accurate accounts of the measurements of the sample's RF characteristics under the conditions specified in this report.

Prepared by : , **Date:** Nov. 13, 2020
Vera Huang / Specialist

Approved by : , **Date:** Nov. 13, 2020
Dylan Chiou / Senior Project Engineer

2 Summary of Test Results

47 CFR FCC Part 15, Subpart C (Section 15.247)			
FCC Clause	Test Item	Result	Remarks
15.207	AC Power Conducted Emission	Pass	Meet the requirement of limit. Minimum passing margin is -15.78 dB at 0.47384 MHz.
15.247(a)(1)(iii)	Number of Hopping Frequency Used	N/A	Refer to Note
15.247(a)(1)(iii)	Dwell Time on Each Channel	N/A	Refer to Note
15.247(a)(1)	1. Hopping Channel Separation 2. Spectrum Bandwidth of a Frequency Hopping Sequence Spread Spectrum System	N/A	Refer to Note
15.247(a)(1)	Maximum Peak Output Power	N/A	Refer to Note
---	Occupied Bandwidth Measurement	N/A	Refer to Note
15.205 & 209	Radiated Emissions	Pass	Meet the requirement of limit. Minimum passing margin is -3.87 dB at 42.61 MHz.
15.247(d)	Band Edge Measurement	N/A	Refer to Note
15.247(d)	Antenna Port Emission	N/A	Refer to Note
15.203	Antenna Requirement	N/A	Refer to Note

Note:

- Only conducted emission and radiated emission below 1GHz tests are performed for the addendum. Refer to BV CPS report no. RFBGSN-WTW-P20080589-4 for the other test data.
- Determining compliance based on the results of the compliance measurement, not taking into account measurement instrumentation uncertainty.

2.1 Measurement Uncertainty

Where relevant, the following measurement uncertainty levels have been estimated for tests performed on the EUT as specified in CISPR 16-4-2:

Measurement	Frequency	Expanded Uncertainty (k=2) (\pm)
Conducted Emissions at mains ports	150 kHz ~ 30 MHz	2.79 dB
Radiated Emissions up to 1 GHz	9 kHz ~ 30 MHz	3.04 dB
	30 MHz ~ 200 MHz	2.93 dB
	200 MHz ~ 1000 MHz	2.95 dB

2.2 Modification Record

There were no modifications required for compliance.

3 General Information

3.1 General Description of EUT

Product	Trimble Gateway NA
Brand	Trimble
Test Model	Trimble Gateway-MA1, Trimble Gateway-BA1, Trimble Gateway-TE1
Model Difference	Refer to note for more details
Status of EUT	Engineering Sample
Power Supply Rating	12 Vdc (adapter)
Modulation Type	GFSK, $\pi/4$ -DQPSK, 8DPSK
Transfer Rate	1/2/3 Mbps
Operating Frequency	2402 ~ 2480 MHz
Number of Channel	79
Antenna Type	FPC antenna with 0.75 dBi gain
Antenna Connector	N/A
Accessory Device	N/A
Data Cable Supplied	N/A

Note:

1. The information of module collocated in the EUT is listed as below.

Module	Brand	Model	EUT Model		
			Trimble Gateway-MA2	Trimble Gateway-BA2	Trimble Gateway-TE2
BT/WLAN Module	msi	BM25	V	V	V
WWAN Module	Quectel	EC25-A	V	V	V

2. The difference between all models are listed as below.

Ant.	Brand	Model	Ant. Type	Remark	EUT Model		
					EUT 1	EUT 2	EUT 3
					Trimble Gateway-MA2	Trimble Gateway-BA2	Trimble Gateway-TE2
WWAN Antenna 1	TAOGLAS	PCS.06.A	SMD Antenna	Internal, Main Antenna	V		V
WWAN Antenna 2	TAOGLAS	PCS.06.B	SMD Antenna	Internal, Aux. Antenna	V	V	V
WWAN Antenna 3	TAOGLAS	MA240.LBI.001	Adhesive Mount Combination Antenna	External, Main Antenna	V		
WWAN Antenna 4	TAOGLAS	MA240.LBI.001	Adhesive Mount Combination Antenna	External, Aux. Antenna	V		
WWAN Antenna 5	PACCAR	PP407031	Exterior-mount Antenna	External, Main Antenna		V	
WLAN Antenna	TAOGLAS	FXP826.07.0120C	FPC Antenna	--	V	V	V

EUT Model	Connector
Trimble Gateway-MA2	a. 1 44-pin Sinbon connector b. 3 Fakra connectors for external antennas c. 1 M13 connector for ethernet
Trimble Gateway-BA2	a. 1 44-pin Sinbon connector b. 2 Fakra connectors for external antennas c. 1 M13 connector for ethernet
Trimble Gateway-TE2	1 44-pin Sinbon connector

3. The above Antenna information is declared by manufacturer and for more detailed features description, please refer to the manufacturer's specifications, the laboratory shall not be held responsible.
4. The above EUT information is declared by manufacturer and for more detailed features description, please refers to the manufacturer's specifications or User's Manual.

3.2 Description of Test Modes

79 channels are provided to this EUT:

Channel	Freq. (MHz)	Channel	Freq. (MHz)	Channel	Freq. (MHz)	Channel	Freq. (MHz)
0	2402	20	2422	40	2442	60	2462
1	2403	21	2423	41	2443	61	2463
2	2404	22	2424	42	2444	62	2464
3	2405	23	2425	43	2445	63	2465
4	2406	24	2426	44	2446	64	2466
5	2407	25	2427	45	2447	65	2467
6	2408	26	2428	46	2448	66	2468
7	2409	27	2429	47	2449	67	2469
8	2410	28	2430	48	2450	68	2470
9	2411	29	2431	49	2451	69	2471
10	2412	30	2432	50	2452	70	2472
11	2413	31	2433	51	2453	71	2473
12	2414	32	2434	52	2454	72	2474
13	2415	33	2435	53	2455	73	2475
14	2416	34	2436	54	2456	74	2476
15	2417	35	2437	55	2457	75	2477
16	2418	36	2438	56	2458	76	2478
17	2419	37	2439	57	2459	77	2479
18	2420	38	2440	58	2460	78	2480
19	2421	39	2441	59	2461		

3.2.1 Test Mode Applicability and Tested Channel Detail

EUT Configure Mode	Applicable To		Description
	RE<1G	PLC	
A	√	√	EUT 1
B	√	√	EUT 2
C	√	√	EUT 3

Where **RE<1G**: Radiated Emission below 1 GHz **PLC**: Power Line Conducted Emission

Note:

1. For Radiated emission test, pre-tested GFSK, π/4-DQPSK, 8DPSK modulation type and found 8DPSK was the worse, therefore chosen for the final test and presented in the test report.
2. The EUT had been pre-tested on the positioned of each 3 axis. The worst case was found when positioned on **X-plane**.

Radiated Emission Test (Below 1 GHz):

- Pre-Scan has been conducted to determine the worst-case mode from all possible combinations between available modulations, data rates and antenna ports (if EUT with antenna diversity architecture).
- Following channel(s) was (were) selected for the final test as listed below.

EUT Configure Mode	Available Channel	Tested Channel	Modulation Technology	Modulation Type	Packet Type
A, B, C	0 to 78	0	FHSS	8DPSK	3DH5

Power Line Conducted Emission Test:

- Pre-Scan has been conducted to determine the worst-case mode from all possible combinations between available modulations, data rates and antenna ports (if EUT with antenna diversity architecture).
- Following channel(s) was (were) selected for the final test as listed below.

EUT Configure Mode	Available Channel	Tested Channel	Modulation Technology	Modulation Type	Packet Type
A, B, C	0 to 78	0	FHSS	8DPSK	3DH5

Test Condition:

Applicable To	Environmental Conditions	Input Power	Tested by
RE<1G	25 deg. C, 65 % RH	120 Vac, 60 Hz	Cyril Chen
PLC	25 deg. C, 65 % RH	120 Vac, 60 Hz	Getaz Yang

3.3 Description of Support Units

The EUT has been tested as an independent unit together with other necessary accessories or support units. The following support units or accessories were used to form a representative test configuration during the tests.

ID	Product	Brand	Model No.	Serial No.	FCC ID	Remarks
A	WWAN & GPS Antenna	TAOGLAS	MA240.LBI.001	NA	NA	For Mode A, Provided by client
		PACCAR	PP407031	NA	NA	For Mode B, Provided by client
B	Bluetooth Tester	R&S	CBT	100980	NA	--
C	Adapter	TPT	PMW120300W8	NA	NA	Provided by client AC Input: 100-240V~, 50-60Hz, 1.1A MAX DC Output: 12V, 3.0A

Note:

1. All power cords of the above support units are non-shielded (1.8m).
2. Item B acted as a communication partner to transfer data.

ID	Descriptions	Qty.	Length (m)	Shielding (Yes/No)	Cores (Qty.)	Remarks
1.	RF Cable	3	3	N	0	-

3.3.1 Configuration of System under Test

Mode A, B

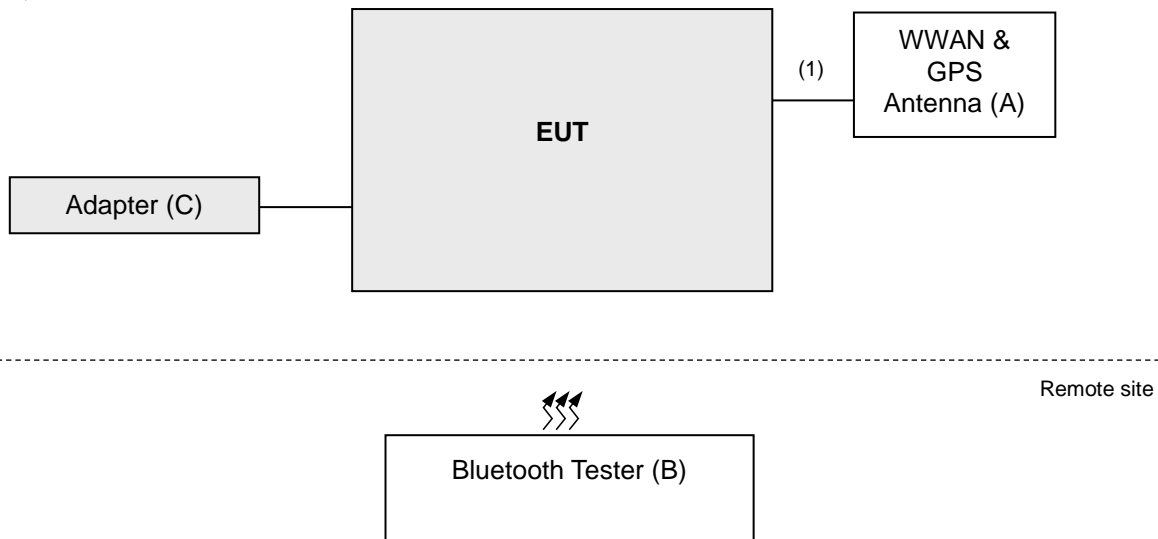

Mode C

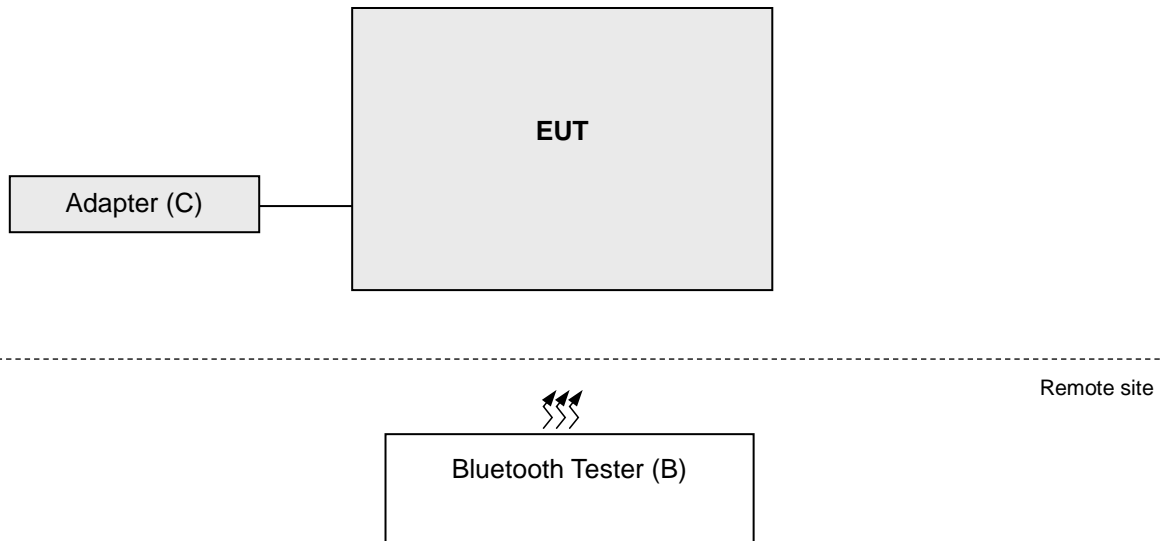

3.4 General Description of Applied Standards and References

The EUT is a RF Product. According to the specifications of the manufacturer, it must comply with the requirements of the following standards and references:

Test Standard:

FCC Part 15, Subpart C (15.247)

ANSI C63.10-2013

All test items have been performed and recorded as per the above standards.

References Test Guidance:

KDB 558074 D01 15.247 Meas Guidance v05r02

All test items have been performed as a reference to the above KDB test guidance.

4 Test Types and Results

4.1 Radiated Emission and Bandedge Measurement

4.1.1 Limits of Radiated Emission and Bandedge Measurement

Radiated emissions which fall in the restricted bands must comply with the radiated emission limits specified as below table. Other emissions shall be at least 20 dB below the highest level of the desired power:

Frequencies (MHz)	Field Strength (microvolts/meter)	Measurement Distance (meters)
0.009 ~ 0.490	2400/F (kHz)	300
0.490 ~ 1.705	24000/F (kHz)	30
1.705 ~ 30.0	30	30
30 ~ 88	100	3
88 ~ 216	150	3
216 ~ 960	200	3
Above 960	500	3

Note:

- a. The lower limit shall apply at the transition frequencies.
- b. Emission level (dBuV/m) = 20 log Emission level (uV/m).
- c. For frequencies above 1000 MHz, the field strength limits are based on average detector, however, the peak field strength of any emission shall not exceed the maximum permitted average limits, specified above by more than 20 dB under any condition of modulation.

4.1.2 Test Instruments

Description & Manufacturer	Model No.	Serial No.	Date of Calibration	Due Date of Calibration
Test Receiver Agilent	N9038A	MY51210203	Mar. 18, 2020	Mar. 17, 2021
Spectrum Analyzer Agilent	N9010A	MY52220314	Dec. 12, 2019	Dec. 11, 2020
HORN Antenna SCHWARZBECK	BBHA 9120D	9120D-969	Nov. 24, 2019	Nov. 23, 2020
BILOG Antenna SCHWARZBECK	VULB 9168	9168-472	Nov. 08, 2019	Nov. 07, 2020
Fixed Attenuator WOKEN	MDCS18N-10	MDCS18N-10-01	Apr. 14, 2020	Apr. 13, 2021
Loop Antenna	EM-6879	269	Sep. 17, 2020	Sep. 16, 2021
Preamplifier EMCI	EMC001340	980201	Oct. 21, 2020	Oct. 20, 2021
Bluetooth Tester	CBT	100980	Jul. 14, 2019	Jul. 13, 2021
Preamplifier EMCI	EMC 012645	980115	Oct. 07, 2020	Oct. 06, 2021
Preamplifier EMCI	EMC 330H	980112	Oct. 07, 2020	Oct. 06, 2021
RF Coaxial Cable EMCI	EMC104-SM-SM-8000	180409	Jan. 18, 2020	Jan. 17, 2021
RF Coaxial Cable HUBER+SUHNNER	SUCOFLEX 104	EMC104-SM-SM-1000(140807)	Oct. 07, 2020	Oct. 06, 2021
RF Coaxial Cable WOKEN	8D-FB	Cable-Ch10-01	Oct. 07, 2020	Oct. 06, 2021
Boresight Antenna Fixture	FBA-01	FBA-SIP01	NA	NA
Software BV ADT	E3 6.120103	NA	NA	NA
Antenna Tower MF	MFA-440H	NA	NA	NA
Turn Table MF	MFT-201SS	NA	NA	NA
Antenna Tower & Turn Table Controller MF	MF-7802	NA	NA	NA

Note: 1. The calibration interval of the above test instruments is 12 / 24 months and the calibrations are traceable to NML/ROC and NIST/USA.

2. The test was performed in HwaYa Chamber 10.

4.1.3 Test Procedures

For Radiated Emission below 30 MHz

- a. The EUT was placed on the top of a rotating table 0.8 meters above the ground at a 3 meter chamber room. The table was rotated 360 degrees to determine the position of the highest radiation.
- b. The EUT was set 3 meters away from the interference-receiving antenna, which was mounted on the top of a variable-height antenna tower.
- c. Parallel, perpendicular, and ground-parallel orientations of the antenna are set to make the measurement.
- d. For each suspected emission, the EUT was arranged to its worst case and the rotatable table was turned from 0 degrees to 360 degrees to find the maximum reading.
- e. The test-receiver system was set to Quasi-Peak Detect Function and Specified Bandwidth with Maximum Hold Mode.

Note:

1. The resolution bandwidth and video bandwidth of test receiver/spectrum analyzer is 9 kHz at frequency below 30 MHz.

For Radiated Emission above 30 MHz

- a. The EUT was placed on the top of a rotating table 0.8 meters (for 30 MHz ~ 1 GHz) above the ground at 3 meter chamber room for test. The table was rotated 360 degrees to determine the position of the highest radiation.
- b. The EUT was set 3 meters away from the interference-receiving antenna, which was mounted on the top of a variable-height antenna tower.
- c. The height of antenna is varied from one meter to four meters above the ground to determine the maximum value of the field strength. Both horizontal and vertical polarizations of the antenna are set to make the measurement.
- d. For each suspected emission, the EUT was arranged to its worst case and then the antenna was tuned to heights from 1 meter to 4 meters and the rotatable table was turned from 0 degrees to 360 degrees to find the maximum reading.
- e. The test-receiver system was set to quasi-peak detect function and specified bandwidth with maximum hold mode when the test frequency is below 1 GHz.

Note:

1. The resolution bandwidth and video bandwidth of test receiver/spectrum analyzer is 120 kHz for Quasi-peak detection (QP) or Peak detection (PK) at frequency below 1 GHz.
2. All modes of operation were investigated and the worst-case emissions are reported.

4.1.4 Deviation from Test Standard

No deviation.

4.1.5 Test Set Up

<Radiated Emission below 30 MHz>

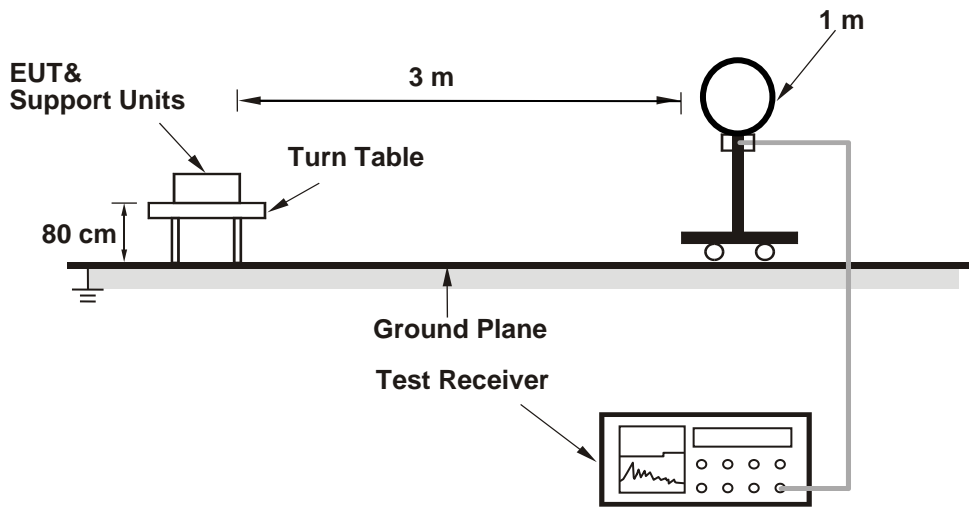

<Radiated Emission 30 MHz to 1 GHz>

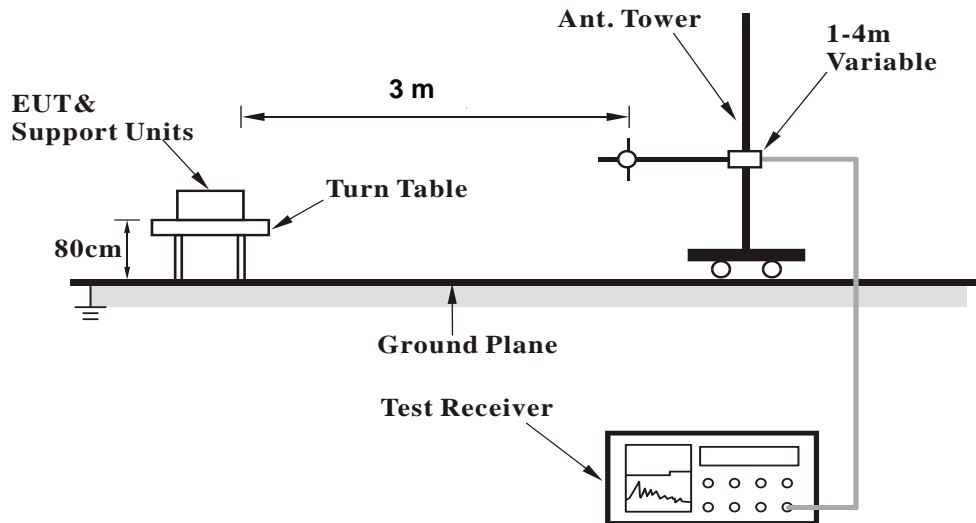

For the actual test configuration, please refer to the attached file (Test Setup Photo).

4.1.6 EUT Operating Conditions

Set the EUT under transmission condition continuously at specific channel frequency.

4.1.7 Test Results

30 MHz ~ 1 GHz Data:

Mode A

EUT Test Condition		Measurement Detail	
Channel	Channel 0	Frequency Range	30 MHz ~ 1 GHz
Input Power	120 Vac, 60 Hz	Detector Function	Quasi-peak (QP)
Environmental Conditions	25 deg. C, 65 % RH	Tested By	Cyril Chen

Horizontal

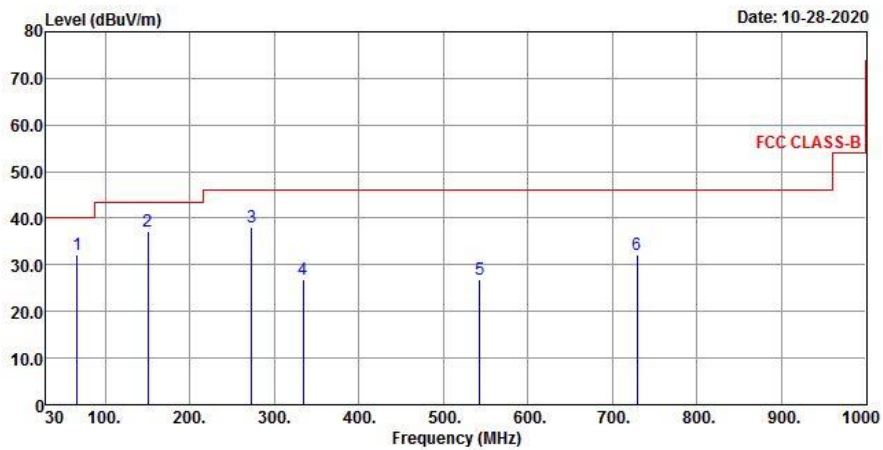

Vertical

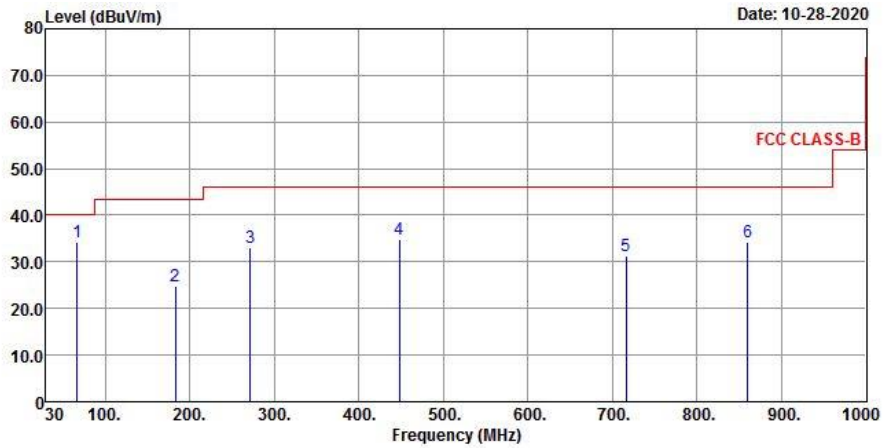

Antenna Polarity & Test Distance: Horizontal at 3 m

Frequency (MHz)	Emission Level (dBuV/m)	Read Level (dBuV)	Factor (dB/m)	Limit (dBuV/m)	Margin (dB)	Antenna Height (cm)	Table Angle (Degree)	Remark
66.86	32.06	45.25	-13.19	40	-7.94	162	231	QP
150.28	37.31	49.02	-11.71	43.5	-6.19	177	121	QP
273.47	38.16	50.13	-11.97	46	-7.84	162	247	QP
334.58	26.72	36.69	-9.97	46	-19.28	200	181	QP
543.13	26.94	31.58	-4.64	46	-19.06	149	218	QP
729.37	32.23	31.94	0.29	46	-13.77	122	137	QP

Antenna Polarity & Test Distance: Vertical at 3 m

Frequency (MHz)	Emission Level (dBuV/m)	Read Level (dBuV)	Factor (dB/m)	Limit (dBuV/m)	Margin (dB)	Antenna Height (cm)	Table Angle (Degree)	Remark
66.86	34.27	47.46	-13.19	40	-5.73	141	179	QP
183.26	24.92	38.69	-13.77	43.5	-18.58	193	257	QP
271.53	33.17	45.22	-12.05	46	-12.83	167	180	QP
448.07	34.73	41.21	-6.48	46	-11.27	122	147	QP
715.79	31.38	31.73	-0.35	46	-14.62	185	123	QP
860.32	34.35	31.75	2.6	46	-11.65	176	266	QP

Remarks:

- Emission Level = Read Level + Factor
Margin value = Emission level – Limit value
- The emission levels of other frequencies were very low against the limit.

Mode B

EUT Test Condition		Measurement Detail	
Channel	Channel 0	Frequency Range	30 MHz ~ 1 GHz
Input Power	120 Vac, 60 Hz	Detector Function	Quasi-peak (QP)
Environmental Conditions	25 deg. C, 65 % RH	Tested By	Cyril Chen

Horizontal

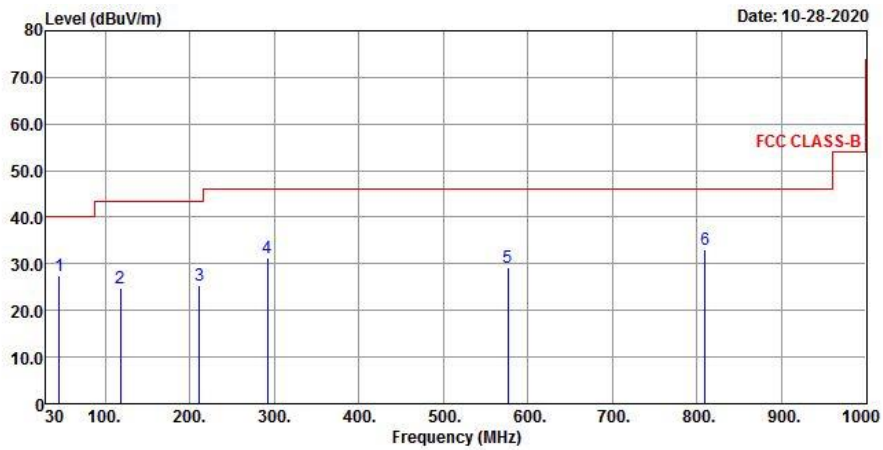

Vertical

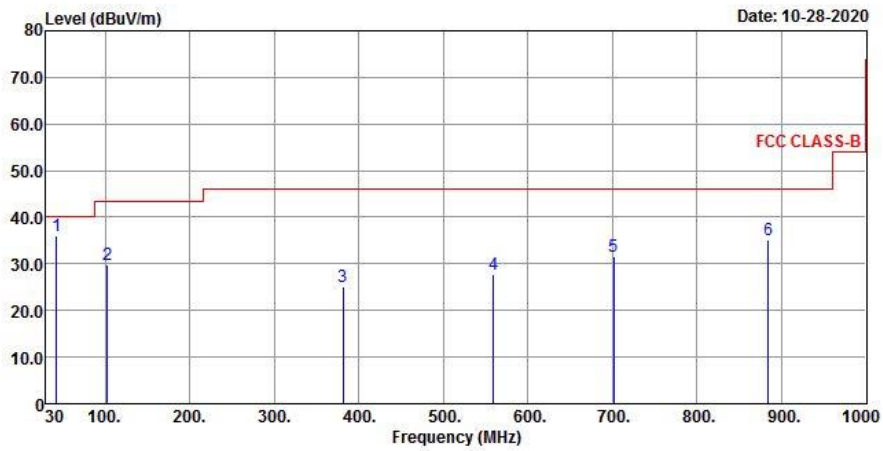

Antenna Polarity & Test Distance: Horizontal at 3 m

Frequency (MHz)	Emission Level (dBuV/m)	Read Level (dBuV)	Factor (dB/m)	Limit (dBuV/m)	Margin (dB)	Antenna Height (cm)	Table Angle (Degree)	Remark
45.52	27.6	39.38	-11.78	40	-12.4	106	254	QP
118.27	24.78	38.73	-13.95	43.5	-18.72	197	188	QP
211.39	25.35	40.39	-15.04	43.5	-18.15	142	148	QP
291.9	31.36	42.76	-11.4	46	-14.64	169	211	QP
576.11	29.3	32.84	-3.54	46	-16.7	121	254	QP
809.88	33.1	31.2	1.9	46	-12.9	133	108	QP

Antenna Polarity & Test Distance: Vertical at 3 m

Frequency (MHz)	Emission Level (dBuV/m)	Read Level (dBuV)	Factor (dB/m)	Limit (dBuV/m)	Margin (dB)	Antenna Height (cm)	Table Angle (Degree)	Remark
42.61	36.13	48.11	-11.98	40	-3.87	108	301	QP
102.75	29.75	45.36	-15.61	43.5	-13.75	123	68	QP
381.14	25.17	33.88	-8.71	46	-20.83	172	90	QP
559.62	27.86	32.02	-4.16	46	-18.14	145	158	QP
701.24	31.55	32.16	-0.61	46	-14.45	196	283	QP
884.57	35.21	32.45	2.76	46	-10.79	166	210	QP

Remarks:

- Emission Level = Read Level + Factor
Margin value = Emission level – Limit value
- The emission levels of other frequencies were very low against the limit.

Mode C

EUT Test Condition		Measurement Detail	
Channel	Channel 0	Frequency Range	30 MHz ~ 1 GHz
Input Power	120 Vac, 60 Hz	Detector Function	Quasi-peak (QP)
Environmental Conditions	25 deg. C, 65 % RH	Tested By	Cyril Chen

Horizontal

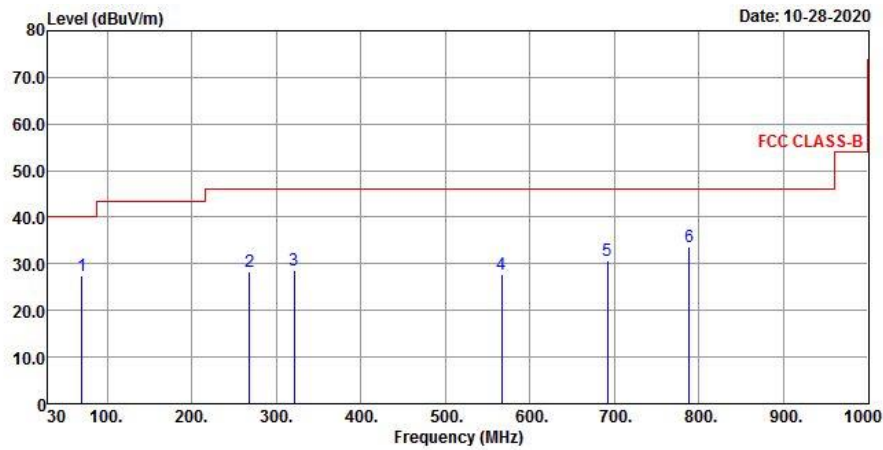

Vertical

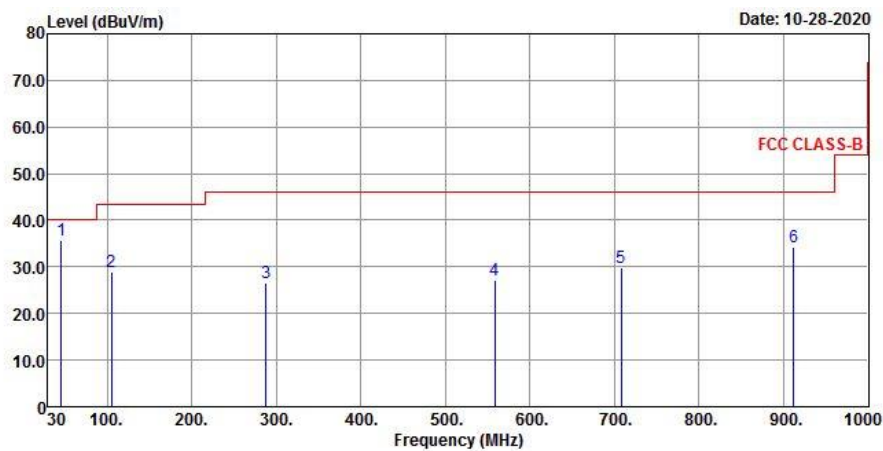

Antenna Polarity & Test Distance: Horizontal at 3 m								
Frequency (MHz)	Emission Level (dBuV/m)	Read Level (dBuV)	Factor (dB/m)	Limit (dBuV/m)	Margin (dB)	Antenna Height (cm)	Table Angle (Degree)	Remark
69.77	27.4	41.25	-13.85	40	-12.6	133	189	QP
268.62	28.32	40.51	-12.19	46	-17.68	174	258	QP
321	28.66	39.08	-10.42	46	-17.34	166	132	QP
566.41	27.78	31.67	-3.89	46	-18.22	124	255	QP
691.54	30.69	31.54	-0.85	46	-15.31	107	154	QP
788.54	33.55	32.02	1.53	46	-12.45	129	199	QP
Antenna Polarity & Test Distance: Vertical at 3 m								
Frequency (MHz)	Emission Level (dBuV/m)	Read Level (dBuV)	Factor (dB/m)	Limit (dBuV/m)	Margin (dB)	Antenna Height (cm)	Table Angle (Degree)	Remark
45.52	35.63	47.41	-11.78	40	-4.37	197	161	QP
104.69	28.98	44.25	-15.27	43.5	-14.52	194	132	QP
288.02	26.44	37.93	-11.49	46	-19.56	173	60	QP
558.65	27.22	31.42	-4.2	46	-18.78	138	251	QP
708.03	29.67	30.15	-0.48	46	-16.33	166	88	QP
911.73	34.28	31.1	3.18	46	-11.72	122	177	QP

Remarks:

1. Emission Level = Read Level + Factor
Margin value = Emission level – Limit value
2. The emission levels of other frequencies were very low against the limit.

4.2 Conducted Emission Measurement

4.2.1 Limits of Conducted Emission Measurement

Frequency (MHz)	Conducted Limit (dBuV)	
	Quasi-Peak	Average
0.15 - 0.5	66 - 56	56 - 46
0.50 - 5.0	56	46
5.0 - 30.0	60	50

- Note: 1. The lower limit shall apply at the transition frequencies.
 2. The limit decreases in line with the logarithm of the frequency in the range of 0.15 to 0.50 MHz.

4.2.2 Test Instruments

Description & Manufacturer	Model No.	Serial No.	Date of Calibration	Due Date of Calibration
Test Receiver ROHDE & SCHWARZ	ESR3	102412	Feb. 17, 2020	Feb. 16, 2021
RF signal cable (with 10dB PAD) Woken	5D-FB	Cable-cond2-01	Sep. 04, 2020	Sep. 03, 2021
LISN/AMN ROHDE & SCHWARZ (EUT)	ESH2-Z5	100100	Jan. 20, 2020	Jan. 19, 2021
LISN/AMN ROHDE & SCHWARZ (Peripheral)	ESH3-Z5	100312	Aug. 18, 2020	Aug. 17, 2021
Software ADT	BV ADT_Cond_ V7.3.7.4	NA	NA	NA

- Note: 1. The calibration interval of the above test instruments is 12 months and the calibrations are traceable to NML/ROC and NIST/USA.
 2. The test was performed in HwaYa Shielded Room 2. (Conduction 2)
 3. The VCCI Site Registration No. is C-12047.

4.2.3 Test Procedures

- The EUT was placed 0.4 meters from the conducting wall of the shielded room with EUT being connected to the power mains through a line impedance stabilization network (LISN). Other support units were connected to the power mains through another LISN. The two LISNs provide 50 ohm/ 50 uH of coupling impedance for the measuring instrument.
- Both lines of the power mains connected to the EUT were checked for maximum conducted interference.
- The frequency range from 150 kHz to 30 MHz was searched. Emission levels under (Limit – 20 dB) was not recorded.

Note: The resolution bandwidth and video bandwidth of test receiver is 9 kHz for quasi-peak detection (QP) and average detection (AV) at frequency 0.15 MHz - 30 MHz.

4.2.4 Deviation from Test Standard

No deviation.

4.2.5 Test Setup

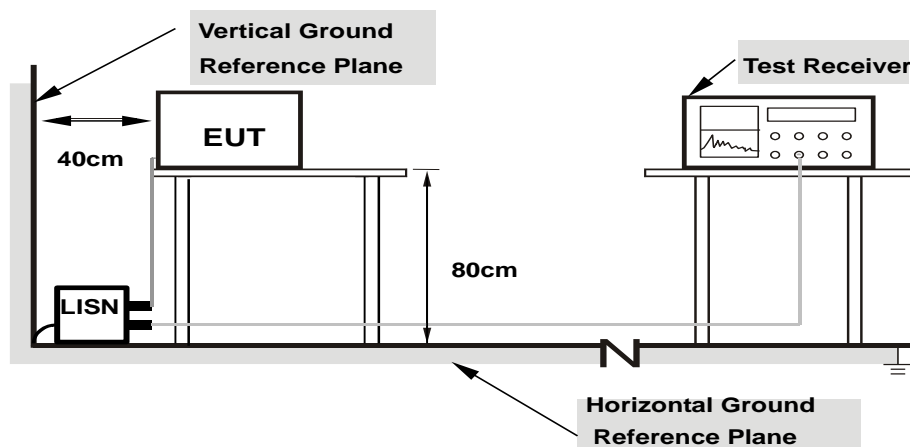

- Note:**
- Support units were connected to second LISN.
 - Both of LISNs (AMN) are 80 cm from EUT and at least 80 from other units and other metal planes

For the actual test configuration, please refer to the attached file (Test Setup Photo).

4.2.6 EUT Operating Condition

Set the EUT under transmission condition continuously at specific channel frequency.

4.2.7 Test Results

Frequency Range	150kHz ~ 30MHz	Detector Function & Resolution Bandwidth	Quasi-Peak (QP) / Average (AV), 9kHz
Input Power	120Vac, 60Hz	Environmental Conditions	21°C, 65%RH
Tested by	Getaz Yang	Test Date	2020/11/4
Test Mode	Mode A		

Phase Of Power : Line (L)										
No	Frequency (MHz)	Correction Factor (dB)	Reading Value (dBuV)		Emission Level (dBuV)		Limit (dBuV)		Margin (dB)	
			Q.P.	AV.	Q.P.	AV.	Q.P.	AV.	Q.P.	AV.
1	0.15391	9.65	34.42	29.42	44.07	39.07	65.79	55.79	-21.72	-16.72
2	0.32204	9.66	21.96	14.27	31.62	23.93	59.65	49.65	-28.03	-25.72
3	0.47039	9.66	25.06	19.36	34.72	29.02	56.51	46.51	-21.79	-17.49
4	5.16262	9.75	12.65	6.82	22.40	16.57	60.00	50.00	-37.60	-33.43
5	8.27498	9.78	13.64	7.18	23.42	16.96	60.00	50.00	-36.58	-33.04
6	16.62283	9.85	15.68	7.87	25.53	17.72	60.00	50.00	-34.47	-32.28

Remarks:

1. Q.P. and AV. are abbreviations of quasi-peak and average individually.
2. The emission levels of other frequencies were very low against the limit.
3. Margin value = Emission level – Limit value
4. Correction factor = Insertion loss + Cable loss
5. Emission Level = Correction Factor + Reading Value

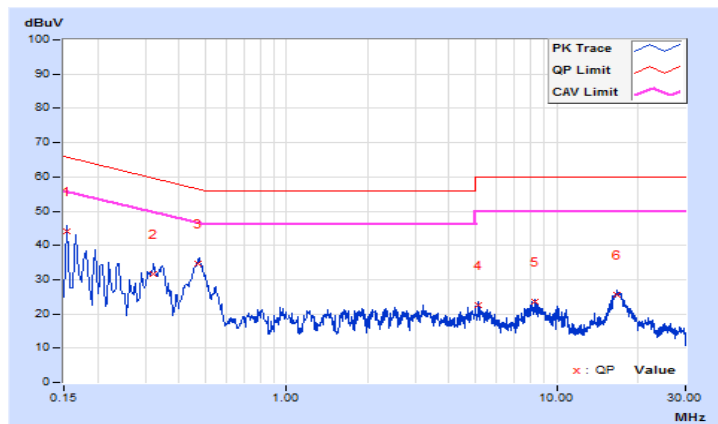

Frequency Range	150kHz ~ 30MHz	Detector Function & Resolution Bandwidth	Quasi-Peak (QP) / Average (AV), 9kHz
Input Power	120Vac, 60Hz	Environmental Conditions	21°C, 65%RH
Tested by	Getaz Yang	Test Date	2020/11/4
Test Mode	Mode A		

Phase Of Power : Neutral (N)										
No	Frequency (MHz)	Correction Factor (dB)	Reading Value (dBuV)		Emission Level (dBuV)		Limit (dBuV)		Margin (dB)	
			Q.P.	AV.	Q.P.	AV.	Q.P.	AV.	Q.P.	AV.
1	0.15782	9.68	29.39	22.93	39.07	32.61	65.58	55.58	-26.51	-22.97
2	0.20243	9.68	23.17	15.44	32.85	25.12	63.51	53.51	-30.66	-28.39
3	0.47039	9.68	24.27	17.02	33.95	26.70	56.51	46.51	-22.56	-19.81
4	1.15829	9.70	13.11	5.33	22.81	15.03	56.00	46.00	-33.19	-30.97
5	5.16653	9.78	11.61	3.54	21.39	13.32	60.00	50.00	-38.61	-36.68
6	17.36964	9.95	15.62	10.79	25.57	20.74	60.00	50.00	-34.43	-29.26

Remarks:

1. Q.P. and AV. are abbreviations of quasi-peak and average individually.
2. The emission levels of other frequencies were very low against the limit.
3. Margin value = Emission level – Limit value
4. Correction factor = Insertion loss + Cable loss
5. Emission Level = Correction Factor + Reading Value

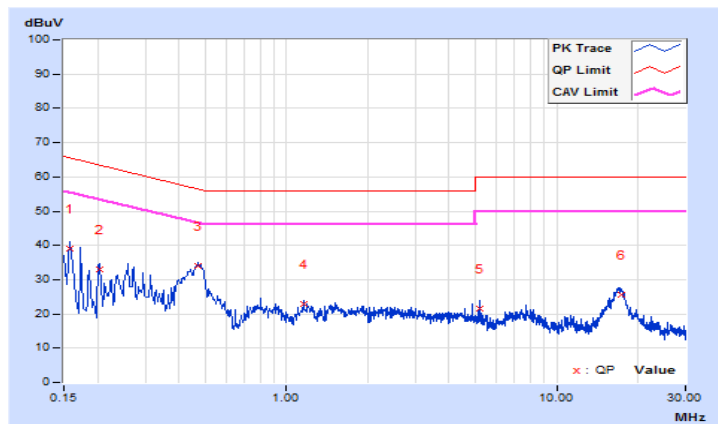

Frequency Range	150kHz ~ 30MHz	Detector Function & Resolution Bandwidth	Quasi-Peak (QP) / Average (AV), 9kHz
Input Power	120Vac, 60Hz	Environmental Conditions	25°C, 75%RH
Tested by	Getaz Yang	Test Date	2020/10/23
Test Mode	Mode B		

Phase Of Power : Line (L)										
No	Frequency (MHz)	Correction Factor (dB)	Reading Value (dBUV)		Emission Level (dBUV)		Limit (dBUV)		Margin (dB)	
			Q.P.	AV.	Q.P.	AV.	Q.P.	AV.	Q.P.	AV.
1	0.22683	10.10	25.19	17.99	35.29	28.09	62.56	52.56	-27.27	-24.47
2	0.46886	10.11	28.54	20.36	38.65	30.47	56.53	46.53	-17.88	-16.06
3	0.58425	10.12	17.51	9.54	27.63	19.66	56.00	46.00	-28.37	-26.34
4	1.19175	10.15	20.44	15.69	30.59	25.84	56.00	46.00	-25.41	-20.16
5	3.34500	10.21	19.45	13.31	29.66	23.52	56.00	46.00	-26.34	-22.48
6	17.30400	10.38	15.23	10.32	25.61	20.70	60.00	50.00	-34.39	-29.30

Remarks:

1. Q.P. and AV. are abbreviations of quasi-peak and average individually.
2. The emission levels of other frequencies were very low against the limit.
3. Margin value = Emission level – Limit value
4. Correction factor = Insertion loss + Cable loss
5. Emission Level = Correction Factor + Reading Value

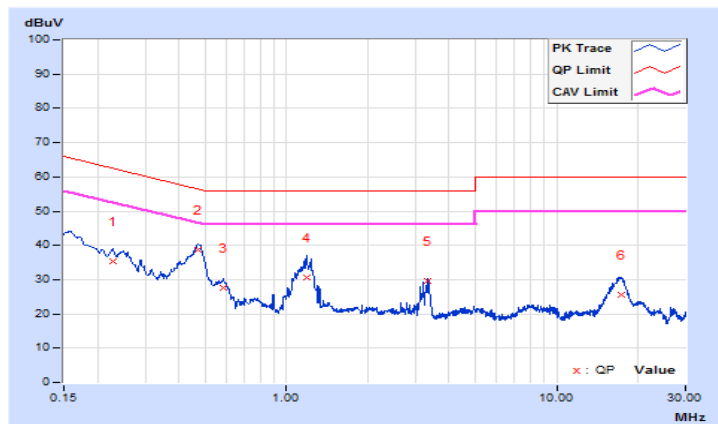

Frequency Range	150kHz ~ 30MHz	Detector Function & Resolution Bandwidth	Quasi-Peak (QP) / Average (AV), 9kHz
Input Power	120Vac, 60Hz	Environmental Conditions	25°C, 75%RH
Tested by	Getaz Yang	Test Date	2020/10/23
Test Mode	Mode B		

Phase Of Power : Neutral (N)										
No	Frequency (MHz)	Correction Factor (dB)	Reading Value (dBUV)		Emission Level (dBUV)		Limit (dBUV)		Margin (dB)	
			Q.P.	AV.	Q.P.	AV.	Q.P.	AV.	Q.P.	AV.
1	0.16787	10.06	25.42	21.42	35.48	31.48	65.07	55.07	-29.59	-23.59
2	0.26437	10.07	20.98	12.89	31.05	22.96	61.29	51.29	-30.24	-28.33
3	0.47384	10.09	27.85	20.58	37.94	30.67	56.45	46.45	-18.51	-15.78
4	0.60000	10.10	14.38	8.36	24.48	18.46	56.00	46.00	-31.52	-27.54
5	1.22325	10.13	11.49	3.57	21.62	13.70	56.00	46.00	-34.38	-32.30
6	16.87425	10.54	14.43	9.61	24.97	20.15	60.00	50.00	-35.03	-29.85

Remarks:

1. Q.P. and AV. are abbreviations of quasi-peak and average individually.
2. The emission levels of other frequencies were very low against the limit.
3. Margin value = Emission level – Limit value
4. Correction factor = Insertion loss + Cable loss
5. Emission Level = Correction Factor + Reading Value

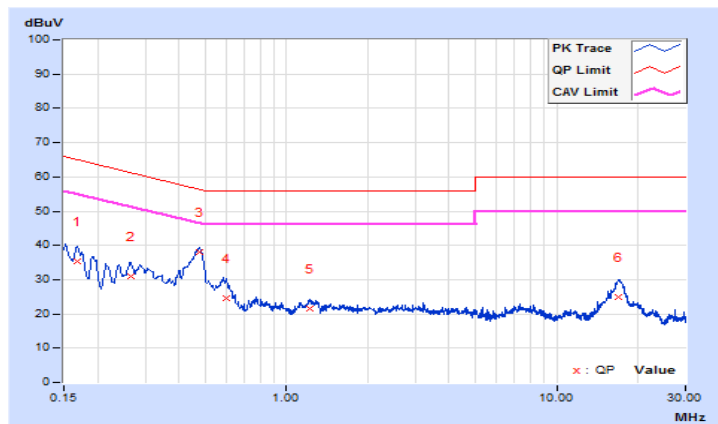

Frequency Range	150kHz ~ 30MHz	Detector Function & Resolution Bandwidth	Quasi-Peak (QP) / Average (AV), 9kHz
Input Power	120Vac, 60Hz	Environmental Conditions	25°C, 75%RH
Tested by	Getaz Yang	Test Date	2020/10/24
Test Mode	Mode C		

Phase Of Power : Line (L)										
No	Frequency (MHz)	Correction Factor (dB)	Reading Value (dBUV)		Emission Level (dBUV)		Limit (dBUV)		Margin (dB)	
			Q.P.	AV.	Q.P.	AV.	Q.P.	AV.	Q.P.	AV.
1	0.15509	10.09	30.45	23.87	40.54	33.96	65.72	55.72	-25.18	-21.76
2	0.47400	10.11	25.83	18.44	35.94	28.55	56.44	46.44	-20.50	-17.89
3	0.59306	10.12	18.45	11.37	28.57	21.49	56.00	46.00	-27.43	-24.51
4	1.18448	10.15	23.98	17.40	34.13	27.55	56.00	46.00	-21.87	-18.45
5	3.37650	10.21	19.55	10.33	29.76	20.54	56.00	46.00	-26.24	-25.46
6	17.04750	10.38	12.81	5.46	23.19	15.84	60.00	50.00	-36.81	-34.16

Remarks:

1. Q.P. and AV. are abbreviations of quasi-peak and average individually.
2. The emission levels of other frequencies were very low against the limit.
3. Margin value = Emission level – Limit value
4. Correction factor = Insertion loss + Cable loss
5. Emission Level = Correction Factor + Reading Value

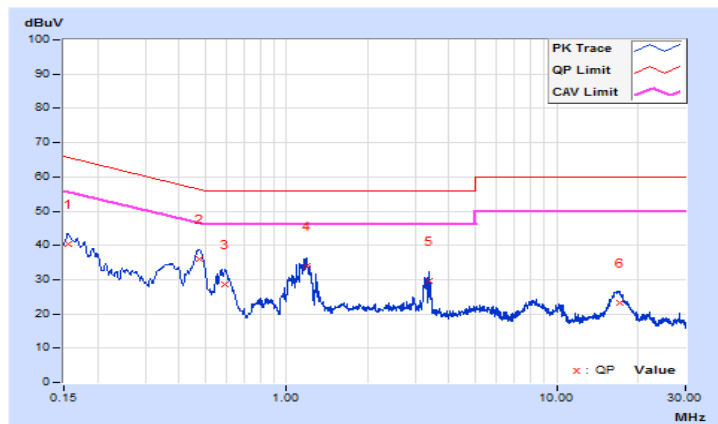

Frequency Range	150kHz ~ 30MHz	Detector Function & Resolution Bandwidth	Quasi-Peak (QP) / Average (AV), 9kHz
Input Power	120Vac, 60Hz	Environmental Conditions	25°C, 75%RH
Tested by	Getaz Yang	Test Date	2020/10/24
Test Mode	Mode C		

Phase Of Power : Neutral (N)										
No	Frequency (MHz)	Correction Factor (dB)	Reading Value (dBUV)		Emission Level (dBUV)		Limit (dBUV)		Margin (dB)	
			Q.P.	AV.	Q.P.	AV.	Q.P.	AV.	Q.P.	AV.
1	0.16575	10.06	31.93	24.32	41.99	34.38	65.17	55.17	-23.18	-20.79
2	0.35475	10.08	19.57	11.83	29.65	21.91	58.85	48.85	-29.20	-26.94
3	0.47175	10.09	24.51	18.30	34.60	28.39	56.48	46.48	-21.88	-18.09
4	1.24575	10.13	14.38	5.49	24.51	15.62	56.00	46.00	-31.49	-30.38
5	3.00300	10.19	11.12	4.79	21.31	14.98	56.00	46.00	-34.69	-31.02
6	16.99575	10.55	13.55	6.14	24.10	16.69	60.00	50.00	-35.90	-33.31

Remarks:

1. Q.P. and AV. are abbreviations of quasi-peak and average individually.
2. The emission levels of other frequencies were very low against the limit.
3. Margin value = Emission level – Limit value
4. Correction factor = Insertion loss + Cable loss
5. Emission Level = Correction Factor + Reading Value

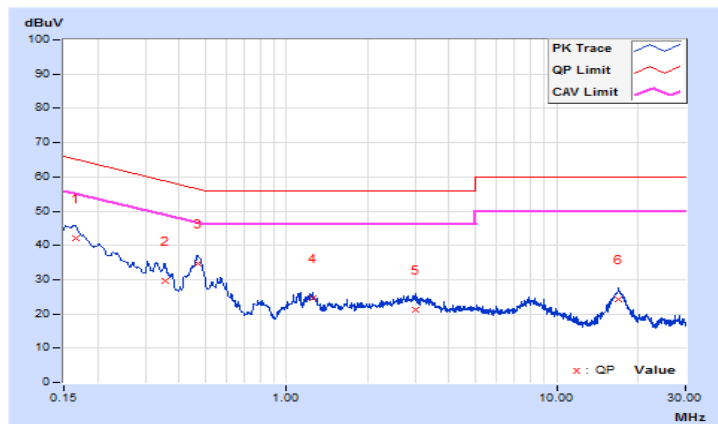

5 Pictures of Test Arrangements

Please refer to the attached file (Test Setup Photo).

Appendix – Information of the Testing Laboratories

We, Bureau Veritas Consumer Products Services (H.K.) Ltd., Taoyuan Branch, were founded in 1988 to provide our best service in EMC, Radio, Telecom and Safety consultation. Our laboratories are FCC recognized accredited test firms and accredited according to ISO/IEC 17025.

If you have any comments, please feel free to contact us at the following:

Lin Kou EMC/RF Lab

Tel: 886-2-26052180

Fax: 886-2-26051924

Hsin Chu EMC/RF/Telecom Lab

Tel: 886-3-6668565

Fax: 886-3-6668323

Hwa Ya EMC/RF/Safety Lab

Tel: 886-3-3183232

Fax: 886-3-3270892

Email: service.adt@tw.bureauveritas.com

Web Site: www.bureauveritas-adt.com

The address and road map of all our labs can be found in our web site also.

--- END ---