

FCC Test Report

Report No.: RFBGSN-WTW-P20080589-7

FCC ID: NKS-PA1

Test Model: Trimble Gateway-PA1

Received Date: Aug. 29, 2020

Test Date: Sep. 09, 2020 ~ Oct. 23, 2020

Issued Date: Nov. 03, 2020

Applicant: PeopleNet Communications Corporation

Address: 4400 Baker Road, Minnetonka Minnesota 55343-8684 United States

Issued By: Bureau Veritas Consumer Products Services (H.K.) Ltd., Taoyuan Branch
Lin Kou Laboratories

Lab Address: No. 47-2, 14th Ling, Chia Pau Vil., Lin Kou Dist., New Taipei City, Taiwan

Test Location: No.19, Hwa Ya 2nd Rd., Wen Hwa Vil., Kwei Shan Dist., Taoyuan City
33383, Taiwan

**FCC Registration /
Designation Number:** 788550 / TW0003



This report is for your exclusive use. Any copying or replication of this report to or for any other person or entity, or use of our name or trademark, is permitted only with our prior written permission. This report sets forth our findings solely with respect to the test samples identified herein. The results set forth in this report are not indicative or representative of the quality or characteristics of the lot from which a test sample was taken or any similar or identical product unless specifically and expressly noted. Our report includes all of the tests requested by you and the results thereof based upon the information that you provided to us. You have 60 days from date of issuance of this report to notify us of any material error or omission caused by our negligence, provided, however, that such notice shall be in writing and shall specifically address the issue you wish to raise. A failure to raise such issue within the prescribed time shall constitute your unqualified acceptance of the completeness of this report, the tests conducted and the correctness of the report contents. Unless specific mention, the uncertainty of measurement has been explicitly taken into account to declare the compliance or non-compliance to the specification.

Table of Contents

Release Control Record	4
1 Certificate of Conformity	5
2 Summary of Test Results.....	6
2.1 Measurement Uncertainty.....	6
2.2 Modification Record	6
3 General Information	7
3.1 General Description of EUT	7
3.2 Description of Test Modes.....	9
3.2.1 Test Mode Applicability and Tested Channel Detail.....	11
3.3 Duty Cycle of Test Signal	13
3.4 Description of Support Units	14
3.4.1 Configuration of System under Test	14
3.5 General Description of Applied Standards and References	15
4 Test Types and Results	16
4.1 Radiated Emission and Bandedge Measurement	16
4.1.1 Limits of Radiated Emission and Bandedge Measurement	16
4.1.2 Test Instruments	18
4.1.3 Test Procedures.....	19
4.1.4 Deviation from Test Standard	19
4.1.5 Test Setup.....	20
4.1.6 EUT Operating Conditions.....	21
4.1.7 Test Results	22
4.2 Conducted Emission Measurement.....	62
4.2.1 Limits of Conducted Emission Measurement	62
4.2.2 Test Instruments	62
4.2.3 Test Procedures.....	63
4.2.4 Deviation from Test Standard	63
4.2.5 Test Setup.....	63
4.2.6 EUT Operating Conditions.....	63
4.2.7 Test Results	64
4.3 Transmit Power Measurement.....	66
4.3.1 Limits of Transmit Power Measurement	66
4.3.2 Test Setup.....	66
4.3.3 Test Instruments	67
4.3.4 Test Procedure	67
4.3.5 Deviation from Test Standard	67
4.3.6 EUT Operating Conditions.....	67
4.3.7 Test Results	68
4.4 Occupied Bandwidth Measurement.....	73
4.4.1 Test Setup.....	73
4.4.2 Test Instruments	73
4.4.3 Test Procedure	73
4.4.4 Test Results	74
4.5 Peak Power Spectral Density Measurement	78
4.5.1 Limits of Peak Power Spectral Density Measurement	78
4.5.2 Test Setup.....	78
4.5.3 Test Instruments	78
4.5.4 Test Procedures.....	78
4.5.5 Deviation from Test Standard	79
4.5.6 EUT Operating Conditions.....	79
4.5.7 Test Results	80
4.6 Frequency Stability	85
4.6.1 Limit of Frequency Stability Measurement	85

4.6.2	Test Setup	85
4.6.3	Test Instruments	85
4.6.4	Test Procedure	85
4.6.5	Deviation from Test Standard	85
4.6.6	EUT Operating Condition	85
4.6.7	Test Results	86
4.7	6 dB Bandwidth Measurement.....	87
4.7.1	Limits of 6 dB Bandwidth Measurement.....	87
4.7.2	Test Setup.....	87
4.7.3	Test Instruments	87
4.7.4	Test Procedure	87
4.7.5	Deviation from Test Standard	87
4.7.6	EUT Operating Condition	87
4.7.7	Test Results	88
5	Pictures of Test Arrangements.....	90
	Annex A- Radiated Out of Band Emission (OOBE) Measurement (For U-NII-3 band)	91
	Annex B- Band Edge Measurement.....	94
	Appendix – Information of the Testing Laboratories	100

Release Control Record

Issue No.	Description	Date Issued
RFBGSN-WTW-P20080589-7	Original Release	Nov. 03, 2020

1 Certificate of Conformity

Product: Trimble Gateway NA

Brand: Trimble

Test Model: Trimble Gateway-PA1

Sample Status: Engineering Sample

Applicant: PeopleNet Communications Corporation

Test Date: Sep. 09, 2020 ~ Oct. 23, 2020

Standards: 47 CFR FCC Part 15, Subpart E (Section 15.407)
ANSI C63.10:2013

The above equipment has been tested by **Bureau Veritas Consumer Products Services (H.K.) Ltd., Taoyuan Branch**, and found compliance with the requirement of the above standards. The test record, data evaluation & Equipment Under Test (EUT) configurations represented herein are true and accurate accounts of the measurements of the sample's RF characteristics under the conditions specified in this report.

Prepared by :  , **Date:** Nov. 03, 2020
Vera Huang / Specialist

Approved by :  , **Date:** Nov. 03, 2020
Dylan Chiou / Senior Project Engineer

2 Summary of Test Results

47 CFR FCC Part 15, Subpart E (Section 15.407)			
FCC Clause	Test Item	Result	Remarks
15.407(b)(6)	AC Power Conducted Emissions	Pass	Meet the requirement of limit. Minimum passing margin is -18.12 dB at 0.47800 MHz.
15.407(b) (1/2/3/4(i/ii)/6)	Radiated Emissions & Band Edge Measurement	Pass	Meet the requirement of limit. Minimum passing margin is -0.71 dB at 5150 MHz.
15.407(a)(1/2/3)	Max Average Transmit Power	Pass	Meet the requirement of limit.
---	Occupied Bandwidth Measurement	-	Reference only
15.407(a)(1/2/3)	Peak Power Spectral Density	Pass	Meet the requirement of limit.
15.407(e)	6 dB Bandwidth	Pass	Meet the requirement of limit. (U-NII-3 Band only)
15.407(g)	Frequency Stability	Pass	Meet the requirement of limit.
15.203	Antenna Requirement	Pass	No antenna connector is used.

Note:

- For U-NII-3 band compliance with rule part 15.407(b)(4)(i), the OOB test plots were recorded in Annex A.
- For U-NII-1, U-NII-2A, U-NII-2C band compliance with rule 15.407(b) of the band-edge items, the test plots were recorded in Annex B. Test Procedures refer to report 4.1.3.
- Determining compliance based on the results of the compliance measurement, not taking into account measurement instrumentation uncertainty.

2.1 Measurement Uncertainty

Where relevant, the following measurement uncertainty levels have been estimated for tests performed on the EUT as specified in CISPR 16-4-2:

Measurement	Frequency	Expanded Uncertainty (k=2) (±)
Conducted Emissions at mains ports	150 kHz ~ 30 MHz	2.79 dB
Radiated Emissions up to 1 GHz	9 kHz ~ 30 MHz	3.04 dB
	30 MHz ~ 200 MHz	2.93 dB
	200 MHz ~ 1000 MHz	2.95 dB
Radiated Emissions above 1 GHz	1 GHz ~ 18 GHz	2.26 dB
	18 GHz ~ 40 GHz	1.94 dB

2.2 Modification Record

There were no modifications required for compliance.

3 General Information

3.1 General Description of EUT

Product	Trimble Gateway NA
Brand	Trimble
Test Model	Trimble Gateway-PA1
Status of EUT	Engineering Sample
Power Supply Rating	12 Vdc (adapter)
Modulation Type	256QAM, 64QAM, 16QAM, QPSK, BPSK
Modulation Technology	OFDM
Transfer Rate	802.11a: 54.0/ 48.0/ 36.0/ 24.0/ 18.0/ 12.0/ 9.0/ 6.0 Mbps 802.11n: up to MCS7 802.11ac: up to V9
Operating Frequency	5180 ~ 5240 MHz, 5260 ~ 5320 MHz, 5500 ~ 5700 MHz, 5745 ~ 5825 MHz
Number of Channel	5180 ~ 5240 MHz: 4 for 802.11a, 802.11n (HT20), 802.11ac (VHT20) 2 for 802.11n (HT40), 802.11ac (VHT40) 1 for 802.11ac (VHT80) 5260 ~ 5320 MHz: 4 for 802.11a, 802.11n (HT20), 802.11ac (VHT20) 2 for 802.11n (HT40), 802.11ac (VHT40) 1 for 802.11ac (VHT80) 5500 ~ 5700 MHz: 11 for 802.11a, 802.11n (HT20), 802.11ac (VHT20) 5 for 802.11n (HT40), 802.11ac (VHT40) 2 for 802.11ac (VHT80) 5745 ~ 5825 MHz: 5 for 802.11a, 802.11n (HT20), 802.11ac (VHT20) 2 for 802.11n (HT40), 802.11ac (VHT40) 1 for 802.11ac (VHT80)
Output Power	59.156 mW for 5180 ~ 5240 MHz 60.674 mW for 5260 ~ 5320 MHz 58.21 mW for 5500 ~ 5700 MHz 57.016 mW for 5745 ~ 5825 MHz
Antenna Type	FPC antenna with 1.22 dBi gain (5180 ~ 5240 MHz) FPC antenna with 1.22 dBi gain (5260 ~ 5320 MHz) FPC antenna with 3.58 dBi gain (5500 ~ 5700 MHz) FPC antenna with 3.52 dBi gain (5745 ~ 5825 MHz)
Antenna Connector	N/A
Accessory Device	N/A
Data Cable Supplied	N/A

Note:

1. The EUT provides one completed transmitter and one receiver.

Modulation Mode	Tx Function
802.11a	1TX
802.11n (HT20)	1TX
802.11n (HT40)	1TX
802.11ac (VHT20)	1TX
802.11ac (VHT40)	1TX
802.11ac (VHT80)	1TX

* The modulation and bandwidth are similar for 802.11n mode for HT20 / HT40 and 802.11ac mode for VHT20 / VHT40, therefore investigated worst case to representative mode in test report. (Final test mode refer section 3.2.1)

2. The information of module collocated in this EUT is listed as below.

Product	Brand	Model
BT/WLAN Module	msi	BM25
WWAN Module	Quectel	EC25-A
AH Module	silex	SX-NEWAH

3. The above Antenna information is declared by manufacturer and for more detailed features description, please refer to the manufacturer's specifications, the laboratory shall not be held responsible.
4. The above EUT information is declared by manufacturer and for more detailed features description, please refers to the manufacturer's specifications or user's manual.

3.2 Description of Test Modes

For 5180 ~ 5240 MHz

4 channels are provided for 802.11a, 802.11n (HT20), 802.11ac (VHT20):

Channel	Frequency (MHz)	Channel	Frequency (MHz)
36	5180	44	5220
40	5200	48	5240

2 channels are provided for 802.11n (HT40), 802.11ac (VHT40):

Channel	Frequency (MHz)	Channel	Frequency (MHz)
38	5190	46	5230

1 channel is provided for 802.11ac (VHT80):

Channel	Frequency (MHz)
42	5210

For 5260 ~ 5320 MHz

4 channels are provided for 802.11a, 802.11n (HT20), 802.11ac (VHT20):

Channel	Frequency (MHz)	Channel	Frequency (MHz)
52	5260	60	5300
56	5280	64	5320

2 channels are provided for 802.11n (HT40), 802.11ac (VHT40):

Channel	Frequency (MHz)	Channel	Frequency (MHz)
54	5270	62	5310

1 channel is provided for 802.11ac (VHT80):

Channel	Frequency (MHz)
58	5290

For 5500 ~ 5700 MHz

11 channels are provided for 802.11a, 802.11n (HT20), 802.11ac (VHT20):

Channel	Frequency (MHz)	Channel	Frequency (MHz)
100	5500	124	5620
104	5520	128	5640
108	5540	132	5660
112	5560	136	5680
116	5580	140	5700
120	5600		

5 channels are provided for 802.11n (HT40), 802.11ac (VHT40):

Channel	Frequency (MHz)	Channel	Frequency (MHz)
102	5510	126	5630
110	5550	134	5670
118	5590		

2 channels are provided for 802.11ac (VHT80):

Channel	Frequency (MHz)	Channel	Frequency (MHz)
106	5530	122	5610

For 5745 ~ 5825 MHz:

5 channels are provided for 802.11a, 802.11n (HT20), 802.11ac (VHT20):

Channel	Frequency (MHz)	Channel	Frequency (MHz)
149	5745	161	5805
153	5765	165	5825
157	5785		

2 channels are provided for 802.11n (HT40), 802.11ac (VHT40):

Channel	Frequency (MHz)	Channel	Frequency (MHz)
151	5755	159	5795

1 channel is provided for 802.11ac (VHT80):

Channel	Frequency (MHz)
155	5775

3.2.1 Test Mode Applicability and Tested Channel Detail

EUT Configure Mode	Applicable To				Description
	RE \geq 1G	RE $<$ 1G	PLC	APCM	
-	√	√	√	√	-

Where **RE \geq 1G**: Radiated Emission above 1 GHz **RE $<$ 1G**: Radiated Emission below 1 GHz
PLC: Power Line Conducted Emission **APCM**: Antenna Port Conducted Measurement

Note:

1. The EUT had been pre-tested on the positioned of each 3 axis. The worst case was found when positioned on **X-plane**.
2. "-" means no effect.

Radiated Emission Test (Above 1 GHz):

- Pre-Scan has been conducted to determine the worst-case mode from all possible combinations between available modulations, data rates and antenna ports (if EUT with antenna diversity architecture).
- Following channel(s) was (were) selected for the final test as listed below.

EUT Configure Mode	Frequency Band (MHz)	Mode	Available Channel	Tested Channel	Modulation Technology	Modulation Type	Data Rate (Mbps)
-	5180-5240	802.11a	36 to 48	36, 40, 48	OFDM	BPSK	6.0
-		802.11n (HT20)	36 to 48	36, 40, 48	OFDM	BPSK	6.5
-		802.11n (HT40)	38 to 46	38, 46	OFDM	BPSK	13.5
-		802.11ac (VHT80)	42	42	OFDM	BPSK	29.3
-	5260-5320	802.11a	52 to 64	52, 60, 64	OFDM	BPSK	6.0
-		802.11n (HT20)	52 to 64	52, 60, 64	OFDM	BPSK	6.5
-		802.11n (HT40)	54 to 62	54, 62	OFDM	BPSK	13.5
-		802.11ac (VHT80)	58	58	OFDM	BPSK	29.3
-	5500-5700	802.11a	100 to 140	100, 116, 140	OFDM	BPSK	6.0
-		802.11n (HT20)	100 to 140	100, 116, 140	OFDM	BPSK	6.5
-		802.11n (HT40)	102 to 134	102, 110, 134	OFDM	BPSK	13.5
-		802.11ac (VHT80)	106 to 122	106, 122	OFDM	BPSK	29.3
-	5745-5825	802.11a	149 to 165	149, 157, 165	OFDM	BPSK	6.0
-		802.11n (HT20)	149 to 165	149, 157, 165	OFDM	BPSK	6.5
-		802.11n (HT40)	151 to 159	151, 159	OFDM	BPSK	13.5
-		802.11ac (VHT80)	155	155	OFDM	BPSK	29.3

Radiated Emission Test (Below 1 GHz):

- Pre-Scan has been conducted to determine the worst-case mode from all possible combinations between available modulations, data rates and antenna ports (if EUT with antenna diversity architecture).
- Following channel(s) was (were) selected for the final test as listed below.

EUT Configure Mode	Frequency Band (MHz)	Mode	Available Channel	Tested Channel	Modulation Technology	Modulation Type	Data Rate (Mbps)
-	5180-5240	802.11n (HT40)	38 to 46	38	OFDM	BPSK	13.5

Power Line Conducted Emission Test:

- Pre-Scan has been conducted to determine the worst-case mode from all possible combinations between available modulations, data rates and antenna ports (if EUT with antenna diversity architecture).
- Following channel(s) was (were) selected for the final test as listed below.

EUT Configure Mode	Frequency Band (MHz)	Mode	Available Channel	Tested Channel	Modulation Technology	Modulation Type	Data Rate (Mbps)
-	5180-5240	802.11n (HT40)	38 to 46	38	OFDM	BPSK	13.5

Antenna Port Conducted Measurement:

- This item includes all test value of each mode, but only includes spectrum plot of worst value of each mode.
- Pre-Scan has been conducted to determine the worst-case mode from all possible combinations between available modulations, data rates and antenna ports (if EUT with antenna diversity architecture).
- Following channel(s) was (were) selected for the final test as listed below.

EUT Configure Mode	Frequency Band (MHz)	Mode	Available Channel	Tested Channel	Modulation Technology	Modulation Type	Data Rate (Mbps)
-	5180-5240	802.11a	36 to 48	36, 40, 48	OFDM	BPSK	6.0
-		802.11n (HT20)	36 to 48	36, 40, 48	OFDM	BPSK	6.5
-		802.11n (HT40)	38 to 46	38, 46	OFDM	BPSK	13.5
-		802.11ac (VHT80)	42	42	OFDM	BPSK	29.3
-	5260-5320	802.11a	52 to 64	52, 60, 64	OFDM	BPSK	6.0
-		802.11n (HT20)	52 to 64	52, 60, 64	OFDM	BPSK	6.5
-		802.11n (HT40)	54 to 62	54, 62	OFDM	BPSK	13.5
-		802.11ac (VHT80)	58	58	OFDM	BPSK	29.3
-	5500-5700	802.11a	100 to 140	100, 116, 140	OFDM	BPSK	6.0
-		802.11n (HT20)	100 to 140	100, 116, 140	OFDM	BPSK	6.5
-		802.11n (HT40)	102 to 134	102, 110, 134	OFDM	BPSK	13.5
-		802.11ac (VHT80)	106 to 122	106, 122	OFDM	BPSK	29.3
-	5745-5825	802.11a	149 to 165	149, 157, 165	OFDM	BPSK	6.0
-		802.11n (HT20)	149 to 165	149, 157, 165	OFDM	BPSK	6.5
-		802.11n (HT40)	151 to 159	151, 159	OFDM	BPSK	13.5
-		802.11ac (VHT80)	155	155	OFDM	BPSK	29.3

Test Condition:

Applicable To	Environmental Conditions	Input Power	Tested by
RE≥1G	25 deg. C, 65 % RH	120 Vac, 60 Hz	Tim Chen
RE<1G	25 deg. C, 65 % RH	120 Vac, 60 Hz	Tim Chen
PLC	25 deg. C, 65 % RH	120 Vac, 60 Hz	Getaz Yang
APCM	25 deg. C, 65 % RH	120 Vac, 60 Hz	Wayne Huang

3.3 Duty Cycle of Test Signal

MODULATION TYPE: BPSK

Duty cycle of test signal is < 98 %, duty factor is required.

802.11a: Duty cycle = 1.428/1.531 = 0.933, Duty factor = $10 \cdot \log(1/0.933) = 0.30$

802.11n (HT20): Duty cycle = 1.334/1.437 = 0.928, Duty factor = $10 \cdot \log(1/0.928) = 0.32$

802.11n (HT40): Duty cycle = 0.663/0.765 = 0.867, Duty factor = $10 \cdot \log(1/0.867) = 0.62$

802.11ac (VHT80): Duty cycle = 0.331/0.433 = 0.764, Duty factor = $10 \cdot \log(1/0.764) = 1.17$

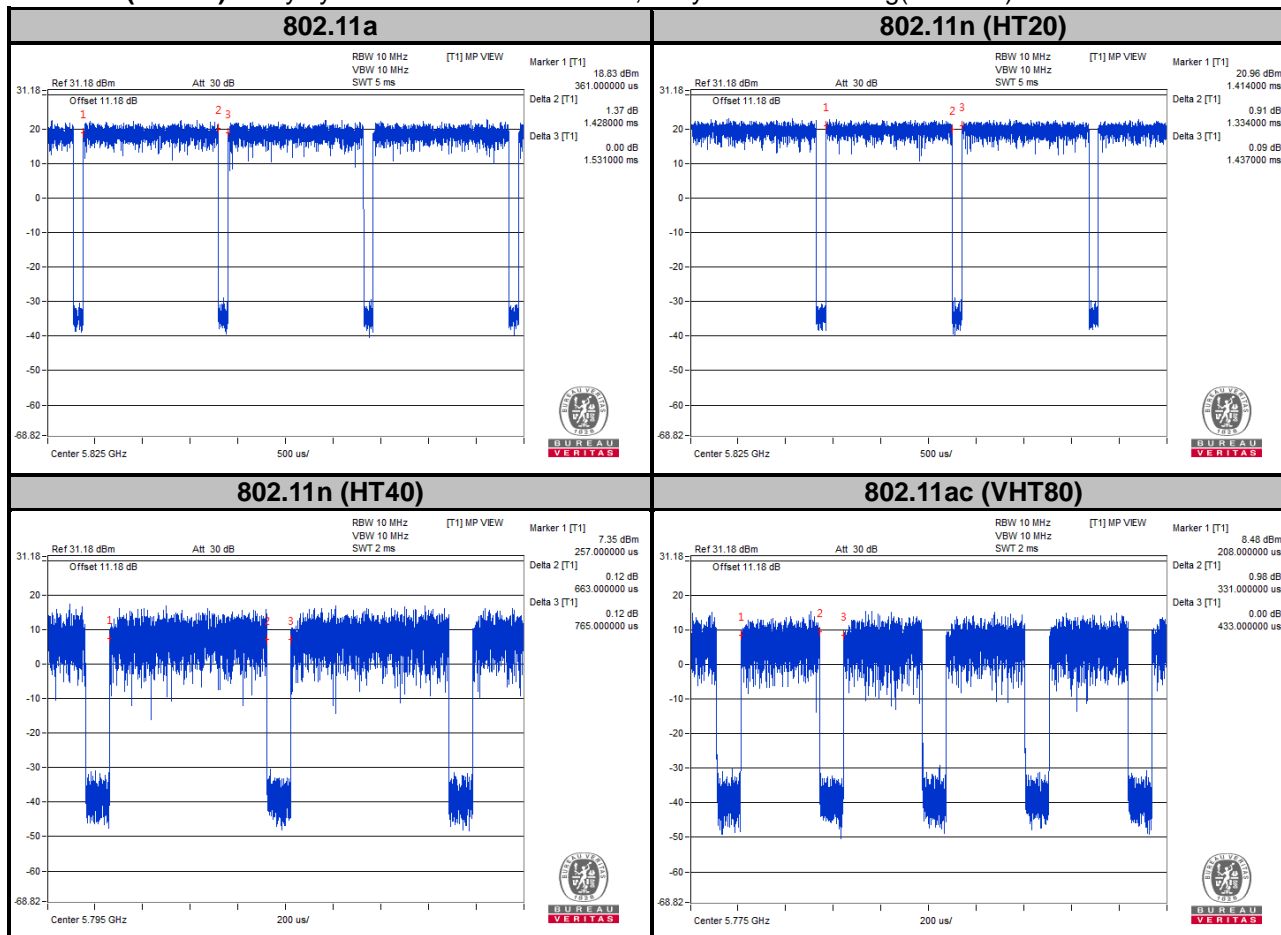

3.4 Description of Support Units

The EUT has been tested as an independent unit together with other necessary accessories or support units. The following support units or accessories were used to form a representative test configuration during the tests.

ID	Product	Brand	Model No.	Serial No.	FCC ID	Remarks
A	WWAN & GPS Antenna	TAOGLAS	MA240.LB1.001	NA	NA	Provided by client
B	AH Antenna	TAOGLAS	IS.05.B.301111	NA	NA	Provided by client
C	Adapter	TPT	PMW120300W8	NA	NA	Provided by client AC Input: 100-240V~, 50-60Hz, 1.1A MAX DC Output: 12V, 3.0A

Note:

1. All power cords of the above support units are non-shielded (1.8m).

ID	Descriptions	Qty.	Length (m)	Shielding (Yes/No)	Cores (Qty.)	Remarks
1.	RF Cable	3	3	N	0	-
2.	RF Cable	1	3	N	0	-

3.4.1 Configuration of System under Test

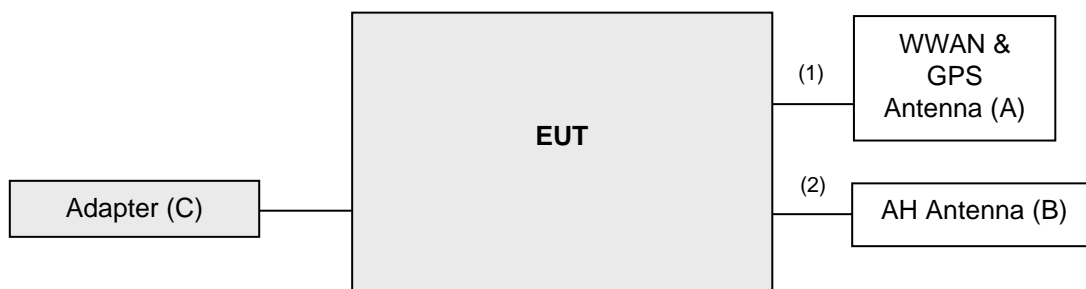

Remote site

3.5 General Description of Applied Standards and References

The EUT is a RF Product. According to the specifications of the manufacturer, it must comply with the requirements of the following standards and references:

Test Standard:

FCC Part 15, Subpart E (15.407)

ANSI C63.10-2013

All test items have been performed and recorded as per the above standards.

References Test Guidance:

KDB 789033 D02 General UNII Test Procedures New Rules v02r01

All test items have been performed as a reference to the above KDB test guidance.

4 Test Types and Results

4.1 Radiated Emission and Bandedge Measurement

4.1.1 Limits of Radiated Emission and Bandedge Measurement

Radiated emissions which fall in the restricted bands must comply with the radiated emission limits specified as below table.

Frequencies (MHz)	Field Strength (microvolts/meter)	Measurement Distance (meters)
0.009 ~ 0.490	2400/F (kHz)	300
0.490 ~ 1.705	24000/F (kHz)	30
1.705 ~ 30.0	30	30
30 ~ 88	100	3
88 ~ 216	150	3
216 ~ 960	200	3
Above 960	500	3

Note:

1. The lower limit shall apply at the transition frequencies.
2. Emission level (dBuV/m) = 20 log Emission level (uV/m).
3. For frequencies above 1000 MHz, the field strength limits are based on average detector, however, the peak field strength of any emission shall not exceed the maximum permitted average limits, specified above by more than 20 dB under any condition of modulation.

Limits of Unwanted Emission Out of the Restricted Bands

Applicable To		Limit	
789033 D02 General UNII Test Procedures New Rules v02r01		Field Strength at 3 m	
		PK: 74 (dBµV/m)	AV: 54 (dBµV/m)
Frequency Band	Applicable To	EIRP Limit	Equivalent Field Strength at 3 m
5150~5250 MHz	15.407(b)(1)	PK: -27 (dBm/MHz)	PK: 68.2 (dBµV/m)
5250~5350 MHz	15.407(b)(2)		
5470~5725 MHz	15.407(b)(3)		
5725~5850 MHz	<input checked="" type="checkbox"/> 15.407(b)(4)(i)	PK:-27 (dBm/MHz) ^{*1} PK:10 (dBm/MHz) ^{*2} PK:15.6 (dBm/MHz) ^{*3} PK:27 (dBm/MHz) ^{*4}	PK: 68.2 (dBµV/m) ^{*1} PK:105.2 (dBµV/m) ^{*2} PK: 110.8 (dBµV/m) ^{*3} PK:122.2 (dBµV/m) ^{*4}
	<input type="checkbox"/> 15.407(b)(4)(ii)	Emission limits in section 15.247(d)	

^{*1} beyond 75 MHz or more above of the band edge.

^{*2} below the band edge increasing linearly to 10 dBm/MHz at 25 MHz above.

^{*3} below the band edge increasing linearly to a level of 15.6 dBm/MHz at 5 MHz above.

^{*4} from 5 MHz above or below the band edge increasing linearly to a level of 27 dBm/MHz at the band edge.

Note:

The following formula is used to convert the equipment isotropic radiated power (eirp) to field strength:

$$E = \frac{1000000\sqrt{30P}}{3} \mu\text{V/m, where } P \text{ is the eirp (Watts).}$$

4.1.2 Test Instruments

Description & Manufacturer	Model No.	Serial No.	Date of Calibration	Due Date of Calibration
Test Receiver Agilent	N9038A	MY51210203	Mar. 18, 2020	Mar. 17, 2021
Spectrum Analyzer Agilent	N9010A	MY52220314	Dec. 12, 2019	Dec. 11, 2020
Spectrum Analyzer ROHDE & SCHWARZ	FSU43	101261	Apr. 16, 2020	Apr. 15, 2021
Broadband Horn Antenna SCHWARZBECK	BBHA 9170	148	Nov. 24, 2019	Nov. 23, 2020
HORN Antenna SCHWARZBECK	BBHA 9120D	9120D-969	Nov. 24, 2019	Nov. 23, 2020
BILOG Antenna SCHWARZBECK	VULB 9168	9168-472	Nov. 08, 2019	Nov. 07, 2020
Fixed Attenuator WOKEN	MDCS18N-10	MDCS18N-10-01	Apr. 14, 2020	Apr. 13, 2021
Loop Antenna	EM-6879	269	Sep. 16, 2019	Sep. 15, 2020
			Sep. 17, 2020	Sep. 16, 2021
Preamplifier EMCI	EMC001340	980201	Oct. 14, 2019	Oct. 13, 2020
			Oct. 21, 2020	Oct. 20, 2021
Preamplifier EMCI	EMC 012645	980115	Oct. 08, 2019	Oct. 07, 2020
			Oct. 07, 2020	Oct. 06, 2021
Preamplifier EMCI	EMC 184045	980116	Oct. 08, 2019	Oct. 07, 2020
			Oct. 07, 2020	Oct. 06, 2021
Preamplifier EMCI	EMC 330H	980112	Oct. 08, 2019	Oct. 07, 2020
			Oct. 07, 2020	Oct. 06, 2021
Power Meter Anritsu	ML2495A	1012010	Sep. 01, 2020	Aug. 31, 2021
Power Sensor Anritsu	MA2411B	1315050	Sep. 01, 2020	Aug. 31, 2021
RF Coaxial Cable EMCI	EMC104-SM-SM-8 000	180409	Jan. 18, 2020	Jan. 17, 2021
RF Coaxial Cable HUBER+SUHNNER	SUCOFLEX 104	EMC104-SM-SM-1 000(140807)	Oct. 08, 2019	Oct. 07, 2020
			Oct. 07, 2020	Oct. 06, 2021
RF Coaxial Cable WOKEN	8D-FB	Cable-Ch10-01	Oct. 08, 2019	Oct. 07, 2020
			Oct. 07, 2020	Oct. 06, 2021
Boresight Antenna Fixture	FBA-01	FBA-SIP01	NA	NA
Software BV ADT	E3 6.120103	NA	NA	NA
Antenna Tower MF	MFA-440H	NA	NA	NA
Turn Table MF	MFT-201SS	NA	NA	NA
Antenna Tower & Turn Table Controller MF	MF-7802	NA	NA	NA

Note: 1. The calibration interval of the above test instruments is 12 months and the calibrations are traceable to NML/ROC and NIST/USA.

2. The test was performed in HwaYa Chamber 10.

4.1.3 Test Procedures

For Radiated Emission below 30 MHz

- a. The EUT was placed on the top of a rotating table 0.8 meters above the ground at a 3 meter chamber room. The table was rotated 360 degrees to determine the position of the highest radiation.
- b. The EUT was set 3 meters away from the interference-receiving antenna, which was mounted on the top of a variable-height antenna tower.
- c. Parallel, perpendicular, and ground-parallel orientations of the antenna are set to make the measurement.
- d. For each suspected emission, the EUT was arranged to its worst case and the rotatable table was turned from 0 degrees to 360 degrees to find the maximum reading.
- e. The test-receiver system was set to Quasi-Peak Detect Function and Specified Bandwidth with Maximum Hold Mode.

Note:

1. The resolution bandwidth and video bandwidth of test receiver/spectrum analyzer is 9 kHz at frequency below 30 MHz.

For Radiated Emission above 30 MHz

- a. The EUT was placed on the top of a rotating table 0.8 meters (for 30 MHz ~ 1 GHz) / 1.5 meters (for above 1 GHz) above the ground at 3 meter chamber room for test. The table was rotated 360 degrees to determine the position of the highest radiation.
- b. The EUT was set 3 meters away from the interference-receiving antenna, which was mounted on the top of a variable-height antenna tower.
- c. The height of antenna is varied from one meter to four meters above the ground to determine the maximum value of the field strength. Both horizontal and vertical polarizations of the antenna are set to make the measurement.
- d. For each suspected emission, the EUT was arranged to its worst case and then the antenna was tuned to heights from 1 meter to 4 meters and the rotatable table was turned from 0 degrees to 360 degrees to find the maximum reading.
- e. The test-receiver system was set to quasi-peak detect function and specified bandwidth with maximum hold mode when the test frequency is below 1 GHz.
- f. The test-receiver system was set to peak and average detected function and specified bandwidth with maximum hold mode when the test frequency is above 1 GHz. If the peak reading value also meets average limit, measurement with the average detector is unnecessary.

Note:

1. The resolution bandwidth and video bandwidth of test receiver/spectrum analyzer is 120 kHz for Quasi-peak detection (QP) or Peak detection (PK) at frequency below 1 GHz.
2. The resolution bandwidth of test receiver/spectrum analyzer is 1 MHz and the video bandwidth is 3 MHz for Peak detection (PK) at frequency above 1 GHz.
3. The resolution bandwidth of test receiver/spectrum analyzer is 1 MHz and the video bandwidth is $\geq 1/T$ (Duty cycle < 98 %) or 10 Hz (Duty cycle ≥ 98 %) for Average detection (AV) at frequency above 1 GHz.
(11a: RBW = 1 MHz, VBW = 1 kHz ; 11n (HT20): RBW = 1 MHz, VBW = 1 kHz ;
11n (HT40): RBW = 1 MHz, VBW = 2 kHz ; 11ac (VHT80): RBW = 1 MHz, VBW = 5.1 kHz)
4. All modes of operation were investigated and the worst-case emissions are reported.

4.1.4 Deviation from Test Standard

No deviation.

4.1.5 Test Setup

<Radiated Emission below 30 MHz>

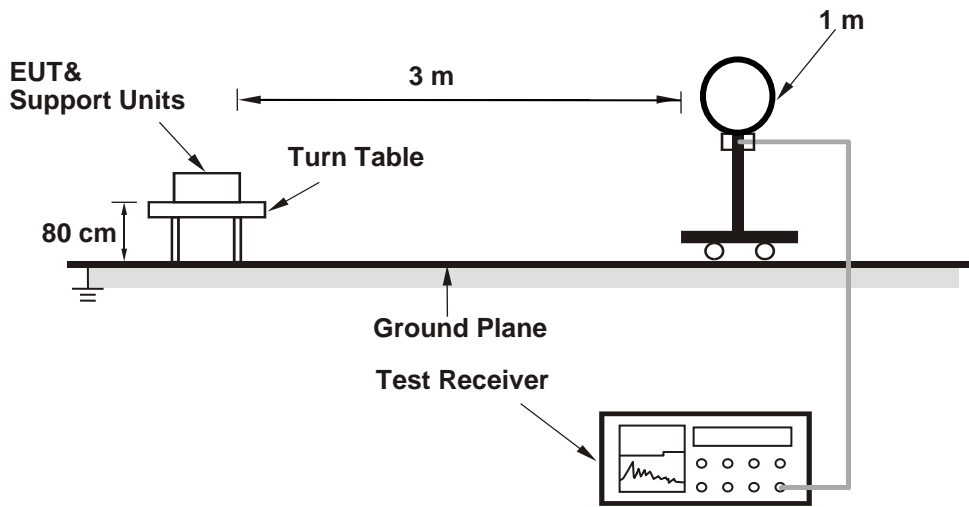

<Radiated Emission 30 MHz to 1 GHz>

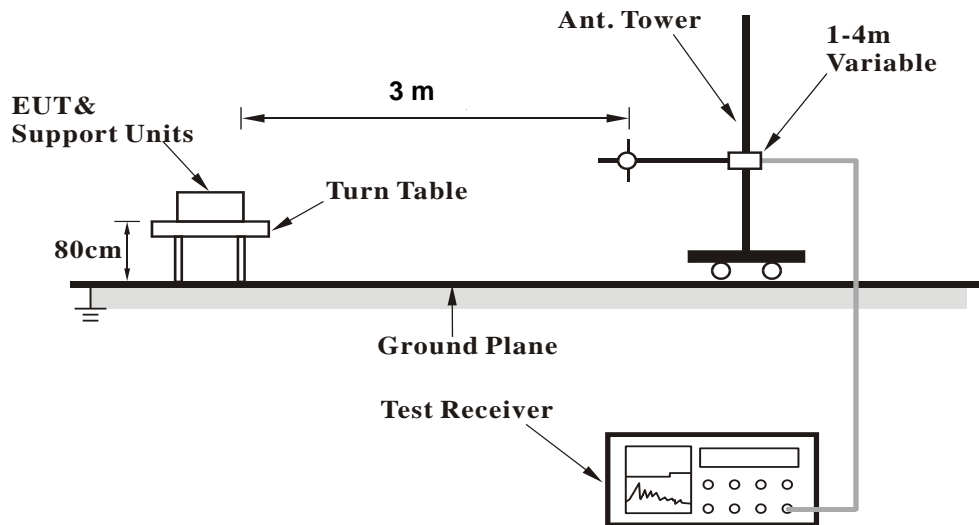

<Radiated Emission above 1 GHz>

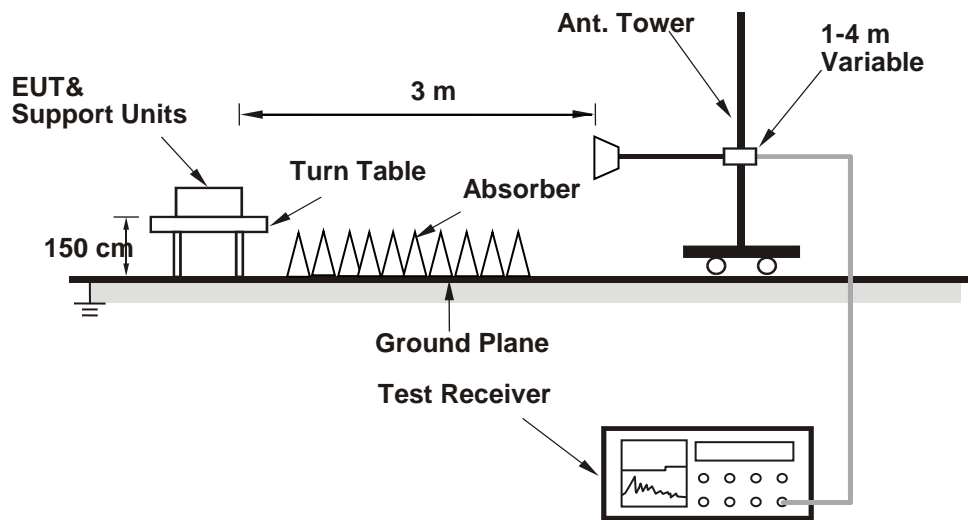

For the actual test configuration, please refer to the attached file (Test Setup Photo).

4.1.6 EUT Operating Conditions

- a. Placed the EUT on a testing table.
- b. Use the software to control the EUT under transmission condition continuously at specific channel frequency.

4.1.7 Test Results
 Above 1 GHz Data :
 802.11a

EUT Test Condition		Measurement Detail	
Channel	Channel 36	Frequency Range	1 GHz ~ 40 GHz
Input Power	120 Vac, 60 Hz	Detector Function	Peak (PK) Average (AV)
Environmental Conditions	25 deg. C, 65 % RH	Tested By	Tim Chen

Antenna Polarity & Test Distance: Horizontal at 3 m								
Frequency (MHz)	Emission Level (dBuV/m)	Read Level (dBuV)	Factor (dB/m)	Limit (dBuV/m)	Margin (dB)	Antenna Height (cm)	Table Angle (Degree)	Remark
5150	45.6	45.18	0.42	54	-8.4	105	94	Average
5150	56.38	55.96	0.42	74	-17.62	105	94	Peak
5180	97.2	96.94	0.26	-----	-----	105	94	Average
5180	106.01	105.75	0.26	-----	-----	105	94	Peak
10360	55.62	57.54	-1.92	68.2	-12.58	154	112	Peak

Antenna Polarity & Test Distance: Vertical at 3 m								
Frequency (MHz)	Emission Level (dBuV/m)	Read Level (dBuV)	Factor (dB/m)	Limit (dBuV/m)	Margin (dB)	Antenna Height (cm)	Table Angle (Degree)	Remark
5150	47.36	46.94	0.42	54	-6.64	133	260	Average
5150	57.71	57.29	0.42	74	-16.29	133	260	Peak
5180	99.5	99.24	0.26	-----	-----	133	260	Average
5180	106.58	106.32	0.26	-----	-----	133	260	Peak
10360	54.65	56.57	-1.92	68.2	-13.55	120	179	Peak

Remarks:

- Emission Level = Read Level + Factor
Margin value = Emission level – Limit value
- 5180 MHz: Fundamental Frequency
- *: Out of Restricted Band
- The emission levels of other frequencies were very low against the limit

EUT Test Condition		Measurement Detail	
Channel	Channel 40	Frequency Range	1 GHz ~ 40 GHz
Input Power	120 Vac, 60 Hz	Detector Function	Peak (PK) Average (AV)
Environmental Conditions	25 deg. C, 65 % RH	Tested By	Tim Chen

Antenna Polarity & Test Distance: Horizontal at 3 m								
Frequency (MHz)	Emission Level (dBuV/m)	Read Level (dBuV)	Factor (dB/m)	Limit (dBuV/m)	Margin (dB)	Antenna Height (cm)	Table Angle (Degree)	Remark
5150	45.39	44.97	0.42	54	-8.61	114	92	Average
5150	54.75	54.33	0.42	74	-19.25	114	92	Peak
5200	100.17	100.03	0.14	-----	-----	114	92	Average
5200	107.87	107.73	0.14	-----	-----	114	92	Peak
5350	40.31	39.98	0.33	54	-13.69	114	92	Average
5350	48.61	48.28	0.33	74	-25.39	114	92	Peak
10400	55.14	56.96	-1.82	68.2	-13.06	131	134	Peak
Antenna Polarity & Test Distance: Vertical at 3 m								
Frequency (MHz)	Emission Level (dBuV/m)	Read Level (dBuV)	Factor (dB/m)	Limit (dBuV/m)	Margin (dB)	Antenna Height (cm)	Table Angle (Degree)	Remark
5150	47.17	46.75	0.42	54	-6.83	125	252	Average
5150	54.66	54.24	0.42	74	-19.34	125	252	Peak
5200	101.86	101.72	0.14	-----	-----	125	252	Average
5200	109.05	108.91	0.14	-----	-----	125	252	Peak
5350	41.33	41	0.33	54	-12.67	125	252	Average
5350	50.31	49.98	0.33	74	-23.69	125	252	Peak
10400	54.73	56.55	-1.82	68.2	-13.47	177	284	Peak

Remarks:

- Emission Level = Read Level + Factor
Margin value = Emission level – Limit value
- 5200 MHz: Fundamental Frequency
- *: Out of Restricted Band
- The emission levels of other frequencies were very low against the limit

EUT Test Condition		Measurement Detail	
Channel	Channel 48	Frequency Range	1 GHz ~ 40 GHz
Input Power	120 Vac, 60 Hz	Detector Function	Peak (PK) Average (AV)
Environmental Conditions	25 deg. C, 65 % RH	Tested By	Tim Chen

Antenna Polarity & Test Distance: Horizontal at 3 m								
Frequency (MHz)	Emission Level (dBuV/m)	Read Level (dBuV)	Factor (dB/m)	Limit (dBuV/m)	Margin (dB)	Antenna Height (cm)	Table Angle (Degree)	Remark
5150	40.53	40.11	0.42	54	-13.47	120	95	Average
5150	49.47	49.05	0.42	74	-24.53	120	95	Peak
5240	100.02	99.92	0.1	-----	-----	120	95	Average
5240	106.78	106.68	0.1	-----	-----	120	95	Peak
5350	39.74	39.41	0.33	54	-14.26	120	95	Average
5350	50.77	50.44	0.33	74	-23.23	120	95	Peak
10480	56.44	57.92	-1.48	68.2	-11.76	159	187	Peak
Antenna Polarity & Test Distance: Vertical at 3 m								
Frequency (MHz)	Emission Level (dBuV/m)	Read Level (dBuV)	Factor (dB/m)	Limit (dBuV/m)	Margin (dB)	Antenna Height (cm)	Table Angle (Degree)	Remark
5150	41.74	41.32	0.42	54	-12.26	132	260	Average
5150	50.03	49.61	0.42	74	-23.97	132	260	Peak
5240	101.99	101.89	0.1	-----	-----	132	260	Average
5240	109.72	109.62	0.1	-----	-----	132	260	Peak
5350	41.58	41.25	0.33	54	-12.42	132	260	Average
5350	51.31	50.98	0.33	74	-22.69	132	260	Peak
10480	55.36	56.84	-1.48	68.2	-12.84	186	99	Peak

Remarks:

- Emission Level = Read Level + Factor
Margin value = Emission level – Limit value
- 5240 MHz: Fundamental Frequency
- *: Out of Restricted Band
- The emission levels of other frequencies were very low against the limit

EUT Test Condition		Measurement Detail	
Channel	Channel 52	Frequency Range	1 GHz ~ 40 GHz
Input Power	120 Vac, 60 Hz	Detector Function	Peak (PK) Average (AV)
Environmental Conditions	25 deg. C, 65 % RH	Tested By	Tim Chen

Antenna Polarity & Test Distance: Horizontal at 3 m								
Frequency (MHz)	Emission Level (dBuV/m)	Read Level (dBuV)	Factor (dB/m)	Limit (dBuV/m)	Margin (dB)	Antenna Height (cm)	Table Angle (Degree)	Remark
5150	40.49	40.07	0.42	54	-13.51	133	91	Average
5150	48.65	48.23	0.42	74	-25.35	133	91	Peak
5260	99.1	98.97	0.13	-----	-----	133	91	Average
5260	108.03	107.9	0.13	-----	-----	133	91	Peak
5350	40.61	40.28	0.33	54	-13.39	133	91	Average
5350	48.13	47.8	0.33	74	-25.87	133	91	Peak
10520	58.67	60.12	-1.45	68.2	-9.53	165	252	Peak
Antenna Polarity & Test Distance: Vertical at 3 m								
Frequency (MHz)	Emission Level (dBuV/m)	Read Level (dBuV)	Factor (dB/m)	Limit (dBuV/m)	Margin (dB)	Antenna Height (cm)	Table Angle (Degree)	Remark
5150	41.46	41.04	0.42	54	-12.54	258	266	Average
5150	49.02	48.6	0.42	74	-24.98	258	266	Peak
5260	101.96	101.83	0.13	-----	-----	258	266	Average
5260	108.95	108.82	0.13	-----	-----	258	266	Peak
5350	41.93	41.6	0.33	54	-12.07	258	266	Average
5350	50.61	50.28	0.33	74	-23.39	258	266	Peak
10520	58.61	60.06	-1.45	68.2	-9.59	196	100	Peak

Remarks:

- Emission Level = Read Level + Factor
Margin value = Emission level – Limit value
- 5260 MHz: Fundamental Frequency
- *: Out of Restricted Band
- The emission levels of other frequencies were very low against the limit

EUT Test Condition		Measurement Detail	
Channel	Channel 60	Frequency Range	1 GHz ~ 40 GHz
Input Power	120 Vac, 60 Hz	Detector Function	Peak (PK) Average (AV)
Environmental Conditions	25 deg. C, 65 % RH	Tested By	Tim Chen

Antenna Polarity & Test Distance: Horizontal at 3 m								
Frequency (MHz)	Emission Level (dBuV/m)	Read Level (dBuV)	Factor (dB/m)	Limit (dBuV/m)	Margin (dB)	Antenna Height (cm)	Table Angle (Degree)	Remark
5150	40.79	40.37	0.42	54	-13.21	107	92	Average
5150	49.43	49.01	0.42	74	-24.57	107	92	Peak
5300	99.18	98.97	0.21	-----	-----	107	92	Average
5300	106.09	105.88	0.21	-----	-----	107	92	Peak
5350	42.97	42.64	0.33	54	-11.03	107	92	Average
5350	51.89	51.56	0.33	74	-22.11	107	92	Peak
10600	47.59	49.2	-1.61	54	-6.41	152	177	Average
10600	57.19	58.8	-1.61	74	-16.81	152	177	Peak

Antenna Polarity & Test Distance: Vertical at 3 m								
Frequency (MHz)	Emission Level (dBuV/m)	Read Level (dBuV)	Factor (dB/m)	Limit (dBuV/m)	Margin (dB)	Antenna Height (cm)	Table Angle (Degree)	Remark
5150	42.24	41.82	0.42	54	-11.76	250	263	Average
5150	50.39	49.97	0.42	74	-23.61	250	263	Peak
5300	101.81	101.6	0.21	-----	-----	250	263	Average
5300	109.25	109.04	0.21	-----	-----	250	263	Peak
5350	46.05	45.72	0.33	54	-7.95	250	263	Average
5350	54.87	54.54	0.33	74	-19.13	250	263	Peak
10600	48.36	49.97	-1.61	54	-5.64	135	262	Average
10600	57.37	58.98	-1.61	74	-16.63	135	262	Peak

Remarks:

- Emission Level = Read Level + Factor
Margin value = Emission level – Limit value
- 5300 MHz: Fundamental Frequency
- *: Out of Restricted Band
- The emission levels of other frequencies were very low against the limit

EUT Test Condition		Measurement Detail	
Channel	Channel 64	Frequency Range	1 GHz ~ 40 GHz
Input Power	120 Vac, 60 Hz	Detector Function	Peak (PK) Average (AV)
Environmental Conditions	25 deg. C, 65 % RH	Tested By	Tim Chen

Antenna Polarity & Test Distance: Horizontal at 3 m								
Frequency (MHz)	Emission Level (dBuV/m)	Read Level (dBuV)	Factor (dB/m)	Limit (dBuV/m)	Margin (dB)	Antenna Height (cm)	Table Angle (Degree)	Remark
5320	96.76	96.5	0.26	-----	-----	126	96	Average
5320	104.83	104.57	0.26	-----	-----	126	96	Peak
5350	46.99	46.66	0.33	54	-7.01	126	96	Average
5350	58.85	58.52	0.33	74	-15.15	126	96	Peak
10640	49.4	51.02	-1.62	54	-4.6	111	121	Average
10640	58.42	60.04	-1.62	74	-15.58	111	121	Peak
Antenna Polarity & Test Distance: Vertical at 3 m								
Frequency (MHz)	Emission Level (dBuV/m)	Read Level (dBuV)	Factor (dB/m)	Limit (dBuV/m)	Margin (dB)	Antenna Height (cm)	Table Angle (Degree)	Remark
5320	99.97	99.71	0.26	-----	-----	249	263	Average
5320	107.83	107.57	0.26	-----	-----	249	263	Peak
5350	50.31	49.98	0.33	54	-3.69	249	263	Average
5350	62.7	62.37	0.33	74	-11.3	249	263	Peak
10640	47.55	49.17	-1.62	54	-6.45	174	216	Average
10640	57.18	58.8	-1.62	74	-16.82	174	216	Peak

Remarks:

- Emission Level = Read Level + Factor
Margin value = Emission level – Limit value
- 5320 MHz: Fundamental Frequency
- *: Out of Restricted Band
- The emission levels of other frequencies were very low against the limit

EUT Test Condition		Measurement Detail	
Channel	Channel 100	Frequency Range	1 GHz ~ 40 GHz
Input Power	120 Vac, 60 Hz	Detector Function	Peak (PK) Average (AV)
Environmental Conditions	25 deg. C, 65 % RH	Tested By	Tim Chen

Antenna Polarity & Test Distance: Horizontal at 3 m								
Frequency (MHz)	Emission Level (dBuV/m)	Read Level (dBuV)	Factor (dB/m)	Limit (dBuV/m)	Margin (dB)	Antenna Height (cm)	Table Angle (Degree)	Remark
5460	44.28	43.53	0.75	54	-9.72	102	94	Average
5460	54.58	53.83	0.75	74	-19.42	102	94	Peak
5470	58.21	57.44	0.77	68.2	-9.99	102	94	Peak
5500	96.08	95.19	0.89	-----	-----	102	93	Average
5500	104.21	103.32	0.89	-----	-----	102	93	Peak
5725	45.43	44.56	0.87	68.2	-22.77	102	94	Peak
11000	48.23	49.54	-1.31	54	-5.77	156	159	Average
11000	57.48	58.79	-1.31	74	-16.52	156	159	Peak
Antenna Polarity & Test Distance: Vertical at 3 m								
Frequency (MHz)	Emission Level (dBuV/m)	Read Level (dBuV)	Factor (dB/m)	Limit (dBuV/m)	Margin (dB)	Antenna Height (cm)	Table Angle (Degree)	Remark
5460	47.28	46.53	0.75	54	-6.72	257	251	Average
5460	57.14	56.39	0.75	74	-16.86	257	251	Peak
5470	62.74	61.97	0.77	68.2	-5.46	257	251	Peak
5500	100.61	99.72	0.89	-----	-----	257	251	Average
5500	108.83	107.94	0.89	-----	-----	257	251	Peak
5725	49.04	48.17	0.87	68.2	-19.16	257	251	Peak
11000	47.89	49.2	-1.31	54	-6.11	178	138	Average
11000	57.47	58.78	-1.31	74	-16.53	178	138	Peak

Remarks:

- Emission Level = Read Level + Factor
Margin value = Emission level – Limit value
- 5500 MHz: Fundamental Frequency
- *: Out of Restricted Band
- The emission levels of other frequencies were very low against the limit

EUT Test Condition		Measurement Detail	
Channel	Channel 116	Frequency Range	1 GHz ~ 40 GHz
Input Power	120 Vac, 60 Hz	Detector Function	Peak (PK) Average (AV)
Environmental Conditions	25 deg. C, 65 % RH	Tested By	Tim Chen

Antenna Polarity & Test Distance: Horizontal at 3 m								
Frequency (MHz)	Emission Level (dBuV/m)	Read Level (dBuV)	Factor (dB/m)	Limit (dBuV/m)	Margin (dB)	Antenna Height (cm)	Table Angle (Degree)	Remark
5460	40.3	39.55	0.75	54	-13.7	128	96	Average
5460	48.77	48.02	0.75	74	-25.23	128	96	Peak
5470	48.62	47.85	0.77	68.2	-19.58	128	96	Peak
5580	97.93	97.13	0.8	-----	-----	128	96	Average
5580	105.25	104.45	0.8	-----	-----	128	96	Peak
5725	47.65	46.78	0.87	68.2	-20.55	128	96	Peak
11160	46.67	48.2	-1.53	54	-7.33	156	284	Average
11160	56.27	57.8	-1.53	74	-17.73	156	284	Peak

Antenna Polarity & Test Distance: Vertical at 3 m								
Frequency (MHz)	Emission Level (dBuV/m)	Read Level (dBuV)	Factor (dB/m)	Limit (dBuV/m)	Margin (dB)	Antenna Height (cm)	Table Angle (Degree)	Remark
5460	41.48	40.73	0.75	54	-12.52	246	254	Average
5460	49.9	49.15	0.75	74	-24.1	246	254	Peak
5470	48.5	47.73	0.77	68.2	-19.7	246	254	Peak
5580	102.01	101.21	0.8	-----	-----	246	254	Average
5580	109.58	108.78	0.8	-----	-----	246	254	Peak
5725	48.04	47.17	0.87	68.2	-20.16	246	254	Peak
11160	47.33	48.86	-1.53	54	-6.67	189	211	Average
11160	56	57.53	-1.53	74	-18	189	211	Peak

Remarks:

- Emission Level = Read Level + Factor
Margin value = Emission level – Limit value
- 5580 MHz: Fundamental Frequency
- *: Out of Restricted Band
- The emission levels of other frequencies were very low against the limit

EUT Test Condition		Measurement Detail	
Channel	Channel 140	Frequency Range	1 GHz ~ 40 GHz
Input Power	120 Vac, 60 Hz	Detector Function	Peak (PK) Average (AV)
Environmental Conditions	25 deg. C, 65 % RH	Tested By	Tim Chen

Antenna Polarity & Test Distance: Horizontal at 3 m								
Frequency (MHz)	Emission Level (dBuV/m)	Read Level (dBuV)	Factor (dB/m)	Limit (dBuV/m)	Margin (dB)	Antenna Height (cm)	Table Angle (Degree)	Remark
5460	39.57	38.82	0.75	54	-14.43	136	96	Average
5460	48.75	48	0.75	74	-25.25	136	96	Peak
5470	48.03	47.26	0.77	68.2	-20.17	136	96	Peak
5700	96.14	95.29	0.85	-----	-----	136	96	Average
5700	103.94	103.09	0.85	-----	-----	136	96	Peak
5725	54.99	54.12	0.87	68.2	-13.21	136	96	Peak
11400	48.5	49.85	-1.35	54	-5.5	138	107	Average
11400	56.78	58.13	-1.35	74	-17.22	138	107	Peak

Antenna Polarity & Test Distance: Vertical at 3 m								
Frequency (MHz)	Emission Level (dBuV/m)	Read Level (dBuV)	Factor (dB/m)	Limit (dBuV/m)	Margin (dB)	Antenna Height (cm)	Table Angle (Degree)	Remark
5460	39.8	39.05	0.75	54	-14.2	256	249	Average
5460	48.69	47.94	0.75	74	-25.31	256	249	Peak
5470	46.82	46.05	0.77	68.2	-21.38	256	249	Peak
5700	100.6	99.75	0.85	-----	-----	256	249	Average
5700	109.06	108.21	0.85	-----	-----	256	249	Peak
5725	64.28	63.41	0.87	68.2	-3.92	256	249	Peak
11400	48.84	50.19	-1.35	54	-5.16	191	133	Average
11400	57.65	59	-1.35	74	-16.35	191	133	Peak

Remarks:

- Emission Level = Read Level + Factor
Margin value = Emission level – Limit value
- 5700 MHz: Fundamental Frequency
- *: Out of Restricted Band
- The emission levels of other frequencies were very low against the limit

EUT Test Condition		Measurement Detail	
Channel	Channel 149	Frequency Range	1 GHz ~ 40 GHz
Input Power	120 Vac, 60 Hz	Detector Function	Peak (PK) Average (AV)
Environmental Conditions	25 deg. C, 65 % RH	Tested By	Tim Chen

<Spurious Emission>

Antenna Polarity & Test Distance: Horizontal at 3 m								
Frequency (MHz)	Emission Level (dBuV/m)	Read Level (dBuV)	Factor (dB/m)	Limit (dBuV/m)	Margin (dB)	Antenna Height (cm)	Table Angle (Degree)	Remark
5745	98.96	98.08	0.88	-----	-----	129	94	Average
5745	106.31	105.43	0.88	-----	-----	129	94	Peak
11490	48.56	49.88	-1.32	54	-5.44	181	203	Average
11490	56.9	58.22	-1.32	74	-17.1	181	203	Peak
Antenna Polarity & Test Distance: Vertical at 3 m								
Frequency (MHz)	Emission Level (dBuV/m)	Read Level (dBuV)	Factor (dB/m)	Limit (dBuV/m)	Margin (dB)	Antenna Height (cm)	Table Angle (Degree)	Remark
5745	102.6	101.72	0.88	-----	-----	260	249	Average
5745	110.3	109.42	0.88	-----	-----	260	249	Peak
11490	47.88	49.2	-1.32	54	-6.12	145	213	Average
11490	55.71	57.03	-1.32	74	-18.29	145	213	Peak

<Out of Band Emission (OOBE)>

Antenna Polarity & Test Distance: Horizontal at 3 m								
Frequency (MHz)	Emission Level (dBuV/m)	Read Level (dBuV)	Factor (dB/m)	Limit (dBuV/m)	Margin (dB)	Antenna Height (cm)	Table Angle (Degree)	Remark
5597.5	51.43	50.64	0.79	68.2	-16.77	129	94	Peak
5658.775	49.6	48.94	0.66	74.72	-25.12	129	94	Peak
5922.4	49.67	48.37	1.3	70.12	-20.45	129	94	Peak
6022.625	50.94	49.49	1.45	68.2	-17.26	129	94	Peak
Antenna Polarity & Test Distance: Vertical at 3 m								
Frequency (MHz)	Emission Level (dBuV/m)	Read Level (dBuV)	Factor (dB/m)	Limit (dBuV/m)	Margin (dB)	Antenna Height (cm)	Table Angle (Degree)	Remark
5597.025	52.64	51.85	0.79	68.2	-15.56	260	249	Peak
5654.975	51.53	50.89	0.64	71.9	-20.37	260	249	Peak
5922.875	49.66	48.36	1.3	69.77	-20.11	260	249	Peak
5965.15	50.55	49.21	1.34	68.2	-17.65	260	249	Peak

Remarks:

- Emission Level = Read Level + Factor
Margin value = Emission level – Limit value
- 5745 MHz: Fundamental Frequency
- *: Out of Restricted Band
- The emission levels of other frequencies were very low against the limit

EUT Test Condition		Measurement Detail	
Channel	Channel 157	Frequency Range	1 GHz ~ 40 GHz
Input Power	120 Vac, 60 Hz	Detector Function	Peak (PK) Average (AV)
Environmental Conditions	25 deg. C, 65 % RH	Tested By	Tim Chen

<Spurious Emission>

Antenna Polarity & Test Distance: Horizontal at 3 m								
Frequency (MHz)	Emission Level (dBuV/m)	Read Level (dBuV)	Factor (dB/m)	Limit (dBuV/m)	Margin (dB)	Antenna Height (cm)	Table Angle (Degree)	Remark
5785	97.36	96.44	0.92	-----	-----	140	91	Average
5785	106.69	105.77	0.92	-----	-----	140	91	Peak
11570	46.64	48.35	-1.71	54	-7.36	143	143	Average
11570	55.87	57.58	-1.71	74	-18.13	143	143	Peak

Antenna Polarity & Test Distance: Vertical at 3 m								
Frequency (MHz)	Emission Level (dBuV/m)	Read Level (dBuV)	Factor (dB/m)	Limit (dBuV/m)	Margin (dB)	Antenna Height (cm)	Table Angle (Degree)	Remark
5785	103.1	102.18	0.92	-----	-----	255	246	Average
5785	110.77	109.85	0.92	-----	-----	255	246	Peak
11570	47.5	49.21	-1.71	54	-6.5	183	170	Average
11570	56.52	58.23	-1.71	74	-17.48	183	170	Peak

<Out of Band Emission (OOBE)>

Antenna Polarity & Test Distance: Horizontal at 3 m								
Frequency (MHz)	Emission Level (dBuV/m)	Read Level (dBuV)	Factor (dB/m)	Limit (dBuV/m)	Margin (dB)	Antenna Height (cm)	Table Angle (Degree)	Remark
5629.325	51.07	50.39	0.68	68.2	-17.13	140	91	Peak
5660.2	48.28	47.61	0.67	75.77	-27.49	140	91	Peak
5922.4	49.94	48.64	1.3	70.12	-20.18	140	91	Peak
5937.6	51.38	50.06	1.32	68.2	-16.82	140	91	Peak

Antenna Polarity & Test Distance: Vertical at 3 m								
Frequency (MHz)	Emission Level (dBuV/m)	Read Level (dBuV)	Factor (dB/m)	Limit (dBuV/m)	Margin (dB)	Antenna Height (cm)	Table Angle (Degree)	Remark
5641.2	51.73	51.05	0.68	68.2	-16.47	255	246	Peak
5651.65	49.95	49.26	0.69	69.43	-19.48	255	246	Peak
5917.175	51.14	49.84	1.3	73.97	-22.83	255	246	Peak
5937.6	53.45	52.13	1.32	68.2	-14.75	255	246	Peak

Remarks:

- Emission Level = Read Level + Factor
Margin value = Emission level – Limit value
- 5785 MHz: Fundamental Frequency
- *: Out of Restricted Band
- The emission levels of other frequencies were very low against the limit

EUT Test Condition		Measurement Detail	
Channel	Channel 165	Frequency Range	1 GHz ~ 40 GHz
Input Power	120 Vac, 60 Hz	Detector Function	Peak (PK) Average (AV)
Environmental Conditions	25 deg. C, 65 % RH	Tested By	Tim Chen

<Spurious Emission>

Antenna Polarity & Test Distance: Horizontal at 3 m								
Frequency (MHz)	Emission Level (dBuV/m)	Read Level (dBuV)	Factor (dB/m)	Limit (dBuV/m)	Margin (dB)	Antenna Height (cm)	Table Angle (Degree)	Remark
5825	97.34	96.28	1.06	-----	-----	147	96	Average
5825	105.54	104.48	1.06	-----	-----	147	96	Peak
11650	45.12	47.18	-2.06	54	-8.88	148	130	Average
11650	54.65	56.71	-2.06	74	-19.35	148	130	Peak

Antenna Polarity & Test Distance: Vertical at 3 m								
Frequency (MHz)	Emission Level (dBuV/m)	Read Level (dBuV)	Factor (dB/m)	Limit (dBuV/m)	Margin (dB)	Antenna Height (cm)	Table Angle (Degree)	Remark
5825	102.84	101.78	1.06	-----	-----	264	246	Average
5825	110.53	109.47	1.06	-----	-----	264	246	Peak
11650	47.08	49.14	-2.06	54	-6.92	191	127	Average
11650	56.14	58.2	-2.06	74	-17.86	191	127	Peak

<Out of Band Emission (OOBE)>

Antenna Polarity & Test Distance: Horizontal at 3 m								
Frequency (MHz)	Emission Level (dBuV/m)	Read Level (dBuV)	Factor (dB/m)	Limit (dBuV/m)	Margin (dB)	Antenna Height (cm)	Table Angle (Degree)	Remark
5604.625	49.63	48.9	0.73	68.2	-18.57	147	96	Peak
5655.45	48.48	47.83	0.65	72.25	-23.77	147	96	Peak
5916.7	49.16	47.86	1.3	74.32	-25.16	147	96	Peak
5974.175	51.47	50.13	1.34	68.2	-16.73	147	96	Peak

Antenna Polarity & Test Distance: Vertical at 3 m								
Frequency (MHz)	Emission Level (dBuV/m)	Read Level (dBuV)	Factor (dB/m)	Limit (dBuV/m)	Margin (dB)	Antenna Height (cm)	Table Angle (Degree)	Remark
5601.775	49.99	49.2	0.79	68.2	-18.21	264	246	Peak
5659.725	50.09	49.42	0.67	75.42	-25.33	264	246	Peak
5916.225	51.12	49.82	1.3	74.67	-23.55	264	246	Peak
5978.45	53.13	51.78	1.35	68.2	-15.07	264	246	Peak

Remarks:

- Emission Level = Read Level + Factor
Margin value = Emission level – Limit value
- 5825 MHz: Fundamental Frequency
- *: Out of Restricted Band
- The emission levels of other frequencies were very low against the limit

802.11n (HT20)

EUT Test Condition		Measurement Detail	
Channel	Channel 36	Frequency Range	1 GHz ~ 40 GHz
Input Power	120 Vac, 60 Hz	Detector Function	Peak (PK) Average (AV)
Environmental Conditions	25 deg. C, 65 % RH	Tested By	Tim Chen

Antenna Polarity & Test Distance: Horizontal at 3 m

Frequency (MHz)	Emission Level (dBuV/m)	Read Level (dBuV)	Factor (dB/m)	Limit (dBuV/m)	Margin (dB)	Antenna Height (cm)	Table Angle (Degree)	Remark
5150	49.11	48.69	0.42	54	-4.89	103	93	Average
5150	61.15	60.73	0.42	74	-12.85	103	93	Peak
5180	97.79	97.53	0.26	-----	-----	103	93	Average
5180	105.99	105.73	0.26	-----	-----	103	93	Peak
10360	54.87	56.79	-1.92	68.2	-13.33	192	144	Peak

Antenna Polarity & Test Distance: Vertical at 3 m

Frequency (MHz)	Emission Level (dBuV/m)	Read Level (dBuV)	Factor (dB/m)	Limit (dBuV/m)	Margin (dB)	Antenna Height (cm)	Table Angle (Degree)	Remark
5150	50.36	49.94	0.42	54	-3.64	138	251	Average
5150	65.09	64.67	0.42	74	-8.91	138	251	Peak
5180	99.92	99.66	0.26	-----	-----	138	251	Average
5180	107.32	107.06	0.26	-----	-----	138	251	Peak
10360	54.74	56.66	-1.92	68.2	-13.46	141	183	Peak

Remarks:

- Emission Level = Read Level + Factor
Margin value = Emission level – Limit value
- 5180 MHz: Fundamental Frequency
- *: Out of Restricted Band
- The emission levels of other frequencies were very low against the limit

EUT Test Condition		Measurement Detail	
Channel	Channel 40	Frequency Range	1 GHz ~ 40 GHz
Input Power	120 Vac, 60 Hz	Detector Function	Peak (PK) Average (AV)
Environmental Conditions	25 deg. C, 65 % RH	Tested By	Tim Chen

Antenna Polarity & Test Distance: Horizontal at 3 m								
Frequency (MHz)	Emission Level (dBuV/m)	Read Level (dBuV)	Factor (dB/m)	Limit (dBuV/m)	Margin (dB)	Antenna Height (cm)	Table Angle (Degree)	Remark
5150	44.9	44.48	0.42	54	-9.1	110	92	Average
5150	52.83	52.41	0.42	74	-21.17	110	92	Peak
5200	99.82	99.68	0.14	-----	-----	110	92	Average
5200	107.74	107.6	0.14	-----	-----	110	92	Peak
5350	40.41	40.08	0.33	54	-13.59	110	92	Average
5350	49.51	49.18	0.33	74	-24.49	110	92	Peak
10400	54.39	56.21	-1.82	68.2	-13.81	181	158	Peak
Antenna Polarity & Test Distance: Vertical at 3 m								
Frequency (MHz)	Emission Level (dBuV/m)	Read Level (dBuV)	Factor (dB/m)	Limit (dBuV/m)	Margin (dB)	Antenna Height (cm)	Table Angle (Degree)	Remark
5150	47.19	46.77	0.42	54	-6.81	119	260	Average
5150	58.73	58.31	0.42	74	-15.27	119	260	Peak
5200	101.45	101.31	0.14	-----	-----	119	260	Average
5200	108.55	108.41	0.14	-----	-----	119	260	Peak
5350	41.05	40.72	0.33	54	-12.95	119	260	Average
5350	49.36	49.03	0.33	74	-24.64	119	260	Peak
10400	54.25	56.07	-1.82	68.2	-13.95	136	242	Peak

Remarks:

- Emission Level = Read Level + Factor
Margin value = Emission level – Limit value
- 5200 MHz: Fundamental Frequency
- *: Out of Restricted Band
- The emission levels of other frequencies were very low against the limit

EUT Test Condition		Measurement Detail	
Channel	Channel 48	Frequency Range	1 GHz ~ 40 GHz
Input Power	120 Vac, 60 Hz	Detector Function	Peak (PK) Average (AV)
Environmental Conditions	25 deg. C, 65 % RH	Tested By	Tim Chen

Antenna Polarity & Test Distance: Horizontal at 3 m								
Frequency (MHz)	Emission Level (dBuV/m)	Read Level (dBuV)	Factor (dB/m)	Limit (dBuV/m)	Margin (dB)	Antenna Height (cm)	Table Angle (Degree)	Remark
5150	40.6	40.18	0.42	54	-13.4	102	93	Average
5150	49.43	49.01	0.42	74	-24.57	102	93	Peak
5240	99.72	99.62	0.1	-----	-----	102	93	Average
5240	107.86	107.76	0.1	-----	-----	102	93	Peak
5350	40.51	40.18	0.33	54	-13.49	102	93	Average
5350	49.22	48.89	0.33	74	-24.78	102	93	Peak
10400	55.08	56.9	-1.82	68.2	-13.12	160	176	Peak
Antenna Polarity & Test Distance: Vertical at 3 m								
Frequency (MHz)	Emission Level (dBuV/m)	Read Level (dBuV)	Factor (dB/m)	Limit (dBuV/m)	Margin (dB)	Antenna Height (cm)	Table Angle (Degree)	Remark
5150	41.45	41.03	0.42	54	-12.55	133	261	Average
5150	50.22	49.8	0.42	74	-23.78	133	261	Peak
5240	101.84	101.74	0.1	-----	-----	133	261	Average
5240	109.61	109.51	0.1	-----	-----	133	261	Peak
5350	41.12	40.79	0.33	54	-12.88	133	261	Average
5350	50.34	50.01	0.33	74	-23.66	133	261	Peak
10400	55.43	57.25	-1.82	68.2	-12.77	137	78	Peak

Remarks:

- Emission Level = Read Level + Factor
Margin value = Emission level – Limit value
- 5240 MHz: Fundamental Frequency
- *: Out of Restricted Band
- The emission levels of other frequencies were very low against the limit

EUT Test Condition		Measurement Detail	
Channel	Channel 52	Frequency Range	1 GHz ~ 40 GHz
Input Power	120 Vac, 60 Hz	Detector Function	Peak (PK) Average (AV)
Environmental Conditions	25 deg. C, 65 % RH	Tested By	Tim Chen

Antenna Polarity & Test Distance: Horizontal at 3 m								
Frequency (MHz)	Emission Level (dBuV/m)	Read Level (dBuV)	Factor (dB/m)	Limit (dBuV/m)	Margin (dB)	Antenna Height (cm)	Table Angle (Degree)	Remark
5108.64	40.53	39.95	0.58	54	-13.47	114	97	Average
5108.64	50.27	49.69	0.58	74	-23.73	114	97	Peak
5150	39.86	39.44	0.42	54	-14.14	114	97	Average
5150	47.32	46.9	0.42	74	-26.68	114	97	Peak
5260	98.65	98.52	0.13	-----	-----	114	97	Average
5260	106.34	106.21	0.13	-----	-----	114	97	Peak
5350	39.2	38.87	0.33	54	-14.8	114	97	Average
5350	46.57	46.24	0.33	74	-27.43	114	97	Peak
5409.12	40.4	39.9	0.5	54	-13.6	114	97	Average
5409.12	48.91	48.41	0.5	74	-25.09	114	97	Peak
10520	57.69	59.14	-1.45	68.2	-10.51	152	163	Peak
Antenna Polarity & Test Distance: Vertical at 3 m								
Frequency (MHz)	Emission Level (dBuV/m)	Read Level (dBuV)	Factor (dB/m)	Limit (dBuV/m)	Margin (dB)	Antenna Height (cm)	Table Angle (Degree)	Remark
5112.48	41.1	40.53	0.57	54	-12.9	234	264	Average
5112.48	50.14	49.57	0.57	74	-23.86	234	264	Peak
5150	40.39	39.97	0.42	54	-13.61	234	264	Average
5150	47.75	47.33	0.42	74	-26.25	234	264	Peak
5260	101.52	101.39	0.13	-----	-----	234	264	Average
5260	108.78	108.65	0.13	-----	-----	234	264	Peak
5350	40.26	39.93	0.33	54	-13.74	234	264	Average
5350	47.75	47.42	0.33	74	-26.25	234	264	Peak
5408.16	41.82	41.32	0.5	54	-12.18	234	264	Average
5408.16	50.5	50	0.5	74	-23.5	234	264	Peak
10520	57.8	59.25	-1.45	68.2	-10.4	199	197	Peak

Remarks:

- Emission Level = Read Level + Factor
Margin value = Emission level – Limit value
- 5260 MHz: Fundamental Frequency
- *: Out of Restricted Band
- The emission levels of other frequencies were very low against the limit

EUT Test Condition		Measurement Detail	
Channel	Channel 60	Frequency Range	1 GHz ~ 40 GHz
Input Power	120 Vac, 60 Hz	Detector Function	Peak (PK) Average (AV)
Environmental Conditions	25 deg. C, 65 % RH	Tested By	Tim Chen

Antenna Polarity & Test Distance: Horizontal at 3 m								
Frequency (MHz)	Emission Level (dBuV/m)	Read Level (dBuV)	Factor (dB/m)	Limit (dBuV/m)	Margin (dB)	Antenna Height (cm)	Table Angle (Degree)	Remark
5150	40.76	40.34	0.42	54	-13.24	133	96	Average
5150	48.98	48.56	0.42	74	-25.02	133	96	Peak
5300	98.96	98.75	0.21	-----	-----	133	96	Average
5300	106.53	106.32	0.21	-----	-----	133	96	Peak
5350	42.89	42.56	0.33	54	-11.11	133	96	Average
5350	53.29	52.96	0.33	74	-20.71	133	96	Peak
10600	48.55	50.16	-1.61	54	-5.45	185	234	Average
10600	57.73	59.34	-1.61	74	-16.27	185	234	Peak
Antenna Polarity & Test Distance: Vertical at 3 m								
Frequency (MHz)	Emission Level (dBuV/m)	Read Level (dBuV)	Factor (dB/m)	Limit (dBuV/m)	Margin (dB)	Antenna Height (cm)	Table Angle (Degree)	Remark
5150	41.63	41.21	0.42	54	-12.37	251	264	Average
5150	49.9	49.48	0.42	74	-24.1	251	264	Peak
5300	101.71	101.5	0.21	-----	-----	251	264	Average
5300	109.5	109.29	0.21	-----	-----	251	264	Peak
5350	45.55	45.22	0.33	54	-8.45	251	264	Average
5350	56.25	55.92	0.33	74	-17.75	251	264	Peak
10600	47.74	49.35	-1.61	54	-6.26	165	132	Average
10600	56.97	58.58	-1.61	74	-17.03	165	132	Peak

Remarks:

- Emission Level = Read Level + Factor
Margin value = Emission level – Limit value
- 5300 MHz: Fundamental Frequency
- *: Out of Restricted Band
- The emission levels of other frequencies were very low against the limit

EUT Test Condition		Measurement Detail	
Channel	Channel 64	Frequency Range	1 GHz ~ 40 GHz
Input Power	120 Vac, 60 Hz	Detector Function	Peak (PK) Average (AV)
Environmental Conditions	25 deg. C, 65 % RH	Tested By	Tim Chen

Antenna Polarity & Test Distance: Horizontal at 3 m								
Frequency (MHz)	Emission Level (dBuV/m)	Read Level (dBuV)	Factor (dB/m)	Limit (dBuV/m)	Margin (dB)	Antenna Height (cm)	Table Angle (Degree)	Remark
5320	95.35	95.09	0.26	-----	-----	127	94	Average
5320	102.98	102.72	0.26	-----	-----	127	94	Peak
5350	44.4	44.07	0.33	54	-9.6	127	94	Average
5350	55.77	55.44	0.33	74	-18.23	127	94	Peak
10640	48.51	50.13	-1.62	54	-5.49	167	192	Average
10640	57.69	59.31	-1.62	74	-16.31	167	192	Peak
Antenna Polarity & Test Distance: Vertical at 3 m								
Frequency (MHz)	Emission Level (dBuV/m)	Read Level (dBuV)	Factor (dB/m)	Limit (dBuV/m)	Margin (dB)	Antenna Height (cm)	Table Angle (Degree)	Remark
5320	98.62	98.36	0.26	-----	-----	249	263	Average
5320	106.28	106.02	0.26	-----	-----	249	263	Peak
5350	47.07	46.74	0.33	54	-6.93	249	263	Average
5350	58.17	57.84	0.33	74	-15.83	249	263	Peak
10640	48.9	50.52	-1.62	54	-5.1	129	125	Average
10640	57.7	59.32	-1.62	74	-16.3	129	125	Peak

Remarks:

- Emission Level = Read Level + Factor
Margin value = Emission level – Limit value
- 5320 MHz: Fundamental Frequency
- *: Out of Restricted Band
- The emission levels of other frequencies were very low against the limit

EUT Test Condition		Measurement Detail	
Channel	Channel 100	Frequency Range	1 GHz ~ 40 GHz
Input Power	120 Vac, 60 Hz	Detector Function	Peak (PK) Average (AV)
Environmental Conditions	25 deg. C, 65 % RH	Tested By	Tim Chen

Antenna Polarity & Test Distance: Horizontal at 3 m								
Frequency (MHz)	Emission Level (dBuV/m)	Read Level (dBuV)	Factor (dB/m)	Limit (dBuV/m)	Margin (dB)	Antenna Height (cm)	Table Angle (Degree)	Remark
5460	43.5	42.75	0.75	54	-10.5	132	95	Average
5460	55.51	54.76	0.75	74	-18.49	132	95	Peak
5470	57.6	56.83	0.77	68.2	-10.6	132	95	Peak
5500	95.67	94.78	0.89	-----	-----	132	95	Average
5500	103.1	102.21	0.89	-----	-----	132	95	Peak
5725	47.05	46.18	0.87	68.2	-21.15	132	95	Peak
11000	48.24	49.55	-1.31	54	-5.76	173	183	Average
11000	57.33	58.64	-1.31	74	-16.67	173	183	Peak
Antenna Polarity & Test Distance: Vertical at 3 m								
Frequency (MHz)	Emission Level (dBuV/m)	Read Level (dBuV)	Factor (dB/m)	Limit (dBuV/m)	Margin (dB)	Antenna Height (cm)	Table Angle (Degree)	Remark
5460	45.8	45.05	0.75	54	-8.2	255	252	Average
5460	54.28	53.53	0.75	74	-19.72	255	252	Peak
5470	61.73	60.96	0.77	68.2	-6.47	255	252	Peak
5500	100.04	99.15	0.89	-----	-----	255	252	Average
5500	107.52	106.63	0.89	-----	-----	255	252	Peak
5725	47.81	46.94	0.87	68.2	-20.39	255	252	Peak
11000	49.15	50.46	-1.31	54	-4.85	132	152	Average
11000	58.33	59.64	-1.31	74	-15.67	132	152	Peak

Remarks:

- Emission Level = Read Level + Factor
Margin value = Emission level – Limit value
- 5500 MHz: Fundamental Frequency
- *: Out of Restricted Band
- The emission levels of other frequencies were very low against the limit

EUT Test Condition		Measurement Detail	
Channel	Channel 116	Frequency Range	1 GHz ~ 40 GHz
Input Power	120 Vac, 60 Hz	Detector Function	Peak (PK) Average (AV)
Environmental Conditions	25 deg. C, 65 % RH	Tested By	Tim Chen

Antenna Polarity & Test Distance: Horizontal at 3 m								
Frequency (MHz)	Emission Level (dBuV/m)	Read Level (dBuV)	Factor (dB/m)	Limit (dBuV/m)	Margin (dB)	Antenna Height (cm)	Table Angle (Degree)	Remark
5431	40.47	39.85	0.62	54	-13.53	126	92	Average
5431	47.36	46.74	0.62	74	-26.64	126	92	Peak
5460	39.84	39.09	0.75	54	-14.16	126	92	Average
5460	50.34	49.59	0.75	74	-23.66	126	92	Peak
5470	50.34	49.57	0.77	68.2	-17.86	126	92	Peak
5580	98.11	97.31	0.8	-----	-----	126	92	Average
5580	104.92	104.12	0.8	-----	-----	126	92	Peak
5725	47.02	46.15	0.87	68.2	-21.18	126	92	Peak
11160	46.66	48.19	-1.53	54	-7.34	123	262	Average
11160	55.3	56.83	-1.53	74	-18.7	123	262	Peak

Antenna Polarity & Test Distance: Vertical at 3 m								
Frequency (MHz)	Emission Level (dBuV/m)	Read Level (dBuV)	Factor (dB/m)	Limit (dBuV/m)	Margin (dB)	Antenna Height (cm)	Table Angle (Degree)	Remark
5431	41.36	40.74	0.62	54	-12.64	248	252	Average
5431	47.48	46.86	0.62	74	-26.52	248	252	Peak
5460	40.36	39.61	0.75	54	-13.64	248	252	Average
5460	50.72	49.97	0.75	74	-23.28	248	252	Peak
5470	48.63	47.86	0.77	68.2	-19.57	248	252	Peak
5580	101.83	101.03	0.8	-----	-----	248	252	Average
5580	109.41	108.61	0.8	-----	-----	248	252	Peak
5725	49.44	48.57	0.87	68.2	-18.76	248	252	Peak
11160	47.59	49.12	-1.53	54	-6.41	169	191	Average
11160	56.41	57.94	-1.53	74	-17.59	169	191	Peak

Remarks:

- Emission Level = Read Level + Factor
Margin value = Emission level – Limit value
- 5580 MHz: Fundamental Frequency
- *: Out of Restricted Band
- The emission levels of other frequencies were very low against the limit

EUT Test Condition		Measurement Detail	
Channel	Channel 140	Frequency Range	1 GHz ~ 40 GHz
Input Power	120 Vac, 60 Hz	Detector Function	Peak (PK) Average (AV)
Environmental Conditions	25 deg. C, 65 % RH	Tested By	Tim Chen

Antenna Polarity & Test Distance: Horizontal at 3 m								
Frequency (MHz)	Emission Level (dBuV/m)	Read Level (dBuV)	Factor (dB/m)	Limit (dBuV/m)	Margin (dB)	Antenna Height (cm)	Table Angle (Degree)	Remark
5460	39.53	38.78	0.75	54	-14.47	138	95	Average
5460	49.09	48.34	0.75	74	-24.91	138	95	Peak
5470	47.77	47	0.77	68.2	-20.43	138	95	Peak
5700	95.76	94.91	0.85	-----	-----	138	95	Average
5700	102.69	101.84	0.85	-----	-----	138	95	Peak
5725	61.68	60.81	0.87	68.2	-6.52	138	95	Peak
11400	46.91	48.26	-1.35	54	-7.09	198	88	Average
11400	55.91	57.26	-1.35	74	-18.09	198	88	Peak

Antenna Polarity & Test Distance: Vertical at 3 m								
Frequency (MHz)	Emission Level (dBuV/m)	Read Level (dBuV)	Factor (dB/m)	Limit (dBuV/m)	Margin (dB)	Antenna Height (cm)	Table Angle (Degree)	Remark
5460	39.63	38.88	0.75	54	-14.37	260	251	Average
5460	49.12	48.37	0.75	74	-24.88	260	251	Peak
5470	47.89	47.12	0.77	68.2	-20.31	260	251	Peak
5700	100.28	99.43	0.85	-----	-----	260	251	Average
5700	107.2	106.35	0.85	-----	-----	260	251	Peak
5725	66.8	65.93	0.87	68.2	-1.4	260	251	Peak
11400	48.21	49.56	-1.35	54	-5.79	124	245	Average
11400	57.28	58.63	-1.35	74	-16.72	124	245	Peak

Remarks:

- Emission Level = Read Level + Factor
Margin value = Emission level – Limit value
- 5700 MHz: Fundamental Frequency
- *: Out of Restricted Band
- The emission levels of other frequencies were very low against the limit

EUT Test Condition		Measurement Detail	
Channel	Channel 149	Frequency Range	1 GHz ~ 40 GHz
Input Power	120 Vac, 60 Hz	Detector Function	Peak (PK) Average (AV)
Environmental Conditions	25 deg. C, 65 % RH	Tested By	Tim Chen

<Spurious Emission>

Antenna Polarity & Test Distance: Horizontal at 3 m								
Frequency (MHz)	Emission Level (dBuV/m)	Read Level (dBuV)	Factor (dB/m)	Limit (dBuV/m)	Margin (dB)	Antenna Height (cm)	Table Angle (Degree)	Remark
5745	99.1	98.22	0.88	-----	-----	120	95	Average
5745	106.62	105.74	0.88	-----	-----	120	95	Peak
11490	48.53	49.85	-1.32	54	-5.47	128	151	Average
11490	57.66	58.98	-1.32	74	-16.34	128	151	Peak
Antenna Polarity & Test Distance: Vertical at 3 m								
Frequency (MHz)	Emission Level (dBuV/m)	Read Level (dBuV)	Factor (dB/m)	Limit (dBuV/m)	Margin (dB)	Antenna Height (cm)	Table Angle (Degree)	Remark
5745	102.91	102.03	0.88	-----	-----	259	246	Average
5745	110.83	109.95	0.88	-----	-----	259	246	Peak
11490	47.63	48.95	-1.32	54	-6.37	108	74	Average
11490	56.1	57.42	-1.32	74	-17.9	108	74	Peak

<Out of Band Emission (OOBE)>

Antenna Polarity & Test Distance: Horizontal at 3 m								
Frequency (MHz)	Emission Level (dBuV/m)	Read Level (dBuV)	Factor (dB/m)	Limit (dBuV/m)	Margin (dB)	Antenna Height (cm)	Table Angle (Degree)	Remark
5593.7	50.81	50.02	0.79	68.2	-17.39	120	95	Peak
5655.925	49.68	49.03	0.65	72.6	-22.92	120	95	Peak
5918.125	49.27	47.97	1.3	73.27	-24	120	95	Peak
5971.325	50.98	49.64	1.34	68.2	-17.22	120	95	Peak
Antenna Polarity & Test Distance: Vertical at 3 m								
Frequency (MHz)	Emission Level (dBuV/m)	Read Level (dBuV)	Factor (dB/m)	Limit (dBuV/m)	Margin (dB)	Antenna Height (cm)	Table Angle (Degree)	Remark
5592.75	52.35	51.56	0.79	68.2	-15.85	259	246	Peak
5650.7	52.26	51.58	0.68	68.72	-16.46	259	246	Peak
5919.55	51.08	49.78	1.3	72.22	-21.14	259	246	Peak
5971.8	52.07	50.73	1.34	68.2	-16.13	259	246	Peak

Remarks:

- Emission Level = Read Level + Factor
Margin value = Emission level – Limit value
- 5745 MHz: Fundamental Frequency
- *: Out of Restricted Band
- The emission levels of other frequencies were very low against the limit

EUT Test Condition		Measurement Detail	
Channel	Channel 157	Frequency Range	1 GHz ~ 40 GHz
Input Power	120 Vac, 60 Hz	Detector Function	Peak (PK) Average (AV)
Environmental Conditions	25 deg. C, 65 % RH	Tested By	Tim Chen

<Spurious Emission>

Antenna Polarity & Test Distance: Horizontal at 3 m								
Frequency (MHz)	Emission Level (dBuV/m)	Read Level (dBuV)	Factor (dB/m)	Limit (dBuV/m)	Margin (dB)	Antenna Height (cm)	Table Angle (Degree)	Remark
5785	98.22	97.3	0.92	-----	-----	130	93	Average
5785	105.37	104.45	0.92	-----	-----	130	93	Peak
11570	46.86	48.57	-1.71	54	-7.14	146	191	Average
11570	55.64	57.35	-1.71	74	-18.36	146	191	Peak

Antenna Polarity & Test Distance: Vertical at 3 m								
Frequency (MHz)	Emission Level (dBuV/m)	Read Level (dBuV)	Factor (dB/m)	Limit (dBuV/m)	Margin (dB)	Antenna Height (cm)	Table Angle (Degree)	Remark
5785	102.73	101.81	0.92	-----	-----	256	246	Average
5785	110.14	109.22	0.92	-----	-----	256	246	Peak
11570	47.61	49.32	-1.71	54	-6.39	190	221	Average
11570	56.43	58.14	-1.71	74	-17.57	190	221	Peak

<Out of Band Emission (OOBE)>

Antenna Polarity & Test Distance: Horizontal at 3 m								
Frequency (MHz)	Emission Level (dBuV/m)	Read Level (dBuV)	Factor (dB/m)	Limit (dBuV/m)	Margin (dB)	Antenna Height (cm)	Table Angle (Degree)	Remark
5638.825	51.06	50.39	0.67	68.2	-17.14	130	93	Peak
5653.075	48.8	48.1	0.7	70.49	-21.69	130	93	Peak
5923.825	50.26	48.96	1.3	69.07	-18.81	130	93	Peak
5939.025	50.98	49.66	1.32	68.2	-17.22	130	93	Peak

Antenna Polarity & Test Distance: Vertical at 3 m								
Frequency (MHz)	Emission Level (dBuV/m)	Read Level (dBuV)	Factor (dB/m)	Limit (dBuV/m)	Margin (dB)	Antenna Height (cm)	Table Angle (Degree)	Remark
5631.225	52.08	51.4	0.68	68.2	-16.12	256	246	Peak
5653.55	49.8	49.1	0.7	70.84	-21.04	256	246	Peak
5917.175	50.04	48.74	1.3	73.97	-23.93	256	246	Peak
5935.7	54.34	53.04	1.3	68.2	-13.86	256	246	Peak

Remarks:

- Emission Level = Read Level + Factor
Margin value = Emission level – Limit value
- 5785 MHz: Fundamental Frequency
- *: Out of Restricted Band
- The emission levels of other frequencies were very low against the limit

EUT Test Condition		Measurement Detail	
Channel	Channel 165	Frequency Range	1 GHz ~ 40 GHz
Input Power	120 Vac, 60 Hz	Detector Function	Peak (PK) Average (AV)
Environmental Conditions	25 deg. C, 65 % RH	Tested By	Tim Chen

<Spurious Emission>

Antenna Polarity & Test Distance: Horizontal at 3 m								
Frequency (MHz)	Emission Level (dBuV/m)	Read Level (dBuV)	Factor (dB/m)	Limit (dBuV/m)	Margin (dB)	Antenna Height (cm)	Table Angle (Degree)	Remark
5825	98.04	96.98	1.06	-----	-----	117	94	Average
5825	105.18	104.12	1.06	-----	-----	117	94	Peak
11650	46.08	48.14	-2.06	54	-7.92	133	279	Average
11650	55.35	57.41	-2.06	74	-18.65	133	279	Peak
Antenna Polarity & Test Distance: Vertical at 3 m								
Frequency (MHz)	Emission Level (dBuV/m)	Read Level (dBuV)	Factor (dB/m)	Limit (dBuV/m)	Margin (dB)	Antenna Height (cm)	Table Angle (Degree)	Remark
5825	102.85	101.79	1.06	-----	-----	254	248	Average
5825	110.27	109.21	1.06	-----	-----	254	248	Peak
11650	45.42	47.48	-2.06	54	-8.58	179	177	Average
11650	54.18	56.24	-2.06	74	-19.82	179	177	Peak

<Out of Band Emission (OOBE)>

Antenna Polarity & Test Distance: Horizontal at 3 m								
Frequency (MHz)	Emission Level (dBuV/m)	Read Level (dBuV)	Factor (dB/m)	Limit (dBuV/m)	Margin (dB)	Antenna Height (cm)	Table Angle (Degree)	Remark
5585.15	49.16	48.36	0.8	68.2	-19.04	117	94	Peak
5658.775	49.01	48.35	0.66	74.72	-25.71	117	94	Peak
5917.175	49.74	48.44	1.3	73.97	-24.23	117	94	Peak
5976.075	51.18	49.83	1.35	68.2	-17.02	117	94	Peak
Antenna Polarity & Test Distance: Vertical at 3 m								
Frequency (MHz)	Emission Level (dBuV/m)	Read Level (dBuV)	Factor (dB/m)	Limit (dBuV/m)	Margin (dB)	Antenna Height (cm)	Table Angle (Degree)	Remark
5615.55	50.15	49.42	0.73	68.2	-18.05	254	248	Peak
5659.725	49.08	48.41	0.67	75.42	-26.34	254	248	Peak
5915.275	50.79	49.49	1.3	75.37	-24.58	254	248	Peak
5974.175	53.19	51.85	1.34	68.2	-15.01	254	248	Peak

Remarks:

- Emission Level = Read Level + Factor
Margin value = Emission level – Limit value
- 5825 MHz: Fundamental Frequency
- *: Out of Restricted Band
- The emission levels of other frequencies were very low against the limit

802.11n (HT40)

EUT Test Condition		Measurement Detail	
Channel	Channel 38	Frequency Range	1 GHz ~ 40 GHz
Input Power	120 Vac, 60 Hz	Detector Function	Peak (PK) Average (AV)
Environmental Conditions	25 deg. C, 65 % RH	Tested By	Tim Chen

Antenna Polarity & Test Distance: Horizontal at 3 m

Frequency (MHz)	Emission Level (dBuV/m)	Read Level (dBuV)	Factor (dB/m)	Limit (dBuV/m)	Margin (dB)	Antenna Height (cm)	Table Angle (Degree)	Remark
5150	48.85	48.43	0.42	54	-5.15	109	92	Average
5150	57.52	57.1	0.42	74	-16.48	109	92	Peak
5190	88.85	88.65	0.2	-----	-----	109	92	Average
5190	99.32	99.12	0.2	-----	-----	109	92	Peak
5350	39.35	39.02	0.33	54	-14.65	109	92	Average
5350	47.57	47.24	0.33	74	-26.43	109	92	Peak
10380	56.49	58.35	-1.86	68.2	-11.71	148	156	Peak

Antenna Polarity & Test Distance: Vertical at 3 m

Frequency (MHz)	Emission Level (dBuV/m)	Read Level (dBuV)	Factor (dB/m)	Limit (dBuV/m)	Margin (dB)	Antenna Height (cm)	Table Angle (Degree)	Remark
5150	53.29	52.87	0.42	54	-0.71	234	261	Average
5150	61.42	61	0.42	74	-12.58	234	261	Peak
5190	97.05	96.85	0.2	-----	-----	234	261	Average
5190	104.98	104.78	0.2	-----	-----	234	261	Peak
5350	40.37	40.04	0.33	54	-13.63	234	261	Average
5350	45.97	45.64	0.33	74	-28.03	234	261	Peak
10380	56.7	58.56	-1.86	68.2	-11.5	189	153	Peak

Remarks:

- Emission Level = Read Level + Factor
Margin value = Emission level – Limit value
- 5190 MHz: Fundamental Frequency
- *: Out of Restricted Band
- The emission levels of other frequencies were very low against the limit

EUT Test Condition		Measurement Detail	
Channel	Channel 46	Frequency Range	1 GHz ~ 40 GHz
Input Power	120 Vac, 60 Hz	Detector Function	Peak (PK) Average (AV)
Environmental Conditions	25 deg. C, 65 % RH	Tested By	Tim Chen

Antenna Polarity & Test Distance: Horizontal at 3 m								
Frequency (MHz)	Emission Level (dBuV/m)	Read Level (dBuV)	Factor (dB/m)	Limit (dBuV/m)	Margin (dB)	Antenna Height (cm)	Table Angle (Degree)	Remark
5150	41.77	41.35	0.42	54	-12.23	108	93	Average
5150	49.25	48.83	0.42	74	-24.75	108	93	Peak
5230	93.47	93.35	0.12	-----	-----	108	93	Average
5230	101.89	101.77	0.12	-----	-----	108	93	Peak
5350	39.62	39.29	0.33	54	-14.38	108	93	Average
5350	45.54	45.21	0.33	74	-28.46	108	93	Peak
10460	57.61	59.2	-1.59	68.2	-10.59	128	171	Peak

Antenna Polarity & Test Distance: Vertical at 3 m								
Frequency (MHz)	Emission Level (dBuV/m)	Read Level (dBuV)	Factor (dB/m)	Limit (dBuV/m)	Margin (dB)	Antenna Height (cm)	Table Angle (Degree)	Remark
5150	43.42	43	0.42	54	-10.58	246	262	Average
5150	54.16	53.74	0.42	74	-19.84	246	262	Peak
5230	96.5	96.38	0.12	-----	-----	246	262	Average
5230	104.65	104.53	0.12	-----	-----	246	262	Peak
5350	41.08	40.75	0.33	54	-12.92	246	262	Average
5350	48.45	48.12	0.33	74	-25.55	246	262	Peak
10460	56.36	57.95	-1.59	68.2	-11.84	168	262	Peak

Remarks:

- Emission Level = Read Level + Factor
Margin value = Emission level – Limit value
- 5230 MHz: Fundamental Frequency
- *: Out of Restricted Band
- The emission levels of other frequencies were very low against the limit

EUT Test Condition		Measurement Detail	
Channel	Channel 54	Frequency Range	1 GHz ~ 40 GHz
Input Power	120 Vac, 60 Hz	Detector Function	Peak (PK) Average (AV)
Environmental Conditions	25 deg. C, 65 % RH	Tested By	Tim Chen

Antenna Polarity & Test Distance: Horizontal at 3 m								
Frequency (MHz)	Emission Level (dBuV/m)	Read Level (dBuV)	Factor (dB/m)	Limit (dBuV/m)	Margin (dB)	Antenna Height (cm)	Table Angle (Degree)	Remark
5150	40.12	39.7	0.42	54	-13.88	119	92	Average
5150	46.76	46.34	0.42	74	-27.24	119	92	Peak
5270	92.4	92.27	0.13	-----	-----	119	92	Average
5270	99.42	99.29	0.13	-----	-----	119	92	Peak
5350	40.55	40.22	0.33	54	-13.45	119	92	Average
5350	48.46	48.13	0.33	74	-25.54	119	92	Peak
10540	57.3	58.79	-1.49	68.2	-10.9	152	133	Peak
Antenna Polarity & Test Distance: Vertical at 3 m								
Frequency (MHz)	Emission Level (dBuV/m)	Read Level (dBuV)	Factor (dB/m)	Limit (dBuV/m)	Margin (dB)	Antenna Height (cm)	Table Angle (Degree)	Remark
5150	41.23	40.81	0.42	54	-12.77	225	258	Average
5150	47.28	46.86	0.42	74	-26.72	225	258	Peak
5270	96.43	96.3	0.13	-----	-----	225	258	Average
5270	103.84	103.71	0.13	-----	-----	225	258	Peak
5350	42.77	42.44	0.33	54	-11.23	225	258	Average
5350	49.89	49.56	0.33	74	-24.11	225	258	Peak
10540	57.23	58.72	-1.49	68.2	-10.97	103	167	Peak

Remarks:

- Emission Level = Read Level + Factor
Margin value = Emission level – Limit value
- 5270 MHz: Fundamental Frequency
- *: Out of Restricted Band
- The emission levels of other frequencies were very low against the limit

EUT Test Condition		Measurement Detail	
Channel	Channel 62	Frequency Range	1 GHz ~ 40 GHz
Input Power	120 Vac, 60 Hz	Detector Function	Peak (PK) Average (AV)
Environmental Conditions	25 deg. C, 65 % RH	Tested By	Tim Chen

Antenna Polarity & Test Distance: Horizontal at 3 m								
Frequency (MHz)	Emission Level (dBuV/m)	Read Level (dBuV)	Factor (dB/m)	Limit (dBuV/m)	Margin (dB)	Antenna Height (cm)	Table Angle (Degree)	Remark
5150	40.29	39.87	0.42	54	-13.71	117	97	Average
5150	46.5	46.08	0.42	74	-27.5	117	97	Peak
5310	92.23	92	0.23	-----	-----	117	97	Average
5310	100.32	100.09	0.23	-----	-----	117	97	Peak
5350	44.54	44.21	0.33	54	-9.46	117	97	Average
5350	57.71	57.38	0.33	74	-16.29	117	97	Peak
10620	49.21	50.83	-1.62	54	-4.79	111	132	Average
10620	57.27	58.89	-1.62	74	-16.73	111	132	Peak

Antenna Polarity & Test Distance: Vertical at 3 m								
Frequency (MHz)	Emission Level (dBuV/m)	Read Level (dBuV)	Factor (dB/m)	Limit (dBuV/m)	Margin (dB)	Antenna Height (cm)	Table Angle (Degree)	Remark
5150	39.81	39.39	0.42	54	-14.19	290	271	Average
5150	46.17	45.75	0.42	74	-27.83	290	271	Peak
5310	94.85	94.62	0.23	-----	-----	290	271	Average
5310	102.26	102.03	0.23	-----	-----	290	271	Peak
5350	48.89	48.56	0.33	54	-5.11	290	271	Average
5350	59.9	59.57	0.33	74	-14.1	290	271	Peak
10620	48.85	50.47	-1.62	54	-5.15	168	152	Average
10620	56.87	58.49	-1.62	74	-17.13	168	152	Peak

Remarks:

- Emission Level = Read Level + Factor
Margin value = Emission level – Limit value
- 5310 MHz: Fundamental Frequency
- *: Out of Restricted Band
- The emission levels of other frequencies were very low against the limit

EUT Test Condition		Measurement Detail	
Channel	Channel 102	Frequency Range	1 GHz ~ 40 GHz
Input Power	120 Vac, 60 Hz	Detector Function	Peak (PK) Average (AV)
Environmental Conditions	25 deg. C, 65 % RH	Tested By	Tim Chen

Antenna Polarity & Test Distance: Horizontal at 3 m								
Frequency (MHz)	Emission Level (dBuV/m)	Read Level (dBuV)	Factor (dB/m)	Limit (dBuV/m)	Margin (dB)	Antenna Height (cm)	Table Angle (Degree)	Remark
5460	45.73	44.98	0.75	54	-8.27	129	95	Average
5460	56.04	55.29	0.75	74	-17.96	129	95	Peak
5470	59.98	59.21	0.77	68.2	-8.22	129	95	Peak
5510	91.24	90.37	0.87	-----	-----	129	95	Average
5510	100.04	99.17	0.87	-----	-----	129	95	Peak
5725	47.41	46.54	0.87	68.2	-20.79	129	95	Peak
11020	46.31	47.64	-1.33	54	-7.69	141	161	Average
11020	55.58	56.91	-1.33	74	-18.42	141	161	Peak

Antenna Polarity & Test Distance: Vertical at 3 m								
Frequency (MHz)	Emission Level (dBuV/m)	Read Level (dBuV)	Factor (dB/m)	Limit (dBuV/m)	Margin (dB)	Antenna Height (cm)	Table Angle (Degree)	Remark
5460	48.59	47.84	0.75	54	-5.41	258	258	Average
5460	63.3	62.55	0.75	74	-10.7	258	258	Peak
5470	64.45	63.68	0.77	68.2	-3.75	258	258	Peak
5510	94.86	93.99	0.87	-----	-----	258	258	Average
5510	103.41	102.54	0.87	-----	-----	258	258	Peak
5725	46.87	46	0.87	68.2	-21.33	258	258	Peak
11020	46.83	48.16	-1.33	54	-7.17	171	189	Average
11020	56.29	57.62	-1.33	74	-17.71	171	189	Peak

Remarks:

- Emission Level = Read Level + Factor
Margin value = Emission level – Limit value
- 5510 MHz: Fundamental Frequency
- *: Out of Restricted Band
- The emission levels of other frequencies were very low against the limit

EUT Test Condition		Measurement Detail	
Channel	Channel 110	Frequency Range	1 GHz ~ 40 GHz
Input Power	120 Vac, 60 Hz	Detector Function	Peak (PK) Average (AV)
Environmental Conditions	25 deg. C, 65 % RH	Tested By	Tim Chen

Antenna Polarity & Test Distance: Horizontal at 3 m								
Frequency (MHz)	Emission Level (dBuV/m)	Read Level (dBuV)	Factor (dB/m)	Limit (dBuV/m)	Margin (dB)	Antenna Height (cm)	Table Angle (Degree)	Remark
5460	40.67	39.92	0.75	54	-13.33	110	92	Average
5460	51.78	51.03	0.75	74	-22.22	110	92	Peak
5470	50.05	49.28	0.77	68.2	-18.15	110	92	Peak
5550	92.15	91.28	0.87	-----	-----	110	92	Average
5550	100.24	99.37	0.87	-----	-----	110	92	Peak
5725	48.49	47.62	0.87	68.2	-19.71	110	92	Peak
11100	46.78	48.17	-1.39	54	-7.22	148	133	Average
11100	55.81	57.2	-1.39	74	-18.19	148	133	Peak

Antenna Polarity & Test Distance: Vertical at 3 m								
Frequency (MHz)	Emission Level (dBuV/m)	Read Level (dBuV)	Factor (dB/m)	Limit (dBuV/m)	Margin (dB)	Antenna Height (cm)	Table Angle (Degree)	Remark
5460	41.82	41.07	0.75	54	-12.18	251	243	Average
5460	50.62	49.87	0.75	74	-23.38	251	243	Peak
5470	51	50.23	0.77	68.2	-17.2	251	243	Peak
5550	96.03	95.16	0.87	-----	-----	252	243	Average
5550	103.88	103.01	0.87	-----	-----	252	243	Peak
5725	47.85	46.98	0.87	68.2	-20.35	251	243	Peak
11100	47.22	48.61	-1.39	54	-6.78	158	131	Average
11100	56.07	57.46	-1.39	74	-17.93	158	131	Peak

Remarks:

- Emission Level = Read Level + Factor
Margin value = Emission level – Limit value
- 5550 MHz: Fundamental Frequency
- *: Out of Restricted Band
- The emission levels of other frequencies were very low against the limit

EUT Test Condition		Measurement Detail	
Channel	Channel 134	Frequency Range	1 GHz ~ 40 GHz
Input Power	120 Vac, 60 Hz	Detector Function	Peak (PK) Average (AV)
Environmental Conditions	25 deg. C, 65 % RH	Tested By	Tim Chen

Antenna Polarity & Test Distance: Horizontal at 3 m								
Frequency (MHz)	Emission Level (dBuV/m)	Read Level (dBuV)	Factor (dB/m)	Limit (dBuV/m)	Margin (dB)	Antenna Height (cm)	Table Angle (Degree)	Remark
5460	39.85	39.1	0.75	54	-14.15	118	96	Average
5460	49.53	48.78	0.75	74	-24.47	118	96	Peak
5470	48.26	47.49	0.77	68.2	-19.94	118	96	Peak
5670	91.67	90.94	0.73	-----	-----	118	96	Average
5670	100.38	99.65	0.73	-----	-----	118	96	Peak
5725	52.48	51.61	0.87	68.2	-15.72	118	96	Peak
11340	47.55	49.16	-1.61	54	-6.45	170	205	Average
11340	56.47	58.08	-1.61	74	-17.53	170	205	Peak

Antenna Polarity & Test Distance: Vertical at 3 m								
Frequency (MHz)	Emission Level (dBuV/m)	Read Level (dBuV)	Factor (dB/m)	Limit (dBuV/m)	Margin (dB)	Antenna Height (cm)	Table Angle (Degree)	Remark
5460	39.87	39.12	0.75	54	-14.13	248	251	Average
5460	49.12	48.37	0.75	74	-24.88	248	251	Peak
5470	48.54	47.77	0.77	68.2	-19.66	248	251	Peak
5670	96.37	95.64	0.73	-----	-----	248	251	Average
5670	105.07	104.34	0.73	-----	-----	248	251	Peak
5725	57.25	56.38	0.87	68.2	-10.95	248	251	Peak
11340	47.35	48.96	-1.61	54	-6.65	134	133	Average
11340	55.59	57.2	-1.61	74	-18.41	134	133	Peak

Remarks:

- Emission Level = Read Level + Factor
Margin value = Emission level – Limit value
- 5670 MHz: Fundamental Frequency
- *: Out of Restricted Band
- The emission levels of other frequencies were very low against the limit

EUT Test Condition		Measurement Detail	
Channel	Channel 151	Frequency Range	1 GHz ~ 40 GHz
Input Power	120 Vac, 60 Hz	Detector Function	Peak (PK) Average (AV)
Environmental Conditions	25 deg. C, 65 % RH	Tested By	Tim Chen

<Spurious Emission>

Antenna Polarity & Test Distance: Horizontal at 3 m								
Frequency (MHz)	Emission Level (dBuV/m)	Read Level (dBuV)	Factor (dB/m)	Limit (dBuV/m)	Margin (dB)	Antenna Height (cm)	Table Angle (Degree)	Remark
5755	93.18	92.27	0.91	-----	-----	118	94	Average
5755	101.36	100.45	0.91	-----	-----	118	94	Peak
11510	47.62	48.97	-1.35	54	-6.38	121	92	Average
11510	56.51	57.86	-1.35	74	-17.49	121	92	Peak
Antenna Polarity & Test Distance: Vertical at 3 m								
Frequency (MHz)	Emission Level (dBuV/m)	Read Level (dBuV)	Factor (dB/m)	Limit (dBuV/m)	Margin (dB)	Antenna Height (cm)	Table Angle (Degree)	Remark
5755	97.49	96.58	0.91	-----	-----	263	245	Average
5755	105.87	104.96	0.91	-----	-----	263	245	Peak
11510	47.24	48.59	-1.35	54	-6.76	171	129	Average
11510	56.51	57.86	-1.35	74	-17.49	171	129	Peak

<Out of Band Emission (OOBE)>

Antenna Polarity & Test Distance: Horizontal at 3 m								
Frequency (MHz)	Emission Level (dBuV/m)	Read Level (dBuV)	Factor (dB/m)	Limit (dBuV/m)	Margin (dB)	Antenna Height (cm)	Table Angle (Degree)	Remark
5593.7	50.86	50.07	0.79	68.2	-17.34	118	94	Peak
5660.2	49.96	49.29	0.67	75.77	-25.81	118	94	Peak
5915.75	49.99	48.69	1.3	75.02	-25.03	118	94	Peak
5979.875	51.42	50.07	1.35	68.2	-16.78	118	94	Peak
Antenna Polarity & Test Distance: Vertical at 3 m								
Frequency (MHz)	Emission Level (dBuV/m)	Read Level (dBuV)	Factor (dB/m)	Limit (dBuV/m)	Margin (dB)	Antenna Height (cm)	Table Angle (Degree)	Remark
5630.75	51.77	51.09	0.68	68.2	-16.43	263	245	Peak
5659.25	52.69	52.02	0.67	75.07	-22.38	263	245	Peak
5915.275	52.24	50.94	1.3	75.37	-23.13	263	245	Peak
5961.825	50.91	49.59	1.32	68.2	-17.29	263	245	Peak

Remarks:

- Emission Level = Read Level + Factor
Margin value = Emission level – Limit value
- 5755 MHz: Fundamental Frequency
- *: Out of Restricted Band
- The emission levels of other frequencies were very low against the limit

EUT Test Condition		Measurement Detail	
Channel	Channel 159	Frequency Range	1 GHz ~ 40 GHz
Input Power	120 Vac, 60 Hz	Detector Function	Peak (PK) Average (AV)
Environmental Conditions	25 deg. C, 65 % RH	Tested By	Tim Chen

<Spurious Emission>

Antenna Polarity & Test Distance: Horizontal at 3 m								
Frequency (MHz)	Emission Level (dBuV/m)	Read Level (dBuV)	Factor (dB/m)	Limit (dBuV/m)	Margin (dB)	Antenna Height (cm)	Table Angle (Degree)	Remark
5795	91.76	90.81	0.95	-----	-----	127	93	Average
5795	100.93	99.98	0.95	-----	-----	127	93	Peak
11590	45.72	47.52	-1.8	54	-8.28	129	213	Average
11590	54.96	56.76	-1.8	74	-19.04	129	213	Peak

Antenna Polarity & Test Distance: Vertical at 3 m								
Frequency (MHz)	Emission Level (dBuV/m)	Read Level (dBuV)	Factor (dB/m)	Limit (dBuV/m)	Margin (dB)	Antenna Height (cm)	Table Angle (Degree)	Remark
5795	95.92	94.97	0.95	-----	-----	253	247	Average
5795	103.58	102.63	0.95	-----	-----	253	247	Peak
11590	45.35	47.15	-1.8	54	-8.65	174	141	Average
11590	54.33	56.13	-1.8	74	-19.67	174	141	Peak

<Out of Band Emission (OOBE)>

Antenna Polarity & Test Distance: Horizontal at 3 m								
Frequency (MHz)	Emission Level (dBuV/m)	Read Level (dBuV)	Factor (dB/m)	Limit (dBuV/m)	Margin (dB)	Antenna Height (cm)	Table Angle (Degree)	Remark
5640.725	49.92	49.24	0.68	68.2	-18.28	127	93	Peak
5659.725	48.92	48.25	0.67	75.42	-26.5	127	93	Peak
5916.7	49.94	48.64	1.3	74.32	-24.38	127	93	Peak
5964.2	50.79	49.46	1.33	68.2	-17.41	127	93	Peak

Antenna Polarity & Test Distance: Vertical at 3 m								
Frequency (MHz)	Emission Level (dBuV/m)	Read Level (dBuV)	Factor (dB/m)	Limit (dBuV/m)	Margin (dB)	Antenna Height (cm)	Table Angle (Degree)	Remark
5641.675	51.02	50.34	0.68	68.2	-17.18	253	247	Peak
5653.075	52.35	51.65	0.7	70.49	-18.14	253	247	Peak
5922.4	50.88	49.58	1.3	70.12	-19.24	253	247	Peak
5946.625	51.96	50.64	1.32	68.2	-16.24	253	247	Peak

Remarks:

- Emission Level = Read Level + Factor
Margin value = Emission level – Limit value
- 5795 MHz: Fundamental Frequency
- *: Out of Restricted Band
- The emission levels of other frequencies were very low against the limit

802.11ac (VHT80)

EUT Test Condition		Measurement Detail	
Channel	Channel 42	Frequency Range	1 GHz ~ 40 GHz
Input Power	120 Vac, 60 Hz	Detector Function	Peak (PK) Average (AV)
Environmental Conditions	25 deg. C, 65 % RH	Tested By	Tim Chen

Antenna Polarity & Test Distance: Horizontal at 3 m

Frequency (MHz)	Emission Level (dBuV/m)	Read Level (dBuV)	Factor (dB/m)	Limit (dBuV/m)	Margin (dB)	Antenna Height (cm)	Table Angle (Degree)	Remark
5150	51.35	50.93	0.42	54	-2.65	127	96	Average
5150	57.9	57.48	0.42	74	-16.1	127	96	Peak
5210	89.82	89.7	0.12	-----	-----	127	96	Average
5210	97.1	96.98	0.12	-----	-----	127	96	Peak
5350	41.2	40.87	0.33	54	-12.8	127	96	Average
5350	46.52	46.19	0.33	74	-27.48	127	96	Peak
10420	57.49	59.23	-1.74	68.2	-10.71	145	134	Peak

Antenna Polarity & Test Distance: Vertical at 3 m

Frequency (MHz)	Emission Level (dBuV/m)	Read Level (dBuV)	Factor (dB/m)	Limit (dBuV/m)	Margin (dB)	Antenna Height (cm)	Table Angle (Degree)	Remark
5150	53.24	52.82	0.42	54	-0.76	234	264	Average
5150	62.14	61.72	0.42	74	-11.86	234	264	Peak
5210	92.53	92.41	0.12	-----	-----	234	264	Average
5210	99.68	99.56	0.12	-----	-----	234	264	Peak
5350	41.81	41.48	0.33	54	-12.19	234	264	Average
5350	49.45	49.12	0.33	74	-24.55	234	264	Peak
10420	57.58	59.32	-1.74	68.2	-10.62	180	195	Peak

Remarks:

- Emission Level = Read Level + Factor
Margin value = Emission level – Limit value
- 5210 MHz: Fundamental Frequency
- *: Out of Restricted Band
- The emission levels of other frequencies were very low against the limit

EUT Test Condition		Measurement Detail	
Channel	Channel 58	Frequency Range	1 GHz ~ 40 GHz
Input Power	120 Vac, 60 Hz	Detector Function	Peak (PK) Average (AV)
Environmental Conditions	25 deg. C, 65 % RH	Tested By	Tim Chen

Antenna Polarity & Test Distance: Horizontal at 3 m								
Frequency (MHz)	Emission Level (dBuV/m)	Read Level (dBuV)	Factor (dB/m)	Limit (dBuV/m)	Margin (dB)	Antenna Height (cm)	Table Angle (Degree)	Remark
5150	41.75	41.33	0.42	54	-12.25	122	95	Average
5150	48.43	48.01	0.42	74	-25.57	122	95	Peak
5290	89.39	89.22	0.17	-----	-----	122	95	Average
5290	96.08	95.91	0.17	-----	-----	122	95	Peak
5350	45.01	44.68	0.33	54	-8.99	122	95	Average
5350	49.98	49.65	0.33	74	-24.02	122	95	Peak
10580	57.31	58.88	-1.57	68.2	-10.89	132	153	Peak
Antenna Polarity & Test Distance: Vertical at 3 m								
Frequency (MHz)	Emission Level (dBuV/m)	Read Level (dBuV)	Factor (dB/m)	Limit (dBuV/m)	Margin (dB)	Antenna Height (cm)	Table Angle (Degree)	Remark
5150	43	42.58	0.42	54	-11	233	259	Average
5150	51.21	50.79	0.42	74	-22.79	233	259	Peak
5290	91.61	91.44	0.17	-----	-----	233	259	Average
5290	98.58	98.41	0.17	-----	-----	233	259	Peak
5350	47.31	46.98	0.33	54	-6.69	233	259	Average
5350	56.81	56.48	0.33	74	-17.19	233	259	Peak
10580	56.68	58.25	-1.57	68.2	-11.52	111	132	Peak

Remarks:

- Emission Level = Read Level + Factor
Margin value = Emission level – Limit value
- 5290 MHz: Fundamental Frequency
- *: Out of Restricted Band
- The emission levels of other frequencies were very low against the limit

EUT Test Condition		Measurement Detail	
Channel	Channel 106	Frequency Range	1 GHz ~ 40 GHz
Input Power	120 Vac, 60 Hz	Detector Function	Peak (PK) Average (AV)
Environmental Conditions	25 deg. C, 65 % RH	Tested By	Tim Chen

Antenna Polarity & Test Distance: Horizontal at 3 m								
Frequency (MHz)	Emission Level (dBuV/m)	Read Level (dBuV)	Factor (dB/m)	Limit (dBuV/m)	Margin (dB)	Antenna Height (cm)	Table Angle (Degree)	Remark
5460	45.82	45.07	0.75	54	-8.18	116	97	Average
5460	53.26	52.51	0.75	74	-20.74	116	97	Peak
5470	56.48	55.71	0.77	68.2	-11.72	116	97	Peak
5530	87.43	86.57	0.86	-----	-----	116	97	Average
5530	95.27	94.41	0.86	-----	-----	116	97	Peak
5725	47.13	46.26	0.87	68.2	-21.07	116	97	Peak
11060	46.03	47.38	-1.35	54	-7.97	167	212	Average
11060	55.64	56.99	-1.35	74	-18.36	167	212	Peak

Antenna Polarity & Test Distance: Vertical at 3 m								
Frequency (MHz)	Emission Level (dBuV/m)	Read Level (dBuV)	Factor (dB/m)	Limit (dBuV/m)	Margin (dB)	Antenna Height (cm)	Table Angle (Degree)	Remark
5460	49.83	49.08	0.75	54	-4.17	262	256	Average
5460	56.3	55.55	0.75	74	-17.7	262	256	Peak
5470	59.55	58.78	0.77	68.2	-8.65	262	256	Peak
5530	90.6	89.74	0.86	-----	-----	262	256	Average
5530	97.96	97.1	0.86	-----	-----	262	256	Peak
5725	47.84	46.97	0.87	68.2	-20.36	262	256	Peak
11060	47.54	48.89	-1.35	54	-6.46	136	158	Average
11060	56.11	57.46	-1.35	74	-17.89	136	158	Peak

Remarks:

- Emission Level = Read Level + Factor
Margin value = Emission level – Limit value
- 5530 MHz: Fundamental Frequency
- *: Out of Restricted Band
- The emission levels of other frequencies were very low against the limit

EUT Test Condition		Measurement Detail	
Channel	Channel 122	Frequency Range	1 GHz ~ 40 GHz
Input Power	120 Vac, 60 Hz	Detector Function	Peak (PK) Average (AV)
Environmental Conditions	25 deg. C, 65 % RH	Tested By	Tim Chen

Antenna Polarity & Test Distance: Horizontal at 3 m								
Frequency (MHz)	Emission Level (dBuV/m)	Read Level (dBuV)	Factor (dB/m)	Limit (dBuV/m)	Margin (dB)	Antenna Height (cm)	Table Angle (Degree)	Remark
5460	43.8	43.05	0.75	54	-10.2	130	96	Average
5460	49.29	48.54	0.75	74	-24.71	130	96	Peak
5470	54.61	53.84	0.77	68.2	-13.59	130	96	Peak
5610	90.65	89.92	0.73	-----	-----	130	96	Average
5610	98.62	97.89	0.73	-----	-----	130	96	Peak
5725	49.75	48.88	0.87	68.2	-18.45	130	96	Peak
11220	48.18	49.84	-1.66	54	-5.82	163	172	Average
11220	57.28	58.94	-1.66	74	-16.72	163	172	Peak

Antenna Polarity & Test Distance: Vertical at 3 m								
Frequency (MHz)	Emission Level (dBuV/m)	Read Level (dBuV)	Factor (dB/m)	Limit (dBuV/m)	Margin (dB)	Antenna Height (cm)	Table Angle (Degree)	Remark
5460	46.72	45.97	0.75	54	-7.28	270	250	Average
5460	53.74	52.99	0.75	74	-20.26	270	250	Peak
5470	53.59	52.82	0.77	68.2	-14.61	270	250	Peak
5610	95.84	95.11	0.73	-----	-----	270	250	Average
5610	103.77	103.04	0.73	-----	-----	270	250	Peak
5725	56.56	55.69	0.87	68.2	-11.64	270	250	Peak
11220	47.49	49.15	-1.66	54	-6.51	129	185	Average
11220	57.16	58.82	-1.66	74	-16.84	129	185	Peak

Remarks:

- Emission Level = Read Level + Factor
Margin value = Emission level – Limit value
- 5610 MHz: Fundamental Frequency
- *: Out of Restricted Band
- The emission levels of other frequencies were very low against the limit

EUT Test Condition		Measurement Detail	
Channel	Channel 155	Frequency Range	1 GHz ~ 40 GHz
Input Power	120 Vac, 60 Hz	Detector Function	Peak (PK) Average (AV)
Environmental Conditions	25 deg. C, 65 % RH	Tested By	Tim Chen

<Spurious Emission>

Antenna Polarity & Test Distance: Horizontal at 3 m								
Frequency (MHz)	Emission Level (dBuV/m)	Read Level (dBuV)	Factor (dB/m)	Limit (dBuV/m)	Margin (dB)	Antenna Height (cm)	Table Angle (Degree)	Remark
5775	90.79	89.85	0.94	-----	-----	131	96	Average
5775	98.89	97.95	0.94	-----	-----	131	96	Peak
11550	46.81	48.41	-1.6	54	-7.19	144	229	Average
11550	55.81	57.41	-1.6	74	-18.19	144	229	Peak
Antenna Polarity & Test Distance: Vertical at 3 m								
Frequency (MHz)	Emission Level (dBuV/m)	Read Level (dBuV)	Factor (dB/m)	Limit (dBuV/m)	Margin (dB)	Antenna Height (cm)	Table Angle (Degree)	Remark
5775	96.32	95.38	0.94	-----	-----	256	250	Average
5775	104.43	103.49	0.94	-----	-----	256	250	Peak
11550	46.96	48.56	-1.6	54	-7.04	192	147	Average
11550	55.85	57.45	-1.6	74	-18.15	192	147	Peak

<Out of Band Emission (OOBE)>

Antenna Polarity & Test Distance: Horizontal at 3 m								
Frequency (MHz)	Emission Level (dBuV/m)	Read Level (dBuV)	Factor (dB/m)	Limit (dBuV/m)	Margin (dB)	Antenna Height (cm)	Table Angle (Degree)	Remark
5645.95	58.36	57.69	0.67	68.2	-9.84	131	96	Peak
5652.6	57.2	56.51	0.69	70.13	-12.93	131	96	Peak
5920.975	53.74	52.44	1.3	71.17	-17.43	131	96	Peak
5929.05	54.8	53.5	1.3	68.2	-13.4	131	96	Peak
Antenna Polarity & Test Distance: Vertical at 3 m								
Frequency (MHz)	Emission Level (dBuV/m)	Read Level (dBuV)	Factor (dB/m)	Limit (dBuV/m)	Margin (dB)	Antenna Height (cm)	Table Angle (Degree)	Remark
5646.425	63.15	62.48	0.67	68.2	-5.05	256	250	Peak
5658.3	63.24	62.58	0.66	74.36	-11.12	256	250	Peak
5921.925	58.01	56.71	1.3	70.47	-12.46	256	250	Peak
5932.375	59.15	57.85	1.3	68.2	-9.05	256	250	Peak

Remarks:

- Emission Level = Read Level + Factor
Margin value = Emission level – Limit value
- 5775 MHz: Fundamental Frequency
- *: Out of Restricted Band
- The emission levels of other frequencies were very low against the limit

9 kHz ~ 30 MHz Data:

The amplitude of spurious emissions attenuated more than 20 dB below the permissible value is not required to be report.

30 MHz ~ 1 GHz Worst-Case Data:

802.11n (HT40)

EUT Test Condition		Measurement Detail	
Channel	Channel 38	Frequency Range	30 MHz ~ 1 GHz
Input Power	120 Vac, 60 Hz	Detector Function	Peak (PK) Quasi-peak (QP)
Environmental Conditions	25 deg. C, 65 % RH	Tested By	Tim Chen

Horizontal

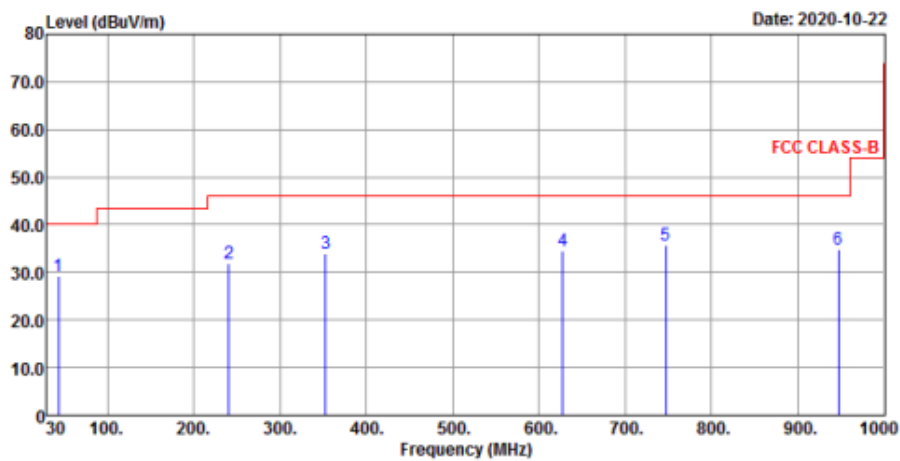

Vertical

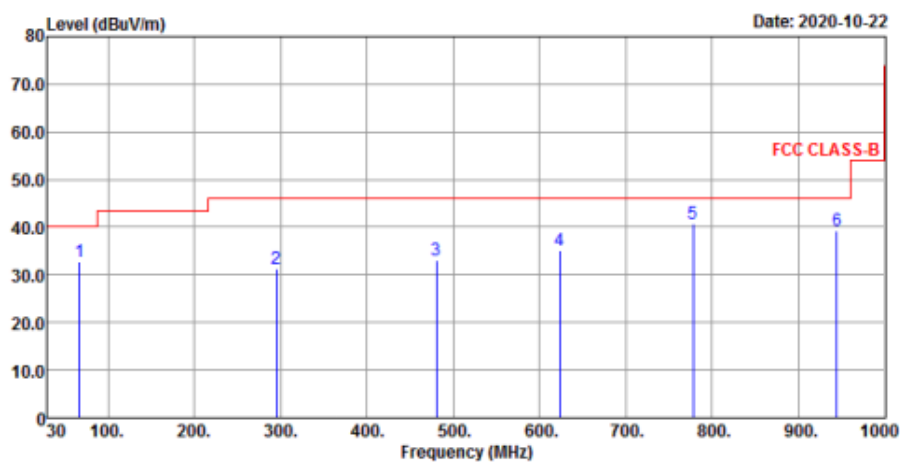

Antenna Polarity & Test Distance: Horizontal at 3 m								
Frequency (MHz)	Emission Level (dBuV/m)	Read Level (dBuV)	Factor (dB/m)	Limit (dBuV/m)	Margin (dB)	Antenna Height (cm)	Table Angle (Degree)	Remark
43.58	29.34	41.26	-11.92	40	-10.66	193	124	QP
240.49	31.8	45.14	-13.34	46	-14.2	109	133	QP
353.01	33.81	43.48	-9.67	46	-12.19	117	226	QP
627.52	34.57	36.41	-1.84	46	-11.43	131	144	QP
746.83	35.75	34.8	0.95	46	-10.25	134	43	QP
946.65	34.85	31.19	3.66	46	-11.15	178	313	QP
Antenna Polarity & Test Distance: Vertical at 3 m								
Frequency (MHz)	Emission Level (dBuV/m)	Read Level (dBuV)	Factor (dB/m)	Limit (dBuV/m)	Margin (dB)	Antenna Height (cm)	Table Angle (Degree)	Remark
66.86	32.67	45.86	-13.19	40	-7.33	131	152	QP
294.81	31.16	42.49	-11.33	46	-14.84	146	69	QP
480.08	33.12	38.93	-5.81	46	-12.88	181	133	QP
623.64	35.09	37.03	-1.94	46	-10.91	177	322	QP
777.87	40.88	39.4	1.48	46	-5.12	143	202	QP
944.71	39.17	35.54	3.63	46	-6.83	179	110	QP

Remarks:

- Emission Level = Read Level + Factor
Margin value = Emission level – Limit value
- The emission levels of other frequencies were very low against the limit

4.2 Conducted Emission Measurement

4.2.1 Limits of Conducted Emission Measurement

Frequency (MHz)	Conducted Limit (dBuV)	
	Quasi-Peak	Average
0.15 - 0.5	66 - 56	56 - 46
0.50 - 5.0	56	46
5.0 - 30.0	60	50

- Note: 1. The lower limit shall apply at the transition frequencies.
 2. The limit decreases in line with the logarithm of the frequency in the range of 0.15 to 0.50 MHz.

4.2.2 Test Instruments

Description & Manufacturer	Model No.	Serial No.	Date of Calibration	Due Date of Calibration
Test Receiver ROHDE & SCHWARZ	ESR3	102412	Feb. 17, 2020	Feb. 16, 2021
RF signal cable (with 10dB PAD) Woken	5D-FB	Cable-cond2-01	Sep. 04, 2020	Sep. 03, 2021
LISN/AMN ROHDE & SCHWARZ (EUT)	ESH2-Z5	100100	Jan. 20, 2020	Jan. 19, 2021
LISN/AMN ROHDE & SCHWARZ (Peripheral)	ESH3-Z5	100312	Aug. 18, 2020	Aug. 17, 2021
Software ADT	BV ADT_Cond_ V7.3.7.4	NA	NA	NA

- Note: 1. The calibration interval of the above test instruments is 12 months and the calibrations are traceable to NML/ROC and NIST/USA.
 2. The test was performed in HwaYa Shielded Room 2. (Conduction 2)
 3. The VCCI Site Registration No. is C-12047.

4.2.3 Test Procedures

- a. The EUT was placed 0.4 meters from the conducting wall of the shielded room with EUT being connected to the power mains through a line impedance stabilization network (LISN). Other support units were connected to the power mains through another LISN. The two LISNs provide 50 ohm/ 50uH of coupling impedance for the measuring instrument.
- b. Both lines of the power mains connected to the EUT were checked for maximum conducted interference.
- c. The frequency range from 150 kHz to 30 MHz was searched. Emission levels under (Limit -20 dB) was not recorded.

Note: All modes of operation were investigated and the worst-case emissions are reported.

4.2.4 Deviation from Test Standard

No deviation.

4.2.5 Test Setup

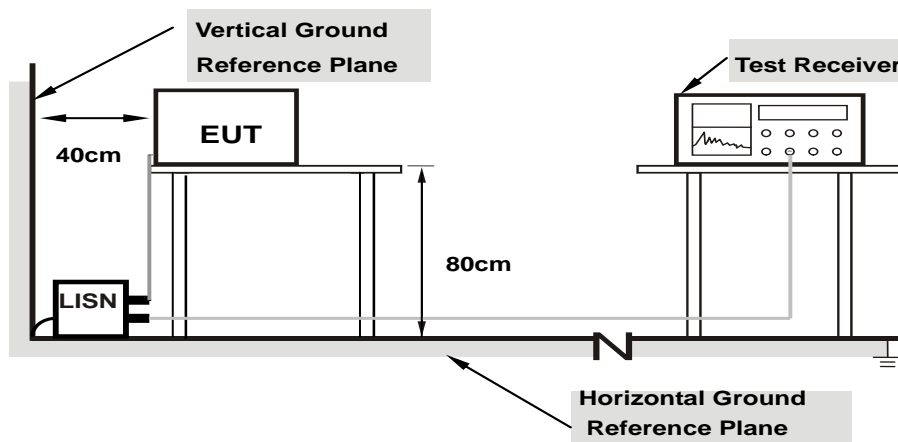

- Note:**
1. Support units were connected to second LISN.
 2. Both of LISNs (AMN) are 80 cm from EUT and at least 80 cm from other units and other metal planes

For the actual test configuration, please refer to the attached file (Test Setup Photo).

4.2.6 EUT Operating Conditions

- a. Placed the EUT on a testing table.
- b. Use the software to control the EUT under transmission condition continuously at specific channel frequency.

4.2.7 Test Results

Frequency Range	150kHz ~ 30MHz	Detector Function & Resolution Bandwidth	Quasi-Peak (QP) / Average (AV), 9kHz
Input Power	120Vac, 60Hz	Environmental Conditions	25°C, 75%RH
Tested by	Getaz Yang	Test Date	2020/10/23

Phase Of Power : Line (L)										
No	Frequency (MHz)	Correction Factor (dB)	Reading Value (dBuV)		Emission Level (dBuV)		Limit (dBuV)		Margin (dB)	
			Q.P.	AV.	Q.P.	AV.	Q.P.	AV.	Q.P.	AV.
1	0.15800	10.09	27.54	22.31	37.63	32.40	65.57	55.57	-27.94	-23.17
2	0.24200	10.10	20.34	15.75	30.44	25.85	62.03	52.03	-31.59	-26.18
3	0.46600	10.11	22.16	15.23	32.27	25.34	56.58	46.58	-24.31	-21.24
4	1.52600	10.16	9.20	1.17	19.36	11.33	56.00	46.00	-36.64	-34.67
5	4.64200	10.24	16.42	10.08	26.66	20.32	56.00	46.00	-29.34	-25.68
6	17.27800	10.38	13.29	8.57	23.67	18.95	60.00	50.00	-36.33	-31.05

Remarks:

1. Q.P. and AV. are abbreviations of quasi-peak and average individually.
2. The emission levels of other frequencies were very low against the limit.
3. Margin value = Emission level – Limit value
4. Correction factor = Insertion loss + Cable loss
5. Emission Level = Correction Factor + Reading Value

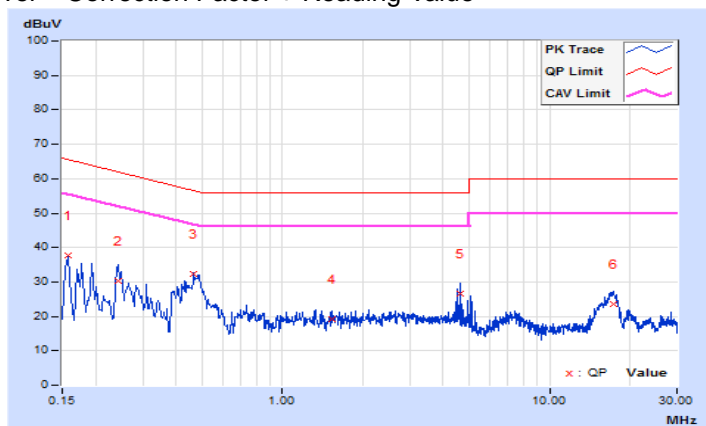

Frequency Range	150kHz ~ 30MHz	Detector Function & Resolution Bandwidth	Quasi-Peak (QP) / Average (AV), 9kHz
Input Power	120Vac, 60Hz	Environmental Conditions	25°C, 75%RH
Tested by	Getaz Yang	Test Date	2020/10/23

Phase Of Power : Neutral (N)										
No	Frequency (MHz)	Correction Factor (dB)	Reading Value (dBuV)		Emission Level (dBuV)		Limit (dBuV)		Margin (dB)	
			Q.P.	AV.	Q.P.	AV.	Q.P.	AV.	Q.P.	AV.
1	0.17400	10.06	24.94	19.44	35.00	29.50	64.77	54.77	-29.77	-25.27
2	0.26600	10.07	18.30	9.67	28.37	19.74	61.24	51.24	-32.87	-31.50
3	0.47800	10.09	25.12	18.16	35.21	28.25	56.37	46.37	-21.16	-18.12
4	0.86600	10.12	9.76	1.61	19.88	11.73	56.00	46.00	-36.12	-34.27
5	4.54200	10.24	17.87	13.03	28.11	23.27	56.00	46.00	-27.89	-22.73
6	17.43400	10.56	12.70	7.70	23.26	18.26	60.00	50.00	-36.74	-31.74

Remarks:

1. Q.P. and AV. are abbreviations of quasi-peak and average individually.
2. The emission levels of other frequencies were very low against the limit.
3. Margin value = Emission level – Limit value
4. Correction factor = Insertion loss + Cable loss
5. Emission Level = Correction Factor + Reading Value

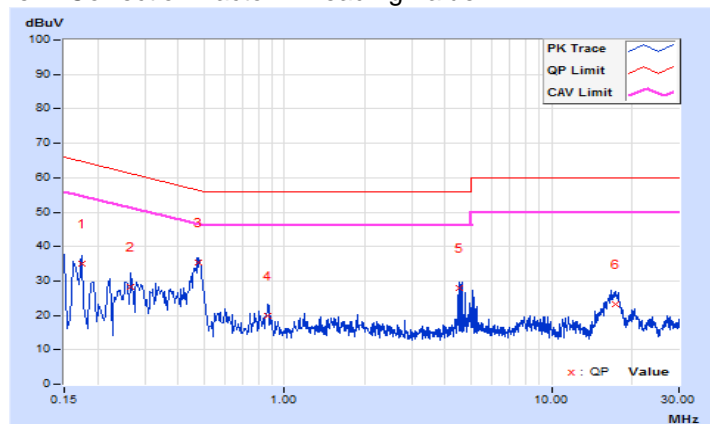

4.3 Transmit Power Measurement

4.3.1 Limits of Transmit Power Measurement

Operation Band	EUT Category	Limit
U-NII-1	Outdoor Access Point	1 Watt (30 dBm) (Max. e.i.r.p \leq 125 mW (21 dBm) at any elevation angle above 30 degrees as measured from the horizon)
	Fixed point-to-point Access Point	1 Watt (30 dBm)
	Indoor Access Point	1 Watt (30 dBm)
	√ Mobile and Portable client device	250 mW (24 dBm)
U-NII-2A	√	250 mW (24 dBm) or 11 dBm + 10 log B*
U-NII-2C	√	250 mW (24 dBm) or 11 dBm + 10 log B*
U-NII-3	√	1 Watt (30 dBm)

*B is the 26 dB emission bandwidth in megahertz

4.3.2 Test Setup

<Power Output Measurement>

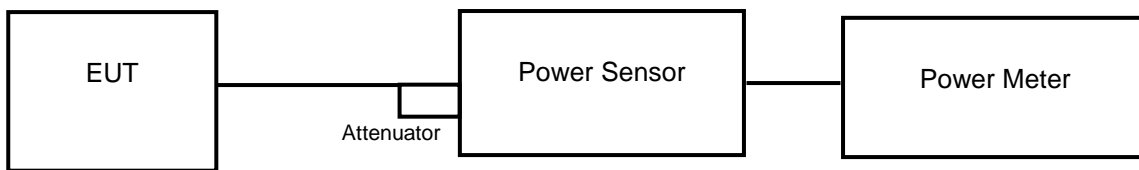

or

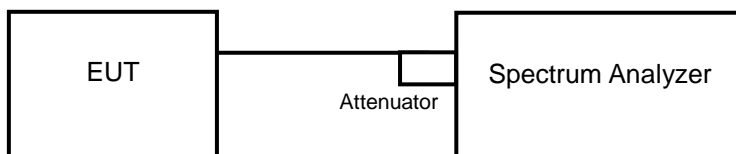

<26 dB Bandwidth>

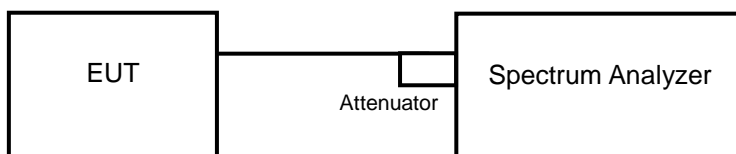

4.3.3 Test Instruments

Refer to section 4.1.2 to get information of above instrument.

4.3.4 Test Procedure

Average Power Measurement

<802.11a, 802.11n (HT20), 802.11n (HT40)>

Method PM is used to perform output power measurement, trigger and gating function of wide band power meter is enabled to measure max output power of TX on burst. Duty factor is not added to measured value.

<802.11ac (VHT80)>

- a. Set span to encompass the entire 26 dB EBW (or, alternatively, the entire 99 % occupied bandwidth) of the signal.
- b. Set sweep trigger to “free run”.
- c. Set RBW = 1 MHz.
- d. Set VBW \geq 3 MHz
- e. Number of points in sweep \geq 2 Span / RBW.
- f. Sweep time \leq (number of points in sweep) * T
- g. Using emission bandwidth to determine the frequency span for integration the channel bandwidth.
- h. Detector = RMS.
- i. Trace mode = max hold.
- j. Allow max hold to run for at least 60 seconds, or longer as needed to allow the trace to stabilize.
- k. Compute power by integrating the spectrum across the EBW (or, alternatively, the entire 99% occupied bandwidth) of the signal using the instrument’s band power measurement function with band limits set equal to the EBW (or occupied bandwidth) band edges. If the instrument does not have a band power function, sum the spectrum levels (in power units) at 1 MHz intervals extending across the EBW (or, alternatively, the entire 99% occupied bandwidth) of the spectrum

26 dB Bandwidth

- a. Set RBW = approximately 1 % of the emission bandwidth.
- b. Set the VBW \geq 3 x RBW.
- c. Detector = Peak.
- d. Trace mode = max hold.
- e. Measure the maximum width of the emission that is 26 dB down from the peak of the emission. Compare this with the RBW setting of the analyzer. Readjust RBW and repeat measurement as needed until the RBW/EBW ratio is approximately 1 %.

4.3.5 Deviation from Test Standard

No deviation.

4.3.6 EUT Operating Conditions

The software provided by client to enable the EUT under transmission condition continuously at lowest, middle and highest channel frequencies individually.

4.3.7 Test Results

Power Output:

802.11a

Channel	Frequency (MHz)	Maximum Conducted Power (mW)	Maximum Conducted Power (dBm)	Power Limit (dBm)	Pass / Fail
36	5180	23.281	13.67	24	Pass
40	5200	57.943	17.63	24	Pass
48	5240	55.59	17.45	24	Pass
52	5260	58.21	17.65	24	Pass
60	5300	58.614	17.68	24	Pass
64	5320	31.477	14.98	24	Pass
100	5500	31.046	14.92	24	Pass
116	5580	58.21	17.65	24	Pass
140	5700	24.099	13.82	24	Pass
149	5745	56.364	17.51	30	Pass
157	5785	56.105	17.49	30	Pass
165	5825	56.494	17.52	30	Pass

Note:

For U-NII-2A, U-NII-2C Band:

1. $11 \text{ dBm} + 10\log(23.43) = 24.70 \text{ dBm} > 24 \text{ dBm}$.
2. $11 \text{ dBm} + 10\log(23.55) = 24.72 \text{ dBm} > 24 \text{ dBm}$.
3. $11 \text{ dBm} + 10\log(21.55) = 24.33 \text{ dBm} > 24 \text{ dBm}$.
4. $11 \text{ dBm} + 10\log(21.55) = 24.33 \text{ dBm} > 24 \text{ dBm}$.
5. $11 \text{ dBm} + 10\log(26.05) = 25.16 \text{ dBm} > 24 \text{ dBm}$.
6. $11 \text{ dBm} + 10\log(21.60) = 24.34 \text{ dBm} > 24 \text{ dBm}$.

802.11n (HT20)

Channel	Frequency (MHz)	Maximum Conducted Power (mW)	Maximum Conducted Power (dBm)	Power Limit (dBm)	Pass / Fail
36	5180	27.29	14.36	24	Pass
40	5200	56.105	17.49	24	Pass
48	5240	59.156	17.72	24	Pass
52	5260	60.674	17.83	24	Pass
60	5300	59.293	17.73	24	Pass
64	5320	24.66	13.92	24	Pass
100	5500	29.04	14.63	24	Pass
116	5580	57.016	17.56	24	Pass
140	5700	38.371	15.84	24	Pass
149	5745	55.463	17.44	30	Pass
157	5785	57.016	17.56	30	Pass
165	5825	56.494	17.52	30	Pass

Note:
For U-NII-2A, U-NII-2C Band:

1. $11 \text{ dBm} + 10\log (25.70) = 25.10 \text{ dBm} > 24 \text{ dBm}$.
2. $11 \text{ dBm} + 10\log (21.36) = 24.30 \text{ dBm} > 24 \text{ dBm}$.
3. $11 \text{ dBm} + 10\log (21.27) = 24.28 \text{ dBm} > 24 \text{ dBm}$.
4. $11 \text{ dBm} + 10\log (21.10) = 24.24 \text{ dBm} > 24 \text{ dBm}$.
5. $11 \text{ dBm} + 10\log (21.88) = 24.40 \text{ dBm} > 24 \text{ dBm}$.
6. $11 \text{ dBm} + 10\log (21.18) = 24.26 \text{ dBm} > 24 \text{ dBm}$.

802.11n (HT40)

Channel	Frequency (MHz)	Maximum Conducted Power (mW)	Maximum Conducted Power (dBm)	Power Limit (dBm)	Pass / Fail
38	5190	19.77	12.96	24	Pass
46	5230	23.496	13.71	24	Pass
54	5270	23.281	13.67	24	Pass
62	5310	23.55	13.72	24	Pass
102	5510	21.33	13.29	24	Pass
110	5550	19.907	12.99	24	Pass
134	5670	22.856	13.59	24	Pass
151	5755	22.439	13.51	30	Pass
159	5795	22.542	13.53	30	Pass

Note:

For U-NII-2A, U-NII-2C Band:

1. $11 \text{ dBm} + 10\log (45.06) = 27.54 \text{ dBm} > 24 \text{ dBm}$.
2. $11 \text{ dBm} + 10\log (44.53) = 27.49 \text{ dBm} > 24 \text{ dBm}$.
3. $11 \text{ dBm} + 10\log (46.28) = 27.65 \text{ dBm} > 24 \text{ dBm}$.
4. $11 \text{ dBm} + 10\log (49.29) = 27.93 \text{ dBm} > 24 \text{ dBm}$.
5. $11 \text{ dBm} + 10\log (46.43) = 27.67 \text{ dBm} > 24 \text{ dBm}$.

802.11ac (VHT80)

Channel	Frequency (MHz)	Maximum Conducted Power (mW)	Maximum Conducted Power (dBm)	Power Limit (dBm)	Pass / Fail
42	5210	16.255	12.11	24	Pass
58	5290	18.75	12.73	24	Pass
106	5530	14.555	11.63	24	Pass
122	5610	33.42	15.24	24	Pass
155	5775	34.914	15.43	30	Pass

Note:

For U-NII-2A, U-NII-2C Band:

1. $11 \text{ dBm} + 10\log (81.94) = 30.13 \text{ dBm} > 24 \text{ dBm}$.
2. $11 \text{ dBm} + 10\log (81.97) = 30.14 \text{ dBm} > 24 \text{ dBm}$.
3. $11 \text{ dBm} + 10\log (96.53) = 30.85 \text{ dBm} > 24 \text{ dBm}$.

26 dB Bandwidth:
802.11a

Channel	Frequency (MHz)	26 dBc Bandwidth (MHz)
36	5180	21.51
40	5200	23.40
48	5240	23.52
52	5260	23.43
60	5300	23.55
64	5320	21.55
100	5500	21.55
116	5580	26.05
140	5700	21.60

802.11n (HT20)

Channel	Frequency (MHz)	26 dBc Bandwidth (MHz)
36	5180	21.23
40	5200	22.56
48	5240	23.81
52	5260	25.70
60	5300	21.36
64	5320	21.27
100	5500	21.10
116	5580	21.88
140	5700	21.18

802.11n (HT40)

Channel	Frequency (MHz)	26 dBc Bandwidth (MHz)
38	5190	41.38
46	5230	45.92
54	5270	45.06
62	5310	44.53
102	5510	46.28
110	5550	49.29
134	5670	46.43

802.11ac (VHT80)

Channel	Frequency (MHz)	26 dBc Bandwidth (MHz)
42	5210	82.20
58	5290	81.94
106	5530	81.97
122	5610	96.53

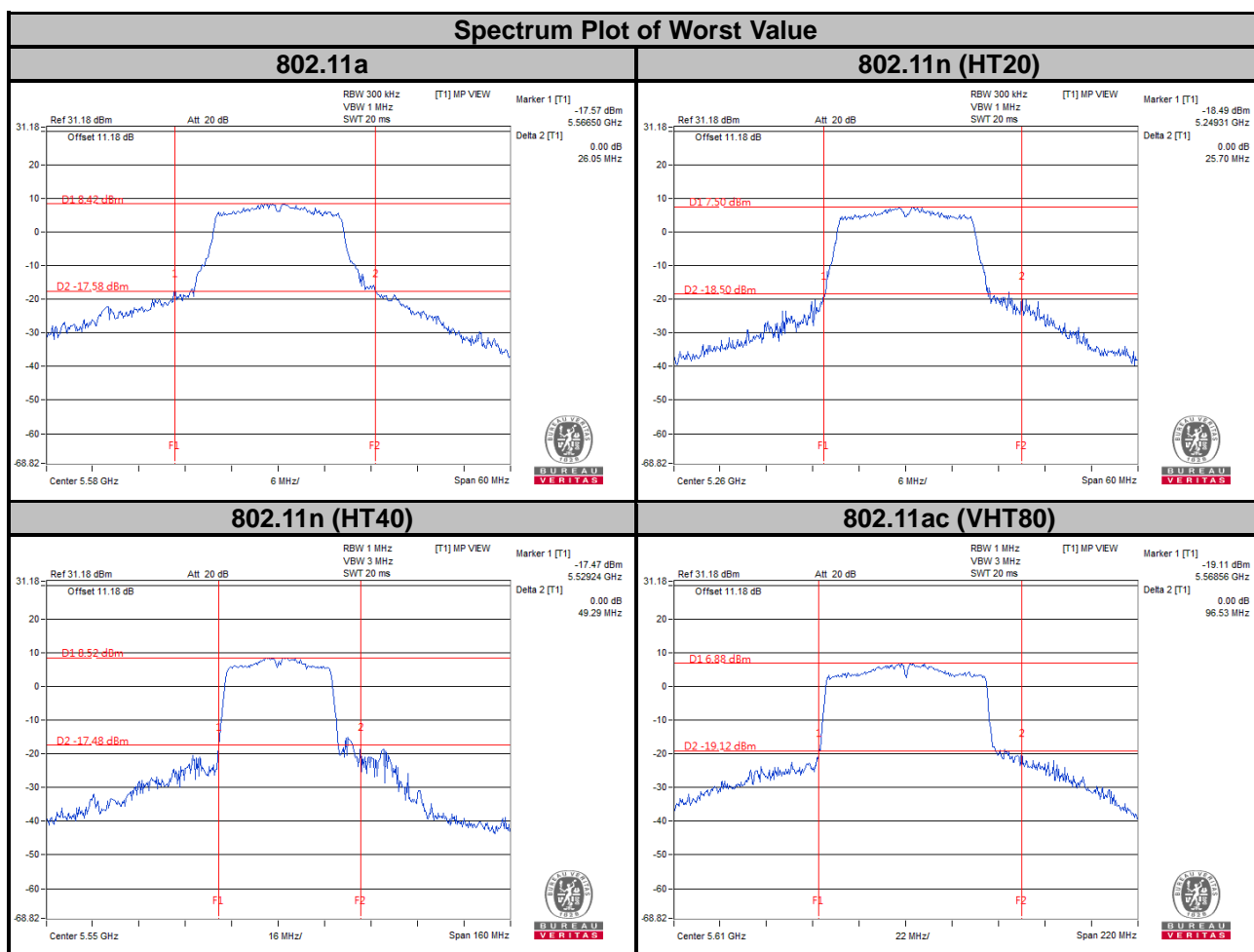

4.4 Occupied Bandwidth Measurement

4.4.1 Test Setup



4.4.2 Test Instruments

Refer to section 4.1.2 to get information of above instrument.

4.4.3 Test Procedure

The transmitter output was connected to the spectrum analyzer through an attenuator. The bandwidth of the fundamental frequency was measured by spectrum analyzer with resolution bandwidth in the range of 1 % to 5 % of the anticipated emission bandwidth, and a video bandwidth at least 3x the resolution bandwidth and set the detector to SAMPLE. The width of a frequency band such that, below the lower and above the upper frequency limits, the mean powers emitted are each equal to a specified percentage 0.5 % of the total mean power of a given emission.

4.4.4 Test Results

802.11a

Channel	Channel Frequency (MHz)	Occupied Bandwidth (MHz)
36	5180	16.92
40	5200	17.16
48	5240	17.16
52	5260	17.04
60	5300	17.16
64	5320	16.92
100	5500	16.92
116	5580	17.16
140	5700	16.92
149	5745	17.52
157	5785	17.40
165	5825	17.28

802.11n (HT20)

Channel	Channel Frequency (MHz)	Occupied Bandwidth (MHz)
36	5180	17.88
40	5200	17.88
48	5240	17.88
52	5260	17.88
60	5300	18.00
64	5320	17.88
100	5500	17.88
116	5580	17.88
140	5700	17.88
149	5745	18.00
157	5785	18.00
165	5825	18.12

802.11n (HT40)

Channel	Channel Frequency (MHz)	Occupied Bandwidth (MHz)
38	5190	36.24
46	5230	36.72
54	5270	36.72
62	5310	36.48
102	5510	36.72
110	5550	36.48
134	5670	36.48
151	5755	36.72
159	5795	36.72

802.11ac (VHT80)

Channel	Channel Frequency (MHz)	Occupied Bandwidth (MHz)
42	5210	75.36
58	5290	75.84
106	5530	75.84
122	5610	76.32
155	5775	75.36

Spectrum Plot of Worst Value

802.11a

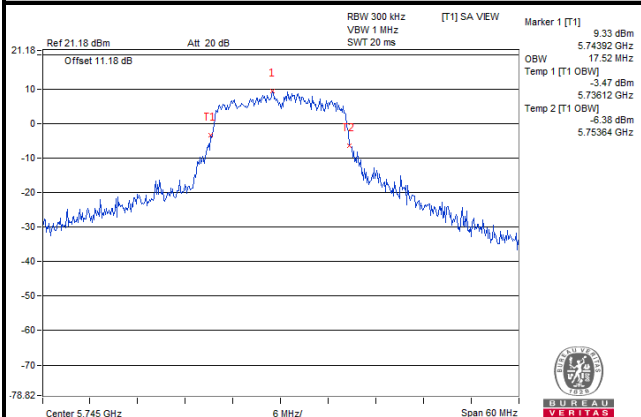

802.11n (HT20)

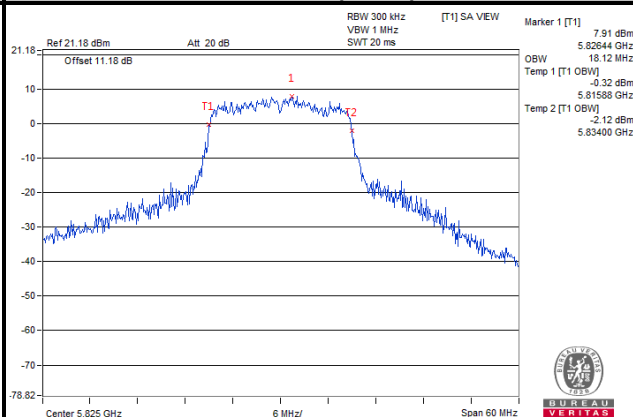

802.11n (HT40)

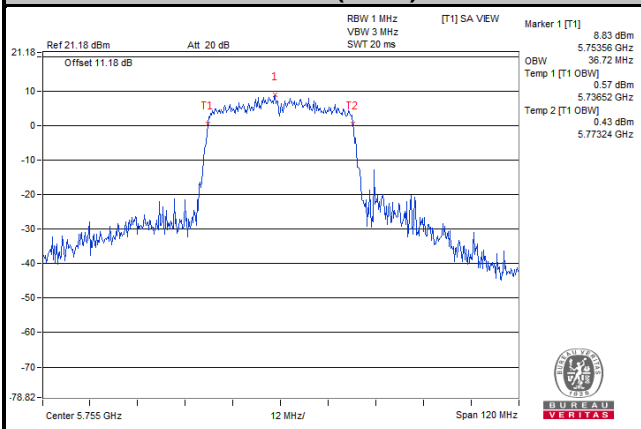

802.11ac (VHT80)

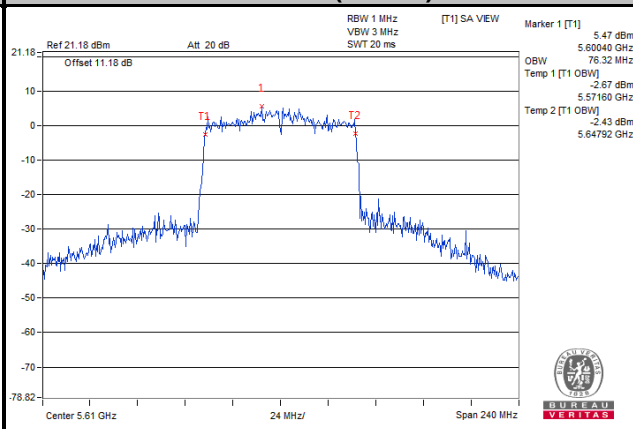

Spectrum Plot for Nearby DFS Band

802.11a

Ch 48 (5240 MHz)

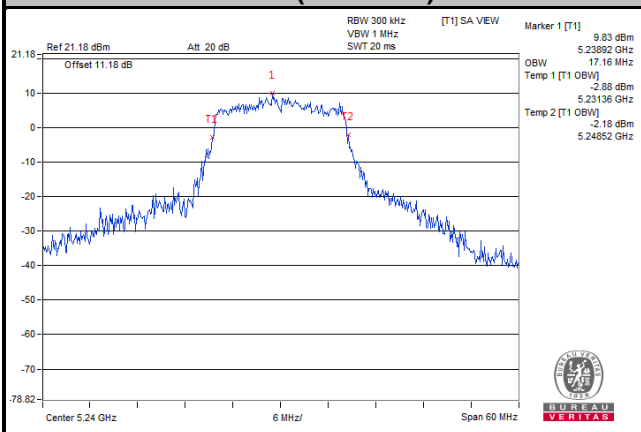

Ch 149 (5745 MHz)

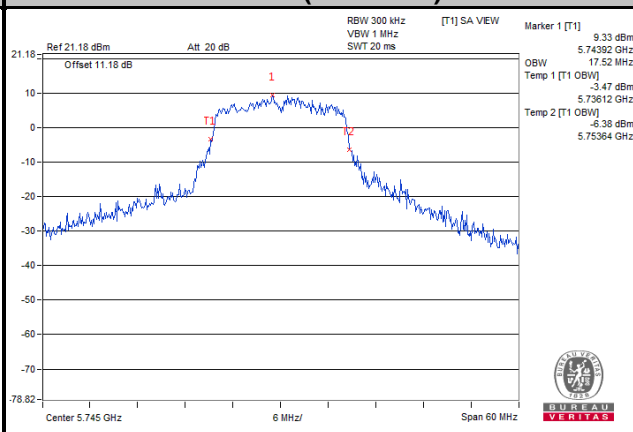



BUREAU VERITAS

802.11n (HT20)

Ch 48 (5240 MHz)

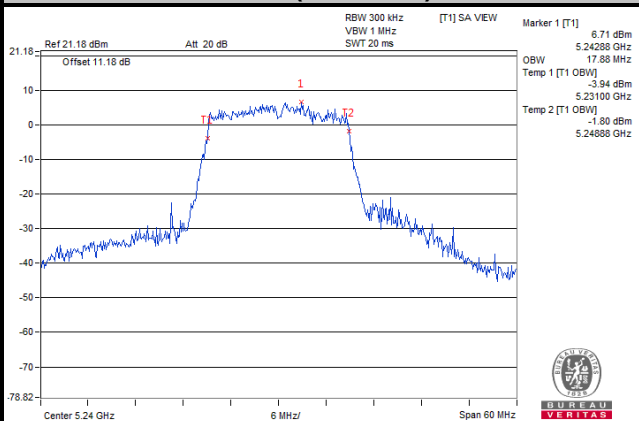

Ch 149 (5745 MHz)

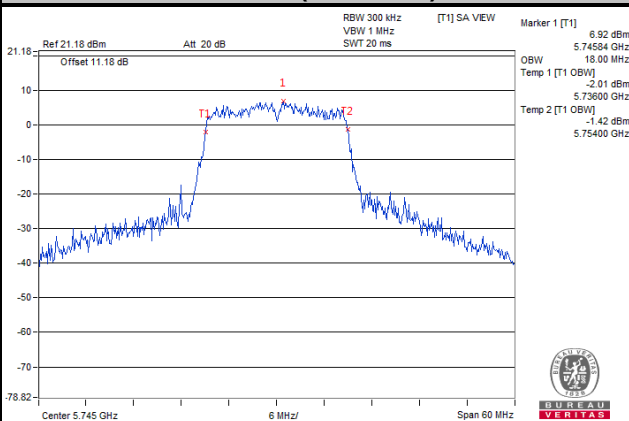

802.11n (HT40)

Ch 46 (5230 MHz)

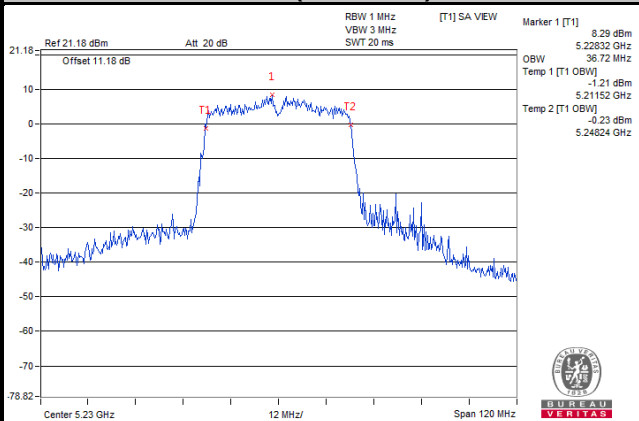

Ch 151 (5755 MHz)

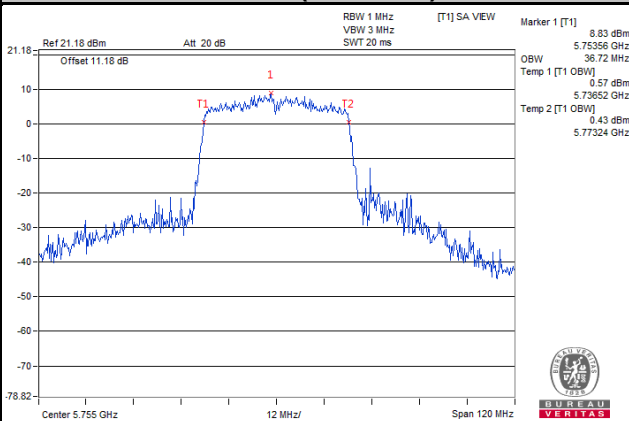

802.11ac (VHT80)

Ch 42 (5210 MHz)

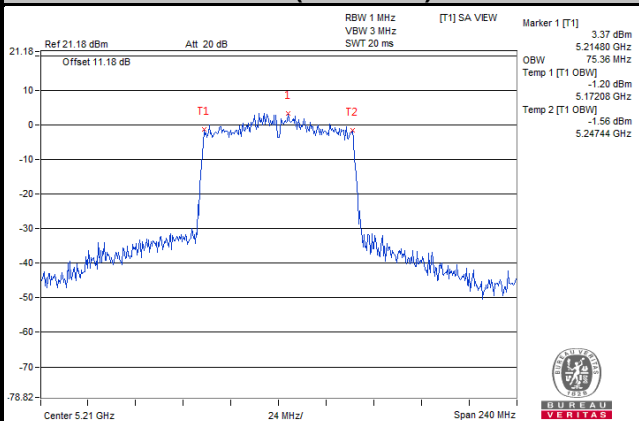

Ch 155 (5775 MHz)

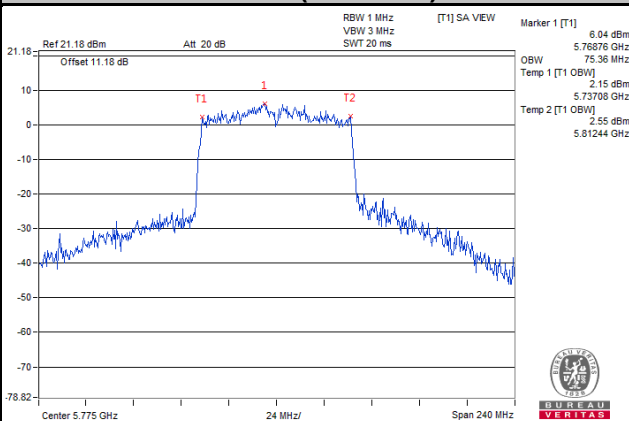

4.5 Peak Power Spectral Density Measurement

4.5.1 Limits of Peak Power Spectral Density Measurement

Operation Band	EUT Category		Limit
U-NII-1		Outdoor Access Point	17 dBm/MHz
		Fixed point-to-point Access Point	
		Indoor Access Point	
	√	Mobile and Portable client device	11 dBm/MHz
U-NII-2A		√	11 dBm/MHz
U-NII-2C		√	11 dBm/MHz
U-NII-3		√	30 dBm/500 kHz

4.5.2 Test Setup

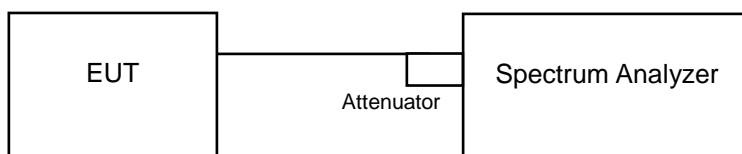

4.5.3 Test Instruments

Refer to section 4.1.2 to get information of above instrument.

4.5.4 Test Procedures

For U-NII-1, U-NII-2A, U-NII-2C band:

Using method SA-2

1. Set span to encompass the entire emission bandwidth (EBW) of the signal.
2. Set RBW = 1 MHz, Set VBW \geq 3 RBW, Detector = RMS
3. Sweep time = auto, trigger set to "free run".
4. Trace average at least 100 traces in power averaging mode.
5. Record the max value and add $10 \log(1/\text{duty cycle})$

※ For U-NII-3:

1. Set span to encompass the entire emission bandwidth (EBW) of the signal.
2. Set RBW = 300 kHz, Set VBW \geq 1 RBW, Detector = RMS
3. Use the peak marker function to determine the maximum power level in any 300 kHz band segment within the fundamental EBW.
4. Scale the observed power level to an equivalent value in 500 kHz by adjusting (increasing) the measured power by a bandwidth correction factor (BWCF) where $BWCF = 10\log(500 \text{ kHz} / 300 \text{ kHz})$.
5. Sweep time = auto, trigger set to "free run".
6. Trace average at least 100 traces in power averaging mode.
7. Record the max value and add $10 \log (1/\text{duty cycle})$

4.5.5 Deviation from Test Standard

No deviation.

4.5.6 EUT Operating Conditions

The software provided by client to enable the EUT under transmission condition continuously at lowest, middle and highest channel frequencies individually.

4.5.7 Test Results

For U-NII-1, U-NII-2A, U-NII-2C Band

802.11a

Channel	Frequency (MHz)	PSD w/o Duty Factor (dBm/MHz)	Duty Factor (dB)	PSD with Duty Factor (dBm/MHz)	Maximum Limit (dBm/MHz)	Pass / Fail
36	5180	1.73	0.30	2.03	11	Pass
40	5200	4.89	0.30	5.19	11	Pass
48	5240	5.01	0.30	5.31	11	Pass
52	5260	4.93	0.30	5.23	11	Pass
60	5300	4.44	0.30	4.74	11	Pass
64	5320	1.99	0.30	2.29	11	Pass
100	5500	1.75	0.30	2.05	11	Pass
116	5580	3.76	0.30	4.06	11	Pass
140	5700	1.90	0.30	2.20	11	Pass

Note: Refer to section 3.3 for duty cycle spectrum plot.

802.11n (HT20)

Channel	Frequency (MHz)	PSD w/o Duty Factor (dBm/MHz)	Duty Factor (dB)	PSD with Duty Factor (dBm/MHz)	Maximum Limit (dBm/MHz)	Pass / Fail
36	5180	1.77	0.32	2.09	11	Pass
40	5200	4.63	0.32	4.95	11	Pass
48	5240	4.63	0.32	4.95	11	Pass
52	5260	4.54	0.32	4.86	11	Pass
60	5300	4.27	0.32	4.59	11	Pass
64	5320	1.30	0.32	1.62	11	Pass
100	5500	1.76	0.32	2.08	11	Pass
116	5580	4.40	0.32	4.72	11	Pass
140	5700	2.10	0.32	2.42	11	Pass

Note: Refer to section 3.3 for duty cycle spectrum plot.

802.11n (HT40)

Channel	Frequency (MHz)	PSD w/o Duty Factor (dBm/MHz)	Duty Factor (dB)	PSD with Duty Factor (dBm/MHz)	Maximum Limit (dBm/MHz)	Pass / Fail
38	5190	-3.42	0.62	-2.80	11	Pass
46	5230	-2.22	0.62	-1.60	11	Pass
54	5270	-2.58	0.62	-1.96	11	Pass
62	5310	-2.80	0.62	-2.18	11	Pass
102	5510	-2.06	0.62	-1.44	11	Pass
110	5550	-2.43	0.62	-1.81	11	Pass
134	5670	-2.67	0.62	-2.05	11	Pass

Note: Refer to section 3.3 for duty cycle spectrum plot.

802.11ac (VHT80)

Channel	Frequency (MHz)	PSD w/o Duty Factor (dBm/MHz)	Duty Factor (dB)	PSD with Duty Factor (dBm/MHz)	Maximum Limit (dBm/MHz)	Pass / Fail
42	5210	-6.85	1.17	-5.68	11	Pass
58	5290	-7.07	1.17	-5.90	11	Pass
106	5530	-7.68	1.17	-6.51	11	Pass
122	5610	-4.65	1.17	-3.48	11	Pass

Note: Refer to section 3.3 for duty cycle spectrum plot.

Spectrum Plot of Worst Value

802.11a

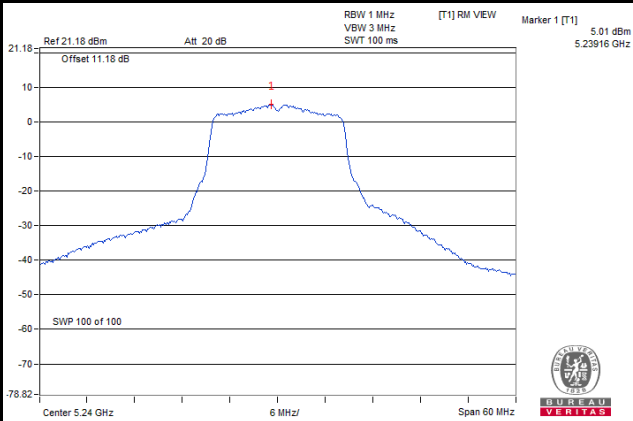

802.11n (HT20)

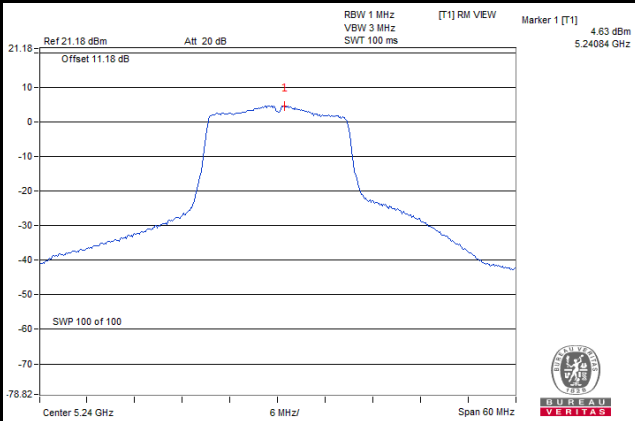

802.11n (HT40)

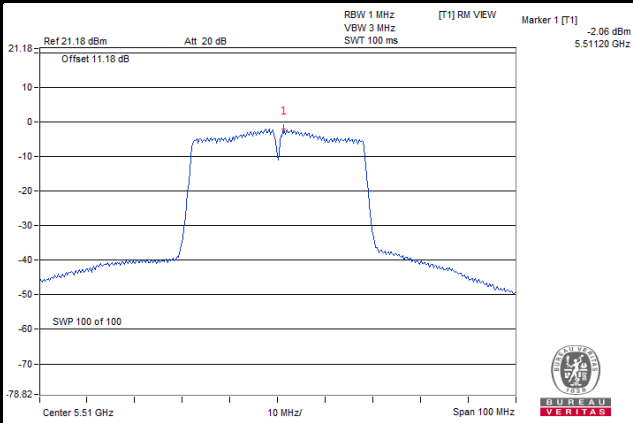

802.11ac (VHT80)

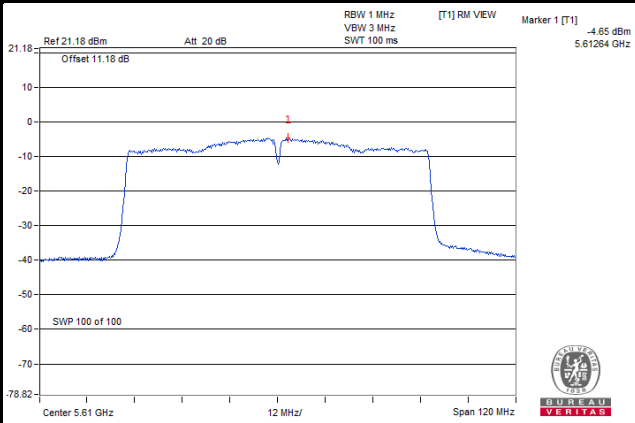

For U-NII-3 Band

802.11a

Channel	Frequency (MHz)	PSD w/o Duty Factor		Duty Factor (dB)	PSD with Duty Factor (dBm/500 kHz)	Limit (dBm/500 kHz)	Pass / Fail
		(dBm/300 kHz)	(dBm/500 kHz)				
149	5745	-3.08	-0.86	0.30	-0.56	30	Pass
157	5785	-3.14	-0.92	0.30	-0.62	30	Pass
165	5825	-3.4	-1.18	0.30	-0.88	30	Pass

Note: Refer to section 3.3 for duty cycle spectrum plot.

802.11n (HT20)

Channel	Frequency (MHz)	PSD w/o Duty Factor		Duty Factor (dB)	PSD with Duty Factor (dBm/500 kHz)	Limit (dBm/500 kHz)	Pass / Fail
		(dBm/300 kHz)	(dBm/500 kHz)				
149	5745	-3.64	-1.42	0.32	-1.1	30	Pass
157	5785	-3.47	-1.25	0.32	-0.93	30	Pass
165	5825	-3.1	-0.88	0.32	-0.56	30	Pass

Note: Refer to section 3.3 for duty cycle spectrum plot.

802.11n (HT40)

Channel	Frequency (MHz)	PSD w/o Duty Factor		Duty Factor (dB)	PSD with Duty Factor (dBm/500 kHz)	Limit (dBm/500 kHz)	Pass / Fail
		(dBm/300 kHz)	(dBm/500 kHz)				
151	5755	-10.37	-8.15	0.62	-7.53	30	Pass
159	5795	-10.77	-8.55	0.62	-7.93	30	Pass

Note: Refer to section 3.3 for duty cycle spectrum plot.

802.11ac (VHT80)

Channel	Frequency (MHz)	PSD w/o Duty Factor		Duty Factor (dB)	PSD with Duty Factor (dBm/500 kHz)	Limit (dBm/500 kHz)	Pass / Fail
		(dBm/300 kHz)	(dBm/500 kHz)				
155	5775	-12.68	-10.46	1.17	-9.29	30	Pass

Note: Refer to section 3.3 for duty cycle spectrum plot.

Spectrum Plot of Worst Value

802.11a

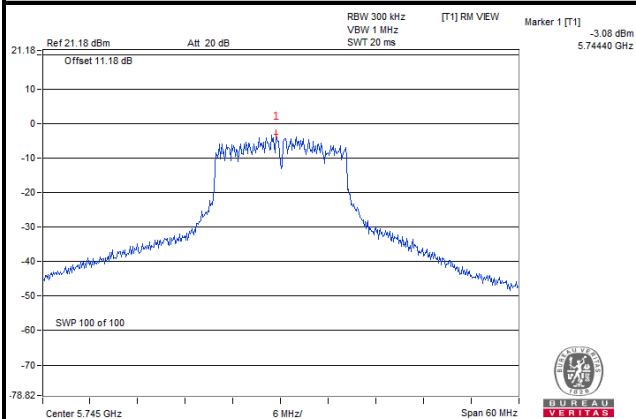

802.11n (HT20)

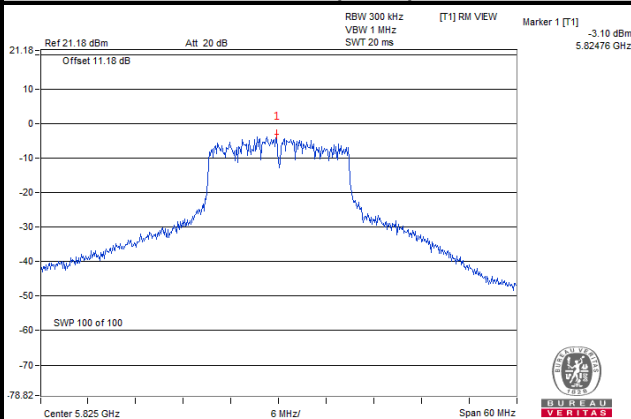

802.11n (HT40)

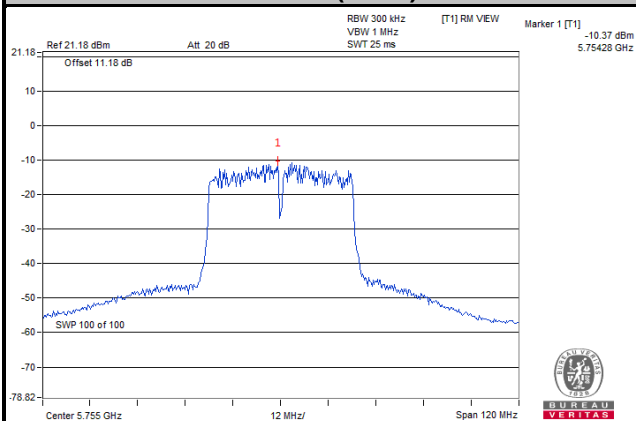

802.11ac (VHT80)

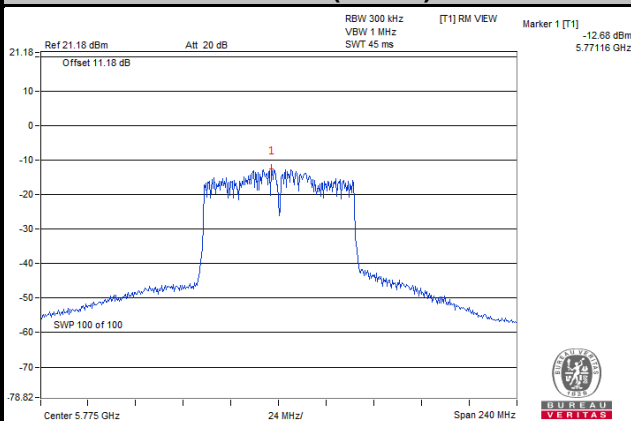

4.6 Frequency Stability

4.6.1 Limit of Frequency Stability Measurement

The frequency of the carrier signal shall be maintained within band of operation.

4.6.2 Test Setup

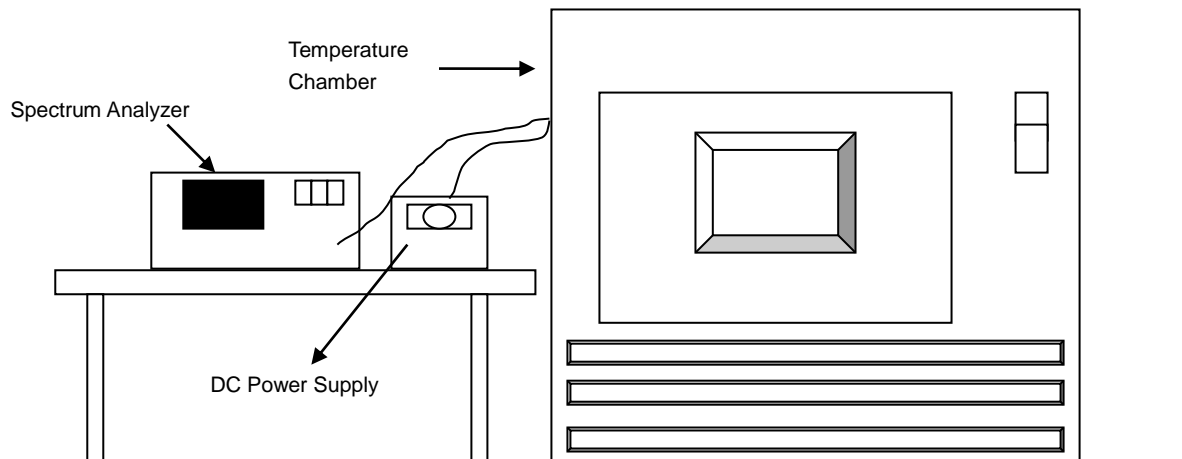

4.6.3 Test Instruments

Refer to section 4.1.2 to get information of above instrument.

4.6.4 Test Procedure

- The EUT was placed inside the environmental test chamber and powered by nominal DC voltage.
- Turn the EUT on and couple its output to a spectrum analyzer.
- Turn the EUT off and set the chamber to the highest temperature specified.
- Allow sufficient time (approximately 30 min) for the temperature of the chamber to stabilize, turn the EUT on and measure the operating frequency after 2, 5, and 10 Minutes.
- Repeat step (d) with the temperature chamber set to the next desired temperature until measurements down to the lowest specified temperature have been completed.
- The test chamber was allowed to stabilize at +20 degree C for a minimum of 30 Minutes. The supply voltage was then adjusted on the EUT from 85% to 115% and the frequency record.

4.6.5 Deviation from Test Standard

No deviation.

4.6.6 EUT Operating Condition

Set the EUT transmit at un-modulation mode to test frequency stability.

4.6.7 Test Results

Frequency Stability Versus Temp.									
Operating Frequency: 5180 MHz									
Temp. (°C)	Power Supply (Vdc)	0 Minute		2 Minute		5 Minute		10 Minute	
		Measured Frequency (MHz)	Result	Measured Frequency (MHz)	Result	Measured Frequency (MHz)	Result	Measured Frequency (MHz)	Result
85	12	5179.9809	PASS	5179.98	PASS	5179.9799	PASS	5179.9773	PASS
80	12	5179.9893	PASS	5179.9898	PASS	5179.9863	PASS	5179.9869	PASS
70	12	5180.0043	PASS	5180.0064	PASS	5180.007	PASS	5180.0061	PASS
60	12	5180.0206	PASS	5180.0202	PASS	5180.0227	PASS	5180.0185	PASS
50	12	5179.9916	PASS	5179.9903	PASS	5179.9888	PASS	5179.9925	PASS
40	12	5179.9873	PASS	5179.9887	PASS	5179.9845	PASS	5179.9864	PASS
30	12	5180.0134	PASS	5180.0146	PASS	5180.0151	PASS	5180.0131	PASS
20	12	5180.016	PASS	5180.017	PASS	5180.0189	PASS	5180.0164	PASS
10	12	5179.9904	PASS	5179.9904	PASS	5179.9902	PASS	5179.9901	PASS
0	12	5180.0044	PASS	5180.0079	PASS	5180.0072	PASS	5180.0056	PASS
-10	12	5180.0062	PASS	5180.0094	PASS	5180.0073	PASS	5180.0075	PASS
-20	12	5179.9964	PASS	5180.001	PASS	5179.9999	PASS	5179.9985	PASS
-30	12	5180.0115	PASS	5180.0107	PASS	5180.0135	PASS	5180.0128	PASS
-40	12	5179.9972	PASS	5179.993	PASS	5179.9953	PASS	5179.9932	PASS

Frequency Stability Versus Voltage									
Operating Frequency: 5180 MHz									
Temp. (°C)	Power Supply (Vdc)	0 Minute		2 Minute		5 Minute		10 Minute	
		Measured Frequency (MHz)	Result	Measured Frequency (MHz)	Result	Measured Frequency (MHz)	Result	Measured Frequency (MHz)	Result
20	13.8	5180.0166	PASS	5180.0176	PASS	5180.0196	PASS	5180.0159	PASS
	12	5180.016	PASS	5180.017	PASS	5180.0189	PASS	5180.0164	PASS
	10.2	5180.0155	PASS	5180.0169	PASS	5180.0192	PASS	5180.0166	PASS

4.7 6 dB Bandwidth Measurement

4.7.1 Limits of 6 dB Bandwidth Measurement

The minimum of 6 dB Bandwidth Measurement is 0.5 MHz.

4.7.2 Test Setup



4.7.3 Test Instruments

Refer to section 4.1.2 to get information of above instrument.

4.7.4 Test Procedure

MEASUREMENT PROCEDURE REF

- Set resolution bandwidth (RBW) = 100 kHz
- Set the video bandwidth (VBW) $\geq 3 \times$ RBW, Detector = Peak.
- Trace mode = max hold.
- Sweep = auto couple.
- Measure the maximum width of the emission that is constrained by the frequencies associated with the two amplitude points (upper and lower) that are attenuated by 6 dB relative to the maximum level measured in the fundamental emission

4.7.5 Deviation from Test Standard

No deviation.

4.7.6 EUT Operating Condition

The software provided by client to enable the EUT under transmission condition continuously at lowest, middle and highest channel frequencies individually.

4.7.7 Test Results

802.11a

Channel	Frequency (MHz)	6 dB Bandwidth (MHz)	Minimum Limit (MHz)	Pass / Fail
149	5745	16.37	0.5	Pass
157	5785	16.14	0.5	Pass
165	5825	16.37	0.5	Pass

802.11n (HT20)

Channel	Frequency (MHz)	6 dB Bandwidth (MHz)	Minimum Limit (MHz)	Pass / Fail
149	5745	17.57	0.5	Pass
157	5785	17.31	0.5	Pass
165	5825	17.56	0.5	Pass

802.11n (HT40)

Channel	Frequency (MHz)	6 dB Bandwidth (MHz)	Minimum Limit (MHz)	Pass / Fail
151	5755	35.86	0.5	Pass
159	5795	36.22	0.5	Pass

802.11ac (VHT80)

Channel	Frequency (MHz)	6 dB Bandwidth (MHz)	Minimum Limit (MHz)	Pass / Fail
155	5775	75.64	0.5	Pass

Spectrum Plot of Worst Value

802.11a

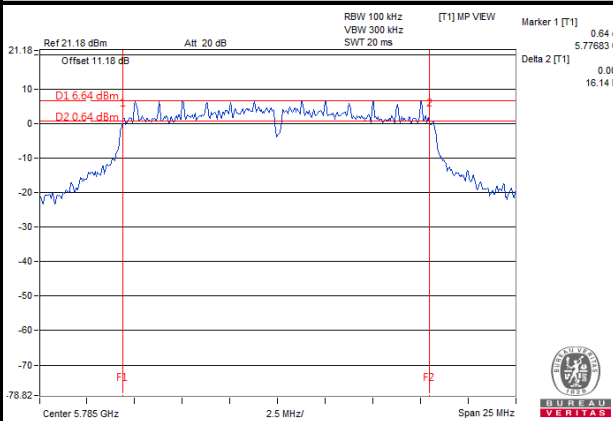

802.11n (HT20)

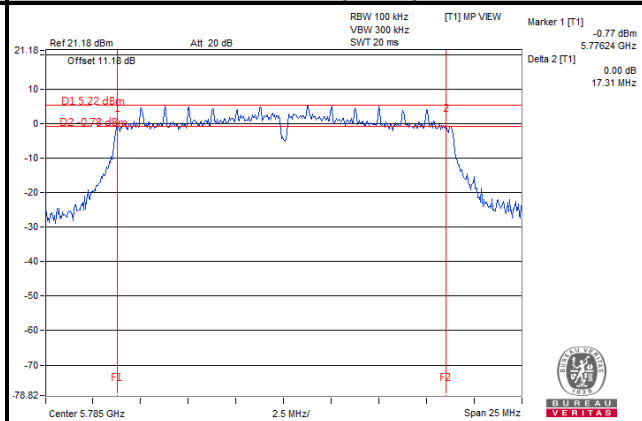

802.11n (HT40)

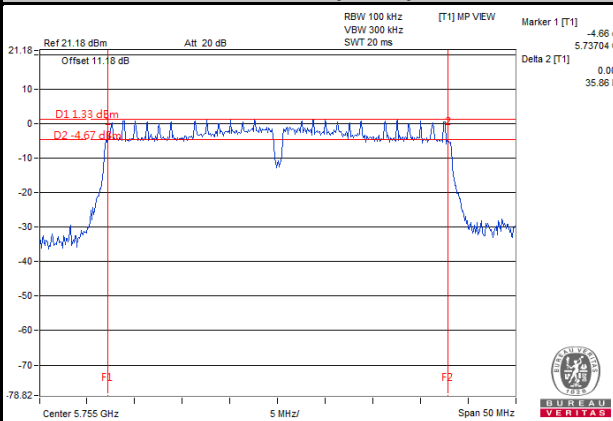

802.11ac (VHT80)

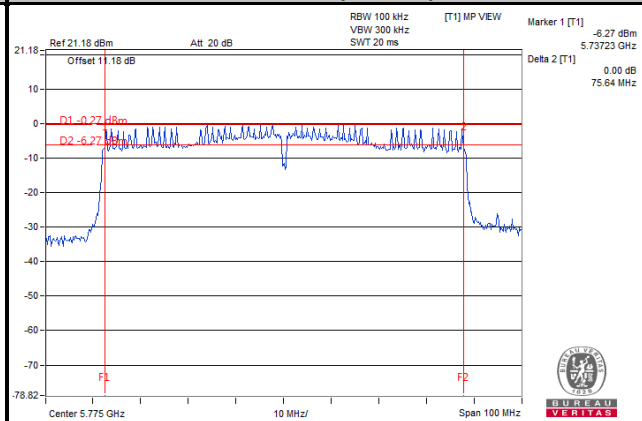

5 Pictures of Test Arrangements

Please refer to the attached file (Test Setup Photo).

Annex A- Radiated Out of Band Emission (OOBE) Measurement (For U-NII-3 band)

802.11a

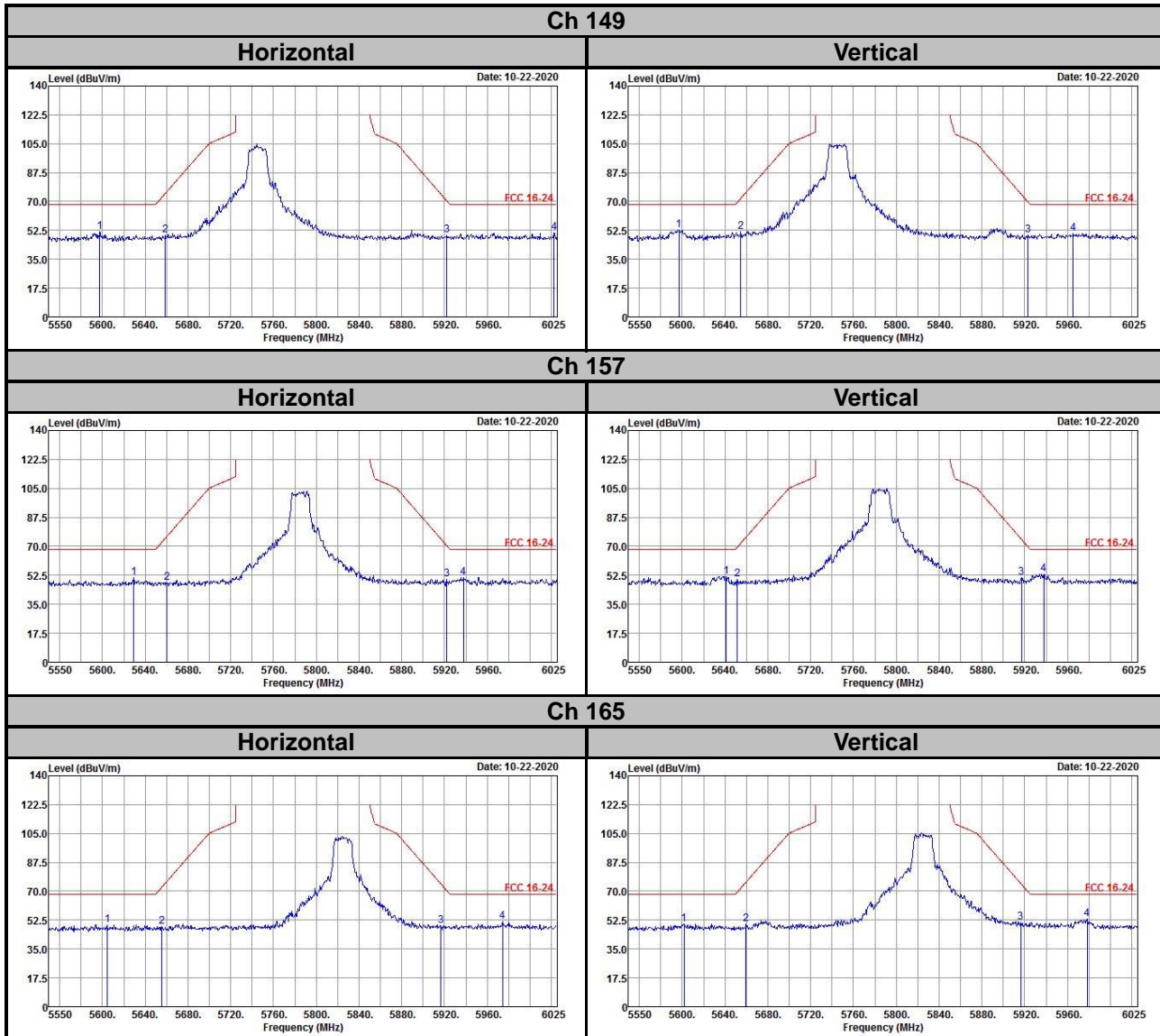

802.11n (HT20)

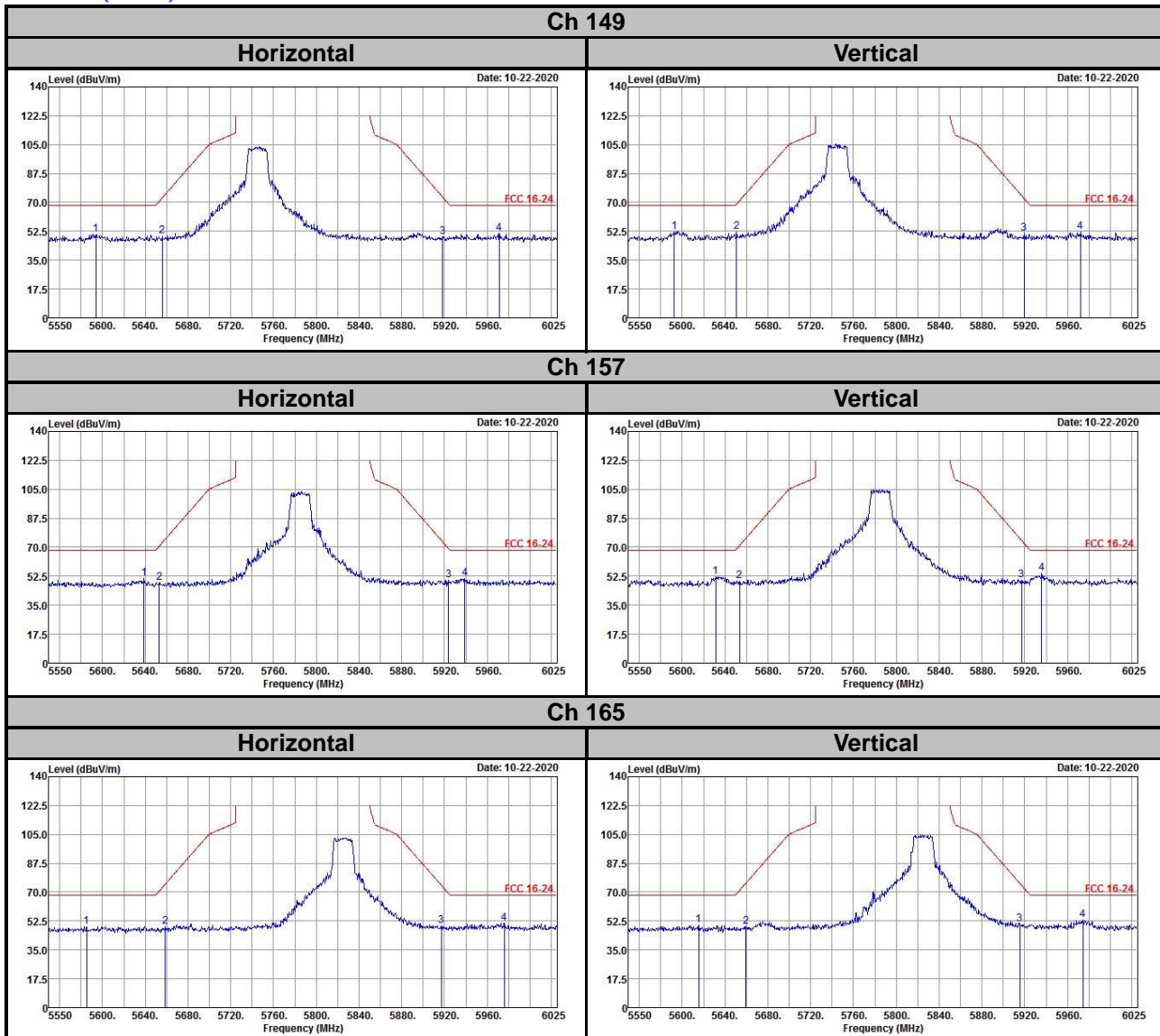

802.11n (HT40)

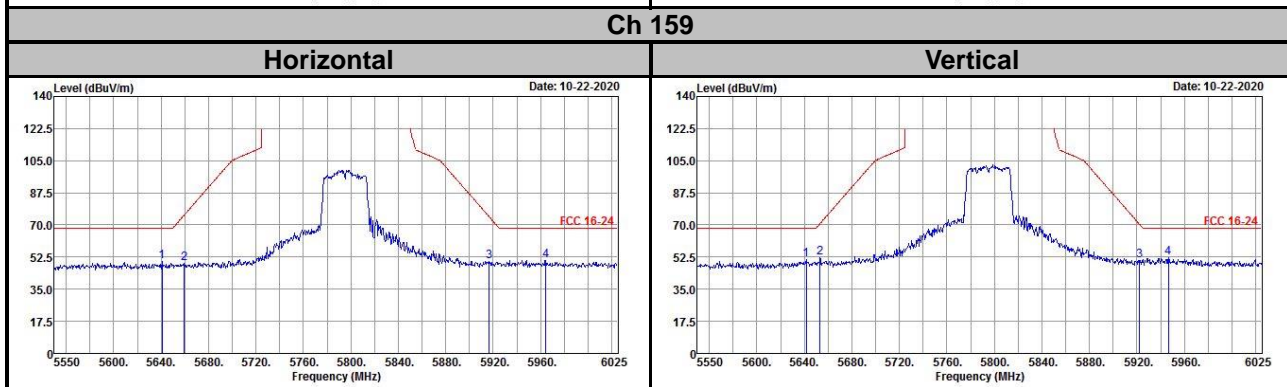
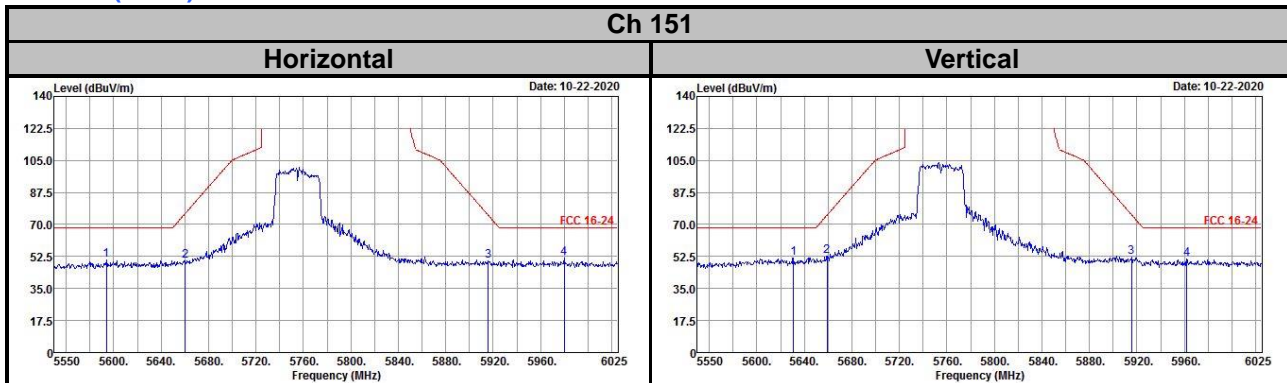

802.11ac (VHT80)

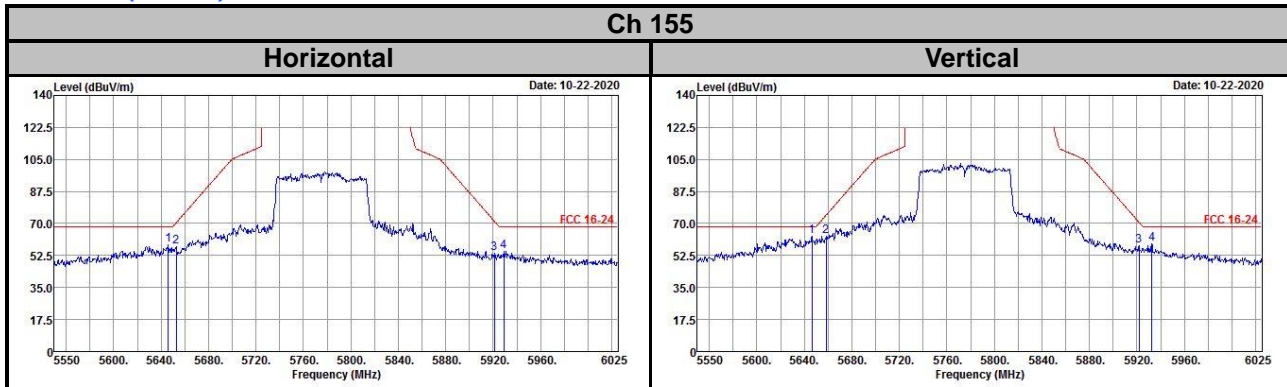

Annex B- Band Edge Measurement

802.11a

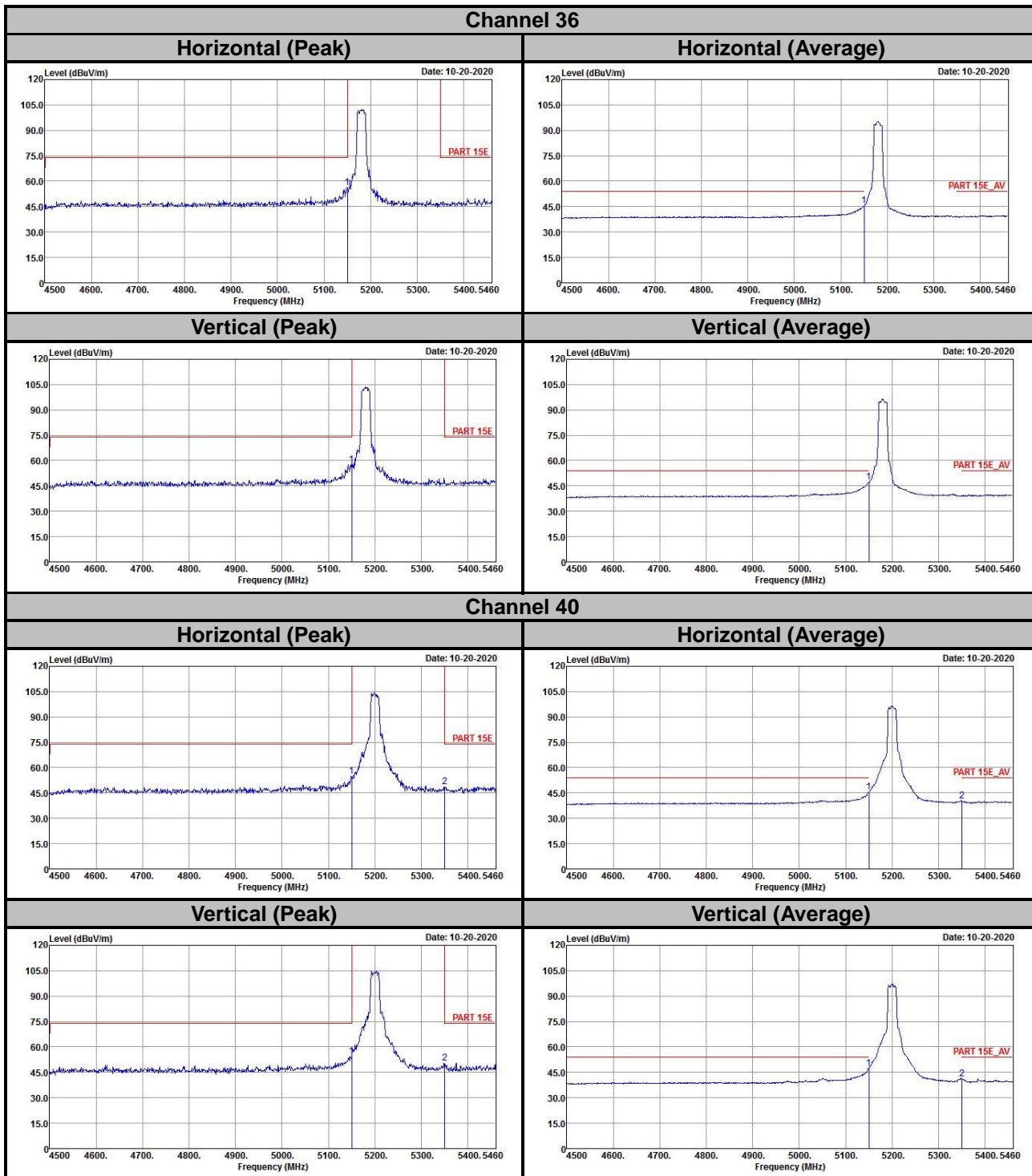

Channel 48

Horizontal (Peak)

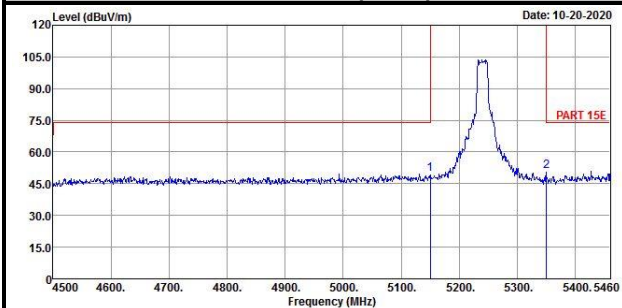

Horizontal (Average)

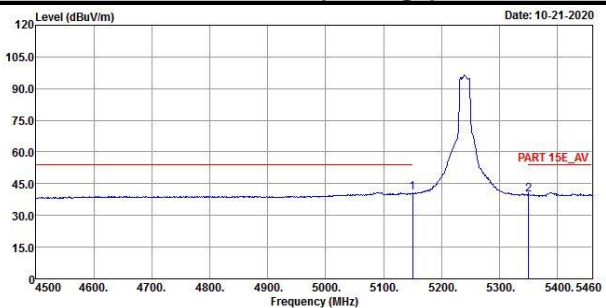

Vertical (Peak)

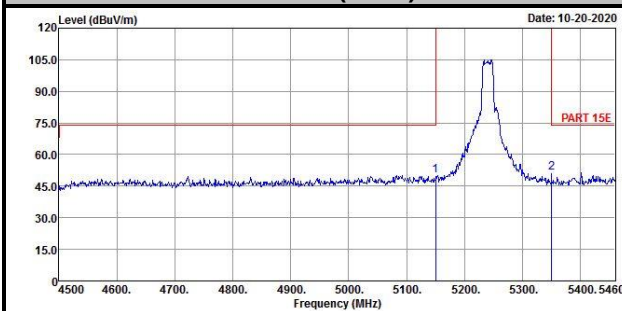

Vertical (Average)

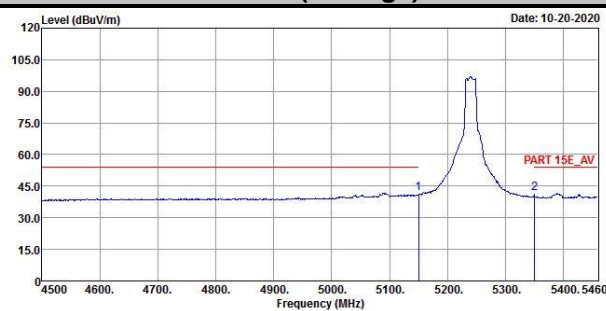

802.11n (HT20)

Channel 36

Horizontal (Peak)

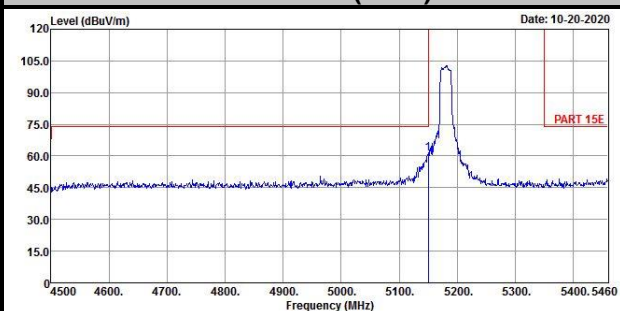

Horizontal (Average)

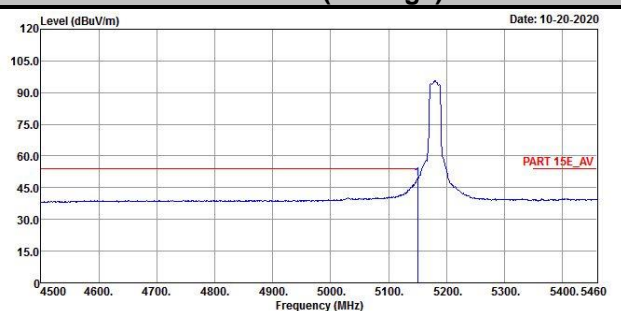

Vertical (Peak)

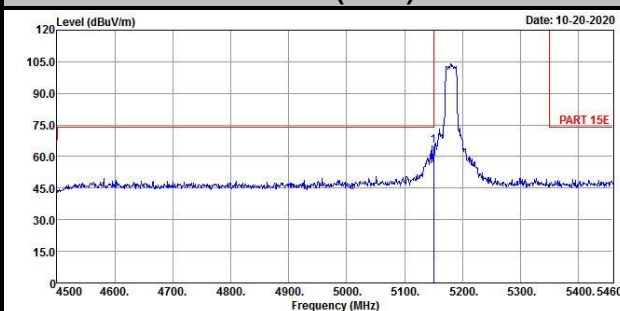

Vertical (Average)

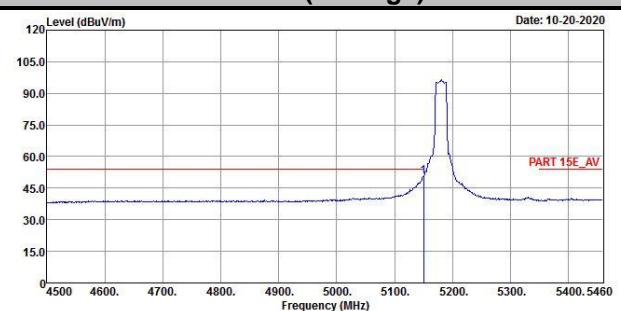

Channel 40

Horizontal (Peak)

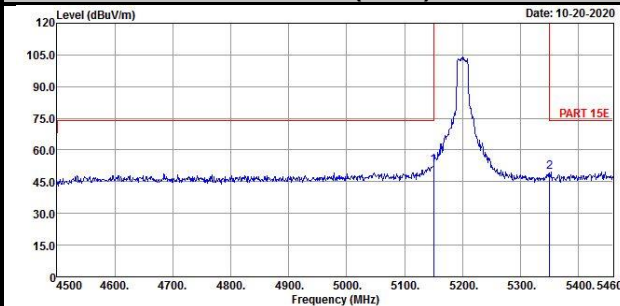

Horizontal (Average)

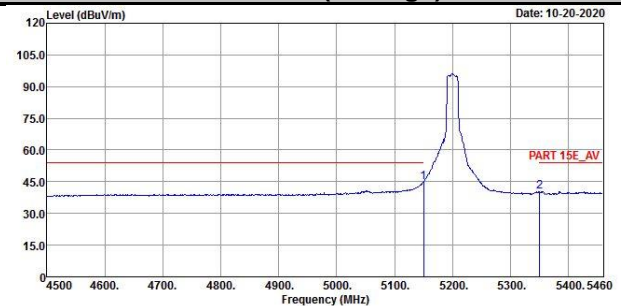

Vertical (Peak)

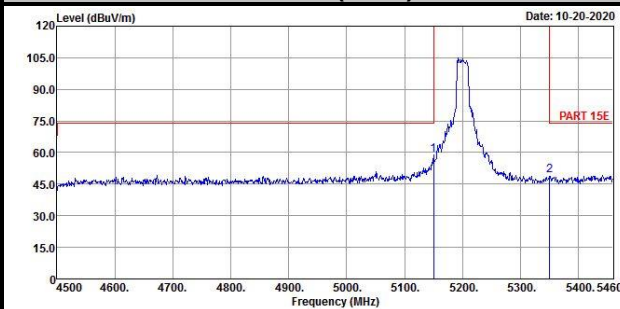

Vertical (Average)

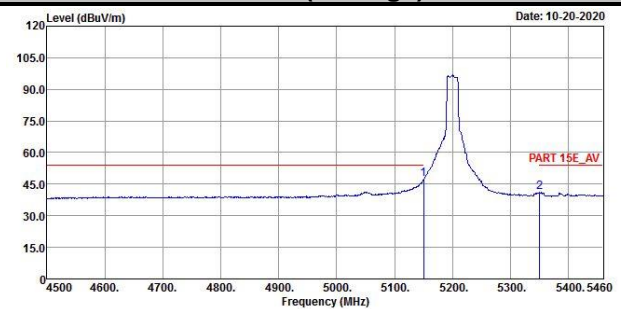

Channel 48

Horizontal (Peak)

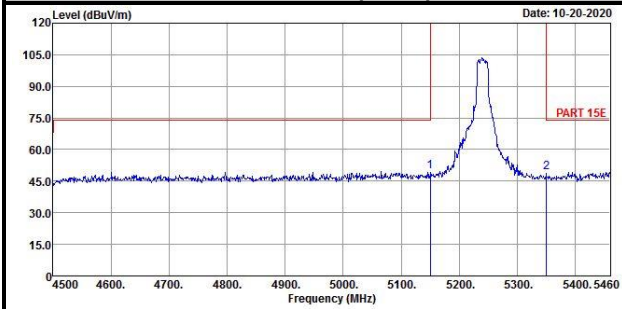

Horizontal (Average)

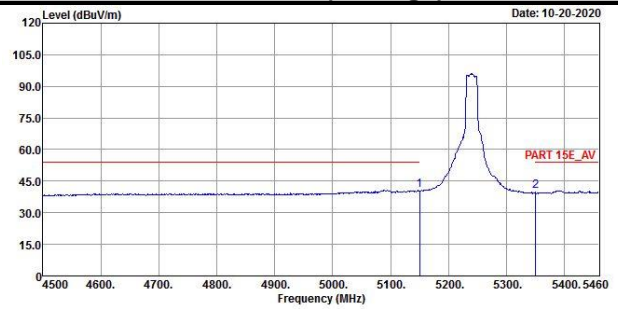

Vertical (Peak)

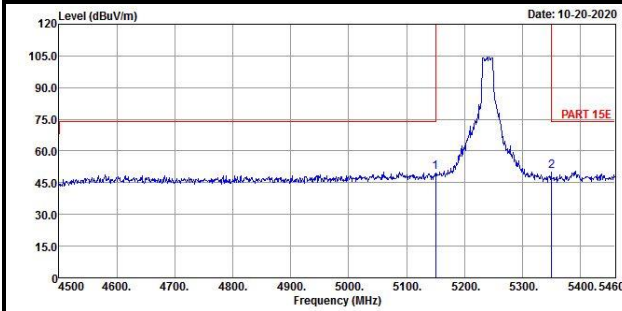

Vertical (Average)

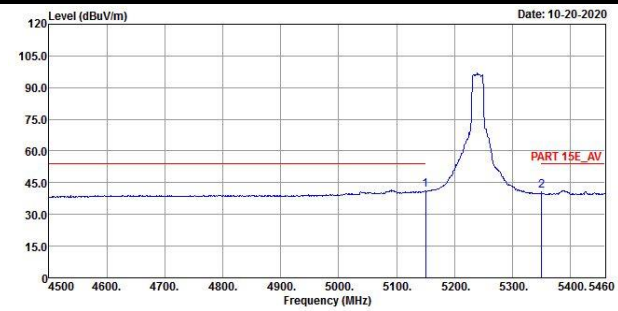

802.11n (HT40)

Channel 38

Horizontal (Peak)

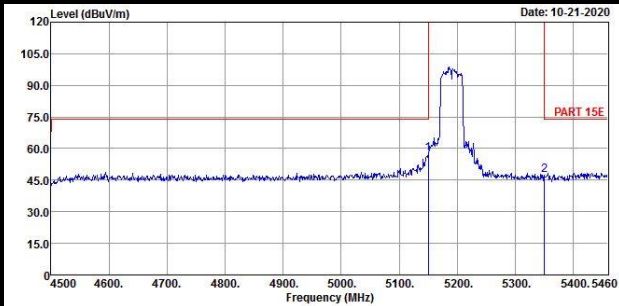

Horizontal (Average)

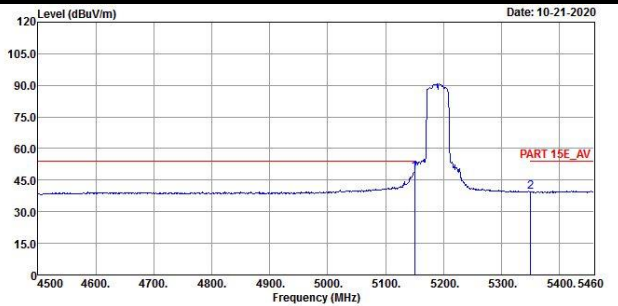

Vertical (Peak)

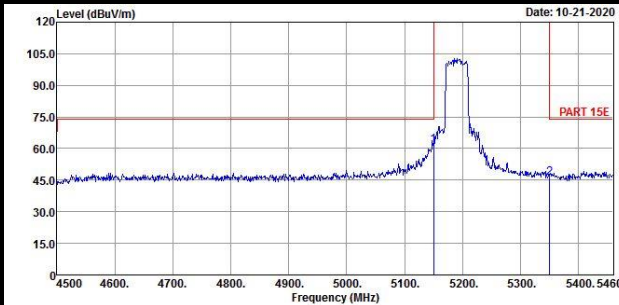

Vertical (Average)

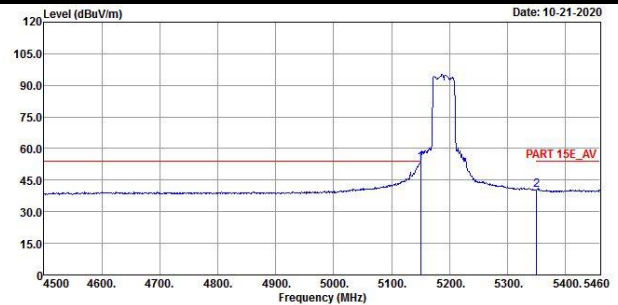

Channel 46

Horizontal (Peak)

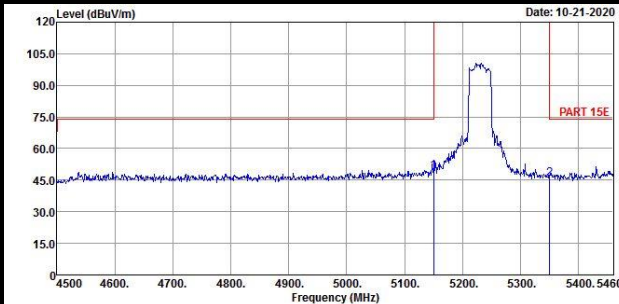

Horizontal (Average)

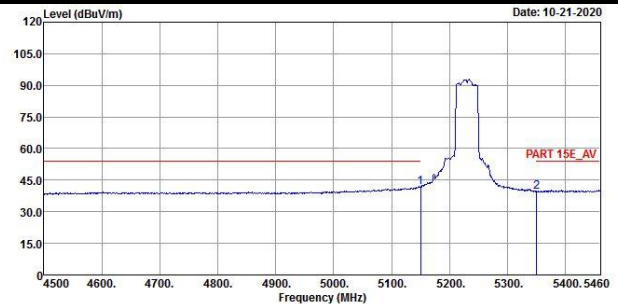

Vertical (Peak)

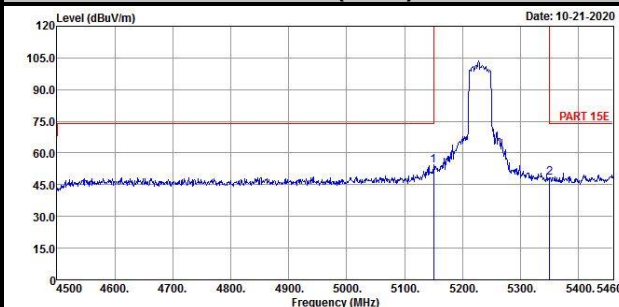

Vertical (Average)

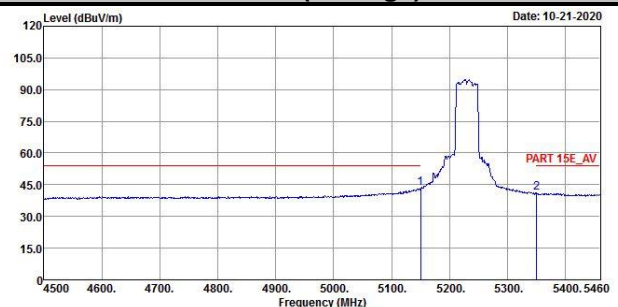

802.11ac (VHT80)

Channel 42

Horizontal (Peak)

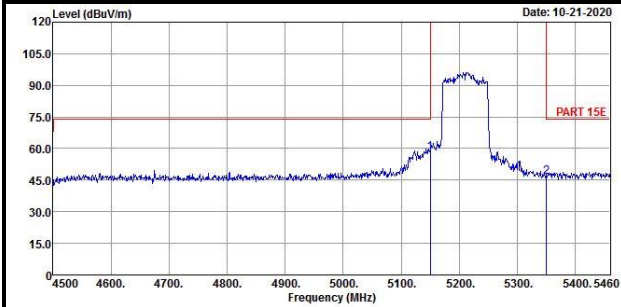

Horizontal (Average)

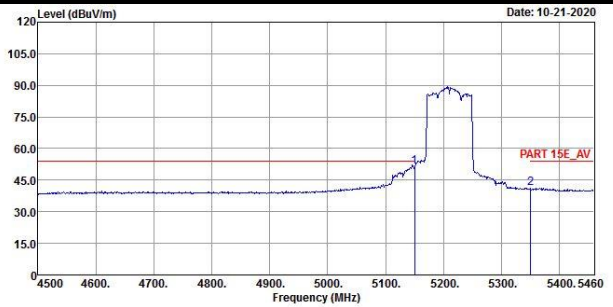

Vertical (Peak)

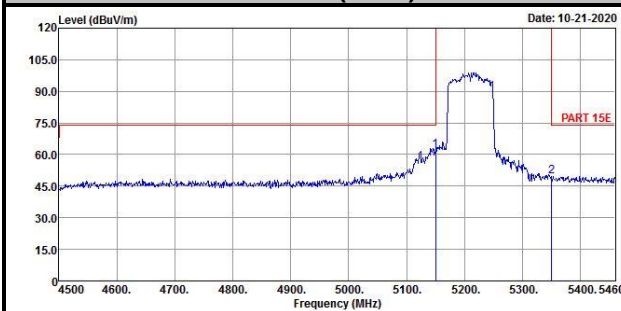

Vertical (Average)

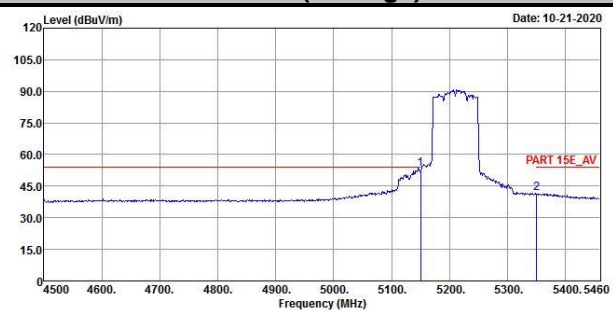

Appendix – Information of the Testing Laboratories

We, Bureau Veritas Consumer Products Services (H.K.) Ltd., Taoyuan Branch, were founded in 1988 to provide our best service in EMC, Radio, Telecom and Safety consultation. Our laboratories are FCC recognized accredited test firms and accredited according to ISO/IEC 17025.

If you have any comments, please feel free to contact us at the following:

Lin Kou EMC/RF Lab

Tel: 886-2-26052180

Fax: 886-2-26051924

Hsin Chu EMC/RF/Telecom Lab

Tel: 886-3-6668565

Fax: 886-3-6668323

Hwa Ya EMC/RF/Safety Lab

Tel: 886-3-3183232

Fax: 886-3-3270892

Email: service.adt@tw.bureauveritas.com

Web Site: www.bureauveritas-adt.com

The address and road map of all our labs can be found in our web site also.

--- END ---