



# SPORTON International Inc.

No. 52, Hwa Ya 1st Rd., Kwei-Shan Hsiang, TaoYuan Hsien, Taiwan, R.O.C.  
Ph: 886-3-327-3456 / FAX: 886-3-327-0973 / www.sporton.com.tw

## FCC RADIO TEST REPORT

Applicant's company	Wistron NeWeb Corporation
Applicant Address	No. 10-1, Li-hsin Road I, Science-baded Industrial Park, Hsinchu 300, Taiwan, R.O.C.
FCC ID	NKRUWASLV1
Manufacturer's company	Wistron NeWeb Corporation
Manufacturer Address	No. 10-1, Li-hsin Road I, Science-baded Industrial Park, Hsinchu 300, Taiwan, R.O.C.

Product Name	Satellite Radio receiver Car Dock
Brand Name	Sirius
Model Name	SLV1
Test Rule Part(s)	47 CFR FCC Part 15 Subpart C § 15.239
Test Freq. Range	88 ~ 108MHz
Receive Date	Jul. 4, 2006
Final Test Date	Sep. 19, 2006
Submission Type	Original Equipment

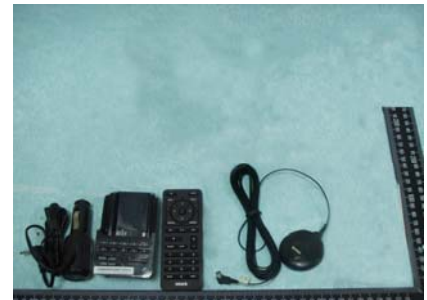

### Statement

The test result in this report refers exclusively to the presented test model / sample.

Without written approval of SPORTON International Inc., the test report shall not be reproduced except in full.

The measurements and test results shown in this test report were made in accordance with the procedures and found in compliance with the limit given in **ANSI C63.4-2003** and **47 CFR FCC Part 15 Subpart C**.

The test equipment used to perform the test is calibrated and traceable to NML/ROC.

## Table of Contents

<b>1. CERTIFICATE OF COMPLIANCE .....</b>	<b>1</b>
<b>2. SUMMARY OF THE TEST RESULT .....</b>	<b>2</b>
<b>3. GENERAL INFORMATION .....</b>	<b>3</b>
3.1. Product Details.....	3
3.2. Accessories.....	3
3.3. Table for Carrier Frequencies .....	3
3.4. Table for Test Modes.....	4
3.5. Table for Testing Locations.....	4
3.6. Table for Supporting Units .....	5
3.7. Test Configurations .....	5
<b>4. TEST RESULT .....</b>	<b>6</b>
4.1. Field Strength of Fundamental Emissions Measurement .....	6
4.2. 20dB Spectrum Bandwidth Measurement .....	14
4.3. Radiated Emissions Measurement .....	17
4.4. Band Edge Emissions Measurement .....	26
4.5. Antenna Requirements .....	30
<b>5. LIST OF MEASURING EQUIPMENTS .....</b>	<b>31</b>
<b>6. SPORTON COMPANY PROFILE .....</b>	<b>32</b>
6.1. Test Location.....	32
<b>APPENDIX A. PHOTOGRAPHS OF EUT.....</b>	<b>A1 ~ A13</b>
<b>APPENDIX B. TEST PHOTOS.....</b>	<b>B1 ~ B4</b>





## 1. CERTIFICATE OF COMPLIANCE

Product Name : Satellite Radio receiver Car Dock  
Brand Name : Sirius  
Model Name : SLV1  
Applicant : Wistron NeWeb Corporation  
Test Rule Part(s) : 47 CFR FCC Part 15 Subpart C § 15.239

Sporton International as requested by the applicant to evaluate the EMC performance of the product sample received on Jul. 4, 2006 would like to declare that the tested sample has been evaluated and found to be in compliance with the tested rule parts. The data recorded as well as the test configuration specified is true and accurate for showing the sample's EMC nature.

Sharon Jiang 19-9-06

Prepared By:

Sharon Jiang / Specialist

Steven Lu 19-9-06

Tested By:

Steven Lu / Engineer

Wayne Hsu 19-9-06

Reviewed By:

Wayne Hsu

## 2. SUMMARY OF THE TEST RESULT

Applied Standard: 47 CFR FCC Part 15 Subpart C				
Part	Rule Section	Description of Test	Result	Under Limit
-	15.207	AC Power Line Conducted Emissions	-	-
4.1	15.239(b)	Field Strength of Fundamental Emissions	Complies	2.52 dB
4.2	15.239(a)	20dB Spectrum Bandwidth	Complies	-
4.3	15.239(c)	Radiated Emissions	Complies	3.38 dB
4.4	15.239(c)	Band Edge Emissions	Complies	9.35 dB
4.5	15.203	Antenna Requirements	Complies	-

Test Items	Uncertainty	Remark
AC Power Line Conducted Emissions	$\pm 2.26\text{dB}$	Confidence levels of 95%
Field Strength of Fundamental Emissions	$\pm 3.72\text{dB}$	Confidence levels of 95%
20dB Spectrum Bandwidth	$\pm 6.25 \times 10^{-7}$	Confidence levels of 95%
Radiated Emissions/ Band Edge Emissions	$\pm 3.72\text{dB}$	Confidence levels of 95%

### 3. GENERAL INFORMATION

#### 3.1. Product Details

Items	Description
Product Type	Low Power Communication Device (FM Transmitter)
Radio Type	Intentional Transmitter
Power Type	Car charger
Interface Type	DC IN / Line OUT / Antenna connect / FM
Modulation	FM
Frequency Range	88 ~ 108MHz
Channel Number	100
Channel Band Width (99%)	74.00 kHz
Max. Field Strength	45.48 dBuV/m at 3m (Average)
Carrier Frequencies	Please refer to section 3.3
Antenna	Integrated (for FM transmitter)

#### 3.2. Accessories

Others
Cradle / SL100

#### 3.3. Table for Carrier Frequencies

Frequency Band	Channel No.	Frequency
88 ~ 108MHz	1	88.1 MHz
	2	88.3 MHz
	:	:
	50	97.9 MHz
	51	98.1 MHz
	52	98.3 MHz
	:	:
	99	107.7 MHz
	100	107.9 MHz

### 3.4. Table for Test Modes

Investigation has been done on all the possible configurations for searching the worst cases. The following table is a list of the test modes shown in this test report.

Test Items	Mode	Channel	Antenna
Field Strength of Fundamental Emissions 20dB Spectrum Bandwidth	CTX1	1/51/100	1
Radiated Emissions 9kHz~30MHz	Normal operation	51	1
Radiated Emissions 30MHz~10 <sup>th</sup> Harmonic	Normal operation	1/51/100	1
Band Edge Emissions	CTX1	1/100	1

Note:

CTX1 =Continuously transmitting and audio modulating content a range of 100 to 5000 Hz.

### 3.5. Table for Testing Locations

Test Site No.	Site Category	Location	FCC Reg. No.	IC File No.	VCCI Reg. No
03CH03-HY	SAC	Hwa Ya	101377	IC 4088	-
TH01-HY	OVEN Room	Hwa Ya	-	-	-

Open Area Test Site (OATS); Semi Anechoic Chamber (SAC); Fully Anechoic Chamber (FAC).

Please refer section 6 for Test Site Address.



### 3.6. Table for Supporting Units

Support Unit	Brand	Model	FCC ID
Speaker	Dell	A125	DoC
Main receiver	SIRIUS	SL100	NKRUWASLDKSP

### 3.7. Test Configurations

#### 3.7.1. Radiation Emissions Test Configuration

9kHz~1GHz (Normal operation)

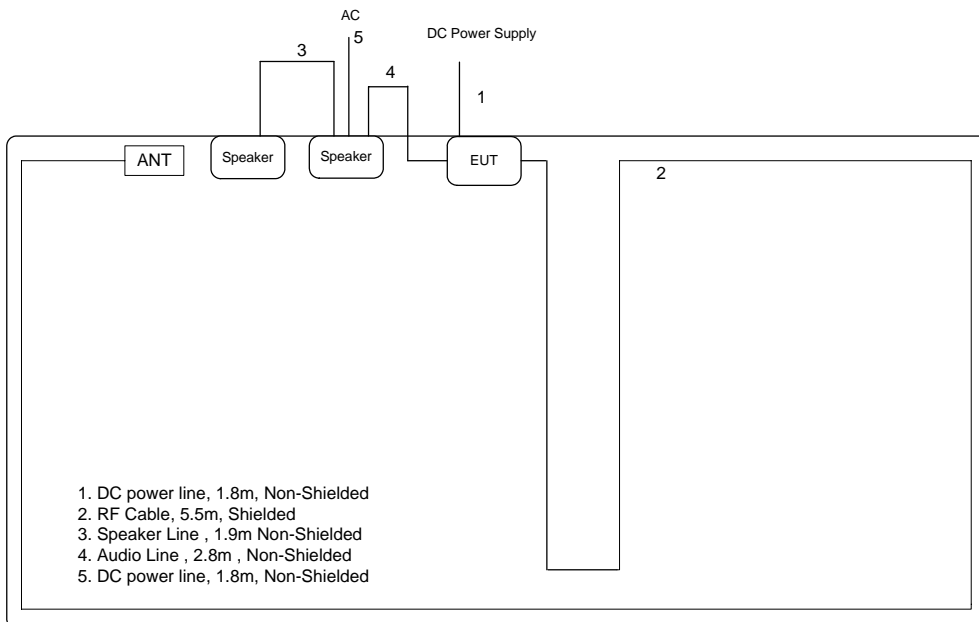

88~108MHz (CTX1)

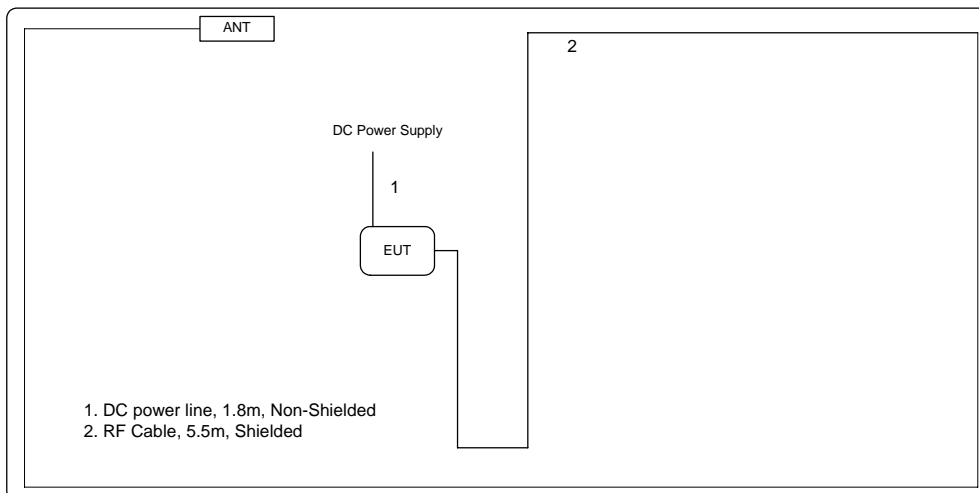



## 4. TEST RESULT

### 4.1. Field Strength of Fundamental Emissions Measurement

#### 4.1.1. Limit

The field strength of fundamental emissions shall comply with the following table.

Frequency Band (MHz)	Fundamental Emissions Limit (dBuV/m) at 3m
88~108	48 (Average)
88~108	68 (Peak)

#### 4.1.2. Measuring Instruments and Setting

Please refer to section 5 in this report. The following table is the setting of the receiver.

Receiver Parameter	Setting
Attenuation	Auto
Center Frequency	Fundamental Frequency
RB	120 KHz
Detector	Peak / Average

#### 4.1.3. Test Procedures

1. Configure the EUT according to ANSI C63.4. The EUT was placed on the top of the turntable 0.8 meter above ground. The phase center of the receiving antenna mounted on the top of a height-variable antenna tower was placed 3 meters far away from the turntable.
2. Power on the EUT and all the supporting units. The turntable was rotated by 360 degrees to determine the position of the highest radiation.
3. The height of the broadband receiving antenna was varied between one meter and four meters above ground to find the maximum emissions field strength of both horizontal and vertical polarization.
4. For each suspected emissions, the antenna tower was scan (from 1 M to 4 M) and then the turntable was rotated (from 0 degree to 360 degrees) to find the maximum reading.
5. For Fundamental emissions, use the receiver to measure peak and average reading.
6. When the radiated emissions limits are expressed in terms of the average value of the emissions, and pulsed operation is employed, the measurement field strength shall be determined by averaging over one complete pulse train, including blanking intervals, as long as the pulse train does not exceed 0.1 seconds. As an alternative (provided the transmitter operates for longer than 0.1 seconds) or in cases where the pulse train exceeds 0.1 seconds, the measured field strength shall be determined from the average absolute voltage during a 0.1 second interval during which the field strength is at its maximum value.

#### 4.1.4. Test Setup Layout

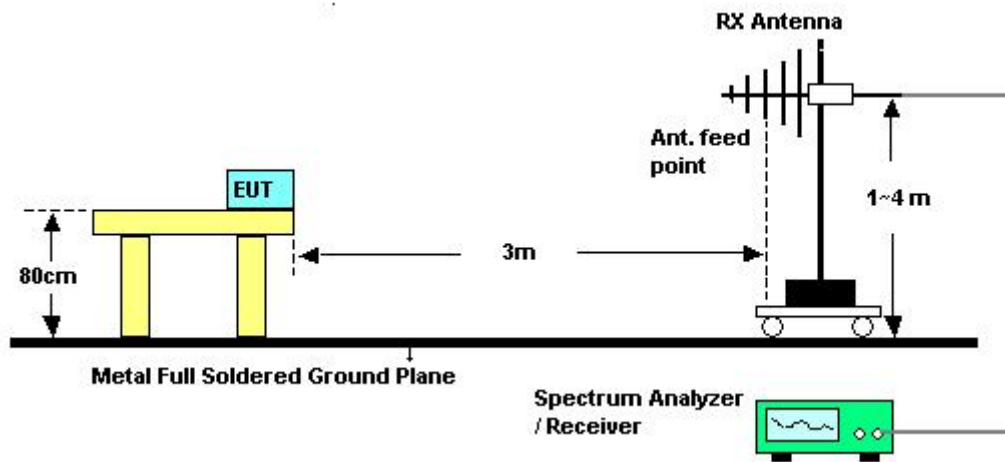

#### 4.1.5. Test Deviation

There is no deviation with the original standard.

#### 4.1.6. EUT Operation during Test

The EUT was programmed to be in continuously transmitting mode.

4.1.7. Test Result of Field Strength of Fundamental Emissions

Temperature	24°C	Humidity	64%
Test Engineer	Leo Hung	Configurations	Channel 1

Vertical

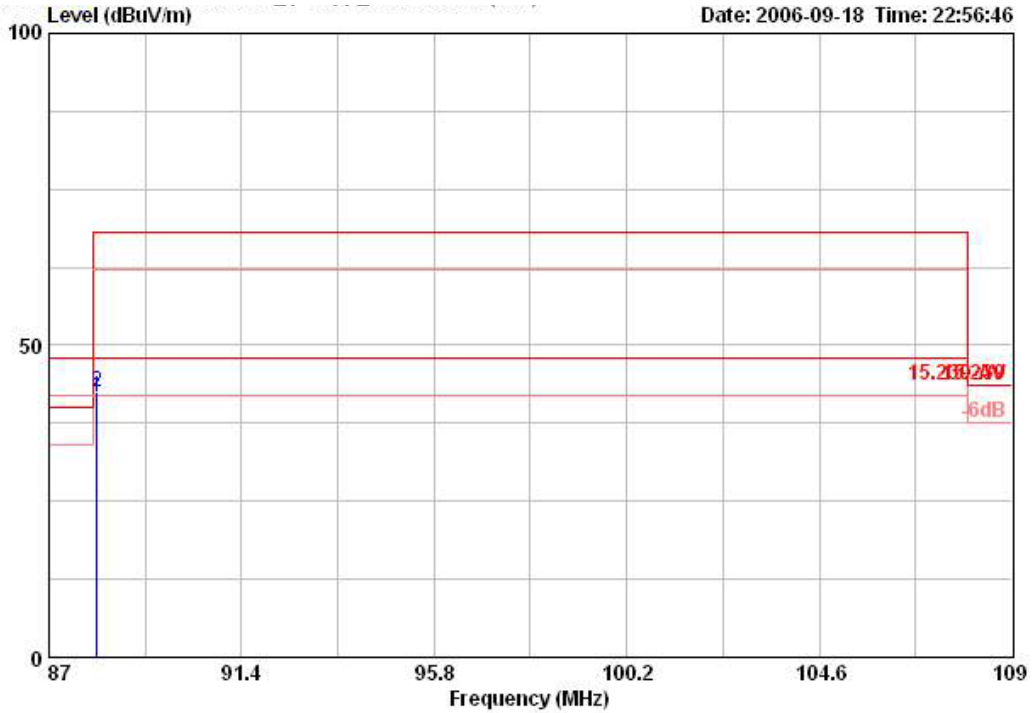

	Freq	Level	Over Limit	Limit Line	ReadAntenna Level	Antenna Factor	Cable Loss	Preamp Factor	Remark	Ant Pos	Table Pos
	MHz	dBuV/m	dB	dBuV/m	dBuV	dB/m	dB	dB		cm	deg
1 @	88.096	41.68	-6.32	48.00	58.27	8.98	0.55	26.12	AVERAGE	121	0
2	88.096	42.56	-25.44	68.00	59.15	8.98	0.55	26.12	PEAK	121	0

Horizontal

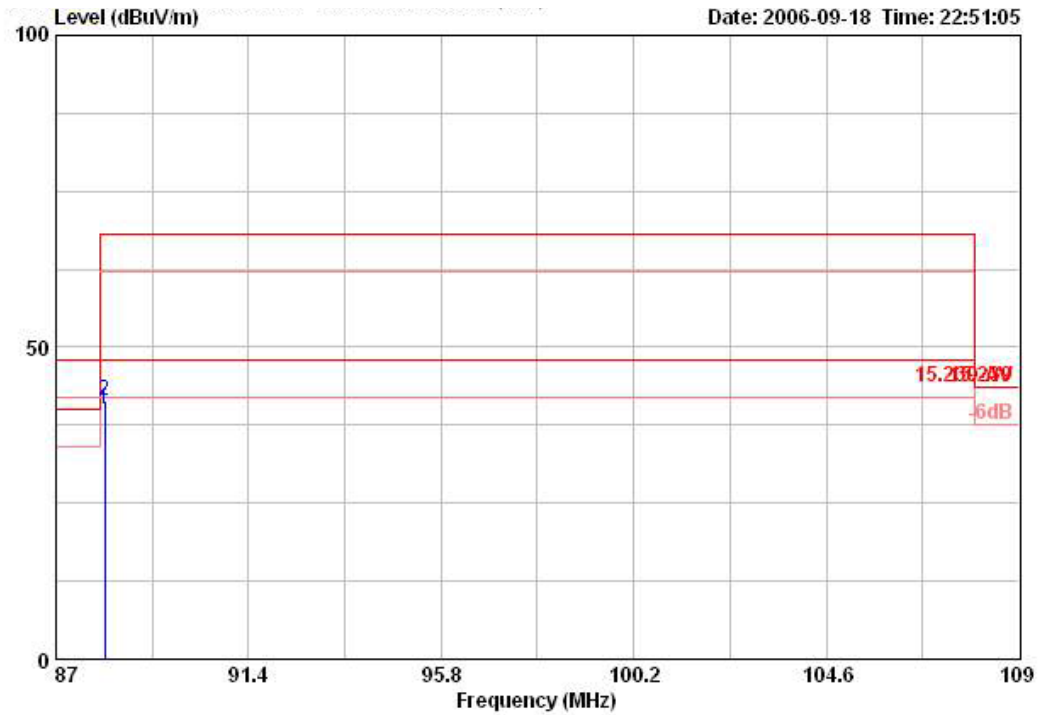

	Freq	Level	Over Limit	Limit Line	Read Level	Antenna Factor	Cable Loss	Preamp Factor	Remark	Ant Pos	Table Pos
	MHz	dBuV/m	dB	dBuV/m	dBuV	dB/m	dB	dB		cm	deg
1 @	88.107	40.03	-7.97	48.00	56.62	8.98	0.55	26.12	AVERAGE	182	301
2	88.107	41.46	-26.54	68.00	58.05	8.98	0.55	26.12	PEAK	182	301

Note:

Emission level (dBuV/m) = 20 log Emission level (uV/m)

Corrected Reading: Antenna Factor + Cable Loss + Read Level - Preamp Factor = Level

Temperature	24°C	Humidity	64%
Test Engineer	Leo Hung	Configurations	Channel 51

Vertical

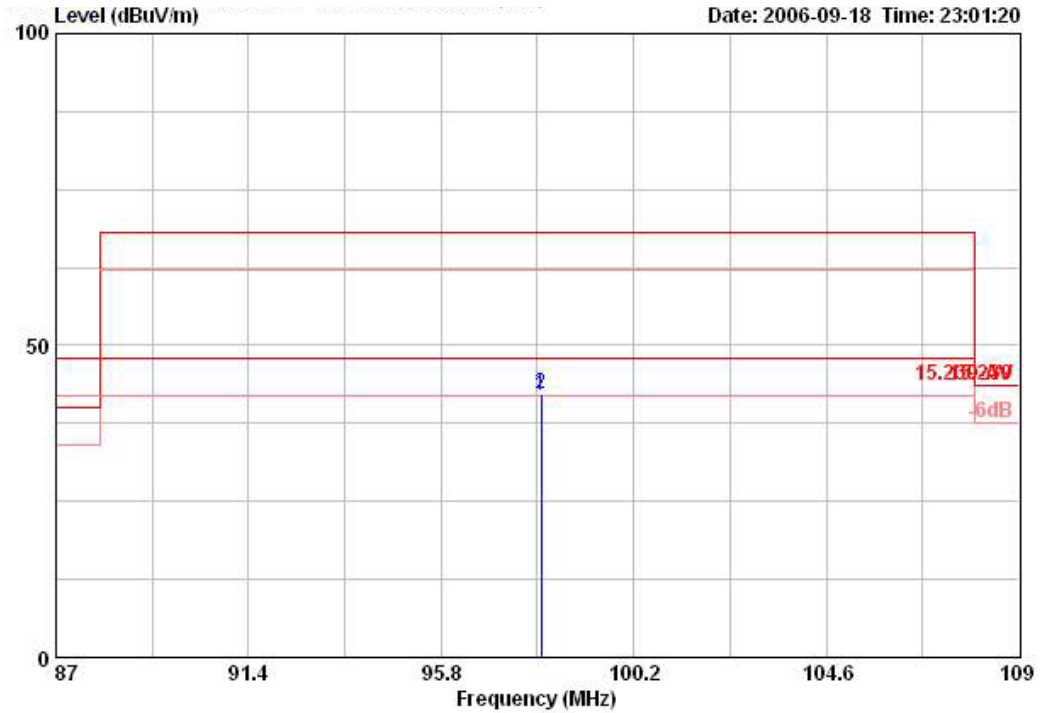

	Freq	Level	Over Limit	Limit Line	ReadAntenna Level	Antenna Factor	Cable Loss	Preamp Factor	Remark	Ant Pos	Table Pos
	MHz	dBuV/m	dB	dBuV/m	dBuV	dB/m	dB	dB		cm	deg
1 @	98.096	41.85	-6.15	48.00	56.60	10.82	0.42	26.00	AVERAGE	247	360
2	98.096	42.29	-25.71	68.00	57.05	10.82	0.42	26.00	PEAK	247	360

Horizontal

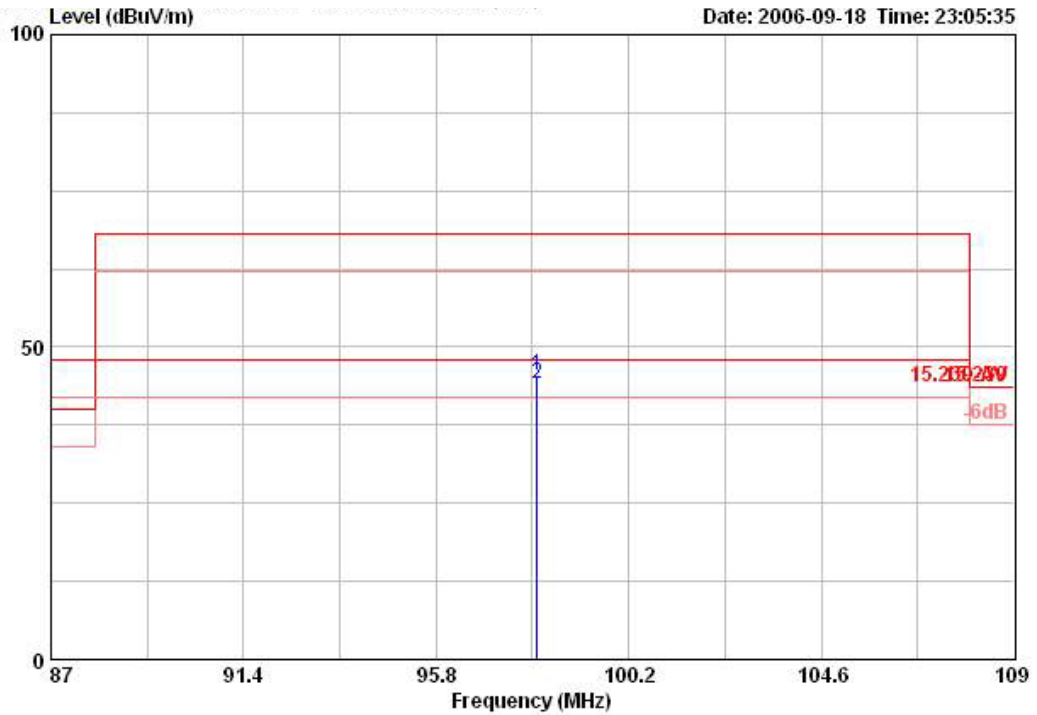

	Freq	Level	Over Limit	Limit Line	Read Level	Antenna Factor	Cable Loss	Preamp Factor	Remark	Ant Pos	Table Pos
	MHz	dBuV/m	dB	dBuV/m	dBuV	dB/m	dB	dB		cm	deg
1	98.107	45.50	-22.50	68.00	60.25	10.82	0.42	26.00	PEAK	176	291
2 @	98.107	44.02	-3.98	48.00	58.78	10.82	0.42	26.00	AVERAGE	176	291

Note:

Emission level (dBuV/m) = 20 log Emission level (uV/m)

Corrected Reading: Antenna Factor + Cable Loss + Read Level - Preamp Factor = Level

<b>Temperature</b>	24°C	<b>Humidity</b>	64%
<b>Test Engineer</b>	Leo Hung	<b>Configurations</b>	Channel 100

Vertical

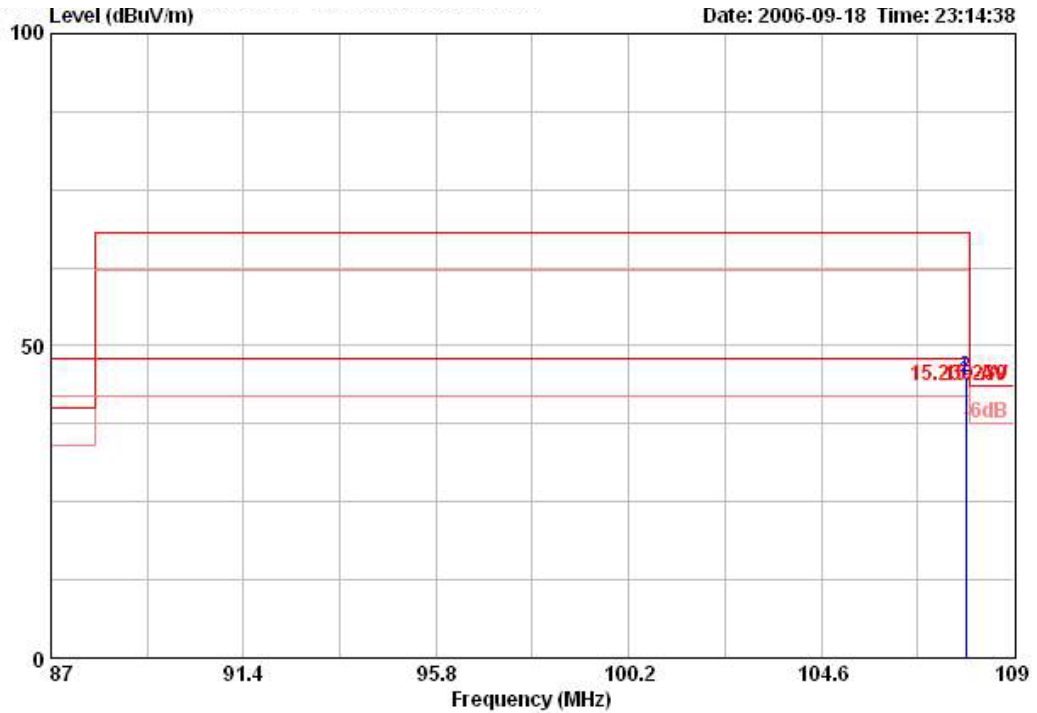

	Freq	Level	Over Limit	Limit Line	ReadAntenna Level	Antenna Factor	Cable Loss	Preamp Factor	Remark	Ant Pos	Table Pos
	MHz	dBuV/m	dB	dBuV/m	dBuV	dB/m	dB	dB		cm	deg
1 @	107.897	44.50	-3.50	48.00	57.68	12.24	0.53	25.95	AVERAGE	301	103
2	107.897	44.87	-23.13	68.00	58.05	12.24	0.53	25.95	PEAK	301	103



Horizontal

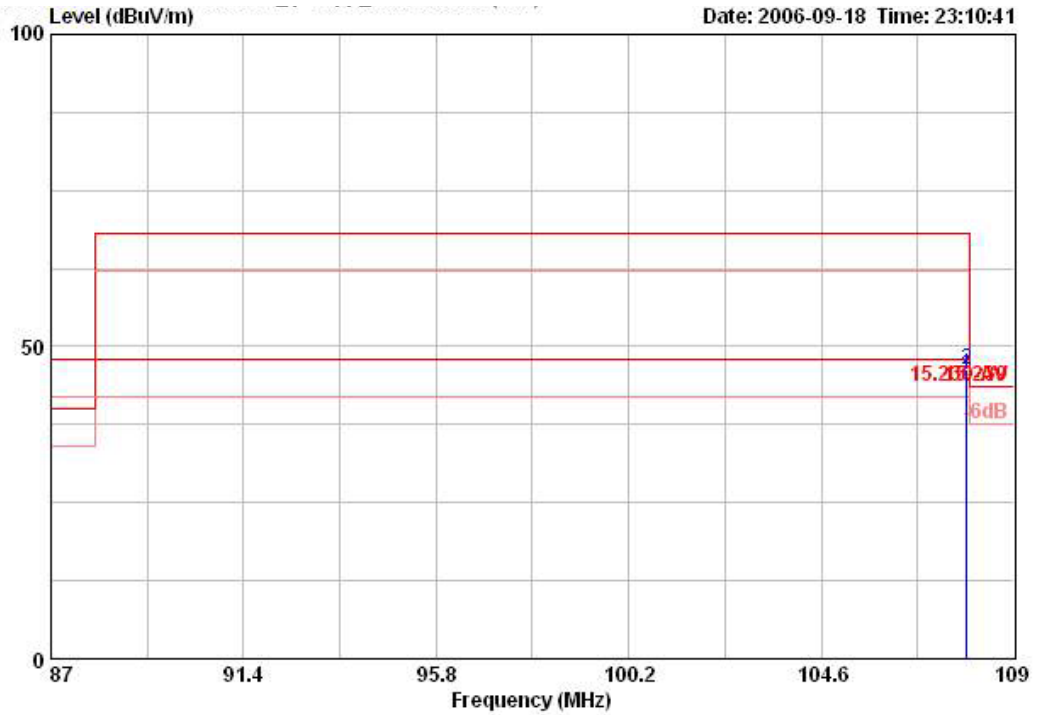

	Over	Limit	Read	Antenna	Cable	Preamp		Ant	Table		
Freq	Level	Limit	Line	Level	Factor	Loss	Factor	Pos	Pos		
MHz	dBuV/m	dB	dBuV/m	dBuV	dB/m	dB	dB	cm	deg		
1 @	107.914	45.48	-2.52	48.00	58.66	12.24	0.53	25.95	AVERAGE	288	32
2	107.914	46.40	-21.60	68.00	59.58	12.24	0.53	25.95	PEAK	288	32

Note:

Emission level (dBuV/m) = 20 log Emission level (uV/m)

Corrected Reading: Antenna Factor + Cable Loss + Read Level - Preamp Factor = Level

## 4.2. 20dB Spectrum Bandwidth Measurement

### 4.2.1. Limit

Emissions from the intentional radiator shall be confined within a band 200 kHz wide centered on the operating frequency.

### 4.2.2. Measuring Instruments and Setting

Please refer to section 5 in this report. The following table is the setting of the Spectrum Analyzer.

Spectrum Parameters	Setting
Attenuation	Auto
Span Frequency	> 20dB Bandwidth
RB	10 kHz
VB	10 kHz
Detector	Peak
Trace	Max Hold
Sweep Time	Auto

### 4.2.3. Test Procedures

1. The transmitter output (antenna port) was connected to the spectrum analyser in peak hold mode.
2. The resolution bandwidth of 10 kHz and the video bandwidth of 10 kHz were used.
3. Measured the spectrum width with power higher than 20dB below carrier.

### 4.2.4. Test Setup Layout

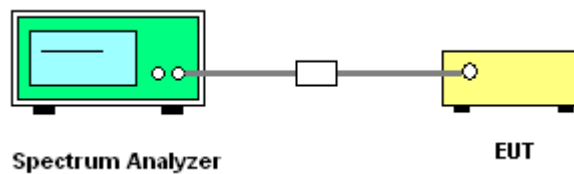

### 4.2.5. Test Deviation

There is no deviation with the original standard.

### 4.2.6. EUT Operation during Test

The EUT was programmed to be in continuously transmitting mode.

4.2.7. Test Result of 20dB Spectrum Bandwidth

Temperature	24°C	Humidity	64%
Test Engineer	Leo Hung	Configurations	Channel 1/51/100

Frequency	20dB BW (kHz)	99% OBW (kHz)	Frequency range (MHz) $f_L > 88\text{MHz}$	Frequency range (MHz) $f_H < 108\text{MHz}$	Test Result
88.1 MHz	57.00	53.00	88.0740	-	Complies
98.1 MHz	58.00	57.00	-	-	Complies
107.9 MHz	77.00	74.00	-	107.9400	Complies

20 dB/99% Bandwidth Plot on 88.1 MHz

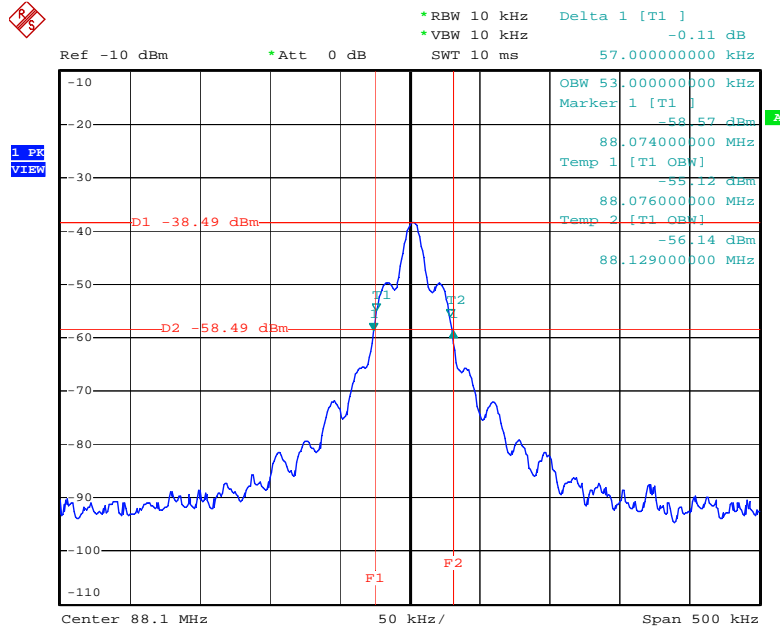

Date: 18.JUL.2006 16:18:00

20 dB/99% Bandwidth Plot on 98.1 MHz

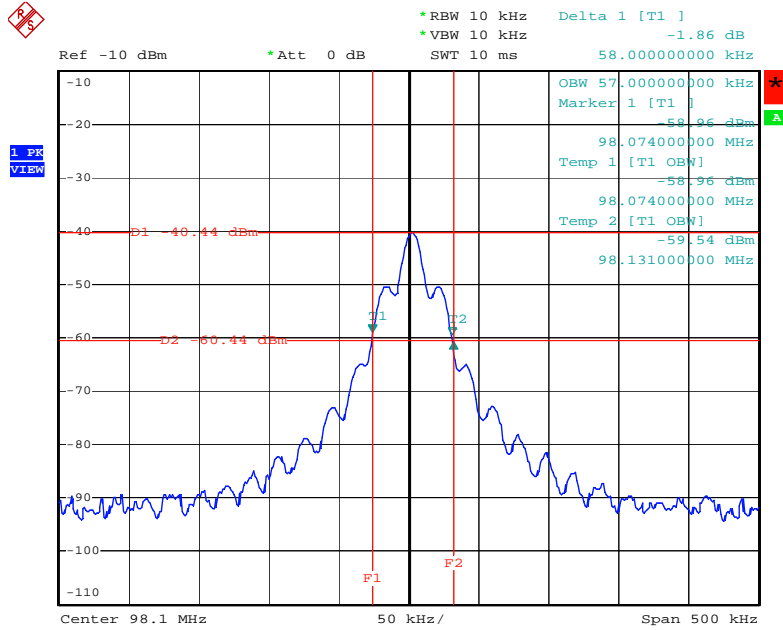

Date: 18.JUL.2006 16:20:35

20 dB/99% Bandwidth Plot on 107.9 MHz

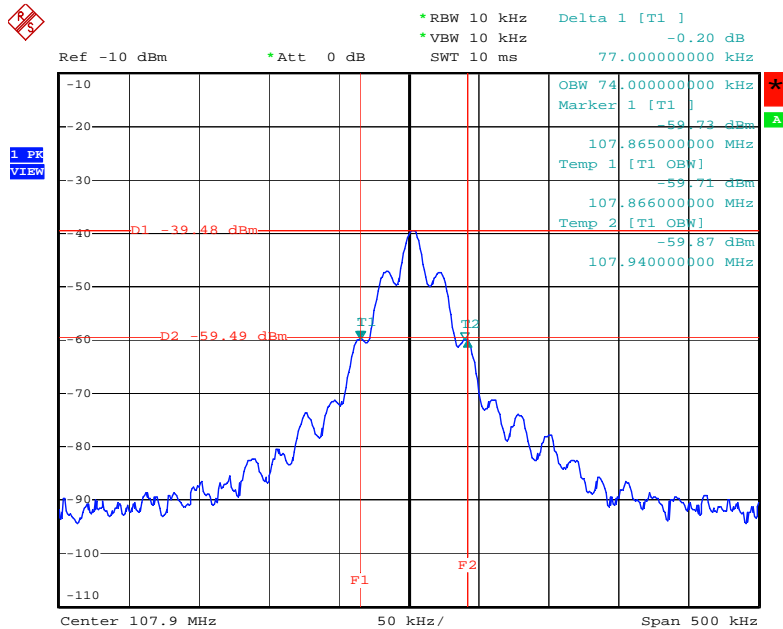

Date: 18.JUL.2006 16:21:36

### 4.3. Radiated Emissions Measurement

#### 4.3.1. Limit

The field strength of any emissions which appear outside of this band shall not exceed the general radiated emissions limits in Section 15.209(a)

Frequencies (MHz)	Field Strength (micorvolts/meter)	Measurement Distance (meters)
0.009~0.490	2400/F(KHz)	300
0.490~1.705	24000/F(KHz)	30
1.705~30.0	30	30
30~88	100	3
88~216	150	3
216~960	200	3
Above 960	500	3

#### 4.3.2. Measuring Instruments and Setting

Please refer to section 5 in this report. The following table is the setting of spectrum analyzer and receiver.

Spectrum Parameter	Setting
Attenuation	Auto
Start Frequency	1000 MHz
Stop Frequency	10th carrier harmonic
RB / VB	1MHz / 1MHz for Peak, 1 MHz / 10Hz for Average

Receiver Parameter	Setting
Attenuation	Auto
Start ~ Stop Frequency	9kHz~150kHz / RB 200Hz for QP
Start ~ Stop Frequency	150kHz~30MHz / RB 9kHz for QP
Start ~ Stop Frequency	30MHz~1000MHz / RB 120kHz for QP

#### 4.3.3. Test Procedures

1. Configure the EUT according to ANSI C63.4. The EUT was placed on the top of the turntable 0.8 meter above ground. The phase center of the receiving antenna mounted on the top of a height-variable antenna tower was placed 3 meters far away from the turntable.
2. Power on the EUT and all the supporting units. The turntable was rotated by 360 degrees to determine the position of the highest radiation.
3. The height of the broadband receiving antenna was varied between one meter and four meters above ground to find the maximum emissions field strength of both horizontal and vertical

polarization.

4. For each suspected emissions, the antenna tower was scan (from 1 M to 4 M) and then the turntable was rotated (from 0 degree to 360 degrees) to find the maximum reading.
5. Set the test-receiver system to Peak or CISPR quasi-peak Detect Function with specified bandwidth under Maximum Hold Mode.
6. For emissions above 1GHz, use 1MHz VBW and RBW for peak reading. Then 1MHz RBW and 10Hz VBW for average reading in spectrum analyzer.
7. When the radiated emissions limits are expressed in terms of the average value of the emissions, and pulsed operation is employed, the measurement field strength shall be determined by averaging over one complete pulse train, including blanking intervals, as long as the pulse train does not exceed 0.1 seconds. As an alternative (provided the transmitter operates for longer than 0.1 seconds) or in cases where the pulse train exceeds 0.1 seconds, the measured field strength shall be determined from the average absolute voltage during a 0.1 second interval during which the field strength is at its maximum value.
8. If the emissions level of the EUT in peak mode was 3 dB lower than the average limit specified, then testing will be stopped and peak values of EUT will be reported, otherwise, the emissions which do not have 3 dB margin will be repeated one by one using the quasi-peak method for below 1GHz.
9. For testing above 1GHz, the emissions level of the EUT in peak mode was lower than average limit (that means the emissions level in peak mode also complies with the limit in average mode), then testing will be stopped and peak values of EUT will be reported, otherwise, the emissions will be measured in average mode again and reported.
10. In case the emission is lower than 30MHz, loop antenna has to be used for measurement and the recorded data should be QP measured by receiver. High – Low scan is not required in this case.

#### 4.3.4. Test Setup Layout

For radiated emissions below 30MHz

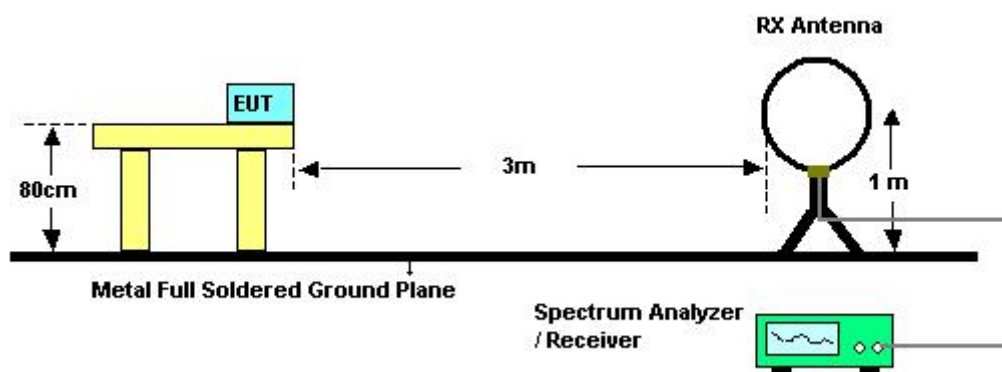

**For radiated emissions above 30MHz**

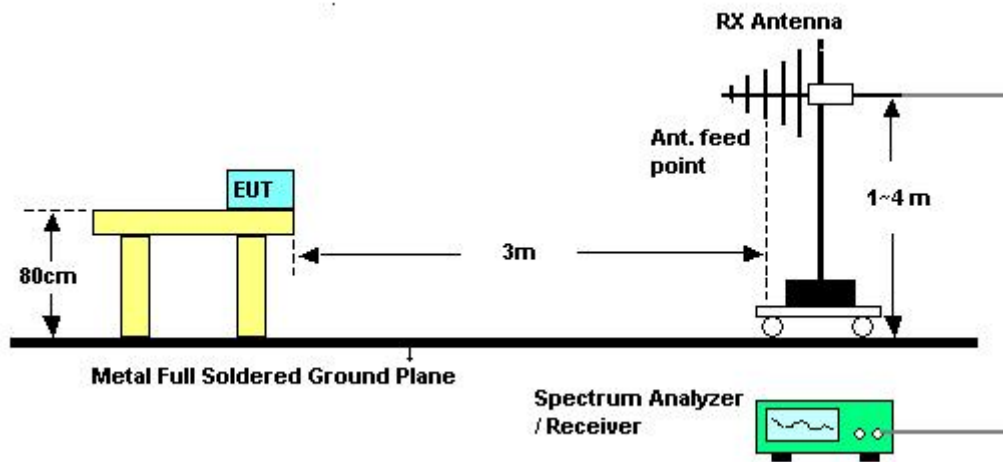

**4.3.5. Test Deviation**

There is no deviation with the original standard.

**4.3.6. EUT Operation during Test**

The EUT was programmed to be in continuously transmitting mode.

**4.3.7. Results of Radiated Emissions (9kHz~30MHz)**

Temperature	24°C	Humidity	64%
Test Engineer	Leo Hung	Configurations	Channel 51

Freq. (MHz)	Level (dBuV)	Over Limit (dB)	Limit Line (dBuV)	Remark
-	-	-	-	See Note

Note:

The amplitude of spurious emissions which are attenuated by more than 20 dB below the permissible value has no need to be reported.

Distance extrapolation factor =  $40 \log(\text{specific distance} / \text{test distance})$  (dB);

Limit line = specific limits (dBuV) + distance extrapolation factor.



4.3.8. Results for Radiated Emissions (30MHz~10<sup>th</sup> Harmonic)

Temperature	24°C	Humidity	64%
Test Engineer	Leo Hung	Configurations	Channel 1

Vertical

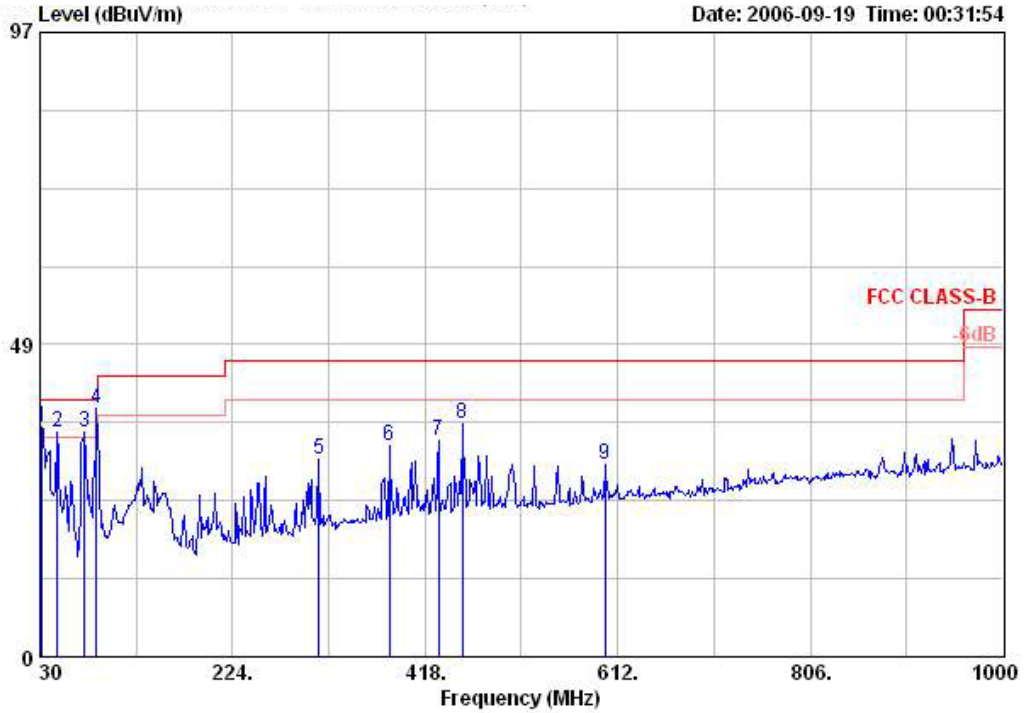

	Freq	Level	Over Limit	Limit Line	Read Level	Antenna Factor	Cable Loss	Preamp Factor	Remark	Ant Pos	Table Pos
	MHz	dBuV/m	dB	dBuV/m	dBuV	dB/m	dB	dB		cm	deg
1 @	31.940	35.58	-4.42	40.00	42.78	18.96	0.32	26.49	Peak	400	0
2 @	47.460	34.99	-5.01	40.00	50.64	10.20	0.63	26.48	Peak	400	0
3 @	74.620	34.77	-5.23	40.00	53.39	7.21	0.37	26.20	Peak	400	0
4 @	87.230	38.57			55.34	8.82	0.54	26.13	Peak	400	0
5	311.300	30.59	-15.41	46.00	40.18	14.22	1.14	24.95	Peak	400	0
6	382.110	32.66	-13.34	46.00	40.48	16.08	1.45	25.35	Peak	400	0
7	431.580	33.63	-12.37	46.00	40.99	16.94	1.49	25.79	Peak	400	0
8	455.830	36.22	-9.78	46.00	43.47	17.27	1.47	25.99	Peak	400	0
9	599.390	29.87	-16.13	46.00	35.04	18.99	2.07	26.23	Peak	400	0

Item 4 is fundamental frequency.

Horizontal

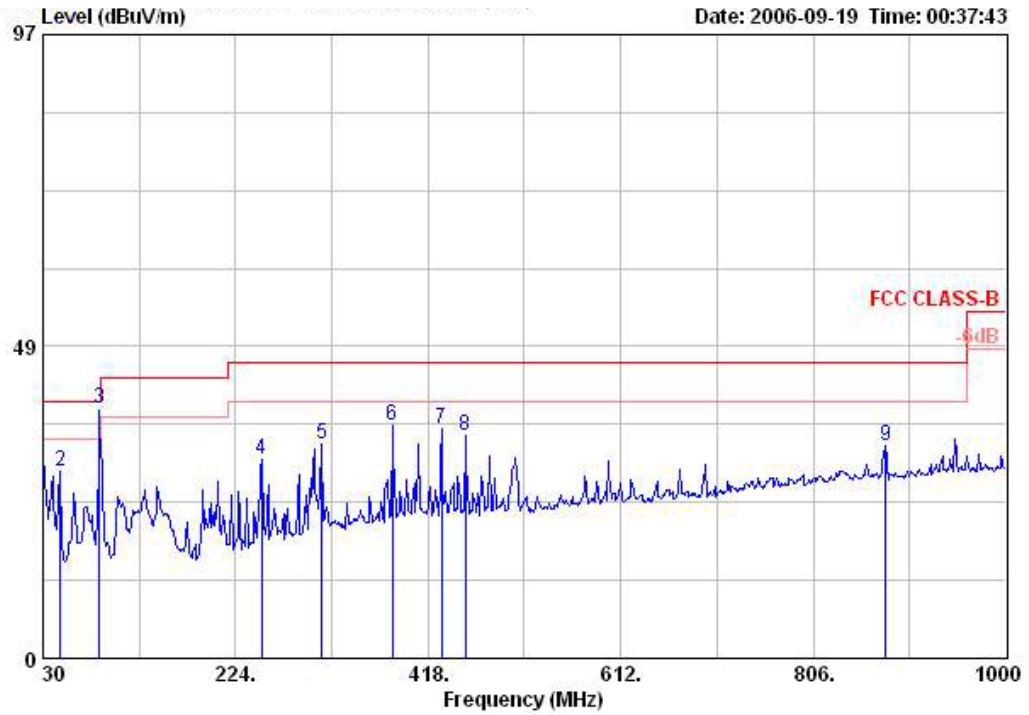

	Freq	Level	Over Limit	Limit Line	Read Level	Antenna Factor	Cable Loss	Preamp Factor	Remark	Ant Pos	Table Pos
	MHz	dBuV/m	dB	dBuV/m	dBuV	dB/m	dB	dB		cm	deg
1	30.000	30.84	-9.16	40.00	36.88	20.20	0.44	26.68	Peak	100	0
2	47.460	29.05	-10.95	40.00	44.70	10.20	0.63	26.48	Peak	100	0
3 @	87.230	38.80			55.57	8.82	0.54	26.13	Peak	100	0
4	250.190	30.79	-15.21	46.00	42.16	12.90	1.15	25.42	Peak	100	0
5	311.300	33.38	-12.62	46.00	42.96	14.22	1.14	24.95	Peak	100	0
6	382.110	36.09	-9.91	46.00	43.90	16.08	1.45	25.35	Peak	100	0
7	431.580	35.76	-10.24	46.00	43.12	16.94	1.49	25.79	Peak	100	0
8	455.830	34.65	-11.35	46.00	41.90	17.27	1.47	25.99	Peak	100	0
9	878.750	33.12	-12.88	46.00	34.11	21.46	2.63	25.08	Peak	100	0

Item 3 is fundamental frequency.

Temperature	24°C	Humidity	64%
Test Engineer	Leo Hung	Configurations	Channel 51

Vertical

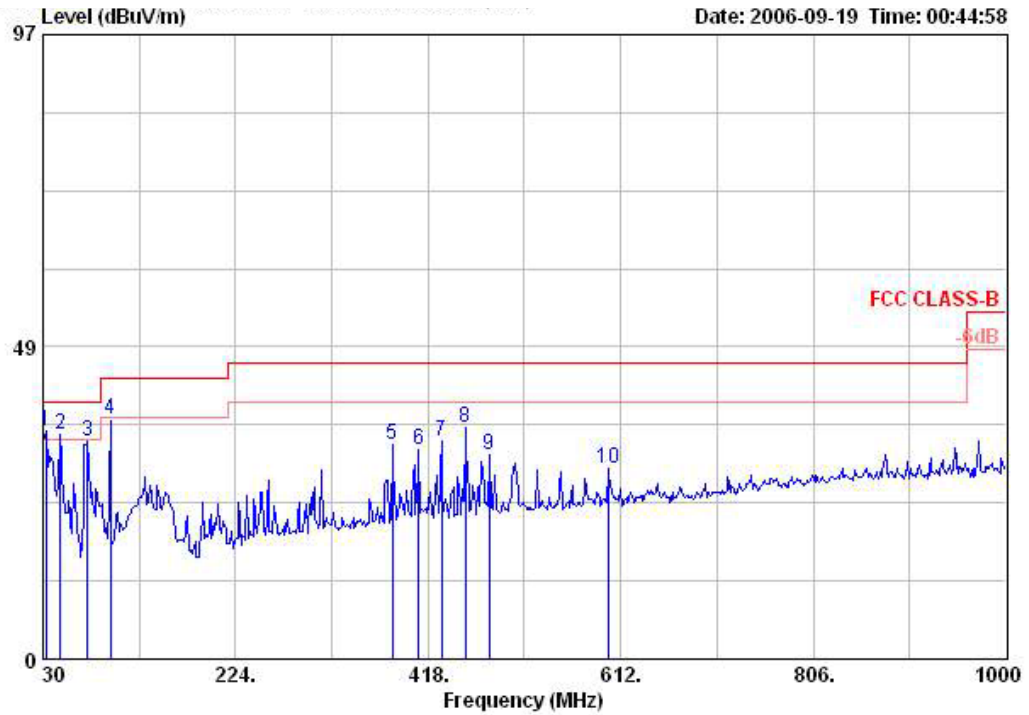

	Over	Limit	Read	Antenna	Cable	Preamp		Ant	Table		
Freq	Level	Limit	Line	Level	Factor	Loss	Factor	Pos	Pos		
MHz	dBuV/m	dB	dBuV/m	dBuV	dB/m	dB	dB	cm	deg		
1 @	32.910	35.46	-4.54	40.00	43.25	18.34	0.27	26.40	Peak	400	0
2 @	47.460	34.93	-5.07	40.00	50.58	10.20	0.63	26.48	Peak	400	0
3 @	74.620	33.73	-6.27	40.00	52.35	7.21	0.37	26.20	Peak	400	0
4 @	97.900	37.15			51.90	10.82	0.42	26.00	Peak	400	0
5	382.110	33.35	-12.65	46.00	41.17	16.08	1.45	25.35	Peak	400	0
6	408.300	32.53	-13.47	46.00	39.94	16.62	1.58	25.61	Peak	400	0
7	431.580	33.81	-12.19	46.00	41.17	16.94	1.49	25.79	Peak	400	0
8	455.830	35.91	-10.09	46.00	43.17	17.27	1.47	25.99	Peak	400	0
9	479.110	31.82	-14.18	46.00	38.81	17.55	1.65	26.18	Peak	400	0
10	599.390	29.64	-16.36	46.00	34.81	18.99	2.07	26.23	Peak	400	0

Item 4 is fundamental frequency.

Horizontal

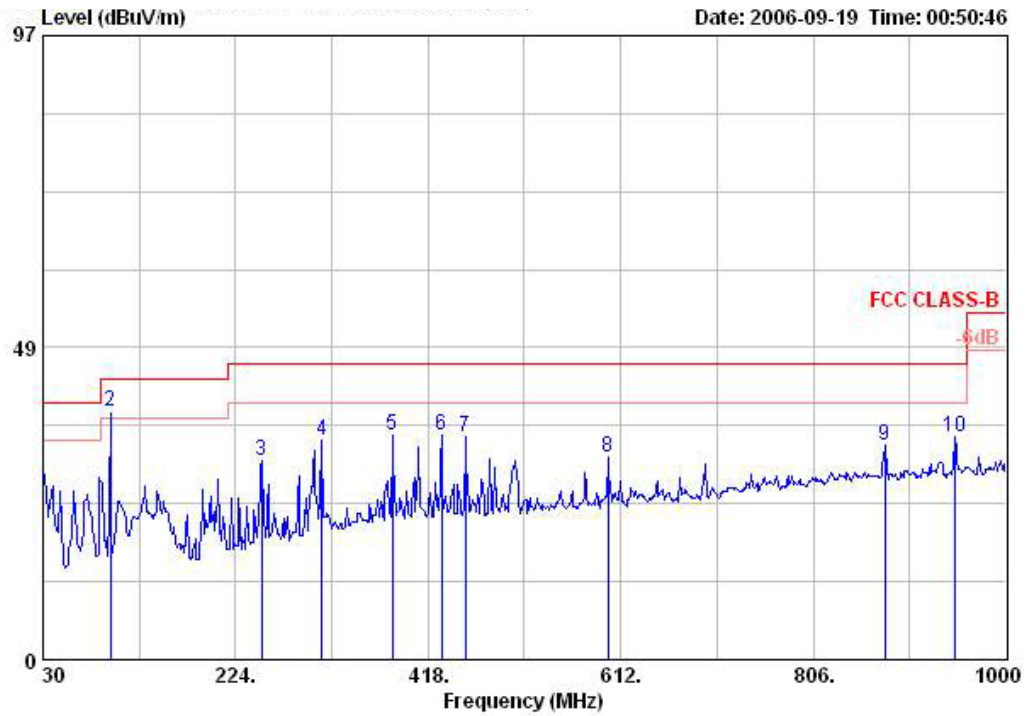

	Freq	Level	Over Limit	Limit Line	ReadAntenna Level	Antenna Factor	Cable Loss	Preamp Factor	Remark	Ant Pos	Table Pos
	MHz	dBuV/m	dB	dBuV/m	dBuV	dB/m	dB	dB		cm	deg
1	30.000	29.34	-10.66	40.00	35.38	20.20	0.44	26.68	Peak	100	0
2 @	97.900	38.65			53.40	10.82	0.42	26.00	Peak	100	0
3	250.190	30.82	-15.18	46.00	42.19	12.90	1.15	25.42	Peak	100	0
4	311.300	33.98	-12.02	46.00	43.56	14.22	1.14	24.95	Peak	100	0
5	382.110	34.89	-11.11	46.00	42.71	16.08	1.45	25.35	Peak	100	0
6	431.580	34.94	-11.06	46.00	42.30	16.94	1.49	25.79	Peak	100	0
7	455.830	34.57	-11.43	46.00	41.82	17.27	1.47	25.99	Peak	100	0
8	599.390	31.33	-14.67	46.00	36.50	18.99	2.07	26.23	Peak	100	0
9	877.780	33.39	-12.61	46.00	34.38	21.46	2.62	25.07	Peak	100	0
10	948.590	34.72	-11.28	46.00	35.17	21.99	3.05	25.49	Peak	100	0

Item 2 is fundamental frequency.

Temperature	24°C	Humidity	64%
Test Engineer	Leo Hung	Configurations	Channel 100

Vertical

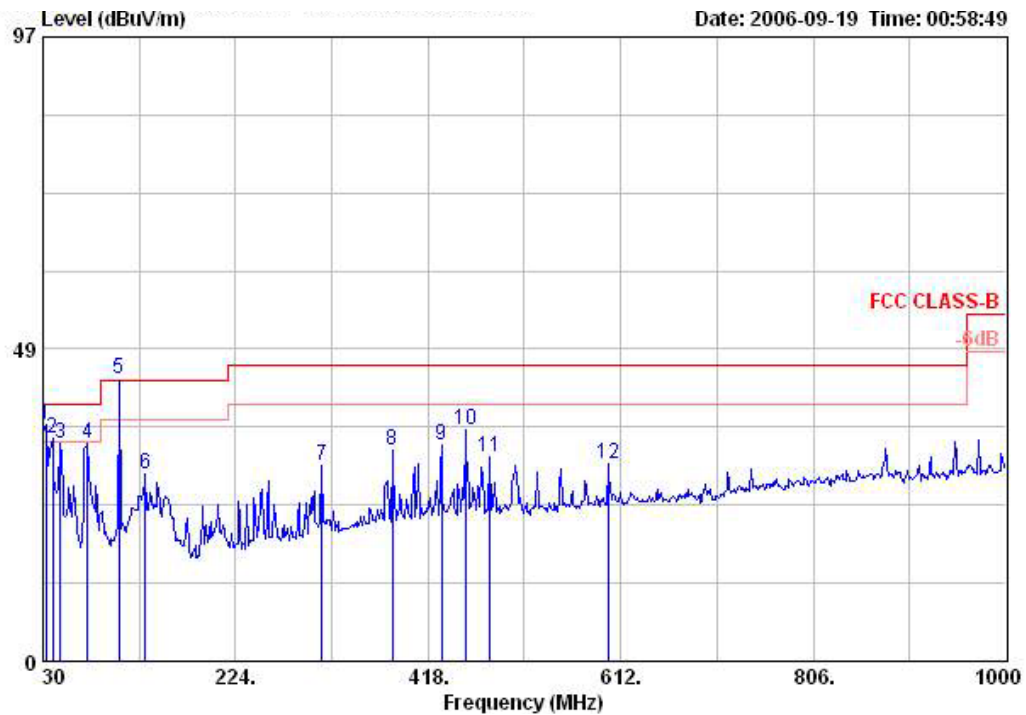

	Freq	Level	Over Limit	Limit Line	Read Level	Antenna Factor	Cable Loss	Preamp Factor	Remark	Ant Pos	Table Pos
	MHz	dBuV/m	dB	dBuV/m	dBuV	dB/m	dB	dB		cm	deg
1 !	32.910	36.62	-3.38	40.00	44.41	18.34	0.27	26.40	Peak	400	0
2 !	39.700	34.75	-5.25	40.00	46.62	14.10	0.63	26.60	Peak	400	0
3	47.460	33.71	-6.29	40.00	49.35	10.20	0.63	26.48	Peak	400	0
4	74.620	33.82	-6.18	40.00	52.44	7.21	0.37	26.20	Peak	400	0
5 over	106.630	43.86			57.20	12.11	0.50	25.95	Peak	400	0
6	132.820	29.06	-14.44	43.50	41.95	12.35	0.62	25.87	Peak	400	0
7	311.300	30.28	-15.72	46.00	39.86	14.22	1.14	24.95	Peak	400	0
8	382.110	32.82	-13.18	46.00	40.63	16.08	1.45	25.35	Peak	400	0
9	431.580	33.60	-12.40	46.00	40.96	16.94	1.49	25.79	Peak	400	0
10	455.830	36.06	-9.94	46.00	43.32	17.27	1.47	25.99	Peak	400	0
11	479.110	31.69	-14.31	46.00	38.67	17.55	1.65	26.18	Peak	400	0
12	599.390	30.71	-15.29	46.00	35.88	18.99	2.07	26.23	Peak	400	0

Item 5 is fundamental frequency.

Horizontal

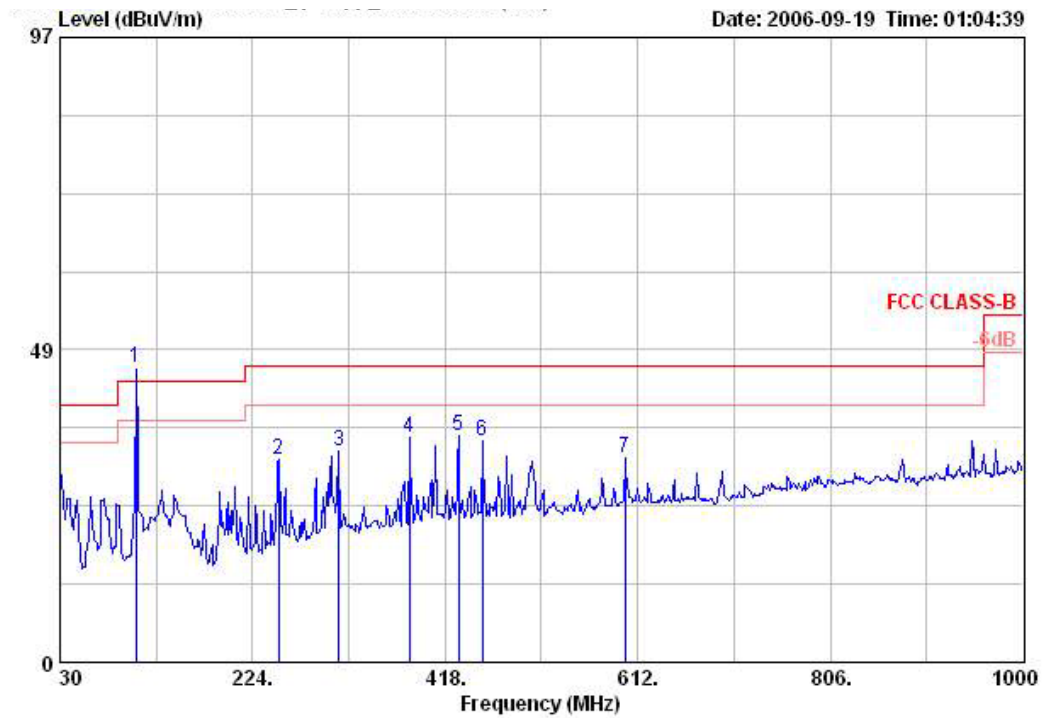

	Freq	Level	Over Limit	Limit Line	Read Level	Antenna Factor	Cable Loss	Preamp Factor	Remark	Ant Pos	Table Pos
	MHz	dBuV/m	dB	dBuV/m	dBuV	dB/m	dB	dB		cm	deg
1 @	106.630	45.66			59.00	12.11	0.50	25.95	Peak	100	0
2	250.190	31.36	-14.64	46.00	42.73	12.90	1.15	25.42	Peak	100	0
3	311.300	32.77	-13.23	46.00	42.36	14.22	1.14	24.95	Peak	100	0
4	382.110	34.97	-11.03	46.00	42.79	16.08	1.45	25.35	Peak	100	0
5	431.580	35.15	-10.85	46.00	42.51	16.94	1.49	25.79	Peak	100	0
6	455.830	34.37	-11.63	46.00	41.62	17.27	1.47	25.99	Peak	100	0
7	599.390	31.69	-14.31	46.00	36.85	18.99	2.07	26.23	Peak	100	0

Item 1 is fundamental frequency.

Note:

The amplitude of spurious emissions which are attenuated by more than 20 dB below the permissible value has no need to be reported.

Emission level (dBuV/m) = 20 log Emission level (uV/m).

Corrected Reading: Antenna Factor + Cable Loss + Read Level - Preamp Factor = Level.



## 4.4. Band Edge Emissions Measurement

### 4.4.1. Limit

Band edge emissions outside of the frequency bands shown in below table.

Outside Frequency Band Edge	Limit (dBuV/m) at 3m
Below 88MHz	40.0 (QP)
Above 108MHz	43.5 (QP)

### 4.4.2. Measuring Instruments and Setting

Please refer to section 5 in this report. The following table is the setting of the receiver.

Receiver Parameter	Setting
Center Frequency	Fundamental Frequency
RB	120 KHz
Detector	QP or Peak

### 4.4.3. Test Procedures

The test procedure is the same as section 4.2.3, only the frequency range investigated is limited to 2MHz around bandedges.

### 4.4.4. Test Setup Layout

This test setup layout is the same as that shown in section 4.2.4

### 4.4.5. Test Deviation

There is no deviation with the original standard.

### 4.4.6. EUT Operation during Test

The EUT was programmed to be in continuously transmitting mode.



4.4.7. Test Result of Band Edge and Fundamental Emissions

Temperature	24°C	Humidity	64%
Test Engineer	Leo Hung	Configurations	Channel 1, 100

Channel 1

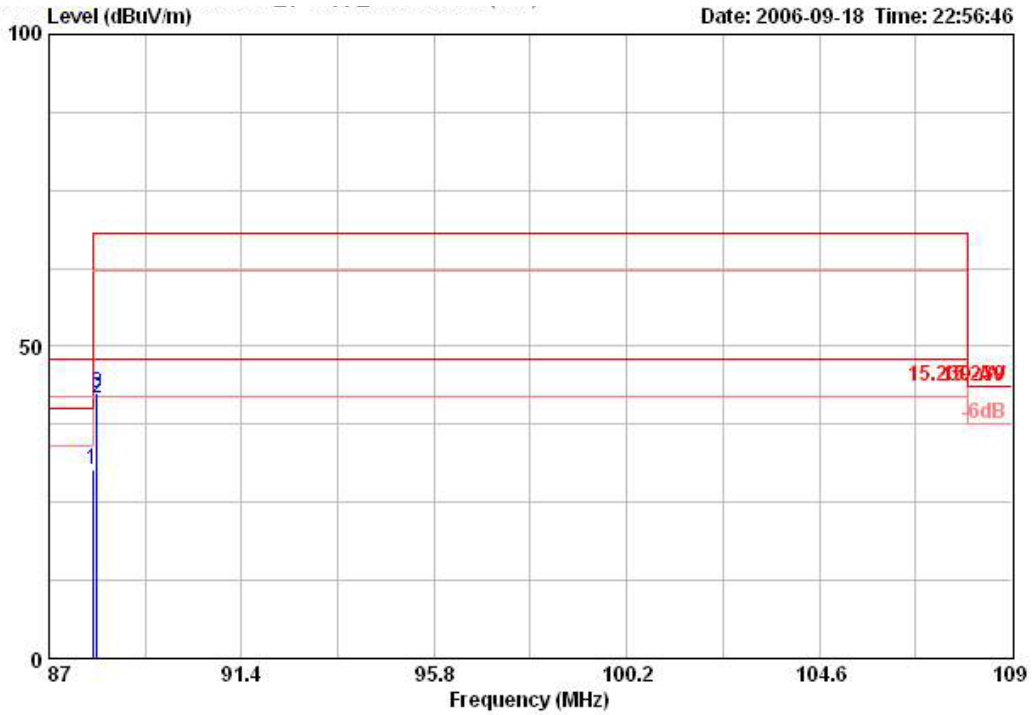

	Freq	Level	Over Limit	Limit Line	Read Level	Antenna Factor	Cable Loss	Preamp Factor	Remark	Ant Pos	Table Pos
	MHz	dBuV/m	dB	dBuV/m	dBuV	dB/m	dB	dB		cm	deg
1	88.000	30.28	-9.72	40.00	46.87	8.98	0.55	26.12	QP	121	0
2 @	88.096	41.68	-6.32	48.00	58.27	8.98	0.55	26.12	AVERAGE	121	0
3	88.096	42.56	-25.44	68.00	59.15	8.98	0.55	26.12	PEAK	121	0

Item 1 is Band Edge.

Channel 100

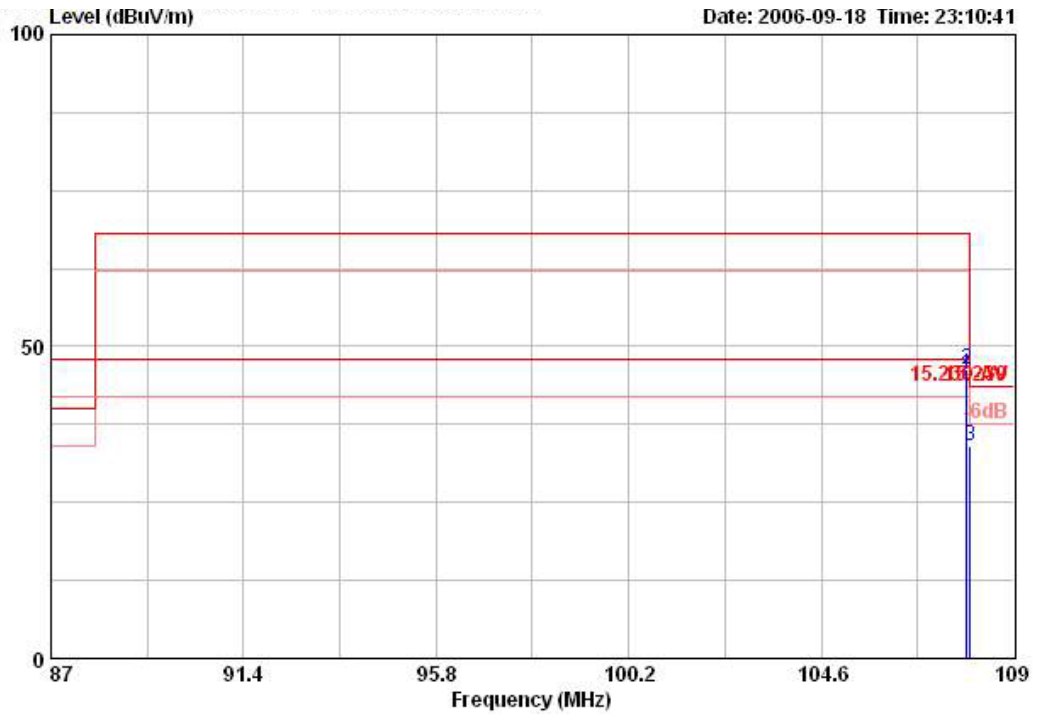

	Freq	Level	Over Limit	Limit Line	Read Level	Antenna Factor	Cable Loss	Preamp Factor	Remark	Ant Pos	Table Pos
	MHz	dBuV/m	dB	dBuV/m	dBuV	dB/m	dB	dB		cm	deg
1 @	107.914	45.48	-2.52	48.00	58.66	12.24	0.53	25.95	AVERAGE	288	32
2	107.914	46.40	-21.60	68.00	59.58	12.24	0.53	25.95	PEAK	288	32
3	108.000	34.15	-9.35	43.50	47.33	12.24	0.53	25.95	QP	288	32

Item 3 is Band Edge.

Note:

Emission level (dBuV/m) = 20 log Emission level (uV/m).

Corrected Reading: Antenna Factor + Cable Loss + Read Level - Preamp Factor = Level.

### Low Band Edge Plot on 88.1 MHz

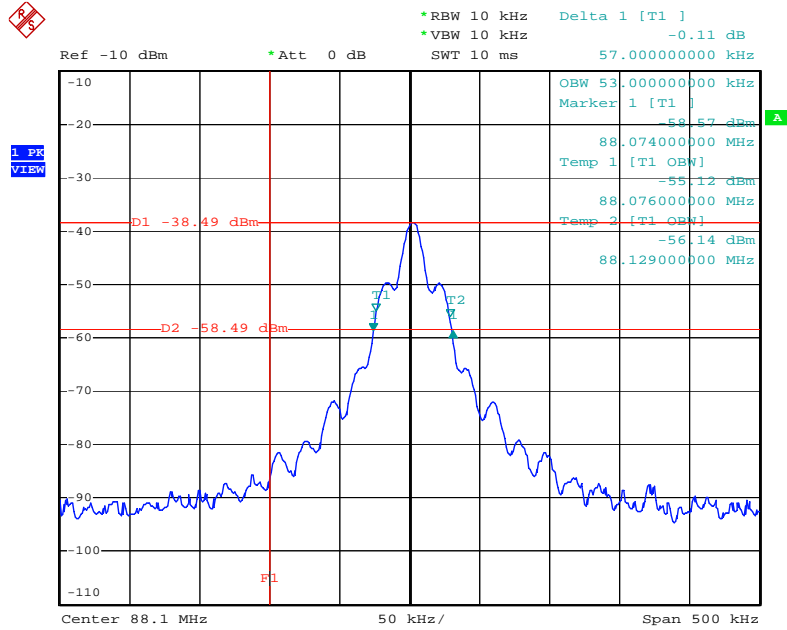

Date: 18.JUL.2006 16:19:10

### High Band Edge Plot on 107.9 MHz

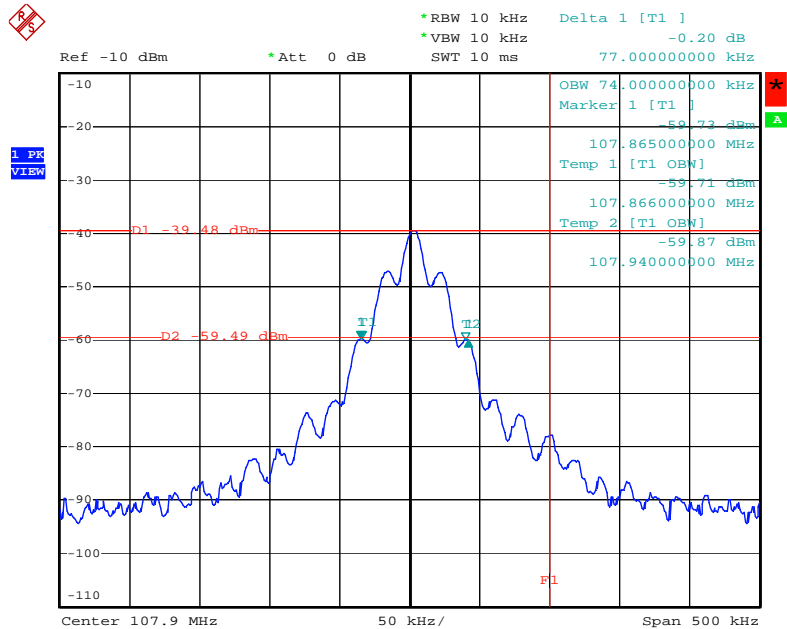

Date: 18.JUL.2006 16:21:55

## 4.5. Antenna Requirements

### 4.5.1. Limit

Except for special regulations, the Low-power Radio-frequency Devices must not be equipped with any jacket for installing an antenna with extension cable. An intentional radiator shall be designed to ensure that no antenna other than that furnished by the responsible party shall be used with the device. The use of a permanently attached antenna or of an antenna that uses a unique coupling to the intentional radiator shall be considered sufficient to comply with the provisions of this Section. The manufacturer may design the unit so that the user can replace a broken antenna, but the use of a standard antenna jack or electrical connector is prohibited. Further, this requirement does not apply to intentional radiators that must be professionally installed.

### 4.5.2. Antenna Connector Construction

Please refer to section 3.1 in this test report, antenna connector complied with the requirements.

## 5. LIST OF MEASURING EQUIPMENTS

Instrument	Manufacturer	Model No.	Serial No.	Characteristics	Calibration Date	Remark
3m Semi Anechoic Chamber	SIDT FRANKONIA	SAC-3M	03CH03-HY	30 MHz - 1 GHz 3m	Jun. 15, 2006	Radiation (03CH03-HY)
Amplifier	SCHAFFNER	CPA9231A	3565	9 kHz - 2 GHz	Jan. 18, 2006	Radiation (03CH03-HY)
Amplifier	Agilent	8449B	3008A02120	1 GHz - 26.5 GHz	May 29, 2006	Radiation (03CH03-HY)
Amplifier	MITEQ	AMF-6F-260400	923364	26.5 GHz - 40 GHz	Jan. 24, 2006*	Radiation (03CH03-HY)
Spectrum Analyzer	R&S	FSP40	100004/040	9 kHz - 40 GHz	Sep. 30, 2005	Radiation (03CH03-HY)
Loop Antenna	R&S	HFH2-Z2	860004/001	9 kHz - 30 MHz	May 23, 2006*	Radiation (03CH03-HY)
Bilog Antenna	SCHAFFNER	CBL 6112D	22237	30 MHz - 1 GHz	Jul. 24, 2006	Radiation (03CH03-HY)
Horn Antenna	EMCO	3115	6903	1GHz ~ 18GHz	Mar. 15, 2006	Radiation (03CH03-HY)
Horn Antenna	SCHWARZBECK	BBHA9170	BBHA9170154	15 GHz - 40 GHz	NCR	Radiation (03CH03-HY)
RF Cable-R03m	Jye Bao	RG142	CB021	30 MHz - 1 GHz	Dec.02, 2005	Radiation (03CH03-HY)
RF Cable-HIGH	SUHNER	SUCOFLEX 106	03CH03-HY	1 GHz - 40 GHz	Dec.02, 2005	Radiation (03CH03-HY)
Turn Table	HD	DS 420	420/650/00	0 - 360 degree	N/A	Radiation (03CH03-HY)
Antenna Mast	HD	MA 240	240/560/00	1 m - 4 m	N/A	Radiation (03CH03-HY)
Spectrum analyzer	R&S	FSP30	100023	9kHz ~ 30GHz	Nov. 26, 2005	Conducted (TH01-HY)
AC power source	HPC	HPA-500W	HPA-9100024	AC 0 ~ 300V	Apr. 21, 2005*	Conducted (TH01-HY)
DC power source	G.W.	GPC-6030D	C671845	DC 1V ~ 60V	Dec. 28, 2005	Conducted (TH01-HY)
Temp. and Humidity Chamber	KSON	THS-C3L	612	N/A	Oct. 01, 2005	Conducted (TH01-HY)
RF CABLE-1m	Jye Bao	RG142	CB034-1m	20MHz ~ 7GHz	Dec. 30, 2005	Conducted (TH01-HY)
RF CABLE-2m	Jye Bao	RG142	CB035-2m	20MHz ~ 1GHz	Dec. 30, 2005	Conducted (TH01-HY)
Oscilloscope	Tektronix	TDS1012	CO38515	100MHz / 1GS/s	Jun. 20, 2006	Conducted (TH01-HY)
Signal Generator	R&S	SMR40	100116	10MHz ~ 40GHz	Dec. 30, 2005	Conducted (TH01-HY)
Data Generator	Tektronix	DG2030	063-2920-50	0.1Hz~400MHz	Jun. 16, 2006	Conducted (TH01-HY)

Note: Calibration Interval of instruments listed above is one year.

Note: \*Calibration Interval of instruments listed above is two year.

Note: NCR means Non-Calibration required.

## 6. SPORTON COMPANY PROFILE

SPORTON Lab. was established in 1986 with one shielded room: the first private EMI test facility, offering local manufacturers an alternative EMI test facility apart from ERSO. In 1988, one 3M and 10M/3M open area test site were setup and also obtained official accreditation from FCC, VCCI and NEMKO. In 1993, a Safety laboratory was founded and obtained accreditation from UL of USA, CSA of Canada and TUV (Rhineland & PS) of Germany. In 1995, one EMC lab, including EMI and EMS test facilities was setup. In 1997, SPORTON Group has provided financial expense to relocate the headquarter to Orient Scientific Park in Taipei Hsien to offer more comprehensive, more qualified and better service to local suppliers and manufactures. In 1999, Safety Group and Component Group were setup. In 2001, SPORTON has established 3M/10M chamber in Hwa Ya Technology Park.

### 6.1. Test Location

SHIJR	ADD : 6Fl., No. 106, Sec. 1, Shintai 5th Rd., Shijr City, Taipei, Taiwan 221, R.O.C. TEL : 02-2696-2468 FAX : 02-2696-2255
HWA YA	ADD : No. 52, Hwa Ya 1st Rd., Kwei-Shan Hsiang, Tao Yuan Hsien, Taiwan, R.O.C. TEL : 03-327-3456 FAX : 03-318-0055
LINKOU	ADD : No. 30-2, Dingfu Tsuen, Linkou Shiang, Taipei, Taiwan 244, R.O.C TEL : 02-2601-1640 FAX : 02-2601-1695
DUNGHU	ADD : No. 3, Lane 238, Kangle St., Neihu Chiu, Taipei, Taiwan 114, R.O.C. TEL : 02-2631-4739 FAX : 02-2631-9740
JUNGHE	ADD : 7Fl., No. 758, Jungjeng Rd., Junghe City, Taipei, Taiwan 235, R.O.C. TEL : 02-8227-2020 FAX : 02-8227-2626
NEIHU	ADD : 4Fl., No. 339, Hsin Hu 2 <sup>nd</sup> Rd., Taipei 114, Taiwan, R.O.C. TEL : 02-2794-8886 FAX : 02-2794-9777
JHUBEI	ADD : No.8, Lane 728, Bo-ai St., Jhubei City, Hsinchu County 302, Taiwan, R.O.C. TEL : 03-656-9065 FAX : 03-656-9085