



Specific Absorption Rate (SAR) Test Report
for
Wistron NeWeb Corporation
on the
Stiletto 2

Report No. : FA782102-1-2-01
Trade Name : Sirius
Model Name : SL2, SL2R, SL2B, SL2C, UWA-SL2, SL2PK1,
SL2PK1R, SL2PK1B, SL2PK1C, SL2TK1C
FCC ID : NKRUWASL2
Date of Testing : Aug. 18, 2007
Date of Report : Aug. 22, 2007
Date of Review : Aug. 22, 2007

- The test results refer exclusively to the presented test model / sample only.
- Without written approval of SPORTON International Inc., the test report shall not be reproduced except in full.
- Report Version: Rev. 01

SPORTON International Inc.

6F, No.106, Sec. 1, Hsin Tai Wu Rd., Hsi Chih, Taipei Hsien, Taiwan, R.O.C.



Table of Contents

- 1. **Statement of Compliance** 1
- 2. **Administration Data** 2
 - 2.1 Testing Laboratory 2
 - 2.2 Detail of Applicant 2
 - 2.3 Detail of Manufacturer 2
 - 2.4 Application Detail 2
- 3. **Scope** 3
 - 3.1 Description of Device Under Test (DUT) 3
 - 3.2 Product Photo 4
 - 3.3 Applied Standards: 5
 - 3.4 Device Category and SAR Limits 6
 - 3.5 Test Conditions 6
 - 3.5.1 Ambient Condition: 6
 - 3.5.2 Test Configuration: 6
- 4. **Specific Absorption Rate (SAR)** 7
 - 4.1 Introduction 7
 - 4.2 SAR Definition 7
- 5. **SAR Measurement Setup** 8
 - 5.1 DASY4 E-Field Probe System 9
 - 5.1.1 ET3DV6 E-Field Probe Specification 10
 - 5.1.2 ET3DV6 E-Field Probe Calibration 10
 - 5.2 DATA Acquisition Electronics (DAE) 11
 - 5.3 Robot 12
 - 5.4 Measurement Server 12
 - 5.5 SAM Twin Phantom 12
 - 5.6 Data Storage and Evaluation 14
 - 5.6.1 Data Storage 14
 - 5.6.2 Data Evaluation 14
 - 5.7 Test Equipment List 17
- 6. **Tissue Simulating Liquids** 18
- 7. **Uncertainty Assessment** 20
- 8. **SAR Measurement Evaluation** 22
 - 8.1 Purpose of System Performance check 22
 - 8.2 System Setup 22
 - 8.3 Validation Results 24
- 9. **Description for DUT Testing Position** 25
- 10. **Measurement Procedures** 26
 - 10.1 Spatial Peak SAR Evaluation 26
 - 10.2 Scan Procedures 27
 - 10.3 SAR Averaged Methods 27
- 11. **SAR Test Results** 28
 - 11.1 Keypad Up with 1.5cm Gap 28
 - 11.2 Keypad Down with 1.5cm Gap 28
- 12. **Reference** 29

- Appendix A - System Performance Check Data
- Appendix B - SAR Measurement Data
- Appendix C - Calibration Data
- Appendix D - Product Photo
- Appendix E - Setup Photo



1. Statement of Compliance

The Specific Absorption Rate (SAR) maximum result found during testing for the **Wistron NeWeb Corporation Stiletto 2 Sirius SL2, SL2R, SL2B, SL2C, UWA-SL2, SL2PK1, SL2PK1R, SL2PK1B, SL2PK1C, SL2TK1C** is **0.06 W/Kg on the WLAN 2.4GHz band body SAR** with expanded uncertainty 20.6%. It is in compliance with Specific Absorption Rate (SAR) for general population/uncontrolled exposure limits specified in FCC 47 CFR part 2 (2.1093) and ANSI/IEEE C95.1-1999 and had been tested in accordance with the measurement methods and procedures specified in OET Bulletin 65 Supplement C (Edition 01-01).

Approved by

A handwritten signature in blue ink that reads "Jones Tsai". The signature is written in a cursive style with a horizontal line underneath it.

Jones Tsai
Manager



2. Administration Data

2.1 Testing Laboratory

Company Name : Sporton International Inc.
Department : Antenna Design/SAR
Address : No.52, Hwa-Ya 1st RD., Hwa Ya Technology Park, Kwei-Shan Hsiang, Tao Yuan Hsien, Taiwan, R.O.C.
Telephone Number : 886-3-327-3456
Fax Number : 886-3-327-0973

2.2 Detail of Applicant

Company Name : Wistron NeWeb Corporation
Address : No. 10-1, Li-hsin Road I, Science-baded Industrial Park, Hsinchu 300, Taiwan, R.O.C.
Telephone Number : 886-03-6667799
Fax Number : 886-03-6667711
Contact Person : Jacky Huang / jacky_huang@wneweb.com.tw

2.3 Detail of Manufacturer

Company Name : 1. Wistron NeWeb Corporation
2. WNC(Kunshan) Corporation
Address : 1. No. 10-1, Li-hsin Road I, Science-baded Industrial Park, Hsinchu 300, Taiwan, R.O.C.
2. No.88,Central Avenue, Area B, Kunshan Export Processing Zone, Kunshan City, Jiangsu, China.

2.4 Application Detail

Date of reception of application: Aug. 18, 2007
Start of test : Aug. 18, 2007
End of test : Aug. 18, 2007



3. Scope

3.1 Description of Device Under Test (DUT)

| | |
|--|--|
| DUT Type : | Stiletto 2 |
| Trade Name : | Sirius |
| Model Name : | SL2, SL2R, SL2B, SL2C, UWA-SL2, SL2PK1, SL2PK1R, SL2PK1B, SL2PK1C, SL2TK1C |
| FCC ID : | NKRUWASL2 |
| Type of Modulation : | DSSS / OFDM |
| Frequency Range : | 2400 ~ 2483.5 MHz |
| Maximum Output Power to Antenna : | 802.11b : 12.80 dBm 802.11g : 15.04 dBm |
| Antenna Type : | PIFA Antenna |
| Antenna Gain : | 1.2 dBi |
| Application Type : | Certification |



3.2 Product Photo

Please refer to Appendix D



3.3 Applied Standards:

The Specific Absorption Rate (SAR) testing specification, method and procedure for this Stiletto 2 is in accordance with the following standards:

47 CFR Part 2 (2.1093),
IEEE C95.1-1999,
IEEE C95.3-2002,
IEEE P1528 -2003, and
OET Bulletin 65 Supplement C (Edition 01-01)



3.4 Device Category and SAR Limits

This device belongs to portable device category because its radiating structure is allowed to be used within 20 centimeters of the body of the user.

Limit for General Population/Uncontrolled exposure should be applied for this device, it is 1.6 W/kg as averaged over any 1 gram of tissue.

3.5 Test Conditions

3.5.1 Ambient Condition:

| | |
|---|-----------|
| Item | MSL 2450 |
| Ambient Temperature (°C) | 20 ~ 24°C |
| Tissue simulating liquid temperature (°C) | 21.4°C |
| Humidity (%) | < 60% |

3.5.2 Test Configuration:

The data rates for SAR testing are 1Mbps for 802.11b and 6Mbps for 802.11g. Engineering testing software installed on the EUT can provide continuous transmitting RF signal. This RF signal utilized in SAR measurement has almost 100% duty cycle and its crest factor is 1. The measurements were performed on the lowest, middle, and highest channel, i.e. channel 1, channel 6, and channel 11 for each testing position.



4. Specific Absorption Rate (SAR)

4.1 Introduction

SAR is related to the rate at which energy is absorbed per unit mass in an object exposed to a radio field. The SAR distribution in a biological body is complicated and is usually carried out by experimental techniques or numerical modeling. The FCC recommends limits for two tiers of groups, occupational/controlled and general population/uncontrolled, based on a person's awareness and ability to exercise control over his or her exposure. In general, occupational/controlled exposure limits are higher than the limits for general population/uncontrolled.

4.2 SAR Definition

The SAR definition is the time derivative (rate) of the incremental energy (dW) absorbed by (dissipated in) an incremental mass (dm) contained in a volume element (dv) of a given density (ρ). The equation description is as below:

$$\mathbf{SAR} = \frac{d}{dt} \left(\frac{dW}{dm} \right) = \frac{d}{dt} \left(\frac{dW}{\rho dv} \right)$$

SAR is expressed in units of Watts per kilogram (W/kg)

SAR measurement can be either related to the temperature elevation in tissue by

$$\mathbf{SAR} = C \frac{\delta T}{\delta t}$$

, where C is the specific heat capacity, δT is the temperature rise and δt the exposure duration,

or related to the electrical field in the tissue by

$$\mathbf{SAR} = \frac{\sigma |E|^2}{\rho}$$

, where σ is the conductivity of the tissue, ρ is the mass density of the tissue and E is the rms electrical field strength.

However for evaluating SAR of low power transmitter, electrical field measurement is typically applied.

5. SAR Measurement Setup

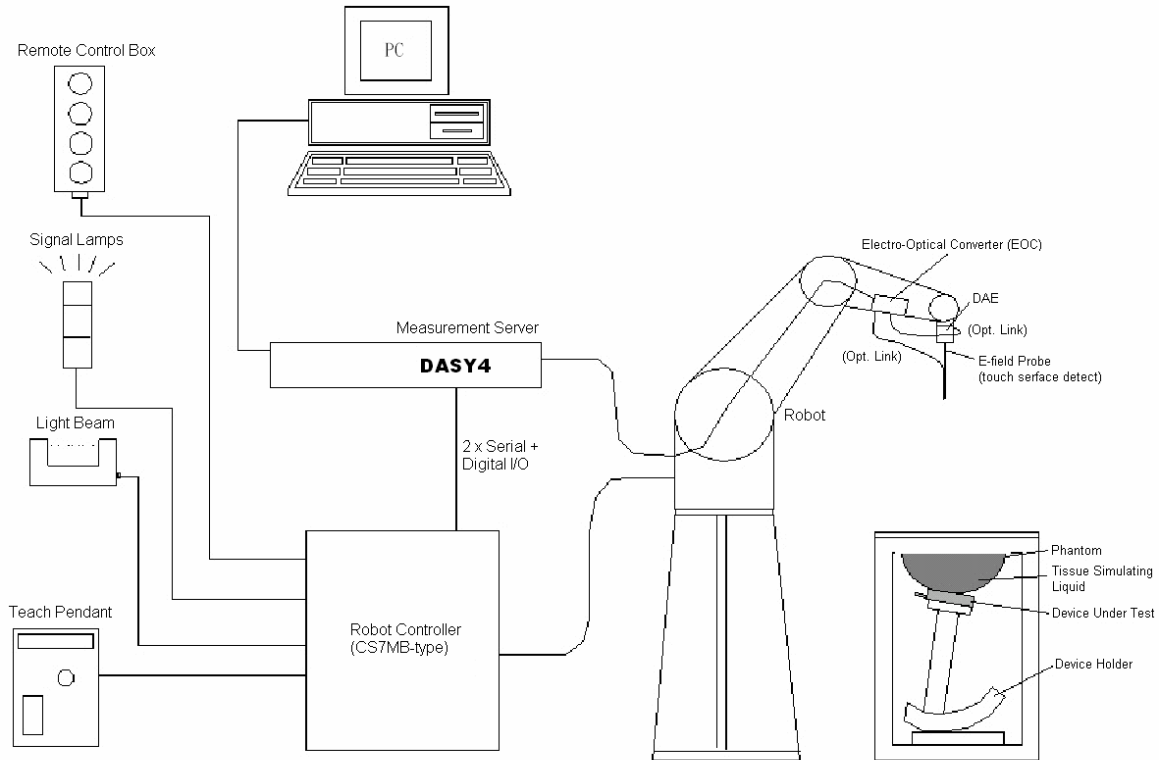

Fig. 5.1 DASY4 system



The DASY4 system for performance compliance tests is illustrated above graphically. This system consists of the following items:

- A standard high precision 6-axis robot with controller, a teach pendant and software
- A data acquisition electronic (DAE) attached to the robot arm extension
- A dosimetric probe equipped with an optical surface detector system
- The electro-optical converter (ECO) performs the conversion between optical and electrical signals
- A measurement server performs the time critical tasks such as signal filtering, control of the robot operation and fast movement interrupts.
- A probe alignment unit which improves the accuracy of the probe positioning
- A computer operating Windows XP
- DASY4 software
- Remove control with teach pendant and additional circuitry for robot safety such as warning lamps, etc.
- The SAM twin phantom
- A device holder
- Tissue simulating liquid
- Dipole for evaluating the proper functioning of the system

Some of the components are described in details in the following sub-sections.

5.1 DASY4 E-Field Probe System

The SAR measurement is conducted with the dosimetric probe ET3DV6 (manufactured by SPEAG). The probe is specially designed and calibrated for use in liquid with high permittivity. The dosimetric probe has special calibration in liquid at different frequency. This probe has a built in optical surface detection system to prevent from collision with phantom.

5.1.1 ET3DV6 E-Field Probe Specification

| | |
|--------------------------|--|
| Construction | Symmetrical design with triangular core Built-in optical fiber for surface detection system Built-in shielding against static charges PEEK enclosure material (resistant to organic solvents) |
| Calibration | Simulating tissue at frequencies of 900MHz, 1.8GHz and 2.45GHz for brain and muscle (accuracy $\pm 8\%$) |
| Frequency | 10 MHz to > 3 GHz |
| Directivity | ± 0.2 dB in brain tissue (rotation around probe axis) ± 0.4 dB in brain tissue (rotation perpendicular to probe axis) |
| Dynamic Range | 5μ W/g to > 100mW/g; Linearity: ± 0.2 dB |
| Surface Detection | ± 0.2 mm repeatability in air and clear liquids on reflecting surface |
| Dimensions | Overall length: 330mm Tip length: 16mm Body diameter: 12mm Tip diameter: 6.8mm Distance from probe tip to dipole centers: 2.7mm |
| Application | General dosimetry up to 3GHz Compliance tests for mobile phones and Wireless LAN Fast automatic scanning in arbitrary phantoms |



Fig. 5.2 Probe setup on robot

5.1.2 ET3DV6 E-Field Probe Calibration

Each probe needs to be calibrated according to a dosimetric assessment procedure with accuracy better than $\pm 10\%$. The spherical isotropy shall be evaluated and within ± 0.25 dB. The sensitivity parameters (NormX, NormY, and NormZ), the diode compression parameter (DCP) and the conversion factor (ConvF) of the probe are tested. The calibration data are as below:



<ET3DV6 Probe>

| | | | | |
|---------------------------------|------------------------|-----------------------|-----------------------|---------------|
| Sensitivity | X axis : 1.57 μ V | Y axis : 1.71 μ V | Z axis : 2.09 μ V | |
| Diode compression point | X axis : 94 mV | Y axis : 94 mV | Z axis : 94 mV | |
| Conversion factor (Body) | Frequency (MHz) | X axis | Y axis | Z axis |
| | 2350~2550 | 4.11 | 4.11 | 4.11 |
| Boundary effect (Body) | Frequency (MHz) | Alpha | Depth | |
| | 2350~2550 | 0.60 | 1.70 | |

NOTE:

1. The probe parameters have been calibrated by the SPEAG.

5.2 DATA Acquisition Electronics (DAE)

The data acquisition electronics (DAE4) consists of a highly sensitive electrometer-grade preamplifier with auto-zeroing, a channel and gain-switching multiplexer, a fast 16 bit AD-converter and a command decoder and control logic unit. Transmission to the measurement server is accomplished through an optical downlink for data and status information as well as an optical uplink for commands and the clock.

The mechanical probe mounting device includes two different sensor systems for frontal and sideways probe contacts. They are used for mechanical surface detection and probe collision detection.

The input impedance of the DAE4 is 200M Ohm; the inputs are symmetrical and floating. Common mode rejection is above 80dB.



5.3 Robot

The DASY4 system uses the high precision robots RX90BL type out of the newer series from Stäubli SA (France). For the 6-axis controller DASY4 system, the CS7MB robot controller version from Stäubli is used. The RX robot series have many features that are important for our application:

- High precision (repeatability 0.02 mm)
- High reliability (industrial design)
- Jerk-free straight movements
- Low ELF interference (the closed metallic construction shields against motor control fields)
- 6-axis controller

5.4 Measurement Server

The DASY4 measurement server is based on a PC/104 CPU board with
166 MHz CPU
32 MB chipset and
64 MB RAM.

Communication with
the DAE4 electronic box
the 16-bit AD-converter system for optical detection and digital I/O interface.

The measurement server performs all the real-time data evaluation for field measurements and surface detection, controls robot movements and handles safety operations.

5.5 SAM Twin Phantom

The SAM twin phantom is a fiberglass shell phantom with 2mm shell thickness (except the ear region where shell thickness increases to 6mm). It has three measurement areas:

- Left head
- Right head
- Flat phantom

The bottom plate contains three pair of bolts for locking the device holder. The device holder positions are adjusted to the standard measurement positions in the three sections.



A white cover is provided to tap the phantom during off-periods to prevent water evaporation and changes in the liquid parameters.

On the phantom top, three reference markers are provided to identify the phantom position with respect to the robot.

The phantom can be used with the following tissue simulating liquids:

- *Water-sugar based liquid
- *Glycol based liquids

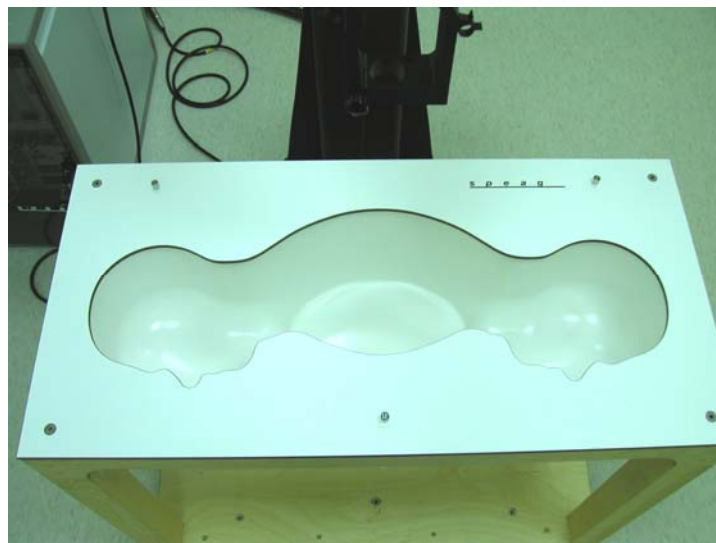

Fig. 5.3 Top view of twin phantom



Fig. 5.4 Bottom view of twin phantom



5.6 Data Storage and Evaluation

5.6.1 Data Storage

The DASY4 software stores the assessed data from the data acquisition electronics as raw data (in microvolt readings from the probe sensors), together with all the necessary software parameters for the data evaluation (probe calibration data, liquid parameters and device frequency and modulation data) in measurement files with the extension .DA4. The post-processing software evaluates the desired unit and format for output each time the data is visualized or exported. This allows verification of the complete software setup even after the measurement and allows correction of erroneous parameter settings. For example, if a measurement has been performed with an incorrect crest factor parameter in the device setup, the parameter can be corrected afterwards and the data can be reevaluated.

The measured data can be visualized or exported in different units or formats, depending on the selected probe type (e.g., [V/m], [A/m], [mW/g]). Some of these units are not available in certain situations or give meaningless results, e.g., a SAR-output in a non-lossy media, will always be zero. Raw data can also be exported to perform the evaluation with other software packages.

5.6.2 Data Evaluation

The DASY4 post-processing software (SEMCAD) automatically executes the following procedures to calculate the field units from the microvolt readings at the probe connector. The parameters used in the evaluation are stored in the configuration modules of the software :

| | | |
|----------------------------|---------------------------|----------------------------------|
| Probe parameters : | - Sensitivity | $Norm_i, a_{i0}, a_{i1}, a_{i2}$ |
| | - Conversion factor | $ConvF_i$ |
| | - Diode compression point | dcp_i |
| Device parameters : | - Frequency | f |
| | - Crest factor | cf |
| Media parameters : | - Conductivity | σ |
| | - Density | ρ |

These parameters must be set correctly in the software. They can be found in the component documents or they can be imported into the software from the configuration files issued for the DASY components. In the direct measuring mode of the multi-meter option, the parameters of the actual system setup are used. In the scan visualization and export modes, the parameters stored in the corresponding document files are used.

The first step of the evaluation is a linearization of the filtered input signal to account for the compression characteristics of the detector diode. The compensation depends on the input signal, the diode type and the DC-transmission factor from the diode to the evaluation electronics. If the exciting field is pulsed, the crest factor of the signal must be known to correctly compensate for peak power. The formula for each channel



can be given as :

$$V_i = U_i + U_i^2 \cdot \frac{cf}{dcp_i}$$

with $V_i =$ compensated signal of channel i ($i = x, y, z$)
 $U_i =$ input signal of channel i ($i = x, y, z$)
 $cf =$ crest factor of exciting field (DASY parameter)
 $dcp_i =$ diode compression point (DASY parameter)

From the compensated input signals, the primary field data for each channel can be evaluated :

E-field probes : $E_i = \sqrt{\frac{V_i}{Norm_i ConvF}}$

H-field probes : $H_i = \sqrt{V_i \frac{a_{i0} + a_{i1}f + a_{i2}f^2}{f}}$

with $V_i =$ compensated signal of channel i ($i = x, y, z$)
 $Norm_i =$ sensor sensitivity of channel i ($i = x, y, z$)
 $\mu V/(V/m)^2$ for E-field Probes
 $ConvF =$ sensitivity enhancement in solution
 $a_{ij} =$ sensor sensitivity factors for H-field probes
 $f =$ carrier frequency [GHz]
 $E_i =$ electric field strength of channel i in V/m
 $H_i =$ magnetic field strength of channel i in A/m

The RSS value of the field components gives the total field strength (Hermitian magnitude) :

$$E_{tot} = \sqrt{E_x^2 + E_y^2 + E_z^2}$$

The primary field data are used to calculate the derived field units.

$$SAR = E_{tot}^2 \cdot \frac{\sigma}{\rho \cdot 1000}$$

with $SAR =$ local specific absorption rate in mW/g
 $E_{tot} =$ total field strength in V/m
 $\sigma =$ conductivity in [mho/m] or [Siemens/m]
 $\rho =$ equivalent tissue density in g/ cm³



* Note that the density is set to 1, to account for actual head tissue density rather than the density of the tissue simulating liquid.

The power flow density is calculated assuming the excitation field to be a free space field.

$$P_{pwe} = \frac{E_{tot}^2}{3770} \quad \text{or} \quad P_{pwe} = H_{tot}^2 \cdot 37.7$$

with P_{pwe} = equivalent power density of a plane wave in mW/cm²
 E_{tot} = total electric field strength in V/m
 H_{tot} = total magnetic field strength in A/m



5.7 Test Equipment List

| Manufacture | Name of Equipment | Type/Model | Serial Number | Calibration | |
|-------------|---------------------------------|-----------------------|-----------------|---------------|---------------|
| | | | | Last Cal. | Due Date |
| SPEAG | Dosimetric E-Filed Probe | ET3DV6 | 1788 | Sep 19, 2006 | Sep. 19, 2007 |
| SPEAG | 2450MHz System Validation Kit | D2450V2 | 736 | Jul. 12, 2007 | Jul. 12, 2009 |
| SPEAG | Data Acquisition Electronics | DAE3 | 577 | Nov. 21, 2006 | Nov. 21, 2007 |
| SPEAG | Device Holder | N/A | N/A | NCR | NCR |
| SPEAG | Phantom | QD 000 P40 C | TP-1150 | NCR | NCR |
| SPEAG | Robot | Staubli RX90BL | F03/5W15A1/A/01 | NCR | NCR |
| SPEAG | Software | DASY4 V4.7 Build 53 | N/A | NCR | NCR |
| SPEAG | Software | SEMCAD V1.8 Build 172 | N/A | NCR | NCR |
| SPEAG | Measurement Server | SE UMS 001 BA | 1021 | NCR | NCR |
| Agilent | ENA Series Network Analyzer | E5071C | MY46100746 | Feb. 21, 2007 | Feb. 21, 2008 |
| Agilent | Wireless Communication Test Set | E5515C | GB46311322 | Dec. 22, 2006 | Dec. 22, 2008 |
| Agilent | Dielectric Probe Kit | 85070D | US01440205 | NCR | NCR |
| Agilent | Dual Directional Coupler | 778D | 50422 | NCR | NCR |
| Agilent | Power Amplifier | 8449B | 3008A01917 | NCR | NCR |
| Agilent | Power Meter | E4416A | GB41292344 | Feb. 08, 2007 | Feb. 08, 2008 |
| Agilent | Power Sensor | E9327A | US40441548 | Feb. 08, 2007 | Feb. 08, 2008 |
| Agilent | Signal Generator | E8247C | MY43320596 | Mar. 01, 2006 | Mar. 01, 2008 |

Table 5.1 Test Equipment List



6. Tissue Simulating Liquids

For the measurement of the field distribution inside the SAM phantom with DAS4, the phantom must be filled with around 25 liters of homogeneous body tissue simulating liquid. The liquid height from the bottom of the phantom body is 15.2 centimeters, which is shown in Fig. 6.1.

The following ingredients for tissue simulating liquid are used:

- **Water:** deionized water (pure H₂O), resistivity $\geq 16M\Omega$ - as basis for the liquid
- **Sugar:** refined sugar in crystals, as available in food shops – to reduce relative permittivity
- **Salt:** pure NaCl – to increase conductivity
- **Cellulose:** Hydroxyethyl-cellulose, medium viscosity (75-125 mPa.s, 2% in water, 20°C), CAS#54290-to increase viscosity and to keep sugar in solution.
- **Preservative:** Preventol D-7 Bayer AG, D-51368 Leverkusen, CAS#55965-84-9- to prevent the spread of bacteria and molds.
- **DGMBE:** Deithlenglycol-monobuthyl ether (DGMBE), Fluka Chemie GmbH, CAS#112-34-5 – to reduce relative permittivity.

Table 6.1 gives the recipes for one liter of tissue simulating liquid for frequency band 2450 MHz.

| Ingredient | MSL-2450 |
|------------------------------|--|
| Water | 698.3 ml |
| DGMBE | 301.7 ml |
| Total amount | 1 liter (1.0 kg) |
| Dielectric Parameters at 22° | f = 2450MHz $\epsilon_r = 52.7 \pm 5\%$, $\sigma = 1.95 \pm 5\%$ S/m |

Table 6.1 Recipes for Tissue Simulating Liquid

The dielectric parameters of the liquids were verified prior to the SAR evaluation using an Agilent 85070D Dielectric Probe Kit and an Agilent Network Analyzer.

Table 6.2 shows the measuring results for muscle simulating liquid.

| Bands | Frequency(MHz) | Permittivity (ϵ_r) | Conductivity (σ) | Measurement date |
|--------------|-----------------------|---|---|-------------------------|
| 2450 MHz | 2412 | 1.90 | 52.8 | Aug. 18, 2007 |
| | 2437 | 1.94 | 52.8 | |
| | 2462 | 1.97 | 52.7 | |

Table 6.2 Measuring Results for Muscle Simulating Liquid

The measuring data are consistent with $\epsilon_r = 52.7 \pm 5\%$ and $\sigma = 1.95 \pm 5\%$.



Fig. 6.1



7. Uncertainty Assessment

The component of uncertainty may generally be categorized according to the methods used to evaluate them. The evaluation of uncertainty by the statistical analysis of a series of observations is termed a Type A evaluation of uncertainty. The evaluation of uncertainty by means other than the statistical analysis of a series of observation is termed a Type B evaluation of uncertainty. Each component of uncertainty, however evaluated, is represented by an estimated standard deviation, termed standard uncertainty, which is determined by the positive square root of the estimated variance.

A Type A evaluation of standard uncertainty may be based on any valid statistical method for treating data. This includes calculating the standard deviation of the mean of a series of independent observations; using the method of least squares to fit a curve to the data in order to estimate the parameter of the curve and their standard deviations; or carrying out an analysis of variance in order to identify and quantify random effects in certain kinds of measurement.

A type B evaluation of standard uncertainty is typically based on scientific judgment using all of the relevant information available. These may include previous measurement data, experience and knowledge of the behavior and properties of relevant materials and instruments, manufacture’s specification, data provided in calibration reports and uncertainties assigned to reference data taken from handbooks. Broadly speaking, the uncertainty is either obtained from an outdoor source or obtained from an assumed distribution, such as the normal distribution, rectangular or triangular distributions indicated in Table 7.1

| Uncertainty Distributions | Normal | Rectangular | Triangular | U-shape |
|-----------------------------------|--------------------|-------------|------------|---------|
| Multiplying factor ^(a) | 1/k ^(b) | 1/√3 | 1/√6 | 1/√2 |

(a) standard uncertainty is determined as the product of the multiplying factor and the estimated range of variations in the measured quantity

(b) *k* is the coverage factor

Table 7.1

The combined standard uncertainty of the measurement result represents the estimated standard deviation of the result. It is obtained by combining the individual standard uncertainties of both Type A and Type B evaluation using the usual “root-sum-squares” (RSS) methods of combining standard deviations by taking the positive square root of the estimated variances.

Expanded uncertainty is a measure of uncertainty that defines an interval about the measurement result within which the measured value is confidently believed to lie. It is obtained by multiplying the combined standard uncertainty by a coverage factor. Typically, the coverage factor ranges from 2 to 3. Using a coverage factor allows the true value of a measured quantity to be specified with a defined probability within the specified uncertainty range. For purpose of this document, a coverage factor two is used, which corresponds to confidence interval of about 95 %. The DASY4 uncertainty Budget is showed in Table 7.2.



| Error Description | Uncertainty Value \pm % | Probability Distribution | Divisor | C_i lg | Standard Unc. (1-g) | v_i or V_{eff} |
|--|---------------------------|--------------------------|------------------------|---------------|------------------------------|--------------------------|
| Measurement System | | | | | | |
| Probe Calibration | ± 4.8 | Normal | 1 | 1 | ± 4.8 | ∞ |
| Axial Isotropy | ± 4.7 | Rectangular | $\sqrt{3}$ | 0.7 | ± 1.9 | ∞ |
| Hemispherical Isotropy | ± 9.6 | Rectangular | $\sqrt{3}$ | 0.7 | ± 3.9 | ∞ |
| Boundary Effect | ± 1.0 | Rectangular | $\sqrt{3}$ | 1 | ± 0.6 | ∞ |
| Linearity | ± 4.7 | Rectangular | $\sqrt{3}$ | 1 | ± 2.7 | ∞ |
| System Detection Limit | ± 1.0 | Rectangular | $\sqrt{3}$ | 1 | ± 0.6 | ∞ |
| Readout Electronics | ± 1.0 | Normal | 1 | 1 | ± 1.0 | ∞ |
| Response Time | ± 0.8 | Rectangular | $\sqrt{3}$ | 1 | ± 0.5 | ∞ |
| Integration time | ± 2.6 | Rectangular | $\sqrt{3}$ | 1 | ± 1.5 | ∞ |
| RF Ambient Conditions | ± 3.0 | Rectangular | $\sqrt{3}$ | 1 | ± 1.7 | ∞ |
| Probe Positioner Mech. Tolerance | ± 0.4 | Rectangular | $\sqrt{3}$ | 1 | ± 0.2 | ∞ |
| Probe Positioning with respect to Phantom Shell | ± 2.9 | Rectangular | $\sqrt{3}$ | 1 | ± 1.7 | ∞ |
| Extrapolation and Interpolation Algorithms for Max. SAR Evaluation | ± 1.0 | Rectangular | $\sqrt{3}$ | 1 | ± 0.6 | ∞ |
| Test sample Related | | | | | | |
| Test sample Positioning | ± 2.9 | Normal | 1 | 1 | ± 2.9 | 145 |
| Device Holder Uncertainty | ± 3.6 | Normal | 1 | 1 | ± 3.6 | 5 |
| Output Power Variation-SAR drift measurement | ± 5.0 | Rectangular | $\sqrt{3}$ | 1 | ± 2.9 | ∞ |
| Phantom and Setup | | | | | | |
| Phantom uncertainty(Including shape and thickness tolerances) | ± 4.0 | Rectangular | $\sqrt{3}$ | 1 | ± 2.3 | ∞ |
| Liquid Conductivity Target tolerance | ± 5.0 | Rectangular | $\sqrt{3}$ | 0.64 | ± 1.8 | ∞ |
| Liquid Conductivity measurement uncertainty | ± 2.5 | Normal | 1 | 0.64 | ± 1.6 | ∞ |
| Liquid Permittivity Target tolerance | ± 5.0 | Rectangular | $\sqrt{3}$ | 0.6 | ± 1.7 | ∞ |
| Liquid Permittivity measurement uncertainty | ± 2.5 | Normal | 1 | 0.6 | ± 1.5 | ∞ |
| Combined standard uncertainty | | | | | ± 10.3 | 330 |
| Coverage Factor for 95 % | | $K=2$ | | | | |
| Expanded uncertainty (Coverage factor = 2) | | | Normal (k=2) 27 | | ± 20.6 | |

Table 7.2 Uncertainty Budget of DASY

8. SAR Measurement Evaluation

Each DASY system is equipped with one or more system validation kits. These units, together with the predefined measurement procedures within the DASY software, enable the user to conduct the system performance check and system validation. System validation kit includes a dipole, tripod holder to fix it underneath the flat phantom and a corresponding distance holder.

8.1 Purpose of System Performance check

The system performance check verifies that the system operates within its specifications. System and operator errors can be detected and corrected. It is recommended that the system performance check be performed prior to any usage of the system in order to guarantee reproducible results. The system performance check uses normal SAR measurements in a simplified setup with a well characterized source. This setup was selected to give a high sensitivity to all parameters that might fail or vary over time. The system check does not intend to replace the calibration of the components, but indicates situations where the system uncertainty is exceeded due to drift or failure.

8.2 System Setup

In the simplified setup for system evaluation, the DUT is replaced by a calibrated dipole and the power source is replaced by a continuous wave which comes from a signal generator at frequency 2450 MHz. The calibrated dipole must be placed beneath the flat phantom section of the SAM twin phantom with the correct distance holder. The distance holder should touch the phantom surface with a light pressure at the reference marking and be oriented parallel to the long side of the phantom. The equipment setup is shown below:

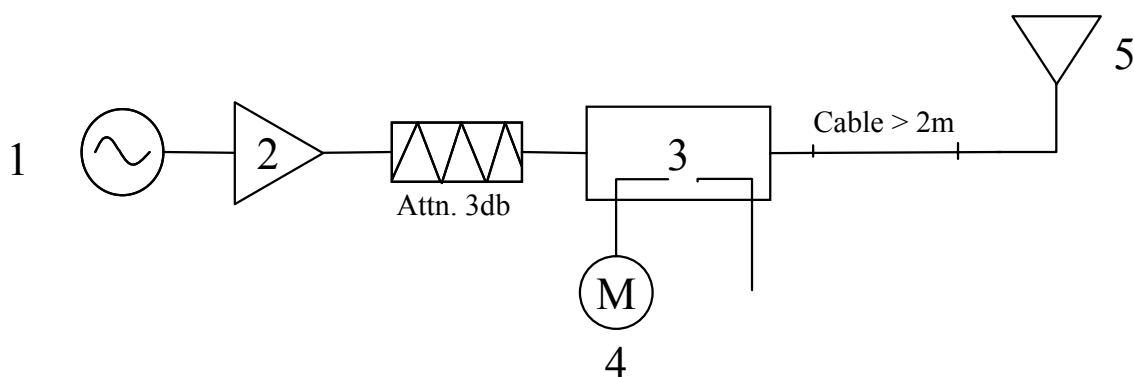

Fig. 8.1 System Evaluation Setup



1. Signal Generator
2. Amplifier
3. Directional Coupler
4. Power Meter
5. 2450 MHz Dipole

The output power on dipole port must be calibrated to 100 mW (20 dBm) before dipole is connected.



Fig 8.2 Dipole Setup



8.3 Validation Results

Comparing to the original SAR value provided by SPEAG, the validation data should within its specification of 10 %. Table 8.1 shows the target SAR and measured SAR after normalized to 1W input power.

| | | Target (W/kg) | Measurement data (W/kg) | Variation | Measurement date |
|----------|-----------|----------------------|--------------------------------|------------------|-------------------------|
| 2450 MHz | SAR (1g) | 52.8 | 53.9 | 2.7 % | Aug. 18, 2007 |
| | SAR (10g) | 24.5 | 25.1 | 2.9 % | |

Table 8.1 Targets SAR and Measured SAR after Normalized to 1W Input Power

The table above indicates the system performance check can meet the variation criterion.



9. Description for DUT Testing Position

This DUT was tested in 2 different positions. They are body worn with keypad up and body worn with keypad down as illustrated below:

- 1) “ Body Worn”
 - i) To position the device parallel to the phantom surface.
 - ii) To adjust the phone parallel to the flat phantom.
 - iii) To adjust the distance between the EUT surface and the flat phantom to 1.5 cm.

Remark: Please refer to Appendix E for the test setup photo.



10. Measurement Procedures

The measurement procedures are as follows:

- Using engineering software to transmit RF power continuously (continuous Tx) in the low channel
- Placing the DUT in the positions described in the last section
- Setting scan area, grid size and other setting on the DASY4 software
- Taking data for the low channel
- Repeat the previous steps for the middle and high channels.

According to the IEEE P1528 draft standard, the recommended procedure for assessing the peak spatial-average SAR value consists of the following steps:

- Power reference measurement
- Area scan
- Zoom scan
- Power reference measurement

10.1 Spatial Peak SAR Evaluation

The procedure for spatial peak SAR evaluation has been implemented according to the IEEE1528-2003 standard. It can be conducted for 1g and 10g, as well as for user-specific masses. The DASY4 software includes all numerical procedures necessary to evaluate the spatial peak SAR value.

Base on the Draft: SCC-34, SC-2, WG-2-Computational Dosimetry, P1528/D1.2 (Recommended Practice for Determining the Peak Spatial-Average Specific Absorption Rate (SAR) in the Human Head from Wireless Communications Devices: Measurement Techniques), a new algorithm has been implemented. The spatial-peak SAR can be computed over any required mass.

The base for the evaluation is a "cube" measurement. The measured volume must include the 1g and 10g cubes with the highest averaged SAR values. For that purpose , the center of the measured volume is aligned to the interpolated peak SAR value of a previously performed area scan.



The entire evaluation of the spatial peak values is performed within the post-processing engine (SEMCAD). The system always gives the maximum values for the 1g and 10g cubes. The algorithm to find the cube with highest averaged SAR is divided into the following stages:

- extraction of the measured data (grid and values) from the Zoom Scan
- calculation of the SAR value at every measurement point based on all stored data (A/D values and measurement parameters)
- generation of a high-resolution mesh within the measured volume
- interpolation of all measured values from the measurement grid to the high-resolution grid
- extrapolation of the entire 3-D field distribution to the phantom surface over the distance from sensor to surface
- calculation of the averaged SAR within masses of 1g and 10g

10.2 Scan Procedures

First Area Scan is used to locate the approximate location(s) of the local peak SAR value(s). The measurement grid within an Area Scan is defined by the grid extent, grid step size and grid offset. Next, in order to determine the EM field distribution in a three-dimensional spatial extension, Zoom Scan is required. The Zoom Scan measures 5x5x7 points with step size 8, 8 and 5 mm. The Zoom Scan is performed around the highest E-field value to determine the averaged SAR-distribution over 1 g.

10.3 SAR Averaged Methods

In DASY4, the interpolation and extrapolation are both based on the modified Quadratic Shepard's method. The interpolation scheme combines a least-square fitted function method and a weighted average method which are the two basic types of computational interpolation and approximation.

Extrapolation routines are used to obtain SAR values between the lowest measurement points and the inner phantom surface. The extrapolation distance is determined by the surface detection distance and the probe sensor offset. The uncertainty increases with the extrapolation distance. To keep the uncertainty within 1% for the 1 g and 10 g cubes, the extrapolation distance should not be larger than 5 mm.



11. SAR Test Results

11.1 Keypad Up with 1.5cm Gap

| Mode | Chan. | Freq (MHz) | Modulation type | Conducted Power (dBm) | Power Drift (dB) | Measured 1g SAR (W/kg) | Limits (W/Kg) | Results |
|---------|-------|------------|-----------------|-----------------------|------------------|------------------------|---------------|---------|
| 802.11b | 1 | 2412(Low) | CCK | 12.80 | - | - | - | - |
| | 6 | 2437(Mid) | CCK | 12.41 | 0.142 | 0.037 | 1.6 | Pass |
| | 11 | 2462(High) | CCK | 12.47 | - | - | - | - |
| 802.11g | 1 | 2412(Low) | OFDM | 15.04 | - | - | - | - |
| | 6 | 2437(Mid) | OFDM | 14.44 | - | - | - | - |
| | 11 | 2462(High) | OFDM | 14.64 | - | - | - | - |

11.2 Keypad Down with 1.5cm Gap

| Mode | Chan. | Freq (MHz) | Modulation type | Conducted Power (dBm) | Power Drift (dB) | Measured 1g SAR (W/kg) | Limits (W/Kg) | Results |
|---------|-------|------------|-----------------|-----------------------|------------------|------------------------|---------------|---------|
| 802.11b | 1 | 2412(Low) | CCK | 12.80 | 0.021 | 0.06 | 1.6 | Pass |
| | 6 | 2437(Mid) | CCK | 12.41 | 0.105 | 0.056 | 1.6 | Pass |
| | 11 | 2462(High) | CCK | 12.47 | -0.128 | 0.049 | 1.6 | Pass |
| 802.11g | 1 | 2412(Low) | OFDM | 15.04 | - | - | - | - |
| | 6 | 2437(Mid) | OFDM | 14.44 | 0.181 | 0.026 | 1.6 | Pass |
| | 11 | 2462(High) | OFDM | 14.64 | - | - | - | - |

Test Engineer : Eric Huang



12. Reference

- [1] FCC 47 CFR Part 2 “Frequency Allocations and Radio Treaty Matters; General Rules and Regulations”
- [2] IEEE Std. P1528-2003, “Recommended Practice for Determining the Peak Spatial-Average Specific Absorption Rate (SAR) in the Human Head from Wireless Communications Devices: Measurement Techniques”, April 21, 2003.
- [3] Supplement C (Edition 01-01) to OET Bulletin 65 (Edition 97-01), “Additional Information for Evaluating Compliance of Mobile and Portable Devices with FCC Limits for Human Exposure to RF Emissions”, June 2001
- [4] IEEE Std. C95.3-2002, “IEEE Recommended Practice for the Measurement of Potentially Hazardous Electromagnetic Fields-RF and Microwave”, 2002
- [5] IEEE Std. C95.1-1999, “IEEE Standard for Safety Levels with Respect to Human Exposure to Radio Frequency Electromagnetic Fields, 3 kHz to 300 GHz”, 1999
- [6] Robert J. Renka, “Multivariate Interpolation Of Large Sets Of Scattered Data”, University of North Texas ACM Transactions on Mathematical Software, vol. 14, no. 2, June 1988, pp. 139-148
- [7] DAYS4 System Handbook



Appendix A - System Performance Check Data

Test Laboratory: Sporton International Inc. SAR Testing Lab

Date: 2007/8/18

System Check_Body_2450MHz

DUT: Dipole 2450 MHz

Communication System: CW; Frequency: 2450 MHz; Duty Cycle: 1:1

Medium: MSL_2450 Medium parameters used: $f = 2450$ MHz; $\sigma = 1.96$ mho/m; $\epsilon_r = 52.8$; $\rho = 1000$ kg/m³

Ambient Temperature : 22.8 °C; Liquid Temperature : 21.4 °C

DASY4 Configuration:

- Probe: ET3DV6 - SN1788; ConvF(4.11, 4.11, 4.11); Calibrated: 2006/9/19

- Sensor-Surface: 4mm (Mechanical And Optical Surface Detection) Sensor-Surface: 4mm (Mechanical Surface Detection)

- Electronics: DAE3 Sn577; Calibrated: 2006/11/21

- Phantom: SAM-B; Type: QD 000 P40 C; Serial: TP-1383

- Measurement SW: DASY4, V4.7 Build 53; Postprocessing SW: SEMCAD, V1.8 Build 172

Pin=100mW/Area Scan (91x91x1): Measurement grid: dx=10mm, dy=10mm

Maximum value of SAR (interpolated) = 6.21 mW/g

Pin=100mW/Zoom Scan (7x7x7)/Cube 0: Measurement grid: dx=5mm, dy=5mm, dz=5mm

Reference Value = 57.2 V/m; Power Drift = 0.007 dB

Peak SAR (extrapolated) = 12.5 W/kg

SAR(1 g) = 5.39 mW/g; SAR(10 g) = 2.51 mW/g

Maximum value of SAR (measured) = 5.97 mW/g

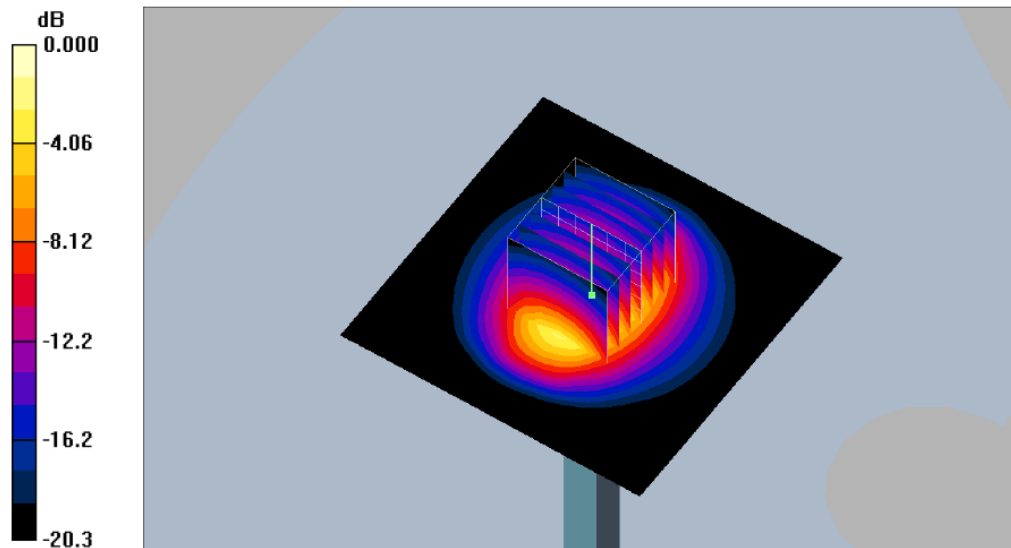



Appendix B - SAR Measurement Data

Test Laboratory: Sporton International Inc. SAR Testing Lab

Date: 2007/8/18

Body_802.11b Ch6_Keypad Up with 1.5cm Gap

DUT: 782102

Communication System: 802.11b ; Frequency: 2437 MHz;Duty Cycle: 1:1

Medium: MSL_2450 Medium parameters used: $f = 2437$ MHz; $\sigma = 1.94$ mho/m; $\epsilon_r = 52.8$; $\rho = 1000$ kg/m³

Ambient Temperature : 22.8 °C; Liquid Temperature : 21.4 °C

DASY4 Configuration:

- Probe: ET3DV6 - SN1788; ConvF(4.11, 4.11, 4.11); Calibrated: 2006/9/19
- Sensor-Surface: 4mm (Mechanical Surface Detection)
- Electronics: DAE3 Sn577; Calibrated: 2006/11/21
- Phantom: SAM-B; Type: QD 000 P40 C; Serial: TP-1383
- Measurement SW: DASY4, V4.7 Build 53; Postprocessing SW: SEMCAD, V1.8 Build 172

Ch6/Area Scan (51x91x1): Measurement grid: dx=15mm, dy=15mm

Maximum value of SAR (interpolated) = 0.039 mW/g

Ch6/Zoom Scan (5x5x7)/Cube 0: Measurement grid: dx=8mm, dy=8mm, dz=5mm

Reference Value = 4.22 V/m; Power Drift = 0.142 dB

Peak SAR (extrapolated) = 0.075 W/kg

SAR(1 g) = 0.037 mW/g; SAR(10 g) = 0.020 mW/g

Maximum value of SAR (measured) = 0.040 mW/g

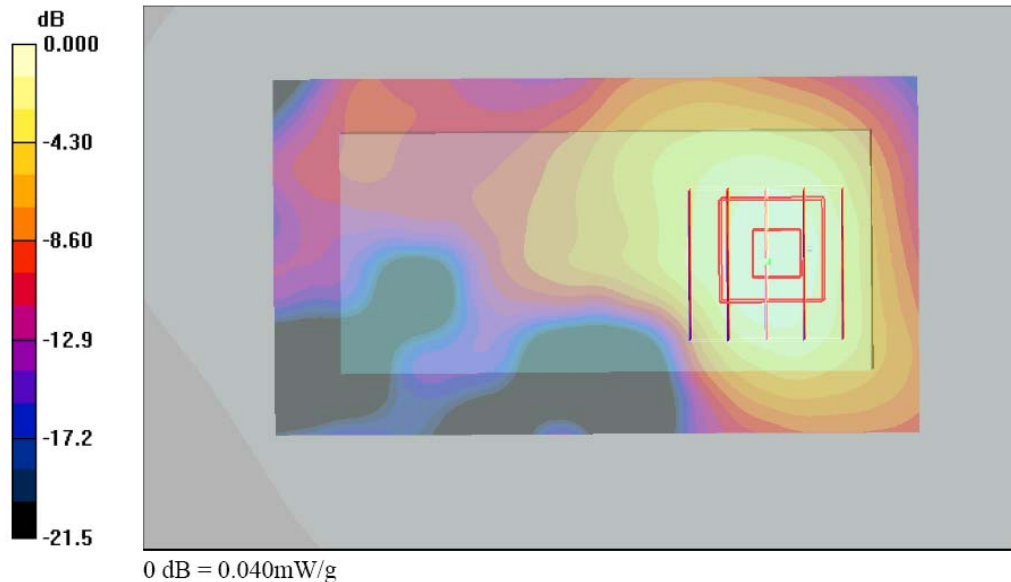



Test Laboratory: Sporton International Inc. SAR Testing Lab

Date: 2007/8/18

Body_802.11b Ch1_Keypad Down with 1.5cm Gap

DUT: 782102

Communication System: 802.11b ; Frequency: 2412 MHz;Duty Cycle: 1:1

Medium: MSL_2450 Medium parameters used: $f = 2412$ MHz; $\sigma = 1.9$ mho/m; $\epsilon_r = 52.8$; $\rho = 1000$ kg/m³

Ambient Temperature : 22.8 °C ; Liquid Temperature : 21.4 °C

DASY4 Configuration:

- Probe: ET3DV6 - SN1788; ConvF(4.11, 4.11, 4.11); Calibrated: 2006/9/19

- Sensor-Surface: 4mm (Mechanical Surface Detection)

- Electronics: DAE3 Sn577; Calibrated: 2006/11/21

- Phantom: SAM-B; Type: QD 000 P40 C; Serial: TP-1383

- Measurement SW: DASY4, V4.7 Build 53; Postprocessing SW: SEMCAD, V1.8 Build 172

Ch1/Area Scan (51x91x1): Measurement grid: dx=15mm, dy=15mm

Maximum value of SAR (interpolated) = 0.064 mW/g

Ch1/Zoom Scan (5x5x7)/Cube 0: Measurement grid: dx=8mm, dy=8mm, dz=5mm

Reference Value = 5.78 V/m; Power Drift = 0.021 dB

Peak SAR (extrapolated) = 0.124 W/kg

SAR(1 g) = 0.060 mW/g; SAR(10 g) = 0.035 mW/g

Maximum value of SAR (measured) = 0.062 mW/g

Ch1/Zoom Scan (5x5x7)/Cube 1: Measurement grid: dx=8mm, dy=8mm, dz=5mm

Reference Value = 5.78 V/m; Power Drift = 0.021 dB

Peak SAR (extrapolated) = 0.117 W/kg

SAR(1 g) = 0.057 mW/g; SAR(10 g) = 0.033 mW/g

Maximum value of SAR (measured) = 0.060 mW/g

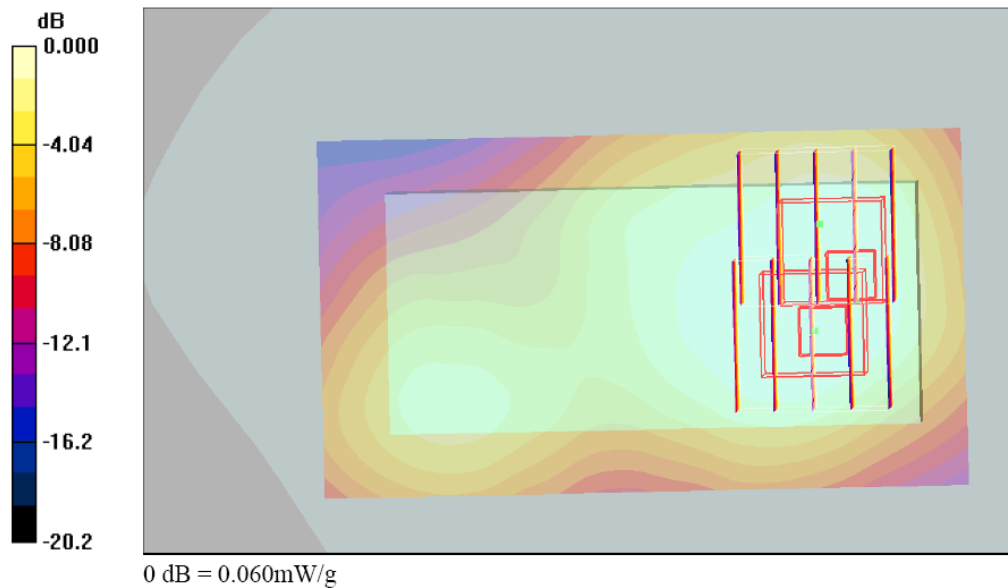



Test Laboratory: Sporton International Inc. SAR Testing Lab

Date: 2007/8/18

Body_802.11g Ch6_Keypad Down with 1.5cm Gap

DUT: 782102

Communication System: 802.11g; Frequency: 2437 MHz; Duty Cycle: 1:1

Medium: MSL_2450 Medium parameters used: $f = 2437$ MHz; $\sigma = 1.94$ mho/m; $\epsilon_r = 52.8$; $\rho = 1000$ kg/m³

Ambient Temperature : 22.9 °C; Liquid Temperature : 21.4 °C

DASY4 Configuration:

- Probe: ET3DV6 - SN1788; ConvF(4.11, 4.11, 4.11); Calibrated: 2006/9/19
- Sensor-Surface: 4mm (Mechanical Surface Detection)
- Electronics: DAE3 Sn577; Calibrated: 2006/11/21
- Phantom: SAM-B; Type: QD 000 P40 C; Serial: TP-1383
- Measurement SW: DASY4, V4.7 Build 53; Postprocessing SW: SEMCAD, V1.8 Build 172

Ch6/Area Scan (51x91x1): Measurement grid: dx=15mm, dy=15mm

Maximum value of SAR (interpolated) = 0.024 mW/g

Ch6/Zoom Scan (5x5x7)/Cube 0: Measurement grid: dx=8mm, dy=8mm, dz=5mm

Reference Value = 3.49 V/m; Power Drift = 0.181 dB

Peak SAR (extrapolated) = 0.055 W/kg

SAR(1 g) = 0.026 mW/g; SAR(10 g) = 0.015 mW/g

Maximum value of SAR (measured) = 0.027 mW/g

Ch6/Zoom Scan (5x5x7)/Cube 1: Measurement grid: dx=8mm, dy=8mm, dz=5mm

Reference Value = 3.49 V/m; Power Drift = 0.181 dB

Peak SAR (extrapolated) = 0.048 W/kg

SAR(1 g) = 0.022 mW/g; SAR(10 g) = 0.013 mW/g

Maximum value of SAR (measured) = 0.025 mW/g

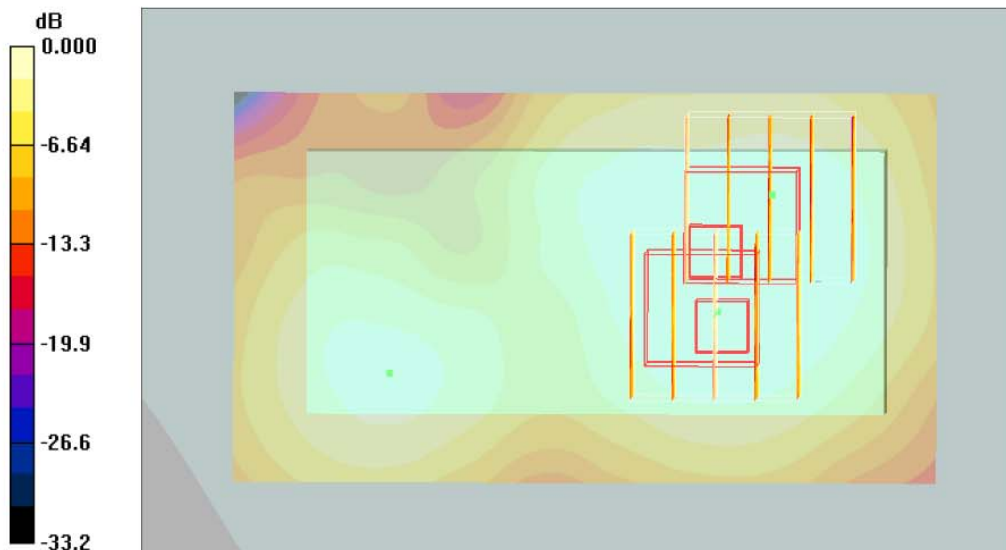



Test Laboratory: Sporton International Inc. SAR Testing Lab

Date: 2007/8/18

Body_802.11b Ch1_Keypad Down with 1.5cm Gap_2D

DUT: 782102

Communication System: 802.11b ; Frequency: 2412 MHz;Duty Cycle: 1:1

Medium: MSL_2450 Medium parameters used: f = 2412 MHz; $\sigma = 1.9$ mho/m; $\epsilon_r = 52.8$; $\rho = 1000$ kg/m³

Ambient Temperature : 22.8 °C ; Liquid Temperature : 21.4 °C

DASY4 Configuration:

- Probe: ET3DV6 - SN1788; ConvF(4.11, 4.11, 4.11); Calibrated: 2006/9/19
- Sensor-Surface: 4mm (Mechanical Surface Detection)
- Electronics: DAE3 Sn577; Calibrated: 2006/11/21
- Phantom: SAM-B; Type: QD 000 P40 C; Serial: TP-1383
- Measurement SW: DASY4, V4.7 Build 53; Postprocessing SW: SEMCAD, V1.8 Build 172

Ch1/Area Scan (51x91x1): Measurement grid: dx=15mm, dy=15mm

Maximum value of SAR (interpolated) = 0.064 mW/g

Ch1/Zoom Scan (5x5x7)/Cube 0: Measurement grid: dx=8mm, dy=8mm, dz=5mm

Reference Value = 5.78 V/m; Power Drift = 0.021 dB

Peak SAR (extrapolated) = 0.124 W/kg

SAR(1 g) = 0.060 mW/g; SAR(10 g) = 0.035 mW/g

Maximum value of SAR (measured) = 0.062 mW/g

Ch1/Zoom Scan (5x5x7)/Cube 1: Measurement grid: dx=8mm, dy=8mm, dz=5mm

Reference Value = 5.78 V/m; Power Drift = 0.021 dB

Peak SAR (extrapolated) = 0.117 W/kg

SAR(1 g) = 0.057 mW/g; SAR(10 g) = 0.033 mW/g

Maximum value of SAR (measured) = 0.060 mW/g

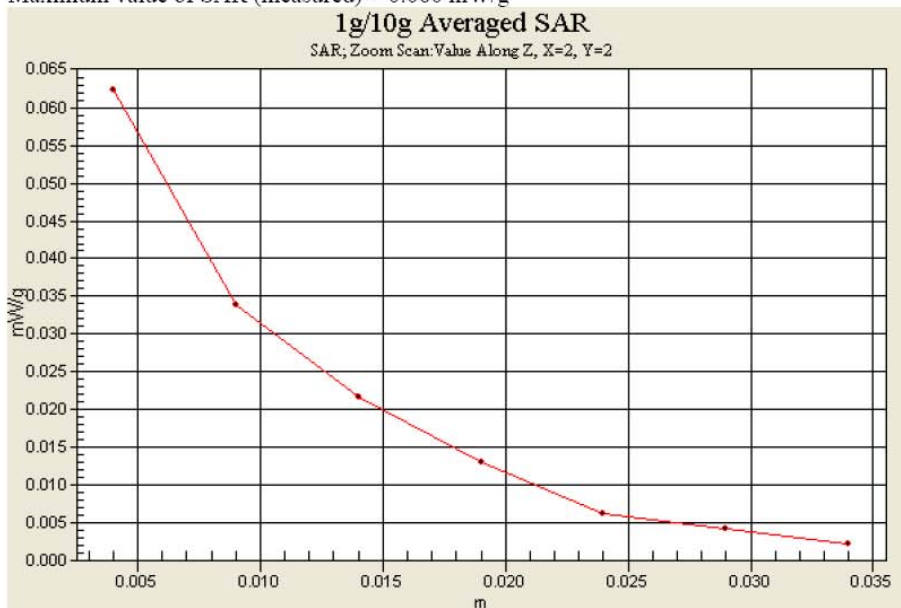



Appendix C – Calibration Data

Calibration Laboratory of Schmid & Partner Engineering AG



S Schweizerischer Kalibrierdienst
C Service suisse d'etalonnage
S Servizio svizzero di taratura
S Swiss Calibration Service

Accredited by the Swiss Federal Office of Metrology and Accreditation
The Swiss Accreditation Service is one of the signatories to the EA
Multilateral Agreement for the recognition of calibration certificates

Accreditation No.: SCS 108

Client Sporton (Auden)

Certificate No: D2450V2-736_Jul07

CALIBRATION CERTIFICATE

Object D2450V2 - SN: 736

Calibration procedure(s) QA CAL-05.v6
Calibration procedure for dipole validation kits

Calibration date: July 12, 2007

Condition of the calibrated item In Tolerance

This calibration certificate documents the traceability to national standards, which realize the physical units of measurements (SI).
The measurements and the uncertainties with confidence probability are given on the following pages and are part of the certificate.

All calibrations have been conducted in the closed laboratory facility: environment temperature (22 ± 3)°C and humidity < 70%.

Calibration Equipment used (M&TE critical for calibration)

Table with 4 columns: Primary Standards, ID #, Cal Date (Calibrated by, Certificate No.), Scheduled Calibration. Includes rows for Power meter EPM-442A, Power sensor HP 8431A, Reference 20 dB Attenuator, Reference 10 dB Attenuator, Reference Probe ES3DV3, DAE4, Secondary Standards, RF generator Agilent E4421B, Network Analyzer HP 8753E.

Calibrated by: Mike Melli, Laboratory Technician
Approved by: Katja Pokovic, Technical Manager

Issued: July 12, 2007

This calibration certificate shall not be reproduced except in full without written approval of the laboratory.



Calibration Laboratory of
Schmid & Partner
Engineering AG
Zeughausstrasse 43, 8004 Zurich, Switzerland



S Schweizerischer Kalibrierdienst
S Service suisse d'étalonnage
C Servizio svizzero di taratura
S Swiss Calibration Service

Accredited by the Swiss Federal Office of Metrology and Accreditation
The Swiss Accreditation Service is one of the signatories to the EA
Multilateral Agreement for the recognition of calibration certificates

Accreditation No.: **SCS 108**

Glossary:

TSL tissue simulating liquid
ConvF sensitivity in TSL / NORM x,y,z
N/A not applicable or not measured

Calibration is Performed According to the Following Standards:

- a) IEEE Std 1528-2003, "IEEE Recommended Practice for Determining the Peak Spatial-Averaged Specific Absorption Rate (SAR) in the Human Head from Wireless Communications Devices: Measurement Techniques", December 2003
- b) IEC 62209-1, "Procedure to measure the Specific Absorption Rate (SAR) for hand-held devices used in close proximity to the ear (frequency range of 300 MHz to 3 GHz)", February 2005
- c) Federal Communications Commission Office of Engineering & Technology (FCC OET), "Evaluating Compliance with FCC Guidelines for Human Exposure to Radiofrequency Electromagnetic Fields; Additional Information for Evaluating Compliance of Mobile and Portable Devices with FCC Limits for Human Exposure to Radiofrequency Emissions", Supplement C (Edition 01-01) to Bulletin 65

Additional Documentation:

- d) DASY4 System Handbook

Methods Applied and Interpretation of Parameters:

- *Measurement Conditions:* Further details are available from the Validation Report at the end of the certificate. All figures stated in the certificate are valid at the frequency indicated.
- *Antenna Parameters with TSL:* The dipole is mounted with the spacer to position its feed point exactly below the center marking of the flat phantom section, with the arms oriented parallel to the body axis.
- *Feed Point Impedance and Return Loss:* These parameters are measured with the dipole positioned under the liquid filled phantom. The impedance stated is transformed from the measurement at the SMA connector to the feed point. The Return Loss ensures low reflected power. No uncertainty required.
- *Electrical Delay:* One-way delay between the SMA connector and the antenna feed point. No uncertainty required.
- *SAR measured:* SAR measured at the stated antenna input power.
- *SAR normalized:* SAR as measured, normalized to an input power of 1 W at the antenna connector.
- *SAR for nominal TSL parameters:* The measured TSL parameters are used to calculate the nominal SAR result.



Measurement Conditions

DASY system configuration, as far as not given on page 1.

| | | |
|------------------------------|---------------------------|-------------|
| DASY Version | DASY4 | V4.7 |
| Extrapolation | Advanced Extrapolation | |
| Phantom | Modular Flat Phantom V5.0 | |
| Distance Dipole Center - TSL | 10 mm | with Spacer |
| Zoom Scan Resolution | dx, dy, dz = 5 mm | |
| Frequency | 2450 MHz ± 1 MHz | |

Head TSL parameters

The following parameters and calculations were applied.

| | Temperature | Permittivity | Conductivity |
|----------------------------------|-----------------|--------------|------------------|
| Nominal Head TSL parameters | 22.0 °C | 39.2 | 1.80 mho/m |
| Measured Head TSL parameters | (22.0 ± 0.2) °C | 38.6 ± 6 % | 1.81 mho/m ± 6 % |
| Head TSL temperature during test | (22.0 ± 0.2) °C | ----- | ----- |

SAR result with Head TSL

| SAR averaged over 1 cm ³ (1 g) of Head TSL | condition | |
|---|--------------------|-----------------------------------|
| SAR measured | 250 mW input power | 13.3 mW / g |
| SAR normalized | normalized to 1W | 53.2 mW / g |
| SAR for nominal Head TSL parameters ¹ | normalized to 1W | 52.7 mW / g ± 17.0 % (k=2) |

| SAR averaged over 10 cm ³ (10 g) of Head TSL | condition | |
|---|--------------------|-----------------------------------|
| SAR measured | 250 mW input power | 6.17 mW / g |
| SAR normalized | normalized to 1W | 24.7 mW / g |
| SAR for nominal Head TSL parameters ¹ | normalized to 1W | 24.5 mW / g ± 16.5 % (k=2) |

¹ Correction to nominal TSL parameters according to d), chapter "SAR Sensitivities"



Body TSL parameters

The following parameters and calculations were applied.

| | Temperature | Permittivity | Conductivity |
|----------------------------------|-----------------|--------------|------------------|
| Nominal Body TSL parameters | 22.0 °C | 52.7 | 1.95 mho/m |
| Measured Body TSL parameters | (22.0 ± 0.2) °C | 53.5 ± 6 % | 1.94 mho/m ± 6 % |
| Body TSL temperature during test | (22.0 ± 0.2) °C | ----- | ----- |

SAR result with Body TSL

| SAR averaged over 1 cm ³ (1 g) of Body TSL | Condition | |
|---|--------------------|-----------------------------------|
| SAR measured | 250 mW input power | 13.0 mW / g |
| SAR normalized | normalized to 1W | 52.0 mW / g |
| SAR for nominal Body TSL parameters ² | normalized to 1W | 52.5 mW / g ± 17.0 % (k=2) |

| SAR averaged over 10 cm ³ (10 g) of Body TSL | Condition | |
|---|--------------------|-----------------------------------|
| SAR measured | 250 mW input power | 6.05 mW / g |
| SAR normalized | normalized to 1W | 24.2 mW / g |
| SAR for nominal Body TSL parameters ² | normalized to 1W | 24.4 mW / g ± 16.5 % (k=2) |

² Correction to nominal TSL parameters according to d), chapter "SAR Sensitivities"