

» STREAM | jockey II



Instruction Manual

Model XTR2CK

To activate your Satellite Radio Receiver or for latest news and questions regarding SIRIUS® Satellite Radio service visit sirius.com or call 1-888-539-SIRIUS (7474).

For accessory & product information visit us at www.getxact.com.

XACT™

SIRIUS
SATELLITE RADIO

KEEPMOVING



This equipment has been tested and found to comply with the limits for a Class B digital device, pursuant to Part 15 of the FCC Rules. These limits are designed to provide reasonable protection against harmful interference in a residential installation. This equipment generates, uses, and can radiate radio frequency energy and, if not installed and used in accordance with the instructions, may cause harmful interference to radio communications. However, there is no guarantee that interference will not occur in a particular installation. If this equipment does cause harmful interference to radio or television reception, which can be determined by turning the equipment off and on, the user is encouraged to try to correct the interference by one or more of the following measures:

- Reorient or relocate the receiving antenna.
- Increase the separation between the equipment and receiver.
- Connect the equipment into an outlet on a circuit different from that to which the receiver is connected.
- Consult the dealer or an experienced radio/TV technician for help.

Changes or modifications not expressly approved by the Manufacturer for compliance could void the user's authority to operate the equipment

NOTE! Use only the appropriate accessories or input devices with your receiver. Use only the 12v Vehicle Adapter that is provided with the kit. It is important that you do not modify it in any way since this will result in damaging your equipment and void the warranty.

COPYRIGHT / TRADEMARKS

No part of this publication may be reproduced, stored in a retrieval system, or transmitted in any form or by any means, whether electronic, mechanical, photocopying, recording or otherwise without the prior writing of the publisher.



is a registered trademark of SIRIUS® Satellite Radio. To activate your Satellite Radio Receiver or for latest news and questions regarding SIRIUS® Satellite Radio service visit sirius.com or call 1-888-539-SIRIUS (7474).

SAFETY PRECAUTIONS

Warning

Follow these notifications to avoid any traffic accidents or personal injury:

1. Installation must be performed according to this user guide.
2. Do not install the device where it may obstruct your view through the windshield or of your vehicle's indicator displays.
3. Do not install the device where it may hinder the function of safety devices such as an airbag. Doing so may prevent the airbag from functioning properly in the event of an accident.
4. The installation and usage suggestions contained in this user guide are subject to any restrictions or limitations that may be imposed by applicable law. The purchaser should check applicable law for any restrictions or limitations before installing and/or operating this device.
5. Failure to follow these safety instructions and warnings may result in a severe accident.

Danger

Be aware of the following precautions to prevent fire and avoid personal injury:

1. To avoid short circuits, never put or leave any metallic objects (coins, tools, etc.) inside the device.
2. If the device emits smoke or strange smells, turn the power off immediately and contact your dealer.
3. Do not drop the device or subject it to strong shocks.
4. If the LCD display becomes damaged or broken, do not touch the liquid crystal fluid. The fluid may be dangerous to your health or even fatal. If the liquid crystal fluid contacts your body or clothing, immediately wash it off with soap and water.

Caution

Do not operate this device in a way that might divert your attention from driving safely. As a driver, you are responsible for safely operating your vehicle in accordance with traffic safety laws at all times.

TABLE OF CONTENTS

Introduction	Page 3
Product Overview	Page 3
Package Contents	Page 3
Components Guide	Page 4
Xact Stream jockey II SIRIUS® Radio	Page 4
Wireless Remote Control	Page 5
Getting Started	Page 6
Mounting Your Xact Stream jockey II Satellite Radio at Home	Page 6
Mounting Your Xact Stream jockey II Satellite Radio in a Vehicle	Page 6
Activating Your SIRIUS® Subscription	Page 7
Basic Operations	Page 10
Tuning to Different Entertainment Categories	Page 10
Searching for Music	Page 11
Searching For Music By Channel	Page 11
Searching For Music By Artist/Composer	Page 11
Searching For Music By Song	Page 12
Direct Tuning	Page 12
Presetting Channels	Page 13
Searching for a Preset Channel/Artist/Song	Page 14
S-Seek Function Memo (Memory Search) Button	Page 15
Performing S-Seek Function	Page 16
Menu Options Settings	Page 18
Basic Setting Procedure	Page 18
SIRIUS® ID	Page 18
Display Settings	Page 19
FM Transmitter	Page 20
Channel Add/Skip	Page 21
Lock Options	Page 21
Audio Level	Page 23
Antenna Aiming	Page 24
SIRIUS® Satellite Map	Page 24
Memory Options	Page 25
Time Features	Page 26
Clock	Page 27
Format	Page 27
Time Zone	Page 27

TABLE OF CONTENTS

Daylight Saving Time	Page 28
Alarm Clock	Page 28
Time	Page 28
Program Alert	Page 29
Program Day/Time	Page 29
Channel Selection	Page 30
Auto Shutdown	Page 30
Sleep Mode	Page 31
Factory Default	Page 31
Display Messages	Page 33
Problem Solving	Page 35
Warranty	Page 36

INTRODUCTION

Product Overview

Thank you for purchasing this product! Your new plug and play XACT Stream | jockey II satellite radio is specifically designed to mount in a vehicle or indoor/outdoor location.

In the event that any item is missing or if you find any mismatch or damage, promptly contact your dealer.

Your Xact Stream | jockey II Satellite Radio Receiver must be used in conjunction with any one of the following Xact Kits, such as the Universal kit, Home kit or Boom Box as required by you specific needs.

- Xact Vehicle Kit: Model Number XS031
- Xact Home Kit: Model Number XS032
- Xact Sound Pad Portable Boom Box: Model Number XS034

The easiest way to activate your Satellite Radio Receiver is to log on to sirius.com. You may also call 1-888-539-SIRIUS (7474).

COMPONENTS GUIDE

XACT Stream | jockey II SIRIUS® Radio

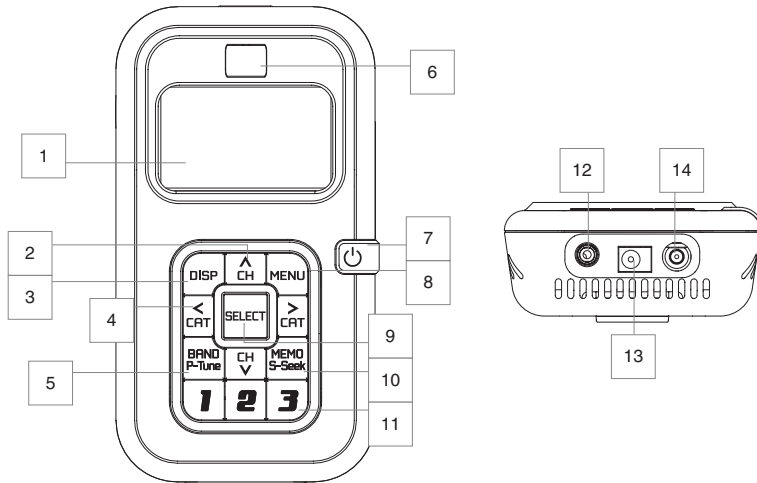

1. LCD Monitor (Main Display)
2. CH (Channel) (Ascend/Descend Buttons)
3. DISP (Display)
4. CAT (Category) (Left/Right Directional Buttons)
5. BAND (P-TUNE)
6. IR for Remote Control
7. Power Button
8. MENU Options List
9. SELECT (OK Button)
10. MEMO (S-Seek)
11. Numerical Keys
12. Audio Jack
13. DC Power Jack
14. Antenna Jack

COMPONENTS GUIDE

Wireless Remote Control

The wireless remote control packed with your plug and play XACT Stream | jockey II satellite radio mirrors the operations of your plug and play XACT Stream | jockey II satellite radio receiver from a remote location.

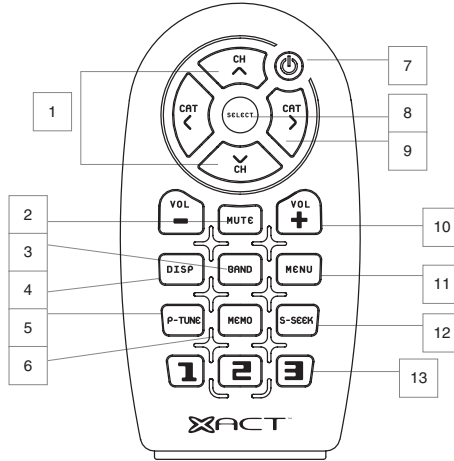

1. CH (Channel) (Ascend/Descend Buttons)
2. MUTE
3. BAND
4. DISP (Display)
5. P-TUNE
6. MEMO
7. Power Button
8. SELECT (OK Button)
9. CAT (Category) (Left/Right Directional Buttons)
10. Volume Adjustment
11. MENU Options List
12. S-Seek
13. Numerical Keys





GETTING STARTED

Mounting Your XACT Stream | jockey II Satellite Radio at Home

Find an appropriate location near your stereo receiver to install your plug and play satellite radio receiver.

Mounting Your XACT Stream | jockey II Satellite Radio in a Vehicle

Find an accessible location in your vehicle to install your plug and play satellite radio receiver; usually, this is the dashboard.

-  Do not mount your device where it may obstruct your view through the windshield or your view of your vehicle's indicator displays.
-  Do not mount your device where it may impede your access to the vehicle's controls.
-  Do not mount your device where it may hinder the function of safety devices, such as an airbag. Doing so may prevent the airbag from functioning accordingly in the event of an accident.
-  Mount your satellite radio where it can be easily reached.
-  The device must be directly in line-of-sight of the remote controller.

NOTE! Do not modify or alter in any way the wires or connections especially to the 12v vehicle adapter. Doing so will prevent the protection provided in the circuitry from functioning properly and result in damaging your receiver. This will void your warranty

Activating Your SIRIUS® Subscription

Before beginning to use your new device, you must first register to the SIRIUS® Satellite Radio service.



There are two ways to activate the SIRIUS® Satellite Radio Service:

1. Visit sirius.com and click activate, then follow the on-screen instructions.
2. Call SIRIUS® at 1-866-845-7474. A representative will help you activate your SIRIUS® Satellite Radio Service.

Note: Make sure to have your identification number accessible when calling SIRIUS®.

Make Note of Your Identification Number

Activating your SIRIUS® Satellite Radio Service:

1. Press MENU to enter the Menu Options settings.

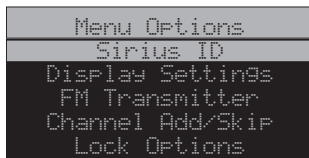

2. Press the Δ or ∇ button select SIRIUS® ID and press the **SELECT** button to enter the sub menu. Your own device's 12-digit SIRIUS® ID Number (ESN) will be displayed on the screen.

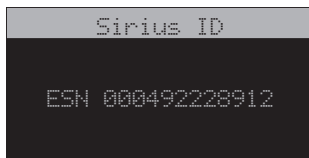

USING THE VEHICLE KIT

INSTALLATION

NOTE! Use only the appropriate accessories or input devices with your receiver. Use only the 12v Vehicle Adapter that is provided with the kit. It is important that you do not modify it in any way since this will result in damaging your equipment and void the warranty.

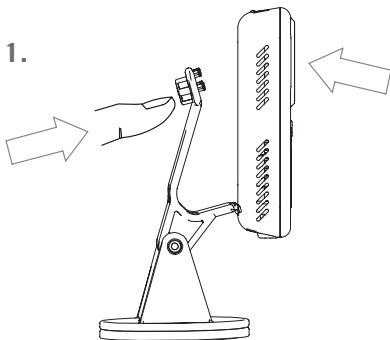

PLACE VEHICLE BASE HOOKS INTO LOCKING SLOT & PUSH THUMB TAB IN...

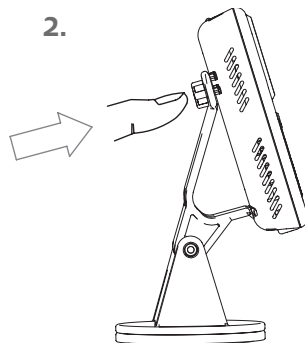

...ROTATE RECEIVER UNIT BACKWARDS TO ENGAGE HOOKS AND TURN KNOB CLOCKWISE TO LOCK IN THE RECEIVER

3.

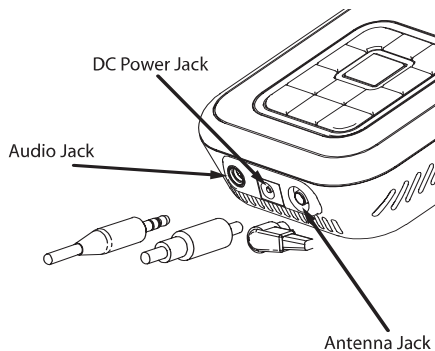

IF YOU HAVE PURCHASED A Boom Box KIT

INSTALLATION

1. PUSH RECEIVER ONTO CONNECTOR

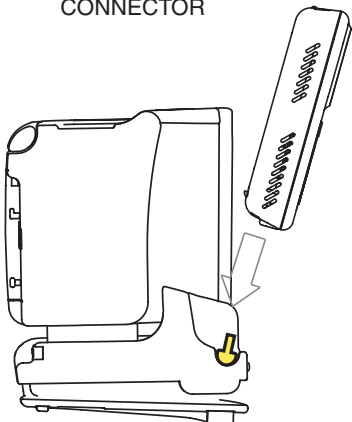

2. ROTATE RECEIVER AND CONNECTOR INTO BOOMBOX

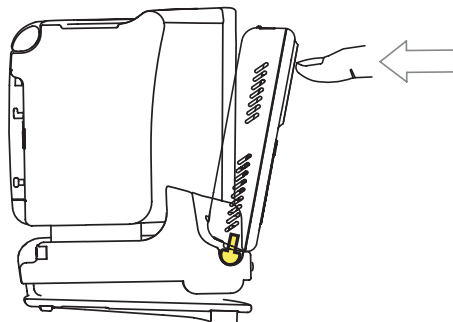

3. LATCH BOOMBOX LOCKS RECEIVER IN PLACE

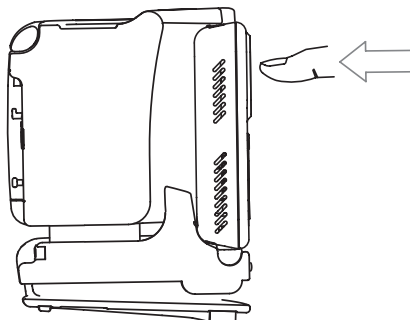

BASIC OPERATIONS

After your SIRIUS® subscription is activated, the Normal (default) Operation screen will pop up.

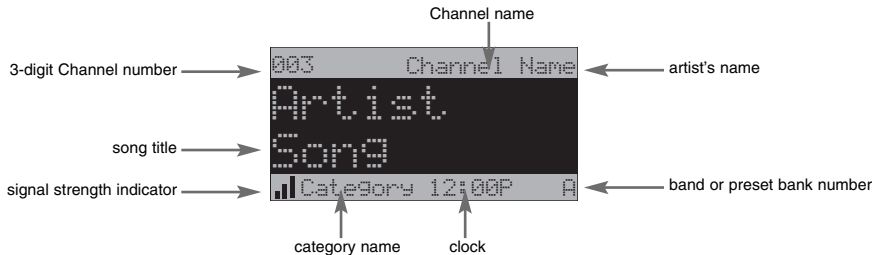

Tuning to Different Entertainment Categories

1. Press the CAT button to scroll through music and entertainment categories.

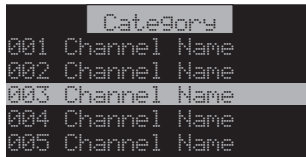

2. Press the CH button to search for channels.
3. When the category you desire is highlighted (for example, "Jazz"), press the **SELECT** button to confirm the setting. The channel will change and the display will revert to the Default Screen for the new channel.



4. To exit this mode without changing to a new channel, press and hold the **DISP** button.

Searching Music

Your satellite radio offers you three ways to seek and select music: by the channel name, by artist/composer and by song title.

Searching For Music By Channel (Channel List)

1. Press and hold the **DISP** button while in Normal Operation mode. The Channel list screen will be displayed, numerically indicating all available channels, regardless of music category.

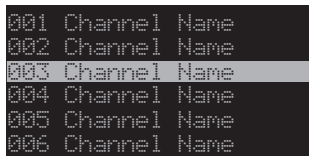

2. Press the $\hat{\text{CH}}$ or $\check{\text{CH}}$ button continuously to choose a preferred channel and press the **SELECT** button to confirm the setting.
3. Press and hold the **DISP** button again to exit from the operation.

Note: The selected channels will remain playing until you make a new change.

Searching For Music By Artist/Composer (Artist/Composer List)

1. Press and hold the **DISP** button while in Normal Operation mode.
2. You will first see the Channel list menu. Press the **DISP** button again. The Artist/Composer list screen will be displayed, listing all currently playing artists, regardless of category. On channels that broadcast "composer" the Composer name will be displayed with the Artist name separated by a slash "/".



3. Press the $\hat{\text{CH}}$ or $\check{\text{CH}}$ button continuously to choose a preferred artist and press the **SELECT** button to confirm the setting.
4. Press and hold the **DISP** button again to exit from the operation.

Searching For Music By Song (Song Title List)

1. Press and hold the **DISP** button while in Normal Operation mode.
2. Continue pressing the **DISP** button twice. The Song Title list screen will be displayed, indicating all currently playing songs, regardless of category. The song title data is listed in ascending order.

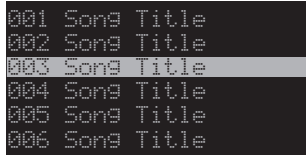

3. Press the \uparrow **CH** or \downarrow **CH** button continuously to choose a preferred song and press the **SELECT** button to confirm the setting.
4. Press and hold the **DISP** button again to exit from the operation.

Direct Tuning

Your XACT Stream | jockey II satellite radio enables you to access your selected channels directly.

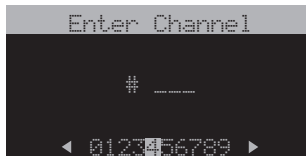

1. Press the **SELECT** button to activate the Direct Tuning mode.
2. The corresponding window is displayed and asks you to enter the desired channel number (3 digits).
3. Use the \leftarrow **CR** or \rightarrow **CR** left/right directional button until the desired digit is highlighted.
4. Press the **SELECT** button to confirm the setting.

Presetting Channels

Your XACT Stream | jockey II satellite radio allows you to preset 18 channels. This design enables you to directly select between 6 different bands of preset channels (identified as A, B, C, D, E and F). Each band contains 3 specific channels (indicated as A-1, A-2, A-3....F-1, F-2 and F-3).

1. Press the $\hat{\text{CH}}$ or \checkmark^{CH} button to search for channels.
2. Press the BRAND P-Tune button to switch to your desired bands (A-F) according to your preference.



3. Once the desired band is set, press and hold the 1,2 or 3 numerical button to select the specific channel. The list will then be recorded in memory.
4. The selected preset number will remain lit on the display screen to demonstrate that it has been memorized.



Note: If a channel is already recorded in the BRAND P-Tune preset list, the new channel will overwrite the old one.

Searching for a Preset Channel/Artist/Song

1. Press and hold the **BRND** button while in Normal Operation mode. The screen will switch between the Normal Operation mode and the Preset Tuning mode.
2. Press and hold the **DISP** button until the Preset Channel list pops up.
3. Press the **DISP** button continuously until the preferred Preset Channel list is indicated.
4. Each time you press the **DISP** button, the Preset lists switches from "Channel Name" to "Artist/Composer" to "Song Title" cyclically.

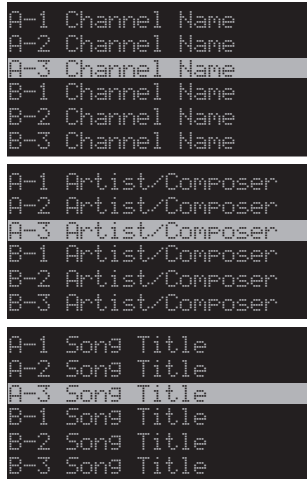

5. Press the **SELECT** button to confirm the setting.

S-Seek Function_MEMO (Memory Search) Button

When in this mode, you can activate the memory search function. This will instruct your satellite radio to search the current incoming SIRIUS® signal and alert you when a song you have saved is being played.



To Store the Information

Under the Normal Operation mode or the Preset Tuning mode, press the **MEMO S-Seek** button. The current program data information is recorded in memory and the capacity status is displayed.



What If You Have Already Recorded the Same Artist/Song?

Your satellite radio automatically checks your recorded data information and compares it with the newly selected program. If the newly selected program has already been recorded, to avoid duplication no entry will be made.



What If the Program Storage is Full?

If the Program Storage is full, a “Memory Full” message will pop up on the screen for a moment, followed by a “Replace” or “Cancel” message.

1. Under Normal Operation mode or in Preset Tuning mode, press the **MEMO** **S-Seek** button.



2. Press the **^** **CH** or **v** **CH** button to select either “Replace” or “Cancel”.
3. Press the **SELECT** button to confirm the setting.

Replace: Do the following to select the program to be overwritten with the new Artist/Composer or Song Title.

- 3a. Press the **SELECT** button, and the follow-up screen will be displayed.

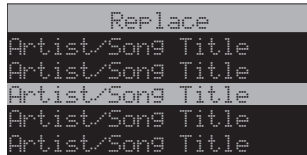

- 3b. Press the **^** **CH** or **v** **CH** button to scroll the the programs.
- 3c. Press the **SELECT** button to replace with the new selection.

Cancel: To avoid overwriting the stored selection, wait for the original screen to be displayed again.

Performing the S-Seek Function

Whenever you turn your satellite radio on, it automatically searches the incoming signal to determine if a match exists between the signal and the artist/composers or song titles that you have recorded in memory (except when S-Seek is set to Off).

1. Press and hold the **MEMO** **S-Seek** button. The recorded programs lists is displayed.
2. Press and release the **SELECT** button while in S-Seek mode.
3. Two selectable options displayed on the screen.
4. Select "Off" (to deactivate the programs searching) or "On" (to activate the program searching) by using the **▲** or **▼** button, then press **SELECT** button to confirm the setting.



Deleting the Recorded Programs (Artist/Song)

1. Press and hold the **MEMO** **S-Seek** button. The recorded programs list is displayed.
2. Press the **▲** or **▼** button to scroll through programs.
3. Press the **SELECT** button to enter the sub-menu.
4. Press the **▲** or **▼** button to select Delete.
5. Press the **SELECT** button again to confirm the setting.

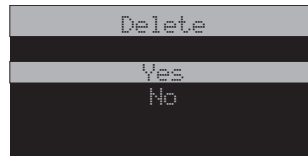
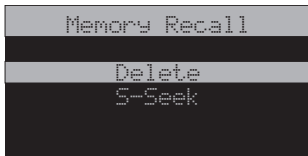

MENU OPTIONS SETTINGS

The following options are included on the Menu Options list:

- SIRIUS® ID
- Display Settings
- FM Transmitter
- Channel Add/Skip
- Lock Options
- Audio Level
- Antenna Aiming
- Memory Options
- Time Features
- Factory Default

BASIC SETTING PROCEDURE

1. Press the **MENU** button. The Menu Options list is displayed on the screen.
2. Press the **▲** or **▼** button to select a desired item
3. Press the **SELECT** button, and the selected Option Setting pops up.
4. Set the Option Setting to your preference according to the steps described below.
5. To exit the Menu Options list, press and hold the **MENU** button.

SIRIUS® ID

Refer to “Make a Note of Your Identification Number” for details.

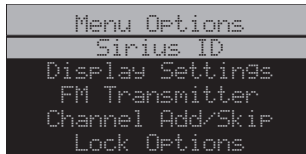

Display Settings

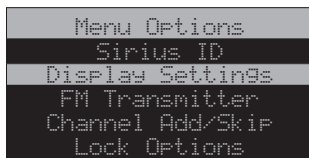

The following adjustments can be made:

- Brightness Control
- Contrast Control

Brightness Control: A 10-segment horizontal bar graph is displayed. Move the \leftarrow \leftarrow or \rightarrow \rightarrow left/right directional button to adjust the dimming control function accordingly. By pressing the \rightarrow \rightarrow or \leftarrow \leftarrow button or by taking no action, you will return to the Menu Operations list.



Contrast Control: A 10-segment horizontal bar graph is displayed. Move the \leftarrow \leftarrow or \rightarrow \rightarrow left/right directional button to adjust the contrast control function accordingly. By pressing the \rightarrow \rightarrow or \leftarrow \leftarrow button or by taking no action, you will return to the Menu Operations list.

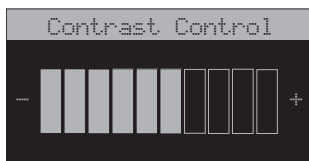

FM Transmitter

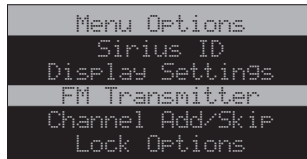

The following adjustments can be made:

- Frequency
- FM On/Off

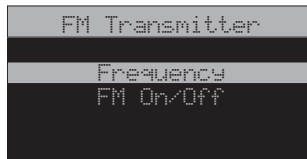

Frequency: enables you to select any one of the pre-programmed FM channels. Press the Δ or ∇ button to select a desired channel, then press the **SELECT** button to confirm the setting. To exit this function, press **MENU** or **SELECT** button.

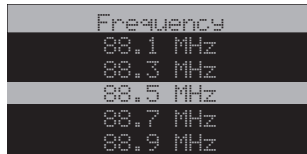

FM On/Off: To activate/deactivate the FM transmitter.



Channel Add/Skip

You can add or skip new/unwanted channels while tuning. When you enter this option, a channel list is displayed, and the current channel playing will be highlighted.

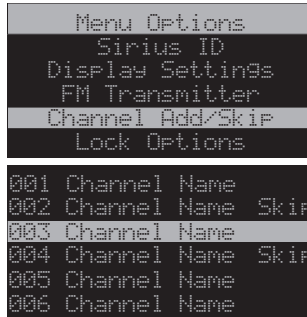

Press the \wedge or ∇ button to navigate the list and highlight the channel you want to skip, then press the **SELECT** button to confirm the setting. A “Skip” message pops up next to the channel displayed. To activate the skipped channel again, repeat the same steps and delete the “Skip” message. While adding the channel, the message “Skip” is removed from alongside the channel name, and the system will no longer skip this channel. To exit this function, press **MENU** button.

Lock Options

Access to particular channels can be set with codes. When you intend to tune in to these particular channels, your receiver will require you to enter the access passwords.

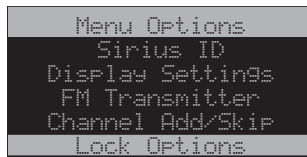

The following adjustments can be made:

- Lock/Unlock
- Edit Code

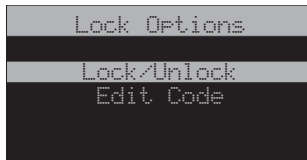

Lock/Unlock: When using Lock/Unlock for the first time, you are asked to type in the 4-digit code that is used to Lock/Unlock the channel access. Press the “0” button four times to enter the default Access Code: 0000



Thereafter, each time you enter this mode, a channel list will be displayed and the currently playing channel will be highlighted. Press the \triangleleft or \triangleright button to select a channel you want to lock, then press the SELECT button to confirm the setting. The message “Lock” pops up next to the channel.

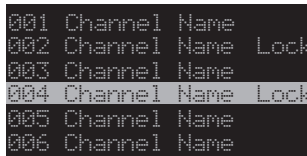

Edit Code: You may change the access password (default code: 0000) to your preference.



1. When you enter this mode, press the \triangleleft or \triangleright left/right directional button to enter the current access code (4-digit default code: 0000 or your previously entered current code) A “New Code” message pops up.



2. Enter the numbers for your new access code by using the \leftarrow _{CAT} or \rightarrow _{CAT} left/right directional buttons. The confirmation screen will then be displayed.
3. Enter the numbers for your new access code again by using \leftarrow _{CAT} or \rightarrow _{CAT} left/right directional buttons. Your new access password is now modified.



Audio Level

Your plug and play satellite radio enables you to adjust audio level. When entering this option, a 10-segment horizontal bar graph is displayed on the screen with a (-) sign to the left and a (+) sign to the right.

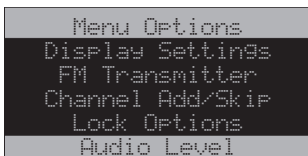

Press the \leftarrow _{CAT} or \rightarrow _{CAT} left/right directional button to adjust the suitable audio level, then press the **SELECT** button to confirm the setting. You can also adjust the Audio level using the Vol+ or Vol- on the Remote Control.



Antenna Aiming

Note: This adjustment setting is required only when you use your device at home. This way, you can assure optimum reception when mounting your SIRIUS® antenna.

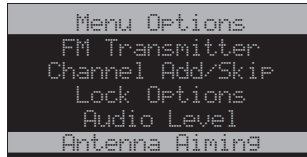

Upon entering this option, two 10-segment horizontal bar graphs are displayed with a (-) sign to the left and a (+) sign to the right. One is labeled “SAT” (satellite signal) and the other “TER” (terrestrial signal strength). The current setting is indicated on the bar graphs. Move the antenna in a location according to the SIRIUS® Satellite Map placement indicated below which provides the strongest signal indication.



SIRIUS® Satellite Map

Due to the paths of SIRIUS® satellites over the US, the best location for the antenna in your home depends on where you live. Use the map below as a general placement guideline.

Area 1 : Place the antenna at an EAST - facing window.

Area 2 : Place the antenna OUTSIDE, away from any overhead obstructions.

Area 3 : Place the antenna at a NORTH WEST - or WEST - facing window.



Area 4 : Place the antenna at a WEST - or NORTH - facing window.

Area 5 : Place the antenna at a NORTH - facing window.

Area 6 : Place the antenna at a NORTH - or EAST - facing window.

Memory Options

In this mode, you can activate or deactivate the Memory Search Function (S-Seek). You can also remove all of the 18 memory locations.

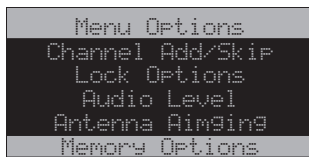

The following adjustments can be made:

- Auto Memory Search
- Clear All

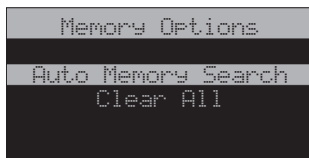

Auto Memory Search: Press the $\hat{\text{CH}}$ or \checkmark button to select either “On” or “Off”, then press the **SELECT** button to implement the setting.

On: To activate the S-Seek function.

Off: To deactivate the S-Seek function.



Clear All: Press the $\hat{\Delta}$ or $\hat{\nabla}$ button to select either “Yes” or “No”.

The message “Are You Sure?” will pop up on the screen. Press the **SELECT** button to confirm the setting.

Yes: will REMOVE all recorded channels.

No: will CANCEL the deletion.



Time Features

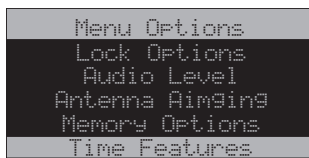

The following adjustments can be made:

- Clock
- Alarm Clock
- Program Alert
- Auto Shutdown
- Sleep Mode



Clock: This option enables you to set up the time to be displayed on the screen. Time is kept directly by the SIRIUS® satellite and is transmitted in GMT FORMAT.



Format: Press the $\hat{\text{C}}_{\text{H}}$ or $\check{\text{C}}_{\text{H}}$ button to select either the "12 Hour" (default) or the "24 Hour" mode, then press the SELECT button to confirm the setting.

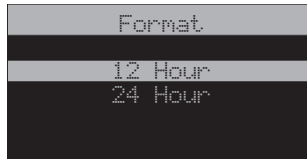

Time Zone: Press the $\hat{\text{C}}_{\text{H}}$ or $\check{\text{C}}_{\text{H}}$ button to select the correct time zone for your region, then press the SELECT button to confirm the setting.

(GMT -9:00) Alaska

(GMT -8:00) Pacific

(GMT -7:00) Mountain

(GMT -6:00) Central

(GMT -5:00) Eastern

(GMT -4:00) Atlantic

(GMT -3:30) Newfndlan

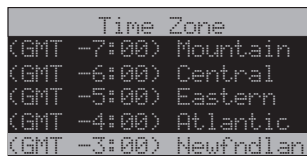

Daylight Saving Time (DST): Activate this option if your area is subject to DST. Press the $\hat{\text{CH}}$ or $\check{\text{CH}}$ button to select “DST Observed” (default) or “DST Not Observed” setting. Then press the SELECT button to confirm the setting.

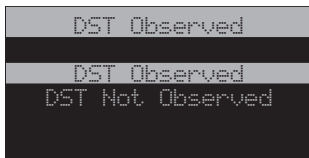

Alarm Clock: You can set your plug and play satellite radio to turn on at a selected time.

Set Alarm: Press the $\hat{\text{CH}}$ or $\check{\text{CH}}$ button to select either the “On” or “Off”(default) setting, then press the SELECT button to confirm the setting.



Time: The default time is 12:00 pm. Press the $\hat{\text{CH}}$ or $\check{\text{CH}}$ button to adjust the hour. Press the \leftarrow_{CAT} or \rightarrow_{CAT} button to adjust the minute. “AM” or “PM” is indicated automatically. Press the SELECT button to confirm the setting.

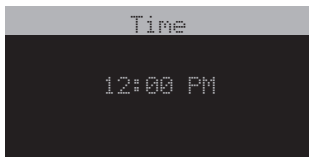

Program Alert: This option allows your XACT Stream | jockey II plug and play satellite radio to tune itself to a pre-selected channel at a pre-selected time.

Note: To use your programmed setting, make sure to set "Program Alert" to "Program Alert On".

The following settings can be made in this sub-menu screen:

- Program Time/Day (default-12:00 PM - Monday)
- Channel Selection (default-Currently Playing Channel)
- Program Alert (default-Off)

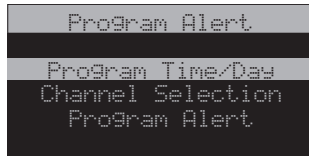

Program Time/Day: Press the $\hat{\text{CH}}$ or $\check{\text{CH}}$ button to select either "Time" or "Day". Then press the SELECT button to confirm the setting.

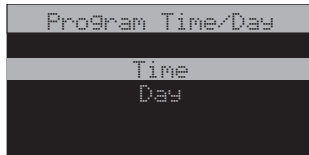

Time: Press the $\hat{\text{CH}}$ or $\check{\text{CH}}$ button to adjust the minute and the $\check{\text{CRT}}$ or $\hat{\text{CRT}}$ button to adjust the hours. Then press the SELECT button. AM or PM displays automatically as you advance the time.

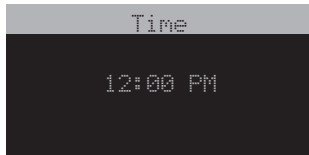

Day: Press the $\hat{\Delta}$ or ∇ to navigate the day: Monday, Tuesday, Wednesday, Thursday, Friday, Saturday, Daily or Sunday. Press the SELECT button to confirm the setting.



Channel Selection: Press the $\hat{\Delta}$ or ∇ button to scroll through the channel list and select the channel of your preference. Press the SELECT button to confirm the setting.

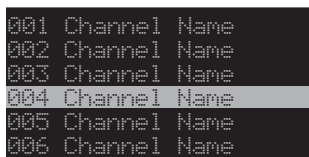

Program Alert: Press the $\hat{\Delta}$ or ∇ to select either the "On" or "Off" setting. Press the SELECT button to confirm the setting.

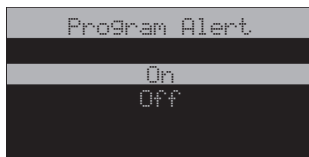

Auto Shutdown: This option will automatically turn your satellite radio off after an hour of inactivity. An audible tone will sound one minute before your device turns off. Press the $\hat{\Delta}$ or ∇ to select the "Enabled" or "Disabled" setting. Press the SELECT button to confirm the setting.

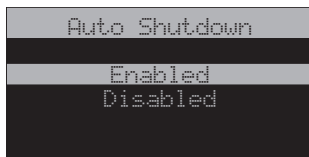

Sleep Mode: When entering this mode, you can program your XACT Stream | jockey II satellite radio to shutdown after a pre-selected period of time.

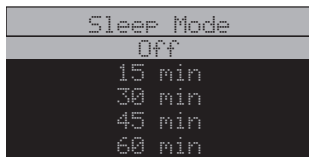

The following adjustments can be made:

Off (default)

15 min.

30 min.

45 min.

60 min.

Press the $\hat{\Delta}_{CH}$ or $\hat{\nabla}_{V}$ button to select the time. Press the **SELECT** button to confirm the setting. Your XACT Stream | jockey II satellite radio receiver will now turn off after the selected time has passed. If “Off” is selected, the Sleep Mode will be canceled.

Factory Default

The following items can be reset to their default mode. A message will pop up that reads “Restore Settings?” before you can reset the item to its default mode.

Press the $\hat{\Delta}_{CH}$ or $\hat{\nabla}_{V}$ button to select either “Yes” (to reset) or “No” (to cancel the reset). Press the **SELECT** button to confirm the setting.

Items revert to their original factory settings as follows:

All Presets revert to empty

Display Dimming to 70%

Display Contrast to 50%

FM Transmitter to “On”

Audio Output Level to 70%

Access to all skipped streams restored

Memory Search On

Memory locations will be erased

12-Hour Clock Format

Eastern time zone

Daylight savings time observed

Alarm Off

Alarm Time 12:00pm

Program Alert Time 12:00pm

Program Alert Day Monday

Program Alert Channel Number (current)

Auto Shutdown Off

Sleep Mode Off

Default Font Size/Type “5x7”

All preset channels and stored artists/composers and songs will also be removed, and all skipped channels will become “un-skipped” (locked channels remain locked).

DISPLAY MESSAGES

Acquiring Signal

When the audio signal is lost, a pop-up window with the message “Acquiring Signal” is displayed until the signal is recovered.

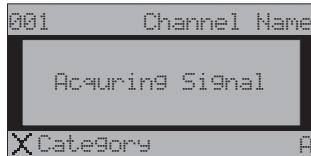

Antenna Not Detected

When no antenna is detected and the signal is lost, a pop-up window with the message “Antenna Not Detected” is displayed until an antenna is detected and the signal is acquired.

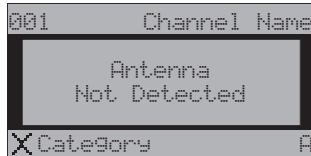

Updating Channels

When a GCI (Global Control Information) update from the SIRIUS® broadcast system is detected, a pop-up window with the message “Updating Channels X% Completed” is displayed until the GCI update is complete.



Subscription Updated

When a subscription update (PSV) from the SIRIUS® broadcast system is detected, a pop-up window with the message “Subscription Updated Anykey to Continue” is displayed for at least 3 seconds.

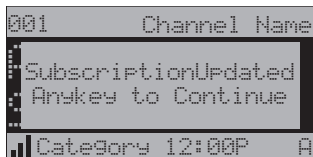

Mute

A single press of the “Mute” button will temporarily disable all analog and digital outputs from your device. Use your remote control to implement this operation.

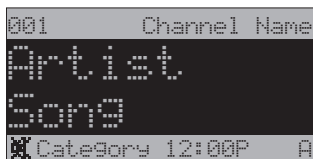

Problem Solving Section

For your assistance, we have listed a few common problems below.

The Satellite Receiver does not work.

Please check the Power Cables. Make sure you have contacted SIRIUS® to activate your Satellite Radio subscription 1-888-539-SIRIUS (7474).

I have no sound from my Satellite Receiver.

Check the audio cables and make sure they are plugged in correctly.

Check the FM Transmitter Setting and make sure that your FM radio is set to the correct channel.

The LCD displays Acquiring Signal.

When the audio signal is lost, a pop-up window with the message “Acquiring Signal” is displayed until the signal is recovered.

The LCD Displays Antenna not Detected.

When no antenna is detected and the signal is lost, a pop-up window with the message “Antenna Not Detected” is displayed until an antenna is detected and the signal is acquired.

Reception is weak or the audio has static and is unclear.

Check that the satellite antenna is connected and not faulty. Change the location of the Antenna making sure it is away from obstructions, see page 24.

WARRANTY

Warranty Information

XACT Communication

One-Year Limited Warranty

This limited warranty sets forth all **XACT Communication** responsibilities regarding your product. There are no other expressed or implied warranties from **XACT Communication**.

Warranty Service Provided

If you purchased the product new from a retail vendor, **XACT Communication** warrants the equipment against defects in material and workmanship for a period of one (1) year from the original date of purchase. This warranty is in lieu of all other express warranties. This warranty begins when you purchase the product and continues for one (1) year unless you sell or rent the unit, in which case the warranty stops.

XACT Communication disclaims any implied warranty, including the warranty of merchantability and the warranty of fitness for a particular purpose, as of the date of one year from your original purchase of the product. **XACT Communication** assumes no responsibility for any special, incidental, or consequential damages.

This warranty gives you specific legal rights and you may have other rights which vary from state to state. Some states do not allow the exclusion or limitations of special, incidental, or consequential damages or limitations on how long a warranty lasts, so the above exclusion or limitation may not apply to you.

Warranty Service Not Provided

This warranty does not cover damage resulting from accident, misuse, abuse, improper installation or operation, lack of reasonable care, unauthorized modification, or the affixing of any attachment not provided by **XACT Communication** with the equipment, and/or loss of parts. This warranty is voided in the event any unauthorized person opens, alters, or repairs the product.

All **XACT Communication** equipment being returned for repair must be suitably packaged.

WARRANTY

What To Do for Warranty Service

During the first thirty (30) days, a defective product is eligible for over-the-counter exchange at the retailer from whom it was purchased. After thirty (30) days, the defective product should be returned to the authorized service center. Please allow a minimum of 2-3 weeks for the return of your product. For the shipping address of the authorized service center, call one of the telephone numbers given below.

Your product will be repaired or replaced if examination by the service center determines the product is defective. Products received damaged as a result of shipping will require you to file a claim with the carrier prior to repair. A product received with missing parts or with damage due to abuse, inadequate packing or some other noncompliance with this limited warranty will be returned to you C.O.D., freight collect.

NOTE: A product received which was not made by **XACT Communication** or which is not defective as determined by our test procedures will not be repaired and will be returned to you C.O.D., freight collect.

To Obtain Warranty Service

- Provide proof of the date of purchase within the package.
- Prepay all shipping costs to the authorized service center.
- Include a return shipping address within the package.

Please retain your sales receipt, the carton, the packing materials, and the printed material. The original carton is the best shipping container for the Product should you have to return it.

For your reference:

Model Number _____

ESN Number _____

S/N Number _____

Date of Purchase _____

Name of Dealer _____

XACT Communication Customer Service Telephone Number:

1-866-466-XACT (9228)

OUTSIDE THE U.S.A. AND CANADA CALL: 1-212-481-7950

Visit Us on the Web: www.getxact.com

NOTES

FCC Caution: Any changes or modifications not expressly approved by the party responsible for compliance could void the user's authority to operate this equipment.

This transmitter must not be co-located or operating in conjunction with any other antenna or transmitter.

NOTES

To activate your Satellite Radio Receiver or for latest news and questions regarding SIRIUS® Satellite Radio service visit sirius.com or call 1-888-539-SIRIUS (7474).

XACT™

SIRIUS
SATELLITE RADIO

Call Toll Free 1-866-466-XACT (9228)
or Visit our Website:

www.getxact.com