

FCC Test Report (Part 24 – GPRS, EDGE, WCDMA, LTE Band 2 / 25)

Report No.: RFBHKI-WTW-P22030766-1

FCC ID: NKRUMC-STD31LFN

Test Model: UMC-STD31LFN

Received Date: Mar. 18, 2022

Test Date: Apr. 06 ~ Apr. 18, 2022

Issued Date: Jul. 04, 2022

Applicant: Wistron NeWeb Corporation

Address: 20 Park Ave. II, Hsinchu Science Park, Hsinchu 308, Taiwan

Issued By: Bureau Veritas Consumer Products Services (H.K.) Ltd., Taoyuan Branch
Lin Kou Laboratories

Lab Address: No. 47-2, 14th Ling, Chia Pau Vil., Lin Kou Dist., New Taipei City, Taiwan

Test Location(1): No. 19, Hwa Ya 2nd Rd., Wen Hwa Vil., Kwei Shan Dist., Taoyuan City
33383, Taiwan

**FCC Registration /
Designation Number(1):** 788550 / TW0003

Test Location(2): No. 70, Wenming Rd., Guishan Dist., Taoyuan City 333, Taiwan (R.O.C.)

**FCC Registration /
Designation Number(2):** 281270 / TW0032



This report is governed by, and incorporates by reference, the Conditions of Testing as posted at the date of issuance of this report at <http://www.bureauveritas.com/home/about-us/our-business/cps/about-us/terms-conditions/> and is intended for your exclusive use. Any copying or replication of this report to or for any other person or entity, or use of our name or trademark, is permitted only with our prior written permission. This report sets forth our findings solely with respect to the test samples identified herein. The results set forth in this report are not indicative or representative of the quality or characteristics of the lot from which a test sample was taken or any similar or identical product unless specifically and expressly noted. Our report includes all of the tests requested by you and the results thereof based upon the information that you provided to us. Measurement uncertainty is only provided upon request for accredited tests. Statements of conformity are based on simple acceptance criteria without taking measurement uncertainty into account, unless otherwise requested in writing. You have 60 days from date of issuance of this report to notify us of any material error or omission caused by our negligence or if you require measurement uncertainty; provided, however, that such notice shall be in writing and shall specifically address the issue you wish to raise. A failure to raise such issue within the prescribed time shall constitute your unqualified acceptance of the completeness of this report, the tests conducted and the correctness of the report contents.

Table of Contents

Release Control Record	4
1 Certificate of Conformity	5
2 Summary of Test Results	6
2.1 Measurement Uncertainty.....	6
2.2 Test Site and Instruments.....	7
3 General Information	8
3.1 General Description of EUT.....	8
3.2 Configuration of System under Test.....	10
3.2.1 Description of Support Units.....	10
3.3 Test Mode Applicability and Tested Channel Detail.....	11
3.4 EUT Operating Conditions.....	19
3.5 General Description of Applied Standards and References.....	19
4 Test Types and Results	20
4.1 Output Power Measurement.....	20
4.1.1 Limits of Output Power Measurement.....	20
4.1.2 Test Procedures.....	20
4.1.3 Test Setup.....	20
4.1.4 Test Results.....	21
4.2 Modulation Characteristics Measurement.....	47
4.2.1 Limits of Modulation Characteristics.....	47
4.2.2 Test Procedure.....	47
4.2.3 Test Setup.....	47
4.2.4 Test Results.....	48
4.3 Frequency Stability Measurement.....	51
4.3.1 Limits of Frequency Stability Measurement.....	51
4.3.2 Test Procedure.....	51
4.3.3 Conducted Setup.....	51
4.3.4 Test Results.....	52
4.4 Occupied Bandwidth Measurement.....	67
4.4.1 Test Procedure.....	67
4.4.2 Test Setup.....	67
4.4.3 Test Result.....	68
4.5 Band Edge Measurement.....	82
4.5.1 Limits of Band Edge Measurement.....	82
4.5.2 Test Setup.....	82
4.5.3 Test Procedures.....	82
4.5.4 Test Results.....	83
4.6 Peak to Average Ratio.....	97
4.6.1 Limits of Peak to Average Ratio Measurement.....	97
4.6.2 Test Setup.....	97
4.6.3 Test Procedures.....	97
4.6.4 Test Results.....	98
4.7 Conducted Spurious Emissions.....	111
4.7.1 Limits of Conducted Spurious Emissions Measurement.....	111
4.7.2 Test Setup.....	111
4.7.3 Test Procedure.....	111
4.7.4 Test Results.....	112
4.8 Radiated Emission Measurement.....	132
4.8.1 Limits of Radiated Emission Measurement.....	132
4.8.2 Test Procedure.....	132
4.8.3 Deviation from Test Standard.....	132
4.8.4 Test Setup.....	133
4.8.5 Test Results.....	134

5	Pictures of Test Arrangements.....	162
	Appendix – Information of the Testing Laboratories	163

Release Control Record

Issue No.	Description	Date Issued
RFBHKI-WTW-P22030766-1	Original release	Jul. 04, 2022

1 Certificate of Conformity

Product: Cellular module
Brand: WNC
Test Model: UMC-STD31LFN
Sample Status: Engineering sample
Applicant: Wistron NeWeb Corporation
Test Date: Apr. 06 ~ Apr. 18, 2022
Standards: FCC Part 24, Subpart E

The above equipment has been tested by **Bureau Veritas Consumer Products Services (H.K.) Ltd., Taoyuan Branch**, and found compliance with the requirement of the above standards. The test record, data evaluation & Equipment Under Test (EUT) configurations represented herein are true and accurate accounts of the measurements of the sample's RF characteristics under the conditions specified in this report.

Prepared by : Pettie Chen, **Date:** Jul. 04, 2022
Pettie Chen / Senior Specialist

Approved by : Jeremy Lin, **Date:** Jul. 04, 2022
Jeremy Lin / Project Engineer

2 Summary of Test Results

Applied Standard: FCC Part 24 & Part 2			
FCC Clause	Test Item	Result	Remarks
2.1046 24.232	Equivalent Isotropically Radiated Power	Pass	Meet the requirement of limit.
2.1046 24.232 (d)	Peak To Average Ratio	Pass	Meet the requirement of limit.
2.1047	Modulation Characteristics	Pass	Meet the requirement
2.1055 24.235	Frequency Stability	Pass	Meet the requirement of limit.
2.1049	Occupied Bandwidth	Pass	Meet the requirement of limit.
24.238	Band Edge Measurements	Pass	Meet the requirement of limit.
2.1051 24.238	Conducted Spurious Emissions	Pass	Meet the requirement of limit.
2.1053 24.238	Radiated Spurious Emissions	Pass	Meet the requirement of limit. Minimum passing margin is -19.52dB at 63.95MHz.

Note: Determining compliance based on the results of the compliance measurement, not taking into account measurement instrumentation uncertainty.

2.1 Measurement Uncertainty

Where relevant, the following measurement uncertainty levels have been estimated for tests performed on the EUT as specified in CISPR 16-4-2:

Measurement	Frequency	Expanded Uncertainty (k=2) (\pm)
Radiated Emissions up to 1 GHz	9kHz ~ 30MHz	3.04 dB
	30MHz ~ 200MHz	3.59 dB
	200MHz ~ 1000MHz	3.60 dB
Radiated Emissions above 1 GHz	1GHz ~ 18GHz	2.29 dB
	18GHz ~ 40GHz	2.29 dB

2.2 Test Site and Instruments

Description & Manufacturer	Model No.	Serial No.	Cal. Date	Cal. Due
Test Receiver KEYSIGHT	N9038B	MY60180018	Feb. 18, 2022	Feb. 17, 2023
Spectrum Analyzer KEYSIGHT	N9020B	MY60110513	Dec. 24, 2021	Dec. 23, 2022
BILOG Antenna SCHWARZBECK	VULB9168	9168-1214	Oct. 27, 2021	Oct. 26, 2022
HORN Antenna RF SPIN	DRH18-E	210101A18E	Nov. 14, 2021	Nov. 13, 2022
HORN Antenna SCHWARZBECK	BBHA 9170	9170-1049	Nov. 14, 2021	Nov. 13, 2022
Loop Antenna TESEQ	HLA 6121	45745	Jul. 21, 2021	Jul. 20, 2022
Preamplifier EMCI	EMC330N	980798	Jan. 17, 2022	Jan. 16, 2023
Preamplifier EMCI	EMC118A45SE	980809	Dec. 30, 2021	Dec. 29, 2022
Preamplifier EMCI	EMC184045SE	980786	Jan. 17, 2022	Jan. 16, 2023
RF signal cable EMCI	EMC104-SM-SM-(9000+3000+1000)	201244+ 201232+ 210103	Jan. 17, 2022	Jan. 16, 2023
RF signal cable EMCI	EMCCFD400-NM-NM-(9000+3000+500)	201251+ 201249+ 201248	Jan. 17, 2022	Jan. 16, 2023
RF signal cable EMCI	EMC101G-KM-KM-(5000+3000+2000)	201261+201258+ 201255	Jan. 17, 2022	Jan. 16, 2023
Software BV ADT	ADT_Radiated_V7.6 .15.9.5	NA	NA	NA
Antenna Tower Max-Full	MFA-515BSN	NA	NA	NA
Turn Table Max-Full	MFT-201SS	NA	NA	NA
Turn Table Controller Max-Full	MF-7802BS	MF780208676	NA	NA
Radio Communication Analyzer Anritsu	MT8821C	6261806803	Feb. 16, 2022	Feb. 15, 2023
Spectrum Analyzer KEYSIGHT	N9030B	MY57140953	Jul. 06, 2021	Jul. 05, 2022
Temperature & Humidity Chamber TERCHY	HRM-120RF	931022	Jan. 03, 2022	Jan. 02, 2023
DC power supply KEYSIGHT	U8002A	MY56330015	NA	NA
Digital Multimeter Fluke	87-III	70360755	Jul. 08, 2021	Jul. 07, 2022

Note: 1. The calibration interval of the above test instruments is 12 months and the calibrations are traceable to NML/ROC and NIST/USA.
2. The test was performed in WM Chamber 9.

3 General Information

3.1 General Description of EUT

Product	Cellular module	
Brand	WNC	
Test Model	UMC-STD31LFN	
Sample Status	Engineering sample	
Power Supply Rating	4.0Vdc	
Modulation Type	GPRS: GMSK EDGE: 8PSK WCDMA: BPSK, QPSK HSDPA: BPSK HSUPA: QPSK LTE: QPSK, 16QAM, 64QAM	
Operating Frequency	GPRS, EDGE	1850.2MHz ~ 1909.8MHz
	WCDMA Band 2	1852.4MHz ~ 1907.6MHz
	LTE Band 2 (Channel Bandwidth 1.4MHz)	1850.7MHz ~ 1909.3MHz
	LTE Band 2 (Channel Bandwidth 3MHz)	1851.5MHz ~ 1908.5MHz
	LTE Band 2 (Channel Bandwidth 5MHz)	1852.5MHz ~ 1907.5MHz
	LTE Band 2 (Channel Bandwidth 10MHz)	1855.0MHz ~ 1905.0MHz
	LTE Band 2 (Channel Bandwidth 15MHz)	1857.5MHz ~ 1902.5MHz
	LTE Band 2 (Channel Bandwidth 20MHz)	1860.0MHz ~ 1900.0MHz
	LTE Band 25 (Channel Bandwidth 1.4MHz)	1850.7MHz ~ 1914.3MHz
	LTE Band 25 (Channel Bandwidth 3MHz)	1851.5MHz ~ 1913.5MHz
	LTE Band 25 (Channel Bandwidth 5MHz)	1852.5MHz ~ 1912.5MHz
	LTE Band 25 (Channel Bandwidth 10MHz)	1855.0MHz ~ 1910.0MHz
	LTE Band 25 (Channel Bandwidth 15MHz)	1857.5MHz ~ 1907.5MHz
	LTE Band 25 (Channel Bandwidth 20MHz)	1860.0MHz ~ 1905.0MHz

Max. EIRP Power	GPRS	1432.188mW (31.56dBm)		
	EDGE	1438.799mW (31.58dBm)		
	WCDMA Band 2	313.329mW (24.96dBm)		
		QPSK	16QAM	64QAM
	LTE Band 2 (Channel Bandwidth 1.4MHz)	306.196mW (24.86dBm)	245.471mW (23.90dBm)	194.089mW (22.88dBm)
	LTE Band 2 (Channel Bandwidth 3MHz)	297.852mW (24.74dBm)	242.103mW (23.84dBm)	188.365mW (22.75dBm)
	LTE Band 2 (Channel Bandwidth 5MHz)	297.167mW (24.73dBm)	236.592mW (23.74dBm)	185.780mW (22.69dBm)
	LTE Band 2 (Channel Bandwidth 10MHz)	304.789mW (24.84dBm)	246.037mW (23.91dBm)	195.434mW (22.91dBm)
	LTE Band 2 (Channel Bandwidth 15MHz)	309.742mW (24.91dBm)	246.604mW (23.92dBm)	191.867mW (22.83dBm)
	LTE Band 2 (Channel Bandwidth 20MHz)	311.172mW (24.93dBm)	252.930mW (24.03dBm)	197.697mW (22.96dBm)
	LTE Band 25 (Channel Bandwidth 1.4MHz)	299.916mW (24.77dBm)	240.991mW (23.82dBm)	190.108mW (22.79dBm)
	LTE Band 25 (Channel Bandwidth 3MHz)	293.765mW (24.68dBm)	237.137mW (23.75dBm)	187.499mW (22.73dBm)
	LTE Band 25 (Channel Bandwidth 5MHz)	295.121mW (24.70dBm)	238.232mW (23.77dBm)	185.780mW (22.69dBm)
	LTE Band 25 (Channel Bandwidth 10MHz)	296.483mW (24.72dBm)	237.684mW (23.76dBm)	188.799mW (22.76dBm)
	LTE Band 25 (Channel Bandwidth 15MHz)	300.608mW (24.78dBm)	244.343mW (23.88dBm)	193.197mW (22.86dBm)
	LTE Band 25 (Channel Bandwidth 20MHz)	294.442mW (24.69dBm)	237.137mW (23.75dBm)	188.365mW (22.75dBm)
Emission Designator	GPRS	247KGXW		
	EDGE	249KG7W		
	WCDMA Band 2	4M19F9W		
		QPSK	16QAM	64QAM
	LTE Band 2 (Channel Bandwidth 1.4MHz)	1M09G7D	1M09D7W	1M09D7W
	LTE Band 2 (Channel Bandwidth 3MHz)	2M69G7D	2M69D7W	2M69D7W
	LTE Band 2 (Channel Bandwidth 5MHz)	4M50G7D	4M49D7W	4M50D7W
	LTE Band 2 (Channel Bandwidth 10MHz)	8M99G7D	8M99D7W	8M99D7W
	LTE Band 2 (Channel Bandwidth 15MHz)	13M5G7D	13M5D7W	13M5D7W
	LTE Band 2 (Channel Bandwidth 20MHz)	18M0G7D	18M0D7W	18M0D7W
	LTE Band 25 (Channel Bandwidth 1.4MHz)	1M09G7D	1M09D7W	1M09D7W
	LTE Band 25 (Channel Bandwidth 3MHz)	2M69G7D	2M69D7W	2M69D7W
	LTE Band 25 (Channel Bandwidth 5MHz)	4M50G7D	4M49D7W	4M50D7W
	LTE Band 25 (Channel Bandwidth 10MHz)	8M99G7D	8M99D7W	8M99D7W
LTE Band 25 (Channel Bandwidth 15MHz)	13M5G7D	13M5D7W	13M5D7W	
LTE Band 25 (Channel Bandwidth 20MHz)	18M0G7D	18M0D7W	18M0D7W	
Antenna Type	Refer to note			
Antenna Connector	Refer to note			
Accessory Device	NA			
Cable Supplied	NA			

Note: The antenna information is listed as below.

Type	Connector	Gain (dBi)													
		GSM 850	GSM 1900	WCDMA B2	WCDMA B5	LTE B2	LTE B4	LTE B5	LTE B7	LTE B12	LTE B17	LTE B25	LTE B26	LTE B66	LTE B71
Dipole	SMA	1.82	1.80	1.80	1.82	1.80	1.57	1.82	2.15	2.02	2.02	1.80	1.82	1.57	2.02

* The above Antenna information is declared by manufacturer and for more detailed features description, please refer to the manufacturer's specifications, the laboratory shall not be held responsible.

3.2 Configuration of System under Test

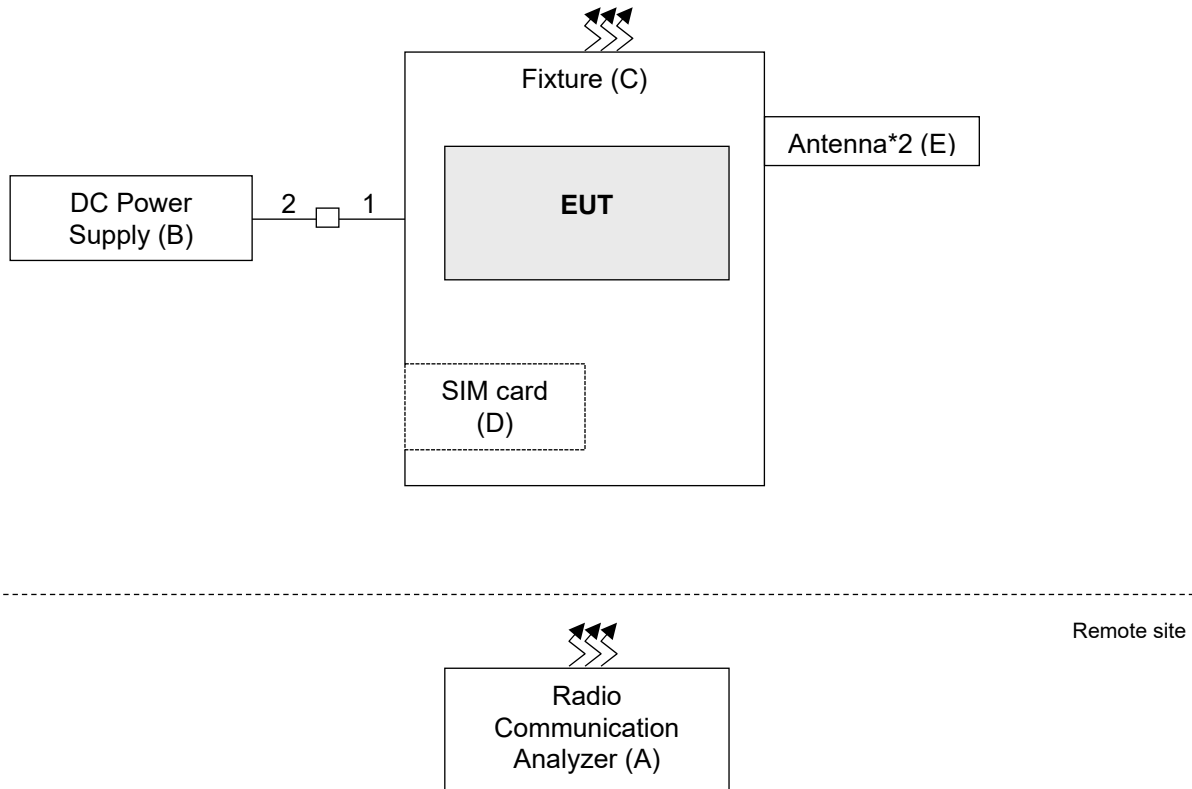

3.2.1 Description of Support Units

The EUT has been tested as an independent unit together with other necessary accessories or support units. The following support units or accessories were used to form a representative test configuration during the tests.

ID	Product	Brand	Model No.	Serial No.	FCC ID	Remarks
A.	Radio Communication Analyzer	Anritsu	MT8820C	6201240432	NA	For LTE
		R&S	CMU200	101095	NA	For GPRS, EDGE, WCDMA
B.	DC Power Supply	TOP WARD	6603A	725906	NA	-
C.	Fixture	NA	NA	NA	NA	Supplied by applicant
D.	SIM Card	R&S	CRT-Z3	NA	NA	Provided by Lab
E.	Antenna*2	NA	NA	NA	NA	Supplied by applicant

Note:

1. All power cords of the above support units are non-shielded (1.8m).
2. Item A acted as a communication partner to transfer data.

ID	Descriptions	Qty.	Length (m)	Shielding (Yes/No)	Cores (Qty.)	Remarks
1.	DC Power Cable	1	0.1	N	0	-
2.	DC Power Cable	1	1.0	N	0	-

3.3 Test Mode Applicability and Tested Channel Detail

Pre-Scan has been conducted to determine the worst-case mode from all possible combinations between available modulations, data rates, XYZ axis and antenna ports. The worst case was found when positioned as the table below. Following channel(s) was (were) selected for the final test as listed below:

Band	Radiated Emission
GPRS, EDGE	Z-plane
WCDMA Band 2	Z-plane
LTE Band 2	Z-plane
LTE Band 25	Z-plane

GPRS, EDGE Mode

EUT Configure Mode	Test Item	Available Channel	Tested Channel	Modulation
-	EIRP	512 to 810	512 (1850.2MHz), 661 (1880.0MHz), 810 (1909.8MHz)	GPRS, EDGE
-	Modulation Characteristics	512 to 810	661 (1880.0MHz)	GPRS, EDGE
-	Frequency Stability	512 to 810	512 (1850.2MHz), 810 (1909.8MHz)	GPRS, EDGE
-	Occupied Bandwidth	512 to 810	512 (1850.2MHz), 661 (1880.0MHz), 810 (1909.8MHz)	GPRS, EDGE
-	Band Edge	512 to 810	512(1850.2MHz), 810(1909.8MHz)	GPRS, EDGE
-	Peak To Average Ratio	512 to 810	512 (1850.2MHz), 661 (1880.0MHz), 810 (1909.8MHz)	GPRS, EDGE
-	Conducted Emission	512 to 810	512 (1850.2MHz), 661 (1880.0MHz), 810 (1909.8MHz)	GPRS, EDGE
-	Radiated Emission Below 1GHz	512 to 810	810 (1909.8MHz)	GPRS
-			661 (1880.0MHz)	EDGE
-	Radiated Emission Above 1GHz	512 to 810	512 (1850.2MHz), 661 (1880.0MHz), 810 (1909.8MHz)	GPRS, EDGE

Note: For radiated emission below 1GHz, select the worst radiated emission channel (above 1GHz) for final testing.

WCDMA Band 2

EUT Configure Mode	Test Item	Available Channel	Tested Channel	Mode
-	EIRP	9262 to 9538	9262 (1852.4MHz), 9400 (1880.0MHz), 9538 (1907.6MHz)	WCDMA, HSDPA, HSUPA
-	Modulation Characteristics	9262 to 9538	9400 (1880.0MHz)	WCDMA, HSDPA, HSUPA
-	Frequency Stability	9262 to 9538	9262 (1852.4MHz), 9538 (1907.6MHz)	WCDMA
-	Occupied Bandwidth	9262 to 9538	9262 (1852.4MHz), 9400 (1880.0MHz), 9538 (1907.6MHz)	WCDMA, HSDPA, HSUPA
-	Band Edge	9262 to 9538	9262 (1852.4MHz), 9538 (1907.6MHz)	WCDMA, HSDPA, HSUPA
-	Peak To Average Ratio	9262 to 9538	9262 (1852.4MHz), 9400 (1880.0MHz), 9538 (1907.6MHz)	WCDMA, HSDPA, HSUPA
-	Conducted Emission	9262 to 9538	9262 (1852.4MHz), 9400 (1880.0MHz), 9538 (1907.6MHz)	WCDMA, HSDPA, HSUPA
-	Radiated Emission Below 1GHz	9262 to 9538	9538 (1907.6MHz)	WCDMA
-	Radiated Emission Above 1GHz	9262 to 9538	9262 (1852.4MHz), 9400 (1880.0MHz), 9538 (1907.6MHz)	WCDMA

Note: For radiated emission below 1GHz, select the worst radiated emission channel (above 1GHz) for final testing.

LTE Band 2

EUT Configure Mode	Test item	Available channel	Tested Channel	Channel Bandwidth	Modulation	RB #
-	EIRP	18607 to 19193	18607 (1850.7MHz), 18900 (1880.0MHz), 19193 (1909.3MHz)	1.4MHz	QPSK / 16QAM / 64QAM	1 Half Full
		18615 to 19185	18615 (1851.5MHz), 18900 (1880.0MHz), 19185 (1908.5MHz)	3MHz	QPSK / 16QAM / 64QAM	1 Half Full
		18625 to 19175	18625 (1852.5MHz), 18900 (1880.0MHz), 19175 (1907.5MHz)	5MHz	QPSK / 16QAM / 64QAM	1 Half Full
		18650 to 19150	18650 (1855.0MHz), 18900 (1880.0MHz), 19150 (1905.0MHz)	10MHz	QPSK / 16QAM / 64QAM	1 Half Full
		18675 to 19125	18675 (1857.5MHz), 18900 (1880.0MHz), 19125 (1902.5MHz)	15MHz	QPSK / 16QAM / 64QAM	1 Half Full
		18700 to 19100	18700 (1860.0MHz), 18900 (1880.0MHz), 19100 (1900.0MHz)	20MHz	QPSK / 16QAM / 64QAM	1 Half Full
-	Modulation Characteristics	18700 to 19100	18900 (1880.0MHz)	20MHz	QPSK / 16QAM / 64QAM	Full
-	Frequency Stability	18607 to 19193	18607 (1850.7MHz), 19193 (1909.3MHz)	1.4MHz	QPSK	Full
		18615 to 19185	18615 (1851.5MHz), 19185 (1908.5MHz)	3MHz	QPSK	Full
		18625 to 19175	18625 (1852.5MHz), 19175 (1907.5MHz)	5MHz	QPSK	Full
		18650 to 19150	18650 (1855.0MHz), 19150 (1905.0MHz)	10MHz	QPSK	Full
		18675 to 19125	18675 (1857.5MHz), 19125 (1902.5MHz)	15MHz	QPSK	Full
		18700 to 19100	18700 (1860.0MHz), 19100 (1900.0MHz)	20MHz	QPSK	Full
-	Occupied Bandwidth	18607 to 19193	18607 (1850.7MHz), 18900 (1880.0MHz), 19193 (1909.3MHz)	1.4MHz	QPSK / 16QAM / 64QAM	Full
		18615 to 19185	18615 (1851.5MHz), 18900 (1880.0MHz), 19185 (1908.5MHz)	3MHz	QPSK / 16QAM / 64QAM	Full
		18625 to 19175	18625 (1852.5MHz), 18900 (1880.0MHz), 19175 (1907.5MHz)	5MHz	QPSK / 16QAM / 64QAM	Full
		18650 to 19150	18650 (1855.0MHz), 18900 (1880.0MHz), 19150 (1905.0MHz)	10MHz	QPSK / 16QAM / 64QAM	Full
		18675 to 19125	18675 (1857.5MHz), 18900 (1880.0MHz), 19125 (1902.5MHz)	15MHz	QPSK / 16QAM / 64QAM	Full
		18700 to 19100	18700 (1860.0MHz), 18900 (1880.0MHz), 19100 (1900.0MHz)	20MHz	QPSK / 16QAM / 64QAM	Full

EUT Configure Mode	Test item	Available channel	Tested Channel	Channel Bandwidth	Modulation	RB #
-	Band Edge	18607 to 19193	18607 (1850.7MHz), 19193 (1909.3MHz)	1.4MHz	QPSK	1 Half Full
		18615 to 19185	18615 (1851.5MHz), 19185 (1908.5MHz)	3MHz	QPSK	1 Half Full
		18625 to 19175	18625 (1852.5MHz), 19175 (1907.5MHz)	5MHz	QPSK	1 Half Full
		18650 to 19150	18650 (1855.0MHz), 19150 (1905.0MHz)	10MHz	QPSK	1 Half Full
		18675 to 19125	18675 (1857.5MHz), 19125 (1902.5MHz)	15MHz	QPSK	1 Half Full
		18700 to 19100	18700 (1860.0MHz), 19100 (1900.0MHz)	20MHz	QPSK	1 Half Full
-	Peak to Average Ratio	18607 to 19193	18607 (1850.7MHz), 18900 (1880.0MHz), 19193 (1909.3MHz)	1.4MHz	QPSK / 16QAM / 64QAM	1
		18615 to 19185	18615 (1851.5MHz), 18900 (1880.0MHz), 19185 (1908.5MHz)	3MHz	QPSK / 16QAM / 64QAM	1
		18625 to 19175	18625 (1852.5MHz), 18900 (1880.0MHz), 19175 (1907.5MHz)	5MHz	QPSK / 16QAM / 64QAM	1
		18650 to 19150	18650 (1855.0MHz), 18900 (1880.0MHz), 19150 (1905.0MHz)	10MHz	QPSK / 16QAM / 64QAM	1
		18675 to 19125	18675 (1857.5MHz), 18900 (1880.0MHz), 19125 (1902.5MHz)	15MHz	QPSK / 16QAM / 64QAM	1
		18700 to 19100	18700 (1860.0MHz), 18900 (1880.0MHz), 19100 (1900.0MHz)	20MHz	QPSK / 16QAM / 64QAM	1

EUT Configure Mode	Test item	Available channel	Tested Channel	Channel Bandwidth	Modulation	RB #
-	Conducted Emission	18607 to 19193	18607 (1850.7MHz), 18900 (1880.0MHz), 19193 (1909.3MHz)	1.4MHz	QPSK	1
		18615 to 19185	18615 (1851.5MHz), 18900 (1880.0MHz), 19185 (1908.5MHz)	3MHz	QPSK	1
		18625 to 19175	18625 (1852.5MHz), 18900 (1880.0MHz), 19175 (1907.5MHz)	5MHz	QPSK	1
		18650 to 19150	18650 (1855.0MHz), 18900 (1880.0MHz), 19150 (1905.0MHz)	10MHz	QPSK	1
		18675 to 19125	18675 (1857.5MHz), 18900 (1880.0MHz), 19125 (1902.5MHz)	15MHz	QPSK	1
		18700 to 19100	18700 (1860.0MHz), 18900 (1880.0MHz), 19100 (1900.0MHz)	20MHz	QPSK	1
-	Radiated Emission Below 1GHz	18607 to 19193	19193 (1909.3MHz)	1.4MHz	QPSK	1
-	Radiated Emission Above 1GHz	18607 to 19193	18607 (1850.7MHz), 18900 (1880.0MHz), 19193 (1909.3MHz)	1.4MHz	QPSK	1
		18625 to 19175	18625 (1852.5MHz), 18900 (1880.0MHz), 19175 (1907.5MHz)	5MHz	QPSK	1
		18700 to 19100	18700 (1860.0MHz), 18900 (1880.0MHz), 19100 (1900.0MHz)	20MHz	QPSK	1

Note:

1. For radiated emission below 1GHz, select the worst radiated emission channel (above 1GHz) for final testing.
2. For radiated emission above 1GHz, according to 3GPP 36.521-1 Section 6.6.3.1.4.1, choose the lowest, 5MHz & highest channel bandwidth for final test.
3. The output power for QPSK, 16QAM and 64QAM, measured value of QPSK is higher than 16QAM, and 64QAM mode. Therefore, only Modulation characteristics, occupied bandwidth and Peak to average ratio items had been tested under QPSK, 16QAM and 64QAM modes, the other test items were performed under worse mode according to the maximum output power.

LTE Band 25

EUT Configure Mode	Test item	Available channel	Tested Channel	Channel Bandwidth	Modulation	RB #
-	EIRP	26047 to 26683	26047 (1850.7MHz), 26365 (1882.5MHz), 26683 (1914.3MHz)	1.4MHz	QPSK / 16QAM / 64QAM	1 Half Full
		26055 to 26675	26055 (1851.5MHz), 26365 (1882.5MHz), 26675 (1913.5MHz)	3MHz	QPSK / 16QAM / 64QAM	1 Half Full
		26065 to 26665	26065 (1852.5MHz), 26365 (1882.5MHz), 26665 (1912.5MHz)	5MHz	QPSK / 16QAM / 64QAM	1 Half Full
		26090 to 26640	26090 (1855.0MHz), 26365 (1882.5MHz), 26640 (1910.0MHz)	10MHz	QPSK / 16QAM / 64QAM	1 Half Full
		26115 to 26615	26115 (1857.5MHz), 26365 (1882.5MHz), 26615 (1907.5MHz)	15MHz	QPSK / 16QAM / 64QAM	1 Half Full
		26140 to 26590	26140 (1860.0MHz), 26365 (1882.5MHz), 26590 (1905.0MHz)	20MHz	QPSK / 16QAM / 64QAM	1 Half Full
-	Modulation Characteristics	26140 to 26590	26365 (1882.5MHz)	20MHz	QPSK / 16QAM / 64QAM	Full
-	Frequency Stability	26047 to 26683	26047 (1850.7MHz), 26683 (1914.3MHz)	1.4MHz	QPSK	Full
		26055 to 26675	26055 (1851.5MHz), 26675 (1913.5MHz)	3MHz	QPSK	Full
		26065 to 26665	26065 (1852.5MHz), 26665 (1912.5MHz)	5MHz	QPSK	Full
		26090 to 26640	26090 (1855.0MHz), 26640 (1910.0MHz)	10MHz	QPSK	Full
		26115 to 26615	26115 (1857.5MHz), 26615 (1907.5MHz)	15MHz	QPSK	Full
		26140 to 26590	26140 (1860.0MHz), 26590 (1905.0MHz)	20MHz	QPSK	Full
-	Occupied Bandwidth	26047 to 26683	26047 (1850.7MHz), 26365 (1882.5MHz), 26683 (1914.3MHz)	1.4MHz	QPSK / 16QAM / 64QAM	Full
		26055 to 26675	26055 (1851.5MHz), 26365 (1882.5MHz), 26675 (1913.5MHz)	3MHz	QPSK / 16QAM / 64QAM	Full
		26065 to 26665	26065 (1852.5MHz), 26365 (1882.5MHz), 26665 (1912.5MHz)	5MHz	QPSK / 16QAM / 64QAM	Full
		26090 to 26640	26090 (1855.0MHz), 26365 (1882.5MHz), 26640 (1910.0MHz)	10MHz	QPSK / 16QAM / 64QAM	Full
		26115 to 26615	26115 (1857.5MHz), 26365 (1882.5MHz), 26615 (1907.5MHz)	15MHz	QPSK / 16QAM / 64QAM	Full
		26140 to 26590	26140 (1860.0MHz), 26365 (1882.5MHz), 26590 (1905.0MHz)	20MHz	QPSK / 16QAM / 64QAM	Full

EUT Configure Mode	Test item	Available channel	Tested Channel	Channel Bandwidth	Modulation	RB #
-	Band Edge	26047 to 26683	26047 (1850.7MHz), 26683 (1914.3MHz)	1.4MHz	QPSK	1 Half Full
		26055 to 26675	26055 (1851.5MHz), 26675 (1913.5MHz)	3MHz	QPSK	1 Half Full
		26065 to 26665	26065 (1852.5MHz), 26665 (1912.5MHz)	5MHz	QPSK	1 Half Full
		26090 to 26640	26090 (1855.0MHz), 26640 (1910.0MHz)	10MHz	QPSK	1 Half Full
		26115 to 26615	26115 (1857.5MHz), 26615 (1907.5MHz)	15MHz	QPSK	1 Half Full
		26140 to 26590	26140 (1860.0MHz), 26590 (1905.0MHz)	20MHz	QPSK	1 Half Full
-	Peak to Average Ratio	26047 to 26683	26047 (1850.7MHz), 26365 (1882.5MHz), 26683 (1914.3MHz)	1.4MHz	QPSK / 16QAM / 64QAM	1
		26055 to 26675	26055 (1851.5MHz), 26365 (1882.5MHz), 26675 (1913.5MHz)	3MHz	QPSK / 16QAM / 64QAM	1
		26065 to 26665	26065 (1852.5MHz), 26365 (1882.5MHz), 26665 (1912.5MHz)	5MHz	QPSK / 16QAM / 64QAM	1
		26090 to 26640	26090 (1855.0MHz), 26365 (1882.5MHz), 26640 (1910.0MHz)	10MHz	QPSK / 16QAM / 64QAM	1
		26115 to 26615	26115 (1857.5MHz), 26365 (1882.5MHz), 26615 (1907.5MHz)	15MHz	QPSK / 16QAM / 64QAM	1
		26140 to 26590	26140 (1860.0MHz), 26365 (1882.5MHz), 26590 (1905.0MHz)	20MHz	QPSK / 16QAM / 64QAM	1

EUT Configure Mode	Test item	Available channel	Tested Channel	Channel Bandwidth	Modulation	RB #
-	Conducted Emission	26047 to 26683	26047 (1850.7MHz), 26365 (1882.5MHz), 26683 (1914.3MHz)	1.4MHz	QPSK	1
		26055 to 26675	26055 (1851.5MHz), 26365 (1882.5MHz), 26675 (1913.5MHz)	3MHz	QPSK	1
		26065 to 26665	26065 (1852.5MHz), 26365 (1882.5MHz), 26665 (1912.5MHz)	5MHz	QPSK	1
		26090 to 26640	26090 (1855.0MHz), 26365 (1882.5MHz), 26640 (1910.0MHz)	10MHz	QPSK	1
		26115 to 26615	26115 (1857.5MHz), 26365 (1882.5MHz), 26615 (1907.5MHz)	15MHz	QPSK	1
		26140 to 26590	26140 (1860.0MHz), 26365 (1882.5MHz), 26590 (1905.0MHz)	20MHz	QPSK	1
-	Radiated Emission Below 1GHz	26047 to 26683	26683 (1914.3MHz)	1.4MHz	QPSK	1
-	Radiated Emission Above 1GHz	26047 to 26683	26047 (1850.7MHz), 26365 (1882.5MHz), 26683 (1914.3MHz)	1.4MHz	QPSK	1
		26065 to 26665	26065 (1852.5MHz), 26365 (1882.5MHz), 26665 (1912.5MHz)	5MHz	QPSK	1
		26140 to 26590	26140 (1860.0MHz), 26365 (1882.5MHz), 26590 (1905.0MHz)	20MHz	QPSK	1

Note:

1. For radiated emission below 1GHz, select the worst radiated emission channel (above 1GHz) for final testing.
2. For radiated emission above 1GHz, according to 3GPP 36.521-1 Section 6.6.3.1.4.1, choose the lowest, 5MHz & highest channel bandwidth for final test.
3. The output power for QPSK, 16QAM and 64QAM, measured value of QPSK is higher than 16QAM, and 64QAM mode. Therefore, only Modulation characteristics, occupied bandwidth and Peak to average ratio items had been tested under QPSK, 16QAM and 64QAM modes, the other test items were performed under worse mode according to the maximum output power.

Test Condition:

Test Item	Environmental Conditions	Input Power	Tested By
EIRP	25deg. C, 60%RH	4.0Vdc	Noah Chang
Modulation Characteristics	25deg. C, 60%RH	4.0Vdc	Noah Chang
Frequency Stability	25deg. C, 60%RH	4.0Vdc	Noah Chang
Occupied Bandwidth	25deg. C, 60%RH	4.0Vdc	Noah Chang
Band Edge	25deg. C, 60%RH	4.0Vdc	Noah Chang
Peak To Average Ratio	25deg. C, 60%RH	4.0Vdc	Noah Chang
Conducted Emission	25deg. C, 60%RH	4.0Vdc	Noah Chang
Radiated Emission	21deg. C, 67%RH	4.0Vdc	Edison Lee

3.4 EUT Operating Conditions

The EUT makes a call to the communication simulator. The communication simulator station system controlled a EUT to export maximum output power under transmission mode and specific channel frequency

3.5 General Description of Applied Standards and References

The EUT is a RF Product. According to the specifications of the manufacturer, it must comply with the requirements of the following standards:

Test Standard:

FCC 47 CFR Part 2

FCC 47 CFR Part 24

ANSI/TIA/EIA-603-E 2016

ANSI 63.26-2015

References Test Guidance:

KDB 971168 D01 Power Meas License Digital Systems v03r01

All test items have been performed and recorded as per the above standards.

4 Test Types and Results

4.1 Output Power Measurement

4.1.1 Limits of Output Power Measurement

Mobile / Portable station are limited to 2 watts e.i.r.p.

4.1.2 Test Procedures

Conducted Power Measurement:

The EUT was set up for the maximum power with GPRS, EDGE, WCDMA, LTE link data modulation and link up with simulator. Set the EUT to transmit under low, middle and high channel and record the power level shown on simulator.

Maximum EIRP / ERP

The relevant equation for determining the maximum ERP or EIRP from the measured RF output power is given in Equation as follows:

$$\text{EIRP} = P_{\text{Meas}} + G_{\text{T}}$$

$$\text{ERP} = P_{\text{Meas}} + G_{\text{T}} - 2.15$$

where

ERP or EIRP effective radiated power or equivalent isotropically radiated power, respectively
(expressed in the same units as P_{Meas} , e.g., dBm or dBW)

P_{Meas} measured transmitter output power or PSD, in dBm or dBW

G_{T} gain of the transmitting antenna, in dBd (ERP) or dBi (EIRP)

4.1.3 Test Setup

Conducted Power Measurement:



4.1.4 Test Results

Conducted Output Power (dBm)

Band	GPRS, EDGE 1900		
Channel	512	661	810
Frequency	1850.2	1880	1909.8
GPRS	29.72	29.76	29.51
EDGE	29.78	29.73	29.48

Band	WCDMA II		
TX Channel	9262	9400	9538
Frequency	1852.4	1880	1907.6
RMC 12.2K	22.93	23.03	23.16
HSDPA	21.96	22.10	22.10
HSUPA	21.83	21.94	22.01

LTE Band 2						
BW	MCS Index	RB Size	RB Offset	Low	Mid	High
		Channel		18700	18900	19100
		Frequency (MHz)		1860	1880	1900
20M	QPSK	1	0	23.13	23.06	22.97
		1	50	23.08	22.98	22.91
		1	99	22.96	22.89	22.79
		50	0	21.95	22.05	22.05
		50	25	22.11	22.01	22.00
		50	50	21.87	21.88	21.94
		100	0	22.02	21.99	22.03
20M	16QAM	1	0	22.23	22.15	22.01
		1	50	22.09	22.02	21.95
		1	99	21.98	21.91	21.81
		50	0	20.97	21.12	21.05
		50	25	21.18	21.10	21.01
		50	50	20.89	20.96	20.99
		100	0	21.03	21.04	21.12
20M	64QAM	1	0	21.16	21.05	20.99
		1	50	21.04	20.98	20.88
		1	99	20.89	20.84	20.71
		50	0	19.96	20.12	20.04
		50	25	20.17	20.10	19.95
		50	50	19.80	19.93	19.90
		100	0	20.03	19.94	20.11

LTE Band 2						
BW	MCS Index	RB Size	RB Offset	Low	Mid	High
		Channel		18675	18900	19125
		Frequency (MHz)		1857.5	1880	1902.5
15M	QPSK	1	0	23.05	23.02	23.11
		1	37	22.79	22.79	22.70
		1	74	22.77	22.85	22.83
		36	0	22.07	22.13	22.20
		36	19	22.00	22.02	21.93
		36	39	21.89	21.98	21.92
		75	0	21.97	21.90	21.92
15M	16QAM	1	0	22.05	22.05	22.12
		1	37	21.81	21.86	21.71
		1	74	21.79	21.95	21.89
		36	0	21.13	21.18	21.29
		36	19	21.01	21.07	20.95
		36	39	20.97	21.03	21.01
		75	0	21.03	20.97	20.92
15M	64QAM	1	0	21.01	21.02	21.03
		1	37	20.75	20.79	20.71
		1	74	20.77	20.91	20.84
		36	0	20.06	20.08	20.24
		36	19	19.91	20.05	19.93
		36	39	19.90	19.96	19.99
		75	0	20.01	19.95	19.82

LTE Band 2						
BW	MCS Index	RB Size	RB Offset	Low	Mid	High
		Channel		18650	18900	19150
		Frequency (MHz)		1855	1880	1905
10M	QPSK	1	0	22.74	22.75	22.70
		1	24	23.01	23.04	22.98
		1	49	22.91	22.94	23.02
		25	0	21.99	22.00	21.90
		25	12	21.79	21.89	21.80
		25	25	22.04	22.05	22.01
		50	0	22.01	21.99	21.93
10M	16QAM	1	0	21.82	21.78	21.70
		1	24	22.11	22.05	22.05
		1	49	21.92	22.03	22.04
		25	0	21.07	21.00	20.99
		25	12	20.80	20.93	20.82
		25	25	21.14	21.06	21.07
		50	0	21.07	21.06	20.95
10M	64QAM	1	0	20.74	20.71	20.61
		1	24	21.11	20.97	21.03
		1	49	20.92	20.95	20.97
		25	0	20.01	19.95	19.93
		25	12	19.76	19.89	19.74
		25	25	20.09	20.00	20.07
		50	0	20.00	20.04	19.95

LTE Band 2						
BW	MCS Index	RB Size	RB Offset	Low	Mid	High
		Channel		18625	18900	19175
		Frequency (MHz)		1852.5	1880	1907.5
5M	QPSK	1	0	22.74	22.72	22.76
		1	12	22.88	22.88	22.93
		1	24	22.69	22.78	22.70
		12	0	21.93	21.95	22.02
		12	6	22.02	22.07	22.02
		12	13	21.95	22.03	22.06
		25	0	21.98	21.92	21.86
5M	16QAM	1	0	21.79	21.76	21.80
		1	12	21.94	21.91	21.93
		1	24	21.74	21.85	21.80
		12	0	20.98	20.99	21.05
		12	6	21.11	21.15	21.09
		12	13	21.03	21.13	21.14
		25	0	21.06	21.01	20.88
5M	64QAM	1	0	20.69	20.73	20.79
		1	12	20.89	20.85	20.87
		1	24	20.65	20.76	20.78
		12	0	19.92	19.97	19.95
		12	6	20.10	20.14	20.09
		12	13	19.98	20.04	20.12
		25	0	19.97	19.97	19.78

LTE Band 2						
BW	MCS Index	RB Size	RB Offset	Low	Mid	High
		Channel		18615	18900	19185
		Frequency (MHz)		1851.5	1880	1908.5
3M	QPSK	1	0	22.77	22.84	22.80
		1	7	22.83	22.92	22.82
		1	14	22.94	22.88	22.85
		8	0	21.94	21.94	21.88
		8	3	22.18	22.09	22.03
		8	7	22.11	22.02	22.09
		15	0	22.12	22.05	22.14
3M	16QAM	1	0	21.83	21.90	21.82
		1	7	21.87	21.95	21.86
		1	14	22.04	21.97	21.90
		8	0	20.97	21.00	20.92
		8	3	21.25	21.11	21.04
		8	7	21.19	21.09	21.14
		15	0	21.13	21.06	21.24
3M	64QAM	1	0	20.75	20.86	20.79
		1	7	20.79	20.93	20.78
		1	14	20.95	20.93	20.86
		8	0	19.92	19.97	19.88
		8	3	20.23	20.11	19.95
		8	7	20.19	20.07	20.13
		15	0	20.11	20.04	20.21

LTE Band 2						
BW	MCS Index	RB Size	RB Offset	Low	Mid	High
		Channel		18607	18900	19193
		Frequency (MHz)		1850.7	1880	1909.3
1.4M	QPSK	1	0	22.71	22.76	22.81
		1	2	22.85	22.88	22.98
		1	5	22.87	22.77	22.82
		3	0	23.06	22.96	22.86
		3	1	22.81	22.85	22.81
		3	3	23.02	22.93	22.96
		6	0	22.04	21.96	21.88
1.4M	16QAM	1	0	21.74	21.79	21.86
		1	2	21.85	21.94	22.02
		1	5	21.88	21.79	21.92
		3	0	22.10	22.00	21.93
		3	1	21.88	21.94	21.85
		3	3	22.05	21.96	22.01
		6	0	21.13	20.96	20.94
1.4M	64QAM	1	0	20.67	20.71	20.83
		1	2	20.82	20.90	20.95
		1	5	20.78	20.74	20.85
		3	0	21.08	20.97	20.86
		3	1	20.83	20.92	20.77
		3	3	21.01	20.94	20.99
		6	0	20.04	19.96	19.85

LTE Band 25						
BW	MCS Index	RB Size	RB Offset	Low	Mid	High
		Channel		26140	26365	26590
		Frequency (MHz)		1860	1882.5	1905
20M	QPSK	1	0	22.78	22.83	22.89
		1	50	22.72	22.79	22.81
		1	99	22.80	22.81	22.71
		50	0	21.66	21.71	21.67
		50	25	21.78	21.73	21.83
		50	50	21.85	21.80	21.74
		100	0	21.82	21.83	21.79
20M	16QAM	1	0	21.84	21.86	21.95
		1	50	21.80	21.88	21.88
		1	99	21.81	21.90	21.76
		50	0	20.71	20.75	20.72
		50	25	20.82	20.73	20.92
		50	50	20.90	20.82	20.78
		100	0	20.91	20.88	20.82
20M	64QAM	1	0	20.79	20.79	20.95
		1	50	20.74	20.79	20.85
		1	99	20.81	20.80	20.72
		50	0	19.63	19.73	19.64
		50	25	19.72	19.71	19.82
		50	50	19.87	19.81	19.72
		100	0	19.85	19.84	19.73

LTE Band 25						
BW	MCS Index	RB Size	RB Offset	Low	Mid	High
		Channel		26115	26365	26615
		Frequency (MHz)		1857.5	1882.5	1907.5
15M	QPSK	1	0	22.78	22.81	22.87
		1	37	22.83	22.88	22.95
		1	74	22.98	22.91	22.94
		36	0	21.74	21.74	21.74
		36	19	21.83	21.80	21.77
		36	39	21.75	21.79	21.73
		75	0	21.98	21.88	21.93
15M	16QAM	1	0	21.82	21.88	21.87
		1	37	21.84	21.91	22.00
		1	74	22.08	21.93	22.04
		36	0	20.74	20.82	20.82
		36	19	20.88	20.89	20.77
		36	39	20.82	20.84	20.73
		75	0	21.02	20.98	21.02
15M	64QAM	1	0	20.73	20.86	20.86
		1	37	20.83	20.88	20.91
		1	74	21.06	20.89	20.99
		36	0	19.74	19.79	19.72
		36	19	19.81	19.82	19.71
		36	39	19.82	19.77	19.63
		75	0	19.94	19.88	19.99

LTE Band 25						
BW	MCS Index	RB Size	RB Offset	Low	Mid	High
		Channel		26090	26365	26640
		Frequency (MHz)		1855	1882.5	1910
10M	QPSK	1	0	22.91	22.86	22.86
		1	24	22.85	22.90	22.92
		1	49	22.85	22.88	22.82
		25	0	21.93	21.87	21.89
		25	12	21.84	21.83	21.78
		25	25	21.87	21.84	21.74
		50	0	21.91	21.85	21.82
10M	16QAM	1	0	21.95	21.86	21.96
		1	24	21.91	21.92	21.96
		1	49	21.88	21.92	21.90
		25	0	20.99	20.90	20.95
		25	12	20.87	20.86	20.85
		25	25	20.90	20.87	20.79
		50	0	20.95	20.91	20.82
10M	64QAM	1	0	20.95	20.84	20.88
		1	24	20.85	20.90	20.96
		1	49	20.78	20.87	20.84
		25	0	19.90	19.87	19.91
		25	12	19.79	19.85	19.79
		25	25	19.82	19.83	19.70
		50	0	19.88	19.83	19.80

LTE Band 25						
BW	MCS Index	RB Size	RB Offset	Low	Mid	High
		Channel		26065	26365	26665
		Frequency (MHz)		1852.5	1882.5	1912.5
5M	QPSK	1	0	22.90	22.80	22.77
		1	12	22.78	22.83	22.75
		1	24	22.86	22.84	22.77
		12	0	21.91	21.89	21.88
		12	6	21.92	21.86	21.89
		12	13	21.90	21.81	21.91
		25	0	21.85	21.78	21.71
5M	16QAM	1	0	21.97	21.81	21.79
		1	12	21.78	21.84	21.81
		1	24	21.86	21.86	21.86
		12	0	20.91	20.90	20.93
		12	6	21.01	20.96	20.97
		12	13	20.92	20.81	20.94
		25	0	20.92	20.88	20.71
5M	64QAM	1	0	20.89	20.71	20.77
		1	12	20.71	20.77	20.80
		1	24	20.85	20.83	20.81
		12	0	19.87	19.81	19.86
		12	6	19.91	19.95	19.93
		12	13	19.88	19.75	19.85
		25	0	19.92	19.86	19.64

LTE Band 25						
BW	MCS Index	RB Size	RB Offset	Low	Mid	High
		Channel		26055	26365	26675
		Frequency (MHz)		1851.5	1882.5	1913.5
3M	QPSK	1	0	22.68	22.78	22.88
		1	7	22.82	22.86	22.79
		1	14	22.86	22.85	22.76
		8	0	21.78	21.86	21.85
		8	3	21.83	21.83	21.89
		8	7	21.79	21.79	21.73
		15	0	21.77	21.73	21.70
3M	16QAM	1	0	21.75	21.84	21.95
		1	7	21.90	21.94	21.84
		1	14	21.91	21.92	21.77
		8	0	20.84	20.86	20.93
		8	3	20.91	20.88	20.94
		8	7	20.82	20.88	20.80
		15	0	20.81	20.75	20.77
3M	64QAM	1	0	20.66	20.78	20.90
		1	7	20.84	20.93	20.80
		1	14	20.89	20.87	20.72
		8	0	19.83	19.82	19.85
		8	3	19.86	19.88	19.87
		8	7	19.74	19.80	19.78
		15	0	19.78	19.71	19.77

LTE Band 25						
BW	MCS Index	RB Size	RB Offset	Low	Mid	High
		Channel		26047	26365	26683
		Frequency (MHz)		1850.7	1882.5	1914.3
1.4M	QPSK	1	0	22.89	22.79	22.82
		1	2	22.97	22.91	22.94
		1	5	22.80	22.90	22.94
		3	0	22.71	22.81	22.84
		3	1	22.81	22.83	22.76
		3	3	22.74	22.81	22.76
		6	0	21.94	21.89	21.88
1.4M	16QAM	1	0	21.97	21.89	21.84
		1	2	22.00	21.91	21.99
		1	5	21.82	21.90	22.02
		3	0	21.71	21.90	21.94
		3	1	21.91	21.87	21.80
		3	3	21.76	21.89	21.78
		6	0	20.95	20.95	20.94
1.4M	64QAM	1	0	20.90	20.80	20.82
		1	2	20.99	20.81	20.96
		1	5	20.74	20.80	20.93
		3	0	20.64	20.88	20.86
		3	1	20.89	20.82	20.70
		3	3	20.66	20.86	20.68
		6	0	19.87	19.89	19.93

EIRP Power (dBm)

Band	GPRS, EDGE 1900		
Channel	512	661	810
Frequency	1850.2	1880	1909.8
GPRS	31.52	31.56	31.31
EDGE	31.58	31.53	31.28

*EIRP = Conducted + antenna gain (1.80dBi)

Band	WCDMA II		
TX Channel	9262	9400	9538
Frequency	1852.4	1880	1907.6
RMC 12.2K	24.73	24.83	24.96
HSDPA	23.76	23.90	23.90
HSUPA	23.63	23.74	23.81

*EIRP = Conducted + antenna gain (1.80dBi)

LTE Band 2						
BW	MCS Index	RB Size	RB Offset	Low	Mid	High
		Channel		18700	18900	19100
		Frequency (MHz)		1860	1880	1900
20M	QPSK	1	0	24.93	24.86	24.77
		1	50	24.88	24.78	24.71
		1	99	24.76	24.69	24.59
		50	0	23.75	23.85	23.85
		50	25	23.91	23.81	23.80
		50	50	23.67	23.68	23.74
		100	0	23.82	23.79	23.83
20M	16QAM	1	0	24.03	23.95	23.81
		1	50	23.89	23.82	23.75
		1	99	23.78	23.71	23.61
		50	0	22.77	22.92	22.85
		50	25	22.98	22.90	22.81
		50	50	22.69	22.76	22.79
		100	0	22.83	22.84	22.92
20M	64QAM	1	0	22.96	22.85	22.79
		1	50	22.84	22.78	22.68
		1	99	22.69	22.64	22.51
		50	0	21.76	21.92	21.84
		50	25	21.97	21.90	21.75
		50	50	21.60	21.73	21.70
		100	0	21.83	21.74	21.91

*EIRP = Conducted + antenna gain (1.80dBi)

LTE Band 2						
BW	MCS Index	RB Size	RB Offset	Low	Mid	High
		Channel		18675	18900	19125
		Frequency (MHz)		1857.5	1880	1902.5
15M	QPSK	1	0	24.85	24.82	24.91
		1	37	24.59	24.59	24.50
		1	74	24.57	24.65	24.63
		36	0	23.87	23.93	24.00
		36	19	23.80	23.82	23.73
		36	39	23.69	23.78	23.72
		75	0	23.77	23.70	23.72
15M	16QAM	1	0	23.85	23.85	23.92
		1	37	23.61	23.66	23.51
		1	74	23.59	23.75	23.69
		36	0	22.93	22.98	23.09
		36	19	22.81	22.87	22.75
		36	39	22.77	22.83	22.81
		75	0	22.83	22.77	22.72
15M	64QAM	1	0	22.81	22.82	22.83
		1	37	22.55	22.59	22.51
		1	74	22.57	22.71	22.64
		36	0	21.86	21.88	22.04
		36	19	21.71	21.85	21.73
		36	39	21.70	21.76	21.79
		75	0	21.81	21.75	21.62

*EIRP = Conducted + antenna gain (1.80dBi)

LTE Band 2						
BW	MCS Index	RB Size	RB Offset	Low	Mid	High
		Channel		18650	18900	19150
		Frequency (MHz)		1855	1880	1905
10M	QPSK	1	0	24.54	24.55	24.50
		1	24	24.81	24.84	24.78
		1	49	24.71	24.74	24.82
		25	0	23.79	23.80	23.70
		25	12	23.59	23.69	23.60
		25	25	23.84	23.85	23.81
		50	0	23.81	23.79	23.73
10M	16QAM	1	0	23.62	23.58	23.50
		1	24	23.91	23.85	23.85
		1	49	23.72	23.83	23.84
		25	0	22.87	22.80	22.79
		25	12	22.60	22.73	22.62
		25	25	22.94	22.86	22.87
		50	0	22.87	22.86	22.75
10M	64QAM	1	0	22.54	22.51	22.41
		1	24	22.91	22.77	22.83
		1	49	22.72	22.75	22.77
		25	0	21.81	21.75	21.73
		25	12	21.56	21.69	21.54
		25	25	21.89	21.80	21.87
		50	0	21.80	21.84	21.75

*EIRP = Conducted + antenna gain (1.80dBi)

LTE Band 2						
BW	MCS Index	RB Size	RB Offset	Low	Mid	High
		Channel		18625	18900	19175
		Frequency (MHz)		1852.5	1880	1907.5
5M	QPSK	1	0	24.54	24.52	24.56
		1	12	24.68	24.68	24.73
		1	24	24.49	24.58	24.50
		12	0	23.73	23.75	23.82
		12	6	23.82	23.87	23.82
		12	13	23.75	23.83	23.86
		25	0	23.78	23.72	23.66
5M	16QAM	1	0	23.59	23.56	23.60
		1	12	23.74	23.71	23.73
		1	24	23.54	23.65	23.60
		12	0	22.78	22.79	22.85
		12	6	22.91	22.95	22.89
		12	13	22.83	22.93	22.94
		25	0	22.86	22.81	22.68
5M	64QAM	1	0	22.49	22.53	22.59
		1	12	22.69	22.65	22.67
		1	24	22.45	22.56	22.58
		12	0	21.72	21.77	21.75
		12	6	21.90	21.94	21.89
		12	13	21.78	21.84	21.92
		25	0	21.77	21.77	21.58

*EIRP = Conducted + antenna gain (1.80dBi)

LTE Band 2						
BW	MCS Index	RB Size	RB Offset	Low	Mid	High
		Channel		18615	18900	19185
		Frequency (MHz)		1851.5	1880	1908.5
3M	QPSK	1	0	24.57	24.64	24.60
		1	7	24.63	24.72	24.62
		1	14	24.74	24.68	24.65
		8	0	23.74	23.74	23.68
		8	3	23.98	23.89	23.83
		8	7	23.91	23.82	23.89
		15	0	23.92	23.85	23.94
3M	16QAM	1	0	23.63	23.70	23.62
		1	7	23.67	23.75	23.66
		1	14	23.84	23.77	23.70
		8	0	22.77	22.80	22.72
		8	3	23.05	22.91	22.84
		8	7	22.99	22.89	22.94
		15	0	22.93	22.86	23.04
3M	64QAM	1	0	22.55	22.66	22.59
		1	7	22.59	22.73	22.58
		1	14	22.75	22.73	22.66
		8	0	21.72	21.77	21.68
		8	3	22.03	21.91	21.75
		8	7	21.99	21.87	21.93
		15	0	21.91	21.84	22.01

*EIRP = Conducted + antenna gain (1.80dBi)

LTE Band 2						
BW	MCS Index	RB Size	RB Offset	Low	Mid	High
		Channel		18607	18900	19193
		Frequency (MHz)		1850.7	1880	1909.3
1.4M	QPSK	1	0	24.51	24.56	24.61
		1	2	24.65	24.68	24.78
		1	5	24.67	24.57	24.62
		3	0	24.86	24.76	24.66
		3	1	24.61	24.65	24.61
		3	3	24.82	24.73	24.76
		6	0	23.84	23.76	23.68
1.4M	16QAM	1	0	23.54	23.59	23.66
		1	2	23.65	23.74	23.82
		1	5	23.68	23.59	23.72
		3	0	23.90	23.80	23.73
		3	1	23.68	23.74	23.65
		3	3	23.85	23.76	23.81
		6	0	22.93	22.76	22.74
1.4M	64QAM	1	0	22.47	22.51	22.63
		1	2	22.62	22.70	22.75
		1	5	22.58	22.54	22.65
		3	0	22.88	22.77	22.66
		3	1	22.63	22.72	22.57
		3	3	22.81	22.74	22.79
		6	0	21.84	21.76	21.65

*EIRP = Conducted + antenna gain (1.80dBi)

LTE Band 25						
BW	MCS Index	RB Size	RB Offset	Low	Mid	High
		Channel		26140	26365	26590
		Frequency (MHz)		1860	1882.5	1905
20M	QPSK	1	0	24.58	24.63	24.69
		1	50	24.52	24.59	24.61
		1	99	24.60	24.61	24.51
		50	0	23.46	23.51	23.47
		50	25	23.58	23.53	23.63
		50	50	23.65	23.60	23.54
		100	0	23.62	23.63	23.59
20M	16QAM	1	0	23.64	23.66	23.75
		1	50	23.60	23.68	23.68
		1	99	23.61	23.70	23.56
		50	0	22.51	22.55	22.52
		50	25	22.62	22.53	22.72
		50	50	22.70	22.62	22.58
		100	0	22.71	22.68	22.62
20M	64QAM	1	0	22.59	22.59	22.75
		1	50	22.54	22.59	22.65
		1	99	22.61	22.60	22.52
		50	0	21.43	21.53	21.44
		50	25	21.52	21.51	21.62
		50	50	21.67	21.61	21.52
		100	0	21.65	21.64	21.53

*EIRP = Conducted + antenna gain (1.80dBi)

LTE Band 25						
BW	MCS Index	RB Size	RB Offset	Low	Mid	High
		Channel		26115	26365	26615
		Frequency (MHz)		1857.5	1882.5	1907.5
15M	QPSK	1	0	24.58	24.61	24.67
		1	37	24.63	24.68	24.75
		1	74	24.78	24.71	24.74
		36	0	23.54	23.54	23.54
		36	19	23.63	23.60	23.57
		36	39	23.55	23.59	23.53
		75	0	23.78	23.68	23.73
15M	16QAM	1	0	23.62	23.68	23.67
		1	37	23.64	23.71	23.80
		1	74	23.88	23.73	23.84
		36	0	22.54	22.62	22.62
		36	19	22.68	22.69	22.57
		36	39	22.62	22.64	22.53
		75	0	22.82	22.78	22.82
15M	64QAM	1	0	22.53	22.66	22.66
		1	37	22.63	22.68	22.71
		1	74	22.86	22.69	22.79
		36	0	21.54	21.59	21.52
		36	19	21.61	21.62	21.51
		36	39	21.62	21.57	21.43
		75	0	21.74	21.68	21.79

*EIRP = Conducted + antenna gain (1.80dBi)

LTE Band 25						
BW	MCS Index	RB Size	RB Offset	Low	Mid	High
		Channel		26090	26365	26640
		Frequency (MHz)		1855	1882.5	1910
10M	QPSK	1	0	24.71	24.66	24.66
		1	24	24.65	24.70	24.72
		1	49	24.65	24.68	24.62
		25	0	23.73	23.67	23.69
		25	12	23.64	23.63	23.58
		25	25	23.67	23.64	23.54
		50	0	23.71	23.65	23.62
10M	16QAM	1	0	23.75	23.66	23.76
		1	24	23.71	23.72	23.76
		1	49	23.68	23.72	23.70
		25	0	22.79	22.70	22.75
		25	12	22.67	22.66	22.65
		25	25	22.70	22.67	22.59
		50	0	22.75	22.71	22.62
10M	64QAM	1	0	22.75	22.64	22.68
		1	24	22.65	22.70	22.76
		1	49	22.58	22.67	22.64
		25	0	21.70	21.67	21.71
		25	12	21.59	21.65	21.59
		25	25	21.62	21.63	21.50
		50	0	21.68	21.63	21.60

*EIRP = Conducted + antenna gain (1.80dBi)

LTE Band 25						
BW	MCS Index	RB Size	RB Offset	Low	Mid	High
		Channel		26065	26365	26665
		Frequency (MHz)		1852.5	1882.5	1912.5
5M	QPSK	1	0	24.70	24.60	24.57
		1	12	24.58	24.63	24.55
		1	24	24.66	24.64	24.57
		12	0	23.71	23.69	23.68
		12	6	23.72	23.66	23.69
		12	13	23.70	23.61	23.71
		25	0	23.65	23.58	23.51
5M	16QAM	1	0	23.77	23.61	23.59
		1	12	23.58	23.64	23.61
		1	24	23.66	23.66	23.66
		12	0	22.71	22.70	22.73
		12	6	22.81	22.76	22.77
		12	13	22.72	22.61	22.74
		25	0	22.72	22.68	22.51
5M	64QAM	1	0	22.69	22.51	22.57
		1	12	22.51	22.57	22.60
		1	24	22.65	22.63	22.61
		12	0	21.67	21.61	21.66
		12	6	21.71	21.75	21.73
		12	13	21.68	21.55	21.65
		25	0	21.72	21.66	21.44

*EIRP = Conducted + antenna gain (1.80dBi)

LTE Band 25						
BW	MCS Index	RB Size	RB Offset	Low	Mid	High
		Channel		26055	26365	26675
		Frequency (MHz)		1851.5	1882.5	1913.5
3M	QPSK	1	0	24.48	24.58	24.68
		1	7	24.62	24.66	24.59
		1	14	24.66	24.65	24.56
		8	0	23.58	23.66	23.65
		8	3	23.63	23.63	23.69
		8	7	23.59	23.59	23.53
		15	0	23.57	23.53	23.50
3M	16QAM	1	0	23.55	23.64	23.75
		1	7	23.70	23.74	23.64
		1	14	23.71	23.72	23.57
		8	0	22.64	22.66	22.73
		8	3	22.71	22.68	22.74
		8	7	22.62	22.68	22.60
		15	0	22.61	22.55	22.57
3M	64QAM	1	0	22.46	22.58	22.70
		1	7	22.64	22.73	22.60
		1	14	22.69	22.67	22.52
		8	0	21.63	21.62	21.65
		8	3	21.66	21.68	21.67
		8	7	21.54	21.60	21.58
		15	0	21.58	21.51	21.57

*EIRP = Conducted + antenna gain (1.80dBi)

LTE Band 25						
BW	MCS Index	RB Size	RB Offset	Low	Mid	High
		Channel		26047	26365	26683
		Frequency (MHz)		1850.7	1882.5	1914.3
1.4M	QPSK	1	0	24.69	24.59	24.62
		1	2	24.77	24.71	24.74
		1	5	24.60	24.70	24.74
		3	0	24.51	24.61	24.64
		3	1	24.61	24.63	24.56
		3	3	24.54	24.61	24.56
		6	0	23.74	23.69	23.68
1.4M	16QAM	1	0	23.77	23.69	23.64
		1	2	23.80	23.71	23.79
		1	5	23.62	23.70	23.82
		3	0	23.51	23.70	23.74
		3	1	23.71	23.67	23.60
		3	3	23.56	23.69	23.58
		6	0	22.75	22.75	22.74
1.4M	64QAM	1	0	22.70	22.60	22.62
		1	2	22.79	22.61	22.76
		1	5	22.54	22.60	22.73
		3	0	22.44	22.68	22.66
		3	1	22.69	22.62	22.50
		3	3	22.46	22.66	22.48
		6	0	21.67	21.69	21.73

*EIRP = Conducted + antenna gain (1.80dBi)

4.2 Modulation Characteristics Measurement

4.2.1 Limits of Modulation Characteristics

N/A

4.2.2 Test Procedure

Connect the EUT to Communication Simulator via the antenna connector, The frequency band is set as EUT supported Modulation and Channels, the EUT output is matched with 50 ohm load, the waveform quality and constellation of the EUT was tested.

4.2.3 Test Setup



4.2.4 Test Results

GPRS, EDGE

Spectrum Plot of Measurement Value

Channel: 661 / Frequency (MHz): 1880.0MHz

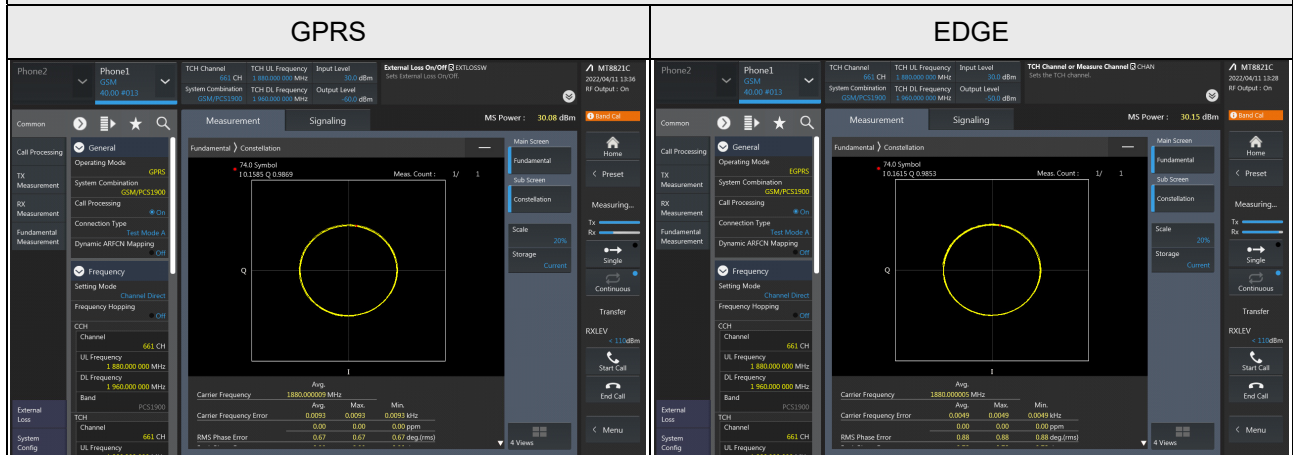

WCDMA Band 2

Spectrum Plot of Measurement Value

Channel: 9400 / Frequency (MHz): 1880.0MHz

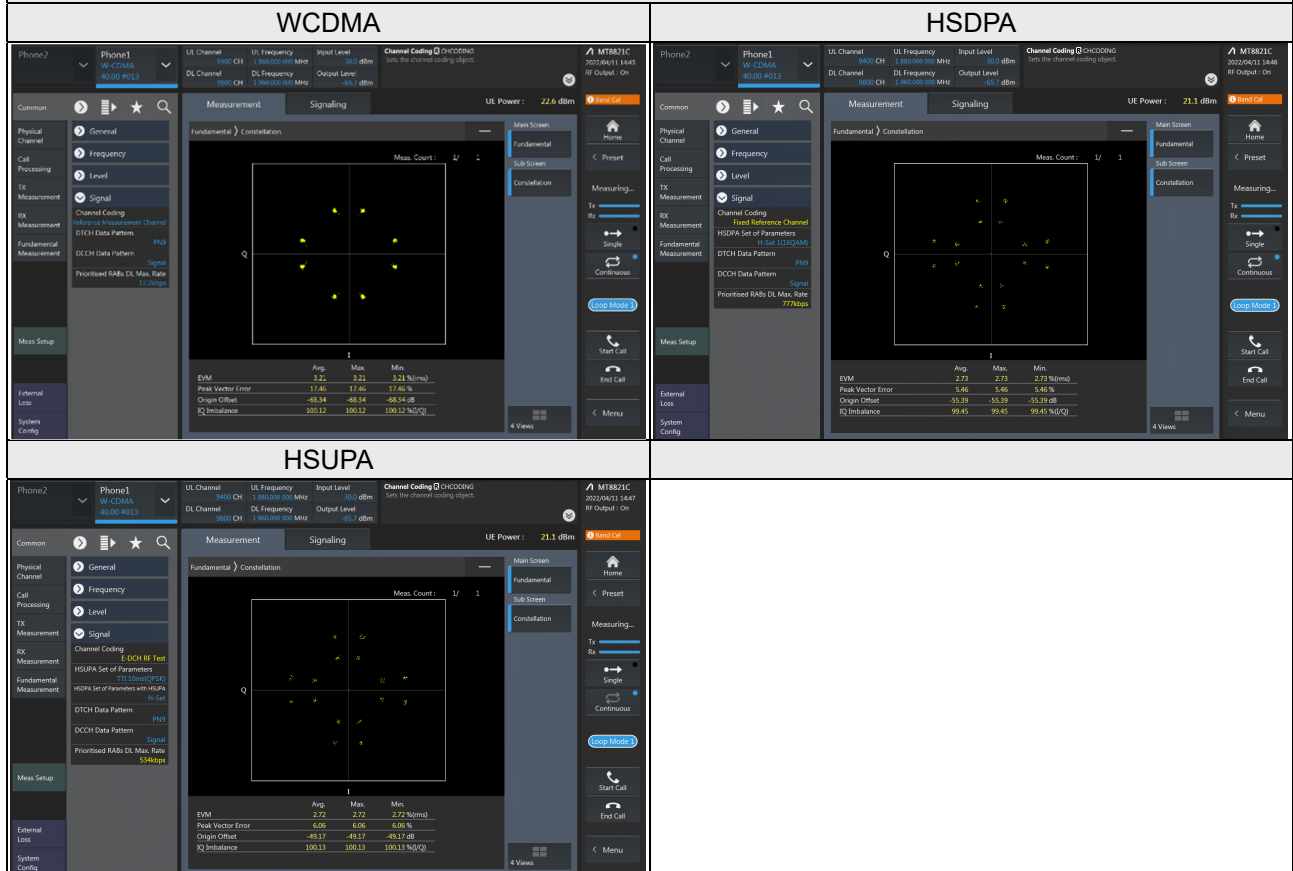

LTE Band 2

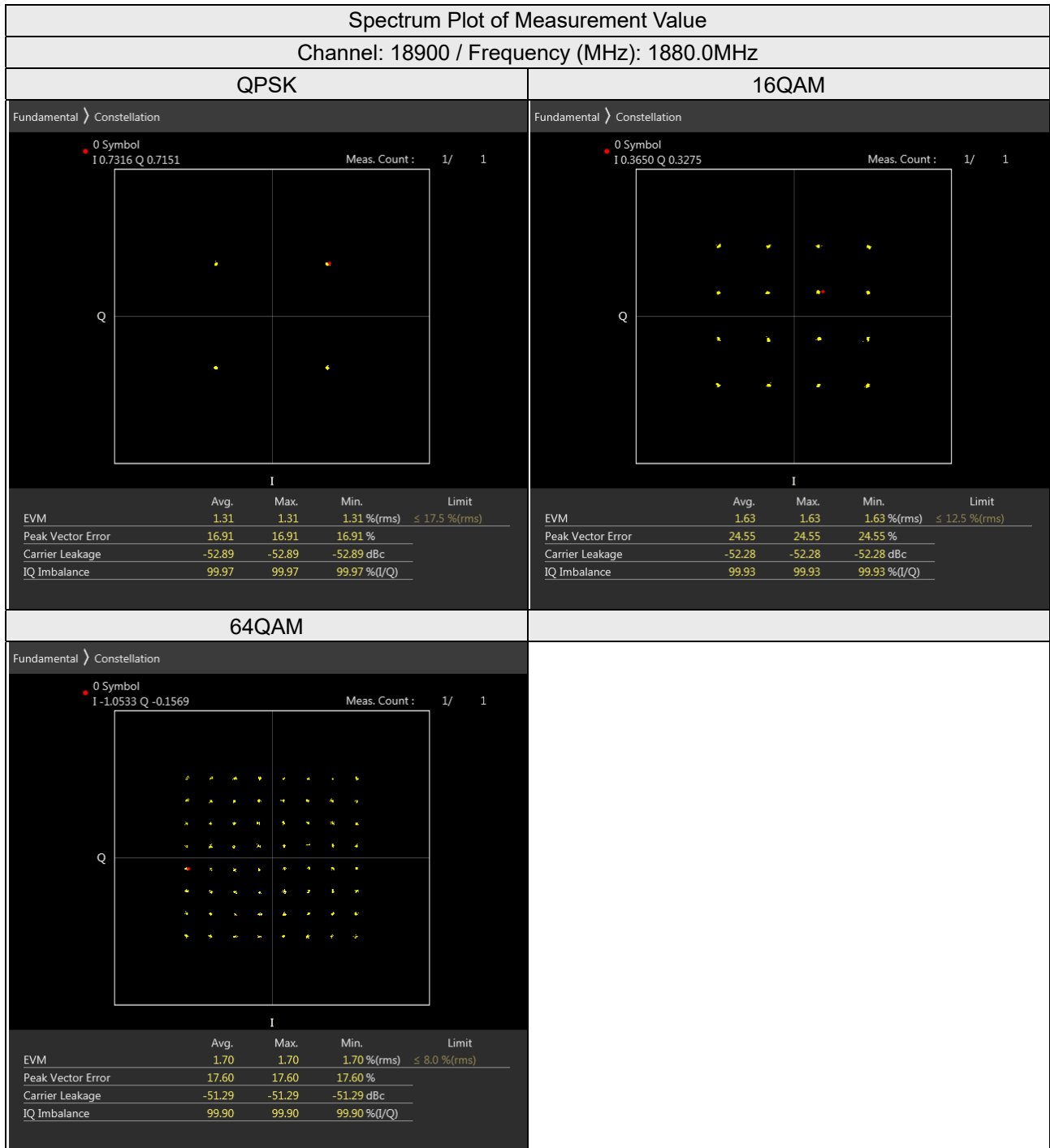

LTE Band 25

Spectrum Plot of Measurement Value

Channel: 26365 / Frequency (MHz): 1882.5MHz

QPSK

16QAM

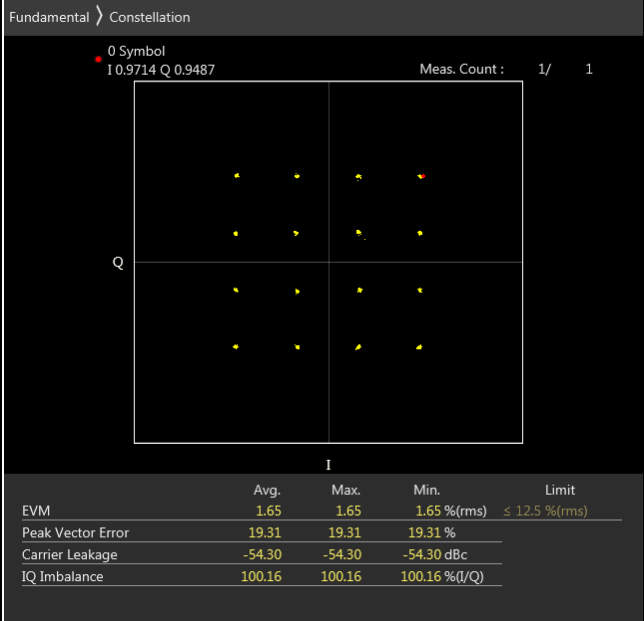
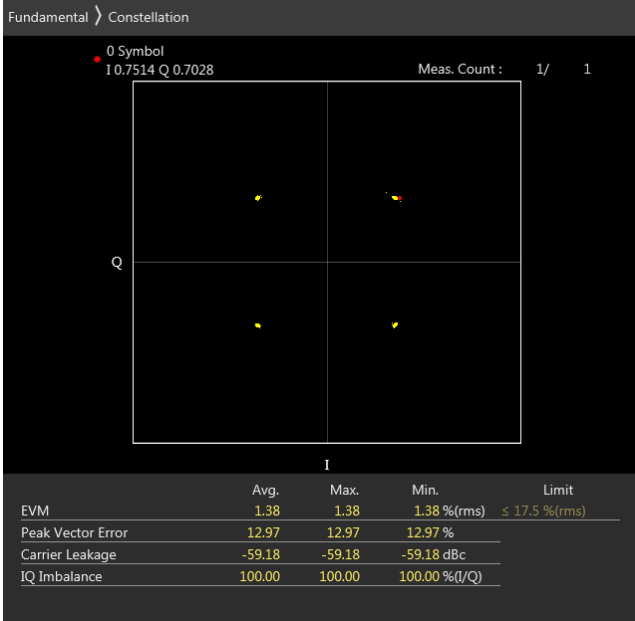

64QAM

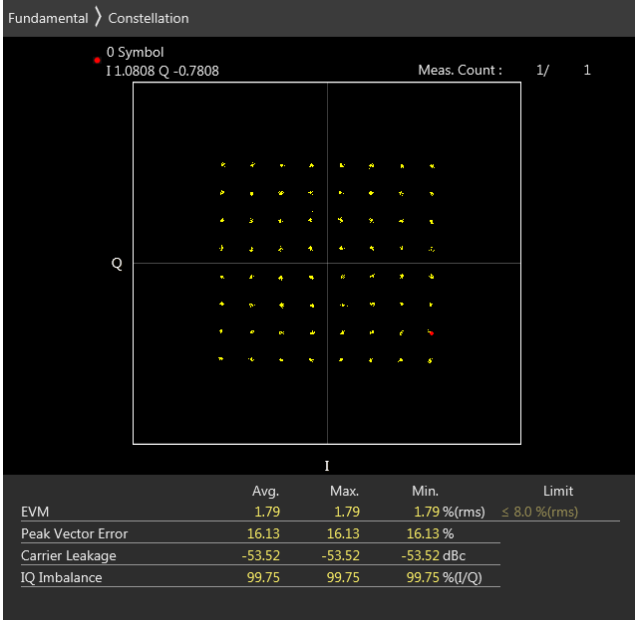

4.3 Frequency Stability Measurement

4.3.1 Limits of Frequency Stability Measurement

The frequency stability shall be sufficient to ensure that the fundamental emission stays within the authorized frequency block.

4.3.2 Test Procedure

- a. Device is placed at the oven room. The oven room could control the temperatures and humidity. Power warm up is at least 15 min and power applied should perform before recording frequency error.
- b. EUT is connected the external power supply to control the DC input power. The test voltage range is from minimum to maximum working voltage. Each step shall be record the frequency error rate.
- c. The temperature range step is 10 degrees in this test items. All temperature levels shall be hold the ± 0.5 °C during the measurement testing. The each temperature step shall be at least 0.5 hours, consider the EUT could be test under the stability condition.

Note: The frequency error was recorded frequency error from the communication simulator.

4.3.3 Conducted Setup

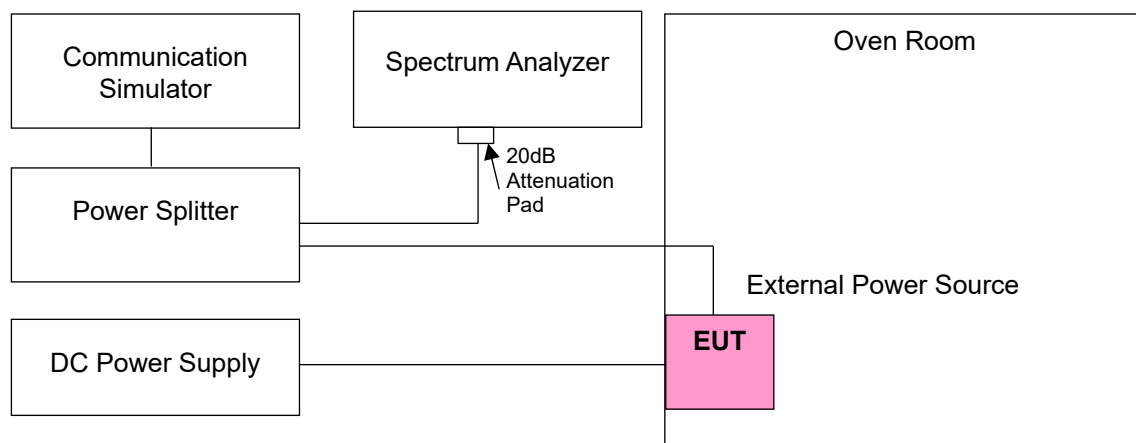

4.3.4 Test Results

Frequency Error vs. Voltage

Voltage (Vdc)	GPRS			
	Low Channel		High Channel	
	Frequency (MHz)	Frequency Error (ppm)	Frequency (MHz)	Frequency Error (ppm)
3.4	1850.199998	-0.001	1909.799997	-0.002
4.0	1850.200002	0.001	1909.800001	0.001
4.6	1850.199997	-0.002	1909.799997	-0.002

Note: The applicant defined the normal working voltage is from 3.4Vdc to 4.6Vdc.

Frequency Error vs. Temperature

Temp. (°C)	GPRS			
	Low Channel		High Channel	
	Frequency (MHz)	Frequency Error (ppm)	Frequency (MHz)	Frequency Error (ppm)
-40	1850.200004	0.002	1909.800002	0.001
-30	1850.200053	0.029	1909.799996	-0.002
-20	1850.199997	-0.002	1909.799998	-0.001
-10	1850.200003	0.002	1909.799998	-0.001
0	1850.199998	-0.001	1909.800004	0.002
10	1850.200001	0.001	1909.800003	0.002
20	1850.199997	-0.002	1909.799997	-0.002
30	1850.200004	0.002	1909.800003	0.002
40	1850.199999	-0.001	1909.799997	-0.002
50	1850.200004	0.002	1909.800004	0.002
60	1850.199997	-0.002	1909.799996	-0.002
70	1850.199998	-0.001	1909.799998	-0.001
80	1850.199999	-0.001	1909.799998	-0.001
85	1850.200003	0.002	1909.800001	0.001

Frequency Error vs. Voltage

Voltage (Vdc)	EDGE			
	Low Channel		High Channel	
	Frequency (MHz)	Frequency Error (ppm)	Frequency (MHz)	Frequency Error (ppm)
3.4	1850.199999	-0.001	1909.799996	-0.002
4.0	1850.200002	0.001	1909.799999	-0.001
4.6	1850.199996	-0.002	1909.799995	-0.003

Note: The applicant defined the normal working voltage is from 3.4Vdc to 4.6Vdc.

Frequency Error vs. Temperature

Temp. (°C)	EDGE			
	Low Channel		High Channel	
	Frequency (MHz)	Frequency Error (ppm)	Frequency (MHz)	Frequency Error (ppm)
-40	1850.200005	0.003	1909.800001	0.001
-30	1850.200005	0.003	1909.799995	-0.003
-20	1850.200004	0.002	1909.799999	-0.001
-10	1850.199996	-0.002	1909.799998	-0.001
0	1850.200004	0.002	1909.799998	-0.001
10	1850.199999	-0.001	1909.800005	0.003
20	1850.200002	0.001	1909.800002	0.001
30	1850.199998	-0.001	1909.799996	-0.002
40	1850.200004	0.002	1909.800004	0.002
50	1850.199998	-0.001	1909.799996	-0.002
60	1850.200005	0.003	1909.800004	0.002
70	1850.199996	-0.002	1909.799999	-0.001
80	1850.199999	-0.001	1909.799997	-0.002
85	1850.200005	0.003	1909.800001	0.001

Frequency Error vs. Voltage

Voltage (Vdc)	WCDMA			
	Low Channel		High Channel	
	Frequency (MHz)	Frequency Error (ppm)	Frequency (MHz)	Frequency Error (ppm)
3.4	1852.400004	0.002	1907.599999	-0.001
4.0	1852.399996	-0.002	1907.599996	-0.002
4.6	1852.400004	0.002	1907.599997	-0.002

Note: The applicant defined the normal working voltage is from 3.4Vdc to 4.6Vdc.

Frequency Error vs. Temperature

Temp. (°C)	WCDMA			
	Low Channel		High Channel	
	Frequency (MHz)	Frequency Error (ppm)	Frequency (MHz)	Frequency Error (ppm)
-40	1852.400004	0.002	1907.600001	0.001
-30	1852.399995	-0.003	1907.599997	-0.002
-20	1852.400004	0.002	1907.600004	0.002
-10	1852.400004	0.002	1907.599997	-0.002
0	1852.399997	-0.002	1907.599996	-0.002
10	1852.400003	0.002	1907.600002	0.001
20	1852.399996	-0.002	1907.600003	0.002
30	1852.400005	0.003	1907.600003	0.002
40	1852.399997	-0.002	1907.599998	-0.001
50	1852.399995	-0.003	1907.599996	-0.002
60	1852.399996	-0.002	1907.600001	0.001
70	1852.400003	0.002	1907.599995	-0.003
80	1852.399999	-0.001	1907.599998	-0.001
85	1852.399996	-0.002	1907.599996	-0.002

Frequency Error vs. Voltage

Voltage (Vdc)	LTE Band 2			
	Channel Bandwidth 1.4 MHz			
	Low Channel		High Channel	
	Frequency (MHz)	Frequency Error (ppm)	Frequency (MHz)	Frequency Error (ppm)
3.4	1850.699996	-0.002	1909.300000	0.000
4.0	1850.700002	0.001	1909.299995	-0.003
4.6	1850.699996	-0.002	1909.300002	0.001

Note: The applicant defined the normal working voltage is from 3.4Vdc to 4.6Vdc.

Frequency Error vs. Temperature

Temp. (°C)	LTE Band 2			
	Channel Bandwidth 1.4 MHz			
	Low Channel		High Channel	
	Frequency (MHz)	Frequency Error (ppm)	Frequency (MHz)	Frequency Error (ppm)
-40	1850.699996	-0.002	1909.300002	0.001
-30	1850.699998	-0.001	1909.299998	-0.001
-20	1850.699996	-0.002	1909.299997	-0.002
-10	1850.699996	-0.002	1909.299998	-0.001
0	1850.700003	0.002	1909.299995	-0.003
10	1850.700004	0.002	1909.300005	0.003
20	1850.700002	0.001	1909.300001	0.001
30	1850.699998	-0.001	1909.299998	-0.001
40	1850.699996	-0.002	1909.300001	0.001
50	1850.700005	0.003	1909.299996	-0.002
60	1850.699996	-0.002	1909.300005	0.003
70	1850.700003	0.002	1909.300001	0.001
80	1850.700004	0.002	1909.300004	0.002
85	1850.700003	0.002	1909.300001	0.001

Frequency Error vs. Voltage

Voltage (Vdc)	LTE Band 2			
	Channel Bandwidth 3MHz			
	Low Channel		High Channel	
	Frequency (MHz)	Frequency Error (ppm)	Frequency (MHz)	Frequency Error (ppm)
3.4	1851.500001	0.001	1908.499998	-0.001
4.0	1851.499997	-0.002	1908.499996	-0.002
4.6	1851.500001	0.001	1908.499999	-0.001

Note: The applicant defined the normal working voltage is from 3.4Vdc to 4.6Vdc.

Frequency Error vs. Temperature

Temp. (°C)	LTE Band 2			
	Channel Bandwidth 3MHz			
	Low Channel		High Channel	
	Frequency (MHz)	Frequency Error (ppm)	Frequency (MHz)	Frequency Error (ppm)
-40	1851.500001	0.001	1908.499995	-0.003
-30	1851.499996	-0.002	1908.500003	0.002
-20	1851.500002	0.001	1908.499996	-0.002
-10	1851.499996	-0.002	1908.500001	0.001
0	1851.500002	0.001	1908.500004	0.002
10	1851.499995	-0.003	1908.499998	-0.001
20	1851.500002	0.001	1908.500003	0.002
30	1851.500003	0.002	1908.499995	-0.003
40	1851.500002	0.001	1908.499999	-0.001
50	1851.499998	-0.001	1908.500005	0.003
60	1851.499997	-0.002	1908.499998	-0.001
70	1851.500001	0.001	1908.499995	-0.003
80	1851.499998	-0.001	1908.500002	0.001
85	1851.500002	0.001	1908.500001	0.001

Frequency Error vs. Voltage

Voltage (Vdc)	LTE Band 2			
	Channel Bandwidth 5 MHz			
	Low Channel		High Channel	
	Frequency (MHz)	Frequency Error (ppm)	Frequency (MHz)	Frequency Error (ppm)
3.4	1852.499999	-0.001	1907.499995	-0.003
4.0	1852.499996	-0.002	1907.500002	0.001
4.6	1852.500003	0.002	1907.500002	0.001

Note: The applicant defined the normal working voltage is from 3.4Vdc to 4.6Vdc.

Frequency Error vs. Temperature

Temp. (°C)	LTE Band 2			
	Channel Bandwidth 5 MHz			
	Low Channel		High Channel	
	Frequency (MHz)	Frequency Error (ppm)	Frequency (MHz)	Frequency Error (ppm)
-40	1852.500001	0.001	1907.499998	-0.001
-30	1852.499997	-0.002	1907.500004	0.002
-20	1852.499998	-0.001	1907.500001	0.001
-10	1852.499997	-0.002	1907.500005	0.003
0	1852.499996	-0.002	1907.499995	-0.003
10	1852.500005	0.003	1907.499998	-0.001
20	1852.500001	0.001	1907.500004	0.002
30	1852.500002	0.001	1907.500001	0.001
40	1852.499995	-0.003	1907.499997	-0.002
50	1852.500005	0.003	1907.499999	-0.001
60	1852.500003	0.002	1907.499995	-0.003
70	1852.500002	0.001	1907.500003	0.002
80	1852.499995	-0.003	1907.500003	0.002
85	1852.500003	0.002	1907.500005	0.003

Frequency Error vs. Voltage

Voltage (Vdc)	LTE Band 2			
	Channel Bandwidth 10 MHz			
	Low Channel		High Channel	
	Frequency (MHz)	Frequency Error (ppm)	Frequency (MHz)	Frequency Error (ppm)
3.4	1855.000003	0.002	1905.000005	0.003
4.0	1854.999997	-0.002	1905.000004	0.002
4.6	1855.000004	0.002	1904.999998	-0.001

Note: The applicant defined the normal working voltage is from 3.4Vdc to 4.6Vdc.

Frequency Error vs. Temperature

Temp. (°C)	LTE Band 2			
	Channel Bandwidth 10 MHz			
	Low Channel		High Channel	
	Frequency (MHz)	Frequency Error (ppm)	Frequency (MHz)	Frequency Error (ppm)
-40	1855.000005	0.003	1904.999999	-0.001
-30	1855.000003	0.002	1904.999997	-0.002
-20	1854.999999	-0.001	1904.999995	-0.003
-10	1855.000005	0.003	1904.999999	-0.001
0	1854.999998	-0.001	1904.999999	-0.001
10	1854.999997	-0.002	1905.000005	0.003
20	1855.000003	0.002	1905.000004	0.002
30	1855.000005	0.003	1905.000002	0.001
40	1855.000004	0.002	1905.000005	0.003
50	1854.999995	-0.003	1904.999995	-0.003
60	1854.999997	-0.002	1905.000005	0.003
70	1854.999999	-0.001	1905.000001	0.001
80	1854.999998	-0.001	1905.000002	0.001
85	1854.999998	-0.001	1904.999996	-0.002

Frequency Error vs. Voltage

Voltage (Vdc)	LTE Band 2			
	Channel Bandwidth 15 MHz			
	Low Channel		High Channel	
	Frequency (MHz)	Frequency Error (ppm)	Frequency (MHz)	Frequency Error (ppm)
3.4	1857.499996	-0.002	1902.499995	-0.003
4.0	1857.499996	-0.002	1902.499997	-0.002
4.6	1857.499998	-0.001	1902.500003	0.002

Note: The applicant defined the normal working voltage is from 3.4Vdc to 4.6Vdc.

Frequency Error vs. Temperature

Temp. (°C)	LTE Band 2			
	Channel Bandwidth 15 MHz			
	Low Channel		High Channel	
	Frequency (MHz)	Frequency Error (ppm)	Frequency (MHz)	Frequency Error (ppm)
-40	1857.499999	-0.001	1902.499995	-0.003
-30	1857.500002	0.001	1902.499997	-0.002
-20	1857.500002	0.001	1902.499999	-0.001
-10	1857.499996	-0.002	1902.499998	-0.001
0	1857.500002	0.001	1902.499998	-0.001
10	1857.499998	-0.001	1902.500004	0.002
20	1857.499998	-0.001	1902.499998	-0.001
30	1857.500004	0.002	1902.500002	0.001
40	1857.500002	0.001	1902.499995	-0.003
50	1857.499997	-0.002	1902.500002	0.001
60	1857.500001	0.001	1902.499997	-0.002
70	1857.499995	-0.003	1902.500004	0.002
80	1857.500002	0.001	1902.500004	0.002
85	1857.500001	0.001	1902.499999	-0.001

Frequency Error vs. Voltage

Voltage (Vdc)	LTE Band 2			
	Channel Bandwidth 20 MHz			
	Low Channel		High Channel	
	Frequency (MHz)	Frequency Error (ppm)	Frequency (MHz)	Frequency Error (ppm)
3.4	1859.999996	-0.002	1899.999998	-0.001
4.0	1859.999998	-0.001	1899.999997	-0.002
4.6	1860.000002	0.001	1900.000001	0.001

Note: The applicant defined the normal working voltage is from 3.4Vdc to 4.6Vdc.

Frequency Error vs. Temperature

Temp. (°C)	LTE Band 2			
	Channel Bandwidth 20 MHz			
	Low Channel		High Channel	
	Frequency (MHz)	Frequency Error (ppm)	Frequency (MHz)	Frequency Error (ppm)
-40	1860.000004	0.002	1899.999999	-0.001
-30	1859.999998	-0.001	1900.000005	0.003
-20	1860.000004	0.002	1899.999997	-0.002
-10	1860.000002	0.001	1899.999995	-0.003
0	1859.999998	-0.001	1899.999997	-0.002
10	1860.000005	0.003	1900.000003	0.002
20	1860.000004	0.002	1899.999996	-0.002
30	1859.999998	-0.001	1899.999996	-0.002
40	1860.000001	0.001	1899.999995	-0.003
50	1860.000002	0.001	1899.999997	-0.002
60	1859.999995	-0.003	1899.999997	-0.002
70	1859.999996	-0.002	1899.999999	-0.001
80	1859.999999	-0.001	1899.999997	-0.002
85	1860.000005	0.003	1900.000005	0.003

Frequency Error vs. Voltage

Voltage (Vdc)	LTE Band 25			
	Channel Bandwidth 1.4 MHz			
	Low Channel		High Channel	
	Frequency (MHz)	Frequency Error (ppm)	Frequency (MHz)	Frequency Error (ppm)
3.4	1850.699997	-0.002	1914.299998	-0.001
4.0	1850.700005	0.003	1914.300002	0.001
4.6	1850.700003	0.002	1914.300004	0.002

Note: The applicant defined the normal working voltage is from 3.4Vdc to 4.6Vdc.

Frequency Error vs. Temperature

Temp. (°C)	LTE Band 25			
	Channel Bandwidth 1.4 MHz			
	Low Channel		High Channel	
	Frequency (MHz)	Frequency Error (ppm)	Frequency (MHz)	Frequency Error (ppm)
-40	1850.700003	0.002	1914.300004	0.002
-30	1850.699997	-0.002	1914.299997	-0.002
-20	1850.699996	-0.002	1914.299999	-0.001
-10	1850.699998	-0.001	1914.299996	-0.002
0	1850.699999	-0.001	1914.299995	-0.003
10	1850.700004	0.002	1914.299998	-0.001
20	1850.699998	-0.001	1914.300003	0.002
30	1850.699996	-0.002	1914.300001	0.001
40	1850.699996	-0.002	1914.299997	-0.002
50	1850.699999	-0.001	1914.299995	-0.003
60	1850.700002	0.001	1914.300005	0.003
70	1850.700005	0.003	1914.299998	-0.001
80	1850.699996	-0.002	1914.299998	-0.001
85	1850.700005	0.003	1914.299995	-0.003

Frequency Error vs. Voltage

Voltage (Vdc)	LTE Band 25			
	Channel Bandwidth 3MHz			
	Low Channel		High Channel	
	Frequency (MHz)	Frequency Error (ppm)	Frequency (MHz)	Frequency Error (ppm)
3.4	1851.500002	0.001	1913.499996	-0.002
4.0	1851.499996	-0.002	1913.500005	0.003
4.6	1851.500003	0.002	1913.500001	0.001

Note: The applicant defined the normal working voltage is from 3.4Vdc to 4.6Vdc.

Frequency Error vs. Temperature

Temp. (°C)	LTE Band 25			
	Channel Bandwidth 3MHz			
	Low Channel		High Channel	
	Frequency (MHz)	Frequency Error (ppm)	Frequency (MHz)	Frequency Error (ppm)
-40	1851.500004	0.002	1913.499999	-0.001
-30	1851.499998	-0.001	1913.500004	0.002
-20	1851.500003	0.002	1913.499999	-0.001
-10	1851.500003	0.002	1913.499998	-0.001
0	1851.500002	0.001	1913.499999	-0.001
10	1851.500002	0.001	1913.499996	-0.002
20	1851.499996	-0.002	1913.500001	0.001
30	1851.500001	0.001	1913.500004	0.002
40	1851.500005	0.003	1913.499999	-0.001
50	1851.500002	0.001	1913.499999	-0.001
60	1851.500002	0.001	1913.499999	-0.001
70	1851.500003	0.002	1913.499998	-0.001
80	1851.499999	-0.001	1913.500003	0.002
85	1851.500002	0.001	1913.499999	-0.001

Frequency Error vs. Voltage

Voltage (Vdc)	LTE Band 25			
	Channel Bandwidth 5 MHz			
	Low Channel		High Channel	
	Frequency (MHz)	Frequency Error (ppm)	Frequency (MHz)	Frequency Error (ppm)
3.4	1852.499998	-0.001	1912.500002	0.001
4.0	1852.500002	0.001	1912.499996	-0.002
4.6	1852.499996	-0.002	1912.500002	0.001

Note: The applicant defined the normal working voltage is from 3.4Vdc to 4.6Vdc.

Frequency Error vs. Temperature

Temp. (°C)	LTE Band 25			
	Channel Bandwidth 5 MHz			
	Low Channel		High Channel	
	Frequency (MHz)	Frequency Error (ppm)	Frequency (MHz)	Frequency Error (ppm)
-40	1852.500003	0.002	1912.500001	0.001
-30	1852.500004	0.002	1912.499996	-0.002
-20	1852.499996	-0.002	1912.500004	0.002
-10	1852.499999	-0.001	1912.500001	0.001
0	1852.500002	0.001	1912.500002	0.001
10	1852.500001	0.001	1912.499999	-0.001
20	1852.500004	0.002	1912.500005	0.003
30	1852.499995	-0.003	1912.499995	-0.003
40	1852.500004	0.002	1912.500005	0.003
50	1852.499995	-0.003	1912.500004	0.002
60	1852.499995	-0.003	1912.500003	0.002
70	1852.499998	-0.001	1912.499996	-0.002
80	1852.499996	-0.002	1912.499997	-0.002
85	1852.499998	-0.001	1912.500001	0.001

Frequency Error vs. Voltage

Voltage (Vdc)	LTE Band 25			
	Channel Bandwidth 10 MHz			
	Low Channel		High Channel	
	Frequency (MHz)	Frequency Error (ppm)	Frequency (MHz)	Frequency Error (ppm)
3.4	1854.999995	-0.003	1909.999997	-0.002
4.0	1854.999995	-0.003	1910.000002	0.001
4.6	1854.999995	-0.003	1909.999995	-0.003

Note: The applicant defined the normal working voltage is from 3.4Vdc to 4.6Vdc.

Frequency Error vs. Temperature

Temp. (°C)	LTE Band 25			
	Channel Bandwidth 10 MHz			
	Low Channel		High Channel	
	Frequency (MHz)	Frequency Error (ppm)	Frequency (MHz)	Frequency Error (ppm)
-40	1855.000005	0.003	1909.999995	-0.003
-30	1854.999999	-0.001	1909.999995	-0.003
-20	1855.000002	0.001	1909.999997	-0.002
-10	1854.999997	-0.002	1909.999997	-0.002
0	1855.000004	0.002	1909.999996	-0.002
10	1854.999998	-0.001	1910.000005	0.003
20	1854.999999	-0.001	1909.999999	-0.001
30	1855.000003	0.002	1909.999995	-0.003
40	1854.999999	-0.001	1909.999998	-0.001
50	1855.000001	0.001	1909.999996	-0.002
60	1854.999998	-0.001	1909.999996	-0.002
70	1854.999995	-0.003	1909.999999	-0.001
80	1854.999999	-0.001	1910.000003	0.002
85	1855.000002	0.001	1910.000003	0.002

Frequency Error vs. Voltage

Voltage (Vdc)	LTE Band 25			
	Channel Bandwidth 15 MHz			
	Low Channel		High Channel	
	Frequency (MHz)	Frequency Error (ppm)	Frequency (MHz)	Frequency Error (ppm)
3.4	1857.500002	0.001	1907.500004	0.002
4.0	1857.500002	0.001	1907.500002	0.001
4.6	1857.499996	-0.002	1907.500002	0.001

Note: The applicant defined the normal working voltage is from 3.4Vdc to 4.6Vdc.

Frequency Error vs. Temperature

Temp. (°C)	LTE Band 25			
	Channel Bandwidth 15 MHz			
	Low Channel		High Channel	
	Frequency (MHz)	Frequency Error (ppm)	Frequency (MHz)	Frequency Error (ppm)
-40	1857.499998	-0.001	1907.499996	-0.002
-30	1857.499998	-0.001	1907.499997	-0.002
-20	1857.500002	0.001	1907.500001	0.001
-10	1857.500003	0.002	1907.499997	-0.002
0	1857.499995	-0.003	1907.500003	0.002
10	1857.500003	0.002	1907.499997	-0.002
20	1857.499997	-0.002	1907.499998	-0.001
30	1857.500001	0.001	1907.499999	-0.001
40	1857.499998	-0.001	1907.499998	-0.001
50	1857.500001	0.001	1907.500001	0.001
60	1857.500004	0.002	1907.499996	-0.002
70	1857.500001	0.001	1907.499995	-0.003
80	1857.500004	0.002	1907.500001	0.001
85	1857.499999	-0.001	1907.499997	-0.002

Frequency Error vs. Voltage

Voltage (Vdc)	LTE Band 25			
	Channel Bandwidth 20 MHz			
	Low Channel		High Channel	
	Frequency (MHz)	Frequency Error (ppm)	Frequency (MHz)	Frequency Error (ppm)
3.4	1859.999998	-0.001	1905.000002	0.001
4.0	1859.999999	-0.001	1904.999996	-0.002
4.6	1859.999998	-0.001	1905.000005	0.003

Note: The applicant defined the normal working voltage is from 3.4Vdc to 4.6Vdc.

Frequency Error vs. Temperature

Temp. (°C)	LTE Band 25			
	Channel Bandwidth 20 MHz			
	Low Channel		High Channel	
	Frequency (MHz)	Frequency Error (ppm)	Frequency (MHz)	Frequency Error (ppm)
-40	1859.999995	-0.003	1904.999999	-0.001
-30	1859.999995	-0.003	1905.000003	0.002
-20	1860.000005	0.003	1904.999997	-0.002
-10	1860.000003	0.002	1904.999997	-0.002
0	1860.000002	0.001	1905.000002	0.001
10	1859.999997	-0.002	1904.999996	-0.002
20	1859.999995	-0.003	1905.000001	0.001
30	1860.000001	0.001	1904.999998	-0.001
40	1859.999996	-0.002	1904.999999	-0.001
50	1859.999996	-0.002	1905.000003	0.002
60	1860.000002	0.001	1905.000003	0.002
70	1860.000004	0.002	1905.000003	0.002
80	1860.000003	0.002	1905.000002	0.001
85	1859.999995	-0.003	1905.000004	0.002

4.4 Occupied Bandwidth Measurement

4.4.1 Test Procedure

For the 26dBc bandwidth measurement method, please refer to section 5.4.3 of ANSI C63.26.

- a) The spectrum analyzer center frequency is set to the nominal EUT channel center frequency. The span range for the spectrum analyzer shall be wide enough to see sufficient roll off of the signal to make the measurement.
- b) The nominal RBW shall be in the range of 1% to 5% of the anticipated OBW, and the VBW shall be set $\geq 3 \times$ RBW.
- c) Set the reference level of the instrument as required to prevent the signal amplitude from exceeding the maximum spectrum analyzer input mixer level for linear operation. See guidance provided in 4.2.3.
- d) The dynamic range of the spectrum analyzer at the selected RBW shall be more than 10 dB below the target “-X dB” requirement, i.e., if the requirement calls for measuring the -26 dB OBW, the spectrum analyzer noise floor at the selected RBW shall be at least 36 dB below the reference level.
- e) Set spectrum analyzer detection mode to peak, and the trace mode to max hold.
- f) Determine the following reference values: Set the EUT to transmit a modulated signal. Allow the trace to stabilize. Set the spectrum analyzer marker to the highest level of the displayed trace (this is the reference value).
- g) Determine the “-X dB amplitude” as equal to (Reference Value - X). Alternatively, this calculation can be performed on the spectrum analyzer using the delta-marker measurement function.
- h) Place two markers, one at the lowest and the other at the highest frequency of the envelope of the spectral display such that each marker is at or slightly below the “-X dB amplitude” determined in step f). If a marker is below this “-X dB amplitude” value it should be as close as possible to this value. The OBW is the positive frequency difference between the two markers.
- i) The OBW shall be reported by providing plot(s) of the measuring instrument display, to include markers depicting the relevant frequency and amplitude information (e.g., marker table). The frequency and amplitude axis and scale shall be clearly labeled. Tabular data may be reported in addition to the plot(s).

For the occupied bandwidth measurement method, please refer to section 5.4.4 of ANSI C63.26.

4.4.2 Test Setup

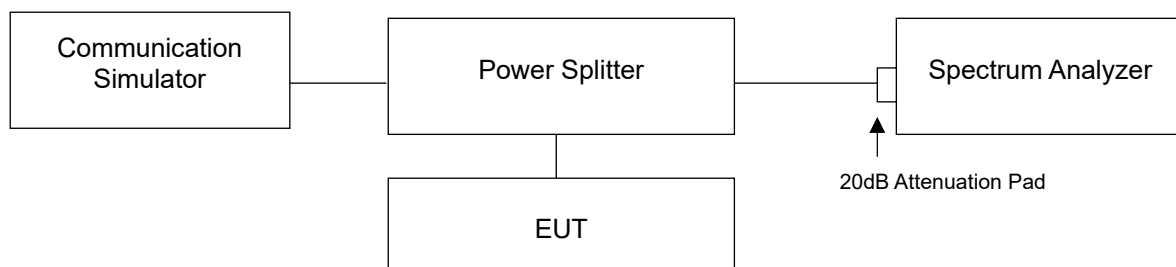

4.4.3 Test Result

GPRS, EDGE

Test Condition	Channel	Frequency (MHz)	Occupied bandwidth (kHz)	26dB Bandwidth (kHz)
GPRS	512	1850.2	247.19	314.1
GPRS	661	1880	247.31	320.3
GPRS	810	1909.8	245.92	316.7
EDGE	512	1850.2	248.87	319.6
EDGE	661	1880	247.29	316.9
EDGE	810	1909.8	246.95	317.1

Spectrum Plot of Worst Value

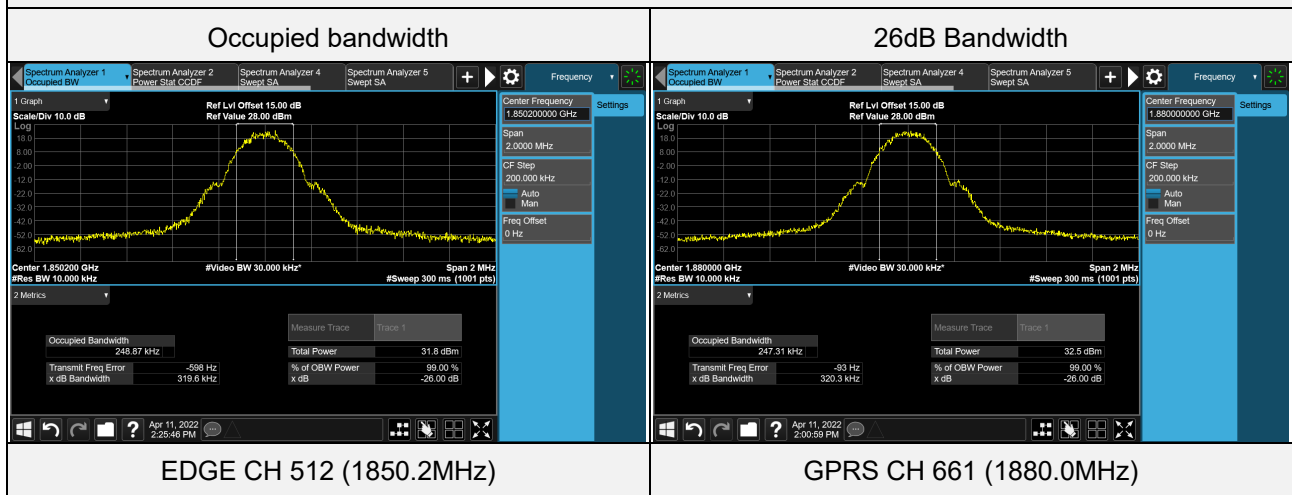

WCDMA Band 2

Test Condition	Channel	Frequency (MHz)	Occupied bandwidth (MHz)	26dB Bandwidth (MHz)
WCDMA	9262	1852.4	4.1772	4.692
WCDMA	9400	1880.0	4.1759	4.698
WCDMA	9538	1907.6	4.1804	4.692
HSDPA	9262	1852.4	4.1810	4.691
HSDPA	9400	1880.0	4.1802	4.702
HSDPA	9538	1907.6	4.1883	4.704
HSUPA	9262	1852.4	4.1800	4.700
HSUPA	9400	1880.0	4.1854	4.704
HSUPA	9538	1907.6	4.1854	4.704

Spectrum Plot of Worst Value

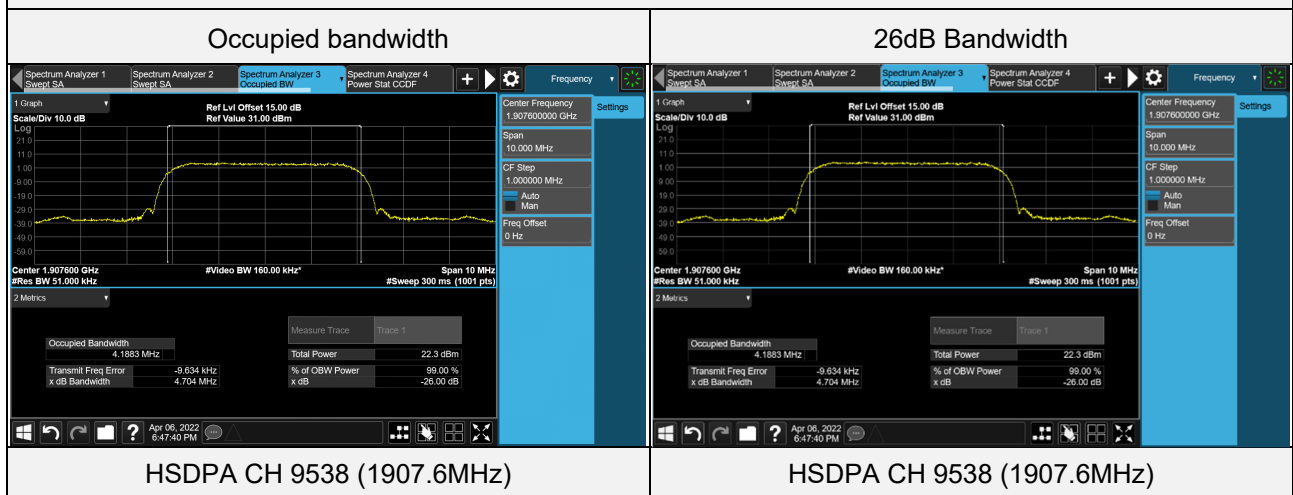

LTE Band 2 (Channel Bandwidth 1.4MHz)

Test Condition	Channel	Frequency (MHz)	Occupied bandwidth (MHz)	26dB Bandwidth (MHz)
QPSK	18607	1850.7	1.0876	1.250
QPSK	18900	1880	1.0894	1.261
QPSK	19193	1909.3	1.0894	1.255
16QAM	18607	1850.7	1.0874	1.244
16QAM	18900	1880	1.0858	1.245
16QAM	19193	1909.3	1.0866	1.253
64QAM	18607	1850.7	1.0879	1.256
64QAM	18900	1880	1.0882	1.252
64QAM	19193	1909.3	1.0877	1.253

Spectrum Plot of Worst Value

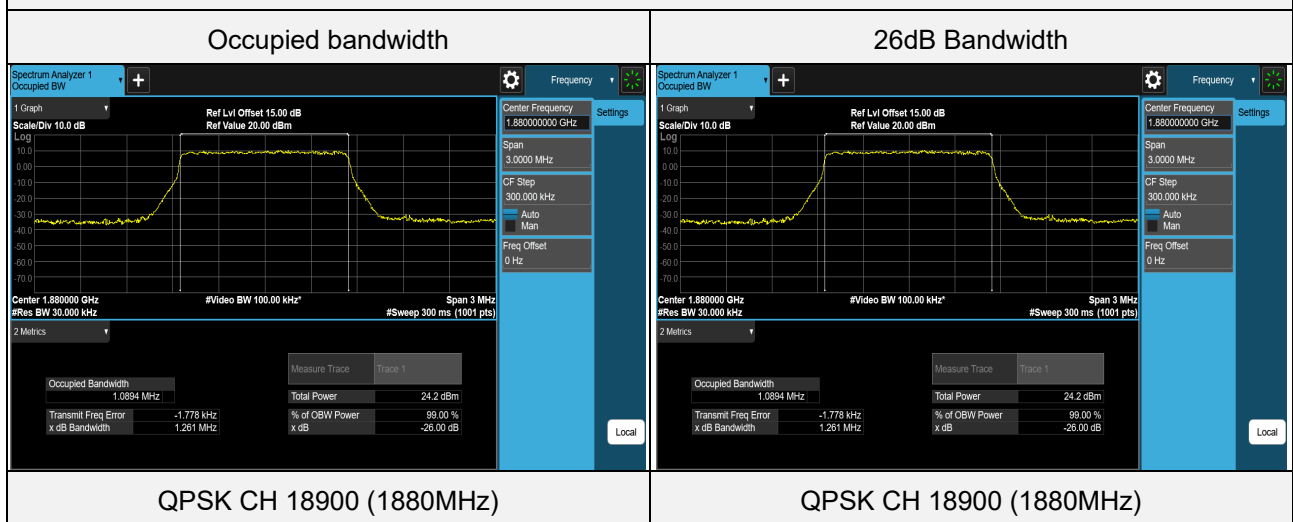

LTE Band 2 (Channel Bandwidth 3MHz)

Test Condition	Channel	Frequency (MHz)	Occupied bandwidth (MHz)	26dB Bandwidth (MHz)
QPSK	18615	1851.5	2.6936	2.866
QPSK	18900	1880	2.6928	2.862
QPSK	19185	1908.5	2.6920	2.872
16QAM	18615	1851.5	2.6908	2.881
16QAM	18900	1880	2.6898	2.869
16QAM	19185	1908.5	2.6908	2.867
64QAM	18615	1851.5	2.6900	2.858
64QAM	18900	1880	2.6914	2.856
64QAM	19185	1908.5	2.6940	2.860

Spectrum Plot of Worst Value

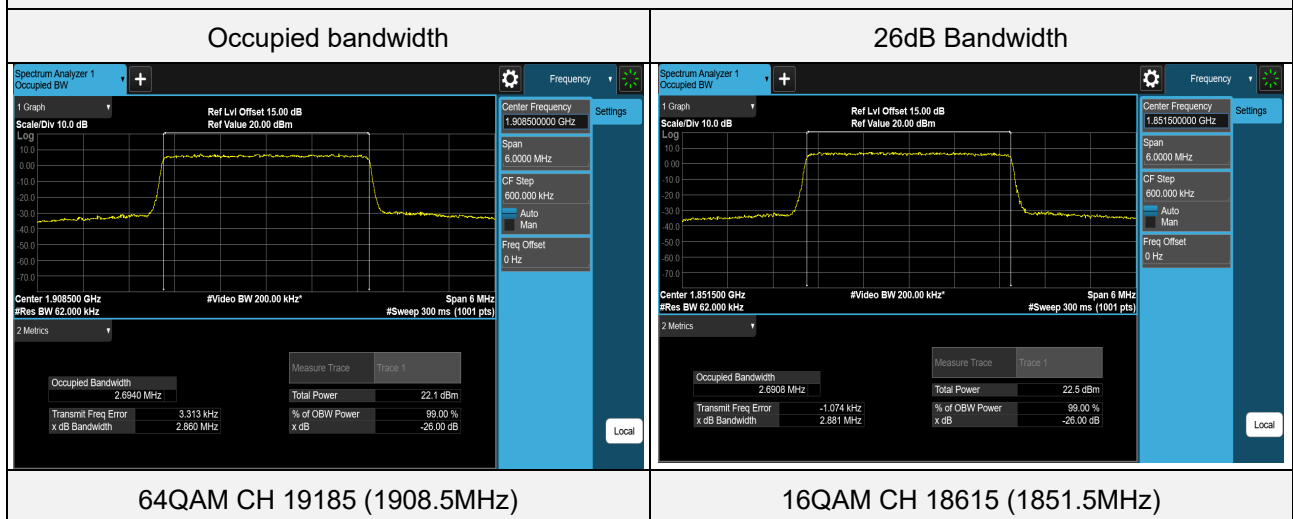

LTE Band 2 (Channel Bandwidth 5MHz)

Test Condition	Channel	Frequency (MHz)	Occupied bandwidth (MHz)	26dB Bandwidth (MHz)
QPSK	18625	1852.5	4.4949	4.781
QPSK	18900	1880	4.4929	4.775
QPSK	19175	1907.5	4.4969	4.776
16QAM	18625	1852.5	4.4899	4.769
16QAM	18900	1880	4.4891	4.764
16QAM	19175	1907.5	4.4910	4.778
64QAM	18625	1852.5	4.4964	4.783
64QAM	18900	1880	4.4988	4.776
64QAM	19175	1907.5	4.4962	4.783

Spectrum Plot of Worst Value

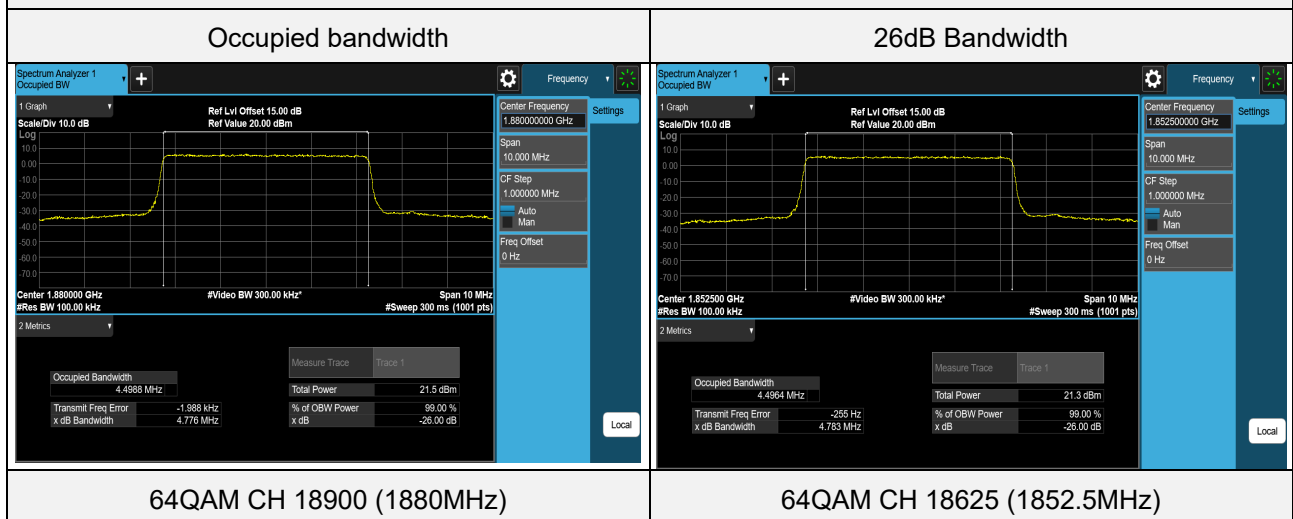

LTE Band 2 (Channel Bandwidth 10MHz)

Test Condition	Channel	Frequency (MHz)	Occupied bandwidth (MHz)	26dB Bandwidth (MHz)
QPSK	18650	1855	8.9824	9.500
QPSK	18900	1880	8.9819	9.493
QPSK	19150	1905	8.9907	9.497
16QAM	18650	1855	8.9841	9.506
16QAM	18900	1880	8.9780	9.491
16QAM	19150	1905	8.9873	9.492
64QAM	18650	1855	8.9841	9.513
64QAM	18900	1880	8.9868	9.503
64QAM	19150	1905	8.9918	9.513

Spectrum Plot of Worst Value

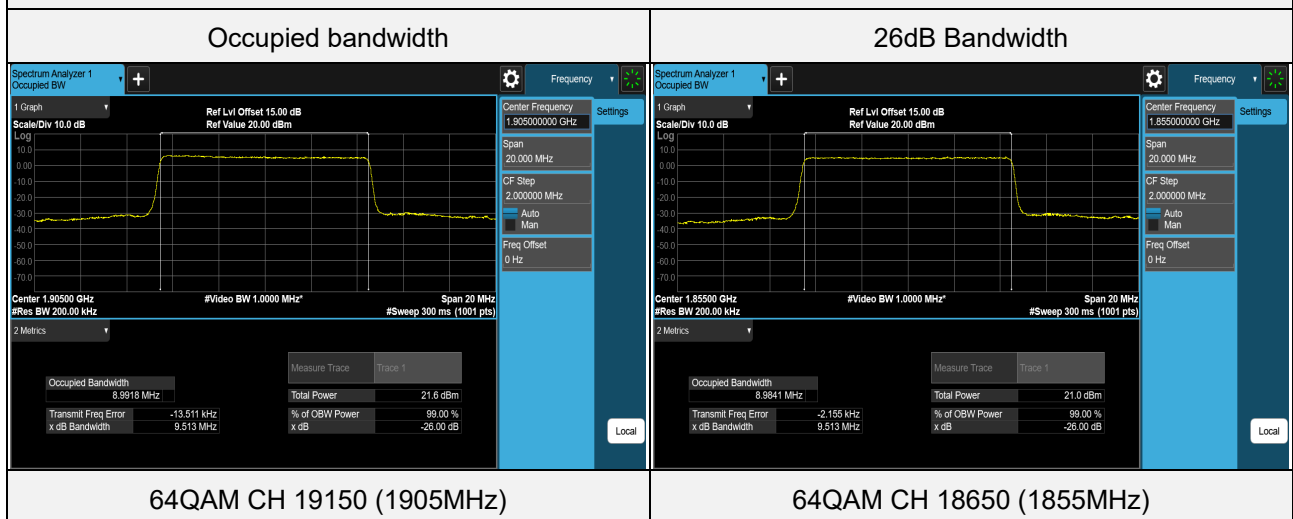

LTE Band 2 (Channel Bandwidth 15MHz)

Test Condition	Channel	Frequency (MHz)	Occupied bandwidth (MHz)	26dB Bandwidth (MHz)
QPSK	18675	1857.5	13.4831	14.230
QPSK	18900	1880	13.4807	14.225
QPSK	19125	1902.5	13.4711	14.205
16QAM	18675	1857.5	13.4748	14.231
16QAM	18900	1880	13.4698	14.228
16QAM	19125	1902.5	13.4559	14.216
64QAM	18675	1857.5	13.4669	14.231
64QAM	18900	1880	13.4676	14.223
64QAM	19125	1902.5	13.4538	14.215

Spectrum Plot of Worst Value

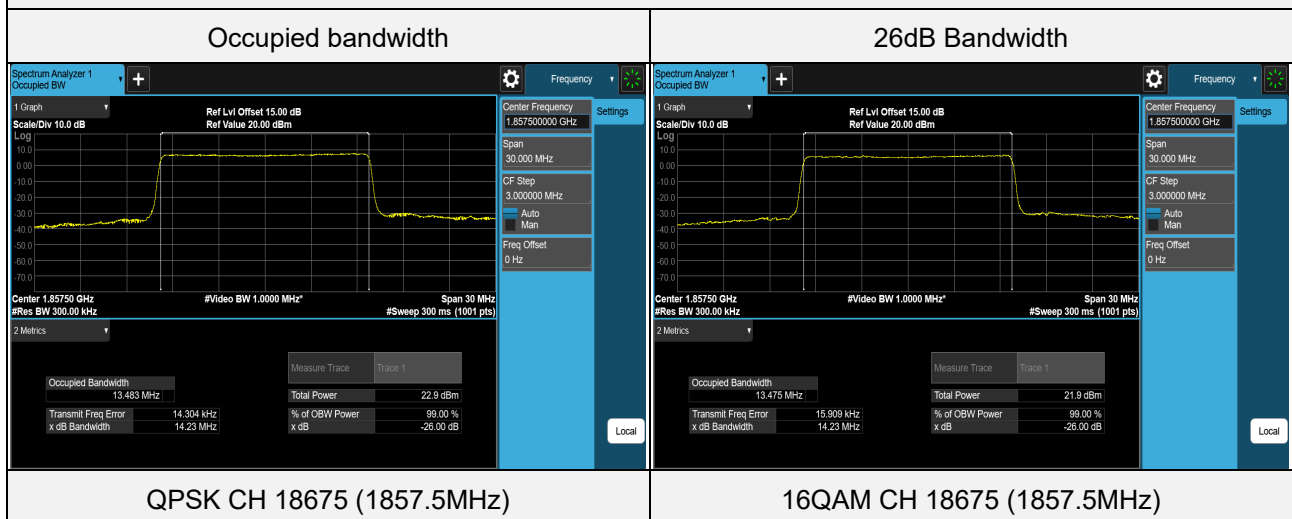

LTE Band 2 (Channel Bandwidth 20MHz)

Test Condition	Channel	Frequency (MHz)	Occupied bandwidth (MHz)	26dB Bandwidth (MHz)
QPSK	18700	1860	17.9642	19.018
QPSK	18900	1880	17.9745	19.015
QPSK	19100	1900	17.9188	18.993
16QAM	18700	1860	17.9737	19.024
16QAM	18900	1880	17.9853	19.033
16QAM	19100	1900	17.9175	18.998
64QAM	18700	1860	17.9749	19.024
64QAM	18900	1880	17.9847	19.023
64QAM	19100	1900	17.9229	19.005

Spectrum Plot of Worst Value

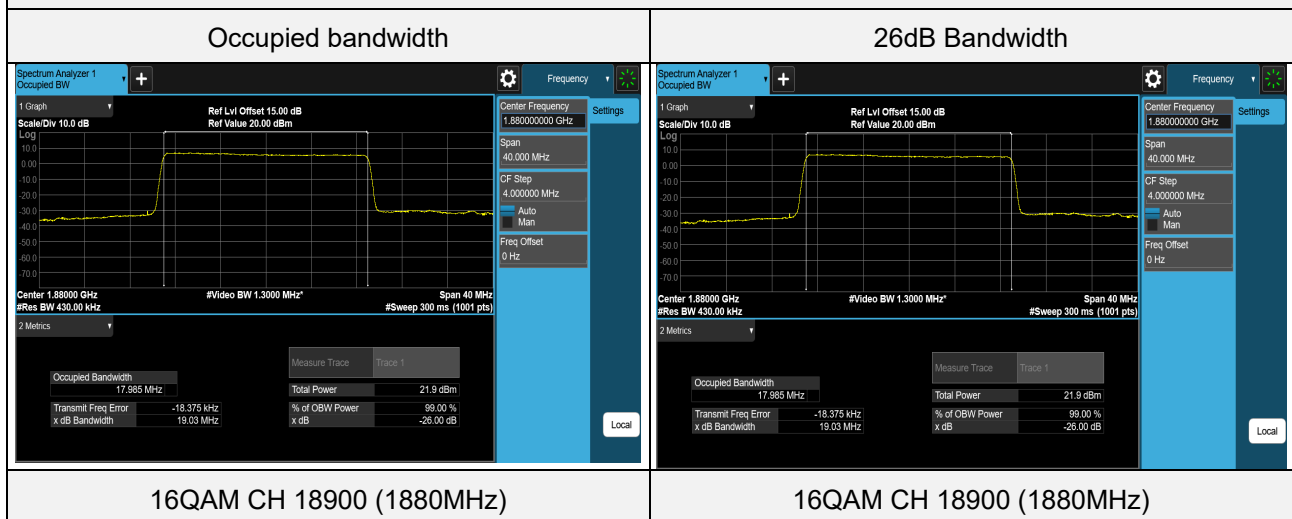

LTE Band 25 (Channel Bandwidth 1.4MHz)

Test Condition	Channel	Frequency (MHz)	Occupied bandwidth (MHz)	26dB Bandwidth (MHz)
QPSK	26047	1850.7	1.0875	1.254
QPSK	26365	1882.5	1.0887	1.254
QPSK	26683	1914.3	1.0897	1.262
16QAM	26047	1850.7	1.0868	1.251
16QAM	26365	1882.5	1.0866	1.251
16QAM	26683	1914.3	1.0871	1.246
64QAM	26047	1850.7	1.0870	1.255
64QAM	26365	1882.5	1.0887	1.255
64QAM	26683	1914.3	1.0875	1.255

Spectrum Plot of Worst Value

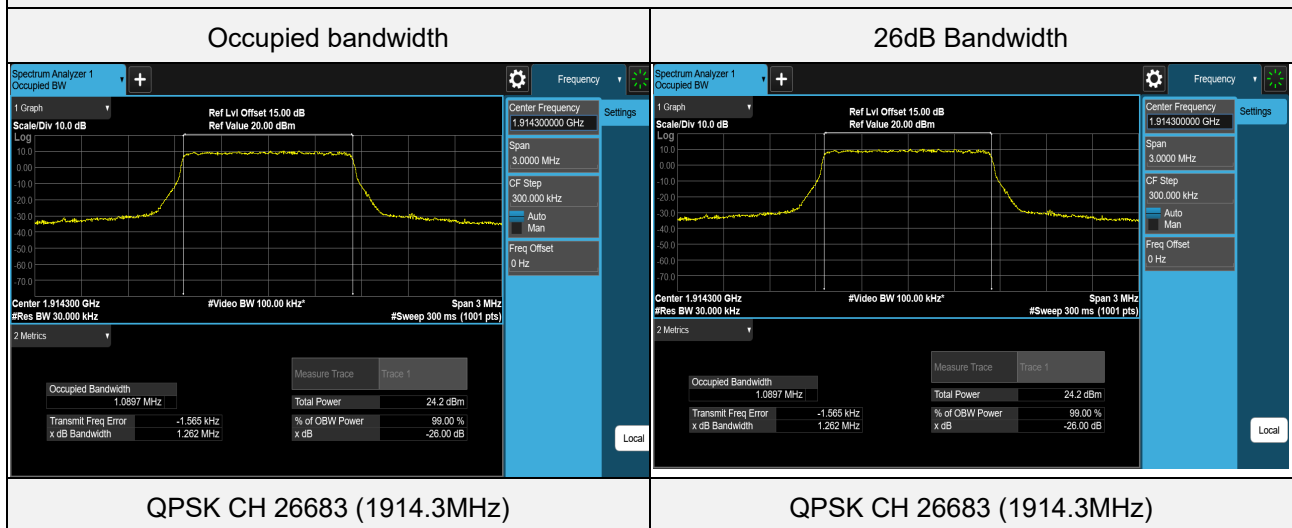

LTE Band 25 (Channel Bandwidth 3MHz)

Test Condition	Channel	Frequency (MHz)	Occupied bandwidth (MHz)	26dB Bandwidth (MHz)
QPSK	26055	1851.5	2.6907	2.864
QPSK	26365	1882.5	2.6900	2.862
QPSK	26675	1913.5	2.6872	2.873
16QAM	26055	1851.5	2.6910	2.869
16QAM	26365	1882.5	2.6903	2.869
16QAM	26675	1913.5	2.6893	2.871
64QAM	26055	1851.5	2.6913	2.857
64QAM	26365	1882.5	2.6937	2.859
64QAM	26675	1913.5	2.6909	2.853

Spectrum Plot of Worst Value

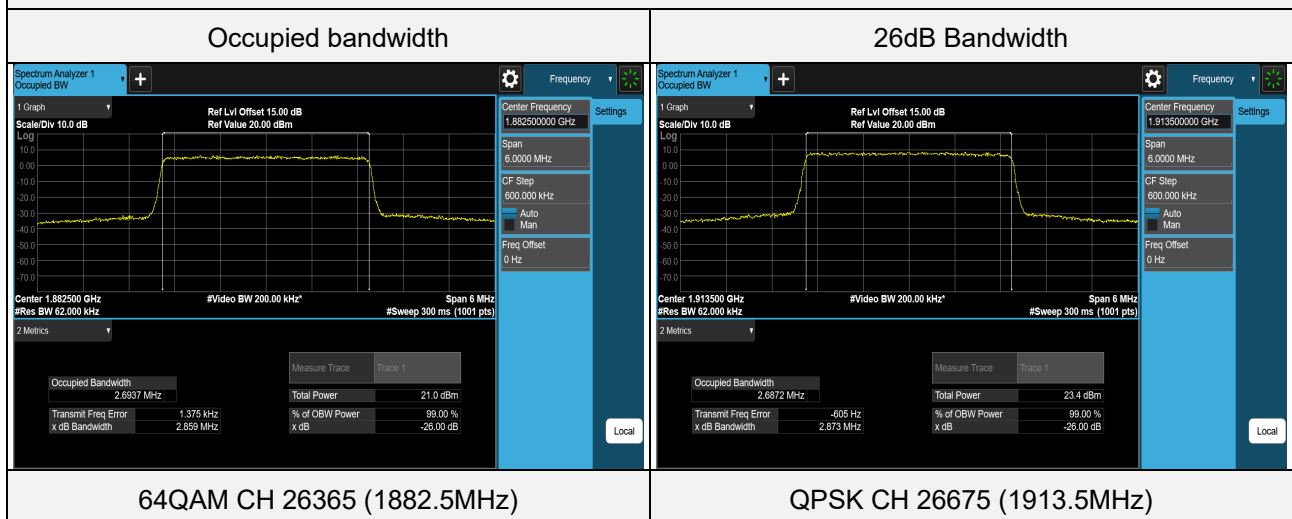

LTE Band 25 (Channel Bandwidth 5MHz)

Test Condition	Channel	Frequency (MHz)	Occupied bandwidth (MHz)	26dB Bandwidth (MHz)
QPSK	26065	1852.5	4.4979	4.880
QPSK	26365	1882.5	4.4998	4.852
QPSK	26665	1912.5	4.4907	4.879
16QAM	26065	1852.5	4.4936	4.851
16QAM	26365	1882.5	4.4914	4.867
16QAM	26665	1912.5	4.4918	4.877
64QAM	26065	1852.5	4.5010	4.886
64QAM	26365	1882.5	4.4990	4.869
64QAM	26665	1912.5	4.4937	4.876

Spectrum Plot of Worst Value

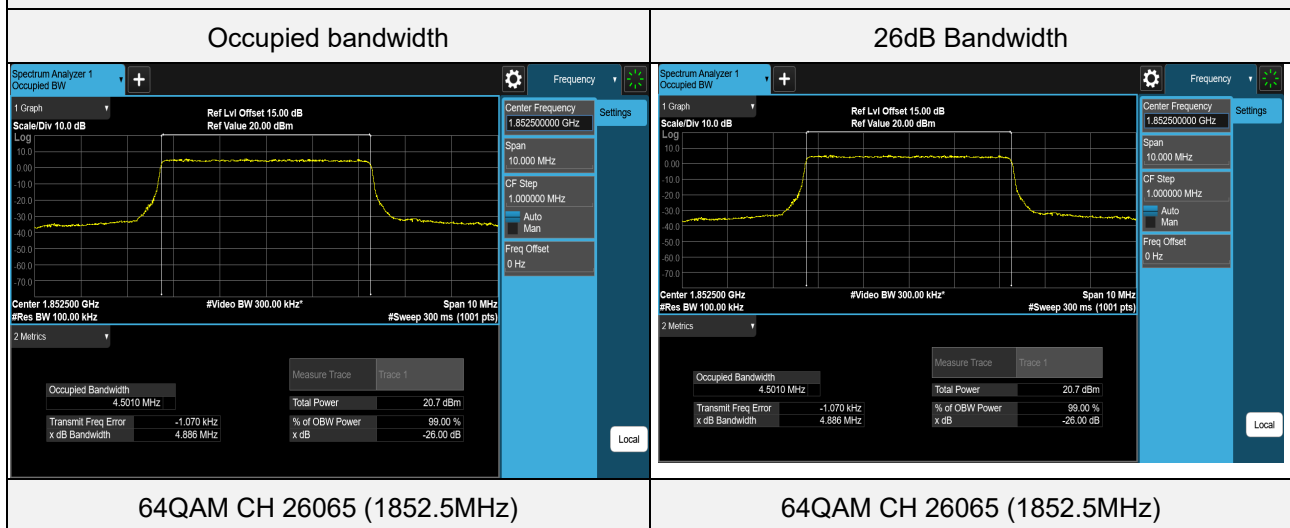

LTE Band 25 (Channel Bandwidth 10MHz)

Test Condition	Channel	Frequency (MHz)	Occupied bandwidth (MHz)	26dB Bandwidth (MHz)
QPSK	26090	1855	8.9877	9.550
QPSK	26365	1882.5	8.9870	9.571
QPSK	26615	1907.5	8.9873	9.542
16QAM	26090	1855	8.9849	9.544
16QAM	26365	1882.5	8.9870	9.530
16QAM	26615	1907.5	8.9815	9.534
64QAM	26090	1855	8.9906	9.570
64QAM	26365	1882.5	8.9863	9.575
64QAM	26615	1907.5	8.9833	9.542

Spectrum Plot of Worst Value

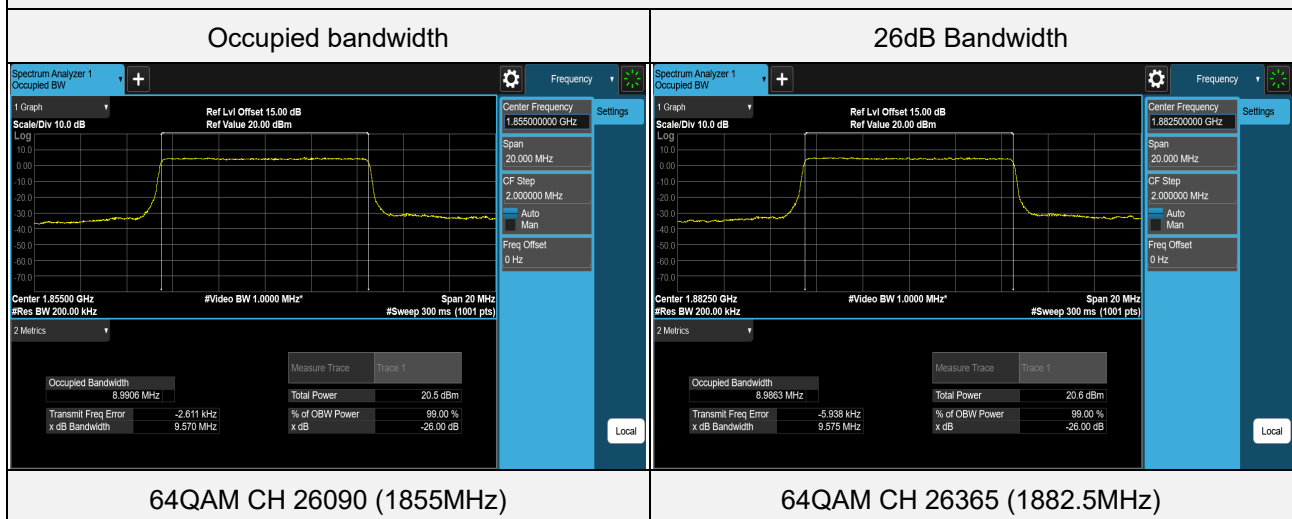

LTE Band 25 (Channel Bandwidth 15MHz)

Test Condition	Channel	Frequency (MHz)	Occupied bandwidth (MHz)	26dB Bandwidth (MHz)
QPSK	26115	1857.5	13.4833	14.254
QPSK	26365	1882.5	13.4806	14.268
QPSK	26615	1907.5	13.5036	14.287
16QAM	26115	1857.5	13.4780	14.275
16QAM	26365	1882.5	13.4840	14.297
16QAM	26615	1907.5	13.4901	14.287
64QAM	26115	1857.5	13.4784	14.284
64QAM	26365	1882.5	13.4766	14.292
64QAM	26615	1907.5	13.4860	14.286

Spectrum Plot of Worst Value

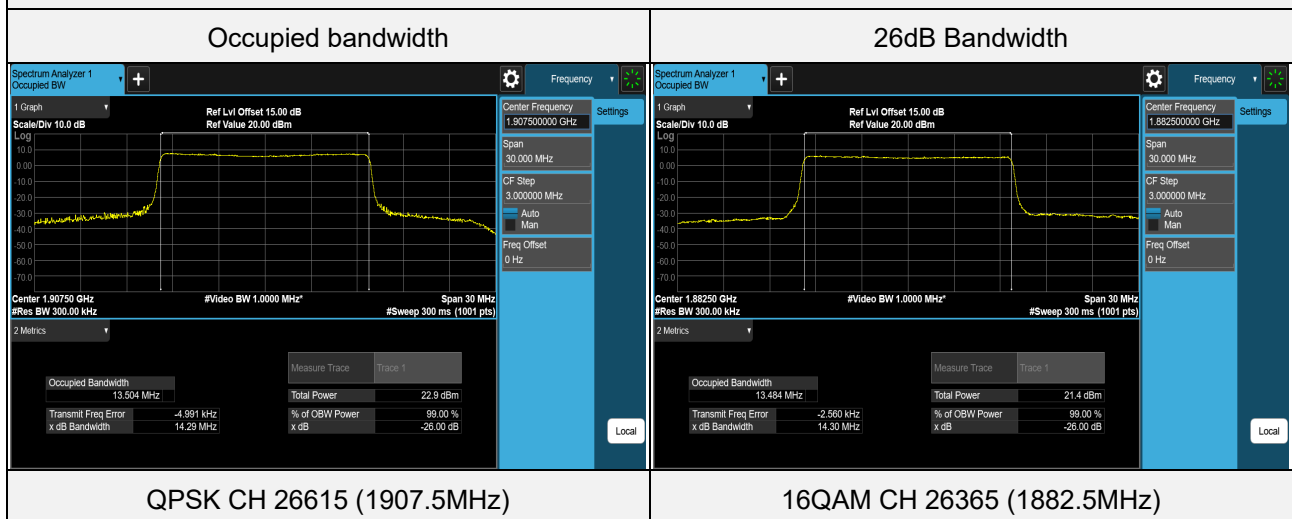

LTE Band 25 (Channel Bandwidth 20MHz)

Test Condition	Channel	Frequency (MHz)	Occupied bandwidth (MHz)	26dB Bandwidth (MHz)
QPSK	26140	1860	17.9787	19.045
QPSK	26365	1882.5	17.9900	19.033
QPSK	26590	1905	17.9868	19.028
16QAM	26140	1860	17.9835	19.040
16QAM	26365	1882.5	18.0090	19.062
16QAM	26590	1905	17.9936	19.035
64QAM	26140	1860	17.9829	19.055
64QAM	26365	1882.5	18.0029	19.055
64QAM	26590	1905	17.9946	19.035

Spectrum Plot of Worst Value

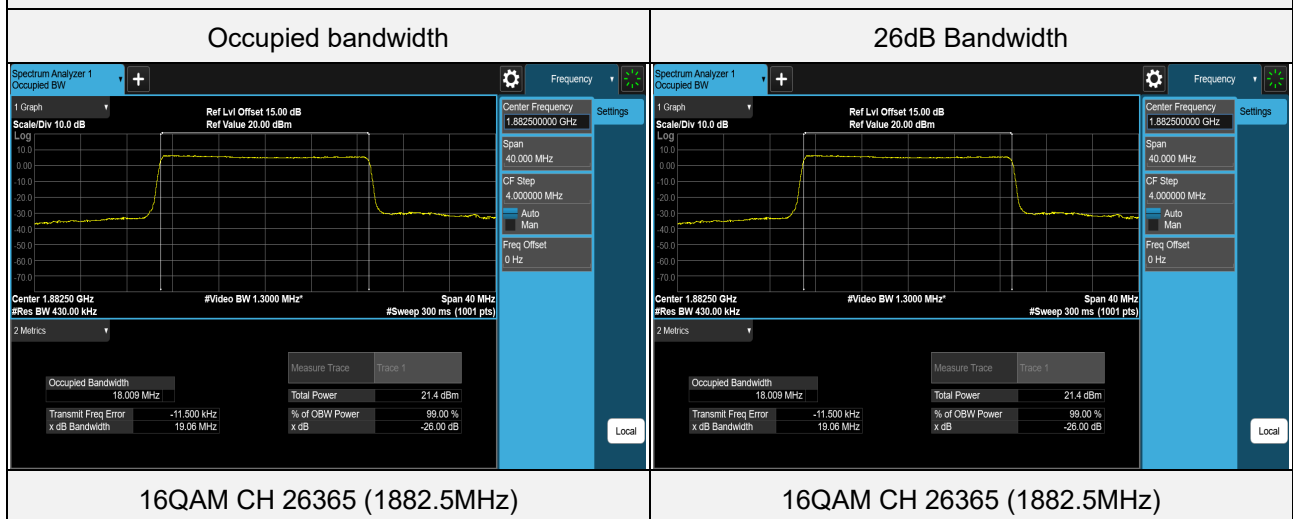

4.5 Band Edge Measurement

4.5.1 Limits of Band Edge Measurement

Power of any emission outside of the authorized operating frequency ranges must be attenuated below the transmitting power (P) by a factor of at least $43 + 10 \log(P)$ dB. In the 1 MHz bands immediately outside and adjacent to the frequency block a resolution bandwidth of at least one percent of the emission bandwidth of the fundamental emission of the transmitter may be employed.

4.5.2 Test Setup

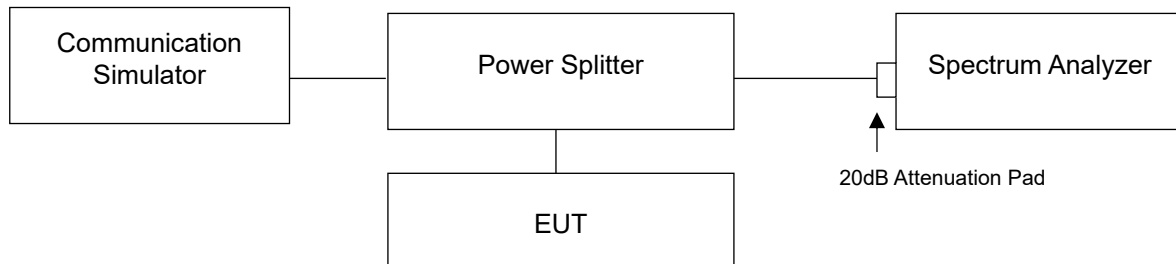

4.5.3 Test Procedures

- a. All measurements were done at low and high operational frequency range.
- b. The center frequency of spectrum is the band edge frequency and span is 2MHz. RB of the spectrum is 10kHz and VB of the spectrum is 30kHz (GPRS / EDGE).
- c. The center frequency of spectrum is the band edge frequency and span is 2MHz. RB of the spectrum is 51kHz and VB of the spectrum is 160kHz (WCDMA / HSDPA / HSUPA).
- d. The center frequency of spectrum is the band edge frequency and span is 1MHz. RB of the spectrum is 15kHz and VB of the spectrum is 51kHz (LTE Channel Bandwidth 1.4MHz).
- e. The center frequency of spectrum is the band edge frequency and span is 1MHz. RB of the spectrum is 30kHz and VB of the spectrum is 100kHz (LTE Channel Bandwidth 3MHz).
- f. The center frequency of spectrum is the band edge frequency and span is 1MHz. RB of the spectrum is 51kHz and VB of the spectrum is 160kHz (LTE Channel Bandwidth 5MHz).
- g. The center frequency of spectrum is the band edge frequency and span is 1MHz. RB of the spectrum is 100kHz and VB of the spectrum is 300kHz (LTE Channel Bandwidth 10MHz).
- h. The center frequency of spectrum is the band edge frequency and span is 1MHz. RB of the spectrum is 150kHz and VB of the spectrum is 470kHz (LTE Channel Bandwidth 15MHz).
- i. The center frequency of spectrum is the band edge frequency and span is 1MHz. RB of the spectrum is 200kHz and VB of the spectrum is 1MHz (LTE Channel Bandwidth 20MHz).
- j. Record the max trace plot into the test report.

4.5.4 Test Results

GPRS

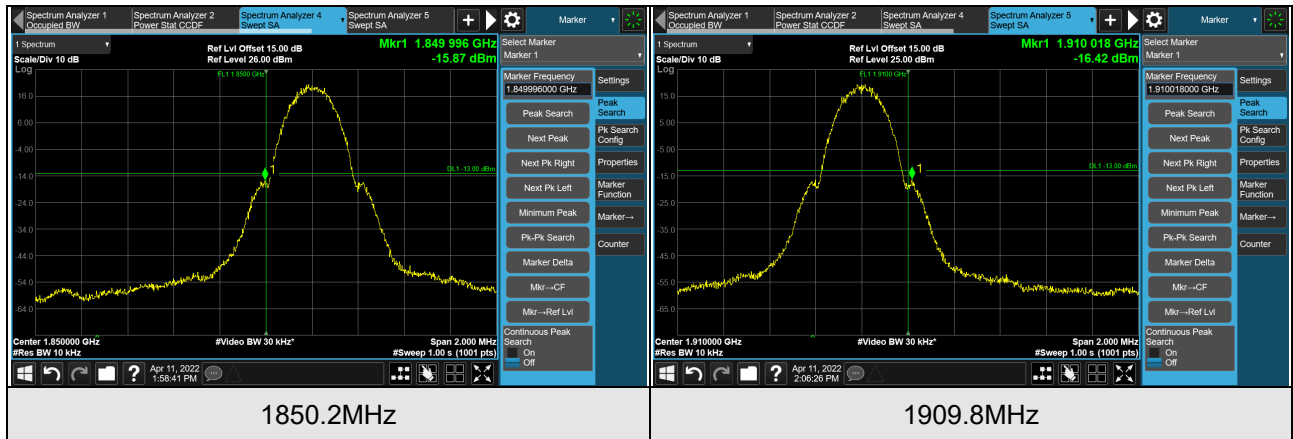

EDGE

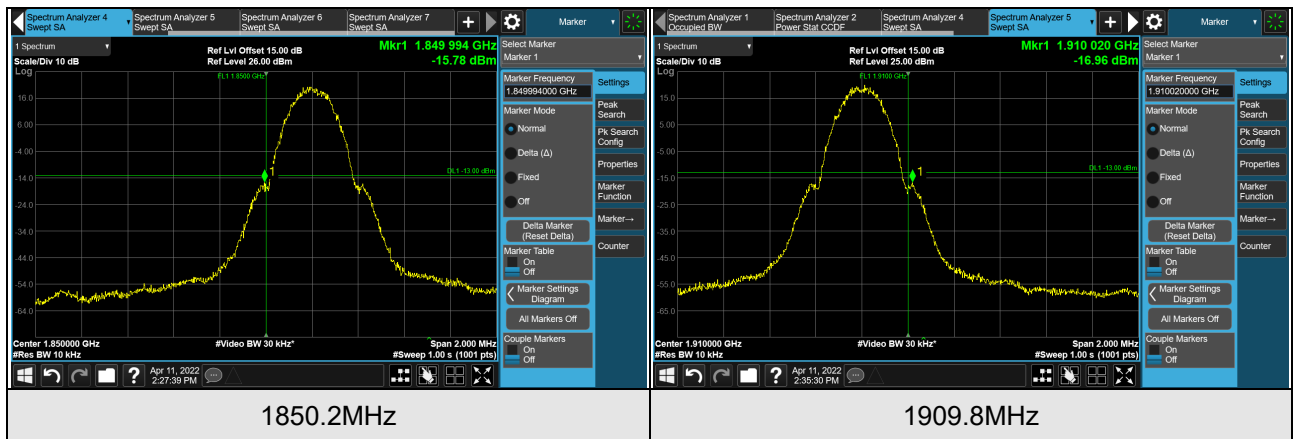

WCDMA Band 2



HSDPA

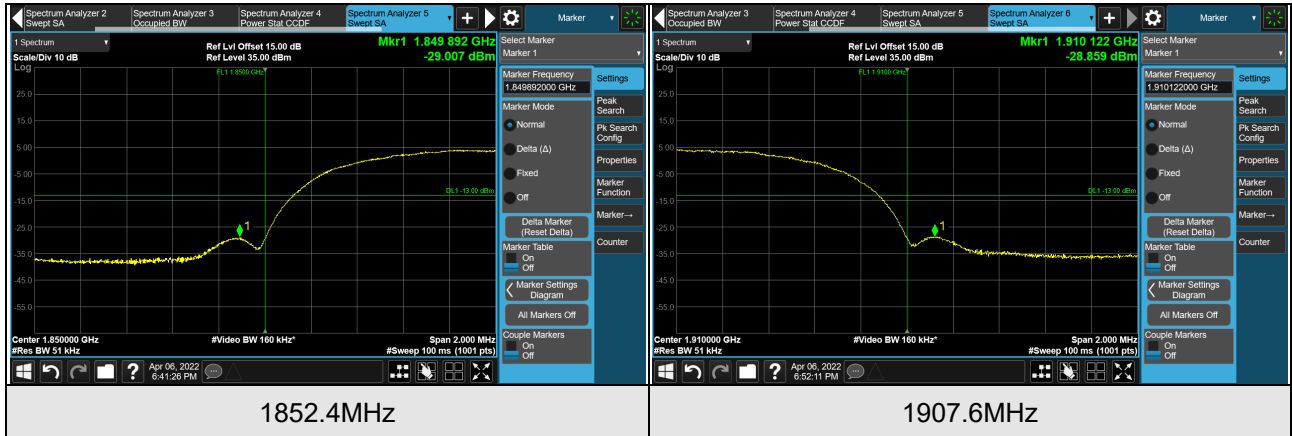

HSUPA

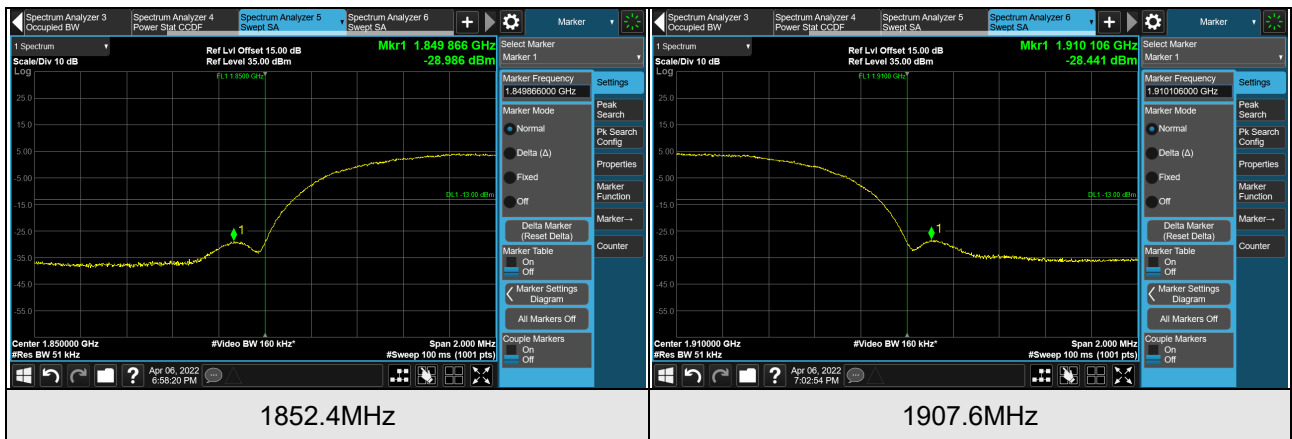

LTE Band 2 (Channel Bandwidth 1.4MHz)

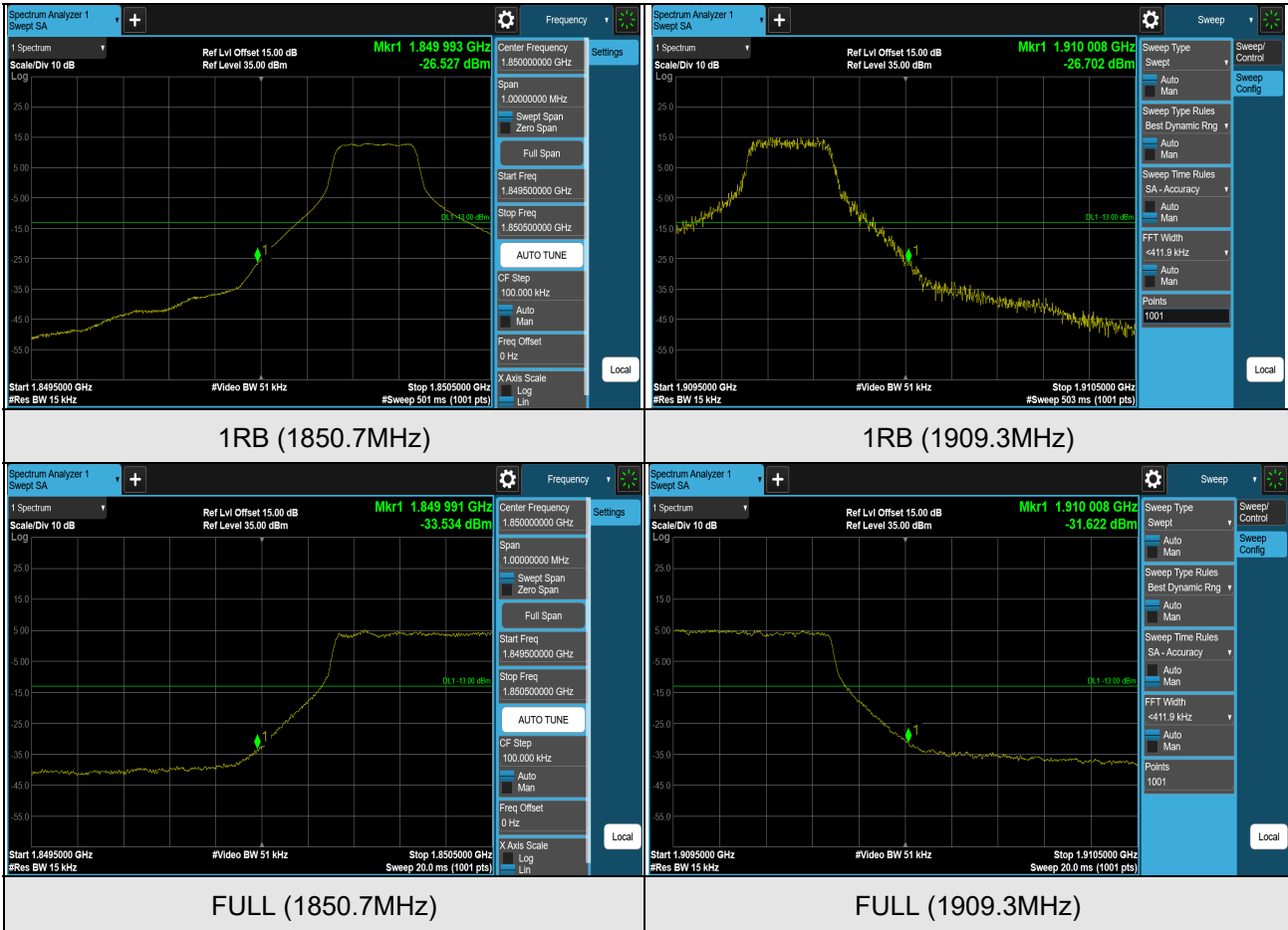

LTE Band 2 (Channel Bandwidth 3MHz)

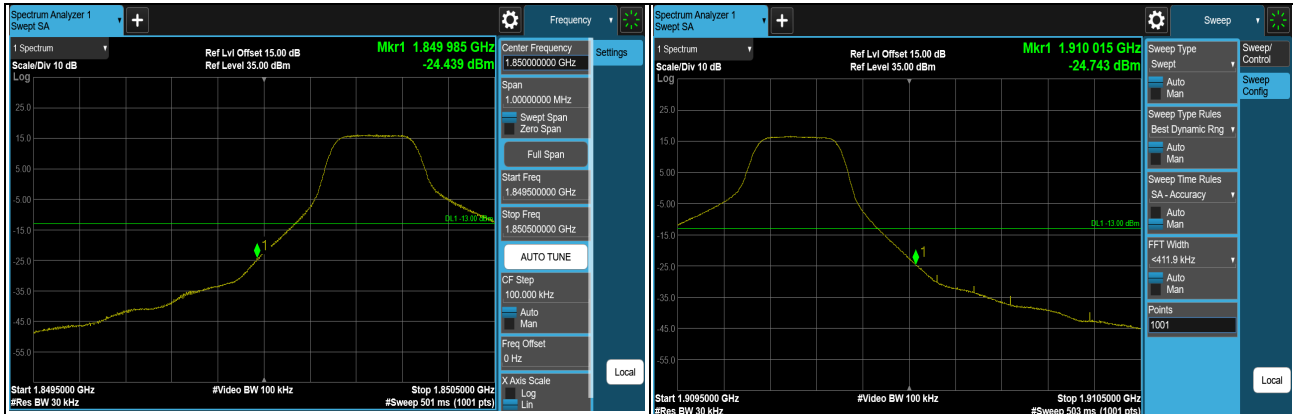

1RB (1851.5MHz)

1RB (1908.5MHz)

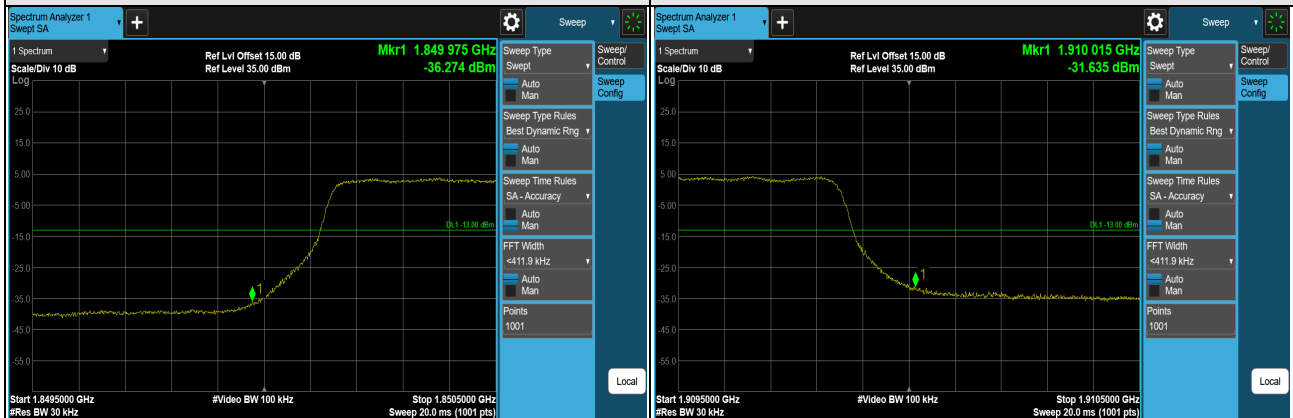

FULL (1851.5MHz)

FULL (1908.5MHz)

LTE Band 2 (Channel Bandwidth 5MHz)

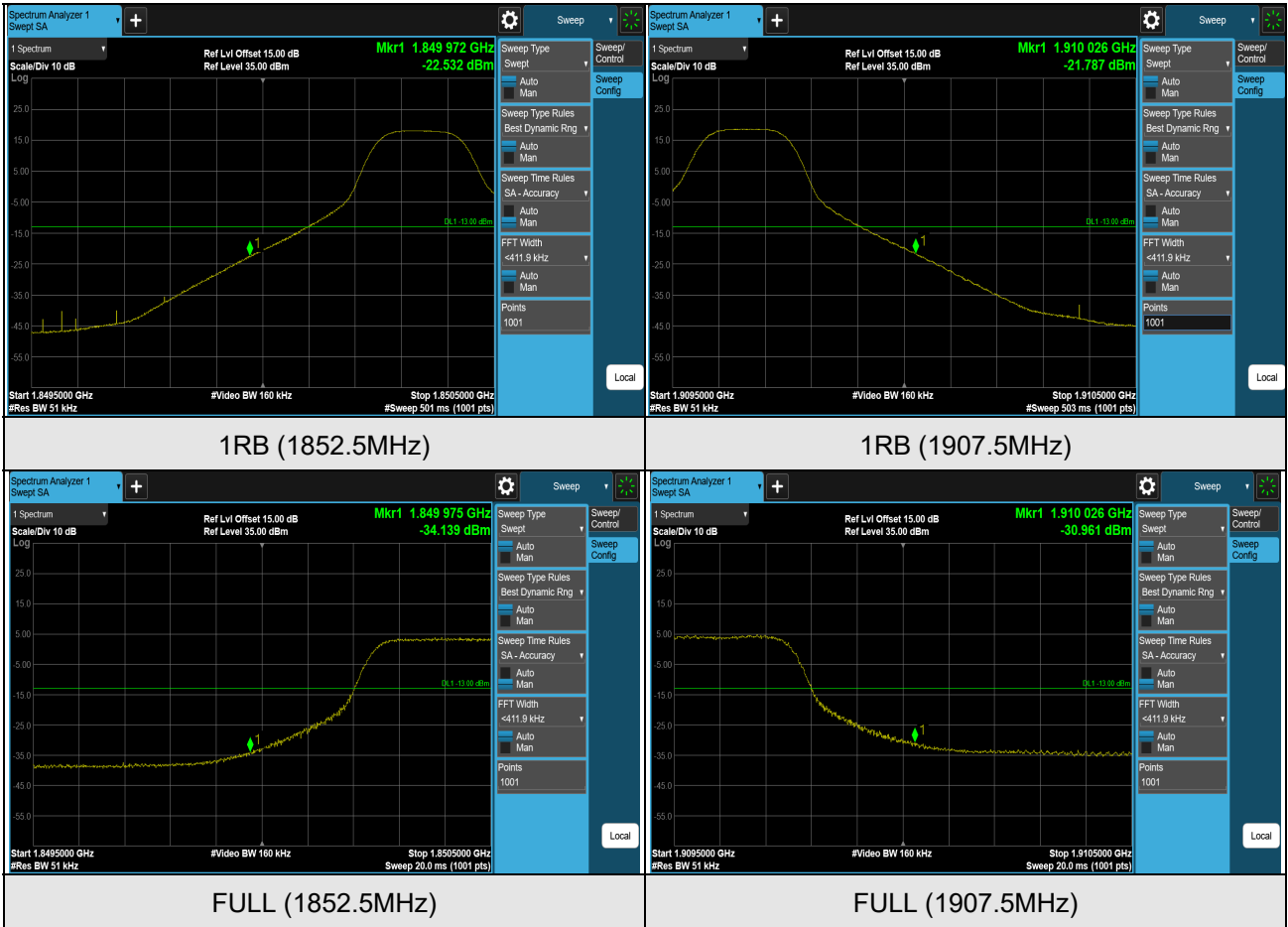

LTE Band 2 (Channel Bandwidth 10MHz)

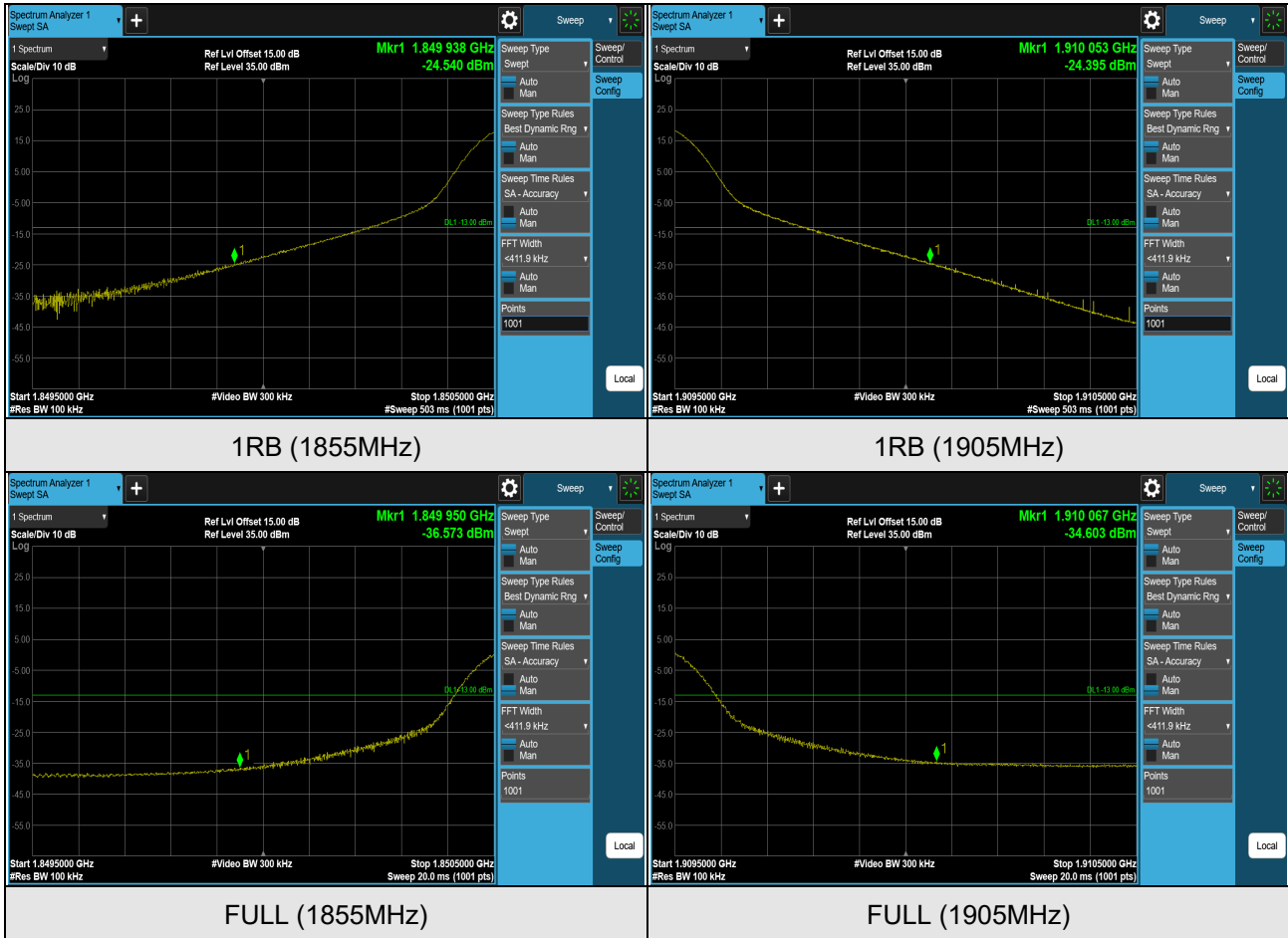

LTE Band 2 (Channel Bandwidth 15MHz)

