

FCC Test Report (Part 22 – GPRS, EDGE, LTE B5/B26)

Report No.: RFBHKI-WTW-P21120244

FCC ID: NKRUMC-MT2731CBN

Test Model: UMC-MT2731CBN

Received Date: Nov. 01, 2021

Test Date: Jan. 17 ~ Feb. 24, 2022

Issued Date: Jun. 09, 2022

Applicant: Wistron NeWeb Corporation

Address: 20 Park Ave. II, Hsinchu Science Park, Hsinchu 308, Taiwan

Issued By: Bureau Veritas Consumer Products Services (H.K.) Ltd., Taoyuan Branch
Lin Kou Laboratories

Lab Address: No. 47-2, 14th Ling, Chia Pau Vil., Lin Kou Dist., New Taipei City, Taiwan

Test Location: No. 19, Hwa Ya 2nd Rd., Wen Hwa Vil., Kwei Shan Dist., Taoyuan City
33383, TAIWAN

**FCC Registration /
Designation Number:** 788550 / TW0003



This report is for your exclusive use. Any copying or replication of this report to or for any other person or entity, or use of our name or trademark, is permitted only with our prior written permission. This report sets forth our findings solely with respect to the test samples identified herein. The results set forth in this report are not indicative or representative of the quality or characteristics of the lot from which a test sample was taken or any similar or identical product specifically and expressly noted. Our report includes all of the tests requested by you and the results thereof based upon the information that you provided to us. You have 60 days from date of issuance of this report to notify us of any material error or omission caused by our negligence, provided, however, that such notice shall be in writing and shall specifically address the issue you wish to raise. A failure to raise such issue within the prescribed time shall constitute your unqualified acceptance of the completeness of this report, the tests conducted and the correctness of the report contents. Unless specific mention, the uncertainty of measurement has been explicitly taken into account to declare the compliance or non-compliance to the specification.

Table of Contents

Release Control Record	4
1 Certificate of Conformity	5
2 Summary of Test Results	6
2.1 Measurement Uncertainty.....	6
2.2 Test Site and Instruments.....	7
3 General Information	8
3.1 General Description of EUT.....	8
3.2 Configuration of System under Test.....	10
3.2.1 Description of Support Units.....	10
3.3 Test Mode Applicability and Tested Channel Detail.....	11
3.4 EUT Operating Conditions.....	17
3.5 General Description of Applied Standards and References.....	17
4 Test Types and Results	18
4.1 Output Power Measurement.....	18
4.1.1 Limits of Output Power Measurement.....	18
4.1.2 Test Procedures.....	18
4.1.3 Test Setup.....	18
4.1.4 Test Results.....	19
4.2 Modulation Characteristics Measurement.....	39
4.2.1 Limits of Modulation Characteristics.....	39
4.2.2 Test Procedure.....	39
4.2.3 Test Setup.....	39
4.2.4 Test Results.....	40
4.3 Frequency Stability Measurement.....	43
4.3.1 Limits of Frequency Stability Measurement.....	43
4.3.2 Test Procedure.....	43
4.3.3 Test Setup.....	43
4.3.4 Test Results.....	44
4.4 Occupied Bandwidth Measurement.....	55
4.4.1 Test Procedure.....	55
4.4.2 Test Setup.....	55
4.4.3 Test Result.....	56
4.5 Band Edge Measurement.....	66
4.5.1 Limits of Band Edge Measurement.....	66
4.5.2 Test Setup.....	66
4.5.3 Test Procedures.....	66
4.5.4 Test Results.....	67
4.6 Peak to Average Ratio.....	77
4.6.1 Limits of Peak to Average Ratio Measurement.....	77
4.6.2 Test Setup.....	77
4.6.3 Test Procedures.....	77
4.6.4 Test Results.....	78
4.7 Conducted Spurious Emissions.....	88
4.7.1 Limits of Conducted Spurious Emissions Measurement.....	88
4.7.2 Test Setup.....	88
4.7.3 Test Procedure.....	88
4.7.4 Test Results.....	89
4.8 Radiated Emission Measurement.....	100
4.8.1 Limits of Radiated Emission Measurement.....	100
4.8.2 Test Procedure.....	100
4.8.3 Deviation from Test Standard.....	100
4.8.4 Test Setup.....	101
4.8.5 Test Results.....	102

5	Pictures of Test Arrangements.....	122
	Appendix – Information of the Testing Laboratories	123

Release Control Record

Issue No.	Description	Date Issued
RFBHKI-WTW-P21120244	Original release	Jun. 09, 2022

1 Certificate of Conformity

Product: Cellular module

Brand: WNC

Test Model: UMC-MT2731CBN

Sample Status: Engineering sample

Applicant: Wistron NeWeb Corporation

Test Date: Jan. 17 ~ Feb. 24, 2022

Standards: FCC Part 22, Subpart H

The above equipment has been tested by **Bureau Veritas Consumer Products Services (H.K.) Ltd., Taoyuan Branch**, and found compliance with the requirement of the above standards. The test record, data evaluation & Equipment Under Test (EUT) configurations represented herein are true and accurate accounts of the measurements of the sample's RF characteristics under the conditions specified in this report.

Prepared by : Celine Chou , **Date:** Jun. 09, 2022
Celine Chou / Senior Specialist

Approved by : Jeremy Lin , **Date:** Jun. 09, 2022
Jeremy Lin / Project Engineer

2 Summary of Test Results

Applied Standard: FCC Part 22 & Part 2			
FCC Clause	Test Item	Result	Remarks
2.1046 22.913 (a)	Effective radiated power	Pass	Meet the requirement of limit.
2.1047	Modulation Characteristics	Pass	Meet the requirement
22.913 (d)	Peak To Average Ratio	Pass	Meet the requirement of limit.
2.1055 22.355	Frequency Stability	Pass	Meet the requirement of limit.
2.1049	Occupied Bandwidth	Pass	Meet the requirement of limit.
22.917	Band Edge Measurements	Pass	Meet the requirement of limit.
2.1051 22.917	Conducted Spurious Emissions	Pass	Meet the requirement of limit.
2.1053 22.917	Radiated Spurious Emissions	Pass	Meet the requirement of limit. Minimum passing margin is -25.55dB at 1648.40MHz.

Note: Determining compliance based on the results of the compliance measurement, not taking into account measurement instrumentation uncertainty.

2.1 Measurement Uncertainty

Where relevant, the following measurement uncertainty levels have been estimated for tests performed on the EUT as specified in CISPR 16-4-2:

Measurement	Frequency	Expanded Uncertainty (k=2) (\pm)
Radiated Emissions up to 1 GHz	9kHz ~ 30MHz	3.04 dB
	30MHz ~ 200MHz	2.93 dB
	200MHz ~ 1000MHz	2.95 dB
Radiated Emissions above 1 GHz	1GHz ~ 18GHz	2.26 dB
	18GHz ~ 40GHz	1.94 dB

2.2 Test Site and Instruments

Description & Manufacturer	Model No.	Serial No.	Cal. Date	Cal. Due
Spectrum Analyzer Agilent	N9010A	MY52220314	Dec. 03, 2021	Dec. 02, 2022
Spectrum Analyzer ROHDE & SCHWARZ	FSU43	101261	Apr. 12, 2021	Apr. 11, 2022
Broadband Horn Antenna SCHWARZBECK	BBHA 9170	148	Nov. 14, 2021	Nov. 13, 2022
HORN Antenna SCHWARZBECK	BBHA 9120D	9120D-969	Nov. 14, 2021	Nov. 13, 2022
BILOG Antenna SCHWARZBECK	VULB 9168	9168-472	Oct. 28, 2021	Oct. 27, 2022
Fixed Attenuator WOKEN	MDCS18N-10	MDCS18N-10-01	Apr. 13, 2021	Apr. 12, 2022
Loop Antenna TESEQ	HLA 6121	45745	Jul. 21, 2021	Jul. 20, 2022
Preamplifier EMCI	EMC001340	980201	Sep. 15, 2021	Sep. 14, 2022
Preamplifier EMCI	EMC 012645	980115	Oct. 05, 2021	Oct. 04, 2022
Preamplifier EMCI	EMC 184045	980116	Oct. 05, 2021	Oct. 04, 2022
Preamplifier EMCI	EMC 330H	980112	Oct. 05, 2021	Oct. 04, 2022
RF Coaxial Cable EMCI	EMC104-SM-SM-800 0	171005	Oct. 05, 2021	Oct. 04, 2022
RF Coaxial Cable HUBER+SUHNNER	SUCOFLEX 104	EMC104-SM-SM-1000 (140807)	Oct. 05, 2021	Oct. 04, 2022
RF Coaxial Cable WOKEN	8D-FB	Cable-Ch10-01	Oct. 05, 2021	Oct. 04, 2022
Software BV ADT	E3 6.120103	NA	NA	NA
Antenna Tower MF	MFA-440H	NA	NA	NA
Turn Table MF	MFT-201SS	NA	NA	NA
Antenna Tower & Turn Table Controller MF	MF-7802	NA	NA	NA
Temperature & Humidity Chamber TERCHY	HRM-120RF	931022	Jan. 03, 2022	Jan. 02, 2023
True RMS Clamp Meter Fluke	325	31130711WS	Jun. 02, 2021	Jun. 01, 2022
DC power supply Keysight	U8002A	MY56330015	NA	NA
Radio Communication Analyzer Anritsu	MT8821C	6272278310	Jun. 23, 2021	Jun. 22, 2022
Universal Radio Communication Tester R&S	CMU200	101095	Nov. 18, 2021	Nov. 17, 2022

Note: 1. The calibration interval of the above test instruments is 12 months and the calibrations are traceable to NML/ROC and NIST/USA.
2. The test was performed in HwaYa Chamber 10.

3 General Information

3.1 General Description of EUT

Product	Cellular module			
Brand	WNC			
Test Model	UMC-MT2731CBN			
Sample Status	Engineering sample			
Power Supply Rating	4.0Vdc			
Modulation Type	GPRS: GMSK EDGE: 8PSK LTE: QPSK, 16QAM, 64QAM			
Operating Frequency	GPRS, EDGE	824.2MHz ~ 848.8MHz		
	LTE Band 5 (Channel Bandwidth 1.4MHz)	824.7MHz ~ 848.3MHz		
	LTE Band 5 (Channel Bandwidth 3MHz)	825.5MHz ~ 847.5MHz		
	LTE Band 5 (Channel Bandwidth 5MHz)	826.5MHz ~ 846.5MHz		
	LTE Band 5 (Channel Bandwidth 10MHz)	829.0MHz ~ 844.0MHz		
	LTE Band 26 (Channel Bandwidth 1.4MHz)	824.7MHz ~ 848.3MHz		
	LTE Band 26 (Channel Bandwidth 3MHz)	825.5MHz ~ 847.5MHz		
	LTE Band 26 (Channel Bandwidth 5MHz)	826.5MHz ~ 846.5MHz		
	LTE Band 26 (Channel Bandwidth 10MHz)	829.0MHz ~ 844.0MHz		
	LTE Band 26 (Channel Bandwidth 15MHz)	831.5MHz ~ 841.5MHz		
Max. ERP Power	GPRS	1161.449mW (30.65dBm)		
	EDGE	912.011mW (29.60dBm)		
		QPSK	16QAM	64QAM
	LTE Band 5 (Channel Bandwidth 1.4MHz)	199.986mW (23.01dBm)	164.437mW (22.16dBm)	131.826mW (21.20dBm)
	LTE Band 5 (Channel Bandwidth 3MHz)	200.447mW (23.02dBm)	165.577mW (22.19dBm)	135.831mW (21.33dBm)
	LTE Band 5 (Channel Bandwidth 5MHz)	201.372mW (23.04dBm)	179.061mW (22.53dBm)	139.316mW (21.44dBm)
	LTE Band 5 (Channel Bandwidth 10MHz)	204.644mW (23.11dBm)	169.434mW (22.29dBm)	134.276mW (21.28dBm)
	LTE Band 26 (Channel Bandwidth 1.4MHz)	203.704mW (23.09dBm)	171.396mW (22.34dBm)	143.219mW (21.56dBm)
	LTE Band 26 (Channel Bandwidth 3MHz)	206.538mW (23.15dBm)	181.552mW (22.59dBm)	137.088mW (21.37dBm)
	LTE Band 26 (Channel Bandwidth 5MHz)	205.116mW (23.12dBm)	178.649mW (22.52dBm)	139.637mW (21.45dBm)
	LTE Band 26 (Channel Bandwidth 10MHz)	207.970mW (23.18dBm)	184.077mW (22.65dBm)	143.880mW (21.58dBm)
	LTE Band 26 (Channel Bandwidth 15MHz)	209.411mW (23.21dBm)	183.231mW (22.63dBm)	145.546mW (21.63dBm)

Emission Designator	GPRS	247KGXW		
	EDGE	246KG7W		
		QPSK	16QAM	64QAM
	LTE Band 5 (Channel Bandwidth 1.4MHz)	1M09G7D	1M09D7W	1M09D7W
	LTE Band 5 (Channel Bandwidth 3MHz)	2M70G7D	2M69D7W	2M69D7W
	LTE Band 5 (Channel Bandwidth 5MHz)	4M50G7D	4M49D7W	4M50D7W
	LTE Band 5 (Channel Bandwidth 10MHz)	8M99G7D	8M99D7W	8M99D7W
	LTE Band 26 (Channel Bandwidth 1.4MHz)	1M09G7D	1M09D7W	1M09D7W
	LTE Band 26 (Channel Bandwidth 3MHz)	2M69G7D	2M69D7W	2M69D7W
	LTE Band 26 (Channel Bandwidth 5MHz)	4M50G7D	4M49D7W	4M50D7W
	LTE Band 26 (Channel Bandwidth 10MHz)	8M99G7D	8M98D7W	8M99D7W
	LTE Band 26 (Channel Bandwidth 15MHz)	13M5G7D	13M5D7W	13M5D7W
Antenna Type	Refer to note			
Antenna Connector	Refer to note			
Accessory Device	NA			
Cable Supplied	NA			

Note: The antenna information is listed as below. (For support unit only)

Type	Connector	Gain (dBi)											
		GSM 850	GSM 1900	LTE B2	LTE B4	LTE B5	LTE B7	LTE B12	LTE B14	LTE B17	LTE B25	LTE B26	LTE B66
Dipole	SMA	1.82	1.80	1.80	1.57	1.82	2.15	2.02	2.02	2.02	1.80	1.82	1.57

* The above Antenna information is declared by manufacturer and for more detailed features description, please refer to the manufacturer's specifications, the laboratory shall not be held responsible.

3.2 Configuration of System under Test

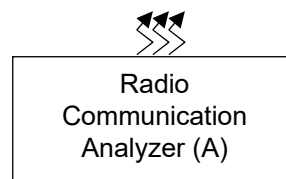
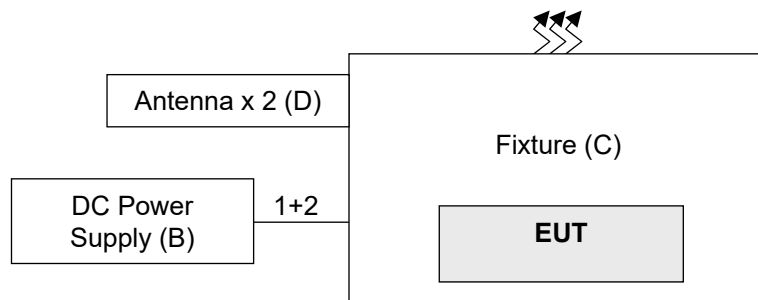

Remote site

3.2.1 Description of Support Units

The EUT has been tested as an independent unit together with other necessary accessories or support units. The following support units or accessories were used to form a representative test configuration during the tests.

ID	Product	Brand	Model No.	Serial No.	FCC ID	Remarks
A.	Radio Communication Analyzer	Anritsu	MT8821C	6261806803	NA	For LTE
		R&S	CMU200	101095	NA	For GPRS, EDGE
B.	DC Power Supply	JIN YIH Technology	SP3051	SP30512050388	NA	-
C.	Fixture	NA	NA	NA	NA	Provided by manufacturer
D.	Antenna x 2	WNC	RF21S00802A	NA	NA	Provided by manufacturer

Note:

1. All power cords of the above support units are non-shielded (1.8m).
2. Item A acted as a communication partner to transfer data.

ID	Descriptions	Qty.	Length (m)	Shielding (Yes/No)	Cores (Qty.)	Remarks
1.	DC Power Cable	1	1.8	N	0	-
2.	DC Cable	1	0.12	N	0	-

3.3 Test Mode Applicability and Tested Channel Detail

Pre-Scan has been conducted to determine the worst-case mode from all possible combinations between available modulations, data rates, XYZ axis and antenna ports. The worst case was found when positioned as the table below. Following channel(s) was (were) selected for the final test as listed below:

Band	Radiated Emission
GPRS, EDGE	Z-plane
LTE Band 5	Z-plane
LTE Band 26	Z-plane

GPRS, EDGE Mode

EUT Configure Mode	Test Item	Available Channel	Tested Channel	Modulation
-	ERP	128 to 251	128 (824.2MHz), 189 (836.4MHz), 251 (848.8MHz)	GPRS, EDGE
-	Modulation Characteristics	128 to 251	128 (824.2MHz)	GPRS, EDGE
-	Frequency Stability	128 to 251	128 (824.2MHz), 251 (848.8MHz)	GPRS, EDGE
-	Occupied Bandwidth	128 to 251	128 (824.2MHz), 189 (836.4MHz), 251 (848.8MHz)	GPRS, EDGE
-	Band Edge	128 to 251	128(824.2MHz), 251(848.8MHz)	GPRS, EDGE
-	Peak To Average Ratio	128 to 251	128 (824.2MHz), 189 (836.4MHz), 251 (848.8MHz)	GPRS, EDGE
-	Conducted Emission	128 to 251	128 (824.2MHz), 189 (836.4MHz), 251 (848.8MHz)	GPRS, EDGE
-	Radiated Emission	128 to 251	128 (824.2MHz), 189 (836.4MHz), 251 (848.8MHz)	GPRS

Note: For radiated emission below 1GHz, select the worst radiated emission channel (above 1GHz) for final testing.

LTE Band 5

EUT Configure Mode	Test item	Available channel	Tested channel	Channel Bandwidth	Modulation	RB #
-	ERP	20407 to 20643	20407 (824.7MHz), 20525 (836.5MHz), 20643 (848.3MHz)	1.4MHz	QPSK / 16QAM / 64QAM	1 Half Full
		20415 to 20635	20415 (825.5MHz), 20525 (836.5MHz), 20635 (847.5MHz)	3MHz	QPSK / 16QAM / 64QAM	1 Half Full
		20425 to 20625	20425 (826.5MHz), 20525 (836.5MHz), 20625 (846.5MHz)	5MHz	QPSK / 16QAM / 64QAM	1 Half Full
		20450 to 20600	20450 (829.0MHz), 20525 (836.5MHz), 20600 (844.0MHz)	10MHz	QPSK / 16QAM / 64QAM	1 Half Full
-	Modulation Characteristics	20450 to 20600	20525 (836.5MHz)	10MHz	QPSK / 16QAM / 64QAM	Full
-	Frequency Stability	20407 to 20643	20407 (824.7MHz), 20643 (848.3MHz)	1.4MHz	QPSK	Full
		20415 to 20635	20415 (825.5MHz), 20635 (847.5MHz)	3MHz	QPSK	Full
		20425 to 20625	20425 (826.5MHz), 20625 (846.5MHz)	5MHz	QPSK	Full
		20450 to 20600	20450 (829.0MHz), 20600 (844.0MHz)	10MHz	QPSK	Full
-	Occupied Bandwidth	20407 to 20643	20407 (824.7MHz), 20525 (836.5MHz), 20643 (848.3MHz)	1.4MHz	QPSK / 16QAM / 64QAM	Full
		20415 to 20635	20415 (825.5MHz), 20525 (836.5MHz), 20635 (847.5MHz)	3MHz	QPSK / 16QAM / 64QAM	Full
		20425 to 20625	20425 (826.5MHz), 20525 (836.5MHz), 20625 (846.5MHz)	5MHz	QPSK / 16QAM / 64QAM	Full
		20450 to 20600	20450 (829.0MHz), 20525 (836.5MHz), 20600 (844.0MHz)	10MHz	QPSK / 16QAM / 64QAM	Full
-	Band Edge	20407 to 20643	20407 (824.7MHz), 20643 (848.3MHz)	1.4MHz	QPSK	1 Half Full
		20415 to 20635	20415 (825.5MHz), 20635 (847.5MHz)	3MHz	QPSK	1 Half Full
		20425 to 20625	20425 (826.5MHz), 20625 (846.5MHz)	5MHz	QPSK	1 Half Full
		20450 to 20600	20450 (829.0MHz), 20600 (844.0MHz)	10MHz	QPSK	1 Half Full

EUT Configure Mode	Test item	Available channel	Tested channel	Channel Bandwidth	Modulation	RB #
-	Peak to Average Ratio	20407 to 20643	20407 (824.7MHz), 20525 (836.5MHz), 20643 (848.3MHz)	1.4MHz	QPSK / 16QAM / 64QAM	1
		20415 to 20635	20415 (825.5MHz), 20525 (836.5MHz), 20635 (847.5MHz)	3MHz	QPSK / 16QAM / 64QAM	1
		20425 to 20625	20425 (826.5MHz), 20525 (836.5MHz), 20625 (846.5MHz)	5MHz	QPSK / 16QAM / 64QAM	1
		20450 to 20600	20450 (829.0MHz), 20525 (836.5MHz), 20600 (844.0MHz)	10MHz	QPSK / 16QAM / 64QAM	1
-	Conducted Emission	20407 to 20643	20407 (824.7MHz), 20525 (836.5MHz), 20643 (848.3MHz)	1.4MHz	QPSK	1
		20415 to 20635	20415 (825.5MHz), 20525 (836.5MHz), 20635 (847.5MHz)	3MHz	QPSK	1
		20425 to 20625	20425 (826.5MHz), 20525 (836.5MHz), 20625 (846.5MHz)	5MHz	QPSK	1
		20450 to 20600	20450 (829.0MHz), 20525 (836.5MHz), 20600 (844.0MHz)	10MHz	QPSK	1
-	Radiated Emission	20407 to 20643	20407 (824.7MHz), 20525 (836.5MHz), 20643 (848.3MHz)	1.4MHz	QPSK	1
		20425 to 20625	20425 (826.5MHz), 20525 (836.5MHz), 20625 (846.5MHz)	5MHz	QPSK	1
		20450 to 20600	20450 (829.0MHz), 20525 (836.5MHz), 20600 (844.0MHz)	10MHz	QPSK	1

Note:

1. For radiated emission below 1GHz, select the worst radiated emission channel (above 1GHz) for final testing.
2. For radiated emission above 1GHz, according to 3GPP 36.521-1 Section 6.6.3.1.4.1, choose the lowest, 5MHz & highest channel bandwidth for final test.
3. The output power for QPSK, 16QAM and 64QAM, measured value of QPSK is higher than 16QAM, and 64QAM mode. Therefore, only Modulation characteristics, occupied bandwidth and Peak to average ratio items had been tested under QPSK, 16QAM and 64QAM modes, the other test items were performed under worse mode according to the maximum output power.

LTE Band 26

EUT Configure Mode	Test item	Available channel	Tested channel	Channel Bandwidth	Modulation	RB #
-	ERP	26797 to 27033	26797 (824.7MHz), 26915 (836.5MHz), 27033 (848.3MHz)	1.4MHz	QPSK / 16QAM / 64QAM	1 Half Full
		26805 to 27025	26805 (825.5MHz), 26915 (836.5MHz), 27025 (847.5MHz)	3MHz	QPSK / 16QAM / 64QAM	1 Half Full
		26815 to 27015	26815 (826.5MHz), 26915 (836.5MHz), 27015 (846.5MHz)	5MHz	QPSK / 16QAM / 64QAM	1 Half Full
		26840 to 26990	26840 (829.0MHz), 26915 (836.5MHz), 26990 (844.0MHz)	10MHz	QPSK / 16QAM / 64QAM	1 Half Full
		26865 to 26965	26865 (831.5MHz), 26915 (836.5MHz), 26965 (841.5MHz)	15MHz	QPSK / 16QAM / 64QAM	1 Half Full
-	Modulation Characteristics	26865 to 26965	26915 (836.5MHz)	15MHz	QPSK / 16QAM / 64QAM	Full
-	Frequency Stability	26797 to 27033	26797 (824.7MHz), 27033 (848.3MHz)	1.4MHz	QPSK	Full
		26805 to 27025	26805 (825.5MHz), 27025 (847.5MHz)	3MHz	QPSK	Full
		26815 to 27015	26815 (826.5MHz), 27015 (846.5MHz)	5MHz	QPSK	Full
		26840 to 26990	26840 (829.0MHz), 26990 (844.0MHz)	10MHz	QPSK	Full
		26865 to 26965	26865 (831.5MHz), 26965 (841.5MHz)	15MHz	QPSK	Full
-	Occupied Bandwidth	26797 to 27033	26797 (824.7MHz), 26915 (836.5MHz), 27033 (848.3MHz)	1.4MHz	QPSK / 16QAM / 64QAM	Full
		26805 to 27025	26805 (825.5MHz), 26915 (836.5MHz), 27025 (847.5MHz)	3MHz	QPSK / 16QAM / 64QAM	Full
		26815 to 27015	26815 (826.5MHz), 26915 (836.5MHz), 27015 (846.5MHz)	5MHz	QPSK / 16QAM / 64QAM	Full
		26840 to 26990	26840 (829.0MHz), 26915 (836.5MHz), 26990 (844.0MHz)	10MHz	QPSK / 16QAM / 64QAM	Full
		26865 to 26965	26865 (831.5MHz), 26915 (836.5MHz), 26965 (841.5MHz)	15MHz	QPSK / 16QAM / 64QAM	Full

EUT Configure Mode	Test item	Available channel	Tested channel	Channel Bandwidth	Modulation	RB #
-	Band Edge	26797 to 27033	26797 (824.7MHz), 27033 (848.3MHz)	1.4MHz	QPSK	1 Half Full
		26805 to 27025	26805 (825.5MHz), 27025 (847.5MHz)	3MHz	QPSK	1 Half Full
		26815 to 27015	26815 (826.5MHz), 27015 (846.5MHz)	5MHz	QPSK	1 Half Full
		26840 to 26990	26840 (829.0MHz), 26990 (844.0MHz)	10MHz	QPSK	1 Half Full
		26865 to 26965	26865 (831.5MHz), 26965 (841.5MHz)	15MHz	QPSK	1 Half Full
-	Peak to Average Ratio	26797 to 27033	26797 (824.7MHz), 26915 (836.5MHz), 27033 (848.3MHz)	1.4MHz	QPSK / 16QAM / 64QAM	1
		26805 to 27025	26805 (825.5MHz), 26915 (836.5MHz), 27025 (847.5MHz)	3MHz	QPSK / 16QAM / 64QAM	1
		26815 to 27015	26815 (826.5MHz), 26915 (836.5MHz), 27015 (846.5MHz)	5MHz	QPSK / 16QAM / 64QAM	1
		26840 to 26990	26840 (829.0MHz), 26915 (836.5MHz), 26990 (844.0MHz)	10MHz	QPSK / 16QAM / 64QAM	1
		26865 to 26965	26865 (831.5MHz), 26915 (836.5MHz), 26965 (841.5MHz)	15MHz	QPSK / 16QAM / 64QAM	1
-	Conducted Emission	26797 to 27033	26797 (824.7MHz), 26915 (836.5MHz), 27033 (848.3MHz)	1.4MHz	QPSK	1
		26805 to 27025	26805 (825.5MHz), 26915 (836.5MHz), 27025 (847.5MHz)	3MHz	QPSK	1
		26815 to 27015	26815 (826.5MHz), 26915 (836.5MHz), 27015 (846.5MHz)	5MHz	QPSK	1
		26840 to 26990	26840 (829.0MHz), 26915 (836.5MHz), 26990 (844.0MHz)	10MHz	QPSK	1
		26865 to 26965	26865 (831.5MHz), 26915 (836.5MHz), 26965 (841.5MHz)	15MHz	QPSK	1

EUT Configure Mode	Test item	Available channel	Tested channel	Channel Bandwidth	Modulation	RB #
-	Radiated Emission	26797 to 27033	26797 (824.7MHz), 26915 (836.5MHz), 27033 (848.3MHz)	1.4MHz	QPSK	1
		26815 to 27015	26815 (826.5MHz), 26915 (836.5MHz), 27015 (846.5MHz)	5MHz	QPSK	1
		26865 to 26965	26865 (831.5MHz), 26915 (836.5MHz), 26965 (841.5MHz)	15MHz	QPSK	1

Note:

1. For radiated emission below 1GHz, select the worst radiated emission channel (above 1GHz) for final testing.
2. For radiated emission above 1GHz, according to 3GPP 36.521-1 Section 6.6.3.1.4.1, choose the lowest, 5MHz & highest channel bandwidth for final test.
3. The output power for QPSK, 16QAM and 64QAM, measured value of QPSK is higher than 16QAM, and 64QAM mode. Therefore, only Modulation characteristics, occupied bandwidth and Peak to average ratio items had been tested under QPSK, 16QAM and 64QAM modes, the other test items were performed under worse mode according to the maximum output power.

Test Condition:

Test Item	Environmental Conditions	Input Power	Tested By
ERP	25deg. C, 60%RH	4.0Vdc	James Yang
Modulation Characteristics	25deg. C, 60%RH	4.0Vdc	James Yang
Frequency Stability	25deg. C, 60%RH	4.0Vdc	James Yang
Occupied Bandwidth	25deg. C, 60%RH	4.0Vdc	James Yang
Band Edge	25deg. C, 60%RH	4.0Vdc	James Yang
Peak To Average Ratio	25deg. C, 60%RH	4.0Vdc	James Yang
Conducted Emission	25deg. C, 60%RH	4.0Vdc	James Yang
Radiated Emission	22deg. C, 64%RH	4.0Vdc	Vincent Chen

3.4 EUT Operating Conditions

The EUT makes a call to the communication simulator. The communication simulator station system controlled a EUT to export maximum output power under transmission mode and specific channel frequency

3.5 General Description of Applied Standards and References

The EUT is a RF Product. According to the specifications of the manufacturer, it must comply with the requirements of the following standards:

Test Standard:

FCC 47 CFR Part 2

FCC 47 CFR Part 22

ANSI/TIA/EIA-603-E 2016

ANSI 63.26-2015

References Test Guidance:

KDB 971168 D01 Power Meas License Digital Systems v03r01

All test items have been performed and recorded as per the above standards.

4 Test Types and Results

4.1 Output Power Measurement

4.1.1 Limits of Output Power Measurement

Mobile / Portable station are limited to 7 watts e.r.p.

4.1.2 Test Procedures

Conducted Power Measurement:

The EUT was set up for the maximum power with GPRS, EDGE, LTE link data modulation and link up with simulator. Set the EUT to transmit under low, middle and high channel and record the power level shown on simulator.

Maximum EIRP / ERP

The relevant equation for determining the maximum ERP or EIRP from the measured RF output power is given in Equation as follows:

$$\text{EIRP} = P_{\text{Meas}} + G_{\text{T}}$$

$$\text{ERP} = P_{\text{Meas}} + G_{\text{T}} - 2.15$$

where

ERP or EIRP effective radiated power or equivalent isotropically radiated power, respectively
(expressed in the same units as P_{Meas} , e.g., dBm or dBW)

P_{Meas} measured transmitter output power or PSD, in dBm or dBW

G_{T} gain of the transmitting antenna, in dBd (ERP) or dBi (EIRP)

4.1.3 Test Setup

Conducted Power Measurement:



4.1.4 Test Results

Conducted Output Power (dBm)

Band	GPRS, EDGE 850		
Channel	128	189	251
Frequency	824.2	836.4	848.8
GPRS	30.98	30.85	30.65
EDGE	29.93	29.91	29.76

LTE Band 5						
BW	MCS Index	RB Size	RB Offset	Low	Mid	High
		Channel		20450	20525	20600
		Frequency (MHz)		829	836.5	844
10M	QPSK	1	0	23.44	23.36	23.15
		1	24	23.41	23.39	23.27
		1	49	23.04	23.27	23.06
		25	0	22.11	22.39	22.21
		25	12	21.86	22.25	22.02
		25	25	21.79	22.23	21.91
		50	0	21.75	22.31	22.05
10M	16QAM	1	0	22.62	22.59	22.58
		1	24	22.51	22.46	22.44
		1	49	22.38	22.39	22.44
		25	0	21.31	21.37	21.46
		25	12	21.25	21.36	21.42
		25	25	21.04	21.27	21.39
		50	0	20.96	21.24	21.26
10M	64QAM	1	0	21.61	21.59	21.47
		1	24	21.47	21.46	21.34
		1	49	21.35	21.34	21.23
		25	0	20.25	20.32	20.13
		25	12	20.17	20.33	20.23
		25	25	20.02	20.18	20.18
		50	0	20.10	20.24	20.14

LTE Band 5						
BW	MCS Index	RB Size	RB Offset	Low	Mid	High
		Channel		20425	20525	20625
		Frequency (MHz)		826.5	836.5	846.5
5M	QPSK	1	0	23.12	23.17	23.02
		1	12	23.28	23.37	23.20
		1	24	22.95	23.07	22.91
		12	0	22.11	22.23	22.12
		12	6	22.27	22.38	22.34
		12	13	22.04	22.25	22.29
		25	0	22.06	22.28	22.29
5M	16QAM	1	0	22.56	22.45	22.56
		1	12	22.78	22.86	22.57
		1	24	22.36	22.36	22.52
		12	0	21.26	21.31	21.49
		12	6	21.28	21.43	21.68
		12	13	21.22	21.35	21.61
		25	0	21.13	21.33	21.55
5M	64QAM	1	0	21.58	21.55	21.37
		1	12	21.71	21.77	21.46
		1	24	21.54	21.46	21.21
		12	0	20.22	20.21	20.03
		12	6	20.36	20.43	20.31
		12	13	20.10	20.26	20.21
		25	0	20.20	20.37	20.37

LTE Band 5						
BW	MCS Index	RB Size	RB Offset	Low	Mid	High
		Channel		20415	20525	20635
		Frequency (MHz)		825.5	836.5	847.5
3M	QPSK	1	0	23.32	23.29	23.06
		1	7	23.32	23.35	23.09
		1	14	23.20	23.25	22.95
		8	0	22.24	22.38	22.05
		8	3	22.14	22.40	22.08
		8	7	21.99	22.36	22.11
		15	0	21.73	22.22	22.03
3M	16QAM	1	0	22.37	22.51	22.32
		1	7	22.28	22.52	22.27
		1	14	22.25	22.48	22.44
		8	0	20.99	21.28	21.19
		8	3	21.12	21.46	21.32
		8	7	21.05	21.38	21.34
		15	0	20.97	21.32	21.32
3M	64QAM	1	0	21.54	21.53	21.37
		1	7	21.64	21.66	21.57
		1	14	21.14	21.24	21.19
		8	0	20.09	20.24	20.29
		8	3	20.23	20.42	20.46
		8	7	20.09	20.33	20.31
		15	0	19.99	20.31	20.23

LTE Band 5						
BW	MCS Index	RB Size	RB Offset	Low	Mid	High
		Channel		20407	20525	20643
		Frequency (MHz)		824.7	836.5	848.3
1.4M	QPSK	1	0	23.24	23.15	23.06
		1	2	23.28	23.34	23.19
		1	5	23.11	23.13	23.04
		3	0	23.18	23.18	23.13
		3	1	23.21	23.25	23.13
		3	3	23.09	23.24	23.22
		6	0	23.06	23.32	23.18
1.4M	16QAM	1	0	22.32	22.45	22.30
		1	2	22.09	22.49	22.22
		1	5	21.99	22.41	22.11
		3	0	21.80	22.34	22.00
		3	1	21.72	22.34	21.99
		3	3	21.63	22.28	22.02
		6	0	20.81	21.44	21.08
1.4M	64QAM	1	0	21.46	21.41	21.34
		1	2	21.30	21.53	21.30
		1	5	21.33	21.43	21.34
		3	0	21.29	21.42	21.35
		3	1	21.36	21.45	21.51
		3	3	21.24	21.45	21.47
		6	0	20.02	20.26	20.21

LTE Band 26						
BW	MCS Index	RB Size	RB Offset	Low	Mid	High
		Channel		26865	26915	26965
		Frequency (MHz)		831.5	836.5	841.5
15M	QPSK	1	0	22.92	23.36	23.44
		1	37	23.54	23.08	23.20
		1	74	22.86	22.82	23.29
		36	0	22.51	22.37	22.15
		36	19	22.26	22.44	22.01
		36	39	21.94	22.19	22.06
		75	0	22.12	22.38	22.06
15M	16QAM	1	0	22.56	22.37	22.58
		1	37	22.90	22.72	22.96
		1	74	22.40	22.09	22.15
		36	0	21.62	21.21	21.39
		36	19	21.02	21.48	21.45
		36	39	21.02	20.98	21.20
		75	0	21.24	21.37	20.99
15M	64QAM	1	0	21.38	21.16	21.53
		1	37	21.59	21.96	21.50
		1	74	21.10	21.26	21.16
		36	0	20.56	20.27	20.34
		36	19	20.02	20.39	19.93
		36	39	20.45	19.92	20.23
		75	0	20.23	20.18	20.46

LTE Band 26						
BW	MCS Index	RB Size	RB Offset	Low	Mid	High
		Channel		26840	26915	26990
		Frequency (MHz)		829	836.5	844
10M	QPSK	1	0	23.37	23.06	22.89
		1	24	23.51	23.21	23.05
		1	49	23.06	23.16	22.76
		25	0	22.14	21.98	22.22
		25	12	22.58	22.20	22.27
		25	25	22.35	22.38	22.17
		50	0	22.40	22.52	22.16
10M	16QAM	1	0	22.62	22.35	22.47
		1	24	22.60	22.46	22.98
		1	49	22.09	22.64	22.46
		25	0	21.17	21.22	21.39
		25	12	21.33	21.57	21.07
		25	25	21.08	20.93	20.91
		50	0	21.47	21.35	21.11
10M	64QAM	1	0	21.49	21.65	21.11
		1	24	21.51	21.61	21.91
		1	49	21.59	21.58	21.26
		25	0	20.48	20.23	20.39
		25	12	19.93	19.98	20.51
		25	25	20.38	20.13	20.45
		50	0	20.12	20.41	20.29

LTE Band 26						
BW	MCS Index	RB Size	RB Offset	Low	Mid	High
		Channel		26815	26915	27015
		Frequency (MHz)		826.5	836.5	846.5
5M	QPSK	1	0	23.16	23.07	22.95
		1	12	23.32	23.04	23.45
		1	24	23.06	23.29	22.85
		12	0	22.28	22.17	22.14
		12	6	22.31	22.24	22.06
		12	13	22.23	22.12	22.15
		25	0	22.24	22.27	22.32
5M	16QAM	1	0	22.48	22.69	22.78
		1	12	22.70	22.85	22.64
		1	24	22.37	22.24	22.40
		12	0	21.33	21.19	21.60
		12	6	21.31	21.54	21.58
		12	13	21.18	21.22	21.26
		25	0	21.22	21.47	21.05
5M	64QAM	1	0	21.35	21.63	21.53
		1	12	21.67	21.78	21.37
		1	24	21.32	21.15	21.26
		12	0	20.30	20.26	20.30
		12	6	20.23	20.33	20.31
		12	13	20.15	20.07	20.34
		25	0	20.26	19.99	20.11

LTE Band 26						
BW	MCS Index	RB Size	RB Offset	Low	Mid	High
		Channel		26805	26915	27025
		Frequency (MHz)		825.5	836.5	847.5
3M	QPSK	1	0	23.42	22.92	23.29
		1	7	23.15	23.18	23.48
		1	14	23.13	23.01	23.28
		8	0	22.54	22.48	22.16
		8	3	22.10	22.03	22.17
		8	7	22.25	22.00	22.31
		15	0	22.41	22.42	22.32
3M	16QAM	1	0	22.34	22.48	22.19
		1	7	22.92	22.78	22.86
		1	14	22.38	22.66	22.37
		8	0	21.38	21.61	21.07
		8	3	21.45	21.01	21.32
		8	7	21.04	21.16	21.16
		15	0	21.21	21.26	21.28
3M	64QAM	1	0	21.23	21.41	21.15
		1	7	21.56	21.48	21.70
		1	14	21.60	21.61	21.27
		8	0	20.13	20.53	20.18
		8	3	20.53	20.31	20.17
		8	7	20.36	19.93	20.04
		15	0	20.53	20.55	20.55

LTE Band 26						
BW	MCS Index	RB Size	RB Offset	Low	Mid	High
		Channel		26797	26915	27033
		Frequency (MHz)		824.7	836.5	848.3
1.4M	QPSK	1	0	23.16	23.42	23.11
		1	2	23.05	23.13	23.34
		1	5	23.01	22.81	23.05
		3	0	22.05	22.33	22.21
		3	1	22.51	22.36	22.44
		3	3	22.06	22.40	22.37
		6	0	22.31	22.20	21.97
1.4M	16QAM	1	0	22.51	22.58	22.54
		1	2	22.67	22.64	22.59
		1	5	22.31	22.57	22.51
		3	0	21.59	21.23	21.20
		3	1	21.14	21.20	21.43
		3	3	21.12	21.00	21.32
		6	0	21.40	21.28	21.50
1.4M	64QAM	1	0	21.54	21.29	21.24
		1	2	21.68	21.89	21.50
		1	5	21.23	21.34	21.47
		3	0	20.12	20.01	20.40
		3	1	20.16	20.13	20.33
		3	3	19.94	20.14	20.07
		6	0	20.11	20.48	20.34

ERP Power (dBm)

Band	GPRS, EDGE 850		
Channel	128	189	251
Frequency	824.2	836.4	848.8
GPRS	30.65	30.52	30.32
EDGE	29.60	29.58	29.43

*ERP = Conducted + antenna gain (1.82dBi) - 2.15

LTE Band 5						
BW	MCS Index	RB Size	RB Offset	Low	Mid	High
		Channel		20450	20525	20600
		Frequency (MHz)		829	836.5	844
10M	QPSK	1	0	23.11	23.03	22.82
		1	24	23.08	23.06	22.94
		1	49	22.71	22.94	22.73
		25	0	21.78	22.06	21.88
		25	12	21.53	21.92	21.69
		25	25	21.46	21.90	21.58
		50	0	21.42	21.98	21.72
10M	16QAM	1	0	22.29	22.26	22.25
		1	24	22.18	22.13	22.11
		1	49	22.05	22.06	22.11
		25	0	20.98	21.04	21.13
		25	12	20.92	21.03	21.09
		25	25	20.71	20.94	21.06
		50	0	20.63	20.91	20.93
10M	64QAM	1	0	21.28	21.26	21.14
		1	24	21.14	21.13	21.01
		1	49	21.02	21.01	20.90
		25	0	19.92	19.99	19.80
		25	12	19.84	20.00	19.90
		25	25	19.69	19.85	19.85
		50	0	19.77	19.91	19.81

*ERP = Conducted + antenna gain (1.82dBi) - 2.15

LTE Band 5						
BW	MCS Index	RB Size	RB Offset	Low	Mid	High
		Channel		20425	20525	20625
		Frequency (MHz)		826.5	836.5	846.5
5M	QPSK	1	0	22.79	22.84	22.69
		1	12	22.95	23.04	22.87
		1	24	22.62	22.74	22.58
		12	0	21.78	21.90	21.79
		12	6	21.94	22.05	22.01
		12	13	21.71	21.92	21.96
		25	0	21.73	21.95	21.96
5M	16QAM	1	0	22.23	22.12	22.23
		1	12	22.45	22.53	22.24
		1	24	22.03	22.03	22.19
		12	0	20.93	20.98	21.16
		12	6	20.95	21.10	21.35
		12	13	20.89	21.02	21.28
		25	0	20.80	21.00	21.22
5M	64QAM	1	0	21.25	21.22	21.04
		1	12	21.38	21.44	21.13
		1	24	21.21	21.13	20.88
		12	0	19.89	19.88	19.70
		12	6	20.03	20.10	19.98
		12	13	19.77	19.93	19.88
		25	0	19.87	20.04	20.04

*ERP = Conducted + antenna gain (1.82dBi) - 2.15

LTE Band 5						
BW	MCS Index	RB Size	RB Offset	Low	Mid	High
		Channel		20415	20525	20635
		Frequency (MHz)		825.5	836.5	847.5
3M	QPSK	1	0	22.99	22.96	22.73
		1	7	22.99	23.02	22.76
		1	14	22.87	22.92	22.62
		8	0	21.91	22.05	21.72
		8	3	21.81	22.07	21.75
		8	7	21.66	22.03	21.78
		15	0	21.40	21.89	21.70
3M	16QAM	1	0	22.04	22.18	21.99
		1	7	21.95	22.19	21.94
		1	14	21.92	22.15	22.11
		8	0	20.66	20.95	20.86
		8	3	20.79	21.13	20.99
		8	7	20.72	21.05	21.01
		15	0	20.64	20.99	20.99
3M	64QAM	1	0	21.21	21.20	21.04
		1	7	21.31	21.33	21.24
		1	14	20.81	20.91	20.86
		8	0	19.76	19.91	19.96
		8	3	19.90	20.09	20.13
		8	7	19.76	20.00	19.98
		15	0	19.66	19.98	19.90

*ERP = Conducted + antenna gain (1.82dBi) - 2.15

LTE Band 5						
BW	MCS Index	RB Size	RB Offset	Low	Mid	High
		Channel		20407	20525	20643
		Frequency (MHz)		824.7	836.5	848.3
1.4M	QPSK	1	0	22.91	22.82	22.73
		1	2	22.95	23.01	22.86
		1	5	22.78	22.80	22.71
		3	0	22.85	22.85	22.80
		3	1	22.88	22.92	22.80
		3	3	22.76	22.91	22.89
		6	0	22.73	22.99	22.85
1.4M	16QAM	1	0	21.99	22.12	21.97
		1	2	21.76	22.16	21.89
		1	5	21.66	22.08	21.78
		3	0	21.47	22.01	21.67
		3	1	21.39	22.01	21.66
		3	3	21.30	21.95	21.69
		6	0	20.48	21.11	20.75
1.4M	64QAM	1	0	21.13	21.08	21.01
		1	2	20.97	21.20	20.97
		1	5	21.00	21.10	21.01
		3	0	20.96	21.09	21.02
		3	1	21.03	21.12	21.18
		3	3	20.91	21.12	21.14
		6	0	19.69	19.93	19.88

*ERP = Conducted + antenna gain (1.82dBi) - 2.15

LTE Band 26						
BW	MCS Index	RB Size	RB Offset	Low	Mid	High
		Channel		26865	26915	26965
		Frequency (MHz)		831.5	836.5	841.5
15M	QPSK	1	0	22.59	23.03	23.11
		1	37	23.21	22.75	22.87
		1	74	22.53	22.49	22.96
		36	0	22.18	22.04	21.82
		36	19	21.93	22.11	21.68
		36	39	21.61	21.86	21.73
		75	0	21.79	22.05	21.73
15M	16QAM	1	0	22.23	22.04	22.25
		1	37	22.57	22.39	22.63
		1	74	22.07	21.76	21.82
		36	0	21.29	20.88	21.06
		36	19	20.69	21.15	21.12
		36	39	20.69	20.65	20.87
		75	0	20.91	21.04	20.66
15M	64QAM	1	0	21.05	20.83	21.20
		1	37	21.26	21.63	21.17
		1	74	20.77	20.93	20.83
		36	0	20.23	19.94	20.01
		36	19	19.69	20.06	19.60
		36	39	20.12	19.59	19.90
		75	0	19.90	19.85	20.13

*ERP = Conducted + antenna gain (1.82dBi) - 2.15

LTE Band 26						
BW	MCS Index	RB Size	RB Offset	Low	Mid	High
		Channel		26840	26915	26990
		Frequency (MHz)		829	836.5	844
10M	QPSK	1	0	23.04	22.73	22.56
		1	24	23.18	22.88	22.72
		1	49	22.73	22.83	22.43
		25	0	21.81	21.65	21.89
		25	12	22.25	21.87	21.94
		25	25	22.02	22.05	21.84
		50	0	22.07	22.19	21.83
10M	16QAM	1	0	22.29	22.02	22.14
		1	24	22.27	22.13	22.65
		1	49	21.76	22.31	22.13
		25	0	20.84	20.89	21.06
		25	12	21.00	21.24	20.74
		25	25	20.75	20.60	20.58
		50	0	21.14	21.02	20.78
10M	64QAM	1	0	21.16	21.32	20.78
		1	24	21.18	21.28	21.58
		1	49	21.26	21.25	20.93
		25	0	20.15	19.90	20.06
		25	12	19.60	19.65	20.18
		25	25	20.05	19.80	20.12
		50	0	19.79	20.08	19.96

*ERP = Conducted + antenna gain (1.82dBi) - 2.15

LTE Band 26						
BW	MCS Index	RB Size	RB Offset	Low	Mid	High
		Channel		26815	26915	27015
		Frequency (MHz)		826.5	836.5	846.5
5M	QPSK	1	0	22.83	22.74	22.62
		1	12	22.99	22.71	23.12
		1	24	22.73	22.96	22.52
		12	0	21.95	21.84	21.81
		12	6	21.98	21.91	21.73
		12	13	21.90	21.79	21.82
		25	0	21.91	21.94	21.99
5M	16QAM	1	0	22.15	22.36	22.45
		1	12	22.37	22.52	22.31
		1	24	22.04	21.91	22.07
		12	0	21.00	20.86	21.27
		12	6	20.98	21.21	21.25
		12	13	20.85	20.89	20.93
		25	0	20.89	21.14	20.72
5M	64QAM	1	0	21.02	21.30	21.20
		1	12	21.34	21.45	21.04
		1	24	20.99	20.82	20.93
		12	0	19.97	19.93	19.97
		12	6	19.90	20.00	19.98
		12	13	19.82	19.74	20.01
		25	0	19.93	19.66	19.78

*ERP = Conducted + antenna gain (1.82dBi) - 2.15

LTE Band 26						
BW	MCS Index	RB Size	RB Offset	Low	Mid	High
		Channel		26805	26915	27025
		Frequency (MHz)		825.5	836.5	847.5
3M	QPSK	1	0	23.09	22.59	22.96
		1	7	22.82	22.85	23.15
		1	14	22.80	22.68	22.95
		8	0	22.21	22.15	21.83
		8	3	21.77	21.70	21.84
		8	7	21.92	21.67	21.98
		15	0	22.08	22.09	21.99
3M	16QAM	1	0	22.01	22.15	21.86
		1	7	22.59	22.45	22.53
		1	14	22.05	22.33	22.04
		8	0	21.05	21.28	20.74
		8	3	21.12	20.68	20.99
		8	7	20.71	20.83	20.83
		15	0	20.88	20.93	20.95
3M	64QAM	1	0	20.90	21.08	20.82
		1	7	21.23	21.15	21.37
		1	14	21.27	21.28	20.94
		8	0	19.80	20.20	19.85
		8	3	20.20	19.98	19.84
		8	7	20.03	19.60	19.71
		15	0	20.20	20.22	20.22

*ERP = Conducted + antenna gain (1.82dBi) - 2.15

LTE Band 26						
BW	MCS Index	RB Size	RB Offset	Low	Mid	High
		Channel		26797	26915	27033
		Frequency (MHz)		824.7	836.5	848.3
1.4M	QPSK	1	0	22.83	23.09	22.78
		1	2	22.72	22.80	23.01
		1	5	22.68	22.48	22.72
		3	0	21.72	22.00	21.88
		3	1	22.18	22.03	22.11
		3	3	21.73	22.07	22.04
		6	0	21.98	21.87	21.64
1.4M	16QAM	1	0	22.18	22.25	22.21
		1	2	22.34	22.31	22.26
		1	5	21.98	22.24	22.18
		3	0	21.26	20.90	20.87
		3	1	20.81	20.87	21.10
		3	3	20.79	20.67	20.99
		6	0	21.07	20.95	21.17
1.4M	64QAM	1	0	21.21	20.96	20.91
		1	2	21.35	21.56	21.17
		1	5	20.90	21.01	21.14
		3	0	19.79	19.68	20.07
		3	1	19.83	19.80	20.00
		3	3	19.61	19.81	19.74
		6	0	19.78	20.15	20.01

*ERP = Conducted + antenna gain (1.82dBi) - 2.15

4.2 Modulation Characteristics Measurement

4.2.1 Limits of Modulation Characteristics

N/A

4.2.2 Test Procedure

Connect the EUT to Communication Simulator via the antenna connector, The frequency band is set as EUT supported Modulation and Channels, the EUT output is matched with 50 ohm load, the waveform quality and constellation of the EUT was tested.

4.2.3 Test Setup



4.2.4 Test Results

GPRS, EDGE

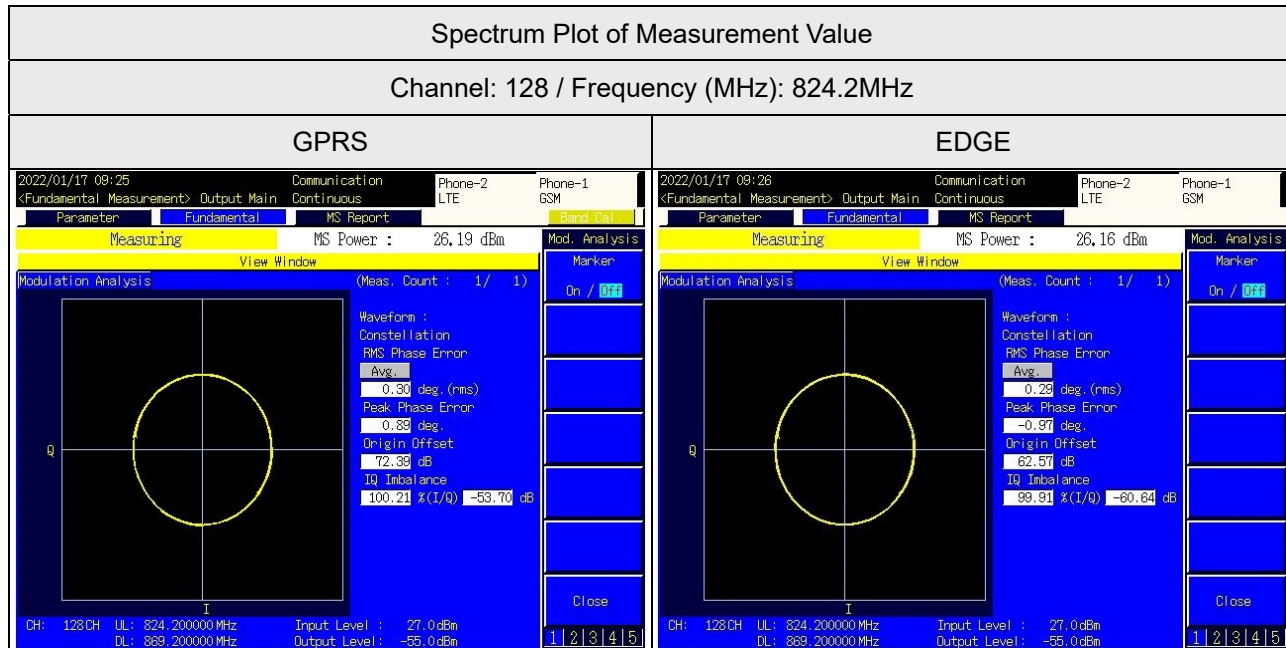

LTE Band 5

Spectrum Plot of Measurement Value

Channel: 20525 / Frequency (MHz): 836.5MHz

QPSK

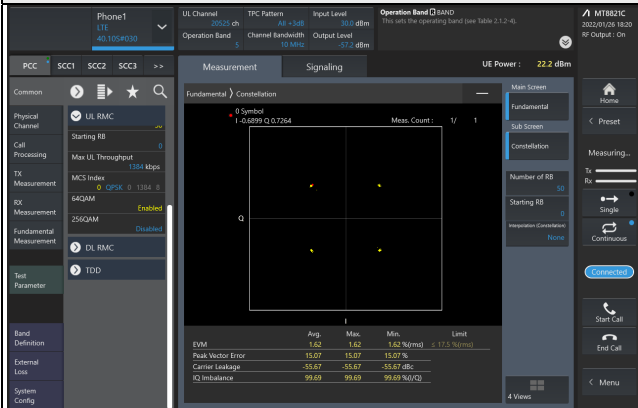

16QAM

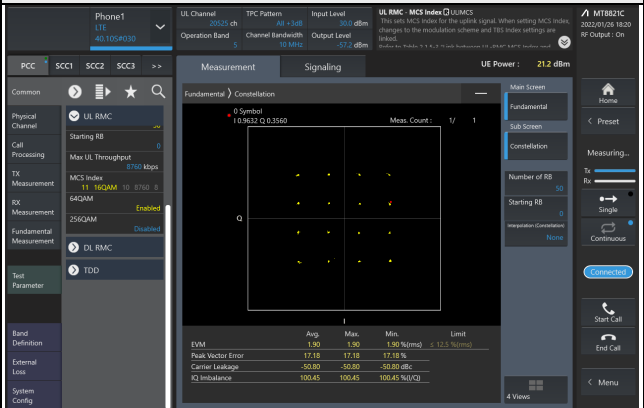

64QAM

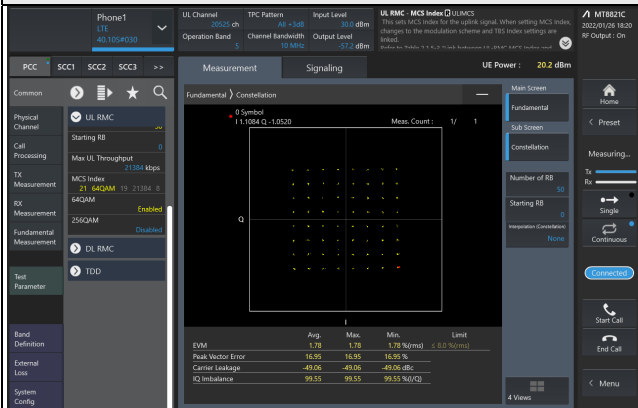

LTE Band 26

Spectrum Plot of Measurement Value

Channel: 26915 / Frequency (MHz): 836.5MHz

QPSK

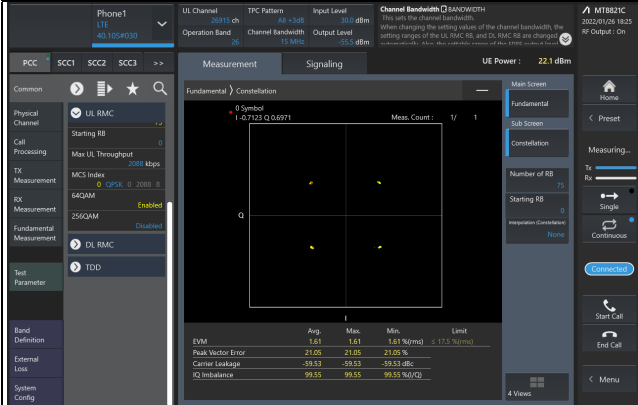

16QAM

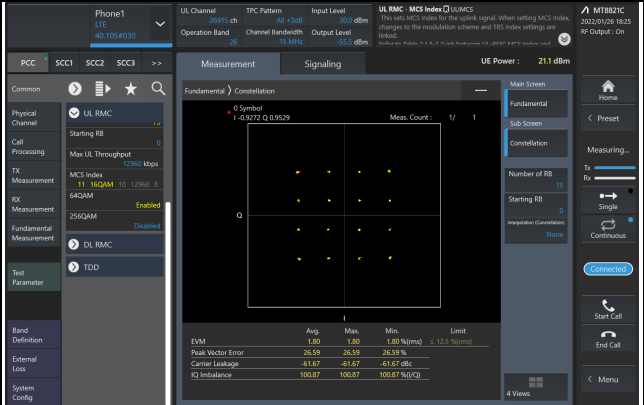

64QAM

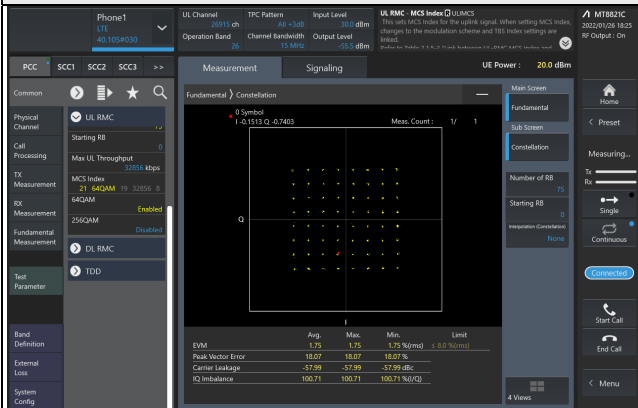

4.3 Frequency Stability Measurement

4.3.1 Limits of Frequency Stability Measurement

1.5 ppm is for base and fixed station. 2.5 ppm is for mobile station.

4.3.2 Test Procedure

- Device is placed at the oven room. The oven room could control the temperatures and humidity. Power warm up is at least 15 min and power applied should perform before recording frequency error.
- EUT is connected the external power supply to control the DC input power. The test voltage range is from minimum to maximum working voltage. Each step shall be record the frequency error rate.
- The temperature range step is 10 degrees in this test items. All temperature levels shall be hold the ± 0.5 °C during the measurement testing. The each temperature step shall be at least 0.5 hours, consider the EUT could be test under the stability condition.

Note: The frequency error was recorded frequency error from the communication simulator.

4.3.3 Test Setup

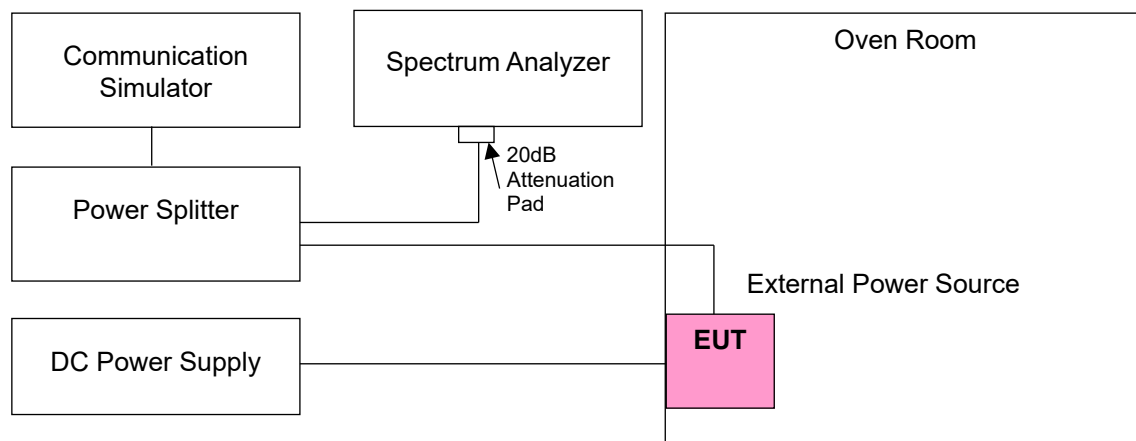

4.3.4 Test Results

Frequency Error vs. Voltage

Voltage (Vdc)	GPRS			
	Low Channel		High Channel	
	Frequency (MHz)	Frequency Error (ppm)	Frequency (MHz)	Frequency Error (ppm)
4.0	824.200003	0.004	848.800001	0.001
3.4	824.200001	0.001	848.800001	0.001
4.6	824.200002	0.002	848.800004	0.005

Note: The applicant defined the normal working voltage is from 3.4Vdc to 4.6Vdc.

Frequency Error vs. Temperature

Temp. (°C)	GPRS			
	Low Channel		High Channel	
	Frequency (MHz)	Frequency Error (ppm)	Frequency (MHz)	Frequency Error (ppm)
-40	824.200001	0.001	848.800001	0.001
-30	824.200003	0.004	848.800003	0.004
-20	824.200001	0.001	848.800002	0.002
-10	824.200002	0.002	848.800004	0.005
0	824.200001	0.001	848.800002	0.002
10	824.200002	0.002	848.800003	0.004
20	824.199998	-0.002	848.799996	-0.005
30	824.199996	-0.005	848.799999	-0.001
40	824.199998	-0.002	848.799996	-0.005
50	824.199998	-0.002	848.799997	-0.004
60	824.199998	-0.002	848.799997	-0.004
70	824.199999	-0.001	848.799997	-0.004
80	824.199997	-0.004	848.799997	-0.004
85	824.199996	-0.005	848.799998	-0.002

Frequency Error vs. Voltage

Voltage (Vdc)	EDGE			
	Low Channel		High Channel	
	Frequency (MHz)	Frequency Error (ppm)	Frequency (MHz)	Frequency Error (ppm)
4.0	824.200002	0.002	848.800001	0.001
3.4	824.200004	0.005	848.800004	0.005
4.6	824.200003	0.004	848.800004	0.005

Note: The applicant defined the normal working voltage is from 3.4Vdc to 4.6Vdc.

Frequency Error vs. Temperature

Temp. (°C)	EDGE			
	Low Channel		High Channel	
	Frequency (MHz)	Frequency Error (ppm)	Frequency (MHz)	Frequency Error (ppm)
-40	824.200002	0.002	848.800001	0.001
-30	824.200003	0.004	848.800002	0.002
-20	824.200004	0.005	848.800003	0.004
-10	824.200003	0.004	848.800003	0.004
0	824.200001	0.001	848.800001	0.001
10	824.200003	0.004	848.800003	0.004
20	824.199997	-0.004	848.799997	-0.004
30	824.199996	-0.005	848.799997	-0.004
40	824.199998	-0.002	848.799997	-0.004
50	824.199999	-0.001	848.799999	-0.001
60	824.199997	-0.004	848.799996	-0.005
70	824.199996	-0.005	848.799998	-0.002
80	824.199996	-0.005	848.799998	-0.002
85	824.199999	-0.001	848.799996	-0.005

Frequency Error vs. Voltage

Voltage (Vdc)	LTE Band 5			
	Channel Bandwidth 1.4 MHz			
	Low Channel		High Channel	
	Frequency (MHz)	Frequency Error (ppm)	Frequency (MHz)	Frequency Error (ppm)
4.0	824.700002	0.002	848.300004	0.005
3.4	824.700002	0.002	848.300003	0.004
4.6	824.700004	0.005	848.300003	0.004

Note: The applicant defined the normal working voltage is from 3.4Vdc to 4.6Vdc.

Frequency Error vs. Temperature

Temp. (°C)	LTE Band 5			
	Channel Bandwidth 1.4 MHz			
	Low Channel		High Channel	
	Frequency (MHz)	Frequency Error (ppm)	Frequency (MHz)	Frequency Error (ppm)
-40	824.700002	0.002	848.300003	0.004
-30	824.700004	0.005	848.300002	0.002
-20	824.700001	0.001	848.300003	0.004
-10	824.700001	0.001	848.300001	0.001
0	824.700003	0.004	848.300003	0.004
10	824.700001	0.001	848.300001	0.001
20	824.699998	-0.002	848.299997	-0.004
30	824.699998	-0.002	848.299998	-0.002
40	824.699997	-0.004	848.299996	-0.005
50	824.699999	-0.001	848.299997	-0.004
60	824.699998	-0.002	848.299999	-0.001
70	824.699997	-0.004	848.299999	-0.001
80	824.699998	-0.002	848.299997	-0.004
85	824.699999	-0.001	848.299997	-0.004

Frequency Error vs. Voltage

Voltage (Vdc)	LTE Band 5			
	Channel Bandwidth 3 MHz			
	Low Channel		High Channel	
	Frequency (MHz)	Frequency Error (ppm)	Frequency (MHz)	Frequency Error (ppm)
4.0	825.500002	0.002	847.500004	0.005
3.4	825.500002	0.002	847.500002	0.002
4.6	825.500002	0.002	847.500003	0.004

Note: The applicant defined the normal working voltage is from 3.4Vdc to 4.6Vdc.

Frequency Error vs. Temperature

Temp. (°C)	LTE Band 5			
	Channel Bandwidth 3 MHz			
	Low Channel		High Channel	
	Frequency (MHz)	Frequency Error (ppm)	Frequency (MHz)	Frequency Error (ppm)
-40	825.500004	0.005	847.500002	0.002
-30	825.500003	0.004	847.500004	0.005
-20	825.500003	0.004	847.500002	0.002
-10	825.500001	0.001	847.500002	0.002
0	825.500004	0.005	847.500002	0.002
10	825.500001	0.001	847.500002	0.002
20	825.499998	-0.002	847.499997	-0.004
30	825.499999	-0.001	847.499999	-0.001
40	825.499997	-0.004	847.499996	-0.005
50	825.499999	-0.001	847.499998	-0.002
60	825.499997	-0.004	847.499998	-0.002
70	825.499996	-0.005	847.499997	-0.004
80	825.499999	-0.001	847.499998	-0.002
85	825.499997	-0.004	847.499998	-0.002

Frequency Error vs. Voltage

Voltage (Vdc)	LTE Band 5			
	Channel Bandwidth 5 MHz			
	Low Channel		High Channel	
	Frequency (MHz)	Frequency Error (ppm)	Frequency (MHz)	Frequency Error (ppm)
4.0	826.500003	0.004	846.500002	0.002
3.4	826.500003	0.004	846.500002	0.002
4.6	826.500004	0.005	846.500002	0.002

Note: The applicant defined the normal working voltage is from 3.4Vdc to 4.6Vdc.

Frequency Error vs. Temperature

Temp. (°C)	LTE Band 5			
	Channel Bandwidth 5 MHz			
	Low Channel		High Channel	
	Frequency (MHz)	Frequency Error (ppm)	Frequency (MHz)	Frequency Error (ppm)
-40	826.500004	0.005	846.500002	0.002
-30	826.500001	0.001	846.500001	0.001
-20	826.500004	0.005	846.500004	0.005
-10	826.500002	0.002	846.500001	0.001
0	826.500004	0.005	846.500003	0.004
10	826.500001	0.001	846.500003	0.004
20	826.499998	-0.002	846.499998	-0.002
30	826.499997	-0.004	846.499996	-0.005
40	826.499996	-0.005	846.499996	-0.005
50	826.499999	-0.001	846.499996	-0.005
60	826.499997	-0.004	846.499997	-0.004
70	826.499996	-0.005	846.499996	-0.005
80	826.499997	-0.004	846.499999	-0.001
85	826.499999	-0.001	846.499997	-0.004

Frequency Error vs. Voltage

Voltage (Vdc)	LTE Band 5			
	Channel Bandwidth 10 MHz			
	Low Channel		High Channel	
	Frequency (MHz)	Frequency Error (ppm)	Frequency (MHz)	Frequency Error (ppm)
4.0	829.000003	0.004	844.000003	0.004
3.4	829.000004	0.005	844.000003	0.004
4.6	829.000003	0.004	844.000002	0.002

Note: The applicant defined the normal working voltage is from 3.4Vdc to 4.6Vdc.

Frequency Error vs. Temperature

Temp. (°C)	LTE Band 5			
	Channel Bandwidth 10 MHz			
	Low Channel		High Channel	
	Frequency (MHz)	Frequency Error (ppm)	Frequency (MHz)	Frequency Error (ppm)
-40	829.000002	0.002	844.000003	0.004
-30	829.000001	0.001	844.000002	0.002
-20	829.000004	0.005	844.000002	0.002
-10	829.000004	0.005	844.000001	0.001
0	829.000001	0.001	844.000001	0.001
10	829.000003	0.004	844.000002	0.002
20	828.999996	-0.005	843.999999	-0.001
30	828.999999	-0.001	843.999998	-0.002
40	828.999999	-0.001	843.999996	-0.005
50	828.999998	-0.002	843.999997	-0.004
60	828.999999	-0.001	843.999997	-0.004
70	828.999999	-0.001	843.999999	-0.001
80	828.999998	-0.002	843.999996	-0.005
85	828.999996	-0.005	843.999997	-0.004

Frequency Error vs. Voltage

Voltage (Vdc)	LTE Band 26			
	Channel Bandwidth: 1.4 MHz			
	Low Channel		High Channel	
	Frequency (MHz)	Frequency Error (ppm)	Frequency (MHz)	Frequency Error (ppm)
4.0	824.700003	0.004	848.300002	0.002
3.4	824.700001	0.001	848.300002	0.002
4.6	824.700002	0.002	848.300001	0.001

Note: The applicant defined the normal working voltage is from 3.4Vdc to 4.6Vdc.

Frequency Error vs. Temperature

Temp. (°C)	LTE Band 26			
	Channel Bandwidth: 1.4 MHz			
	Low Channel		High Channel	
	Frequency (MHz)	Frequency Error (ppm)	Frequency (MHz)	Frequency Error (ppm)
-40	824.700002	0.002	848.300003	0.004
-30	824.700003	0.004	848.300002	0.002
-20	824.700001	0.001	848.300001	0.001
-10	824.700003	0.004	848.300001	0.001
0	824.700001	0.001	848.300003	0.004
10	824.700001	0.001	848.300003	0.004
20	824.699999	-0.001	848.299997	-0.004
30	824.699997	-0.004	848.299996	-0.005
40	824.699998	-0.002	848.299998	-0.002
50	824.699997	-0.004	848.299997	-0.004
60	824.699999	-0.001	848.299997	-0.004
70	824.699997	-0.004	848.299998	-0.002
80	824.699999	-0.001	848.299996	-0.005
85	824.699999	-0.001	848.299999	-0.001

Frequency Error vs. Voltage

Voltage (Vdc)	LTE Band 26			
	Channel Bandwidth: 3 MHz			
	Low Channel		High Channel	
	Frequency (MHz)	Frequency Error (ppm)	Frequency (MHz)	Frequency Error (ppm)
4.0	825.500003	0.004	847.500001	0.001
3.4	825.500004	0.005	847.500001	0.001
4.6	825.500001	0.001	847.500004	0.005

Note: The applicant defined the normal working voltage is from 3.4Vdc to 4.6Vdc.

Frequency Error vs. Temperature

Temp. (°C)	LTE Band 26			
	Channel Bandwidth: 3 MHz			
	Low Channel		High Channel	
	Frequency (MHz)	Frequency Error (ppm)	Frequency (MHz)	Frequency Error (ppm)
-40	825.500004	0.005	847.500004	0.005
-30	825.500003	0.004	847.500001	0.001
-20	825.500004	0.005	847.500001	0.001
-10	825.500002	0.002	847.500001	0.001
0	825.500004	0.005	847.500003	0.004
10	825.500004	0.005	847.500001	0.001
20	825.499996	-0.005	847.499999	-0.001
30	825.499999	-0.001	847.499998	-0.002
40	825.499999	-0.001	847.499998	-0.002
50	825.499997	-0.004	847.499997	-0.004
60	825.499997	-0.004	847.499999	-0.001
70	825.499999	-0.001	847.499997	-0.004
80	825.499997	-0.004	847.499997	-0.004
85	825.499996	-0.005	847.499999	-0.001

Frequency Error vs. Voltage

Voltage (Vdc)	LTE Band 26			
	Channel Bandwidth: 5 MHz			
	Low Channel		High Channel	
	Frequency (MHz)	Frequency Error (ppm)	Frequency (MHz)	Frequency Error (ppm)
4.0	826.500003	0.004	846.500001	0.001
3.4	826.500003	0.004	846.500002	0.002
4.6	826.500001	0.001	846.500003	0.004

Note: The applicant defined the normal working voltage is from 3.4Vdc to 4.6Vdc.

Frequency Error vs. Temperature

Temp. (°C)	LTE Band 26			
	Channel Bandwidth: 5 MHz			
	Low Channel		High Channel	
	Frequency (MHz)	Frequency Error (ppm)	Frequency (MHz)	Frequency Error (ppm)
-40	826.500003	0.004	846.500001	0.001
-30	826.500001	0.001	846.500004	0.005
-20	826.500001	0.001	846.500003	0.004
-10	826.500001	0.001	846.500001	0.001
0	826.500003	0.004	846.500001	0.001
10	826.500004	0.005	846.500004	0.005
20	826.499998	-0.002	846.499996	-0.005
30	826.499996	-0.005	846.499998	-0.002
40	826.499999	-0.001	846.499998	-0.002
50	826.499997	-0.004	846.499998	-0.002
60	826.499998	-0.002	846.499999	-0.001
70	826.499997	-0.004	846.499996	-0.005
80	826.499997	-0.004	846.499999	-0.001
85	826.499998	-0.002	846.499996	-0.005

Frequency Error vs. Voltage

Voltage (Vdc)	LTE Band 26			
	Channel Bandwidth: 10 MHz			
	Low Channel		High Channel	
	Frequency (MHz)	Frequency Error (ppm)	Frequency (MHz)	Frequency Error (ppm)
4.0	829.000001	0.001	844.000001	0.001
3.4	829.000001	0.001	844.000002	0.002
4.6	829.000001	0.001	844.000002	0.002

Note: The applicant defined the normal working voltage is from 3.4Vdc to 4.6Vdc.

Frequency Error vs. Temperature

Temp. (°C)	LTE Band 26			
	Channel Bandwidth: 10 MHz			
	Low Channel		High Channel	
	Frequency (MHz)	Frequency Error (ppm)	Frequency (MHz)	Frequency Error (ppm)
-40	829.000002	0.002	844.000002	0.002
-30	829.000003	0.004	844.000004	0.005
-20	829.000003	0.004	844.000001	0.001
-10	829.000002	0.002	844.000001	0.001
0	829.000004	0.005	844.000003	0.004
10	829.000001	0.001	844.000004	0.005
20	828.999998	-0.002	843.999998	-0.002
30	828.999997	-0.004	843.999998	-0.002
40	828.999997	-0.004	843.999997	-0.004
50	828.999999	-0.001	843.999997	-0.004
60	828.999996	-0.005	843.999997	-0.004
70	828.999999	-0.001	843.999998	-0.002
80	828.999997	-0.004	843.999999	-0.001
85	828.999999	-0.001	843.999998	-0.002

Frequency Error vs. Voltage

Voltage (Vdc)	LTE Band 26			
	Channel Bandwidth: 15 MHz			
	Low Channel		High Channel	
	Frequency (MHz)	Frequency Error (ppm)	Frequency (MHz)	Frequency Error (ppm)
4.0	831.500003	0.004	841.500004	0.005
3.4	831.500002	0.002	841.500004	0.005
4.6	831.500002	0.002	841.500002	0.002

Note: The applicant defined the normal working voltage is from 3.4Vdc to 4.6Vdc.

Frequency Error vs. Temperature

Temp. (°C)	LTE Band 26			
	Channel Bandwidth: 15 MHz			
	Low Channel		High Channel	
	Frequency (MHz)	Frequency Error (ppm)	Frequency (MHz)	Frequency Error (ppm)
-40	831.500001	0.001	841.500003	0.004
-30	831.500004	0.005	841.500002	0.002
-20	831.500004	0.005	841.500003	0.004
-10	831.500004	0.005	841.500003	0.004
0	831.500001	0.001	841.500004	0.005
10	831.500003	0.004	841.500001	0.001
20	831.499997	-0.004	841.499998	-0.002
30	831.499998	-0.002	841.499996	-0.005
40	831.499997	-0.004	841.499999	-0.001
50	831.499996	-0.005	841.499998	-0.002
60	831.499996	-0.005	841.499999	-0.001
70	831.499996	-0.005	841.499998	-0.002
80	831.499998	-0.002	841.499997	-0.004
85	831.499999	-0.001	841.499996	-0.005

4.4 Occupied Bandwidth Measurement

4.4.1 Test Procedure

For the 26dBc bandwidth measurement method, please refer to section 5.4.3 of ANSI C63.26.

- a) The spectrum analyzer center frequency is set to the nominal EUT channel center frequency. The span range for the spectrum analyzer shall be wide enough to see sufficient roll off of the signal to make the measurement.
- b) The nominal RBW shall be in the range of 1% to 5% of the anticipated OBW, and the VBW shall be set $\geq 3 \times$ RBW.
- c) Set the reference level of the instrument as required to prevent the signal amplitude from exceeding the maximum spectrum analyzer input mixer level for linear operation. See guidance provided in 4.2.3.
- d) The dynamic range of the spectrum analyzer at the selected RBW shall be more than 10 dB below the target “-X dB” requirement, i.e., if the requirement calls for measuring the -26 dB OBW, the spectrum analyzer noise floor at the selected RBW shall be at least 36 dB below the reference level.
- e) Set spectrum analyzer detection mode to peak, and the trace mode to max hold.
- f) Determine the following reference values: Set the EUT to transmit a modulated signal. Allow the trace to stabilize. Set the spectrum analyzer marker to the highest level of the displayed trace (this is the reference value).
- g) Determine the “-X dB amplitude” as equal to (Reference Value - X). Alternatively, this calculation can be performed on the spectrum analyzer using the delta-marker measurement function.
- h) Place two markers, one at the lowest and the other at the highest frequency of the envelope of the spectral display such that each marker is at or slightly below the “-X dB amplitude” determined in step f). If a marker is below this “-X dB amplitude” value it should be as close as possible to this value. The OBW is the positive frequency difference between the two markers.
- i) The OBW shall be reported by providing plot(s) of the measuring instrument display, to include markers depicting the relevant frequency and amplitude information (e.g., marker table). The frequency and amplitude axis and scale shall be clearly labeled. Tabular data may be reported in addition to the plot(s).

For the occupied bandwidth measurement method, please refer to section 5.4.4 of ANSI C63.26.

4.4.2 Test Setup

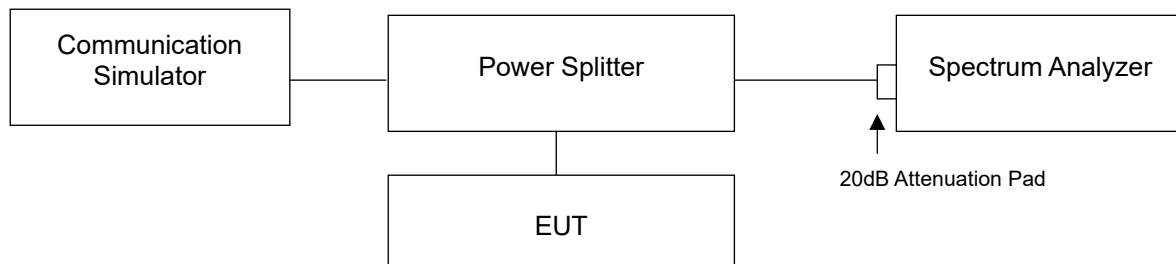

4.4.3 Test Result

GPRS, EDGE

Test Condition	Channel	Frequency (MHz)	Occupied bandwidth (kHz)	26dB Bandwidth (kHz)
GPRS	128	824.2	247.37	318.80
GPRS	189	836.4	246.25	317.50
GPRS	251	848.8	245.04	314.30
EDGE	128	824.2	244.70	318.80
EDGE	189	836.4	245.77	320.60
EDGE	251	848.8	245.37	318.00

Spectrum Plot of Worst Value

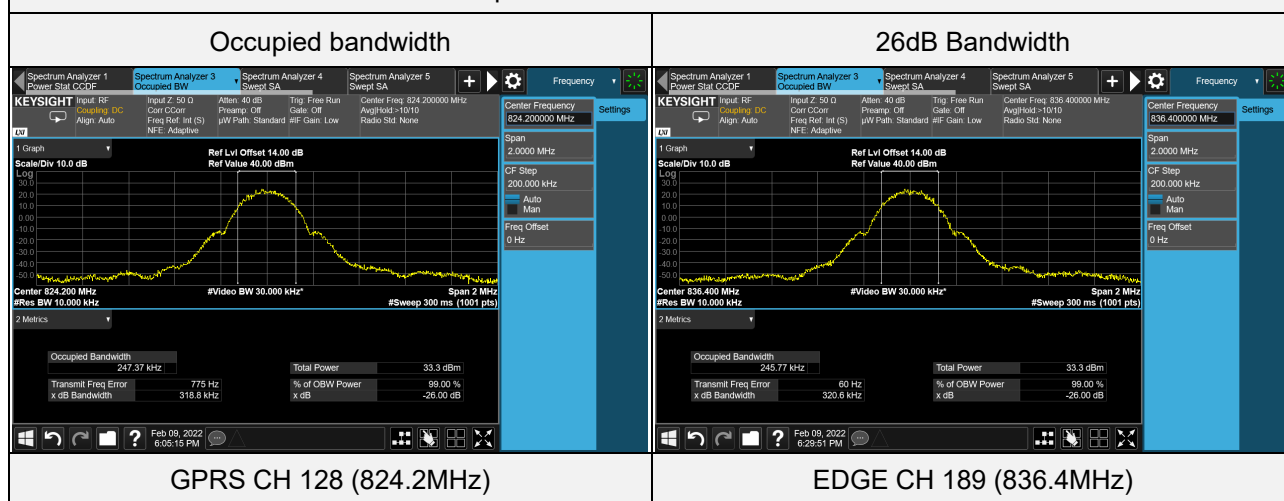

LTE Band 5 (Channel Bandwidth 1.4MHz)

Test Condition	Channel	Frequency (MHz)	Occupied bandwidth (MHz)	26dB Bandwidth (MHz)
QPSK	20407	824.7	1.0865	1.256
QPSK	20525	836.5	1.0898	1.259
QPSK	20643	848.3	1.0880	1.253
16QAM	20407	824.7	1.0872	1.253
16QAM	20525	836.5	1.0861	1.250
16QAM	20643	848.3	1.0871	1.247
64QAM	20407	824.7	1.0883	1.251
64QAM	20525	836.5	1.0882	1.246
64QAM	20643	848.3	1.0873	1.251

Spectrum Plot of Worst Value

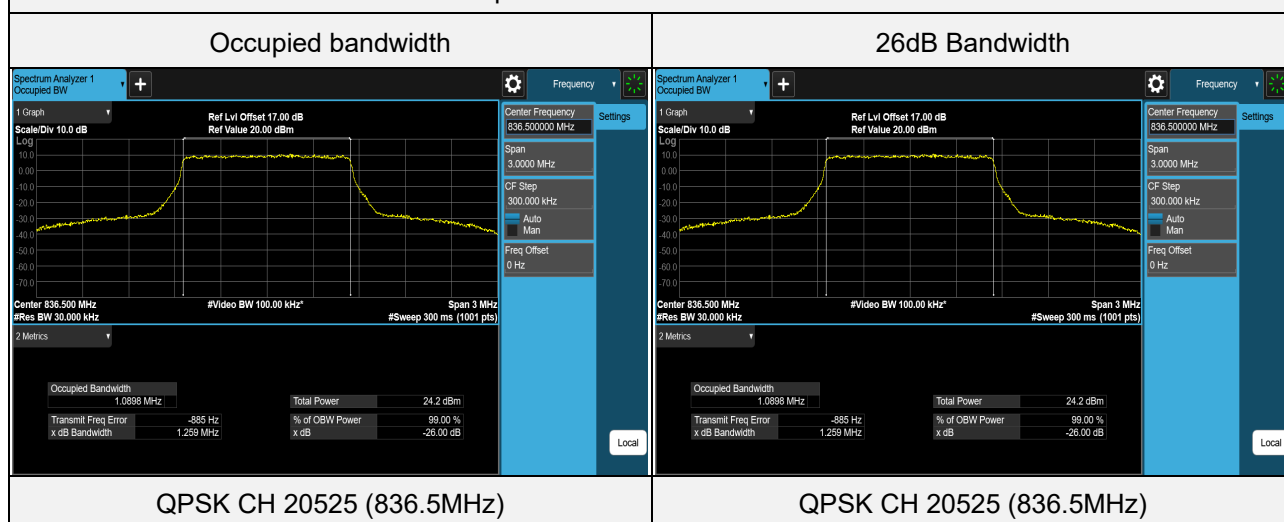

LTE Band 5 (Channel Bandwidth 3MHz)

Test Condition	Channel	Frequency (MHz)	Occupied bandwidth (MHz)	26dB Bandwidth (MHz)
QPSK	20415	825.5	2.6954	2.870
QPSK	20525	836.5	2.6917	2.868
QPSK	20635	847.5	2.6941	2.866
16QAM	20415	825.5	2.6938	2.875
16QAM	20525	836.5	2.6916	2.872
16QAM	20635	847.5	2.6920	2.873
64QAM	20415	825.5	2.6916	2.862
64QAM	20525	836.5	2.6902	2.861
64QAM	20635	847.5	2.6911	2.892

Spectrum Plot of Worst Value

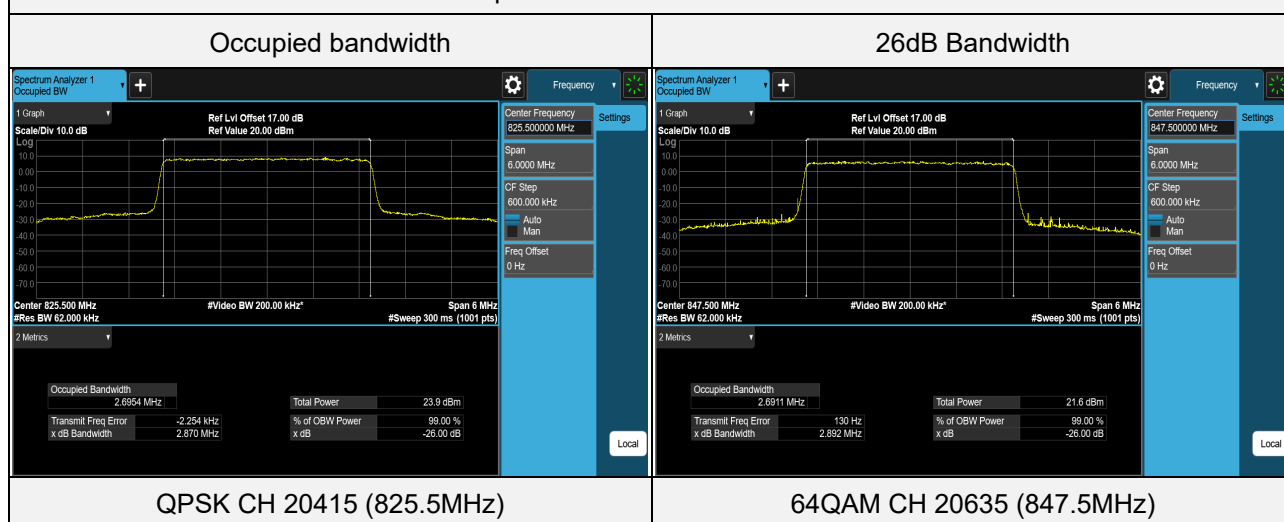

LTE Band 5 (Channel Bandwidth 5MHz)

Test Condition	Channel	Frequency (MHz)	Occupied bandwidth (MHz)	26dB Bandwidth (MHz)
QPSK	20425	826.5	4.4960	4.780
QPSK	20525	836.5	4.4941	4.779
QPSK	20625	846.5	4.4864	4.764
16QAM	20425	826.5	4.4924	4.773
16QAM	20525	836.5	4.4898	4.767
16QAM	20625	846.5	4.4883	4.765
64QAM	20425	826.5	4.4979	4.775
64QAM	20525	836.5	4.4915	4.770
64QAM	20625	846.5	4.4892	4.776

Spectrum Plot of Worst Value

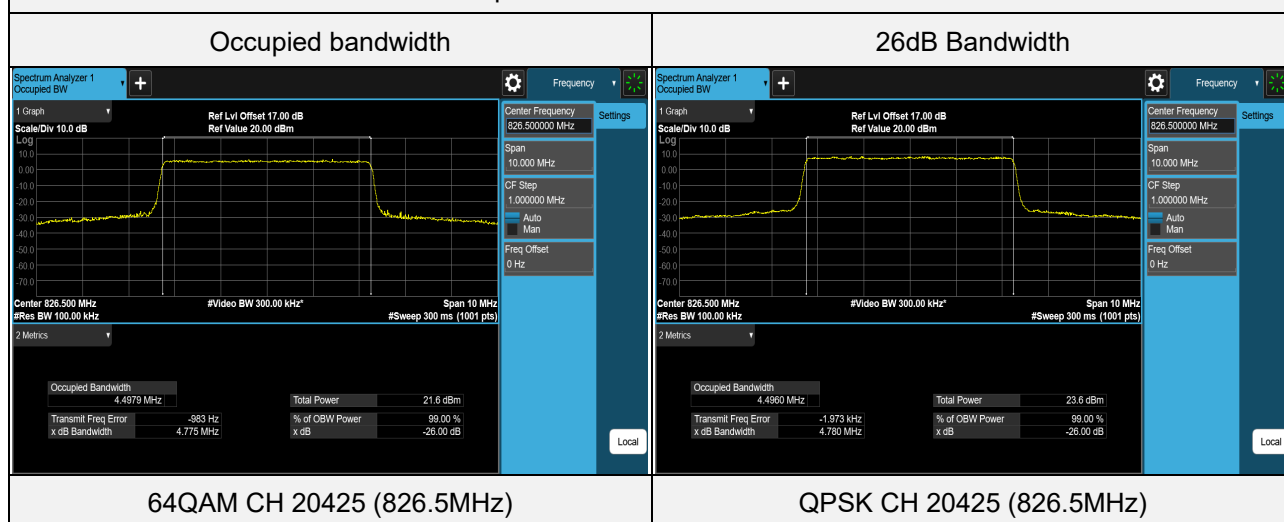

LTE Band 5 (Channel Bandwidth 10MHz)

Test Condition	Channel	Frequency (MHz)	Occupied bandwidth (MHz)	26dB Bandwidth (MHz)
QPSK	20450	829	8.9857	9.516
QPSK	20525	836.5	8.9736	9.510
QPSK	20600	844	8.9792	9.510
16QAM	20450	829	8.9865	9.513
16QAM	20525	836.5	8.9747	9.503
16QAM	20600	844	8.9797	9.498
64QAM	20450	829	8.9850	9.518
64QAM	20525	836.5	8.9724	9.505
64QAM	20600	844	8.9785	9.515

Spectrum Plot of Worst Value

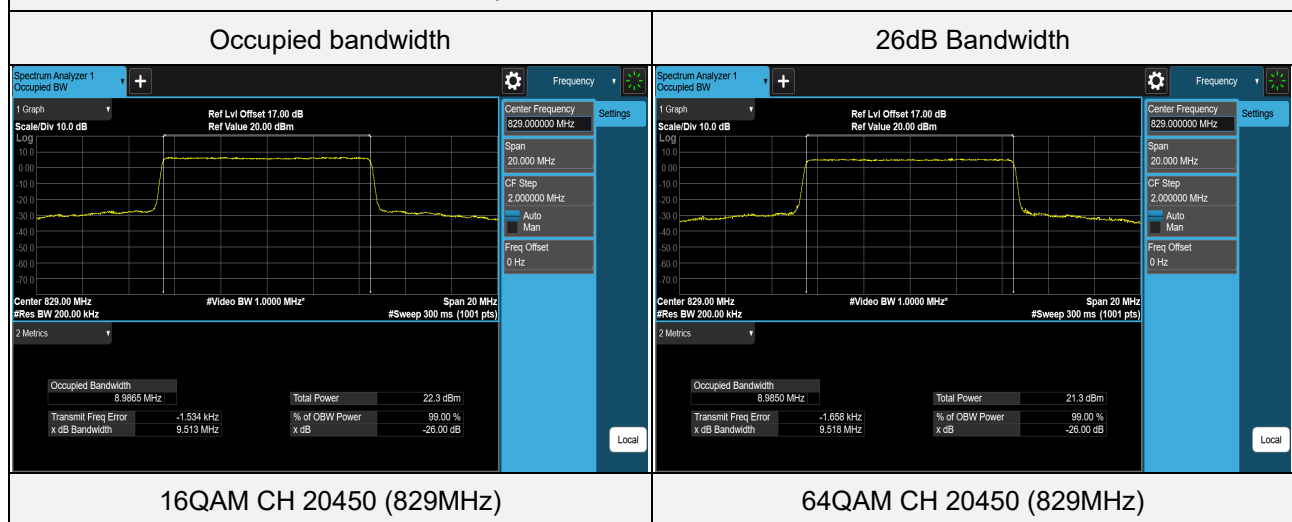

LTE Band 26 (Channel Bandwidth 1.4MHz)

Test Condition	Channel	Frequency (MHz)	Occupied bandwidth (MHz)	26dB Bandwidth (MHz)
QPSK	26797	824.7	1.0876	1.251
QPSK	26915	836.5	1.0894	1.262
QPSK	27033	848.3	1.0902	1.268
16QAM	26797	824.7	1.0865	1.243
16QAM	26915	836.5	1.0872	1.248
16QAM	27033	848.3	1.0861	1.250
64QAM	26797	824.7	1.0861	1.245
64QAM	26915	836.5	1.0880	1.246
64QAM	27033	848.3	1.0857	1.249

Spectrum Plot of Worst Value

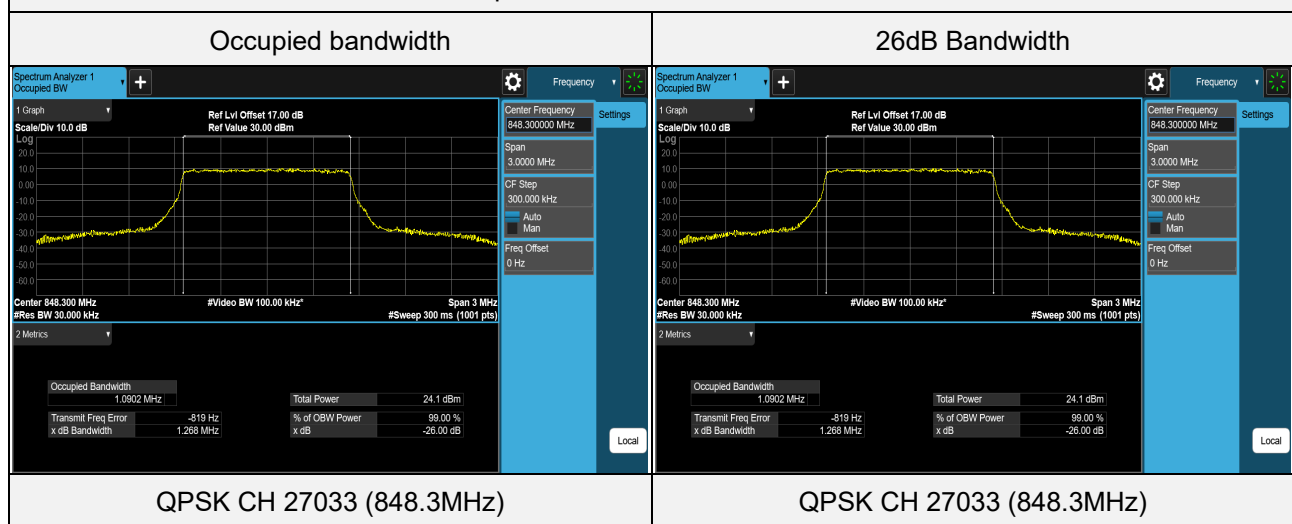

LTE Band 26 (Channel Bandwidth 3MHz)

Test Condition	Channel	Frequency (MHz)	Occupied bandwidth (MHz)	26dB Bandwidth (MHz)
QPSK	26805	825.5	2.6941	2.875
QPSK	26915	836.5	2.6934	2.870
QPSK	27025	847.5	2.6894	2.868
16QAM	26805	825.5	2.6937	2.879
16QAM	26915	836.5	2.6920	2.868
16QAM	27025	847.5	2.6894	2.871
64QAM	26805	825.5	2.6932	2.865
64QAM	26915	836.5	2.6923	2.861
64QAM	27025	847.5	2.6907	2.860

Spectrum Plot of Worst Value

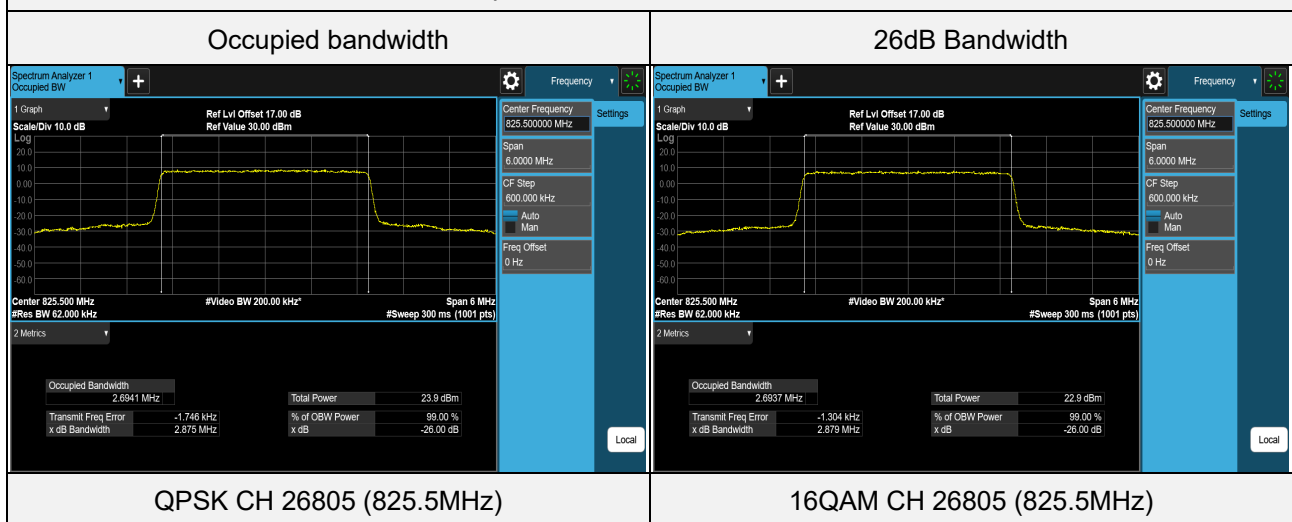

LTE Band 26 (Channel Bandwidth 5MHz)

Test Condition	Channel	Frequency (MHz)	Occupied bandwidth (MHz)	26dB Bandwidth (MHz)
QPSK	26815	826.5	4.4973	4.779
QPSK	26915	836.5	4.4948	4.769
QPSK	27015	846.5	4.4921	4.778
16QAM	26815	826.5	4.4933	4.768
16QAM	26915	836.5	4.4923	4.770
16QAM	27015	846.5	4.4859	4.767
64QAM	26815	826.5	4.4956	4.781
64QAM	26915	836.5	4.4929	4.778
64QAM	27015	846.5	4.4926	4.771

Spectrum Plot of Worst Value

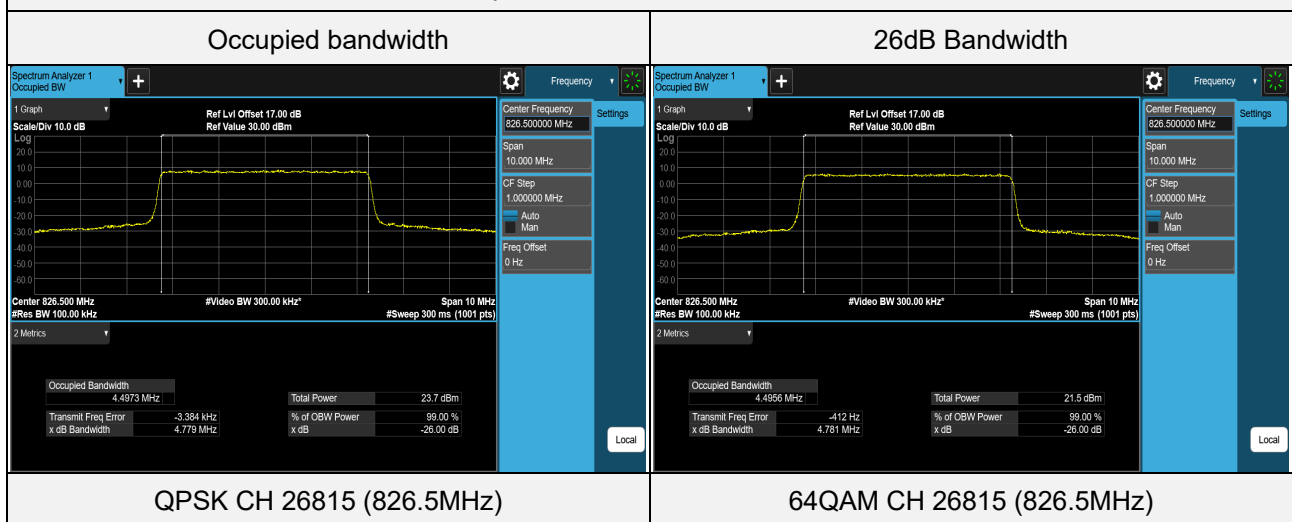

LTE Band 26 (Channel Bandwidth 10MHz)

Test Condition	Channel	Frequency (MHz)	Occupied bandwidth (MHz)	26dB Bandwidth (MHz)
QPSK	26840	829	8.9901	9.507
QPSK	26915	836.5	8.9750	9.496
QPSK	26990	844	8.9771	9.501
16QAM	26840	829	8.9810	9.509
16QAM	26915	836.5	8.9737	9.496
16QAM	26990	844	8.9814	9.497
64QAM	26840	829	8.9868	9.525
64QAM	26915	836.5	8.9768	9.504
64QAM	26990	844	8.9804	9.497

Spectrum Plot of Worst Value

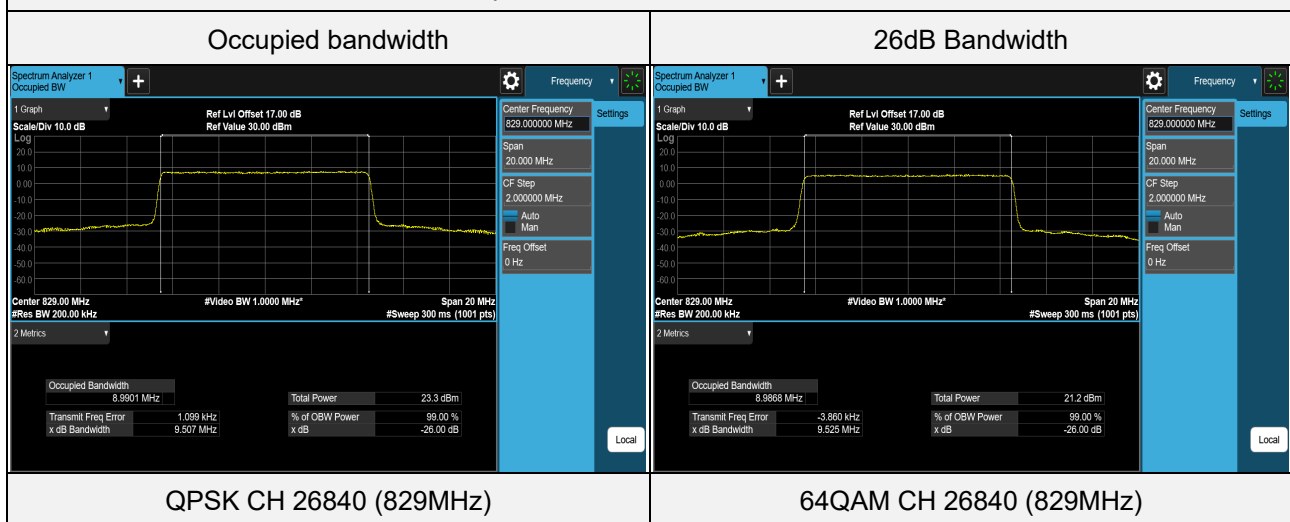

LTE Band 26 (Channel Bandwidth 15MHz)

Test Condition	Channel	Frequency (MHz)	Occupied bandwidth (MHz)	26dB Bandwidth (MHz)
QPSK	26865	831.5	13.475	14.24
QPSK	26915	836.5	13.462	14.23
QPSK	26965	841.5	13.465	14.22
16QAM	26865	831.5	13.457	14.24
16QAM	26915	836.5	13.445	14.22
16QAM	26965	841.5	13.455	14.23
64QAM	26865	831.5	13.455	14.24
64QAM	26915	836.5	13.442	14.23
64QAM	26965	841.5	13.448	14.22

Spectrum Plot of Worst Value

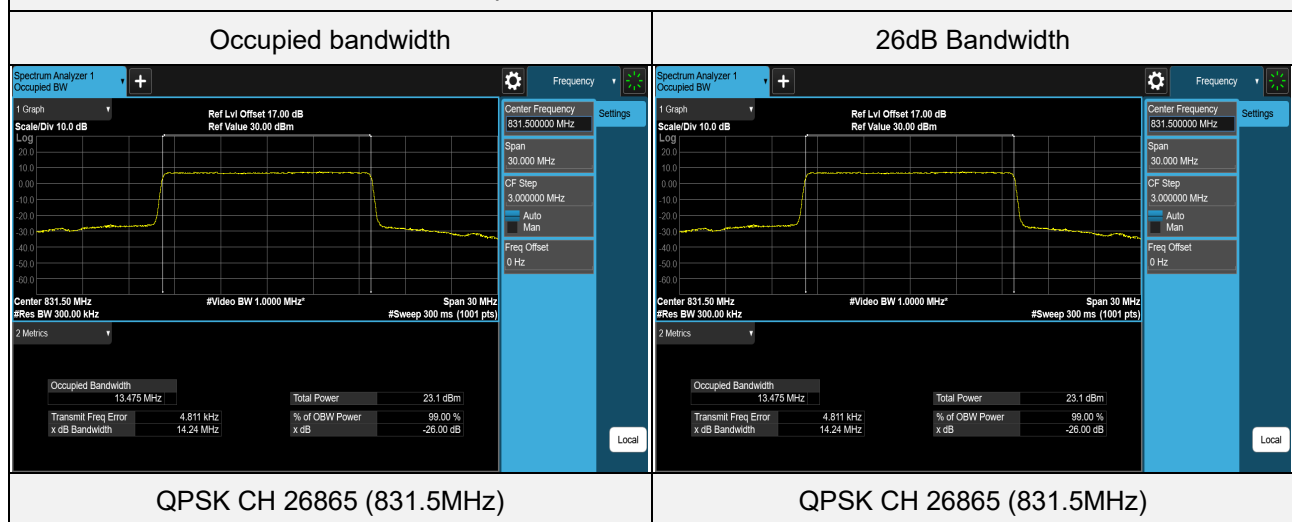

4.5 Band Edge Measurement

4.5.1 Limits of Band Edge Measurement

Power of any emission outside of the authorized operating frequency ranges must be attenuated below the transmitting power (P) by a factor of at least $43 + 10 \log(P)$ dB. In the 1 MHz bands immediately outside and adjacent to the frequency block a resolution bandwidth of at least one percent of the emission bandwidth of the fundamental emission of the transmitter may be employed.

4.5.2 Test Setup

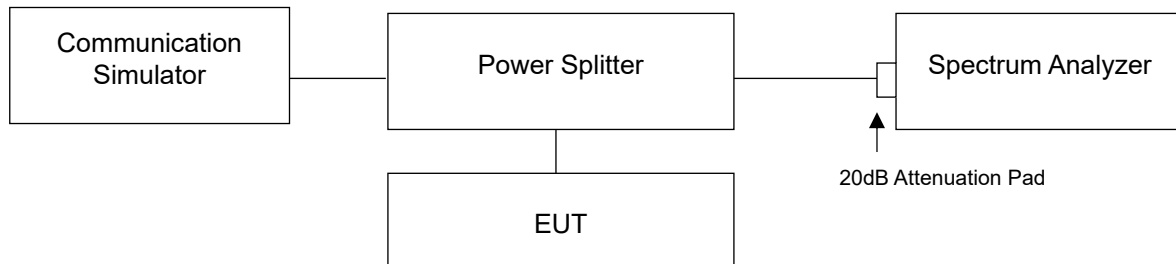

4.5.3 Test Procedures

- All measurements were done at low and high operational frequency range.
- The center frequency of spectrum is the band edge frequency and span is 2MHz. RB of the spectrum is 10kHz and VB of the spectrum is 30kHz (GPRS / EDGE).
- The center frequency of spectrum is the band edge frequency and span is 1MHz. RB of the spectrum is 30kHz and VB of the spectrum is 100kHz (LTE Channel Bandwidth 1.4MHz).
- The center frequency of spectrum is the band edge frequency and span is 1MHz. RB of the spectrum is 62kHz and VB of the spectrum is 200kHz (LTE Channel Bandwidth 3MHz).
- The center frequency of spectrum is the band edge frequency and span is 1MHz. RB of the spectrum is 100kHz and VB of the spectrum is 300kHz (LTE Channel Bandwidth 5MHz).
- The center frequency of spectrum is the band edge frequency and span is 1MHz. RB of the spectrum is 200kHz and VB of the spectrum is 620kHz (LTE Channel Bandwidth 10MHz).
- The center frequency of spectrum is the band edge frequency and span is 1MHz. RB of the spectrum is 300kHz and VB of the spectrum is 1MHz (LTE Channel Bandwidth 15MHz).
- Record the max trace plot into the test report.

4.5.4 Test Results

GPRS

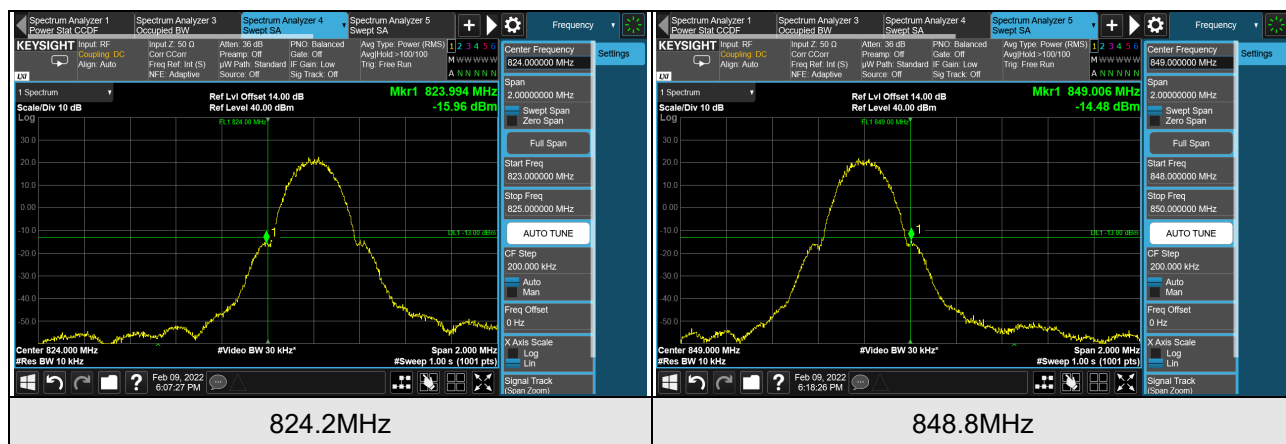

EDGE

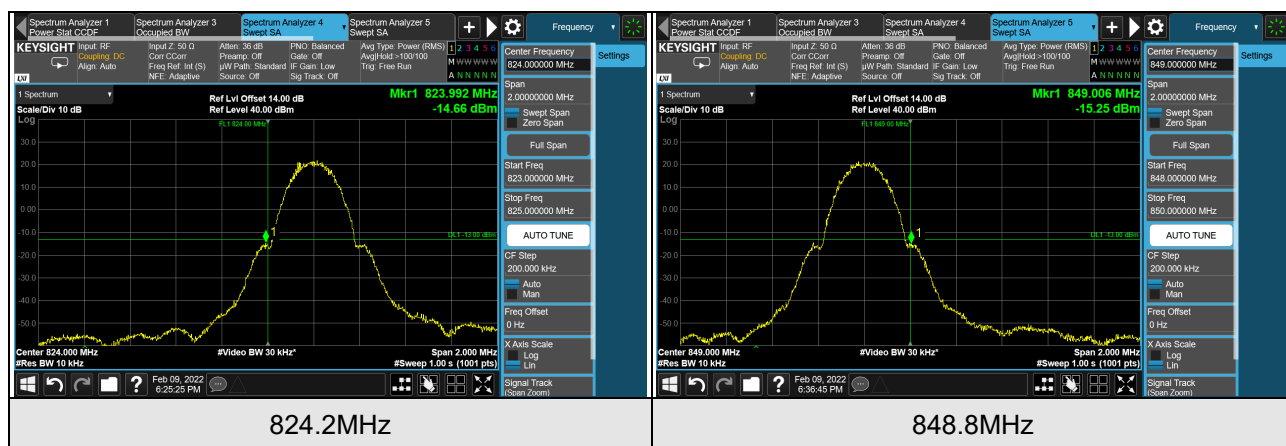

LTE Band 5 (Channel Bandwidth 1.4MHz)

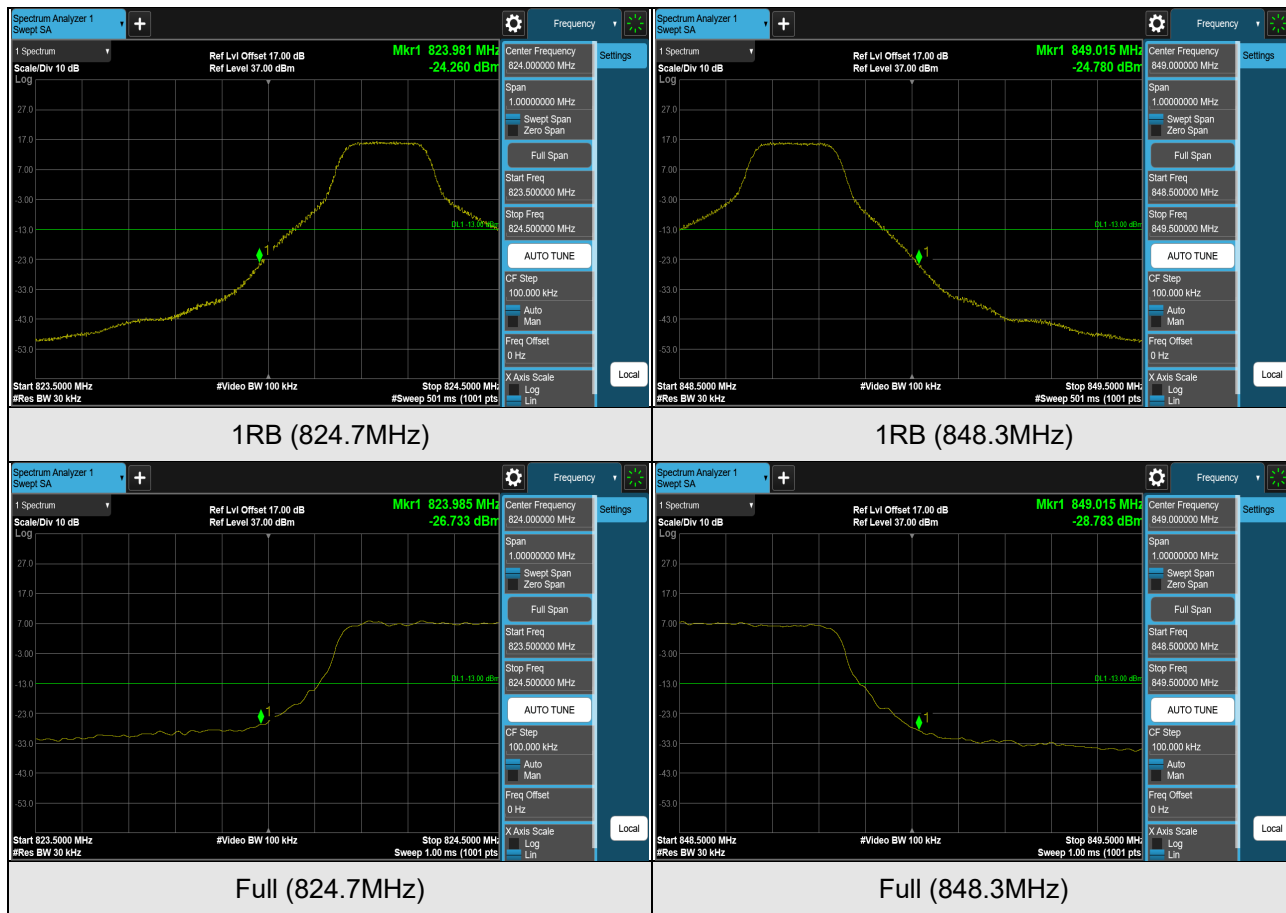

LTE Band 5 (Channel Bandwidth 3MHz)

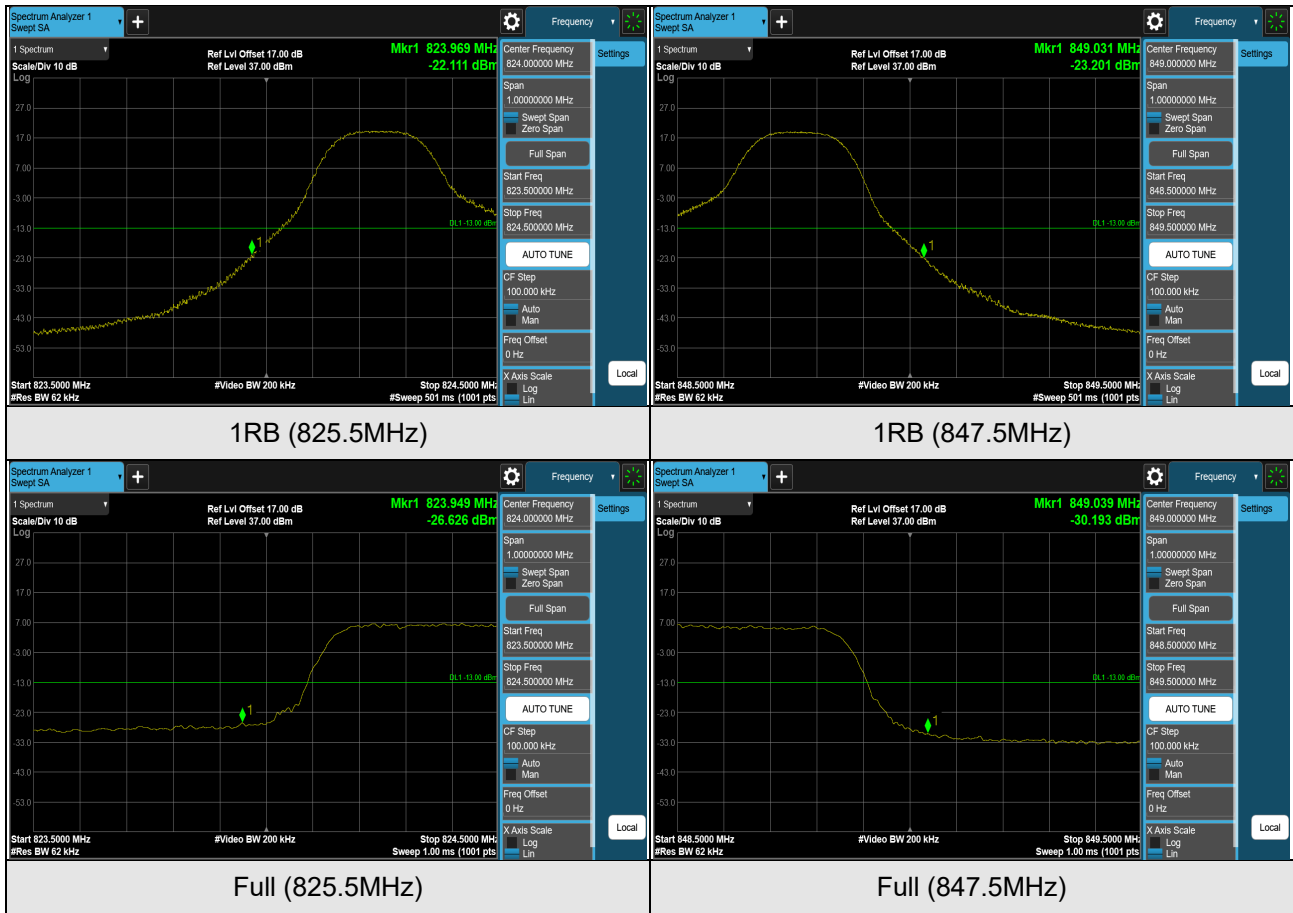

LTE Band 5 (Channel Bandwidth 5MHz)

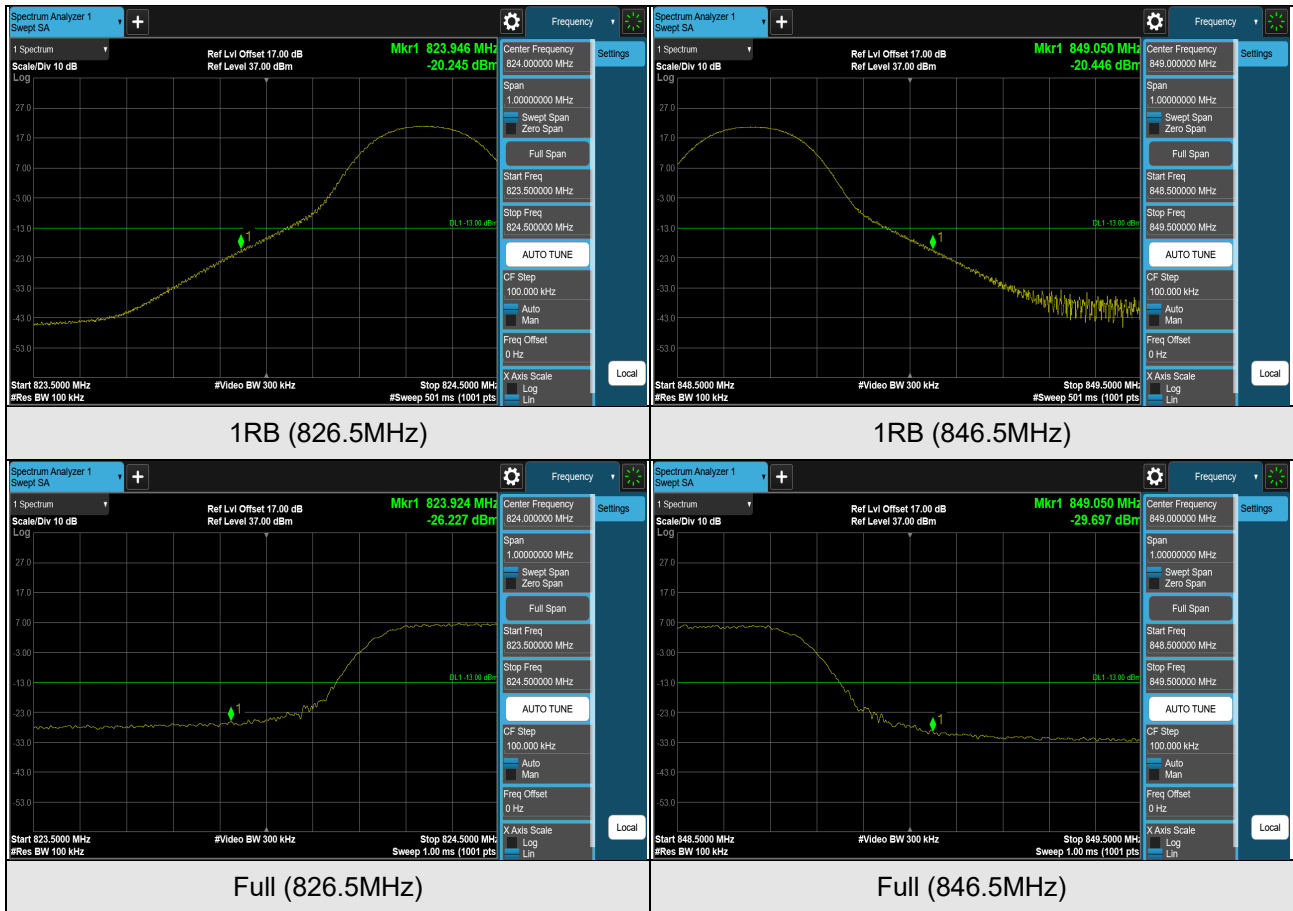

LTE Band 5 (Channel Bandwidth 10MHz)

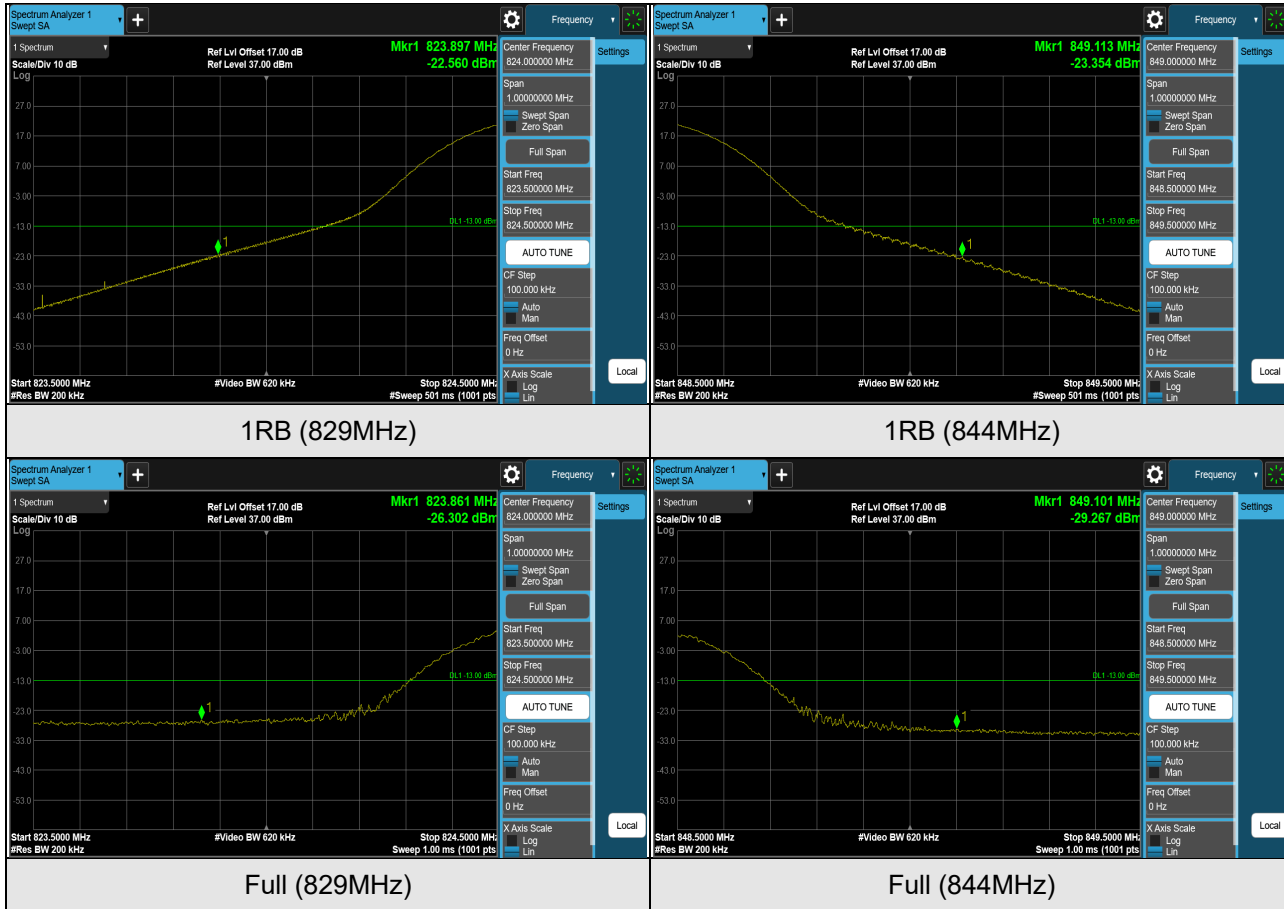

LTE Band 26 (Channel Bandwidth 1.4MHz)

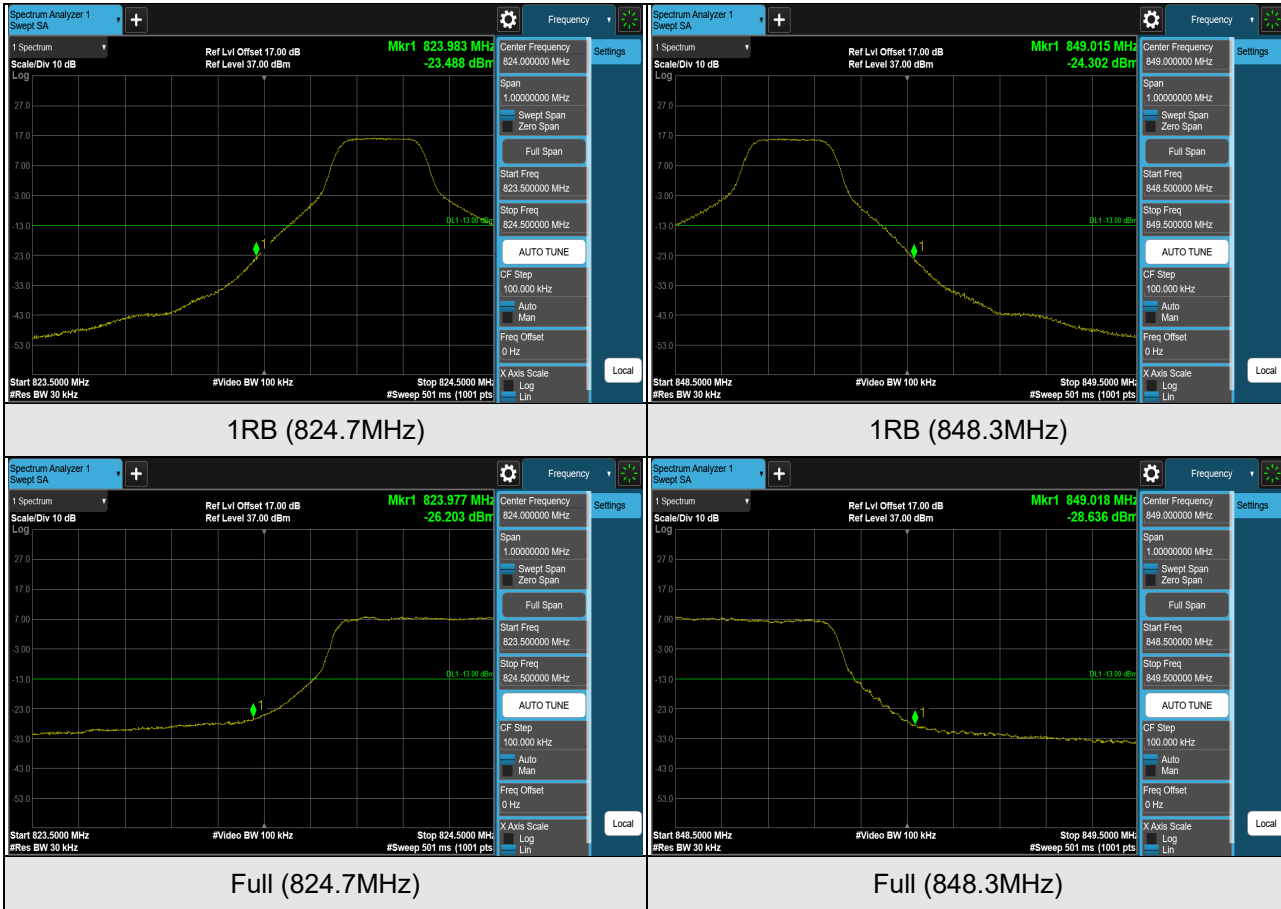

LTE Band 26 (Channel Bandwidth 3MHz)

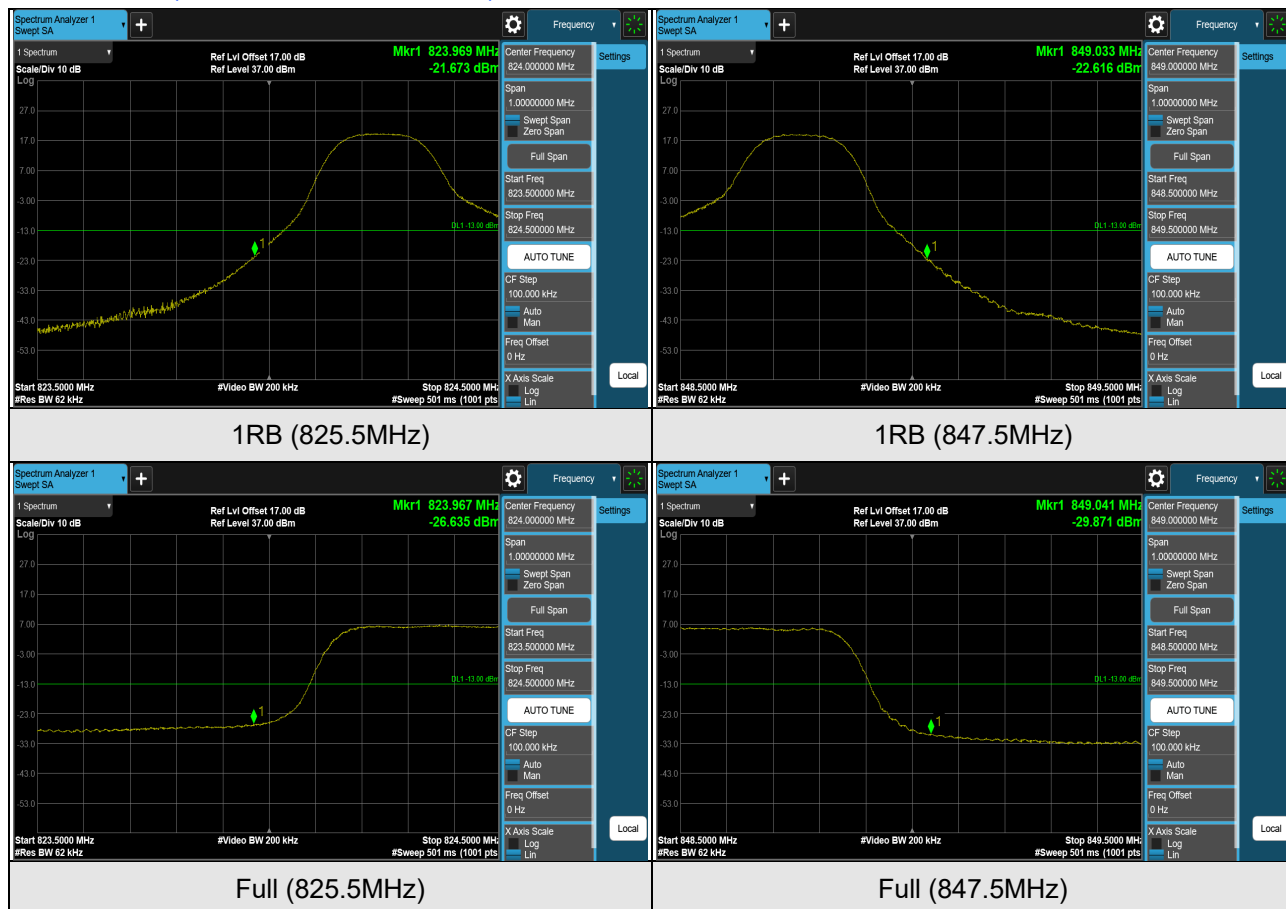

LTE Band 26 (Channel Bandwidth 5MHz)

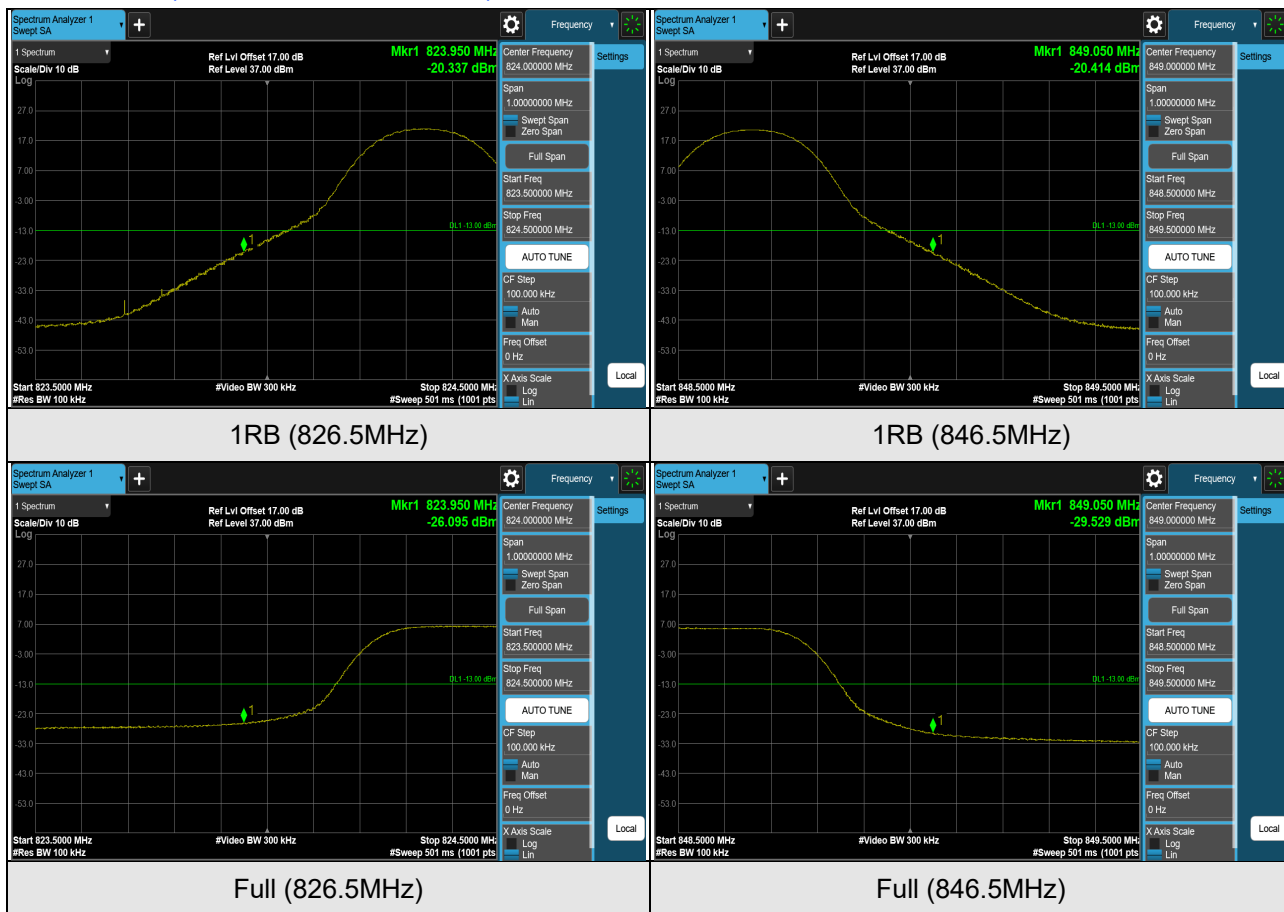

LTE Band 26 (Channel Bandwidth 10MHz)

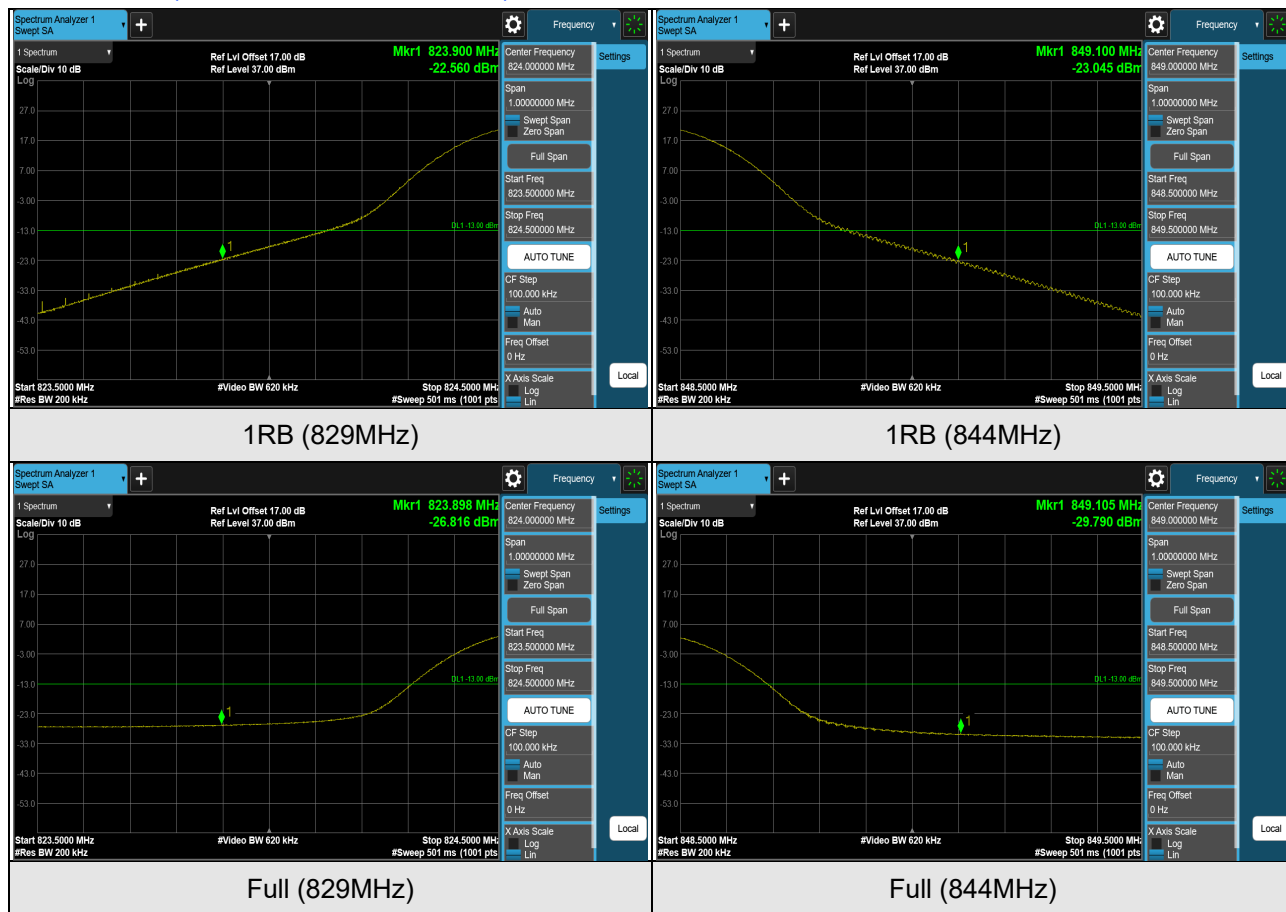

LTE Band 26 (Channel Bandwidth 15MHz)

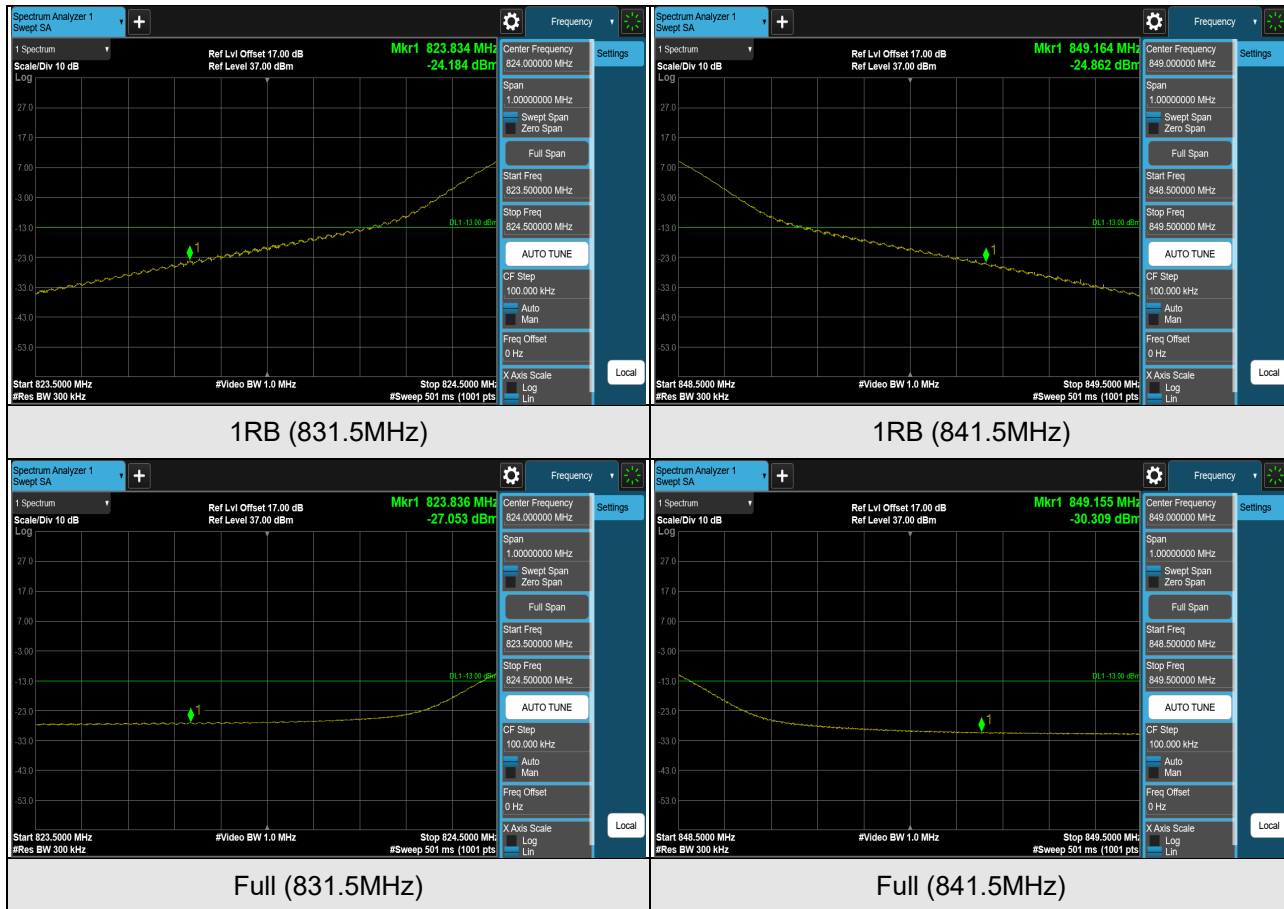

4.6 Peak to Average Ratio

4.6.1 Limits of Peak to Average Ratio Measurement

In measuring transmissions in this band using an average power technique, the peak to-average ratio (PAR) of the transmission may not exceed 13 dB

4.6.2 Test Setup

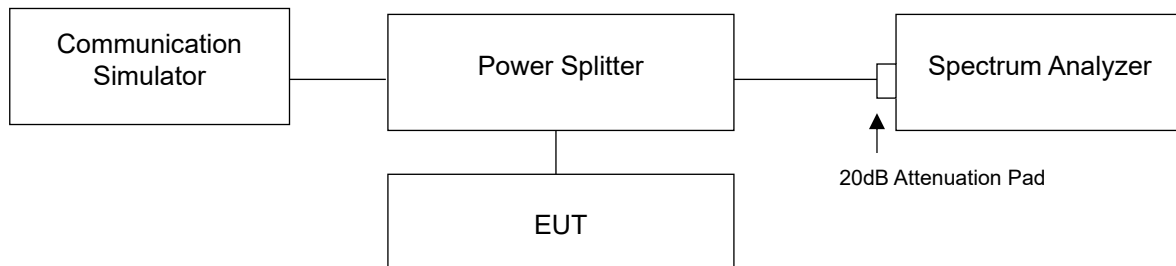

4.6.3 Test Procedures

- Set resolution/measurement bandwidth \geq signal's occupied bandwidth;
- Set the number of counts to a value that stabilizes the measured CCDF curve;
- Record the maximum PAPR level associated with a probability of 0.1%.

4.6.4 Test Results

GPRS, EDGE

Test Condition	Channel	Frequency (MHz)	Measure. Value (dB)	Limit (dB)	Result
GPRS	128	824.2	2.61	13	Pass
GPRS	189	836.4	2.61	13	Pass
GPRS	251	848.8	2.62	13	Pass
EDGE	128	824.2	2.61	13	Pass
EDGE	189	836.4	2.62	13	Pass
EDGE	251	848.8	2.61	13	Pass

Spectrum Plot of Worst Value

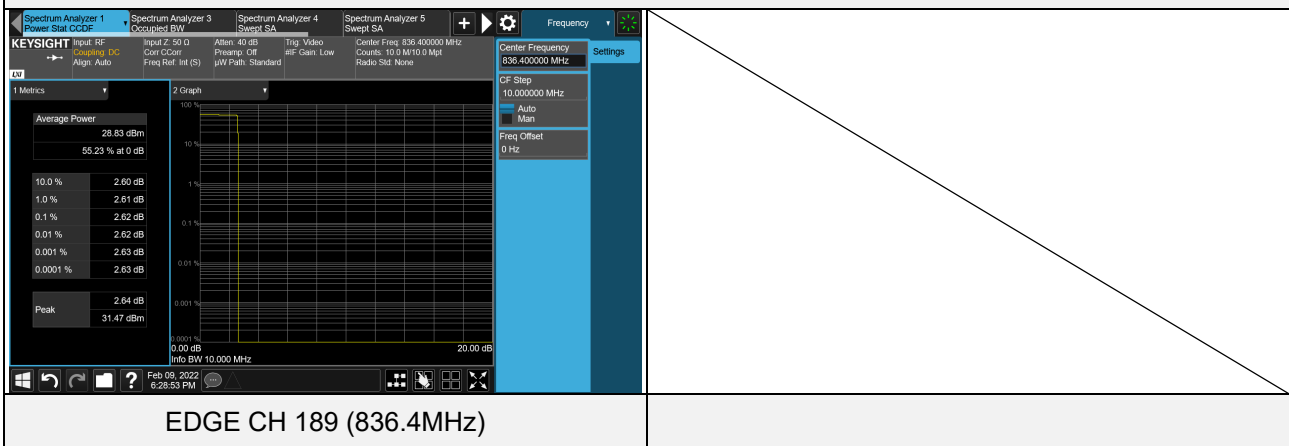

LTE Band 5 (Channel Bandwidth 1.4MHz)

Test Condition	Channel	Frequency (MHz)	Measure. Value (dB)	Limit (dB)	Result
QPSK	20407	824.7	5.44	13	Pass
QPSK	20525	836.5	5.83	13	Pass
QPSK	20643	848.3	5.45	13	Pass
16QAM	20407	824.7	6.35	13	Pass
16QAM	20525	836.5	6.59	13	Pass
16QAM	20643	848.3	6.34	13	Pass
64QAM	20407	824.7	6.49	13	Pass
64QAM	20525	836.5	6.65	13	Pass
64QAM	20643	848.3	6.55	13	Pass

Spectrum Plot of Worst Value

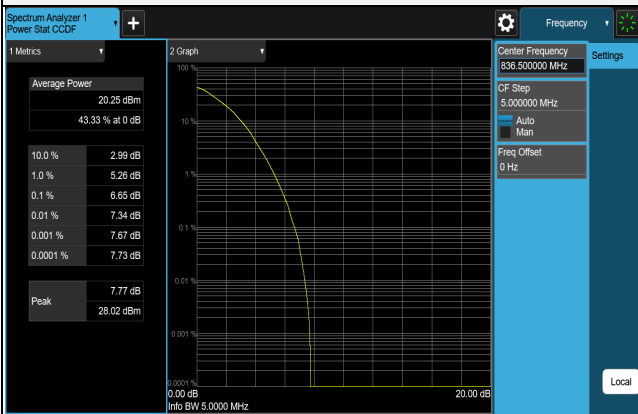

64QAM CH 20525 (836.5MHz)

LTE Band 5 (Channel Bandwidth 3MHz)

Test Condition	Channel	Frequency (MHz)	Measure. Value (dB)	Limit (dB)	Result
QPSK	20415	825.5	5.62	13	Pass
QPSK	20525	836.5	5.77	13	Pass
QPSK	20635	847.5	5.71	13	Pass
16QAM	20415	825.5	6.41	13	Pass
16QAM	20525	836.5	6.63	13	Pass
16QAM	20635	847.5	6.58	13	Pass
64QAM	20415	825.5	6.53	13	Pass
64QAM	20525	836.5	6.61	13	Pass
64QAM	20635	847.5	6.62	13	Pass

Spectrum Plot of Worst Value

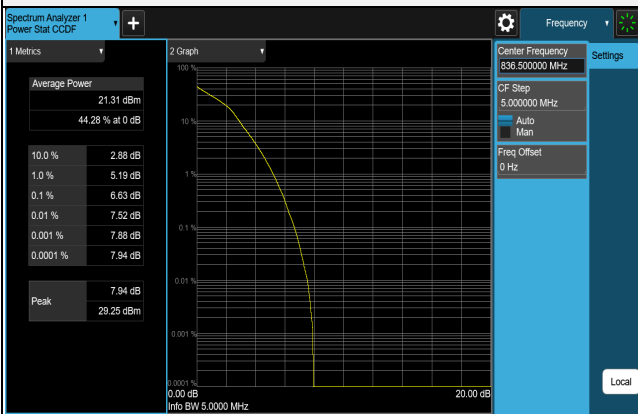

16QAM CH 20525 (836.5MHz)

LTE Band 5 (Channel Bandwidth 5MHz)

Test Condition	Channel	Frequency (MHz)	Measure. Value (dB)	Limit (dB)	Result
QPSK	20425	826.5	5.73	13	Pass
QPSK	20525	836.5	5.82	13	Pass
QPSK	20625	846.5	5.72	13	Pass
16QAM	20425	826.5	6.39	13	Pass
16QAM	20525	836.5	6.49	13	Pass
16QAM	20625	846.5	6.45	13	Pass
64QAM	20425	826.5	6.57	13	Pass
64QAM	20525	836.5	6.60	13	Pass
64QAM	20625	846.5	6.61	13	Pass

Spectrum Plot of Worst Value

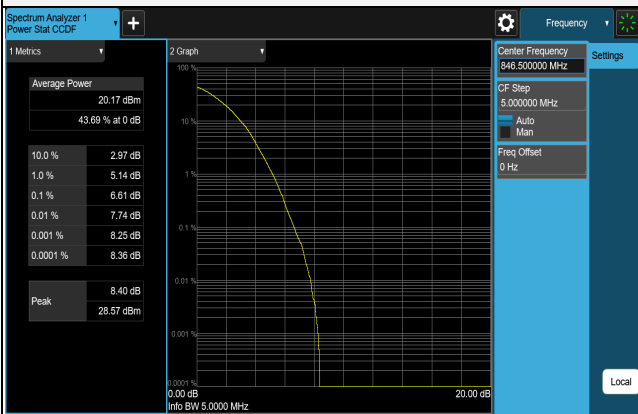

64QAM CH 20625 (846.5MHz)

LTE Band 5 (Channel Bandwidth 10MHz)

Test Condition	Channel	Frequency (MHz)	Measure. Value (dB)	Limit (dB)	Result
QPSK	20450	829	5.87	13	Pass
QPSK	20525	836.5	5.78	13	Pass
QPSK	20600	844	5.85	13	Pass
16QAM	20450	829	6.46	13	Pass
16QAM	20525	836.5	6.47	13	Pass
16QAM	20600	844	6.45	13	Pass
64QAM	20450	829	6.62	13	Pass
64QAM	20525	836.5	6.51	13	Pass
64QAM	20600	844	6.55	13	Pass

Spectrum Plot of Worst Value

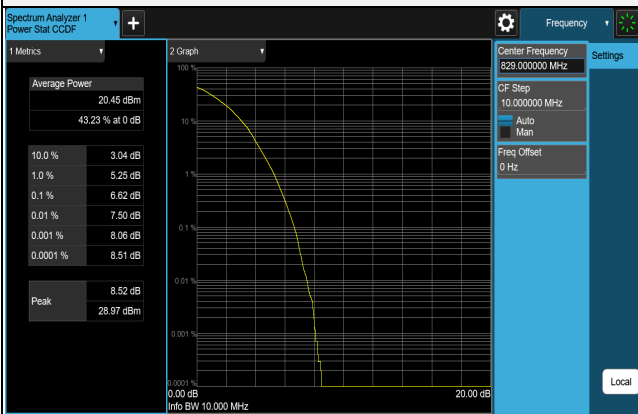

64QAM CH 20450 (829MHz)

LTE Band 26 (Channel Bandwidth 1.4MHz)

Test Condition	Channel	Frequency (MHz)	Measure. Value (dB)	Limit (dB)	Result
QPSK	26797	824.7	4.54	13	Pass
QPSK	26915	836.5	4.95	13	Pass
QPSK	27033	848.3	4.54	13	Pass
16QAM	26797	824.7	5.60	13	Pass
16QAM	26915	836.5	6.00	13	Pass
16QAM	27033	848.3	5.66	13	Pass
64QAM	26797	824.7	5.36	13	Pass
64QAM	26915	836.5	6.31	13	Pass
64QAM	27033	848.3	6.07	13	Pass

Spectrum Plot of Worst Value

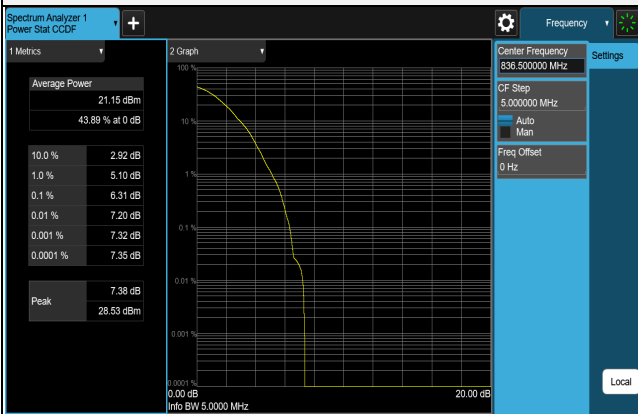

64QAM CH 26915 (836.5MHz)

LTE Band 26 (Channel Bandwidth 3MHz)

Test Condition	Channel	Frequency (MHz)	Measure. Value (dB)	Limit (dB)	Result
QPSK	26805	825.5	4.48	13	Pass
QPSK	26915	836.5	4.91	13	Pass
QPSK	27025	847.5	4.77	13	Pass
16QAM	26805	825.5	5.59	13	Pass
16QAM	26915	836.5	6.02	13	Pass
16QAM	27025	847.5	5.81	13	Pass
64QAM	26805	825.5	6.00	13	Pass
64QAM	26915	836.5	6.32	13	Pass
64QAM	27025	847.5	6.24	13	Pass

Spectrum Plot of Worst Value

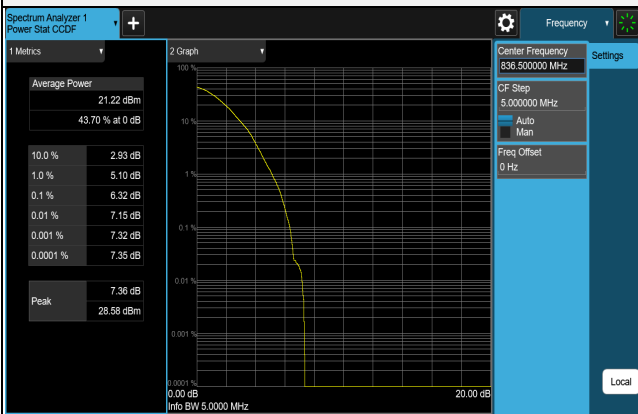

64QAM CH 26915 (836.5MHz)

LTE Band 26 (Channel Bandwidth 5MHz)

Test Condition	Channel	Frequency (MHz)	Measure. Value (dB)	Limit (dB)	Result
QPSK	26815	826.5	4.51	13	Pass
QPSK	26915	836.5	4.99	13	Pass
QPSK	27015	846.5	4.75	13	Pass
16QAM	26815	826.5	5.55	13	Pass
16QAM	26915	836.5	6.06	13	Pass
16QAM	27015	846.5	5.85	13	Pass
64QAM	26815	826.5	6.00	13	Pass
64QAM	26915	836.5	6.34	13	Pass
64QAM	27015	846.5	6.20	13	Pass

Spectrum Plot of Worst Value

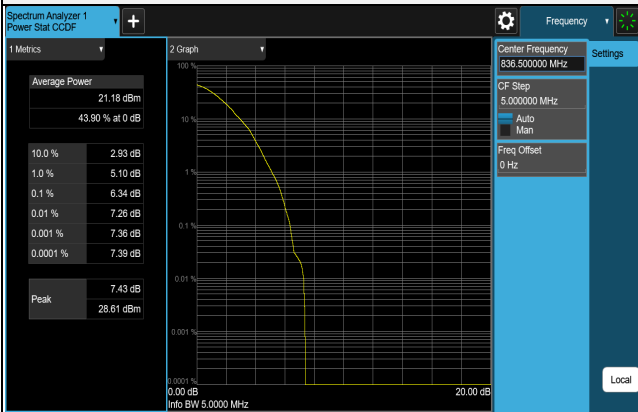

64QAM CH 26915 (836.5MHz)

LTE Band 26 (Channel Bandwidth 10MHz)

Test Condition	Channel	Frequency (MHz)	Measure. Value (dB)	Limit (dB)	Result
QPSK	26840	829	4.45	13	Pass
QPSK	26915	836.5	4.97	13	Pass
QPSK	26990	844	4.68	13	Pass
16QAM	26840	829	5.44	13	Pass
16QAM	26915	836.5	6.03	13	Pass
16QAM	26990	844	5.68	13	Pass
64QAM	26840	829	5.95	13	Pass
64QAM	26915	836.5	6.32	13	Pass
64QAM	26990	844	6.10	13	Pass

Spectrum Plot of Worst Value

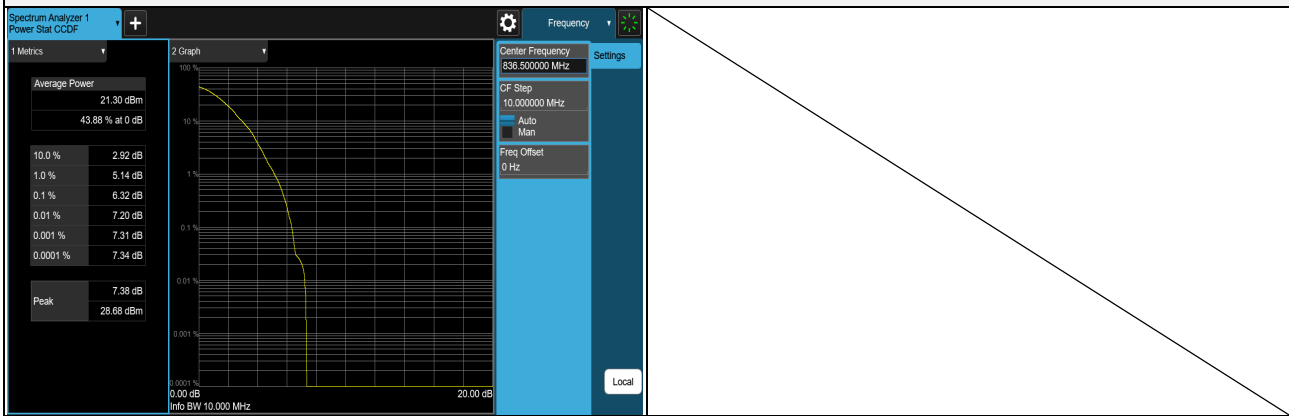

64QAM CH 26915 (836.5MHz)

LTE Band 26 (Channel Bandwidth 15MHz)

Test Condition	Channel	Frequency (MHz)	Measure. Value (dB)	Limit (dB)	Result
QPSK	26865	831.5	4.47	13	Pass
QPSK	26915	836.5	4.78	13	Pass
QPSK	26965	841.5	5.02	13	Pass
16QAM	26865	831.5	5.52	13	Pass
16QAM	26915	836.5	5.79	13	Pass
16QAM	26965	841.5	5.98	13	Pass
64QAM	26865	831.5	5.95	13	Pass
64QAM	26915	836.5	6.18	13	Pass
64QAM	26965	841.5	6.23	13	Pass

Spectrum Plot of Worst Value

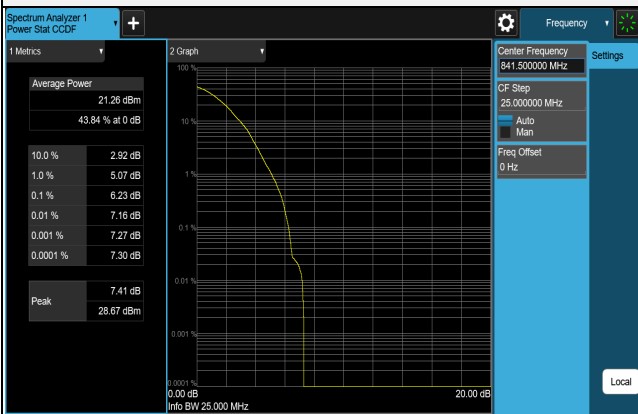

64QAM CH 26965 (841.5MHz)

4.7 Conducted Spurious Emissions

4.7.1 Limits of Conducted Spurious Emissions Measurement

The power of any emission outside of the authorized operating frequency ranges must be attenuated below the transmitting power (P) by a factor of at least $43 + 10 \log(P)$ dB. The emission limit equal to -13dBm .

4.7.2 Test Setup

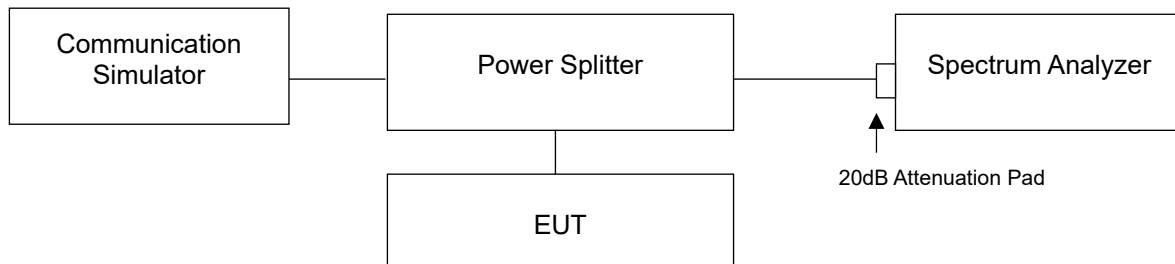

4.7.3 Test Procedure

- All measurements were done at low, middle and high channels operational frequency range.
- Measuring frequency range is from 9kHz to 9GHz / 10GHz. 20dB attenuation pad is connected with spectrum. RBW = 1MHz and VBW = 3MHz / RBW = 100kHz and VBW = 300kHz are used for conducted emission measurement.